

RESTRICTED

SEPTEMBER 1950

BUSHIPS

# ELECTRON

NavShips 900,100



RESTRICTED





A  
MONTHLY  
MAGAZINE  
FOR  
ELECTRONICS  
TECHNICIANS

<i>CV-57/URR, CV-60/URR, AN/URA-6/-7/-8 Frequency Shift Receiver-Converters</i> .....	1
<i>Pointers on U-H-F Equipment</i> .....	4
<i>Sonar Transducer Repair Facility</i> .....	5
<i>Opening Test-Tool Set AN/USM-3</i> .....	7
<i>The Electronics Officer Aboard Ship</i> .....	8
<i>Check Your Shipyard Overhaul Work Lists</i> .....	14
<i>Waveguide Hybrids</i> .....	15
<i>Fluorescent Light Interference at a Naval Air Station</i>	20
<i>Check on Waveguide Excellence</i> .....	23
<i>Models TEJ, TEK and TEL Nomenclature Change..</i>	23
<i>Model OAA-F.C. No. 2—Replacement of Choke Coil</i> .....	24
<i>Models VL and X-VL—F.C. No. 1—Provision of Moisture Proofing</i> .....	24
<i>Models TCK-4/-6 Power Supply Connections</i> ....	24
<i>Model NMC Filter Junction Box (W.T)</i> .....	24
<i>Model TBL-5/-6/-7/-12/-13 I.B. Correction....</i>	24
<i>Cabinet CY-597/G Defective Switch Panel Wiring..</i>	24
<i>Failure of Noise Generator SG-23/U in Test Tool Set AN/USM-3</i> .....	25
<i>Failure of IN23B Crystals in Mark 13</i> .....	25
<i>U-H-F Performance</i> .....	25
<i>Models VK and X-VK—F.C. No. 4—Provision of Moisture Proofing</i> .....	25
<i>Care and Maintenance of Motors and Generators ..</i>	26
<i>Pointers on Loran</i> .....	28
<i>USN USL Notes</i> .....	29
<i>The Field Engineer Sez</i> .....	30
<i>ESO Monthly Column</i> .....	32
<i>Electronic Field Change Index</i> .....	33

THE PRINTING OF THIS PUBLICATION HAS BEEN APPROVED BY THE DIRECTOR OF THE BUREAU OF THE BUDGET 13 JANUARY 1950

*DISTRIBUTION: BuSHIPS ELECTRON is sent to Department of Defense activities concerned with the installation, operation, maintenance, and supply of electronic equipment. If the quantity supplied is not correct, please advise the Bureau promptly.*

*CONTRIBUTIONS: Contributions to this magazine are always welcome. All material should be addressed to The Editor BuShips Electron, Bureau of Ships (Code 993-c), Navy Department, Washington 25, D. C. Whenever possible articles should be accompanied by appropriate sketches, diagrams, or photographs.*

*CLASSIFICATION: Most issues of BuSHIPS ELECTRON are classified restricted or confidential in order that information on all types of equipment may be included. Specific material published in any issue may or may not be classified, however. Each issue is assigned the highest classification of material included. Classified material should be shown only to concerned personnel as provided in U. S. Navy Regulations. Don't forget, many enlisted men are concerned with the contents of this magazine. BuSHIPS ELECTRON contains information affecting the national defense of the United States within the meaning of the Espionage Act (U.S.C. 50; 31-32) as amended.*

CV-57/URR

CV-60/URR

AN/URA-6/-7/-8

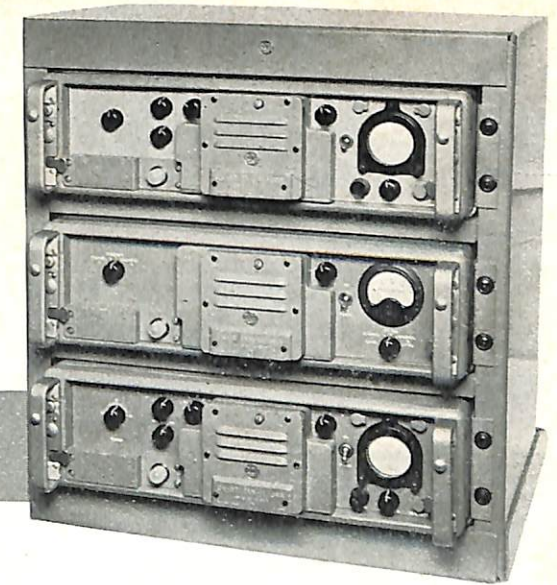

Frequency shift converter comparator group AN/URA-6.

# FREQUENCY SHIFT RECEIVER CONVERTERS

A frequency shift receiver converter is required in addition to a communication receiver in order to use the intelligence contained in frequency shift keyed radioteletype signals to operate a teletype printer. Frequency shift receiver converters are classified as intermediate-frequency or audio-frequency types according to the frequency range at which the intelligence is obtained from the communications receiver. Each type has certain advantages over the other type and there is no general agreement among communications engineers as to which is the better.

The Type CV-57/URR, CV-60/URR, AN/URA-6, AN/URA-7 and AN/URA-8 frequency shift converters comprise a series of equipments of similar appearance, mechanical construction and electrical circuitry which includes both intermediate-frequency and audio-frequency types for single-channel operation and two-channel diversity operation. These equipments utilize plug-in subassemblies in file cabinet drawer type construction. This type of construction permits the chassis to be withdrawn from its enclosure on slides similar to those on file cabinet drawers. When in the withdrawn position, the chassis can be rotated on pivots on the slide mechanism, to permit convenient inspection and replacement of tubes and plug-in subassemblies. Each equipment is furnished with brackets and a mounting frame for installation on

a table top or in a standard relay rack. When mounted in a relay rack, each Type CV-57/URR and CV-60/URR occupies 5 1/4 inches of panel space and each AN/URA-6, AN/URA-7 and AN/URA-8 occupies 15 3/4 inches of panel space. Each enclosure is provided with a filter unit which has a radio-frequency filter for each external connection.

All the equipments in this series provide for operation over the two ranges of frequency shift normally encountered in communications service. When adjusted for wide shift they will operate with frequency shift keyed signals having a frequency difference between marks and spaces of any value between 200 cycles and 1000 cycles. When adjusted for narrow shift they will operate with frequency shift keyed signals having a frequency difference between marks and spaces of any value between 10 cycles and 200 cycles.

The Type CV-57/URR is a single channel intermediate-frequency type frequency shift converter having an input circuit that is tunable to operate with any superheterodyne communications receiver which has an intermediate frequency within the range of 400 kilocycles to 470 kilocycles. It contains five plug-in subassemblies to perform the functions of the input circuit, intermediate-frequency limiter amplifier, keyer, tuning indicator and power supply. Installation of this converter requires modification of the communications receiver to obtain signal output at the receiver's intermediate frequency. This receiver modification is accomplished in Navy Model RBB and RBC series receivers by installation of a Type 10563 coupling unit.



Frequency shift converter  
CV-57/URR.

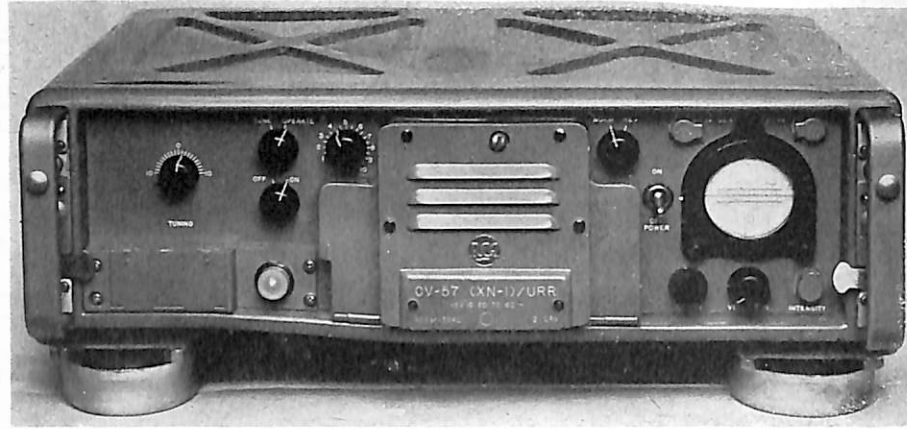

The input subassembly of the Type CV-57/URR frequency shift converter contains the input filters, frequency converter tube, conversion oscillator tube and reactance tube. The input filters are designed for operation from a 70-ohm coaxial transmission line and are tunable, by means of screwdriver adjustments, to any frequency between 400 kilocycles and 470 kilocycles. The frequency converter with its associated conversion oscillator changes the signals to have a center frequency of 40 kilocycles. The conversion oscillator is provided with a frequency vernier on the front panel for fine tuning. Automatic-frequency-control is also provided by the reactance tube which obtains its control voltage from the discriminator in the intermediate-frequency subassembly.

The intermediate-frequency subassembly operates at a center frequency of 40 kilocycles and provides selectivity, amplitude limiting and detection. Two degrees of selectivity are provided for the two ranges of frequency shift. When adjusted for wide shift the bandwidth of the limiting amplifier is approximately 1800 cycles and when adjusted for narrow shift it is approximately 1000 cycles. The limiting range is sufficient to provide satisfactory performance with input signal amplitudes between 2500 microvolts and 500,000 microvolts. A linear discriminator provides d-c signal voltages which are proportional to the mark and space frequencies. The discriminator has two frequency characteristics which correspond to the two degrees of selectivity of the limiter amplifier and the range of frequency shift. The discriminator output voltage is fed to the reactance tube in the input subassembly, to the keyer subassembly and to the tuning indicator.

The keyer subassembly contains a low-pass filter, voltage amplifiers, Eccles Jordan type flip-flop circuits, teletype keyer tubes, a tone oscillator and a tone keyer. The low-pass filter has two frequency characteristics identified as slow speed, for single channel teletype, and fast speed, for high speed keying and multiplex teletype. The flip-flop circuits have time constants and d-c restorers to provide automatic mark hold when there is no signal or when there is a steady space signal. The teletype keyer

tubes key the 60-milliampere teletype line current which must be supplied from an external teletype battery having its negative terminal grounded. The audio tone oscillator generates any one of eight tone frequencies which are keyed on and off by the tone keyer. Provision is also made for keying an externally-supplied audio-frequency tone instead of the signal from the internal tone oscillator.

The tuning indicator subassembly contains a Type 2BP1 cathode-ray tube which indicates condition of centering of the signal on the discriminator curve. The tuning pattern consists of two parallel horizontal lines obtained by applying the discriminator output voltage to the direct coupled vertical amplifier of the oscilloscope and using a 60-cycle sine wave sweep voltage. The vertical position of the pattern on the cathode-ray tube screen indicates the condition of tuning, being in the center of the screen when tuning is correct and moving up or down as the signal is detuned. The vertical distance between the two lines is proportional to the frequency difference between marks and spaces for any

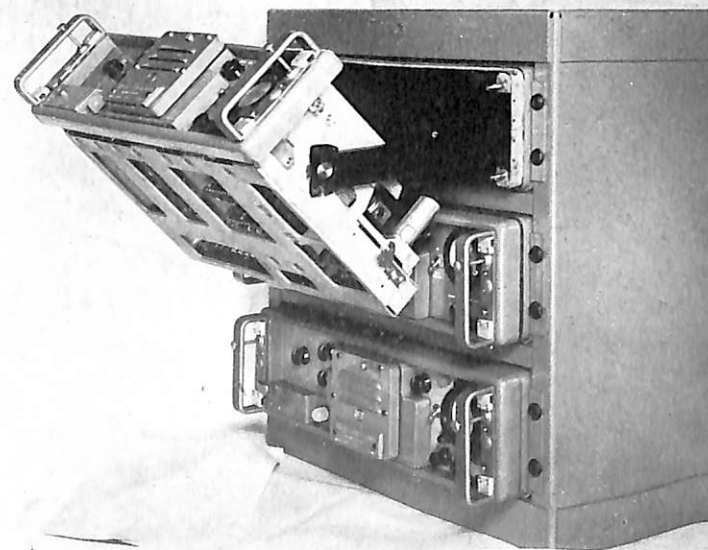

Frequency shift converter comparator group AN/URA-6.

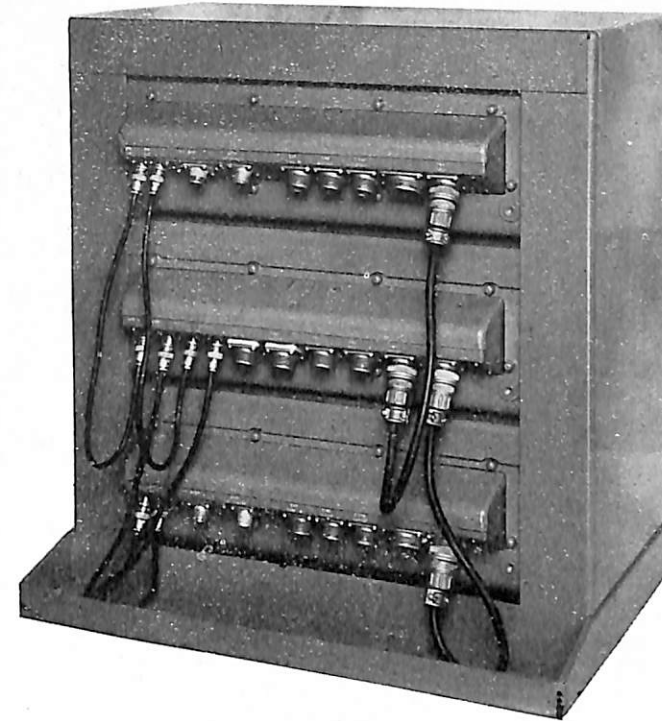

Frequency shift converter comparator group AN/URA-6, rear view showing cable connectors.

given setting of the oscilloscope amplifier gain control.

The power supply subassembly contains the power transformer, rectifier tubes, ripple filters and voltage regulators necessary to provide all of the d-c and a-c voltages and power for operation of the equipment. The power transformer primary has taps for operation from power lines having nominal voltages of 105, 115 and 125 volts.

The Type CV-60/URR is a single channel audio-frequency type frequency shift converter designed to operate from the audio-frequency output of any communication receiver having a beat frequency oscillator. It contains four plug-in subassemblies to perform the functions of audio limiter, keyer, tuning indicator and power supply. No modification of the companion receiver is required.

The audio-frequency input subassembly contains the input filters, audio-frequency limiter amplifiers and the audio-frequency discriminator. When the equipment is adjusted for wide shift the input circuit is connected through a bandpass filter which has a bandwidth of 2200 cycles and the discriminator center frequency is 2550 cycles. When the equipment is adjusted for narrow shift the input circuit is connected through a high-pass filter which will pass all frequencies above 775 cycles, and the discriminator center frequency is 1000 cycles. The high-pass filter is adequate for narrow shifts because all low frequency Navy receivers will not pass audio frequencies above 1400 cycles. The limiting range of the limiter amplifier is sufficient to provide satisfactory performance

with input signals between 60 microwatts and 60 milliwatts. The nominal input impedance is 600 ohms. The discriminator is approximately linear, producing d-c voltage outputs which are proportional to the mark and space frequencies.

The keyer, tuning indicator and power supply subassemblies of the Type CV-60/URR are the same as those of the CV-57/URR frequency shift converter.

The Model AN/URA-6 frequency shift converter comparator group consists of two Type CV-57/URA-6 converters and one Type CM-14/URA-6 comparator connected to provide two channel diversity reception of radioteletype signals. Each Type CV-57/URA-6 converter is identical to the single channel Type CV-57/URR converter. They may be used as two separate single channel equipments.

The Type CM-14/URA-6 comparator uses electronic switching to select the output from the discriminator of either of two frequency shift converters, and uses the selected discriminator output to key the teletype printer

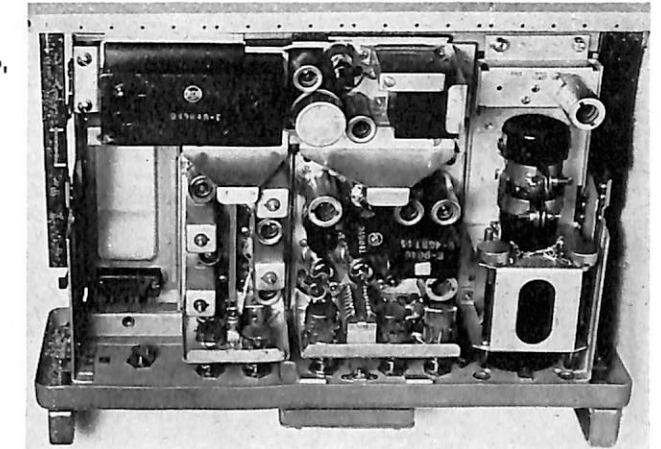

Frequency shift converter CV-57/URR, with input subassembly removed.

loop. It contains three plug-in subassemblies to perform the functions of a diversity gate, keyer and power unit.

The diversity gate subassembly takes frequency shift keyed signals from each of the two associated converters, before the signal has passed through the limiter circuits. These two control signals are amplified and applied to a differential rectifier which controls an Eccles Jordan type flip-flop circuit. The flip-flop circuit is connected by means of direct-coupled amplifiers to a pair of gate tubes which pass the signal from the discriminator of one converter and reject the signal from the discriminator of the other converter. The selected discriminator output is used to control the keyer subassembly.

The keyer subassembly of the Type CM-14/URA-6 is identical with the keyer subassembly of the CV-57/URR and CV-60/URR. The power supply subassembly is similar to the power supply subassembly in the CV-57/



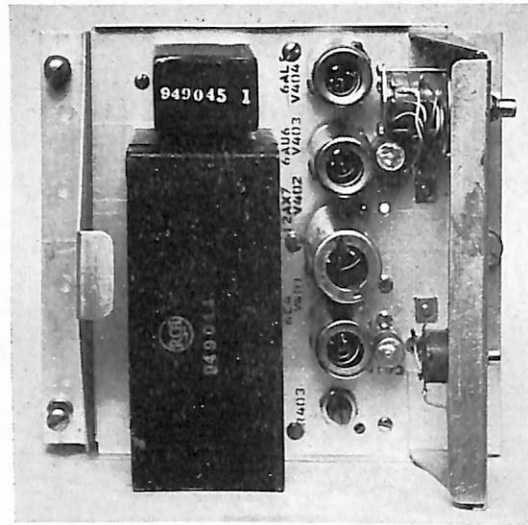

Audio-frequency input subassembly removed from CV-60/URR.

URR and CV-60/URR, but it has different electrical characteristics due to the smaller power requirements of the Type CM-14/URA-6 comparator.

The Model AN/URA-7 frequency shift converter comparator group is similar to the Model AN/URA-6 frequency shift converter comparator group, except the input subassembly of each of the converters is tuned to 50 kilocycles and has an input impedance of 1000 ohms for operation with Navy Model RBP and RCP diversity receivers.

The Model AN/URA-8 frequency shift converter

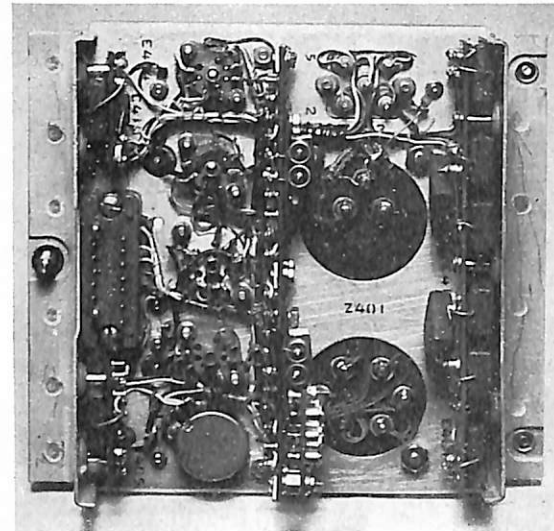

Audio-frequency input subassembly removed from CV-60/URR, bottom view.

comparator group consists of two Type CV-60/URA-8 converters and one Type CM-14/URA-8 comparator connected to provide two channel diversity reception of radioteletype signals. Each Type CV-60/URA-8 converter is identical to the single channel Type CV-60/URR converter. They may be used as two separate single channel equipments. The Type CM-14/URA-8 comparator is identical to the Type CM-14/URA-6 and Type CM-14/URA-7 comparators.

Production and delivery of this series of frequency shift converters is scheduled to begin this year.

## POINTERS ON U-H-F EQUIPMENT

Following are some pointers on u-h-f equipment maintenance:

1—A sheet metal shield made to cover the front panel of Model TDZ transmitters mounted near the deck will prevent damage to switches, dials, meters and other panel-mounted components.

2—When operating your TDZ keep the third tripler and power amplifier total grid currents under 50 milliamperes and prolong the life of the expensive 2C39 tubes. During tuning, the cathode currents should be kept below 35 ma.

3—When installing 2C39 tubes in the power amplifier or tripler stages, exercise caution to prevent damage to the filament finger contacts in the special tube sockets.

4—After installing new 2C39 tubes allow them to bake with filament current only for about an hour. This will prevent many failures of this type tube.

5—To avoid doubling instead of tripling when tuning the TDZ use the calibration curves in the instruction book for approximate settings.

6—The established u-h-f allowance for all ships of the fleet is two sets of RDZ crystals and two sets of TDZ crystals regardless of the number of equipments installed. Each set consists of 101 crystals. If your sets only have 100 crystals, order the extra crystal from the nearest Electronics Supply Office. The frequency is 234.0 Mc. Before you order sets of crystals inspect contents of spare parts boxes carefully as many sets were packed with the shipboard spare parts but not listed on the inventory. If you have some bad u-h-f crystals do not try to replace the entire set, order only those necessary to replace the defective ones.

7—If you are not using your u-h-f equipments daily, turn them on and let them run for about an hour to keep moisture out and mechanical parts from "freezing."

8—Use your equipment as often as possible in order that all persons concerned become familiar with its operation and capabilities.—*SerLant Monthly Bulletin*

# Sonar Transducer Repair Facility

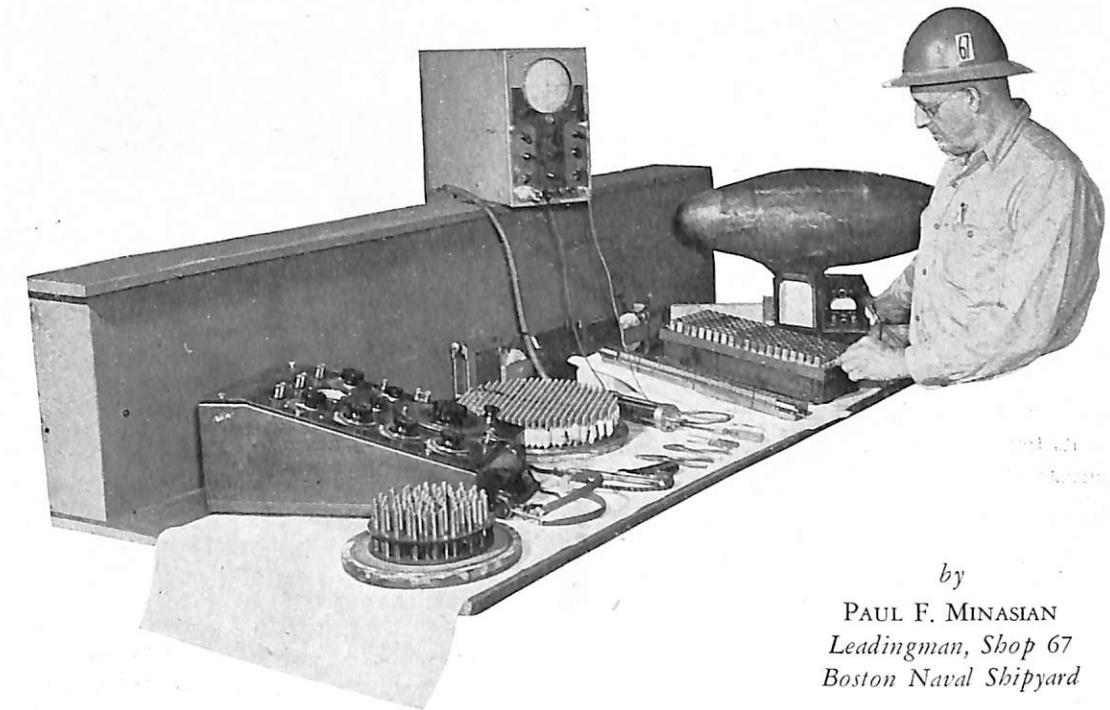

by  
PAUL F. MINASIAN  
Leadingman, Shop 67  
Boston Naval Shipyard

The establishment of a Sonar Transducer Repair Facility within Shop 67 of the Boston Naval Shipyard in July 1948 under the cognizance of the Shipyard Shop Superintendent provides the East Coast with this strategic activity for the manufacture and repair of the all-important sonar transducers. Prior to that time, only at Pearl Harbor and Mare Island were transducer repairs possible.

Thus, the necessity of long and costly transducer shipment for repair was eliminated as well as the most costly loss of all, time. In many cases a second dry-docking of a vessel for transducer installation was necessary due to the long periods consumed in transducer shipment to and from the remote repair facilities.

While still in its infancy, the Boston Facility was called on to manufacture complete NGA submarine transducer crystal assemblies to fulfill high priority needs. The original manufacturer had terminated his contract on this type equipment and no NGA's were available. It is a matter of record now that this undertaking was highly successful; priority deadlines were met and each transducer passed more rigid tests than the manufacturer's NGA's.

A second achievement was the complete assembly of an NMC fathometer magnetostriction array made possible largely by the use of a special jig devised by the Boston Facility. The Facility has also devised a jig for supporting QDA transducers in such a way that a transmitting response test can be plotted in a shallow tank with full tilting range bearings.

In addition, tank response testing of QHB type transducers has been initiated. By means of a specially devised, automatic, remotely operated transmitting and receiving multi-contacter, each individual section of the QHB can be tested for transmitting and receiving response. Also, special precision equipment has been set up to perform the highly sensitive electromechanical tests to this transducer before cable installation, wiring, and tank testing.

Since no sonar system can be any more efficient than its transducer, the most intensive tests are performed to assure a transducer's top operating quality before it is released for a ship's use. At the Facility, a transducer brought in for repairs undergoes the following exhaustive tests:



First, it is pressure sprayed with warm water and air to remove all foreign sea matter and growth, corrosion, and saline crystal formations. Then, it is cleaned with an acid solution and lignum vitae to restore the acoustic window to its normal condition of sound transparency. At this point, the cable is tested for insulation strength, followed by the application of a voltage several times its normal operating value. The resistance, inductance and capacity of the unit are then measured with a sensitive bridge to determine whether the unit falls within normal limits. If all indications are satisfactory, a band width of frequencies, ranging from slightly below the natural resonant frequency of the transducer to a value slightly above, is applied to determine frequency response, impedance ratio, and motional impedance characteristics. The foregoing tests determine the degree and order of repair necessary; and after repairs are effected, the preceding tests are applied again to ascertain repair adequacy.

Now the transducer is ready for either vacuum pumping or the application of a drying agent, as the case may require, to determine watertight integrity. Rejuvenated, the transducer now undergoes its initial submergence, whereby its test under actual "fire" may be determined. This consists of applying to it a voltage of a frequency comparable to its shipboard use. "Pinged" by an accurately controlled pulse-timing and measuring equipment, the transducer emits its acoustic energy in the direction of a sensitive flat-response hydrophone which converts the axial sound intensity into an alternating voltage of exactly the same frequency. This supersonic energy is time-gated, measured, and presented in both video and electromechanical form for observation and evaluation.

Since present day underwater detection equipment design accentuates maximum directivity, this requirement is closely plotted during the transducer's performance. Upon withdrawal from the test tank, the insulation strength of the unit is again closely measured to detect any tendency toward weakening.

ADP Crystal Assembly, removed from a Type-78248 transducer, showing the wholesale etching and crystal growing process which was caused by pollution of the castor oil while the unit was in service. Note the complete disappearance of many crystals through the center and right end of the unit. Other crystals have grown beyond their bounds and bridged over to form irregular masses.

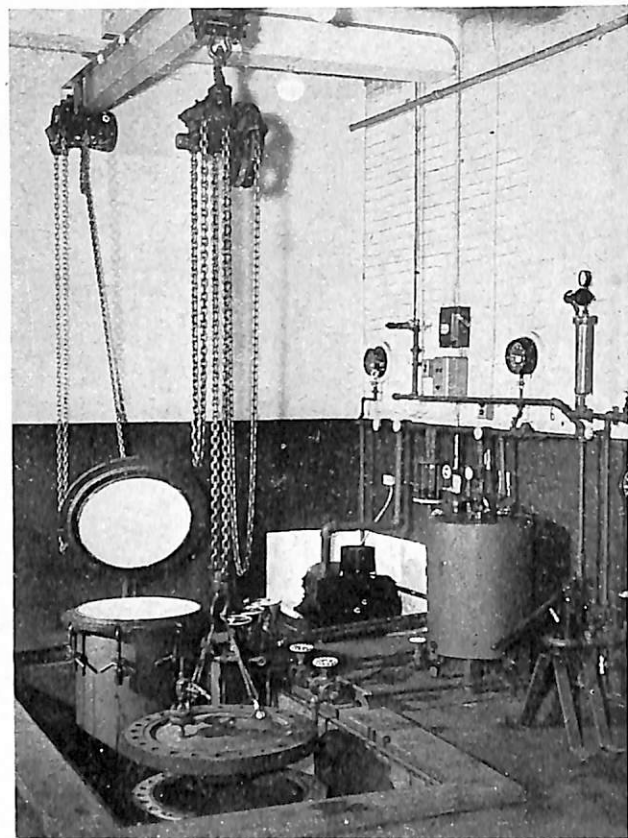
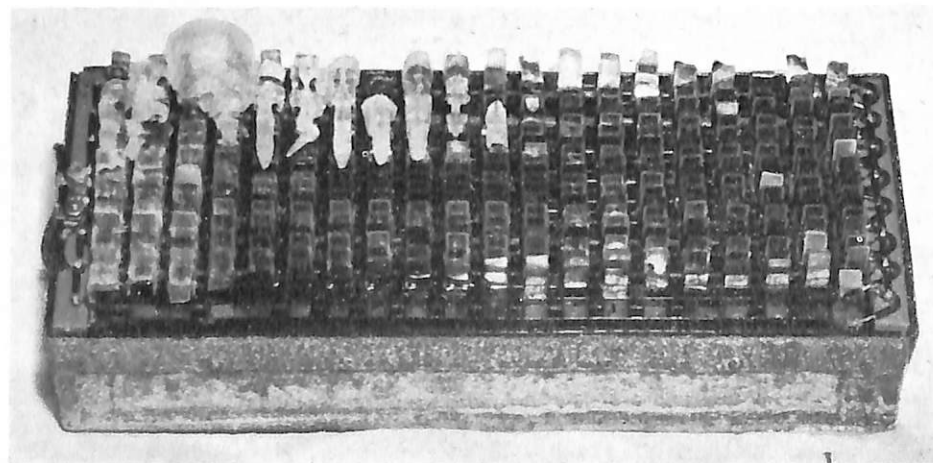

The means for applying a vacuum pumping process or a high pressure test to special transducers for submarine use.

Now the transducer is ready for its submarine mantle. First, a preservative coating is needed to protect its metal against the ravages of the sea, and then an outer cloak to ward off sea life whose growth would greatly attenuate and distort the sound beam.

However comprehensive and technical the above tests may be, the Facility's skill and ingenuity undergo their severest tests during the complete manufacture and assembly of a complicated crystal transducer array. The most critical and fragile of all sonar components, the Rochelle and ammonium di-hydrogen phosphate crystals



The Sonar Transducer Repair Facility. The test tank is housed in the right end of the building. This building has glass block windows.

require "feather touch" handling, utmost exacting care seasoned with pin-point tolerances, and full time vigilance of precise temperature, humidity, and solvent and ingredient purity. Particularly critical is the process of bonding the crystal array to the resonator plate during which expert coordination of timing, pressure, temperature, and component quality control spell success.

So delicate are some of the crystal operations that special means are taken to prevent breath-moisture from infiltrating the crystal atmosphere, since injury to crystals through moisture is usually irreparable.

The alternate transducer principle, based on periodic ferromagnetic elongations and contractions, imposes less problems with respect to atmospheric conditions and handling, yet, due to many intrinsic variables, exacts con-

tinuous and complex, rigid testing to ascertain this type transducer's merit. Such bothersome phenomena as reduced retentivity of permanent magnets, periodic changes in reverse permeability of metals, exposure to spheres of high magnetic influence causing induction, varying degrees of metallic fatigue, change in mechanical resonance, and decline in the acoustic characteristics of the materials, all tend to cut serious inroads into a transducer's efficiency.

The Facility has been alert to these problems and has attempted to devise adequate tests to detect immediately a weakened condition in all type transducers. To date, continued progress has been made in this direction, and we are confident that our efforts will bring full solution to these intricate transducer problems in the near future.

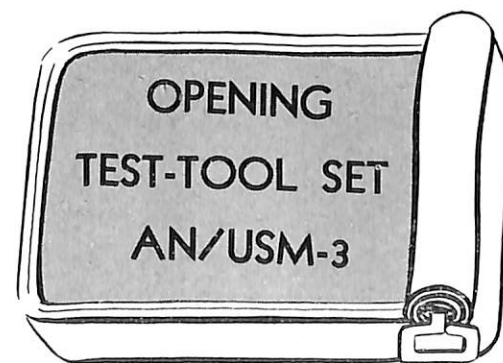

A case has been reported of a technician attempting to open the case of Test-Tool Set AN/USM-3 while it

was upside down. The nameplate, of course, is on the top of the case and serves as a guide in opening the case. Furthermore if the case is opened while inverted it will be difficult to lift and, if forced, will cause some of the pen type probes to crack.

In order to prevent a recurrence of this difficulty it is suggested that the word "bottom" be stenciled on the bottom of the case.

The Bureau is extremely desirous of obtaining comments on the usefulness and applicability of the test-tool set. Since it was designed primarily for emergency use under battle conditions reports of trial repairs under simulated emergency battle conditions are solicited.

Please address comments, reports, suggestions, etc., to the Bureau of Ships, Code 983E.



# The ELECTRONICS OFFICER ABOARD SHIP

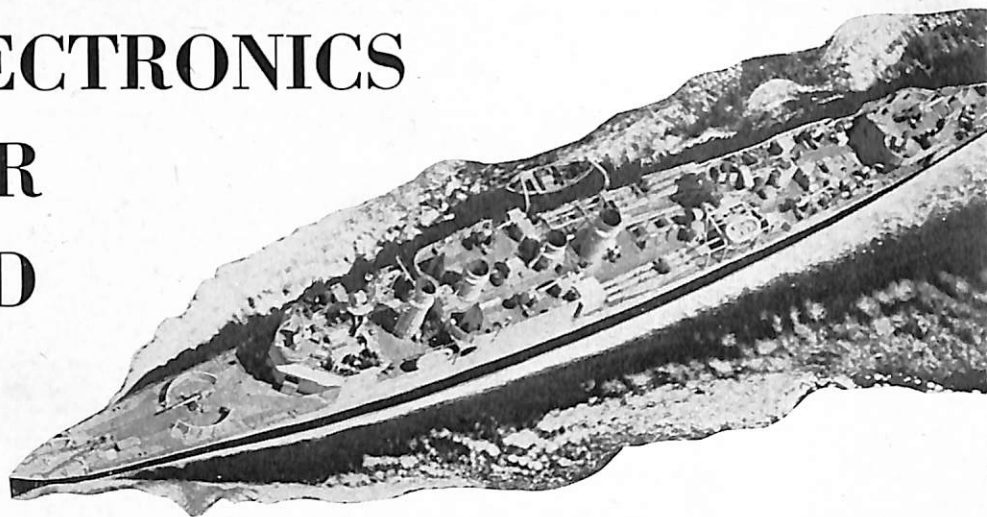

To begin with a challenge, the writer believes that organization and administration are the two most important factors in successful shipboard electronics maintenance. In the following paragraphs we will attempt to justify our stand.

## Organization

After reading LCdr Scott's thought provoking article in the February 1950 *BU SHIPS ELECTRON*, we began to piece together the various essential processes which are necessary to make electronics maintenance "tick" aboard ship. The following ideas appear to the writer to be the most necessary in successful electronics shipboard administration. Inasmuch as the AGC type vessel is one of the most complicated in its electronic system, it was chosen as the type for discussion. Naturally less complex electronic systems would hold to the same type divisional organization but in that case several duties or billets would be absorbed by only one man. It should be borne in mind that the allowance of ET's as discussed herein is a peacetime allowance. In war-time the actual number of ET's would be double or more than that stated. The allowance of radiomen would be several hundred also. In war-time the same type divisional organization would still hold but a more detailed assignment to specific equipment would be carried out. In brief, the system is flexible and readily expandable to meet almost any number of ET's available.

The normal allowance of ET's in the AGC type vessel is as follows, divided for purposes of this discussion into three major categories as indicated:

Rating	Radio	Radar	Shop
ETC-2	1	1	—
ET1-4	2	1	1
ET2-5	3	2	—
ET3-5	4	1	—
SN-4	2	1	1
Total	20	6	2

*BUREAU COMMENT: The opinions expressed in this article are those of the author, and are not necessarily those of the Bureau of Ships.*

Figure 1 is a functional sketch of the electronics divisional organization.

The Electronics Repair Officer is also the Electronics Division Officer and is specifically charged with "being responsible under the Engineer Officer for the repair of all electronic equipment" as well as being responsible to the commanding officer as a division officer for all duties as set out in Navy Regulations. He will be called upon to stand his normal tour of watches and will be assigned collateral duties. In some instances watches and collateral duties may absorb the greater portion of his time. Thus it becomes apparent that an organization of electronics technicians which can and does function without the active participation of the Electronics Officer is vital. The Electronics Officer who feels that he must be the most accomplished technician aboard and that he must personally supervise every minute repair is doomed to disappointment and will eventually face the complete breakdown of his electronic equipment. Technicians must function independently but with close cooperation as a group. The Electronics Officer should supervise to the extent that he is cognizant of what is going on in general and in some instances in detail, but never to the extent of paralyzing the efficiency of his technicians.

From the foregoing it is not intended that the Electronics Officer disinterest himself in the technical aspects of his job. He should in fact never overlook an oppor-

tunity to further his electronics education. The preferred method however is through the discoveries of his own technicians and not to bypass them entirely in personal research. When a unique casualty occurs and is repaired he should listen to the technician's listing of troubles and from his own knowledge of the equipment or from a schematic or in some cases from an actual survey of front-panel indications, analyze the defect. It is not necessary that the Electronics Officer have an extensive knowledge of electronics, but if he does have even an elementary knowledge then a more mutual understanding and relationship exists between himself and his technicians. His personality and administrative methods are far more important than his technical ability. We are speaking of the Electronics Officer aboard ship now rather than the electronics engineer.

The normal battle station of the Electronics Officer should be in the electronics workshop or in main damage control central. Normally the Electronics Officer should stand CIC watches. This will enable him to keep in close contact with operations activities so that he will know what equipment will be needed and when. In addition he can closely supervise radarmen's activities and the radar equipment in general. He can instruct personnel at every opportunity in the proper use and care of equipment. This procedure will also free the Radio Electrician to handle radio and communications.

The first assistant to the Electronics Officer and the individual who actually is in direct charge of the division's activities is the Radio Electrician. He is the technical specialist and should be regarded as such. No technical decision should result without his opinion. Usually he stands no watches and therefore is available 24 hours

a day. He is in the best position to draw up training programs for daily school. Specific delegation of responsibilities would depend upon the individual desires between the Electronics Officer and the Radio Electrician. The normal battle station of the Radio Electrician should be remote from that of the Electronics Officer, preferably in radio II or III in event of battle damage.

Referring to Figure 1 again it is noted that the three main categories of electronics are: radio, radar and shop (ASW type vessels have sonar in addition).

The chief electronics technician in charge of radio is responsible for all functions and maintenance of all radio equipment. His normal battle station is in radio I (main receiving room). His first assistant is his senior first class who is in charge of transmitters and whose battle station is in the main transmitter room (radio II). The ET1 has an ET3 assistant in keeping with the engineering practice of having at least two technicians service high voltage equipment. In the secondary transmitting room (radio III) another ET1 is stationed with his ET2 assistant. The ET2 should be in addition a u-h-f expert (TDZ/RDZ) inasmuch as in the particular vessel being described this equipment is located in the room adjoining radio III.

An ET3 with SN assistant is assigned to receivers in radio I under the ETC (radio). Another ET3 is assigned to both external and internal teletype equipment and associated projection machines. The TTY technician will ordinarily be a fleet school graduate in TTY terminal equipment. The normal battle station for these men is in radio I.

All radio equipment in CIC, Voice Filter, Joint Opera-

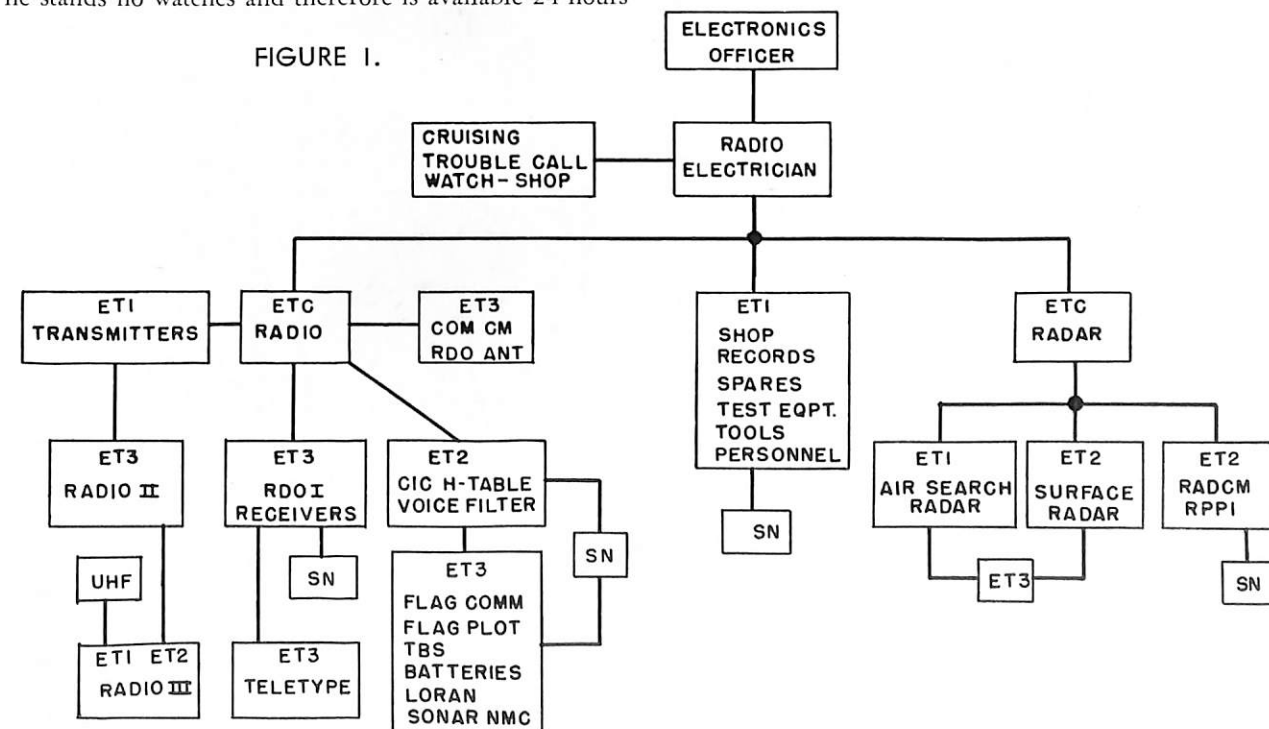

by  
 LT. RICHARD L. WARREN, USN  
 Headquarters Fifth Naval District  
 Norfolk, Virginia



tions, H-table, Flag Plot, Flag Communications, Bridge, Flag Bridge, etc., is broken down into two major divisions: CIC-Voice Filter and topside equipment less radar. An ET2 is put in over-all charge but with direct responsibility in CIC-Voice Filter, and with ET3 and SN assistants for topside equipment less radar. Normal battle stations are in CIC-Voice Filter and Flag Communications. The ET3 assigned to ComCM works directly for the ETC (radio) as delegated, in addition he is assigned radio antenna maintenance in general. ComCM equipment allowances are constantly changing so no specific functions will be discussed here. Higher classification also pertains.

The chief electronics technician in charge of radar is responsible for all functions and maintenance of all radar. He has three principal assistants. An ET1 is assigned to air search radars, an ET2 is assigned to all surface search radars, and an ET2 is responsible for all RPPI's and RadCM equipment. An ET3 and SN are assigned as additional assistants. The normal battle station for the ETC (radar) is in CIC along with his ET3 assistant. The ET1 assistant for air search-radar is in the topside radar room along with a SN assistant at air and surface search main frames. The ET2 assistant for surface search radar is in the forward radar room at additional air and surface search main frames and in company with the radar operators. The ET2 assistant for RadCM and RPPI's normally remains in the electronics workshop during battle or in the Radar Countermeasures Room.

The last category but by far not the least important is the ET1 and SN assistant assigned to the electronics workshop. This ET1 should be selected on his ability to "keep the ball rolling" on all fronts. He should be able to provide tools, spares, blueprints or test equipment whenever required for whatever purposes, as well as having a knack for handling paper work. He keeps tab on all work accomplished by electronics, makes watch quarter and station assignments of personnel, assigns working parties, cleaning stations, maintains publications, instruction manuals, machinery histories, blueprints, schematics, work requests, job orders, failure reports, spare parts stowage, shortages, requisitions, receipts, expenditures and many other tasks. In brief he should be the ET1 in training for ETC. By assuming all the tedious tasks of day to day administration he permits all others to become free to actually perform physical electronic maintenance and repair. This is a most important function in the divisional organization. All too often the Electronics Officer and Radio Electrician become embroiled in these small details and lose sight of their over-all supervisory capacity. The normal battle station of the ET1 and SN assistant is in the electronics workshop.

The normal cruising watch is a 24-hour trouble call watch (2 ET's, one for radio, one for radar) who

bunk in the electronics workshop. In some cases ET's are required to take the transmitter watch in radio II. This particular watch for ET's is undesirable for several reasons. The ET's lose valuable man hours which could be spent in maintenance and repair work, and the radio-men are not receiving any material training. It would seem foolish that operations would deliberately reduce the qualifications and effectiveness of their petty officers. Such a state is an adverse reflection upon training officers themselves.

### Administration

The problem of administering the electronics division is similar to that of administering any shipboard division. A peculiarity of the electronics division however is the exceptionally high level of intelligence of personnel. Before any man can become an electronics technician he must have gotten a GCT mark of 55 or better among other high standards. This is not a requirement for a seaman in the deck force. As with any group of superior training or background it is much more difficult to sway technician's attitudes and thinking than with unskilled personnel. Iron-handed discipline will not work here.

The division officer must thoroughly study the service records of each man, become familiar with his background, learn his personal problems, and see to it that he is working at a job which satisfies him. There should be a mutual feeling that the man will come to his division officer at any time to discuss a personal problem and that the problem will be received with an attentive ear. By this it is not meant that a complete breakdown in military relationships should occur, but that electronics technicians can usually be dealt with in a much more informal manner than with un-skilled personnel without fear of becoming familiar.

Those technicians with the highest GCT should be placed in charge of projects with some few exceptions. The higher level of intelligence will show in due time. It becomes apparent in one man consistently solving problems just a bit sooner than the other man. Do not err however in retaining an ET just because he does have an exceptionally high GCT mark. Personality adjustments within the division are just as important. If he cannot "get along" with others, his high I.Q. is useless.

The ultimate goal in administering the electronics division is that the division will function by itself and on its own initiative without being pushed continually by the division officer. This is most certainly possible if personnel are carefully selected, adjusted and indoctrinated. The Electronics Officer then becomes a bystander, a general supervisor, and the division continues to function just as efficiently whether he is present or not. The will to accomplish has been created.

The writer has made a unique observation in connection with personnel working at jobs with which they are

dissatisfied. The results are not conclusive by any means, but it can be stated that a relationship exists between personnel injury rate and job dissatisfaction. It was learned that those technicians who were assigned to jobs in which they were not particularly interested or to which they had asked not to be assigned, experienced injuries, whereas personnel assigned to jobs in which they were most satisfied experienced no injuries of any sort. Coincidence? Perhaps.

The division officer must constantly seek to improve morale in the division. This can be done in any number of ways. Job satisfaction seems to be the principal tool at the disposal of the division officer. He must carefully note personal relationships within the division. One "bad apple" can ruin all of his strenuous efforts. In some instances the only solution seems to be a transfer to new duty away from the ship entirely. Good chief and first class petty officers are not only a necessity in the electronics division, they are indispensable. Without good leaders nothing constructive can be accomplished. There was a time after the late war when a lone technician was welcomed aboard no matter who he was or how competent. That day has passed. Cast out all the second-raters and have in the electronics division the "cream of the crop." Comb through the ship at regular intervals and solicit the most promising young strikers, especially so those with high GCT marks. Show these new men the advantages of learning electronics and point out its benefits both in and out of the Navy. The electronics division has the distinction of having a higher average I.Q. than any other group of men aboard ship. The division officer should always keep that fact in mind. It is not inferred here that the ET should rest on his laurels but conversely by virtue of his having better than average mental equipment the division officer can set higher standards and expect more results both in the application of skilled knowledge and in conduct and courtesy.

The percentage of ship-overs in the higher brackets is a good indication of the state of morale within the division. The division officer should encourage the lower rates to ship-over of course but many times a young man feels compelled to get out. Sometimes an actual comparison of "hidden-pay" benefits in the Navy with civilian pay for a non-college man reveals to the young ET for the first time that the Navy isn't so bad after all. Another and relatively important factor in good morale is that of permanent job assignment. The ET should be assigned to the job of his choice subject to the exigencies of the service and informed that it is permanent for a given period (6 months or so). He should understand that he is fully responsible for the maintenance and repair of that equipment. If he can keep it operating with 30 minutes work each day, all well and good. If he has to work 24 hours each day,

well, that's his problem. Nothing can destroy morale so rapidly as the shifting of an ET from one job to another because a shipmate shirks carrying his part of the load, or due to favoritism on the part of the division leaders.

### Materiel

Probably the two most important factors in keeping materiel in optimum operating condition are the electronics workshop and equipment check-off lists. This may sound strange at first but let us elaborate.

First the electronics workshop serves several useful purposes. Electronics divisional activity should revolve about the workshop as a sort of operations center, similar to the familiar gunner's mate "shack." ET's should have their coffee mess here if authorized, where it can be supervised. All records should be filed in an orderly manner, complete sets of instruction manuals, blueprints and schematics should be available. Workbenches should be available with adequate lighting. A complete array of test equipment should be mounted above the workbench to permit the testing of any small-size electronic equipment. Provision should be made for the stowage of technicians' tools and repair kits. The usual rubber deck matting should be placed. The psychological aspect of the electronics workshop overshadows its maintenance value in that the technician unconsciously feels that there is a location in the ship which is "off-limits" to all but the technician, and also that if it is necessary to completely dismantle a component of electronic equipment for repairs, the electronics workshop has just the facilities and equipment to do so. Nothing can be so discouraging as having to analyze and repair equipment in a passageway in poor lighting and with dozens of people crowding by.

With electronic equipment scattered about the ship, it would be impractical to transport each defective component to the workshop for repair. The idea of transporting heavy test equipment about the ship for the same purpose is also undesirable. A simple solution then is to permanently mount test equipment about the ship at strategic locations so that a maximum amount of equipment can be serviced with that test equipment. In brief, establish small "workshops" near the equipment. For example: near the radar mount an echo box and scope; and in radio I mount a small workbench in one corner with tube tester, signal generator, volt-ohmmeter, condenser checker, power supply, etc.

If your allowance of test equipment is not complete, obtain all items as soon as possible. Technicians cannot be expected to accomplish the impossible. With adequate test equipment, efficiency will be greatly increased. In addition prestige will be increased if they are observed using complicated test equipment. They become technicians rather than radio mechanics. For example: the new test set AN/USM-3 issued recently is



outstanding. It is small, light-weight, readily portable, and once the technician becomes familiar with its uses, he cannot use it enough. It is unfortunate that the allowance is so small. Each technician should be allowed one set.

Check-off lists were listed as one of the factors in enabling the optimum maintenance of electronic equipment. We classify several procedures as "check-off lists." First, it was learned that the practice of verbal equipment status reports at morning quarters is most effective. These reports consist of listing the general condition of electronic equipment assigned to the petty officer in charge as of 0800. The value of this report is two-fold. The technician or operator personnel must actually operate the equipment to check its operation before 0800 each day and the Electronics Officer receives a complete and up-to-date summary of his entire electronics installation if necessary to report that data at morning quarters. Naturally if any casualties occur thereafter, he is informed of that fact also. Daily operation of electronic equipment is paramount. Many small and disturbing casualties (relays sticking, switches broken, controls slipping, dial lights out, etc.) can be caught with this procedure and repaired in short order. Another advantage provided by the morning status report is that the daily work plan can be laid out quickly. The technician reports such and such a casualty, states that he will be repairing it that morning, or requests that it be listed on weekly work plan for the following week or listed in the CSMP as a shipyard repair.

The "weekly work plan" mentioned above is another device useful to the Electronics Officer. It was originally devised upon the request of the Engineer Officer who desired both a record of important work accomplished by electronics and a projected work plan for the coming week. You will find that it is valuable. It engenders foresightedness in intelligent work planning, provides a maximum utilization of available man hours, and ensures an orderly progress of maintenance work. This weekly work plan is a composite of all desired work items as submitted by all hands in the electronics division, not necessarily only ideas of the Electronics Officer.

The use of "equipment failure reports" is also recommended. This is merely a mimeographed form listing pertinent information in connection with equipment failure: reason for failure, serial number, spares used, etc. This form is filled in by the technician making the repair in a few seconds time and turned in to the ET1 in charge of the electronics workshop. He then extracts the required data for entry in the machinery history, fills out NAVSHIPS 383 (BuShips failure report), causes spare parts used to be requisitioned if necessary, etc.

The actual "check-off lists" as such are the key to

the whole electronics maintenance program. The Electronics Officer in collaboration with other divisional personnel and with other ship types similar to his own should extract pertinent material from the BuShips Manual, Equipment Instruction Manuals, publications. CEMB, RMB, EIB, etc., to draw up a composite check-off maintenance list for each equipment on board. The checkoffs should include daily, bi-weekly, monthly, quarterly and annual items. It should be complete in every respect. Every week these check lists should be issued to petty officers in charge of equipment for checking off each item as maintenance is performed. At the end of the week, the electronics workshop ET1 should look over the check lists and note any discrepancies, calling the Electronics Officer's attention to any discrepancy of note. The check lists should be kept on file for a short time for reference purposes if any question should arise as to whether or not an equipment was given routine maintenance. The Electronics Officer will learn that the check-off lists pay the best dividends of all. Their use is highly recommended.

To actually carry out the required upkeep and maintenance procedures as required by Bureau instructions would require more ET's than available on board ship in conjunction with working parties, inspection, compartment cleaners, watches, etc. A certain minimum amount of time must be spent however in maintenance of electronic equipment or it will cease to function. The Electronics Division Officer is faced with the problem of expanding his man-power, or stretching his working force. About the only solution here is enlisting the aid of operator personnel for routine upkeep and maintenance and keeping technicians available for repairs. This sensitive subject will tax his ability as a diplomat. First he must obtain official approval, then, having received it must teach reluctant operator personnel how to perform maintenance. Ingenious arguments will be presented on why operator personnel should not do the ET's job. Diverse dodges and obstacles will be presented to the Electronics Officer on why radiomen should not know how to tune transmitters, or why radarmen should not know what the SG main frame is.

We will take a chance at this point to stick our neck out by submitting that electronics should be shifted to the operations department instead of remaining under engineering. Many obstacles would be removed from the path of electronics maintenance if this were so. ET's would not be continually changing tubes in equipment not being used that had been carelessly left energized by operator personnel, there would be less clash in obtaining operator personnel aid in maintenance, only to mention a few points, because operations would be responsible for the maintenance and repair of its own equipment.

The Electronics Officer can expand his man-power

force by utilizing every opportunity to gain outside help. Obtain tender, shipyard or advance base assistance whenever physically possible. Obtain electronics inspections from various activities affording this service whenever possible. Continually seek electronics assistance. The maintenance of electronic equipment requires continual checking, re-checking, adjustment and repair. The Electronics Officer can never say, "All my equipment is in perfect operating condition." With the small force of technicians he has at his disposal, he must have outside help.

In performing electronic maintenance good judgment is necessary. Never undertake major repairs too near dates of operations at sea. Always test operate equipment before its scheduled use. Before any important operations at sea replenish tubes in equipment with new, tested tubes. Continually check critical adjustments. Operate equipment daily. Stow equipment-tested tubes near equipment to facilitate emergency repairs. Continually plan ahead as far as is possible. Plan your maintenance program so that the electronic equipment will be as near in perfect condition as is possible before getting underway. Before entering port have job orders prepared to rush to a repair activity as soon as possible. Your plans will never work out perfectly, but the nearer perfect, the better.

Proper analysis of the operation of electronic equipment cannot be made without a blueprint or schematic if it is at all complex. The blueprint and schematic file kept in the electronics workshop must be complete and up-to-date if any intelligent idea is to be obtained of the ship's complex cabling system and remotes, as well as the individual electronic equipment. Ensure their correctness and enter corrections as they occur. Nothing can be so exasperating or wasteful in time and man-power than attempting to use a blueprint or schematic which is incorrect and not knowing it is incorrect.

Without an adequate supply of spare parts and efficient methods of procurement, stowage, and expenditure, the electronics division cannot hope to operate effectively as a repair organization. This fact should be self-evident. All too often the ET ultimately determines that C205 is shorted in the TBK and hustles down to several storerooms to find the TBK spares, finds the box in which C205 is located, opens the carton marked "C205" to find that someone else has done just that but forgot to order a replacement and has kindly left the empty carton in spares. The ET1 in the electronic workshop can eliminate this type of slipshod spare parts maintenance. He should be held fully responsible for having the required spares when needed or show sufficient reason for not doing so. The new spare parts program which places small items in bins seems to be satisfactory in all respects and will be a boon to streamlined spare parts handling.

The Current Ships Maintenance Project should be kept by the Electronics Officer personally, due to its relative importance. Applicable alts, navalts, alt requests, correspondence references, work requests, job orders, etc., should be included. The Electronics Officer should attempt to be as foresighted as possible in connection with installation of new equipment aboard his vessel and the modernization or improvement of existing installations. He should not hesitate to intelligently criticize shipyard installations or request considered changes. Shipyards work under tight schedules too and many times would like to do better jobs than is physically possible for them to do within time limitations. Oftenwise better shipyard installations would result if the vessel would provide an ET co-worker in conjunction with the shipyard crew for liaison and inspection purposes.

The CEMB, RMB, ELECTRON and EIB are sources of indispensable information and should be kept readily at hand for technician use as desired. It goes without saying that these publications should be corrected without fail. Any special instruction requiring immediate attention should be disseminated without delay to the petty officer in charge of the equipment concerned.

A common distasteful situation which faces the Electronics Officer almost daily is that of requests for unauthorized changes in electronic equipment or in the electronic system itself. "Jury rigs" are strictly taboo. Unauthorized changes are prohibited by the BuShips Manual to begin with but may cause trouble in any number of ways in the equipment itself or within the electronic system. Naturally if the Commanding Officer authorizes the change in writing, it will be made. The preferred method however is to request the change via official channels as an authorized alteration to the electronic system.

## Training

Electronics training aboard ship will fall into three classes: becoming familiar with ships electronic system, becoming familiar with specific equipment, and general electronics instruction.

Training to provide familiarity with ship's electronic system can largely be accomplished by on station instruction and rotation of job assignments. Have the petty officer in charge of a station prepare and give lectures regarding the electronic equipment located within his sphere of responsibility, explain cabling and remotes emanating from his station, demonstrate patch panels operation, switching systems, etc. Encourage an ET to plan ahead as to what new station he would like to be assigned. The objective here is that any ET should be able to take over another ET's job at any time, and by the time he has learned all electronic stations and responsibilities in the ship he will be competent to as-



sume chief petty officer duties. Another valuable practice in this connection is to require the submission of sketches and diagrams of wiring, cabling and remote systems.

Training to provide familiarity with specific electronic equipment is accomplished by actual on-the-job instruction using the "big brother" method; i.e. a higher rated ET experienced with the equipment teaches a younger man in the learn-by-doing process. Equipment peculiarities are passed on in this manner and such valuable information will never be lost so long as a complete turnover in personnel does not occur. Personnel should be required to trace out and make sketches of power supply lines and local remotes for purposes of familiarization.

The use of test equipment and tools should be taught by chief petty officers or experienced first class. It is extremely important that good habits and procedures are formed in the minds of the younger men with this instruction.

General electronics instruction should be carried on for ET3 and SN strikers. Valuable progress courses are available for this purpose as well as many excellent movies and mock-ups. The class "A" electronics school course of instruction should be followed as closely as possible. Trainees should be encouraged to build small radio receivers in conjunction with their course of instruction, i.e. power supply, audio amplifier, detector, intermediate amplifier, oscillator, mixer and r-f stage. It would be desirable if small receiver kits were allowed vessels for this purpose.

Daily school should be held regardless of commitments short of emergency battle repairs. At times it may seem foolish and wasteful to continue daily schooling but in the long run it never is, providing the proper

## CHECK YOUR SHIPYARD OVERHAUL WORK LISTS

Many of the Service Force ships scheduled for Naval shipyard overhaul submit electronics work lists. Some are compiled by the technician, and some by the Electronics Officer. In many cases, these lists contain items which can and should be accomplished by the ET rather than by shipyard personnel. Due to the shortage of repair funds within the Fleet, it is necessary that an intensive effort be made by the ships to do as much electronic work as possible with the ship's personnel. The following list of items are normally considered to be ship's force work:

- 1—Antennas—clean, paint and replace wire antennas.
- 2—Bearings—replace in small motors and generators.
- 3—Cabling—replace small uncritical lengths.
- 4—Direction Finders—cleaning, routine maintenance, loop checks and calibration.
- 5—Field Changes—All field changes of a minor nature, and those designated as being accomplished by

**BUSHIPS COMMENT:** Although the above was originally addressed to Service Force Atlantic ships only, the Bureau feels that it applies in general to all ships in active status. Further comment is invited on this subject.

type of training is carried out. The ideal time to hold school is immediately after morning quarters for about 45 minutes depending upon what is to be taught and daily commitments. Never let an opportunity for training be lost. If an ET has an exceptionally good idea or procedure assemble the division and hold school. The immediate man hours lost may be made up later by good impressions created in the minds of your ET's. The ship should be considered as one continual school of instruction. Show a sincere interest in the progress in rate of your ET's. Every day should be spent in improving the state of maintenance of the electronic equipment and in improving the electronics technician in his ability to perform the duties of his rating as well as training him for next higher rating.

A long range program should be laid out in connection with efficient use of fleet schools. The ideal situation is that a new striker is sent to school just as a school graduate is returned aboard. Special equipment maintenance schools (TTY terminal, UHF, RCM, etc.) should be utilized to the maximum. Never make the mistake of maintaining that a *deserving* man cannot be spared to attend school.

The state of training in the electronics division is a direct measure of the effectiveness of the electronics personnel, the degree of control that the Electronics Officer is able to exert over his personnel and the condition of the electronic equipment.

### Summary

In closing, we repeat our first statement, that organization and administration are the two most important factors in shipboard maintenance. The Electronics Officer who can organize and administer most effectively will win the battle of electronics maintenance.

- ships' force on the F.C. Bulletin.
- 6—Generators—routine cleaning, maintenance and minor repairs.
  - 7—Insulators—cleaning and replacement as required.
  - 8—Jacks (phone)—replacement and repair.
  - 9—Keys (telegraph)—installation, replacement, adjustment and repair.
  - 10—Loran—repair and adjustment.
  - 11—Meters—minor repairs only, replacement of meters which are integral parts of equipment.
  - 12—Oscilloscopes—repair and adjustment.
  - 13—Receivers (all types)—all repairs except alignment; all tests.
  - 14—Transmitters (all types)—all repairs and alterations, except major changes, and repairs to sealed oscillator compartments; all tests.
  - 15—Test instruments—all repairs except where special instruments or techniques are required.

—SerLant Monthly Bulletin.

# WAVEGUIDE HYBRIDS

In the past fifteen years, the waveguide has been developed from an electrical curiosity to an important medium for microwave transmission. Progress was especially rapid during the war years, since many of the most important developments in radar would have been virtually impossible without waveguides. It is now possible to judge with some perspective the role that waveguides will play in communications developments of the near future. Hollow-pipe guides do not assume a thoroughly practical form until the wavelength is shorter than about thirty centimeters. At this upper limit, the waveguide has supplanted coaxial cables in same instances. For shorter wavelengths, it becomes increasingly attractive, so that at ten centimeters it is the preferred medium for the efficient, shielded transmission of high power, and at three centimeters it is almost exclusively used.

Although the earliest work emphasized waveguides as a form of transmission line for radio waves, it was apparent from the outset that waveguide structures would be required also to serve as numerous basic electrical components. At low frequencies, these components include such elements as coils, capacitors, resistors, transformers, relays, and switches. It was soon found that waveguide counterparts of these low-frequency elements could be constructed to operate in the microwave region. To the uninitiated, the electrical behavior and physical form of these new components appear novel and even revolutionary.

The investigation of waveguide transmission and of related circuit elements, as carried on by Dr. G. C. Southworth and his associates, opened up vistas of a radically new communications art for the Bell System. Expanding effort in microwave research and development is now bringing about a reduction to practice. The engineering



Courtesy Bell Telephone Laboratories

of waveguide components, for example, is already sufficiently far advanced to permit construction of a microwave circuit between New York and Boston in a manner only dreamed of ten years ago.

One of the waveguide components which is finding a wide variety of uses is the four-arm junction shown in Figures 1 and 2. If wave power is sent into this junction from the arm S, Figure 2, half of the power flows into each of the arms 1 and P. Conversely, if waves are sent into the junction from the arm P, the power is again equally divided between arms 1 and 2, with none flowing into the arm S. Thus arm S and arm P are balanced with respect to each other, provided arm 1 and arm 2 are terminated in a symmetrical manner. Since the junction provides balance reminiscent of the familiar hybrid coil, it is called a hybrid junction.<sup>1</sup>

The features just described, depending upon the combination of geometrical symmetry with the polarization properties of rectangular waveguide, are inherent in the junction by itself. An important refinement is realized, however, when reactive tuning, as exemplified by the metal post and rod in Figure 2, is associated with the

<sup>1</sup>The term "Magic Tee" which has also been applied to this construction, is felt to be a misnomer—See BUSHIPS ELECTRON for April 1947.



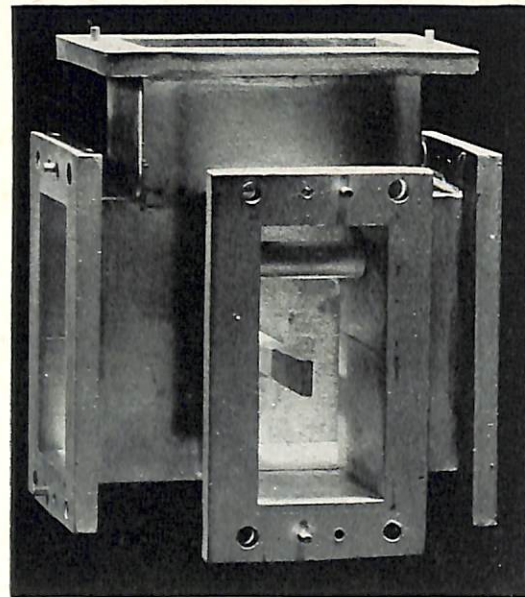

FIGURE 1. One form of waveguide hybrid.

junction. These added elements improve the impedance match of the junction to each of the four arms, and thereby automatically bring about a high degree of balance between arm 1 and arm 2.

A qualitative explanation of the hybrid junction can be arranged to bring out some of the more important aspects of modern waveguide theory and practice. It is recalled that radio waves can be freely propagated within any conducting tube, so long as the wavelength is shorter than a cutoff wavelength determined by the cross-sectional size and shape of the pipe. There is, indeed, an infinitude of transmission modes, corresponding to different patterns of lines of force, which can be established and maintained for wave transmission, and thus an infinitude of different wavelengths. For reasons of simplicity, however, waveguide developments have so far been confined almost exclusively to the mode of longest cutoff wavelength, the so-called dominant wave, in pipes so proportioned that no other mode can be freely sustained. Also, for practical reasons, only circular and rectangular shapes are in common use. In Figure 3, lines of electric intensity in the dominant wave are shown for tubes of circular, square, and oblong cross-section. A close resemblance to radio waves in free space is evident.

There is an important difference between symmetrical and non-symmetrical pipes, however, with respect to the permissible orientation of the plane of polarization. Patterns are shown in Figure 3 for both vertical and horizontal polarization. In the circular and square pipes, the configuration may have any orientation, depending upon the manner in which the waves were initially launched. In an oblong pipe, however, the cutoff wave-

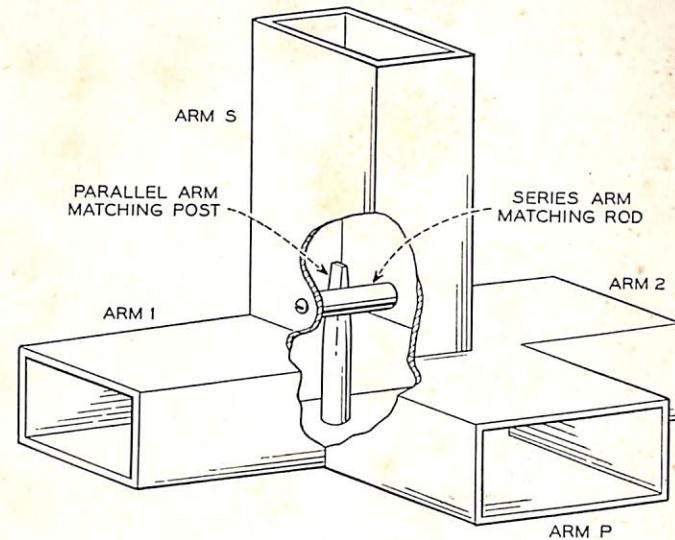

FIGURE 2. Perspective cut-away view of waveguide hybrid showing "rod" and "post" used in impedance matching.

length corresponding to the cross-polarized oscillation can be depressed below the operating wave-length, and only the fixed orientation shown can be freely transmitted.

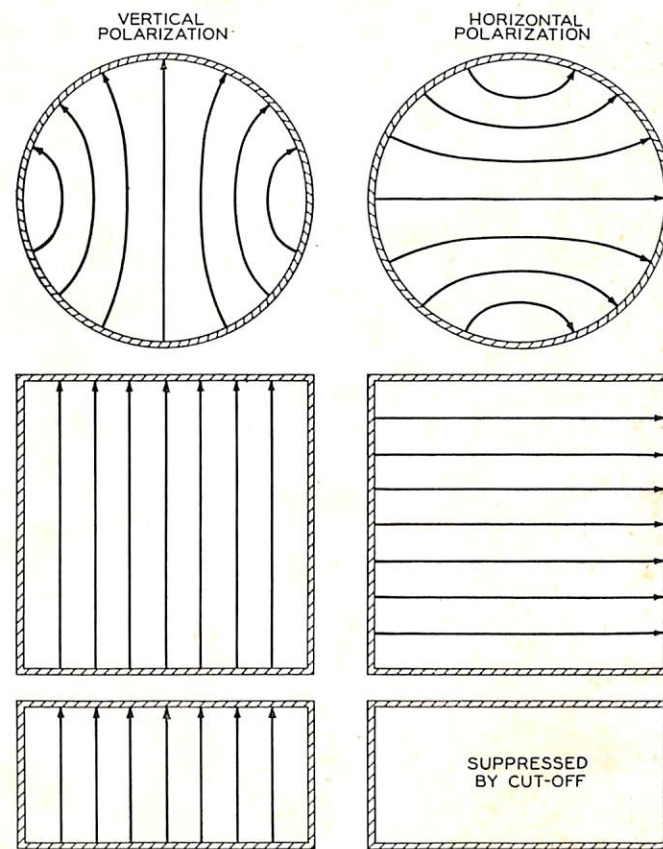

FIGURE 3. Electric field configuration in circular, square, and oblong guides.

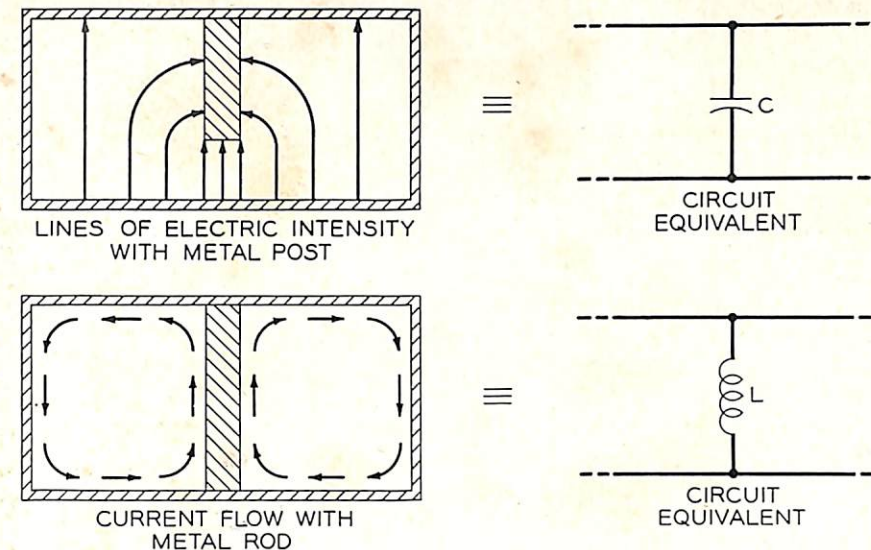

FIGURE 4. A "post" at the upper left is equivalent to a shunt capacitor, while a "rod" lower left, is equivalent to a shunt coil.

An oblong shape is thus preferred whenever there is any chance that the polarization may be rotated in an uncontrolled fashion. Experience has shown that unavoidable irregularities or deliberate distortions, such as bends, do tend to rotate the plane of polarization in circular waveguides to such an extent as to interfere seriously with the normal operation of the system. For the most part, therefore, waveguide components have been developed with rectangular guide. Best results are generally obtained when the proportions of the cross-section lie in the vicinity of 1 by 2, with the larger inside dimension equal to about three-quarters of a wavelength.

Waveguide studies are greatly facilitated by the close analogies that can be established with conventional transmission line circuits. Just as the waveguide itself is representable as a transmission line, so also can waveguide components be replaced for analytical purposes by equivalent networks of impedance elements in associa-

tion with sections of line. For the simpler waveguide structures, the equivalent networks are obvious upon inspection or can be readily derived from elementary consideration of electric fields and currents within the configuration. This is true, for instance, of the post and rod already shown in the hybrid junction. As indicated in Figure 4, the metal post concentrates the electric field between itself and the nearby wall of the guide, and is equivalent to a capacitance placed in shunt across a transmission line. With the metal rod, on the other hand, the principal effect is to provide paths for conductive current flow between the connected walls of the guide, with a resulting increase in magnetic flux and flux linkages, and thus it is like an inductance in shunt across a line. Provided that reasonably good conductors have been selected for the post and rod, their resistance components can be neglected except in extreme cases.

For more complex waveguide structures, accurate representation in terms of equivalent networks can often be reached only after considerable study. This is true of the hybrid junction. For a first approach to this subject, equivalent network analysis is not well suited. Instead, use can be made of analogies with optics. Here the principal concern is with the spreading of a wave front from one portion of the structure to the others. In a straight section of guide, the wave fronts are plane; distribution of the electric field has been indicated in Figure 3. In the vicinity of a severe discontinuity such as an abrupt junction, there is local distortion, wave fronts become curved, and the field may follow a complicated distribution. An accurate knowledge of this distortion is not essential, however, in deriving important properties of the hybrid junction.

Figure 5 shows what happens when a wave front spreads into a hybrid junction from the arm S. Lines of electric intensity are drawn in several successive positions of the wave front. To show why no power flows

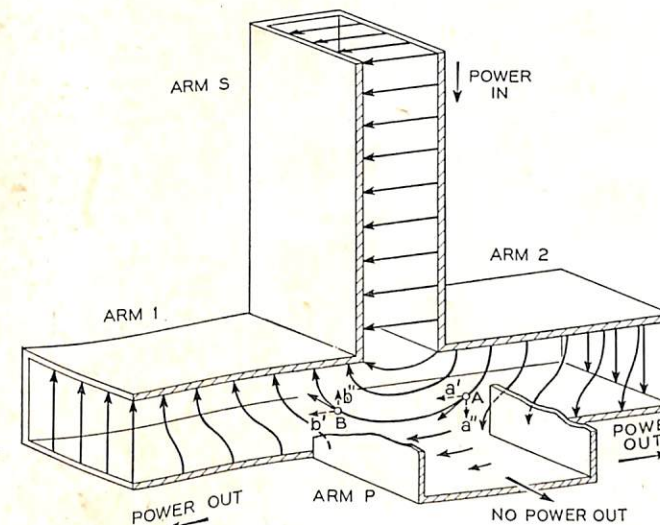

FIGURE 5. Electric field at a hybrid junction with power flowing in through arm S.



into the arm P, the electric intensity in a typical position of the front is indicated vectorially at two points, A and B, symmetrically disposed with respect to the center of the junction. At A, the local field has components  $a'$  toward the left and  $a''$  downward, while at B the components are  $b'$  toward the left and  $b''$  upward. From symmetry, the magnitudes of the respective components at A and B are equal. Thus, the downward and upward intensities  $a''$  and  $b''$  cancel, or, more precisely, they induce equal and opposite voltages in the arm P as the wave front spreads into that arm. The intensities  $a'$  and  $b'$  reinforce each other and tend to produce in the arm P a cross-polarized wave. If the arm P guide is correctly proportioned, however, the cross-polarized wave cannot be freely propagated. This shows that no power flows into the arm P as a result of the electromotive force exerted at A and B. All other points in the wave front can be grouped in pairs, symmetrically located with respect to the junction center, and the same conclusion holds for each pair of points. From the wave front as a whole, therefore, no power flows into the arm P, and the power which is transmitted through the junction must appear in arm 1 and arm 2, and from symmetry, in equal amounts. It will be noticed that at points equidistant from the junction, the polarities of the electric intensity are reversed in arm 1 and arm 2. With respect to phase, at least, the arm S acts as a transmission line connected in series with the line corresponding to arm 1 and arm 2.

What happens when a wave front spreads into the junction from the arm P is shown in Figure 6. With respect to flow toward the arm S, the lines of electric intensity are seen to be directed so as to create only a cross-polarized wave in the arm S. As in the previous case, there are, in places off-center from the junction, additional components arising from the curvature of the lines of force, but these are cancelled by the mirror image components on the other side of the junction center. With properly proportioned guide for the arm S, therefore, no power flows into it from the arm P. This conclusion is in harmony with the reciprocity theorem for electrical networks; if no power can be transmitted from arm S and received at arm P, then no power can flow the other way when the positions of transmitter and receiver are interchanged.

Figure 6 also indicates how power from the arm P spreads into arm 1 and arm 2. With complete symmetry prevailing in these arms and their terminations, the power is equally divided between them. Here the geometry does not act to reverse the polarity of lines of force, and at equal distances from the junction, voltages in arm 1 and arm 2 are in phase. From this consideration, the arm P is regarded as analogous to a transmission line connected in parallel across a line corresponding to arm 1 and arm 2.

To reveal clearly the balancing and power dividing properties of the hybrid junction, the picturization of wave propagation has been simplified by neglecting waves reflected from various parts of the junction. On account of the sharp geometrical discontinuities involved, field patterns in the region of the junction are in reality very complicated, corresponding to the superposition of waves bouncing back and forth within this region. All reflected components are symmetrical or paired with respect to the center, so that they are incapable of disturbing the balance of power division. The presence of reflection does, however, lead to a serious impedance mismatch of the device to the individual arms. These mismatches can be eliminated by incorporating within the junction tuning elements such as the rod and post visible in Figure 2. From an optical point of view, they are regarded as sources of additional reflections whose amplitudes and phases are such as to bring about cancellation of the original reflections. In terms of network analysis, the rod and post are equivalent, as has been pointed out, to a coil and capacitor, and are disposed so as to tune out the reactance associated with the equivalent network of the junction. By a proper choice of

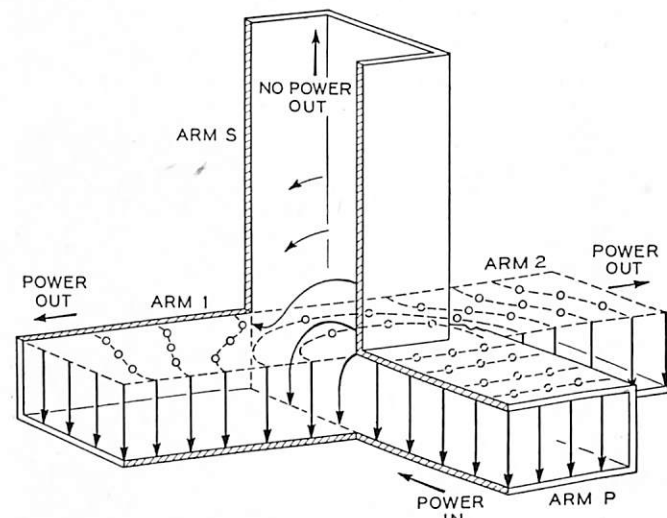

FIGURE 6. Electric field at hybrid with power flowing in through arm P.

tuning elements, effective neutralization of reflections can be obtained over a remarkably broad band of frequencies. Other tuning means, metal plates for example, can be used in place of the rod and post. The particular combination shown, developed by C. F. Edwards, is being widely used.

When the hybrid junction has been matched by reactive tuning, it exhibits the further customary property, that of balance between arm 1 and arm 2. If power is caused to flow into the junction from arm 1, a hasty analysis of wave-front propagation leads to the conclusion that the power will be divided in some fashion among the other three arms. This is indeed true. The

use of matching reactors, however, automatically brings about a balance between arm 1 and arm 2, so that power flows only into the arm S and arm P and is, moreover, evenly divided between them. This behavior, while not obvious from an optical standpoint, is a necessary consequence of the law of reciprocity.

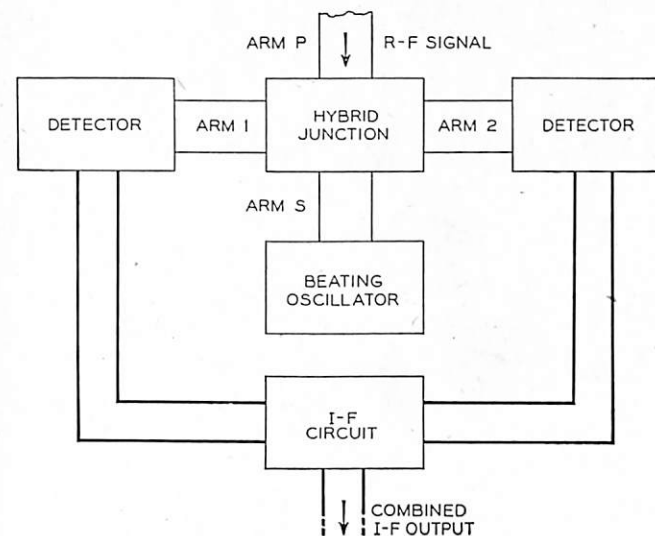

FIGURE 7. Use of a waveguide hybrid junction with a balanced converter.

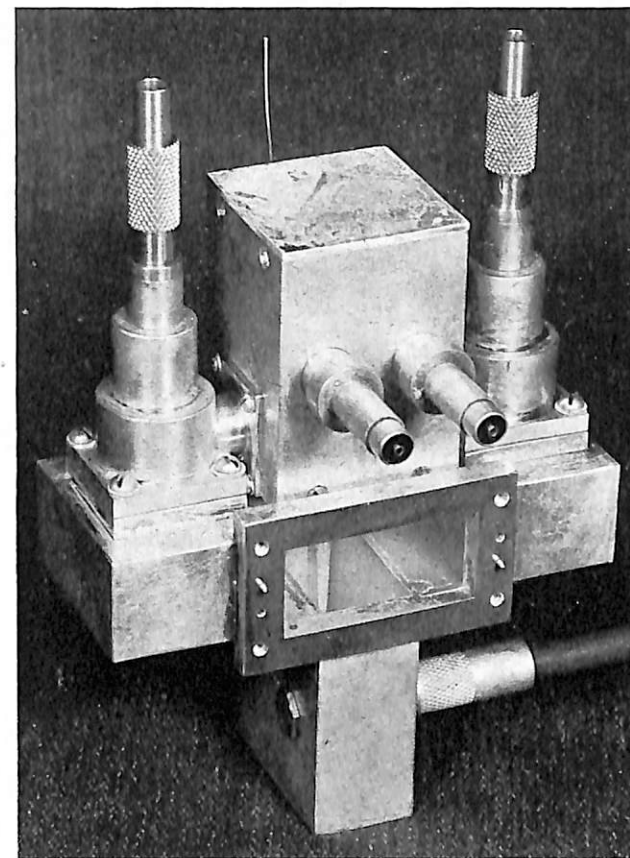

FIGURE 8. A balanced converter used in the microwave repeater system between New York and Boston.

Hybrid junctions have been built from various sizes of guide for use at frequencies in the vicinity of 4,000, 6,000, 9,000, and 24,000 Mc. Constructed with reasonable care, they provide an isolation of 35 to 40 decibels between the arm S and the arm P, and satisfactory impedance matching over frequency bands as wide as twelve percent. If unusual pains are taken to secure a geometrically symmetrical junction, the balance is improved to 50 decibels or more.

The hybrid junction can be used in the same way as its low frequency counterpart, the hybrid coil. The junction has, in addition, many diverse applications in microwave systems and in laboratory measurements, so that it already occupies as important a position in centimeter wave techniques as does the hybrid coil in low frequency practice. New uses are constantly being discovered in which advantage is taken of the balance, power division, and phasing afforded by the junction.

Perhaps the most important use so far found for hybrid junctions is in the balanced converter. Since this was also one of the earliest applications, it has been brought to an advanced stage of development. The general principles underlying the operation of the balanced converter or first detector are shown in the block diagram of Figure 7. Two detectors, in this case point-contact silicon rectifiers, are used as terminations for arm 1 and arm 2 of a hybrid junction. The beating oscillator power is introduced from the arm S, and the signal input from the arm P. With this arrangement, half of the signal power and half of the beat frequency power are developed in each rectifier. The 180-degree phase shift between the signals in arm 1 and arm 2 by the nature of the series connection persists in the intermediate-frequency voltages developed at the two rectifiers. By combining the two intermediate-frequency signals with proper phasing, however, all of the intermediate-frequency power can be made available in a single output.

An important advantage afforded by such a balanced detector is the isolation achieved between the signal line and local beating oscillator. If care is taken to build a truly symmetrical structure and to use rectifiers which are as nearly identical as possible, this uncoupling corresponds to the balance between the arm S and the arm P of the hybrid junction. Another advantage is that the same intermediate-frequency phasing which combines the two intermediate-frequency signals additively causes noise contributions from the beating oscillators to be cancelled. For these and other reasons, the balanced converter is considered the most efficient and desirable microwave detector now available. A specific construction developed by C. F. Edwards is illustrated in Figure 8. This is the converter that is now being used in the microwave repeater system between New York and Boston.



# FLUORESCENT LIGHT INTERFERENCE

## AT A NAVAL AIR STATION

The Bureau of Ships is presently conducting electronic interference surveys at many Naval Shore Communication Stations and Naval Air Stations as an important phase of the Bureau's comprehensive long-range program for the elimination of electronic interference at these activities.

The electronic interference surveys conducted to date have disclosed many new sources of interference, varying in nature from the commonplace to the obscure including many interesting examples. The disclosure of these sources of electronic interference during the course of the surveys and the prompt corrective action taken by cognizant personnel, have resulted in appreciable improvement in the signal-to-noise ratios at the activities concerned.

An interesting example of an obscure source of electronic interference was encountered during the survey recently conducted at the Naval Auxiliary Air Station, Monterey, California, where preliminary measurements made in the area surrounding the control tower and

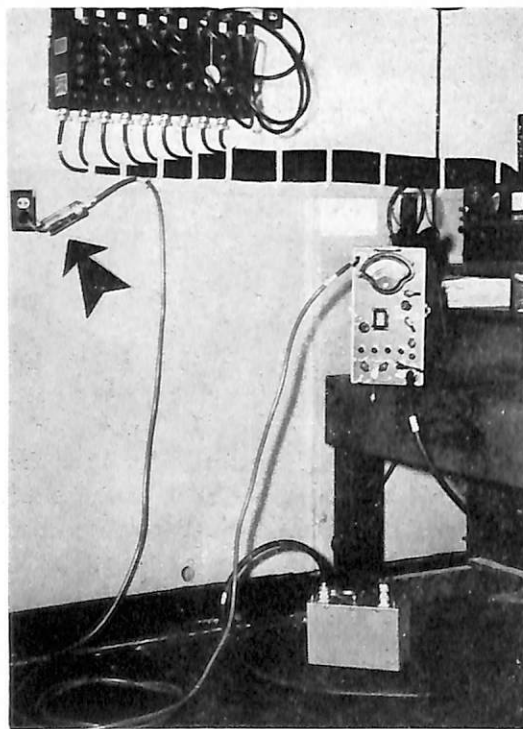

R-F Probe MX-980/PRM-1 (shown by arrow) used with the AN/PRM-1 to measure conducted electronic interference on the a-c power line.

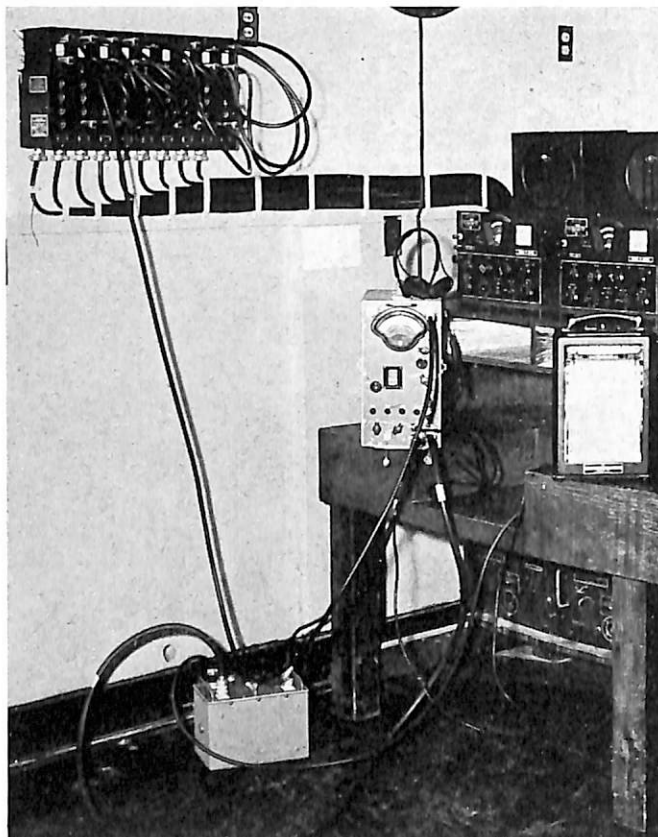

Use of the CU-197/PRM-1 impedance matching network for measuring interference at the antenna input to the receivers.

operations building indicated a high ambient electronic interference level, which was seriously restricting communications between the control tower and aircraft, especially at 3105 and 4995 kc.

A radio interference and field intensity meter AN/PRM-1 (150 kc to 25 Mc) was set up in the receiver room located on the ground floor of the operations building where measurements were made of the conducted electronic interference existing on the a-c power lines at the power input to the receivers. Radio-frequency probe MX-980/PRM-1 was used for this purpose. Figure 1 illustrates the use of this probe. A high

by

WILLIAM A. RITZ

*Electronics Shore Division, Bureau of Ships*

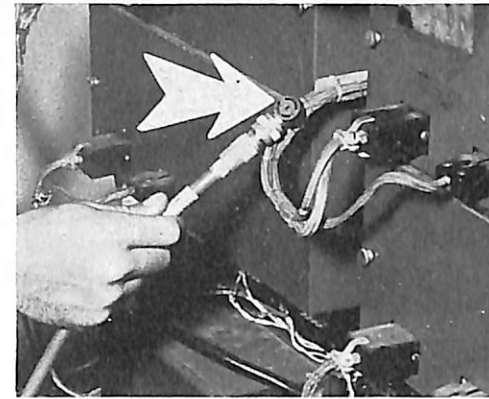

Use of the loop probe AT-211/PRM-1 (shown by arrow) for locating sources of electronic interference.

level of 60/120-cycle pulse type interference was observed during the course of these measurements.

A second set of measurements was then made, using the AN/PRM-1 with an impedance matching network CU-197/PRM-1 terminated at the receiver end of the download from the No. 2 whip antenna serving a receiver operating on 4495 kc. This whip antenna is mounted on the walk located around the outside of the control tower room. Figure 2 illustrates the use of this impedance matching network.

The results of the above measurements and related tests proved conclusively that the greater part of the electronic interference was entering the receivers by way of the antennas rather than conducted through the power lines to the receivers.

An AN/PRM-1 operated in a portable manner by means of self-contained batteries was then employed in an attempt to locate the source of this radiated elec-

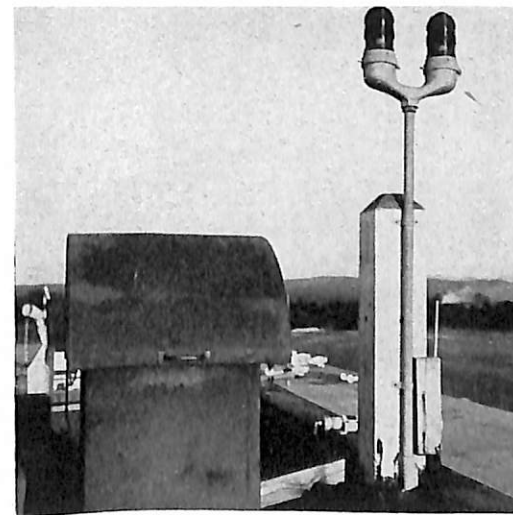

High levels of electronic interference were observed in the vicinity of this ventilator and light post located on top of the control tower in proximity to the whip antennas.

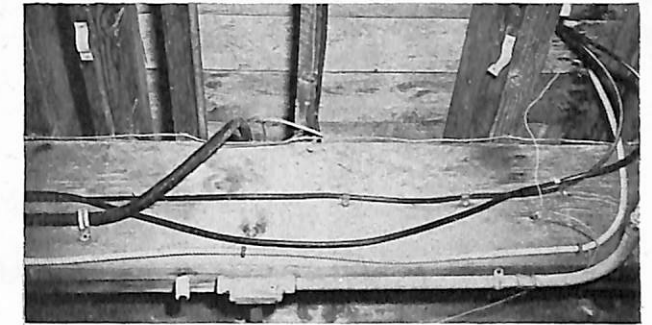

Poorly-run coaxial leads and inadequate grounds located under the deck of the control tower room.

tronic interference. Using loop probe AT-211/PRM-1 in connection with this meter, measurements were first made on the roof of the control tower. Figure 3 illustrates the use of this loop probe at this point. By this method high intensities of electronic interference were measured in the vicinity of the light post and ventilator which are located on the control tower roof. Figure 4 shows this ventilator and light post and the general area. The area directly under the floor of the control tower was then similarly measured, and high interference levels were observed at this location but no well-defined focal point could be ascertained at that time. Figures 5 and 6 illustrate typical conditions in this area. The major portion of the interference picked up by the antenna was easily identified as the type created by fluorescent lights, and an investigation disclosed the source to be the fluorescent lights which are located in the aerology instrument room and in the office of United Air Lines. However, the method whereby this interference was coupled to the antennas from these fluorescent lights presented a

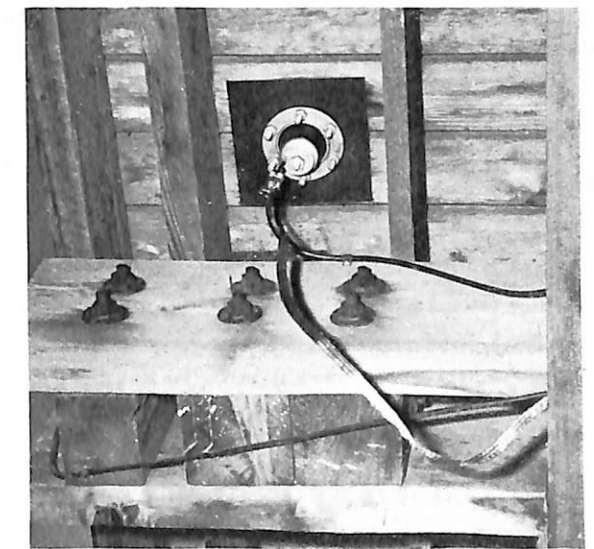

Area under control tower floor showing inadequate ground strap on shield of antenna lead-in to the 3105-kc receiver. This whip antenna is mounted on the northeast corner of the control tower.



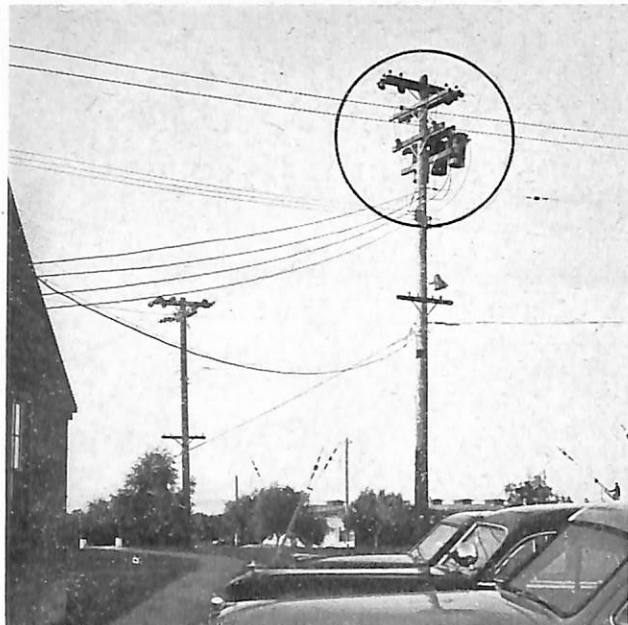

The transformers (circled), mounted on the pole, which were suspected of radiating the fluorescent light interference to the whip antennas until the true source was disclosed.

problem, as direct radiation from the fluorescent lights to the antennas was impossible, due to the distance between the lights and the whip antennas mounted on the control tower walk. Obviously the interference was being conducted from the fluorescent lights over the power line wiring and was then radiated to the control tower antennas from some obscure point. The electronic interference at first appeared to be radiating from a transmission pole on which the power transformer supplying power to the control tower and associated operations building were mounted, due to the close proximity of this pole to the antennas. Figures 7 and 8 show this transformer pole and the control tower.

By carrying the AN/PRM-1 and walking directly beneath the overhead power lines, standing waves along these power lines were observed. Comparison of the maxima of these standing waves soon established the source of the interference to be emanating from a point in the vicinity of the control tower, illustrated by Figure 9. Standing waves were also observed through the 115-volt power lighting circuits of the control tower and operations building, and at all times the observed electronic interference peaked at 2.8 Mc. Carrying the AN/PRM-1 and walking past a water drainage downspout leading from the roof of the operations building, very high interference levels were observed on the meter. Visual inspection revealed that a light circuit of the knob-and-tube type was installed along the inner side of a wall adjacent to this downspout and also in the ceiling of the rooms which were at a level with a metal flashing around the outer edge of the roof of this building.

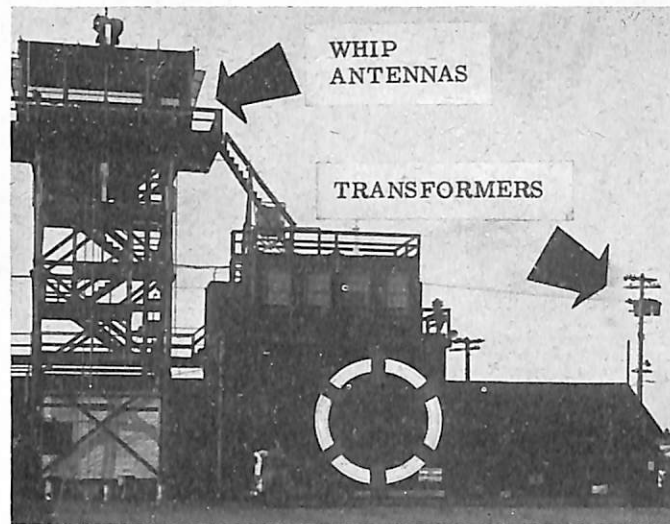

Control tower, operations building and United Air Lines offices (resonant area circled).

Figure 10 illustrates this type of wiring which supplies power to a number of fluorescent lights located in aerology etc. Figure 11 illustrates this type of light, which when turned on and off produced corresponding increases and decreases in the radiated interference levels existing in the vicinity of the downspout. Previous tests had not indicated these fluorescent lights to be

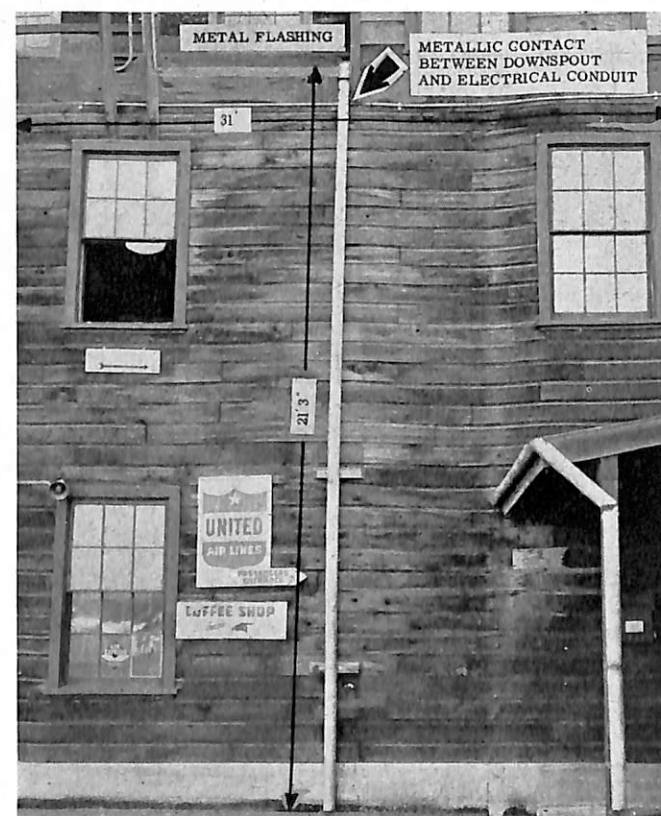

View of the gutterspout on side of tower building.

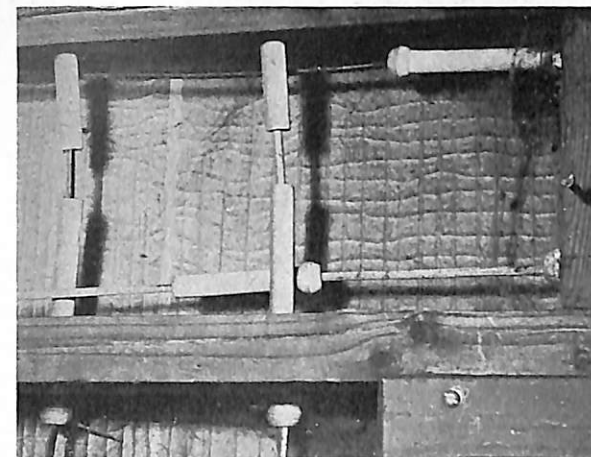

Knob-and-tube type open wiring supplying power to the fluorescent light fixtures in the operations building.

creating abnormal high levels of radiated interference. Continuing the search for the coupling medium, measurements were then made of the various combinations that would indicate possible resonance at 2.8 Mc. Investigation disclosed that a length of metal flashing and downspout plus a length of outside electrical conduit resulted in a length approximately  $\frac{1}{2}$  wave length at 2.8 Mc. The open wiring of the knob and tube variety used in the commercial air lines and operations office building located below and adjacent to the control tower was found to act as a transmission line, which due to close proximity to the gutter and downspout assembly provided a means of inductive coupling for the electronic interference.

The electronic interference signals were then radiated from the gutter and downspout assembly with a high degree of efficiency at the resonant frequency of 2.8 Mc. This radiated electronic interference was then picked up by the whip antennas which are mounted on the walk

## CHECK ON WAVEGUIDE EXCELLENCE

Recently a field engineer of the Western Electric Co. reported a very handy way to check on whether or not the waveguide system was fouled. Very frequently this is the last part of a system to be checked for trouble since it isn't the most common source of difficulty.

The check consists of comparing the frequency of the transmitter on DUMMY and on ANTENNA. Waveguide trouble sets up standing waves and pulls the magnetron frequency. If this frequency pulling is greater than 3 or 4 divisions on the TS-33/AP, trouble can reasonably be suspected in the waveguide.—*Western Electric Co. Newsletter.*

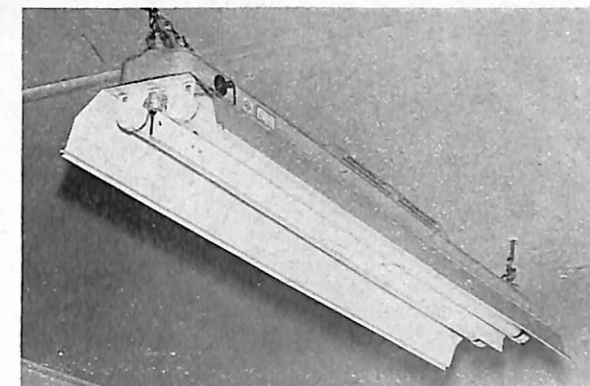

The type of fluorescent light which created the electronic interference.

around the outer walls of the control tower. While electronic interference produced by fluorescent lights is usually highest in amplitude at the low frequencies, the gutter and downspout assembly, comprising a resonant circuit at 2.8 Mc, distorted the normal electronic interference amplitude curve with respect to frequency, producing highest amplitudes of electronic interference at 2.8 to 3.5 Mc, accounting for the high level of the electronic interference affecting the control tower receivers when these receivers were tuned to 3105 and 4495 kc. Station personnel found it impracticable to install a ground to the lower end of the downspout, illustrated by Figure 9. A jumper was installed between two electrical conduits, one of which was attached to the metal gutter flashing, thereby breaking up the resonant circuit. With this corrective action taken, the electronic interference produced by the fluorescent lights then dropped to a low level of 2 microvolts as compared to the previous level of approximately 30 microvolts, thereby resulting in an appreciable improvement in control tower reception.

## MODELS TEJ, TEK AND TEL NOMENCLATURE CHANGE

Nomenclature of the Models TEJ, TEK, and TEL transmitters has been changed to conform to Army-Navy nomenclature as follows:

Old	New
Model TEJ	AN/URT-4
Model TEK	AN/URT-2
Model TEL	AN/URT-3

All future reference to this equipment should use the new nomenclature.



## MODEL OAA—F.C. NO. 2— REPLACEMENT OF CHOKE COIL

The Bureau of Ships has procured 1000 field change kits for Model OAA Radar Test Equipment (echo box) under Contract NObsr—42482. Field Change No. 2—OAA is necessary to correct the frequency sensitivity of the echo box with respect to both ring time and relative transmitter power meter indications. The change is relatively simple and it is regarded as within the capacity of ships force. It consists primarily of the replacement of a choke coil and the addition of a capacitor. Ships with SA, SC, SK Series and SR and SRa radars aboard should accomplish this change on their Model OAA's as soon as possible. They may be obtained through the usual channels.

## MODELS VL AND X-VL— F.C. NO. 1—PROVISION OF MOISTURE PROOFING

Field Change Kit Number 1—VL will be available within the next three months at Naval stocking activities for the following equipments:

X-VL Serials 1 and 2, Contract NObsr—30196

VL Serials 1–20, Contract NObsr—39429

The purpose of this field change is to provide complete moisture-proofing of the unit top.

Time required is one man-hour. No special tools are needed.

All requests for these kits shall be forwarded directly to the Bureau of Ships. Requests shall include serial and contract numbers of the Model VL repeater for which required.

## MODELS TCK-4/-6 POWER SUPPLY CONNECTIONS

Faulty operation of a Model TCK-4 transmitter rectifier power supply utilizing Type 836 tubes has been reported. The report also stated that the difficulty was overcome by using Type 866A/866 tubes.

The use of either Type 836 or Type 866A/866 tubes in the rectifier power supply is permissible providing the transformer connections are proper for the respective types. The connections must be changed if tubes of one type are replaced with tubes of another type. The proper connections for the use of Type 836 tubes are shown in Figure 7–21, Rectifier Unit Schematic Diagram, of the instruction book, NavShips 900,210. A note on the schematic diagram lists the changes required when operating with Type 866A/866 tubes.

## MODEL NMC FILTER JUNCTION BOX (W.T.)

Recently a beneficial suggestion was submitted by Mr. Dan A. Almanzar, Electrician in Shop 67 at Long Beach Naval Shipyard, as a modification of the sonar filter junction box affecting Field Change No. 7—NMC. This suggestion concerns the method of lay out and mounting of the capacitors, terminal board and mounting plate.

The suggested method is intended to reduce the man-hours required, to simplify installation and improve the watertight integrity of the filter junction boxes.

The Bureau approves this method and recommends using the watertight box show on BuShips drawing RE 53F-2000A in lieu of the one shown on BuShips specifications 9-S-5341-L-Alt.5, Figures 26–16 and 26–17, Section 26 of the Sonar Bulletin. These W.T. box assemblies will contain a lightning arrester on a mounting plate which is to be removed and a new mounting plate cut from sheet steel. Mounting brackets are provided that should reduce the time of fabrication and assembly.

## MODEL TBL-5/-6/-7/-12/-13 I.B. CORRECTION

Figures 10–43 and 10–47, schematic diagrams of the Model TBL-13 transmitter, in the instruction book for Models TBL-5/-6/-7/-12/-13 transmitters, NavShips 900,381, are in error and should be corrected to be in conformance with the respective equipment. On both schematics, the numerals 19 and 23, identifying terminals on the +2000-volt lead and ground, should be reversed. The terminal for the +2000-volt lead should be marked "19" and the ground lead should be marked "23." In addition, a connection should be shown from Terminal 23 to ground on the schematic in Figure 10–47.

## CABINET CY-597/G DEFECTIVE SWITCH PANEL WIRING

The Bureau of Ships has received a report that Switch Panels SA-134/G in Cabinets CY-597/G have been found incorrectly wired. The wiring defect has the power line (source) running to the shell contact of fuses F-1601 and F-1602 instead of the center contact, which introduces a shock hazard when installing fuses.

All installed Cabinets CY-597/G should be checked for this defect which if found, may be corrected by interchanging the two wires leading to each fuse.

## FAILURE OF NOISE GENERATOR SG-23/U IN TEST TOOL SET AN/USM-3

The Bureau of Ships has received some reports of defective noise generators in Test-Tool Set AN/USM-3. These units should be checked immediately upon arrival with a fresh battery. If inoperative and incapable of being adjusted as described in Paragraph 3 of Section 5 of NavShips 91146 (Instruction Book for Test-Tool Set AN/USM-3), the defective noise generator should be shipped to the Radio Frequency Laboratories Inc., care of Inspector of Naval Material, Newark, New Jersey, together with a duplicate copy of the NavShips-383 failure report. This action should be recorded on the Bureau of Ships copy of the NavShips-383 failure report. Information copies of any correspondence forwarding these units to the Inspector should be sent to the Bureau of Ships, Code 983E.

A similar procedure should be followed for any of the other probe type units in the test-tool set which are defective upon arrival.

Replacement units should be ordered in the usual manner since contractual replacements will be made into the supply system rather than to individual activities.

## FAILURE OF IN23B CRYSTALS IN MARK 13

Attention has been invited to the necessity for checking for both continuity and presence of voltages on the keep-alive circuit of the D-151693 Transmitter-Receiver Unit. It is pointed out that resistance measurements are not sufficient for "the usual ohmmeter will not distinguish between the approximately 10 megohms specified for this circuit and an actual open circuit." Instances have occurred where high failure rates for 1N23B crystals have prevailed and the absence of keep-alive voltage was not detected until actual voltage measurements were taken. Voltage measurements from Terminal 8 to ground of the transmitter switching unit should indicate approximately —800 volts when these readings are taken with a high resistance voltmeter such as the Volt-Ohmyst. Correspondingly lower readings will result when meters with lower resistance values are used. At present an effort is being made to obtain readings using a Model 260 Simpson Meter and these will be passed on to the field as soon as they are available.—*Western Electric Newsletter.*

## U-H-F PERFORMANCE

"What is considered acceptable performance for u-h-f equipment"?

This question was raised one day when someone in the Bureau of Ships paused long enough to consider all the tests and other checks requested of the fleet—to mention a few, radiation patterns, receiver sensitivity, transmission line losses, antenna location, field changes accomplished, hours of operation, hours lost and maximum range. While providing the Bureau with much data for making summaries and frequently advising the ship to take corrective measures, maximum communicating distance on all azimuth bearings is not known.

Another question is, "From these reports is it possible to determine in every case whether shipboard u-h-f communications are meeting the "line of sight" requirement (established by CNO) under all conditions?" The answer must be "no." The present u-h-f communication equipment, although approved for service use does not meet this requirement in every instance.

There is always a question as to what range is expected to satisfy requirements. Naturally, it is different for each type of ship. Based on fleet and OpDevFor reports, the following ranges are considered acceptable, and are concurred in by C.N.O.:

Eight miles between vessels of the small landing craft and patrol craft classes.

Twelve miles between vessels of the large landing craft and small auxiliary classes.

Fifteen miles between vessels of the large auxiliary and medium-size combatant classes.

Eighteen miles between large combatant class vessels.

## MODELS VK AND X-VK— F.C. NO. 4—PROVISION OF MOISTURE PROOFING

Field Change Kit Number 4—VK will be available within the next three months at Naval Stocking activities for the following equipments:

X-VK Serials 1–6, Contract NXsr—97654

VK Serials 1–150, Contract NObsr—30148

VK Serials 156–214, Contract NObsr—42474

The purpose of this field change is to provide complete moisture-proofing of the unit top.

Time required is two man-hours. No special tools are needed.

All requests for these kits shall be forwarded directly to the Bureau of Ships. Request shall include serial and contract numbers of the Model VK repeater for which required.





of

# MOTORS and GENERATORS

In dealing with electrical machinery, as with all electrical equipment, the instructions and safety precautions must be carried out at all times. A few of the more important machinery safety precautions are outlined below:

1—The interior and exterior of machines, panels and control boxes must be kept free from dust, dirt, water, salt, lint and oil at all times.

2—A small bellows or compressed, dry air may be used in cleaning interior parts. When brushes are used they must be entirely non-metallic.

3—Emery cloth or paper shall never be used on electrical equipment.

4—Protective devices for machinery, such as circuit breakers, fuses, and interlocks must be kept in working order and operating with their designed settings or ratings at all times.

5—Fuse box, junction box and panel covers must be kept on and properly secured at all times. Lever type boxes shall be kept closed. Box gaskets will be kept in good condition and free from paint.

6—When machines run at excessive temperatures or when there is sparking, the machines must be shut down and the defects causing improper operation corrected. Failure to do so will damage or destroy the machines.

7—Great care must be taken in working on brush rigging of running machines or the commutator may be seriously damaged.

8—After an overhaul, electrical machinery shall not be started until a careful inspection has been made for loose bolts, tools, broken insulators, metallic dust or chips, improper clearances and loose connections. The lubrication must be checked, machine speed, output, current and other readings should be taken, and compared

with the normal readings in the instruction book and recorded.

## Armature Troubles

The three types of troubles encountered in armatures are mechanical defects, short circuits and open circuits. Troubles to be expected in each category follow:

### Mechanical Defects

- 1—Journals worn, scored, or out of round.
- 2—Commutators scored, pitted, worn out of round, or worn unevenly; exposed mica segments.
- 3—Windings loosened up or thrown out, binding wires broken or stretched. Careful inspections and measurements will reveal any of these defects.

### Short Circuits

- 1—In individual coils (most common fault).
- 2—Between adjacent coils.
- 3—To frame or core.
- 4—Between armature sections.
- 5—Partial shorts of any of above types.
- 6—Short circuits usually make their presence known by violent armature heating, accompanied by the smell of overheated or burning insulation. There is usually a flickering of any lights in the circuit and sparking at the commutator.

When such symptoms are observed the machine should be stopped at once to avoid complete destruction of the armature. In addition to the short circuits mentioned above, occasionally metallic dust or chips lodged in the commutator insulating segments cause similar symptoms.

After the machine has been stopped, the faulty coil can frequently be located by its excessive temperature or by the baked, changed color appearance of the insulation or varnish.

7—Open Circuits: Partial or complete breaks in an armature circuit are ordinarily not accompanied by excessive heating. There will be heavy sparking at the commutator, the circuit at fault being indicated by a brush. If the circuits are badly broken up there may be a ring of fire around the commutator due to the spark holding between bars.

When no break can be found, passing a fairly heavy current through the armature will either definitely open the break or indicate its location by local heating.

In an emergency when no spare armature is available, it is sometimes feasible to disconnect the broken coil from its commutator segments and insulate the loose ends. The disconnected segments should then be bridged with a well-soldered strip of copper that will carry the armature current. Such a repaired armature should be replaced at the earliest opportunity.

8—Grounded Armature: An armature can be checked for grounds by using a megger to read the resistance from the armature coils (commutator bars) to the shaft as ground. A normal armature should show a megohm or more resistance to ground on this test.

9—Field Coil Troubles: A grounded field coil may be detected by taking megger readings of the resistance to ground, connecting one lead to the frame and one to a lead of the field coil under test, the brushes must be removed or lifted clear of the commutator for this test.

### Open Circuits

1—An open field coil may be detected by connecting an ohmmeter across the field input. If the whole field is found to be open, test each individual field coil for continuity.

2—A shorted field coil is usually more difficult to locate than an open coil. The slight heating of a shorted coil is a fair indication. A low range ohmmeter can be used to read the resistance of each field coil. The shorted coil will be indicated by the lowest reading.

3—A partially opened field coil can be detected by the method used for shorted coils, except that the defective coil will show an increased reading of resistance.

### Defective Insulation

It will sometimes happen that a machine will show very poor insulation resistance. In such a case the armature or field coils should be dried out by being baked in an oven. When no drying oven is available, it is sometimes feasible to dry an armature or coil by passing d.c. through it to heat it slightly. Care must be taken to keep the current low to avoid overheating and damage to the insulation.

### Brushes

The brushes are an important link in the electrical circuit since they must form the connection to the armature by way of the commutator. If the brushes fit poorly or the brush pressure is too low, the contact resistance may be very high. If the brush pressure is too high, excessive brush wear and grooving of commutator will result. Where the instruction book does not specify brush pressure, the brush spring tension should be adjusted so that:

Brush pressure in pounds =  $1.5 \times$  (brush area in sq. ins.)

When the brush pressure is too high, there will be

sparking, excessive commutator wear, grooving, brush wear and brush crumbling. When the brush pressure is too low there will be sparking, unsteady voltages, selective commutation, and unbalance in the armature circuits. When renewing brushes the commutator should be clean and free from grooves. If grooves have been cut, the commutator should be turned down before new brushes are fitted. The new brushes are fitted into the holders and then lifted sufficiently to allow a sheet of coarse sandpaper to be slipped under the brush with the sanded side toward the brush. The sandpaper should then be drawn under the brush taking care to pull it only in the direction of rotation of the commutator.

The brush must be raised in its holder while the sandpaper is being returned to the starting point to avoid cutting the brushes in the wrong direction. The ends of the sandpaper must be kept as close to the commutator as possible to avoid rounding the brush edges.

After the brush has been shaped to fit the commutator approximately, fine sandpaper should be used to get the final smooth fit, using the same process as is described above. After fitting of all brushes is completed, the dust and sand must be cleaned off carefully and the brush pressure checked.

The normal commutator acquires a hard, smooth finish having a medium chocolate-brown color, and should not be cleaned when it appears normal. It should never be lubricated with anything.

If a coating of smut and black carbon deposit appears on the commutator, it may be removed with carbon tetrachloride and a rag. If the commutator is very dirty, especially when slightly pitted, it may be cleaned with the finest sandpaper. After cleaning, the commutator must be carefully wiped off.

### Loss of Residual Magnetism

Sometimes, when a generator is started, it will fail to build up and deliver any output voltage. This failure is usually due to loss of residual magnetism in the magnetic field. It is caused by an accidental connection of the field with reversed polarity. The magnetism may be restored by applying a DC current to the field terminals for a few seconds. The brushes are lifted clear of the armature to prevent a short circuit through it, the direct current is then applied to energize the field and remagnetize the poles. Care must be taken to insure connecting the direct current with the correct polarity. If no DC line voltage is available, a storage battery may be used. After the field has been energized, the external voltage is disconnected, the brushes reset, and the machine started.

### Operating Temperatures

A great deal of electrical machinery is designed to operate at relatively high temperatures, much equipment being perfectly safe at 176 degrees Fahrenheit or more.

by  
LT. W. E. JONES  
Staff ComServLant, Norfolk, Va.



The hand is a very poor thermometer and should not be relied on except as a general indicator. A metal temperature of 120 degrees Fahrenheit is very uncomfortable to the touch. When a thermometer is mounted on the outside of a machine, a correction of 15 degrees Centigrade or 27 degrees Fahrenheit should be added to the reading to compensate for the inability to read the true temperature within the machine itself. The equipment instructions or the nameplate usually show either the maximum safe operating temperature or the temperature rise of the machine when operating with full load.

### Lubrication

Most motor-generator sets and other small pieces of electrical equipment need lubrication at from 3 to 12 month periods, depending on the use given the machine and the manufacturer's instructions. Electrical equipment is very frequently overlubricated so that the overflowing oil or grease damages the insulation. The equipment must be kept clean, and examined frequently for proper lubrication. The proper kind of lubricant specified by the instructions should always be used. If dirt and abrasive material get into the bearings, they must

## POINTERS ON LORAN

In recent months there have been many calls to the Electronic Service Group of ComServLant for repair of Model DAS series loran equipments. A list of troubles that occur frequently are listed below for the information and guidance of technicians in servicing this equipment:

*Jittery "B" trace*—This is caused by the grid resistor R-162 in the B1 delay, changing in value. This 2.2-megohm resistor will change to as high as 7 megohms. When this resistance increases, the grid voltage on the second half of the multivibrator increases, changing the delay and giving faster sweeps. In rare cases, it will be found that the coupling capacitor, C-161, will be causing the same trouble. Also it should be remembered that the regulated +265 volts must be set correctly as it can also cause jitters if improperly adjusted.

*Third counter cannot be adjusted*—This is caused by capacitors C-123 or C-125 in V-108 circuit changing value. This can be observed by taking waveforms at pin 8 of the tube. Figure 7-22 in the instruction book portrays the waveforms that should be observed on the oscilloscope.

*No gain through the receiver on one band*—This is usually caused by an open antenna coil. A rough check is to rotate the band switch of the receiver from one through four, with the gain control on the indicator unit set at a value which will give an inch or two of grass in any of the different positions. In making an ohm-meter check of the coil, a good meter should be used because of the very low resistance of the primary section.

be carefully cleaned out. If practicable, it is best to disassemble the bearing and wash off the dirty lubricant with kerosene or light oil, wiping carefully with clean rags before replacing parts. When renewing lubricant, it is desirable to flush out the bearings with oil or grease. When a drain plug is fitted, clean grease should be forced through until it appears at the outlet. The surplus should be removed and the plugs replaced. In an emergency, cake oil or grease can be flushed out with warm (not hot) kerosene. This procedure is not as desirable as taking down the bearing and cleaning it. A good general rule is to see that every bearing surface is lubricated with the right amount of the proper lubricant at all times.

### Hot Bearings

When a bearing is overheated, it must be cooled before the machine is stopped, except in an emergency, or the bearing and the journal will "freeze" together. Slowing down the machine, forcing in new lubricant, or pouring light oil over the bearing may help to cool it off. It is dangerous to pour water on overheated metal because cracking may result.—*ServLant Monthly Bulletin*.

When replacing the antenna coil (L-301, L-302, L-303 and L-304) care should be taken to tag the leads as they are removed to insure proper connections when installing the new coil. When the new coil has been installed, the four bands will have to be aligned by the use of a signal generator. The screwdriver adjustments on the top of the can vary the frequency at which the coil will peak up. An LM frequency meter can be attached to the input of the receiver and the four bands adjusted for maximum height of waveform on the indicator scope for the different frequencies of the coil. Band one is 1950 kc, band two is 1850 kc, band three is 1900 kc and band four is 1750 kc. The opening or shorting of the antenna coil is usually caused by having the transmitting antennas located too close to the loran receiving antenna, thereby inducing too much voltage across the coil. One method of preventing this would be to keep the coaxial cable at the rear of the receiver disconnected except when actually taking a fix, also trying to keep transmitters shut down during the short period of time necessary to take the fix.

Approximately fifty percent of the calls are on equipments that need nothing more than a complete alignment. There is no reason for a technician to need help in this case, since the instruction book and other technical pamphlets cover the alignment procedure. It should be pointed out that some of the adjustments are inside the equipment and not merely on the front panel.—*ServLant Monthly Bulletin*.

# USN USL notes

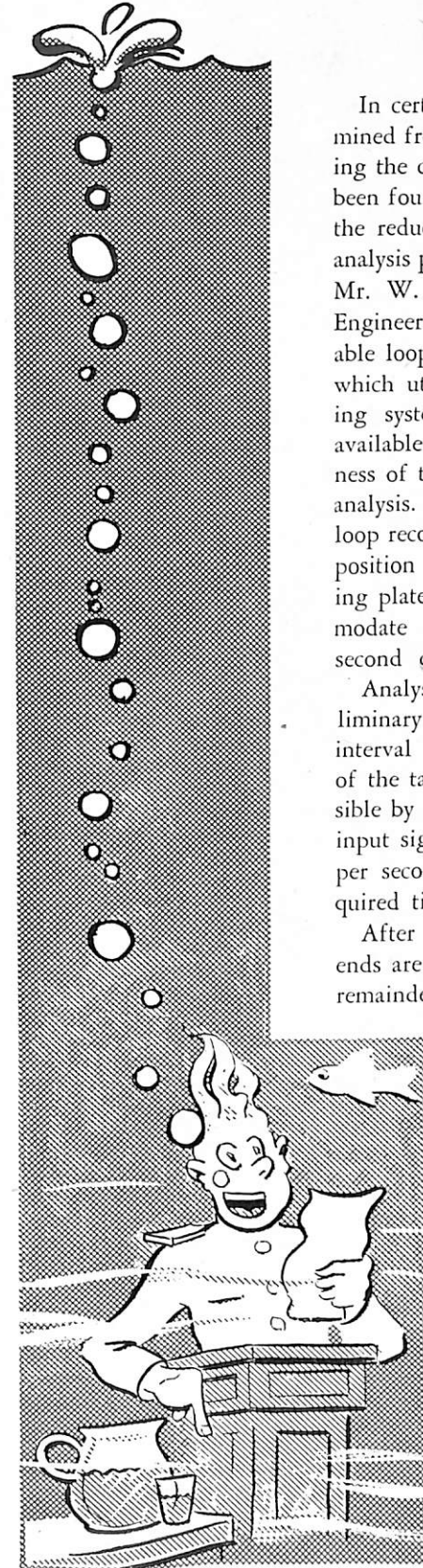

## VARIABLE LOOP MAGNETIC TAPE RECORDER-REPRODUCER

In certain underwater sound propagation studies, spectrum characteristics are determined from magnetic tape recordings made at sea or dubbed from disc recordings. During the course of making quantitative analyses in connection with such studies, it has been found that conventional sampling methods are cumbersome and complex and that the reduction data is a tedious process. In an effort to simplify some phases of the analysis process, Mr. W. F. Saars, Head of the Recording Group at the Laboratory, and Mr. W. G. Lohmeyer, of the Mechanical Engineering Group, have designed a variable loop magnetic tape recorder-reproducer which utilizes a Magnecorder PT-6 recording system. Although similar devices are available commercially, they lack the preciseness of timing which is essential to accurate analysis. The novel aspect of the variable loop recorder-reproducer lies in the multiple-position tape pulley and its precision mounting plate which allows the device to accommodate recorded samples of one- to two-second duration in 0.1-second increments.

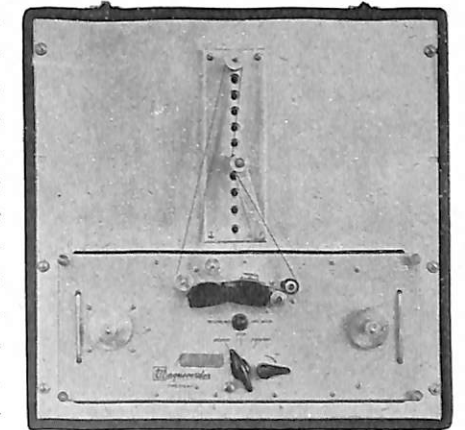

Analysis of a recording begins with a preliminary editing of the tape to determine the interval sampling rate. The first sample is then selected by cutting a linear section of the tape corresponding to the desired time duration. This procedure is made possible by the inclusion of a time reference cue, such as the momentary blanking of the input signal, near the start of each recording; since tape speeds of 7.5 or 15 inches per second are normally used for recording the proper length of tape for the required time interval is easily measured.

After the tape sample has been cut with scissors of non-magnetic material, the ends are butted and spliced, and the loop is threaded onto the sampling device. The remainder of the tape is not removed from the pay-out and take-up reels, although the take-up reel must be slipped from the drive spindle in order to prevent it from rotating with the tape drive capstan.

The loop may then be reproduced continuously until the sampling requirement has been fulfilled. When the analysis of the sample has been completed, it is spliced back into the main tape and the next sample indicated by editing of the tape is selected.

While the variable loop unit is intended primarily for sampling phenomena of relatively long time duration in the fields of underwater sound and acoustics and for transient energy studies in the audible spectrum, various other applications are possible. With this device, time marks may be introduced into records, commands may be repeated at stated intervals, or short messages may be recorded for subsequent repetitive reproduction. The analysis of speech imperfections may also be facilitated through the use of the unit.

The chief advantage of the variable loop unit over comparable devices lies in the precision with which samples may be taken. Since it is only 19 inches square including the Magnecorder system, it is compact and portable.



## MARK 12 MOD 2

### Results of Poor Maintenance

The Bureau recently received a report from a field engineer listing troubles found on the Mark 12/2 radar installed in an active fleet unit. These troubles are listed in the following paragraphs with the engineers comments on remedial measures necessary to correct same. The engineer concluded this report with—"This particular equipment had been under the care of the assigned technician for only two weeks or so. His predecessor had not given the equipment the care and attention (preventive maintenance) it required, and many of the troubles listed had been of long standing. It was the ship's desire to have the equipment placed in proper operating condition, and it was the technician's desire to understand the equipment, which was the first fire control equipment he had had the opportunity to work on. The service call began with a "school" session, in which the system design, layout, and theory of operation were discussed in considerable detail. Maintenance procedures and their purpose were then discussed as each unit in turn was inspected for trouble conditions and those found were corrected." After reading the multitude of troubles found by this engineer on one radar equipment, it is believed that technicians and Electronics Officers will have a deeper appreciation of the importance of a carefully planned and well executed preventive maintenance program on all the electronic equipment for which they are responsible.

1—Range unit failed to follow rotation of the handwheel in range control unit. This difficulty was found to be caused by a shorted secondary winding from center tap to terminal 5 of T2, the output transformer for the AID circuit in the range correction unit. The short was apparently caused by overheating, probably due to a gassy or shorted 6L6 tube at V-22. Voltage output from T2 was insufficient to drive the AID motor in the range unit. Replaced T2 from ship's spares.

2—Automatic range following circuit did not function. The trouble was found to be similar to that in the AID circuit. Winding 4-5 of T1 was shorted and the can was swollen. Probably caused by a shorted or gassy 6L6 in V-13. Since only one KS-8491 transformer was supplied in a set of spares (list A) a replacement transformer was borrowed from spares of another vessel, operating in the area.

3—Sound of spark from modulator unit abnormal. False target appears intermittently at random locations along the range sweep. The rotary spark gap found to be in poor condition, and the spark wheel contained both molybdenum and stainless steel pins, upsetting the dynamic balance. The hub disc against which the grounding brush bears was worn in the contact area, and showed two deeply etched areas where the brush prob-



ably rested at some time when the equipment was turned on with the spark motor inoperative. The stationary electrode was rotated to bring an unpitted surface into action. The wheel pins were rotated as required and the steel pins were removed and replaced by new molybdenum pins. The hub disc was replaced from ship's spares and the gap spacing was adjusted to 0.022". After these repairs were made the spark sound returned to normal and the false target disappeared from the trace.

4—Regulated rectifier developed trouble during testing. Evidenced by random variation of sweep lengths, followed by disappearance of sweeps from all indicators. Voltage found to have fallen to 150. Replaced V(16)1, rectifier tube Type 393A, which showed only a very faint blue glow and which had a badly tilted plate structure. Voltage normal but regulation poor after changing this tube. Replaced the control amplifier tubes, V3 and V6 (6L6's), and regulation returned to normal.

5—Electrical limit switches on range unit slewing mechanism, Unit 5A, improperly set. Slewing motor drove range unit into its mechanical stops at the high range end, and was disabled at 6000 yards when going toward zero range. Switch cams were reset for operation at 57,000 yards and 100 yards, respectively.

6—Switching to AGC at the operators control unit resulted in a total loss of targets and grass. Trouble found in adjustments of MAX I-F GAIN and I-F AGC LEVEL potentiometers in receiver circuit unit. After correctly readjusting these components, normal operation was obtained from the AGC circuit.

7—Spot disabling circuit was found inoperative. Examination disclosed a faulty 6SN7 in V(10)11 in the receiver circuit unit. Replacement of this tube restored operation. Adjusted for sensitive operation on range calibration signal, then readjusted for insensitivity to noise.

8—All indicators were found to be improperly adjusted with reference to spot and sweep centering. These were properly adjusted but a frozen FOCUS potentiometer was found in the control officers indicator, and a defective selector switch was located in the pointer's indicator. This ship's spare indicator was also found to be inoperative in that no sweeps could be made to appear on the screen although proper voltages were avail-

able to the control officer's position. Parts were taken from the spare indicator to correct the difficulties in the two indicators noted and the spare indicator was then rebuilt from the ship's spares.

9—After work was accomplished on the indicators, it was noted that when the range sweep was properly centered on all scopes, switching to TRAIN or ELEV indication caused a two-inch displacement of the sweep trace to the right. This trouble indication pointed to some undesired load on the d-c component of the image shift voltage supply, resulting in lowered potential on the left deflection plate of all scopes when switched to TRAIN or ELEV. The source of this current drain was found to be located in the trainer's indicator, where a partial ground existed on the image spacing voltage lead. Removal of this ground corrected the trouble and restored normal operation.

10—Indicating lamps on train and elevation meters would not light when spot enabling circuit operated. It was determined that the 6.3-volt a-c supply to these lamps was leaving the receiver circuit unit when the spot disabling relay was released, as is normal, but that the voltage was not present at the train and elevation meters. Available time did not permit checking the ship's wiring to find the error, but the method to be used was discussed with the technician, who will correct this trouble at his first opportunity.

11—During adjustments the range unit developed a failure of the precision pip circuit, evidenced by the impossibility of getting the notch down to zero on the scopes even though the range unit was at a below-zero setting. The trouble was isolated in stage V(5)2 by standard signal tracing methods, and proved to be a 500-ohm short to ground in C6B, a cathode bypass capacitor in the 82-kc precision oscillator circuit. Capacitor C6 was replaced from ship's spares and circuit operation restored to normal.

12—Again the notch failed to follow rotation of the handwheel in the range control unit, although the AID motor was rotating as intended. The difficulty was found by observation of the range unit gear train while the AID motor was energized and rotating. Slipping was observed in the differential which combines the outputs of the AID and AUTO motors, applied to one sun disc, with the local handwheel rotation which is applied to the other sun disc. This differential operates by friction drive instead of employing geared teeth. An accumulation of oil and grease on the friction surfaces, combined with small amounts of dirt in the teeth of the following gears and an apparent lessening of pressure exerted by the differential loading springs, was enough to permit the sun discs to slip against the planetary discs without causing them to rotate. The technician was advised to clean the differential discs and the gear teeth, and to relubricate with care. A method of increasing

the spring tension, if needed, was also discussed.

13—On the final checkout and test of boresighting accuracy, it was observed that the sense of the indications for TRAIN was reversed on the range operator's indicator, the trainer's indicator, and the train meter. The pointer's indicator and control officer's indicator displayed the proper direction of spot movement for TRAIN, however. All indicators and the elevation meter were correct in elevation. The circuit was analyzed in conference with the technician, and it was agreed that two separate wiring errors must exist and must be separately corrected. A plan was made for the correction of sense reversal, involving the following two operations:

- a—Interchange wires at terminals 1 and 2 of the indicator power unit. This will result in reversal of train sense indication only, but will affect all indicators alike, as well as the wandering spot and train meter voltage output of the indicator circuit unit.
- b—In the CW-62097 junction box in the director, on terminals 7 and 8, interchange the R-L deflection leads in cables 223 and 233, to the pointer's indicator station and the control officer's station, respectively. This will have the effect of correcting the spot sense in train on the two indicators mentioned, which will have been previously reversed by operation (a).

Upon completion of these operations by the technician, the spot and train meter sense reversal condition will be corrected.

14—The equipment showed need of correcting certain adjustments. The installation adjustment procedure was referred to, and all system adjustments were trimmed for optimum performance and accuracy except the double-echo zero-set for the range unit. This operation was described in detail and left to the ship's force to perform while at sea where the requisite conditions could be properly set up.

## MODEL TDZ/RDZ FEEDBACK

A field engineer operating out of the Naval Station, Key West reports the following conditions and remedy encountered on board a ship in that area:

When handsets were inserted in both remote units of the TDZ/RDZ installation on board the subject vessel, feedback was very objectionable. An investigation revealed that at some time previous both the handsets had been rewired in such a manner that the "push-to-talk" switch was in the keying line (contact E) rather than in the common line (contact D). The result was that when the transmitter was keyed from one remote station, feedback occurred in the other between the always closed modulation circuit and the non-muted speaker. Rewiring of these handsets corrected the difficulty and restored operation to normal.



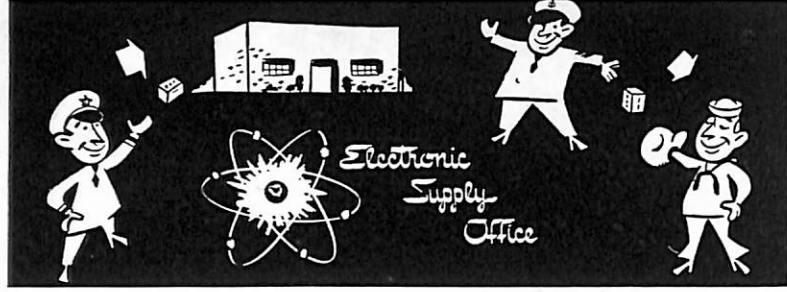

# E.S.O. MONTHLY COLUMN

## PROVISIONS FOR "PARTS PECULIAR"

The new Spare Parts Specification 16E6(Ships) provides for a provisioning meeting to determine the "parts peculiar" that will be procured for equipment spares and for bulk stock. Representatives of BuShips, ESO, the cognizant Inspector of Naval Material, and the equipment manufacturer assemble at the manufacturer's plant to review the equipment and to go over the parts list and determine the quantities to be procured.

The items that are selected by BuShips represent the maintenance parts-peculiar to be supplied with the equipments in the form of equipment spares. ESO representatives determine the quantities for stock which it is believed at the time of the provisioning meeting will meet the requirements of this part for the life of the equipment. No common parts are procured under Spare Parts Specification 16E6(Ships), as these parts are procured by ESO and maintained in stock based on supply and demand requirements.

ESO's estimate on the number of parts needed for the life of the equipment is based partially on failure data for similar parts in the same category of material. In this respect, it is essential that the fleet furnish the Bureau with complete Failure Reports on each maintenance repair part. These reports, when consolidated, should reflect a true picture of the frequency and type

## NBS-383 FAILURES REPORTS ON DEFECTIVE ITEMS

Failure reports received by the Bureau of Ships indicate that many items are received in a defective condition. This often is a result of faulty packing, stowage and handling.

Reporting an item that was received in a defective condition is just as important as reporting an item that failed in service. The Bureau of Ships forwards these failure reports to ESO for review and appropriate action. When complete information, describing the condition in which the material was received and the name of the issuing activity is included on the report, it provides a basis for taking more positive action to prevent such failures in the future.

of failure, so that usage of similar items may be predicted.

Accurate determination of parts-peculiar needed for the life of the equipment is necessary to eliminate overstocking and to avoid exorbitant manufacturing costs at a later date. Once the manufacturer has discontinued production of a particular item, and scrapped the dies, the engineering expense required in retooling for production of a small quantity may result in a cost of more than one hundred times as much per item as the original sales price! Therefore, it is essential to procure correct stock quantities so that supply of parts peculiar will not be depleted during the life of the equipment.

## COLD STORAGE LENGTHENS LIFE

No, sailor, that doesn't mean you have to lock yourself up in a refrigerator every night! We are referring to the life of dry cell batteries—not human beings.

It is well known that the life of a dry cell battery gradually diminishes, even though the battery may be lying idly on a shelf. No "fountain of youth" has been discovered to assure complete recovery, but it has been learned that cold storage of dry cell batteries does lengthen shelf life approximately six months.

For this reason, and to obviate many of the difficulties formerly encountered in the distribution of this category of material, the Bureau of Supplies and Accounts initiated action to establish cold storage facilities at the major distribution points, particularly NSC, Norfolk, NSQ, Pearl Harbor, and NSC, Oakland. In the future, when present stocks are cleared away, a ship or shore activity receiving dry batteries from one of these distribution points can expect an expiration date six months longer.

As a result, not only will the shelf life of batteries be substantially increased, but delivery under contract can be effected in case-lot quantities to the installations having cold storage facilities; requirements for operating activities can be met from stocks maintained in cold storage, thus decreasing the frequency of necessary purchases; and delivery schedules will not have to be revised to meet changing demands at the consumer level.

## ELECTRONIC FIELD CHANGE INDEX

Field Change Number	Field Change Title	Date of Field Change	Serial Numbers of Equipment Affected	Modifying Activity	Man-Hours Req'd	Source of Material	Stock Number of Kit	Instruction Bulletin	Contract Number
<i>YG Radio Homing Equipment</i>									
1	Change in Over-The-Bow Keying Circuit	Nov. '45	All	SF	1	Stock	None	CEMB	None
2	Hood for Barco Joint	Nov. '45	All	YF	3	Kit	—	With Kit	NXs-820
3	Installation of Improved Contacts for Relay K-101	Nov. '45	Superseded by Field Change #4						
4	Elimination of Keying Relay K-101	Nov. '45	All	SF	3	Stock	None	CEMB IB-	None
5	Addition of True Bearing Control Unit Type CAIH-23408	Nov. '45	All	YF	8	Kit	None	38258-P3 (With Kit)	None
6		Nov. '45	1 thru 30	SF	1	Stock	None	CEMB	None
<i>YG-1 Radio Homing Equipment</i>									
1	Change in Over-The-Bow Keying Circuit	Nov. '45	1 thru 759	SF	1	Stock	None	CEMB	None
2	Hood for Barco Joint		Not applicable						
3	Installation of Improved Contacts for Relay K-101		Not applicable						
4	Elimination of Keying Relay K-101		Not applicable						
5	Addition of True Bearing Control Unit Type CAIH-23408	Nov. '45	All	YF	8	Kit	None	IB-38258-P3 (With Kit)	None
6			Not applicable						
<i>Type CME-60069 Signal Generator</i>									
1	Addition of Output Control for Type CME-60069 Signal Generator	Feb. '46	All CME-60069 Signal Generators used with Loran Skywave Trainers	SF	1/2	Stock	None	CEMB	None
<i>TT-23/SG Teletype Panels</i>									
1	Replacement of Jack Washers and Nuts and Rewiring of Meter Circuit	June '48	All	SF	2	Kit	None	NavShips 98085	NObst-39378
<i>Model 14 Transmitter-Distributor Teletype Equipment</i>									
1	Replacement of Motor-Generator Resistor	Oct. '47	All Model 14 transmitter-distributors having either No. 107151 or No. 6708 AC series governed motors	SF	1	Stock	None	NavShips 98028	None





# The MODERN ALADDIN

ELECTRONICS IS YOUR 1950 GENIE — BUT TO ACQUIRE  
 FULL CONNICTS OF THIS MODERN GIANT REQUIRES THAT  
 YOU, TECHNICIANS, KEEP INFORMED OF THE LATEST ELEC-  
 TRO. TRENDS, INITIATE AND ZEALOUSLY FOLLOW  
 PREVIOUS TRENDS, MAINTENANCE SCHEDULES, AND DILI-  
 GENTLY PERFORM ALL OTHER TASKS CONNECTED  
 WITH YOUR JOB.