

BUSHIPS

JUNE

# ELECTRONICS



ROUTING	INIT.
COMM. OFF.	8
ENG. OFF.	FC
FILE	

RESTRICTED

IN THIS ISSUE  
MAGNETIC AMPLIFIER  
FUNDAMENTALS

Miller

**THIS  
ISSUE**

<i>Magnetic Amplifier Fundamentals (part one of 2 parts)</i>	1
<i>Anomalous Propagation</i>	6
<i>Model RDM Failures</i>	11
<i>Secure Equipment Covers Properly</i>	11
<i>AN/URR-13 Warning—Use Proper Alignment Tool</i>	11
<i>Use of the LM in Receiver Alignment</i>	12
<i>Soldering Miniatures</i> .. <i>Atkinson</i>	14
<i>Model SV Servicing Notes</i>	16
<i>Availability of F. C. No. 1—QHBa and F. C. No. 1—QHB-1</i> ... <i>Ommen</i>	16
<i>Insulation Resistance of Shipboard Coaxial Lines</i>	16
<i>E. S. O. Monthly Column</i>	17
<i>Protecting Exposed R-F Cables and Connectors</i>	18
<i>Models TEB and TEC Bias Circuit Modification</i>	18
<i>RMB Pages "SL Series 3-i" and "SL Series 3-ii"</i>	18
<i>Letters to the Editor</i>	19
<i>GCA Reports</i>	32

THE PRINTING OF THIS PUBLICATION HAS BEEN APPROVED BY THE DIRECTOR OF THE BUREAU OF THE BUDGET 13 JANUARY 1950

*DISTRIBUTION:* BUSHIPS ELECTRON is sent to Department of Defense activities concerned with the installation, operation, maintenance, and supply of electronic equipment. If the quantity supplied is not correct, please advise the Bureau promptly.

*CONTRIBUTIONS:* Contributions to this magazine are always welcome. All material should be addressed to The Editor BuShips Electron, Bureau of Ships (Code 993-c), Navy Department, Washington 25, D. C. Whenever possible articles should be accompanied by appropriate sketches, diagrams, or photographs.

*CLASSIFICATION:* Most issues of BUSHIPS ELECTRON are classified restricted or confidential in order that information on all types of equipment may be included. Specific material published in any issue may or may not be classified, however. Each issue is assigned the highest classification of material included. Classified material should be shown only to concerned personnel as provided in U. S. Navy Regulations. Don't forget, many enlisted men are concerned with the contents of this magazine. BUSHIPS ELECTRON contains information affecting the national defense of the United States within the meaning of the Espionage Act (U.S.C. 50; 31-32) as amended.

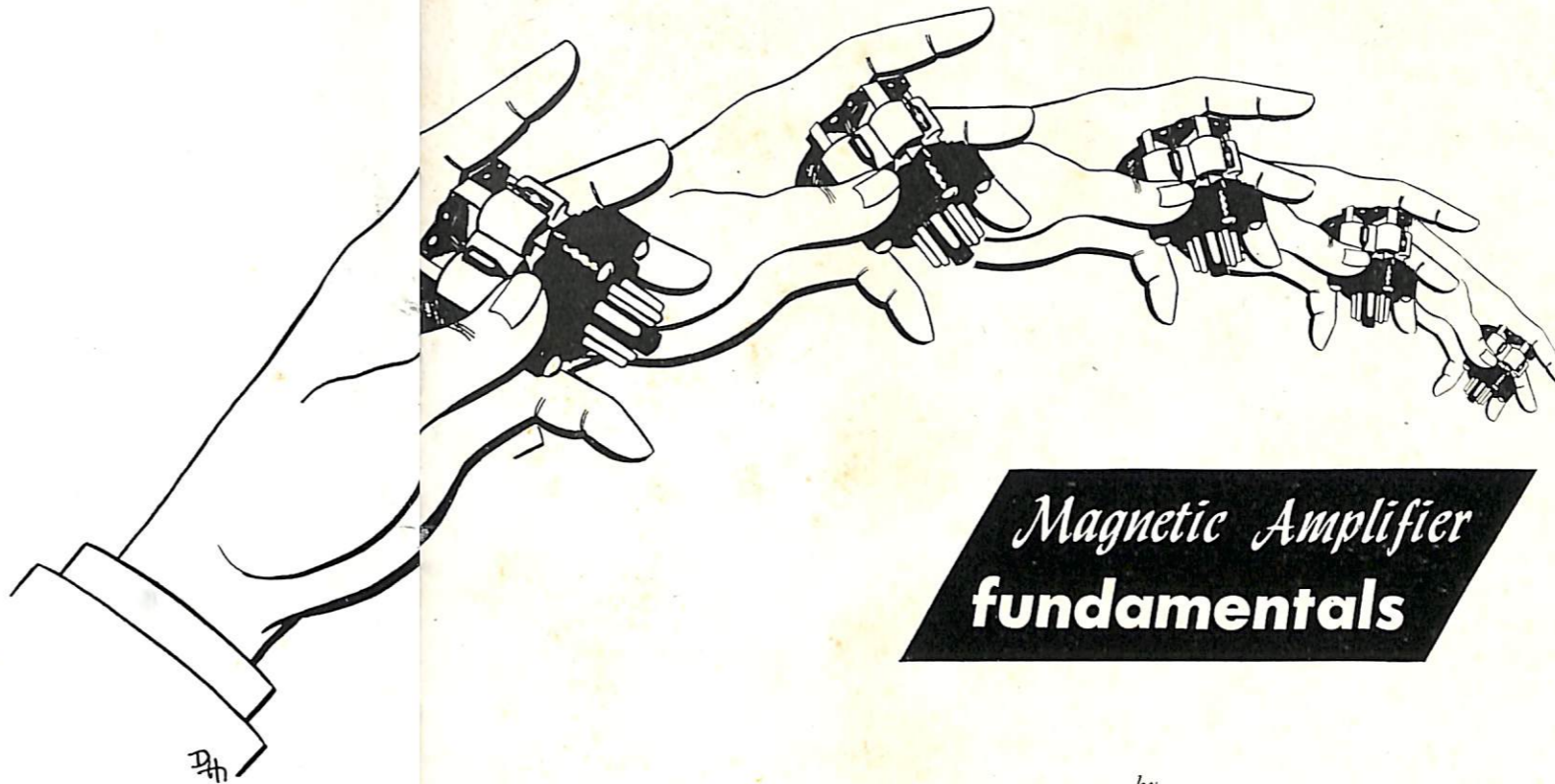

## *Magnetic Amplifier fundamentals*

by  
LT. CDR. ALMON M. VINCENT, USN  
*Electronics Design & Development Division  
Bureau of Ships*

### Introduction

This paper on magnetic amplifiers has been prepared to supplement a memorandum titled "Magnetic amplifiers, Applications" issued by BuShips, Code 815B on 11 October 1950. After the original memo was distributed, sufficient requests for additional information and extra copies were received to warrant a more complete treatment of the subject.

Previous articles<sup>1</sup> described the magnetic amplifier from a mathematical and design angle, analyzing results obtained with various types of core material, coil relationships, etc. Therefore, the mathematical analysis will not be included in this review.

The material used in this subject represents information more of a practical nature, gathered from various symposia, government and commercial engineering reports, patent applications, contractors data and technical publications. In certain instances, direct phraseology

used in foreign translations and in some material sources was necessary to obviate any possibility of reflecting a personal bias on controversial or critical points. Some sources were overly optimistic in their appraisal of applications, others unduly conservative. An average between the two extremes can be expected in the production units. Direct quotations, unless greatly contracted for simplification, are credited to their source. A reference bibliography is included for any one desiring to examine the mathematics and design data more in detail.

A magnetic amplifier is essentially a device in which the alternating-current reactance of a coil is controlled by means of a direct-current signal which modifies the permeability of the magnetic material upon which the coil is wound. Magnetic amplifiers are often referred to as saturable reactors, d-c controlled reactors, amplistats, transducers, saturable transformers, etc., although all are not exactly synonymous names. Actually almost any conventional transformer containing an "iron core" could be used for this purpose, but it would not be efficient.

<sup>1</sup> See the bibliography at the end of this article.

These amplifiers are not new. The possibility of utilizing magnetic saturation for control purposes was mentioned by Lord Rayleigh, in 1887. The first American patents on such a device were granted as early as 1903. Four German patents on saturable controls were granted between 1909 and 1916. Related devices utilizing saturable core features were found in electrical equipment in Austria and France as early as 1885 but were not identified as such.

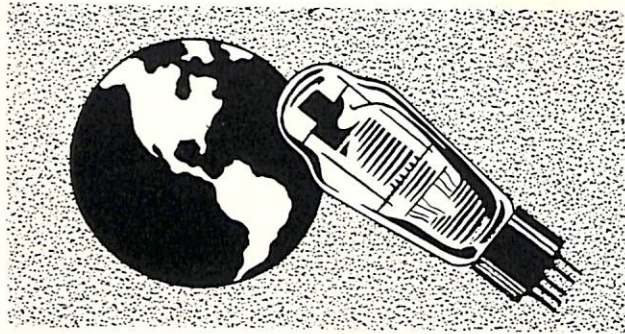

Dr. E. F. W. Alexanderson is generally accepted as the inventor of the magnetic amplifier in that his disclosure of 1916 was the first to indicate that the device could be used as an amplifier. However, prior to this, Fessenden, in his early work outlined the basic principles of varying an inductance by changing the permeability of its core for radio-frequency applications. In 1912 a radio telephone circuit was established between Berlin and Vienna, utilizing magnetic amplifiers as r-f modulators. Alexanderson's patent in 1920 incorporated self excitation utilizing a shunt rectifier. In 1921, Logan of USA introduced the series load rectifier. This is the feature that elevated the device to a more competitive position with other control components. This amplifier, however, never gained popularity at that time, due mainly to the unsuitable core material and mercury arc rectifiers then available. Another thing that retarded development was that the industry simply was not ready for such a device. Universal application of electron tube devices was then in the midst of its popularity in about the same relationship that the magnetic amplifier is in industry today. The application of the dry copper oxide rectifier, with an improved self excitation circuit in 1928, revived the interest in the device somewhat. The introduction later of the more stable selenium rectifier contributed toward a more reliable and predictable performance. The efficiency however was still low in comparison to vacuum tube components. It was not until a special core material was developed that the device began to compete with vacuum tube components.

Preisach, in Germany probably can be credited with the rebirth of the magnetic amplifier in that he was responsible for the development of the first magnetic material having a rectangular hysteresis loop. The ma-

terial used for this development however, was Permalloy, an American contribution. A paper on this process was published in 1932. Additional improvements in this loop were made in 1934 by Dahl and Pawlek, also Germans, by further purifying the material and combining magnetic annealing and grain orientation treatment in 50 percent nickel-iron. The Japanese however had revealed the magnetic annealing process prior to this. Swedish engineers also contributed invaluable theoretical data during this period of development. Dr. Lamms publication entitled "Transductor," released in 1943, (2nd edition 1948) is probably the most comprehensive mathematical and theoretical treatise on this device available to date.

This is roughly the picture on development of this device prior to the war. At this point it became a practical device. Later developments resulted in improved efficiency and performance, but no particular high points were passed. The patent office lists several hundred patents on magnetic amplifiers and related devices, most of which are on improvements in design and new applications. Space permits only a historical review of basic developments up to the point where the amplifier became a practical device. To give due credit to the many other prominent American and foreign inventors who have contributed to this development would require several volumes.

It was during the last war that the exploitation of this device was accentuated by the discovery of the general application of the magnetic amplifier by the German army, navy, and air force. It was mainly the improvement in magnetic material and the introduction of selenium rectifiers that led to the practical exploitation of the magnetic amplifier by the Germans.

The German navy used magnetic amplifiers in its master gun stabilizing system. The German air force used it in an automatic pilot and in blind approach equipment. They also used this unit in various servo applications, and frequency control for motor generators in the long range rockets and in blind landing aids, and to regulate the fuel flow in relation to atmospheric and ram air pressures in some types of guided missiles. The German army had even started to apply it to the V-2 steering system. Although some progress had been made in developing improved core material during this period, most of their scientists on this project concentrated their efforts toward practical applications.

The Japanese also early realized the advantages of such a device. This is attested to by the fact that every major improvement in magnetic material during this century, which included permanent magnetic material such as cobalt and alnico, resulted from Japanese efforts.

Saturable core reactors and transformers, with limited applications, were used by the Germans as automatic stabilizers in submarines during the first world war, but

they were relatively inefficient devices compared to current components.

It was during the last war that it became evident in this country that magnetic amplifiers could be used to good advantage in many places where vacuum tubes were previously considered necessary. The U. S. Navy has been incorporating this static device, to a very limited extent, primarily in rotating equipment, during the past eight years.

Renewed interest in magnetic amplifiers, not only by the electronics engineers but by the electrical power industry as well, can be attributed to several factors, mainly:

- 1—The internal feedback circuit utilizing dry rectifiers, resulted in a considerably greater power gain ratio.
- 2—Improvement in both core material and dry rectifiers, which made it possible to build a much smaller and efficient unit.
- 3—The German operating experience in both air and surface crafts proved in some measure the reliability of such a device.
- 4—The need of a rugged, static, maintenance free device, requiring no "warm up" time.
- 5—Reduction of number of electron tubes otherwise necessary.
- 6—Engineering development made available multiple units with improved linearity, gain and response time. These improvements coupled with smooth compound interacting controls made the device applicable to equipment heretofore not considered.
- 7—The Bureau is ready for such a device. The increased maintenance load resulting from the constantly expanding electron tube and automatic control devices is becoming a major consideration. Indications are that we have only begun to exploit its possibilities.

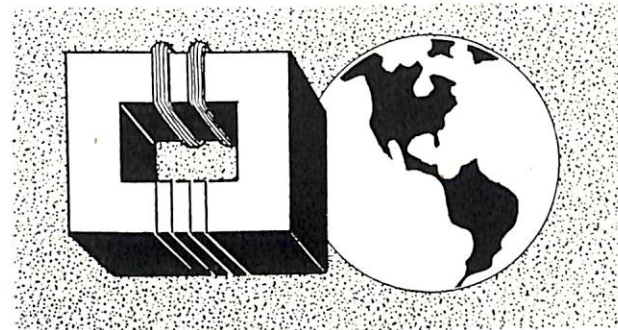

A few of the circuits, broken down to basic essentials, are shown to assist the readers in familiarizing themselves with the theory of operation. Many of these simplified circuits would function without modifications, however, in actual practice, additional compounded coils, resistors, and capacitors are added to increase the versatility, by improving the power factor, response, and adaptability to the specific application. These circuits are shown with a single turn control coil. Actually there

are usually several hundred times as many turns on the control coils as there are in the load coil. In many instances, to simplify the sketches, only single reactors and simple half wave rectifiers are shown, when this can be done without affecting the theoretical operating principle. In most installations, opposing coils and bridge rectifiers would be required. General fields of application are cited along with typical starting compositions offered as an aid to the skilled technician in the development of magnetic controls to meet his special needs. In addition to the uses cited, the skilled technician will no doubt visualize and develop other applications.

## <sup>2</sup>Applications

Applications of the magnetic amplifier are listed as follows:

1—*Amplifiers*—AC or DC for current voltage and power. Example: Low level d-c applications: Thermocouple and photo cell amplifier to directly operate motors and controllers. Amplification gains of several million can be realized without the use of electronic tubes but with rather long time constants. This is an excellent d-c amplifier. This amplifier is not subject to drift difficulties often encountered in electron tube installations.

2—*Regulators*—(most common use) control of voltage, current and frequency of industrial power installations, ship main propulsion and auxiliary units, aircraft automotive electrical equipment, line-to-line voltage regulators independent of frequency. (Regulating applications have been thoroughly proven and should be considered for all auxiliary generators supplying power to electronic equipment—a large portion of electronic equipment failure can be attributed to poorly regulated power supplies.)

3—*Relays*—Locking including normally closed, open or frequency sensitive relays. (The substitution of these units for mechanical relays should be considered for equipment used in the tropics, where contact and mechanical difficulties are encountered due to humidity and fungus, as they contain no contacts and moving parts and can be completely sealed.)

4—*Saturable Reactor*—Lighting control, variable impedance, etc. Single units are currently used to control up to 50,000 kva.

5—*Motor Starters, Electrical Welding and Automatic Battery Charging Control*—The effectiveness and sensitivity of regulating controls are considerably increased by the addition of a non-linear device such as a thyrite or glow tube which can be connected to effectively amplify the error or act as a reference source themselves.

6—*Current Limiting Reactors*—Limiting power currents during short circuits. Limiting armature currents during slow motion or static conditions in follow-up motors.

<sup>2</sup> The following material, to footnote 3, is taken from the original memo.

7—*Servo Systems*—Complete, utilizing magnetic amplifiers as regulators, converters, computers, and as a complete replacement for a rotary magnetic amplifier (amplidyne) system, at less cost and weight.

8—*Instrument Amplifiers*—Remote control, etc.

9—*Synchronizer*—For automatic pulse and frequency control.

10—*Differentiating Systems*—For course plotters and predictors (Example: Direct integration from DECCA, RAYDIST, LORAC and RADUX-II phase comparison meters to graphic course plotters) constant speed controls for surveying, wire drag, mine laying, convoys, etc.

11—*Automatic Stabilizers and Pilots*—For submarine and aircraft. (A-C power supply systems for aircrafts are well established making saturable reactor control extremely attractive.)

12—*Impulse Storing and Memory Devices*.

13—*Timers*—Timing pulse generator for radar and loran equipment. Wave shaping, etc. (currently produced with frequency range between 25 cycles and 1 Mc.)

14—*Electrical Computers*—Add-subtract-multiply-divide-differentiate-or integrate electrical quantities.

15—*Converters*—DC to AC—AC to DC. Another possible method of converting DC to AC at both 60 and 400 cycles for the electronic equipment on auxiliary vessels equipped with d-c main generators. Rotary converters and motor generators on any vessel have always been a maintenance problem. (The DC to AC application is still under development.)

16—*Oscillators*—Within limited frequency range.

17—*Phase Shifters*—Reactance control to  $1/4$  cycle. Currently used as phase shifters in grid control of mercury arc rectifiers, and pulse delay matching circuits in radar equipment.

18—*Fuel Pump Reactor Drives*—(In locations where relay starting and control contact sparks could cause an explosion).

19—*Modulators*—Voice frequency modulators and r-f carrier trigger circuits.

20—*Frequency Multipliers and Reducers*—Including telephone tone and ringing circuits up to RF. In one type of frequency multiplier a direct-current flux is added to cause operation of the unit at the most efficient point for the generation of the desired harmonic. Another type recently developed converts 60 cycle power to 420 cycles with an efficiency of 60%, with a considerable reduction in weight over comparable rotating equipment.

21—*Seismograph and Magnetometer Amplifiers*—Tide gauge, anticipator, audio gain sequence circuits. Drift difficulties often encountered in these applications are practically eliminated when this device is substituted for tube amplifiers.

22—*Multivibrators*—One shot and free running

square wave generators.

23—*Sweep Generators*—Trigger and pulse forming circuits for radar and loran equipment.

24—*Counter and Dividers*—For loran, shoran and radar indicators.

25—*Mine and Submarine Detectors*.

26—*Field Control for Magnetic Fluid Clutches and Magnetic Powder Brakes*—One manufacturer has replaced the regular d-c charging generator on an experimental buss with a 400-cycle a-c unit. The generator voltage is magnetic amplifier controlled to plus or minus 2% from

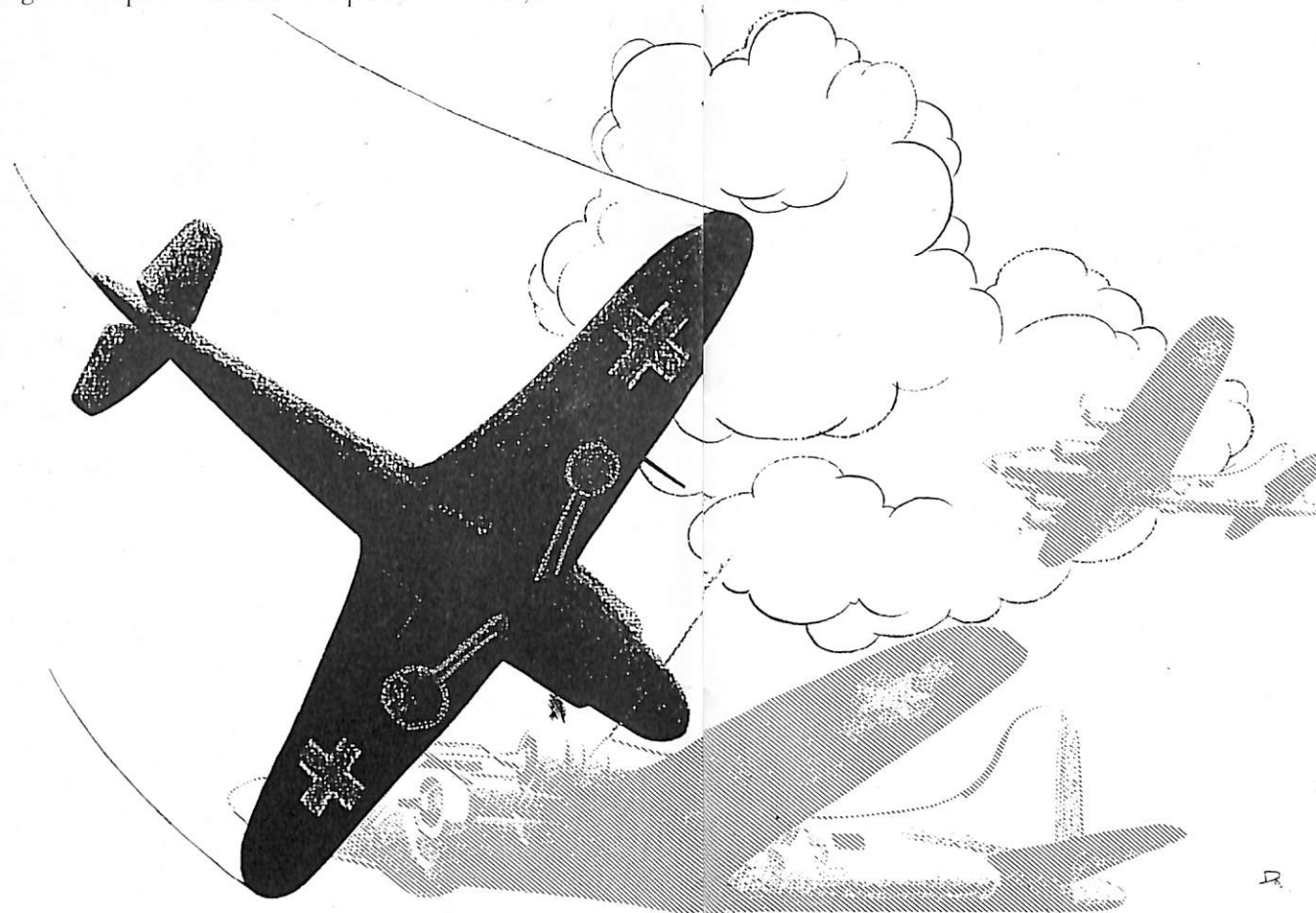

The German Air Force used magnetic amplifiers in automatic pilot and blind approach equipment.

idling to full speed. Magnetic amplifiers are then used to obtain optimum battery charging rates, and as remote controls for the powdered iron brakes, clutch and miscellaneous auxiliary equipment.

### Advantages

The magnetic amplifier has several advantages for electronics which are as follows:

1—They contain no moving parts. Maintenance of the unit without rectifiers is comparable to that of a conventional transformer. With rectifiers the life is governed by the type of rectifiers used—conventional radar germanium crystal rectifiers are used in the low powered

units—dry disc in the larger units. These rectifiers are conservatively rated at 60,000 hours for full power operation.

2—*Ruggedness*—Shock resistance equivalent to that of a transformer of similar size.

3—*Stability*—Comparatively (no cathode emission change with filament temperature) insensitive to variations in power supply (with inverse winding) therefore, requires no separate stabilized power, and can be operated from any available source—(currently production is concentrating on 60/400/800 cycle units, with de-

7—*Circuit Isolation*—The inputs and outputs are electrically isolated. The low impedance circuits also result in reduced electrostatic coupling and feed back.

8—*Safety*—Can be safely operated in enclosed areas where starting relays and control contact sparks could cause an explosion.

9—*Adaptability*—These amplifiers can be built with specially shaped cores for mosaic installations in confined spaces. Amplifier gains can be changed simply by adjusting the d-c fields. Gain control leads are less effected by stray r-f pickup noises often encountered with high resistance high voltage components necessary in equivalent electron tube circuits. Separate low impedance gain windings may be added to the core if isolation is required; (permanent magnets with adjustable air gaps, may in certain applications be used to set fixed gain). Separate windings may also be used to introduce feed back, either positive or negative to obtain increased amplification or degeneration to improve the frequency response. In addition to the above, separate windings have been added to superimpose independently varying signals in either phase relation or amplitude or both for specific purposes.

10—These amplifiers are also excellent devices to use in conjunction with electron tubes for many applications. Tube controlled core saturation can be applied to many existing electron tube installations with a resultant increase in stability, operating range and overload protection.

11—*Readiness*—They require no warm-up time. Example: Gun control units would not have to be kept continuously energized for instant use.

### Disadvantages

Although this amplifier has the advantages listed above, it also has disadvantages which are listed below:

1—*Time Constant*—In general, the time constant is long compared to that of vacuum tubes and short compared to electro-mechanical devices. Current servo production units have a lag of one cycle of exciting frequency. Pulse trigger circuits are being designed with lags of less than one microsecond with a h-f power source. Actually, it may be possible with modern materials and techniques to obtain time constants in most cases, comparable with those of vacuum tube circuits, especially in similar applications.

2—*Impedance Range*—The impedance of a magnetic amplifier cannot be increased to infinity or decreased to zero—reflected impedances, therefore must be considered. With full output (core saturated) the output impedance is reduced almost to the d-c resistance of the core windings and (if used) rectifiers. Input may be designed with an impedance of a fraction of an ohm to a megohm or more.

sign contracts committed to experimental units for self-excited 20-kc carrier voice modulated amplifier for bull horn public address amplifiers).

4—*Overloading*—A magnetic amplifier can carry overloads equal to an equivalent transformer.

5—*Environmental*—Can be hermetically sealed and inconspicuously built in as part of the equipment. Normally requires no ventilation and can be installed in compartments with combustible material.

6—*High Gain*—Power gain per stage is comparable to that of a vacuum tube stage. They can be cascaded almost to any power gain. The efficiency is also greater.

Continued on Page 20

The phenomenon of anomalous propagation is being given increasing attention in current electronics literature and in daily discussion among personnel in the electronics field. This is particularly true in the field of radar which employs much higher frequencies than communications and also by the nature of operation of radar as opposed to radio. Anomalous propagation is the general designation for all non-standard propagation. Anomalous propagation can be summed up in a few words which should be perfectly clear to the layman.



It is that phenomenon which, due to many factors, results in extremely long or short ranges (particularly radar ranges on land mass and surface targets) with the change from one to the other varying from a few hours to several days. By this we mean that on a certain day, evidences of abnormally long ranges may be exhibited by the radar, while on the next day and possibly for many days thereafter, conditions may be normal and the ranges obtained will be in line with those to be expected from that radar. Then a change will occur in the atmospheric conditions which will again produce either extremely long ranges or, conversely, excessively short ranges. These abnormal or subnormal ranges, resulting from anomalous propagation, have resulted in some confusion and misunderstanding, not only in the minds of electronics personnel but in those of many Commanding, Executive, and other ship's officers.

This article is prepared with two basic reasons in mind: (1) To further acquaint Commanding Officers with the imponderables and unpredictables which result in anomalous propagation, and which should be given due consideration before deciding that the electronics equipment is at fault. (2) To caution technicians not to place the blame on anomalous propagation when subnormal ranges are being received until they have thoroughly checked the equipment and are absolutely positive that it is working normally. In the case of the first, some Commanding Officers have, upon perceiving land mass target echoes at ranges of 175 to 200 miles on cer-

tain days, formed the opinion that these ranges are to be expected at all times. Therefore when atmospheric conditions return to normal with accompanying decreases in ranges consistent with what should be expected of the radar under normal operating conditions; or when atmospheric conditions reverse themselves and cause subnormal ranges, these Commanding Officers are prone to assume that the radar is not operating properly and place the entire blame on the Electronics Department.

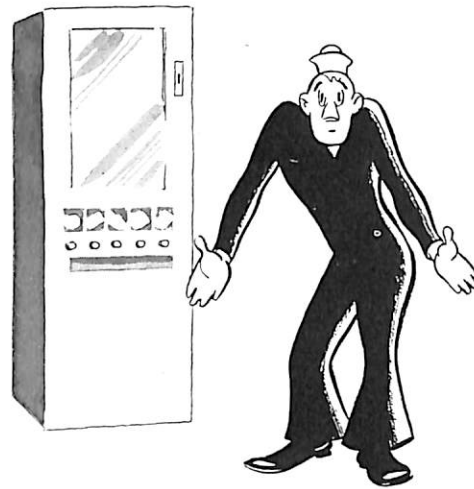

In the case of the second, there have undoubtedly been cases wherein the technicians have been too quick to place the blame for sub-normal results on anomalous propagation when actually the equipment was not operating properly. It is believed, in all fairness to everyone concerned, that both of these points should be carefully considered before any action is taken during periods of non-standard radar performance.

As stated above, anomalous propagation is a condition caused by changes in atmospheric conditions: These changes are principally in temperature and moisture content. It is a rather well-known fact that radar energy, under normal atmospheric conditions, travels in a path very near to line-of-sight with possibly some bending. It is a characteristic of most long-range air and surface search radar equipments that the antenna is designed to produce a beam which will give a limited vertical coverage as well as long-range low-level detection. In the earlier sets, and in some of the sets now in use, this

# anomalous propagation

## COMMANDING OFFICERS PLEASE NOTE!

was accomplished by a "fan beam" type of antenna pattern in which the energy was "sprayed out" from the antenna covering a vertical distance from the surface up to approximately forty or fifty degrees and a horizontal width of from 5° to 10°. Later developments in antenna design produced antenna patterns wherein the energy is directed along the surface in a more concentrated manner and yet simultaneously provides a limited vertical coverage. Practically all the later types of search radars employ this type of antenna, the goal being to obtain the greatest ranges possible on surface targets and aircraft up to 40,000 feet.

At the frequencies employed in radar equipments, energy from the radar antenna is propagated in a fixed pattern directed along the surface and to a limited vertical height. However, some of the energy radiated by the antenna will be lost due to a certain percentage of high angle scattering at the point of origin. Further, the energy that is propagated along the surface will, as

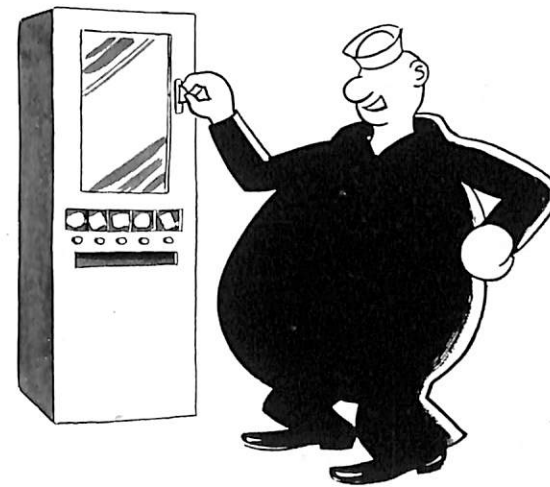

the distance increases, be attenuated due to several factors. This statement is true only where the temperature and moisture content in the atmosphere are such that no sharp changes in density are present. However, if a high density medium does exist and that medium is lying near the surface of the earth or water (approximately 100 feet to 2- or 3,000 feet) super-refraction of the radar rays will result.

Experiments, tests, and atmospheric data have proven beyond a doubt that under certain conditions such a high density medium will be present in certain areas with its height from the surface varying from a few feet to several thousand feet. One condition which causes this phenomenon and which is encountered quite frequently at sea is the presence of a warm air mass over a cool body of water.

Under normal or standard conditions, the temperature of the atmosphere decreases slowly from the surface of the earth to the higher altitudes and the moisture content varies in much the same manner. When a warm body of air is present over a cool body of water evaporation of the water from the surface produces a concentration of moisture and a decrease in temperature near the surface. At an unpredictable height above the surface, determined by the height of the body of warm air, the temperature will be much greater than at the surface and the moisture content will be less. This results in a sharp temperature inversion and a pronounced moisture lapse (decrease in moisture content). Under these conditions, the refraction of radar waves is sharply increased. When refraction is greater than normal the radar waves will more nearly follow the surface and detection ranges on low-flying aircraft and surface targets will be markedly greater than normal.

Radar surface coverage can be adversely affected by atmospheric conditions just as easily as it can be advantageously affected. In the preceding paragraph we have explained the phenomenon of a "duct" being formed between the surface and a body of warm air lying at a certain height above the surface. The condition which produces sub-normal surface coverage is brought about in a manner similar to that described above, except for the location of the "duct". Temperature inversions and moisture lapses are not confined entirely to surface locations. It is possible for temperature and moisture conditions to be such that "ducts" can be formed in the atmosphere itself. In other words, if meteorological conditions are such that a cold moist area is present up to a certain altitude and above this altitude lies a warm



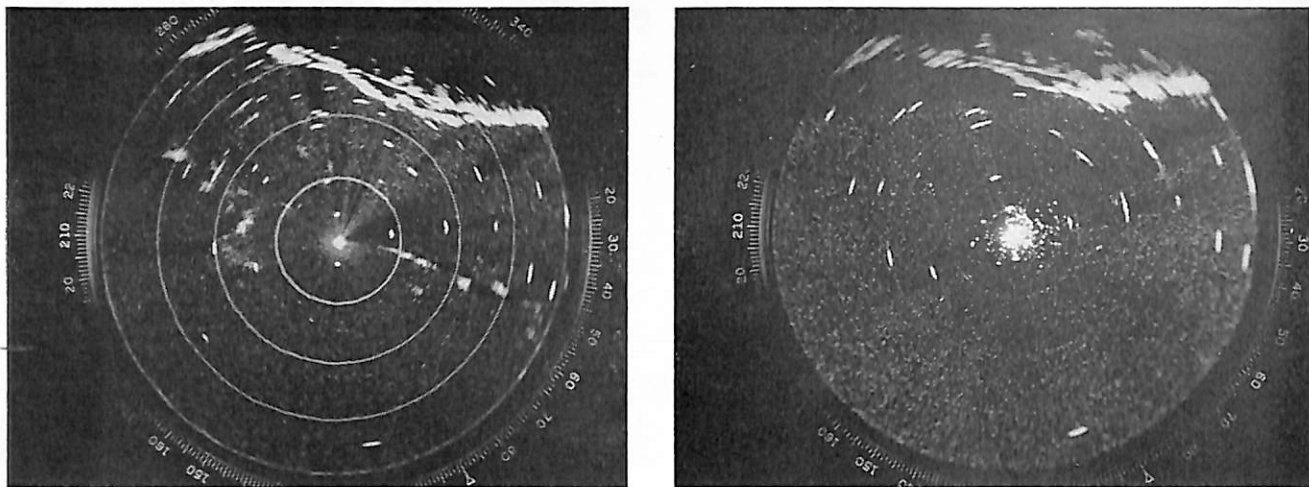

A comparison of the effects of "trapping" on different model radars, both on the 80-mile scale. SG-3 on left and AN/SPS-6B on the right.

body of air we will have the same conditions of temperature inversion and moisture lapse as those described for surface conditions. However, the "duct" now formed will be lying in the atmosphere and will have no connection with the surface. These "ducts" are not necessarily parallel to the surface but may run at angles from the surface upward. If a ship is located in such a position that the energy from the radar is being trapped in one of these atmospheric "ducts" there will be a noticeable reduction in ranges normally obtained on surface and low-flying aircraft and possibly a pronounced increase in high-angle coverage. This is the situation where the technician must be very careful to insure that his equipment is operating properly before deciding that atmospheric "trapping" is present.

Experiments and investigations have proven that radar

waves radiated from an antenna up to angles of 1.5 to 2.0 degrees from the horizon will be trapped in surface "ducts" when atmospheric conditions are such that these "ducts" exist. The remainder of the energy in the radar beam will be propagated in the atmosphere above the "duct". In this discussion the energy we are primarily concerned with is that small amount which will enter and be trapped in these "ducts". Admitted, it is only a small percentage of the total energy propagated from the antenna but due to the characteristics of the "duct" and other properties, attenuation of the energy is very small when compared to the remainder of the energy not trapped. Radar waves which are trapped will tend to follow the surface beyond the line-of-sight and much further. Therefore when we consider that the energy in the "duct" is attenuated very little and that by action of

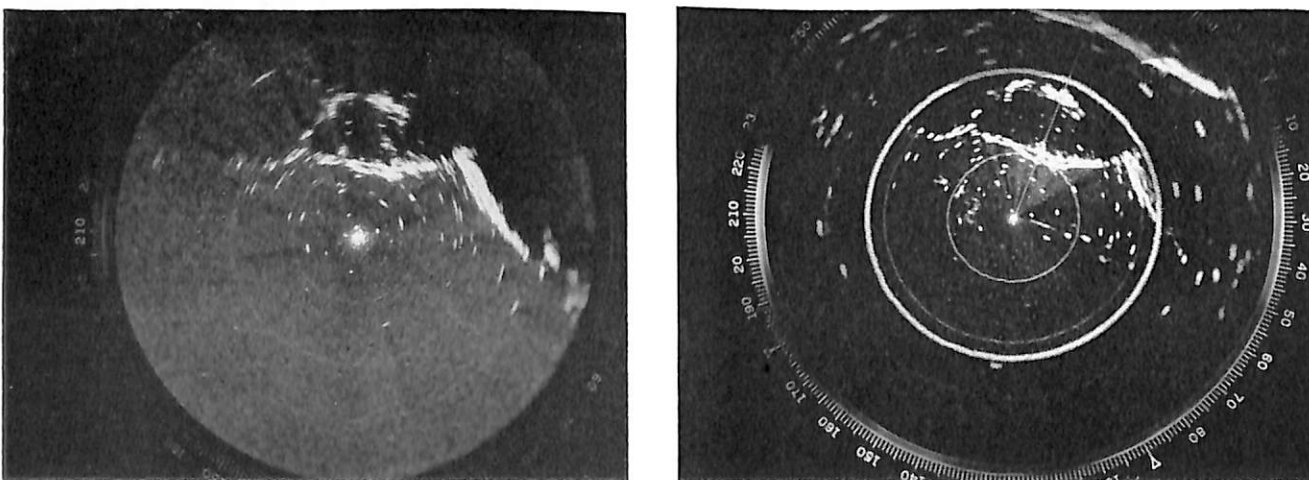

A second comparison of the SG-3 (on left) and AN/SPS-6B (on right) radars illustrating "trapping" on the 200-mile scale.

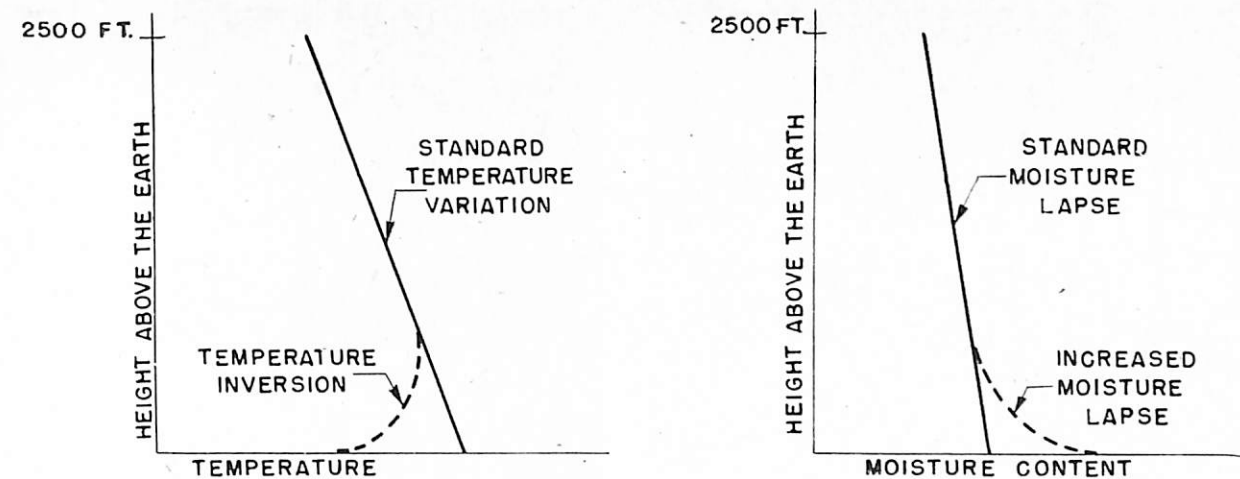

Variation of temperature and moisture content of the atmosphere as a function of height above the earth.

the "duct" this energy is carried well beyond the line-of-sight, then it becomes apparent that we will obtain extremely long ranges on objects which are on or near the surface—in other words all objects which are enclosed in the atmospheric "duct". Again it is pointed out that this trapping affects only those radar rays which are radiated at very low angles (up to approximately 1.5 degrees from the horizon). Those waves which are radiated at a higher angle are not bent sufficiently to enter the "duct". The over-all effect of this "trapping" on the radar coverage is to extend the lobe or lobes which lie within the duct, thus producing the "fantastic" ranges of 175 to 200 miles and even greater on surface targets, particularly land masses, which are often-times observed on our radars. It is pointed out that all available data tends to indicate that the higher radar frequencies are more susceptible to "trapping" than the lower radar frequencies, although current air search radars operating in the "L" band have repeatedly exhibited effects of "trapping" due to weather conditions.

The existence of the phenomenon of anomalous propagation has long been recognized by engineers and scientists but its effect on radar coverage as a whole, both surface and air and combination of the two, is still a matter of much discussion. One fact that all are agreed on is that when temperature and moisture conditions are in a certain relationship an effect of radar trapping and ducting will be present and extremely long ranges will be observed on surface targets and low flying aircraft. As for the effect on detection of high-flying aircraft during periods of surface trapping, there are two distinct lines of thought, and unfortunately the two are at variance with each other. The first is that detection of high-flying aircraft is not seriously affected during periods of surface trapping. This theory has been in-

vestigated fully and much data taken to substantiate same. The second is just the reverse in that detection of high-flying aircraft is adversely affected during periods of surface trapping. The proponents of this theory have made numerous observations but detailed data such as records of ranges and altitudes taken simultaneously with temperature and humidity do not exist. True, the experiments and tests conducted by the two groups were in widely separated locations and different types of radars were employed throughout the investigations. However, in spite of these facts, the results were so dissimilar that the question is still, for all practical purposes, unanswered to the satisfaction of all concerned.

The foregoing dissertation is not intended to advance the theory of either of the two groups but rather to point out and explain in a general manner to all interested parties that anomalous propagation does exist and that radar ranges can be advantageously or adversely affected by the phenomenon. If Command as well as technical personnel will recognize this basic fact and weigh each situation carefully it is believed that each will more fully appreciate the problems and viewpoints of the other.

Technicians should maintain performance records of their equipments for presentation to the Electronics Officer or other interested personnel. If these records are accurate and cover regular periods the Electronics Officer can more easily inspect them and check to insure that the equipment is up to normal operating efficiency when periods of anomalous propagation are suspected. Equipment manufacturers, under the direction of the Bureau of Ships, have provided many testing procedures for use on radar equipment. Over-all performance can most readily and reliably be checked by the use of the echo box. This test unit is designed to give a complete check

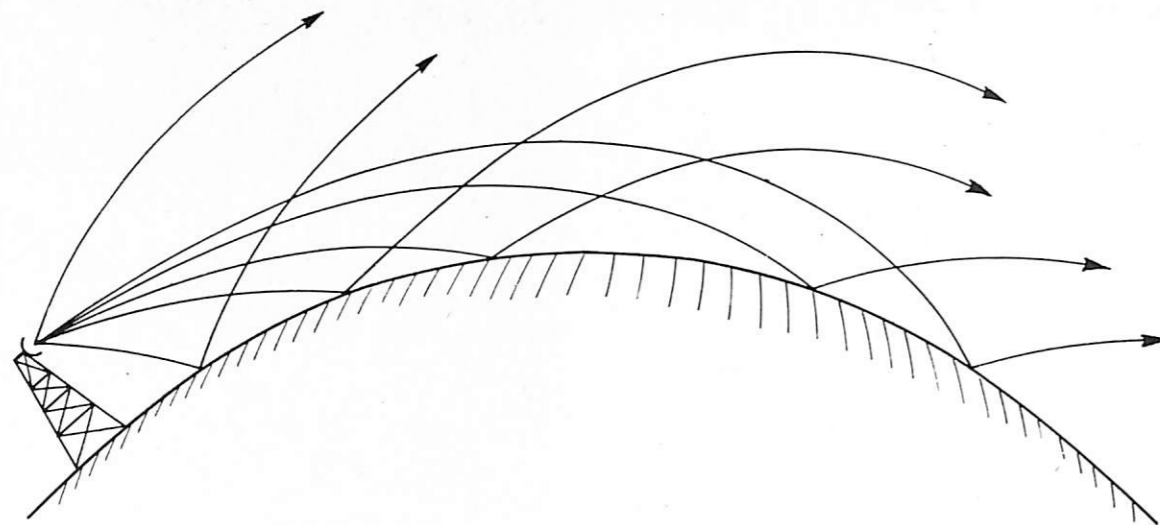

An artist's illustration of surface trapping resulting from abnormal refraction.

of transmitter and receiver performance. In some radars the echo box also includes a check of the r-f transmission line and antenna. However, if the box only checks the transmitter and receiver it is still a valuable and reliable instrument for indicating system performance. A suggested method of maintaining echo box ring times is by a graphical presentation. This can be easily done by plotting ring time (vertical coordinate) against hour and date (horizontal coordinate). Thus when the graph is inspected, the entire picture is presented showing system performance over a long period of time. Experience has proven, however, that different operators and technicians

will obtain different readings of ring time on the same equipment. In this respect it is desirable, if practicable, that the same person, either technician or operator, rather than random personnel, measure and record all ring times on one particular radar. By this we mean that if ET3 Jones is assigned to the SP radar, he and only he, should measure and record ring time on that particular equipment. Thus the element of varying interpretations by different personnel will be, to a certain extent, eliminated from the graphical analysis of system performance as presented by ring time measurements.

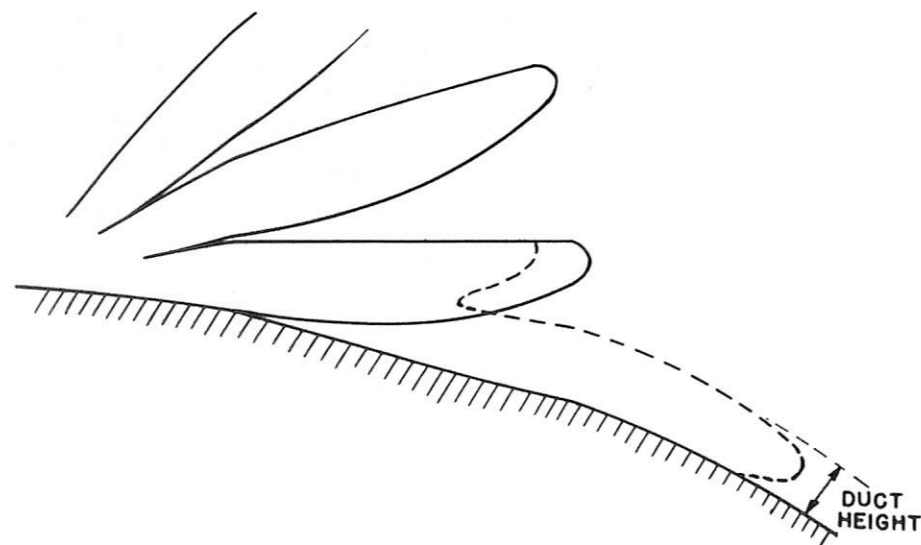

Idealized illustration of increased low-angle and surface coverage caused by surface trapping of energy.

## MODEL RDM FAILURES

The Bureau of Ships has been advised by a field activity that frequent outages are occurring in Model RDM receivers being used with i-f type converters without an audio load. Under this "no-load" condition the plate dissipation of the 6K6 output is exceeded causing the tube to short. The shorted output tube would then cause a burn-out of either the output transformer, the filter choke, or the power transformer. This type of failure may be largely eliminated by connecting a 500-ohm 5-watt resistor across Terminals 1 and 2 of TB-4, which is located in the rear of the chassis. This resistor will place almost a normal load on the output tube but will not interfere with headphone reception. It should be removed when use of the loudspeaker is required.

If, under conditions of extremely high ambient temperature and high line voltages, the resistor does not offer sufficient protection, a 1/8-ampere fuse may be installed between Pin 2 and X-14 and L-50. As wired at the factory, the original lead also serves as a filament lead for V-14. Care must be taken that the fuse is not inserted in the filament lead. The fuse may be mounted in an extractor type fuse holder mounted in a convenient spot on the rear apron of the chassis.

Where required, the foregoing modification is authorized without report to the Bureau.

## AN/URR-13 WARNING— USE PROPER ALIGNMENT TOOL

Attention is invited to the fact that the r-f plate inductance trimmer screws in the AN/URR-13 receiver are approximately 180 volts above ground. These screws are of the Bristol type and a special insulated alignment tool to fit these screws is provided with each receiver.

Inexperienced or careless personnel may attempt to use a regular metal Bristol wrench to make the plate trimmer adjustments which would result in either a severe shock or grounding of plate voltage.

All Electronics Technicians are warned of this potential hazard, and are requested to insert the following warning under Para. 4d Section 7 of the instruction book:

"WARNING—Unless the Bristol type alignment tool furnished with the equipment is used, danger to personnel and damage to equipment may result since these trimmer screws are 180 volts above ground."

## SECURE EQUIPMENT COVERS PROPERLY

The Officer in Charge, Electronics Technicians School, Class "A", Great Lakes, Illinois, reports an amplifier searchlight control box received in damaged condition.

The cover of this particular control box was received with only seven of the thirty-two bolts and nuts in place as shown by chalk marks on Figure 1. The three top nuts were loosely secured. Complete deterioration of the electrical parts was caused by moisture entering

under the loose cover. All electrical items with the exception of the drive motor are considered beyond economical repair. The usable mechanical parts are being salvaged for future use.

This report is printed as an item of interest indicating the damage that can accrue as a result of poorly secured covers on equipment stowed for long periods.

FIGURE 1.



# USE OF THE LM IN RECEIVER ALIGNMENT

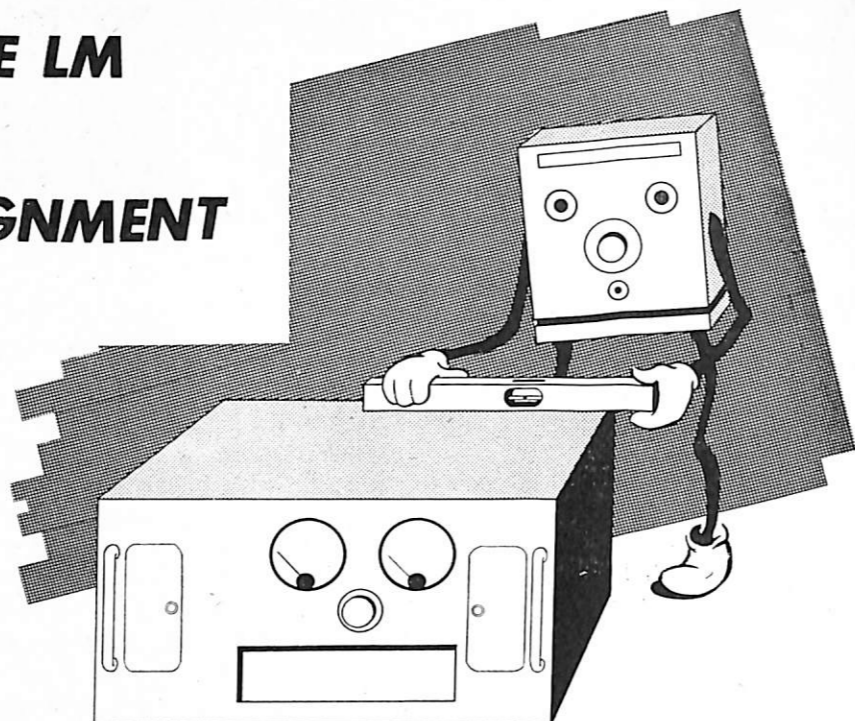

by

H. I. STRATTON and L. F. ZAKOWSKI  
Philco Field Engineers

Using the LM Frequency Meter for calibration and alignment of receivers is considered desirable when no signal generator is available. The LM is especially useful in the alignment of receiver i-f stages in u-h-f and v-h-f receivers, such as the RCK and RDZ. In crystal controlled receivers, since the i-f sensitivity is practically the rated receiver sensitivity, it is mandatory that the i-f stages be very accurately aligned. One of the exceptions to use of the LM for i-f alignment is Navy Model TBS receiver which requires a very strong signal for alignment of its i-f stages.

In considering the use of the LM its disadvantages should be pointed out; the greatest of these being its uncalibrated output voltage. The LM, as a frequency measuring standard, is very rich in harmonic frequencies. It must be noted that the higher order of harmonics, when received on the higher frequency ranges of a receiver, will be separated by a smaller number of dial scale divisions. This should not cause trouble, if the technician uses a little caution, unless the receiver is very badly misaligned or the frequency scale is in great error. Another drawback of the LM is its relatively low power output (compared to that of the LP) and its lack of low frequency coverage below 125 kc., as would be required on such receivers as Models RAK and RBA.

Although the fundamental frequency range of the LM is from 125 kc., to 250 kc., on the low frequency band, and 2000 kc. to 4000 kc., on the high band, it may be used above 20 megacycles with a little caution.

As the higher order harmonics are used, the power output of the LM will diminish. A shielded lead should be used with the LM and provisions made for grounding the shield at both the LM and receiver terminals.

An example of LM fundamental frequency setting would be as follows: It is desired to use the LM as a standard for checking 10 megacycles on the receiver. This can be obtained from many different fundamental frequency settings. An example of two typical settings would be 2000 kc. and 2500 kc. If the fifth harmonic of 2000 kc. were used one would have more check points closer to desired frequency. If the 2500-kc. fundamental were used, it would give a higher signal output (due to being lesser order harmonic) and would more greatly separate adjacent check points. It might be desirable to spread out these adjacent check points to prevent accidental alignment on the wrong harmonic in cases of excessive receiver error. Following accurate calibration it may be helpful to use a lower fundamental frequency of the LM to aid in plotting the response curve points across the band.

## Using the LM as a Signal Generator

The output of the LM is developed across a 500-ohm carbon potentiometer. When connecting the LM to the receiver it is recommended that a suitable isolating capacitor (such as a .001-microfarad 600-volt paper or mica) be used to prevent any receiver high voltage from accidentally being connected across this potentiometer during alignment of i-f stages.

On receivers not equipped with built-in output meters it is important that an external output meter (Models

OCR, OE, Simpson 260, or similar) be used on the receiver output to give a sharp visual indication of maximum signal level. The output meter should be kept on its lower ranges to give a more accurate peak and to reduce the chance of overdriving the receiver and creating stronger images with excessive LM output signal.

## Preliminary Receiver Sensitivity Check

If a receiver is accurately calibrated (as indicated by frequency checks with known frequency stations at different points on the band) and the noise level, with antenna disconnected, is high, it may be assumed the receiver is operating normally. If an LP is available it should be used to verify sensitivity. (It is assumed that the tubes in the receiver have been checked.)

In comparing the overall sensitivity of one receiver against another it must be remembered that all controls should be in the same respective positions. The r-f gain controls should be in their maximum clockwise position, AVC controls set to "off," crystal filter (where used) should be "off", etc.

## Checking Sensitivity with the LM

The following is an example of checking a typical 3 to 6 megacycle band on a receiver. Adjust the LM fundamental frequency to 250 kc. This will provide numerous check points across the band. As the receiver

is tuned across the band, from low end to high end, there will be indications every 250 kc. (disregarding images). Each harmonic of this 250-kc. signal should be plotted as to the indication on the receiver output meter. The peak meter readings should fall off gradually in going from the low end of the band to the high end.

This is due to the decreasing strength of the higher order harmonics transmitted by the LM. Such indications as an increase in the signal at the high end of the band or a dip in the center of the band would indicate improper tracking of the receiver. This would suggest complete re-alignment on that band.

## Use of an LP for Final Check of Sensitivity

When an LP is available it can be used for final sensitivity measurement of the receiver by adjusting it near the calibrated frequency setting indicated on the receiver. Then adjust the LP tuning control for maximum indication on the receiver output meter and note the input signal level necessary to obtain the rated receiver output (as indicated by the output meter). Disregard the small amount of dial error on the LP because it is merely being used for sensitivity measurements under this condition.

Typical Navy receivers which may be aligned by this method include RAL, RAO, RBB, RBC, RBH, RBS and TCS.  
—*ServLant Monthly Bulletin*

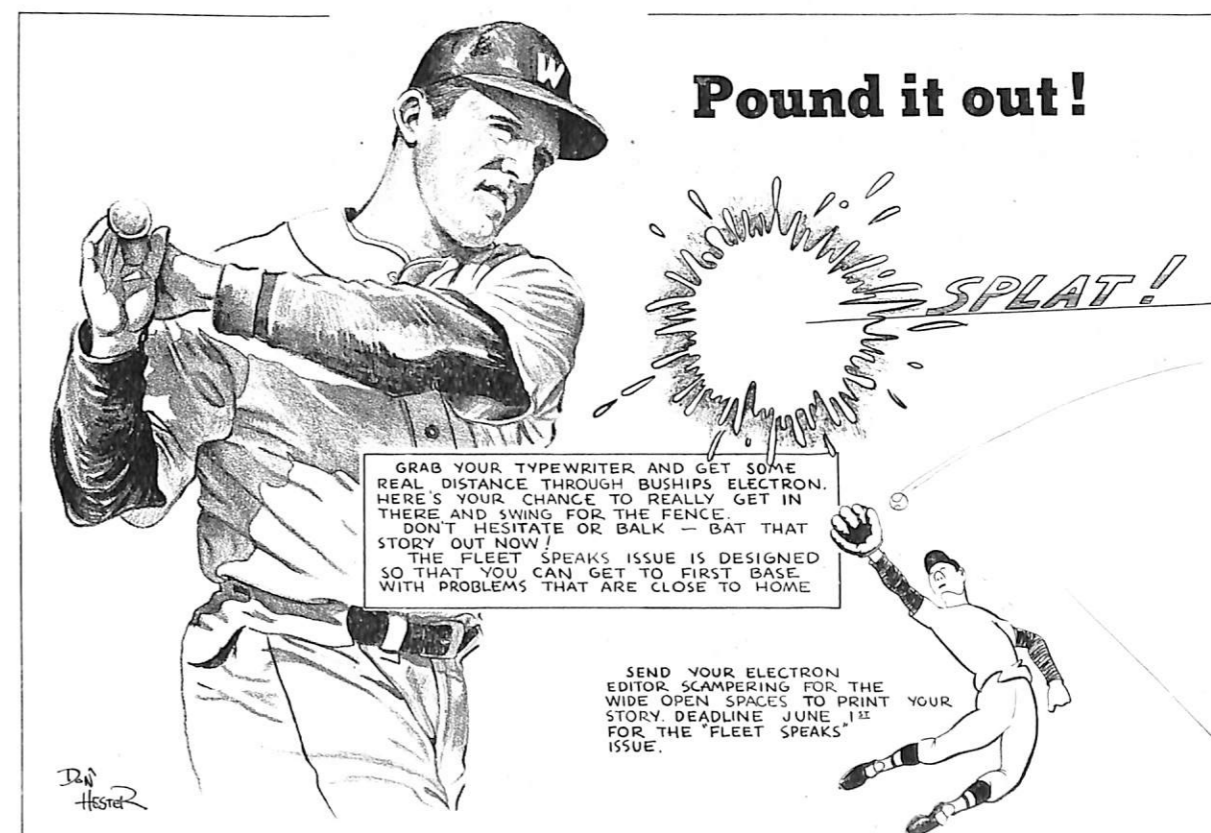



# Soldering Miniatures

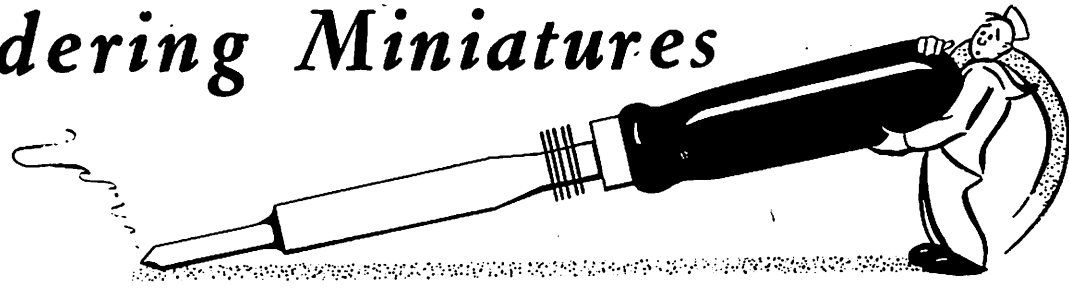

Overheating of small carbon composition resistors during the soldering process can cause permanent changes in nominal resistance. In the past this did not present a very serious problem. Resistors were large physically and terminating leads were long. Recently, however, following the general trend towards miniaturization and lightness, the physical dimensions of resistors have de-

being approximately equal to the product of the iron temperature and the application time. For example, tests have shown that a joint requiring two or three seconds' application of the iron at 400° C. will require about 15 seconds' application at 200° C. Iron temperatures below 200° C. will not make a good soldered joint. Tinning action is poor and the solder is apt to pile up rather than penetrate into the joint. Also, the use of a small iron is not the answer to the problem. Miniature irons operate at about the same temperature and heat the resistor just as much as the larger ones, although their thermal capacity is much less. Low temperature soldering involves the use of special solders and fluxes and cannot be used in equipments subject to any considerable temperature rise during operation. Overheating of resistors during soldering can be avoided only by restricting heat conduction along the terminating leads.

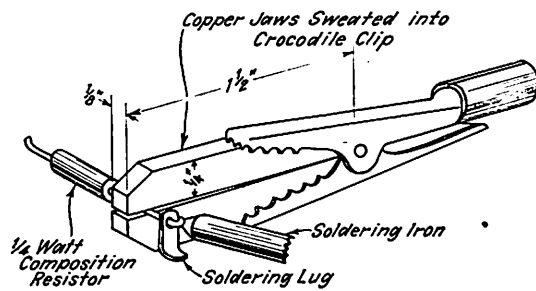

FIGURE 1—Details of clamp type shunt.

creased greatly and the space limitations in the small compact equipments are such that the terminal leads must be made very short. Under these conditions the application of a soldering iron close to the body of the resistor is almost certain to cause overheating, with consequent change in resistance which may easily exceed the working tolerances.

## Theoretical Considerations

Heat can be transferred from a hot body to a cold by three means: conduction, convection and radiation. During the soldering process conduction plays the major role, the heat from the iron passing along the terminating lead to the body of the resistor. Therefore, the thermal conductivity, cross-sectional area, and length of the lead are important. The quantity of heat which the resistor is capable of dissipating (by radiation and convection) is determined by its surface area and permissible temperature rise under continuous loading, that is to say, its wattage rating.

## Practical Considerations

A satisfactory soldered joint requires a minimum quantity of heat before it becomes effective, this quantity

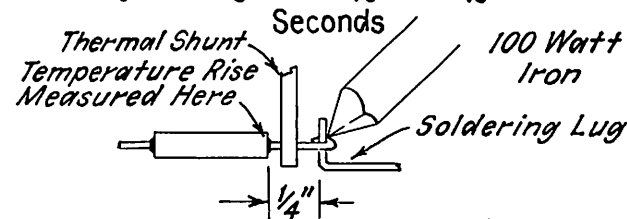
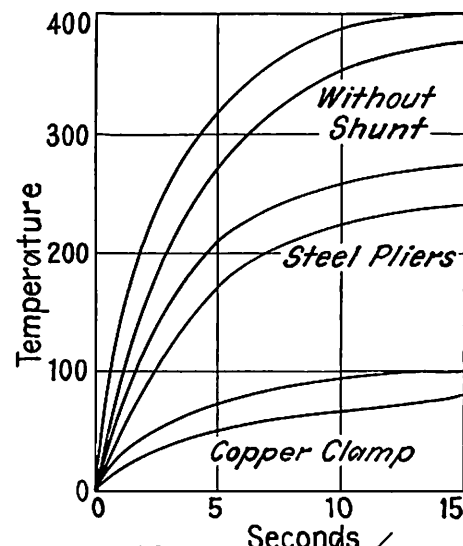

FIGURE 2—Effect of thermal shunts on temperature rise of composition resistor.

## Theory of the Thermal Shunt

If it is accepted that heat reaches the resistor for the most part by conduction along the terminating lead, then it should be possible to restrict this heat flow by means of a thermal shunt in the same manner that a sensitive meter is shunted when used in a series circuit carrying a heavy current. For such a thermal shunt to be effective it must have good thermal contact with the lead between the body of the resistor and the iron. It must have a thermal capacity several times greater than the resistor it is to protect. Lastly, it must have a large dissipating surface of the proper finish for disposing of the absorbed heat by radiation and convection processes.

The simplest method of providing a thermal shunt, and one used by many technicians, is to grip the lead between the resistor body and the lug with a pair of long-nose pliers while soldering. A big reduction in resistance variation is achieved in this way, as can be seen by reference to Figure 2. For general-purpose occasional work the pliers method is fairly satisfactory, but it does have certain disadvantages. The pliers have to be held while making the joint and the operator would tend to release them at the same time that he removed the iron, thus permitting unrestricted flow of heat into the resistor body from the still molten joint (see Figure 2). It is rather awkward to solder with one hand. Finally,

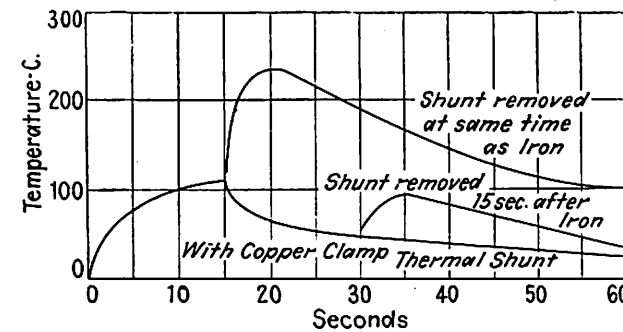

FIGURE 3—Resistor cooling curves.

steel does not fill the requirements for good conductivity and high thermal capacity necessary in a thermal shunt.

The best shunt material is copper, and the best construction is one of the clamp type which is self-holding and can be left on for fifteen or twenty seconds or until the joint cools. A good thermal shunt can be made easily by sweating small copper bars into the jaws of an ordinary alligator clip, as shown in Figure 4.

## Use of the Thermal Shunt

A shunt should be used during each soldering operation involving a miniature component. This applies not only to resistors but also to any circuit element likely to be damaged by excessive heat such as small capacitors, choke coils on polystyrene forms, and wire-ended crystals. The risk of damaging a component increases with

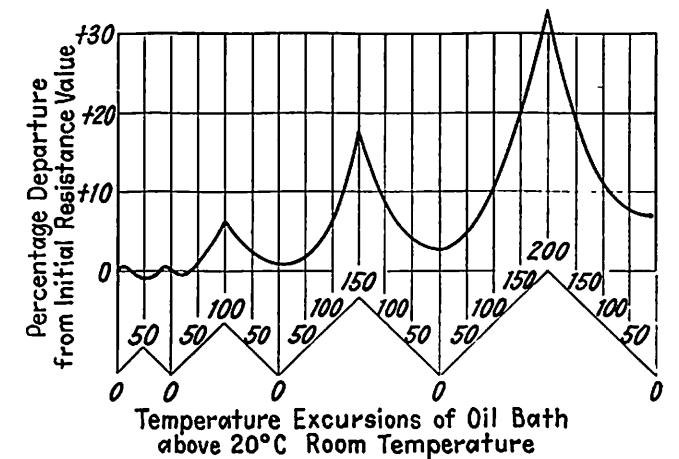

FIGURE 4—Changes in resistance as a result of overheating. Data for this curve were obtained by immersing the resistor in an oil bath to raise the temperature and allowing it to cool down to room temperature after each excursion, in order to determine the permanent effect of heating.

the time required to make a satisfactory joint. This time may be reduced by pretinning the lug and leads before making the joint and by using a fairly hot iron. Size of iron is also important. If accessibility is adequate, a standard 100-watt iron may be used. In tight places a miniature iron can be used, but it should be remembered that while the temperature of the miniature iron is only slightly lower than that of the standard iron, the thermal capacity is much less. If the lug is large and has a wire wrapped around it in addition to the terminating leads, the thermal capacity will be quite high and it may be impossible to supply the quantity of heat required, resulting in a cold joint. The shunt should be placed so that it is as close to the resistor body and as far away from the joint as possible. It is essential to insure that the clamp does not contact both the resistor and the joint, as it would then provide a low-impedance path for the flow of heat from the iron. It has been found that a distance of 1/16 inch from the lug to clamp is sufficient. In order that the copper-clamp thermal shunt shall maintain its effectiveness in use, it is necessary to keep the jaws flat and parallel and free from grease, dirt and flux so that good contact between the clamp and the terminating lead is insured. The face of the clamp adjacent to the iron should be kept bright to minimize heat transfer by radiation, while the rest of the clamp should be matt black to assist heat loss.

—Digest U. S. Naval Aviation Electronics

Send your problems to the Editor of BUSHIPS ELECTRON. He will solve them for you and print the answer in "Letters to the Editor". See Page 19 of this issue for examples.

## MODEL SV SERVICING NOTES

### Rep-Rate Setting

Setting rep-rate on the Model SV to the correct 400 PPS can be readily done by turning fine control to MAXIMUM and setting scope sweep to 60 cycles; then set control to show 7 pips from test sync jack, or 420 PPS MAXIMUM. A gain of 1200 yards in ringtime was obtained on one system after this adjustment.

### Transmitter 5000-Volt Supply

Troubles in the Model SV transmitter 5,000-volt supply using the carbon plate type 371-B rectifier tube show as symptoms:

1—Jittery voltage reading on position 7 of the test meter.

2—Variations from 4,000 to 5,000 volts.

3—One of the 371-B tubes showing a considerable amount of color.

These have been traced, in all cases, to a loose plate cap on the 371-B tube. The cap on the carbon plate tubes is soldered to the lead-through wire and this soldered connection is either poor or intermittent when the tube is new or develops this condition with use.

## AVAILABILITY OF F.C. NO. 1—QHBa AND F.C. NO. 1—QHB-1

### QHBa (ASW Vessels)

Referring to the Receiver-Transmitter (CAN-43073) shown in Figure 7-17 of Model QHBa Instruction Book (NAVSHIPS 91125), ALNAV 45-50 warned all personnel against failure of the phenolic-headed push rod to operate switch S-707 and to discharge the capacitors when the lower door is opened. This warning was amplified on Page 21 of the August issue of the ELECTRON magazine, (NAVSHIPS 900,100).

Replacements for the phenolic-headed rods in the form of all steel rods are now available for equipments serials 1 through 172 inclusive, on surface vessels under SNSN F16-M-384501-866 and are described in NAVSHIPS 98198. The kits are stocked at:

Philadelphia Naval Shipyard  
Norfolk Naval Shipyard  
Boston Naval Shipyard  
Charleston Naval Shipyard  
Mare Island Naval Shipyard  
Ships Supply Depot, Naval Supply Center,  
Oakland

### Low or Intermittent Magnetron Current

Occasionally a condition of low or intermittent magnetron current shows up in the SV transmitter. When this happens, check R(2)18 which is mounted on the magnetron mounting bracket. Connect an ohmmeter across this resistor and heat the body of the resistor with a soldering iron. In some cases this meter shunt dropped from its normal 6.25 ohms down to a value of 2 ohms.

### Arcing or Overheating of 5D21 Tubes

Here is another case of meter shunt trouble. With the SV transmitter ON TIME control adjusted to 170 ma, the four 5D21 tubes started to arc and get hot. It was found that the meter shunt R(2)24 had changed enough to give an error of 35 ma. Since this happened to be on the high side it meant that the 5D21's were adjusted to an ON TIME current of 205 ma which was causing the aforementioned arcing and excessive plate dissipation. Unless a resistance bridge is available, this meter shunt is difficult to check because its normal value is 0.625 ohms, 2% tolerance. This is not the only reason for arcing or hot 5D21's but it is one of the factors that must be taken into consideration when this trouble is encountered.

Ships Supply Depot, Naval Supply Center,  
Norfolk

Ships Supply Depot, Naval Supply Center,  
Pearl Harbor

### QHB-1 (Submarines)

Referring to Model QHB and QHB-1 Instruction Book (NAVSHIPS 900,976(A) and NAVSHIPS 98197, Field Change No. 1—QHB-1 applies to equipments serials 1 through 19 inclusive on submarines. The new steel rods are stocked under SNSN F16-M-384501-867 at Ships Supply Depot, Naval Supply Center, Norfolk and the Ships Supply Depot, Naval Supply Center, Oakland.

## INSULATION RESISTANCE OF SHIPBOARD COAXIAL LINES

The insulation resistance of solid dielectric or air dielectric coaxial lines as installed and not terminated by any equipment (but including connectors attached) should be over 100 megohms as measured with a 500-volt megger or megohmmeter such as Navy Model OCV or Type P (Standard Navy Stock Number G17-I-702).

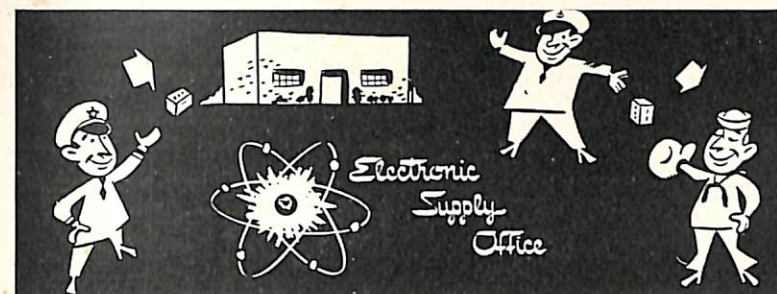

## ALLOWANCE LIST PROGRAM

Commencing February 1951, the Bureau of Ships delegated to ESO responsibility for preparing allowances for part of the active fleet. These allowances constitute an integral part of the Shipboard Integrated Electronic Maintenance Parts System, which provides for the conversion of ships to the bin stowage of electronic parts and the identification of these by Standard Navy Stock Numbers.

In conjunction with this program, BuShips has also given ESO the responsibility of maintaining, printing and distributing Stock Number Identification Tables. The principal purpose of the SNITS is to provide a means of identifying material. Employing the SNIT, the electronics technician determines the stock number of the item needed for replacement by cross-referencing the circuit symbol number in the instruction book and on the SNIT to the appropriate Standard Navy Stock Number.

The SNITS also are employed as the tools to enable the obtaining of Standard Navy Stock Numbers for materials contained in spare parts boxes aboard unconverted ships. Over 900 different types of Stock Number Identification Tables have been printed and are ready for use.

In the preparation of designated allowances, ESO is mechanically providing spare parts stock record cards for designated active fleet ships being converted. These cards are sequenced for easy handling, and contain stock number and noun name information.

## FLOATING ELECTRONICS WAREHOUSE

Are you short some hard-to-get electronic maintenance part 'way out there at sea, Mate? Well, maybe you won't have to send stateside for it after all, because who knows? Maybe the ELECTRON will float right up to your ship and you'll have all the maintenance parts you need.

Of course, we don't mean this magazine; we're referring to the Navy's new floating electronics warehouse, the USS *Electron* (AG-146), a converted LST.

This vessel, the recent commissioning of which has

given added impetus to the Navy's concept of mobile supply for vessels in the Active Fleet, has relinquished her load of tanks in favor of row upon row of neatly stock-numbered bins containing more than 20,000 different electronic items for the servicing of ships in forward areas. Chances are you'd find exactly what you need in the *Electron's* carefully selected stock. The *Electron* is the first floating electronics warehouse to be commissioned but hold on, Mates—there'll be more.

Many of the smaller and more commonly used electronic items are stowed in bins in the forward part of the tank deck for greater accessibility, while items too bulky for bin storage are stowed amidships in the after portion of the *Electron's* tank deck.

Definitely not an accumulation of guesses, this stocking system for the "floating warehouse" is the progeny of much careful research and statistical analysis. The *Electron's* inventory is in close agreement with all that is known to date regarding frequency of use, failure rates (a function of average life), and available space.

The electronics technicians and storekeepers aboard this ship have received special instruction in the implementation of current programs of Electronic Supply.

## BREAKDOWN PROGRAM

The Bureau of Supplies and Accounts has authorized the continuation of the Breakdown Program at SSD, NSC Oakland, NSD Bayonne and SSD, NSC Norfolk. Approval was granted in view of the tremendous advantages incident to the breakdown operation. Through this program, many items in spare parts boxes have been identified by Standard Navy Stock Numbers. The binning and reporting of these has made available large quantities of material to satisfy system-wide requirements—with considerable saving to the Navy.

Through recent Bureau of Ships' action, approximately 25,000 additional spare parts boxes were made available for breakdown. All East Coast boxes now made eligible through the Bureau's action will be processed by SSD, NSC Norfolk. The West Coast portion of these will be broken down by SSD, NSC Oakland.

# E.S.O. MONTHLY COLUMN

## PROTECTING EXPOSED R-F CABLES AND CONNECTORS

The following notes are being added to installation plans which contain instructions for installing exposed radio-frequency solid coaxial cables (except teflon) and should be followed where no other specific instructions are issued:

Material Specification Grade or Class	Obtain From	Ordering Information	
		Standard Navy Stock Number	Size
Insulating Varnish JAN-V-1137 <sup>1</sup> Type N Grade CA	GSSO	G52-V-1240	1 pint can
		G52-V-1245	1 quart can
		G52-V-1255	1 gallon can
		G52-V-1260	5 gallon can
Dielectric Compound AN-C-128 (Dow Corning #4)	ESO	N52-C-3096-790	8 oz. cartridge
	ASO	R52-C-3109-110 R52-C-3107-125	8 oz. cartridge 10 lb. can
Synthetic Resin Tape 17-T-28 Type VF (Vinyl)	GSSO	G17-T-1745-60 <sup>1</sup>	3/4 in. width <sup>2</sup>
		G17-T-1745-200	1 in. width
		G17-T-1745-250	1 1/4 in. width
		G17-T-1745-300	1 1/2 in. width

1—A smooth, thin and uniform film of dielectric compound should be used only on

- (a) Cable plugs and jacks
- (1) on gaskets
  - (2) outside the cable jacket where the clamping nuts will seize cable
  - (3) all threads exposed during assembly
- (b) Adapters—only on exposed threads.

CAUTION: Do not fill voids with dielectric compound unless specifically called for in the installa-

## MODELS TEB AND TEC BIAS CIRCUIT MODIFICATION

The "bias" indicator on the Models TEB and TEC transmitters is located in the common supply circuit of the bias plate transformer and the low power supply transformer. In this location the light, when not energized, indicates only that the common supply circuit is inoperative. The prime function of the "bias" light is to indicate presence of d-c bias voltage for the PA tubes of the transmitter. Naval Radio Station, Annapo-

tion instructions. To do so will adversely affect the electrical characteristics.

2—Electrical Insulating Varnish—JAN-V-1137 Grade CA should be painted on the outside of all assembled connectors to a point at least 4 inches from each connector, after wiping off any excess dielectric compound.

3—After the varnish has dried, cover the entire varnished areas with several layers of Type VF (vinyl) synthetic resin tape with a 50% overlap between turns.

4—For teflon cable installations see RE 62F 2000—Shipboard Installation Teflon Cable High Temperature

<sup>1</sup> Formerly 52-V-13.  
<sup>2</sup> Preferred size.

Use (included in NAVSHIPS 900,153—Standard and Guidance Plans).

Attention is again invited to the necessity of using Armor Clamp MX-564/U with the UG-21/U, UG-22/U and UG-23/U series connectors when installed on armored cable.

The latest types connectors shall be used, especially in critical applications.

lis, has submitted a modification to the subject transmitters to cause the bias light to be energized only when this d-c bias is present. The modification consists of connecting the light and its series resistor from the junction of the bias bleeder resistors to ground.

The Bureau approves of this modification to be made on an optional basis.

## RMB PAGES "SL SERIES 3-i" AND "SL SERIES 3-ii"

The listing of RMB Page "SL Series 3-i" in Supplement No. 28 is incorrect. This page is in Supplement No. 20. Page "SL Series 3-ii" is a blank page.



# EDITOR

Continuing a new, and it is sincerely hoped, a permanent feature of your magazine—ELECTRON. This new feature is the answer to numerous suggestions and requests from fleet and shore personnel for a medium of presenting their individual problems, gripes and questions on electronics matters and obtaining answers to such queries. This section is not to be confused with the FORUM which has been a regular part of the ELECTRON since its inception in 1945. The continuance of this new feature depends entirely on you—the personnel in the field—since we must first receive correspondence from the field before we can search out the answers and print them. As a matter of convenience, it is suggested you write directly to:

Editor  
BU SHIPS ELECTRON  
Sir:

Concerning the components included in the signal circuit of two teletype machines hooked up for neutral operation, I have a question.

Why should the battery polarity have any bearing on the operation of the selector magnets, since according to the theory of electromagnetism, a field will be built up around the electromagnets (selector magnets), regardless of the polarity of the current through the coils, and theoretically, the selector magnets should operate equally well on currents flowing in either direction?

I have made inquiries of all personnel connected with teletype repair whom I have been able to contact, and so far have not been able to find an explanation of this phenomenon.

R. E. R., ET1

*The theory that you state about electromagnets is absolutely correct for the normal electromagnet. However, the selectors are equipped with POLAR electromagnets, which use a permanent magnet in conjunction with an electromagnet.*

*When the current through the electromagnet is such as to create a magnetic field of a polarity that adds to the magnetic field of the permanent magnet, the selector*

*The following is typical of the type of letters received to date for inclusion in this column:*

The Editor  
BuShips Electron  
Code 993  
Bureau of Ships  
Navy Department  
Washington 25, D. C.

*relay operates. When the current through the electromagnet is reversed, however, the magnetic field produced cancels the magnetic field of the permanent magnet and the selector relay does not operate.*

Editor

Editor  
BU SHIPS ELECTRON  
Sir:

Is it possible for me to get magazines concerning electronic instruments and equipment used on LST's and PC's? Although I know much of the basic theory of electronics, I would like to get something to read about these specific equipments.

C. E. M., Electricians Helper

*The Bureau of Ships is unable to issue electronic publications to individuals. Authoritative information is obtainable from the nearest Electronics Office. Also the individual LST's and PC's will have some publications aboard.*

Editor

Magnetic Amplifier Fundamentals

Continued from Page 5

3—Aging—If feedback units requiring rectifiers are used the life of the rectifier is the age determining factor. Modern dry type rectifiers, conservatively operated have a life expectancy many times that of a vacuum tube, and will stand considerably greater overload surges, and should not, once installed, require service or maintenance during a service life of at least five years. (The log book of the German cruiser "Prinz Eugen" shows that not one of the various types of magnetic amplifiers used on that vessel for gun stabilizers and servos, required servicing for a period of ten years.)

4—Frequency Limit—The upper frequency limit of a magnetic amplifier appears at the present stage of development to be about a half million cycles. It is assumed, without further investigation, that this limit oc-

60-cycle counterpart. The linearity and response time are also improved almost directly in proportion to frequency. High speed replacement units for vacuum tubes, however, indicate that they may be much smaller and lighter than equivalent vacuum tube circuits.

7—Cost—Initially, until mass production is established, these amplifiers will be more expensive than the components they replace. This is due not only to the necessity of absorbing part of the research cost in the first production units, but also to allow protection to cover any possible engineering problems that may develop in special applications. Indications are that once mass production is established magnetic amplifiers can compete in cost not only with electron tube components but with the cheaper electro-mechanical devices as well.

The uses indicated in the above list are but a few of the many applications. Not all of the magnetic amplifier

ous transmitters, receivers, etc. The reduction of vacuum tubes alone, by any device, is a consideration, when it is realized that the electronic equipment on a single BB today requires over 5,000 tubes, and the number is rapidly increasing. Storage space requirements for almost an equal number of spares is also a consideration.

The substitution of magnetic amplifiers for all mechanical regulating devices used on auxiliary power units supplying electronic equipment should be made mandatory, limited only to availability. These are relatively simple applications, and should be the first to be considered.

Lieutenant Commander A. M. Vincent, Code 815B, has been temporarily assigned to act as liaison officer between Electronics Design and Development Division, Naval research facilities and manufacturers, primarily to expedite special applications in design. It has been found that due to the limited research in subject matter, a lag of at least a year is encountered before a production unit can be placed in service. Any contemplated specialized application should be routed through Code 815.<sup>3</sup>

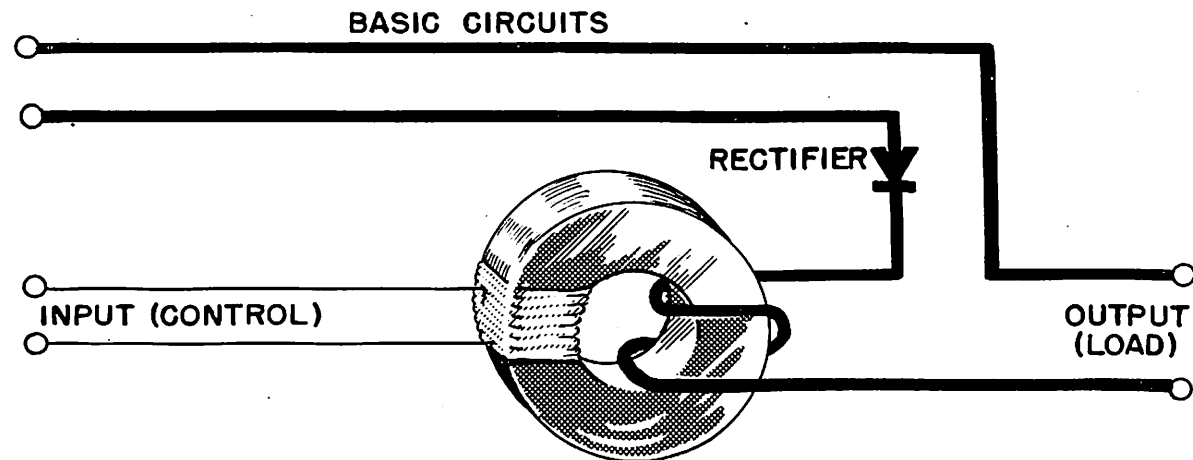

FIGURE 1—Basic principles of the internal feedback reactance type magnetic amplifier.

curs due to eddy currents within the core, or winding capacity effects or both; response of pulse repetition rates up to 400,000 per second have been obtained with time constants of one microsecond, using 3 Mc as excitation frequency.

5—Capacity—The capacity of the series saturated amplifiers currently produced are limited to around 10 kilowatts due to the size of the rectifiers. Shunt compound units have been built with capacities up to 50,000 kw. Theoretically there is no upper limit to power handling capacity of these amplifiers, likewise there is practically no lower limit. Magnetic amplifiers are capable of amplifying signals too weak to penetrate the emission shot noises of a vacuum tube.

6—Size—In many low powered applications the magnetic amplifier may be larger and heavier than competitive units. This is especially true in the 60-cycle components, where the size of the core is almost inversely related to frequency. For a given size, the 400-cycle amplifier would have about five times the capacity of its

applications mentioned are commercially available, as some are still in the experimental stage. Basic research on magnetostrictive magnetic amplifiers, oscillators and power units utilizing composite cores of nickel, iron, cobalt, in bridge circuits with permanent magnets for fractional saturation bias levels are now being studied for special applications.

Magnetic amplifiers should not be considered as a substitute for all tubes and relays in control and regulating circuits. Each application should be weighed and balanced against competitive installations. In certain installations, these amplifiers may actually be larger, heavier and less suited than other means. A magnetic amplifier should be considered only if its advantages outweigh its disadvantages when compared with competitive means.

Magnetic amplifiers should be considered for applications within their limitations for many types of equipments now using vacuum tubes, relays, rheostats, circuit breakers, meters, certain rotating devices, self-synchron-

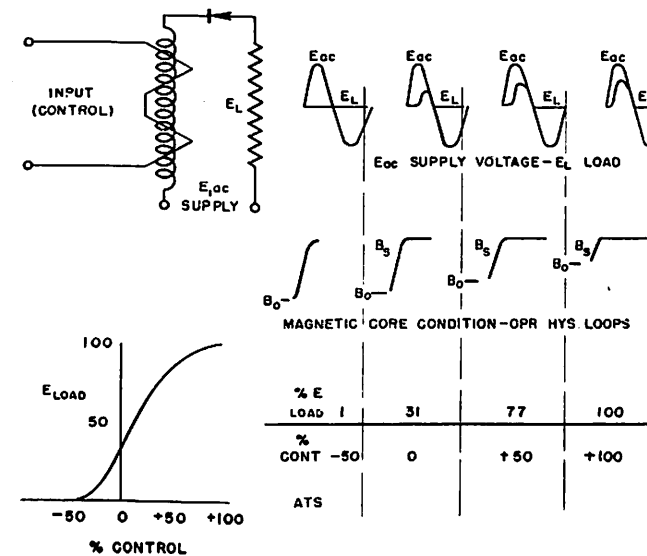
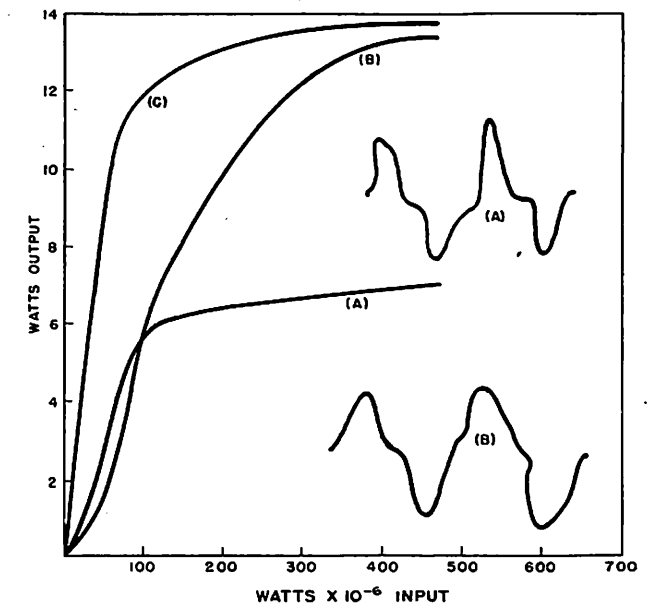

FIGURE 2—Operation of self-saturating half-wave magnetic amplifier load and supply voltages as functions of time.

Circuits

Figure 1 is a sketch showing the basic principles of the internal feedback reactance type magnetic amplifier. The core is made up of very thin washer laminations or toroidal wound ribbon of specially treated transformer iron alloy. The control coil usually consists of several hundred times the turns in the anode or power winding. The current in the control winding may be pure DC, half or full wave rectified AC, rectified pulses, or alter-

<sup>3</sup> End of material taken from the original memo.



FULL WAVE MAGNETIC AMPLIFIER CHARACTERISTICS OF 50% N-I ALLOY.  
(A) STANDARD ANNEAL  
(B) SPECIAL ANNEAL COLD REDUCTION  
(C) CRITICAL ANNEAL UNDER MAGNETIC INFLUENCE

FIGURE 3—Results of sharp saturation.

nating current. There is no (in single core Figure 1 there would be) transfer of energy between power and control windings. The rectifier in the load coil limits the flow of alternating current to only one direction thereby permitting the load source to assist the input field in controlling saturation. Thus the input control winding need supply only a fraction of the control power otherwise required. The net control force acting upon the core is then proportional to the algebraic sum of the ampere turns in both windings. The superimposing of a directional flux upon the core controls the point on the magnetization curve about which the a-c flux oscillates. The input signal coil thus acts essentially as a modulator of the inductance in the load circuit, increasing or decreasing its impedance, by controlled saturation in relation to the amplitude and frequency of the input signal or control current. Without the anode rectifier (often used) the control ampere turns would have to be equal to the load ampere turns plus sufficient ampere turns to saturate the core. This circuit shows a single core. Double cores connected inductively opposing, are usually used to improve the efficiency and wave form, and to cancel transformer action reflected into the control winding, except in certain instances where pure sine waves are matched with the error signals in the control winding. Figure 2 demonstrates the mode of operation, showing load and supply voltages as a function of time. Figure 3 shows results of sharp saturation—the wave of the special core unit is considerably more sinusoidal

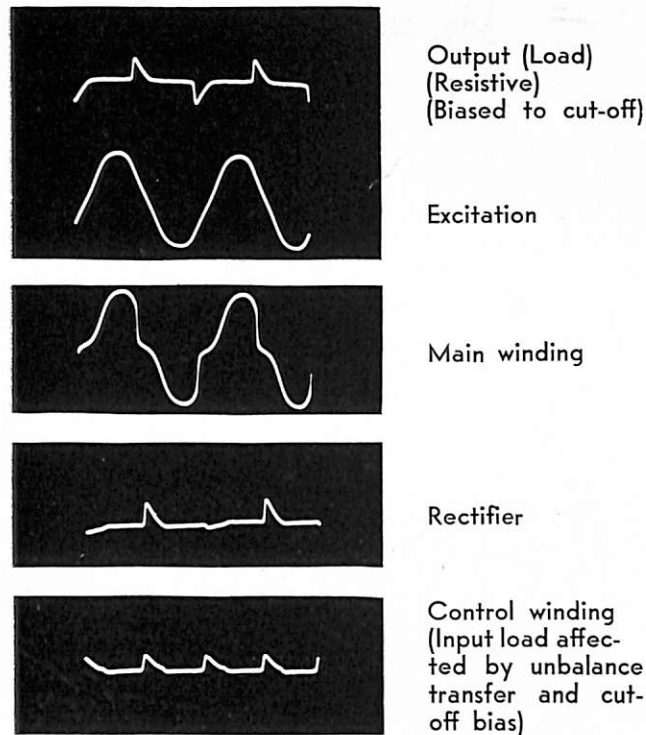

FIGURE 4—Voltage wave forms (low excitation).

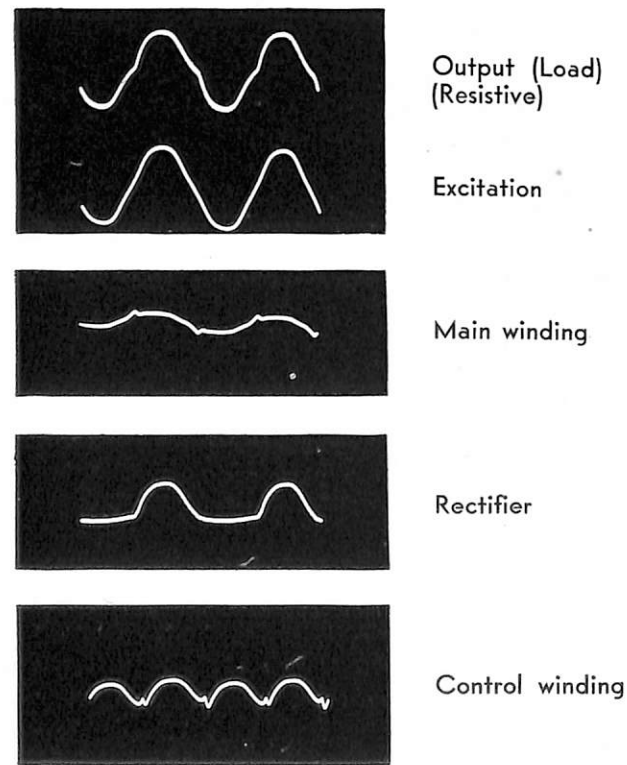

FIGURE 5—Voltage wave forms at saturation.

and the power amplification is much greater. Figures 4 and 5 show wave forms across various points when two biased half wave units (Figure 6) are connected in series across a bridge rectifier for full wave output. The short output peaks at low excitation are caused by the high cutoff bias.

Figure 7 shows different types of core patterns: (a) is a commonly used 3-legged core, (b) is a double core reactor, (c) is a continuous core, toroidal wound and (d) is a 3-phase core, controlled by a single control winding.

Figure 8 (a) is a schematic diagram of Figure 1. Figure 8 (b) is a simple saturable reactor without the internal feedback feature. Figure 8 (c) is a rough electro-mechanical effective equivalent of 8 (a) and (b). To simplify these sketches, core arrangements have been omitted.

Figure 9 shows conventional internal feedback power amplifier circuits with d-c output. The coils shown in Fig-

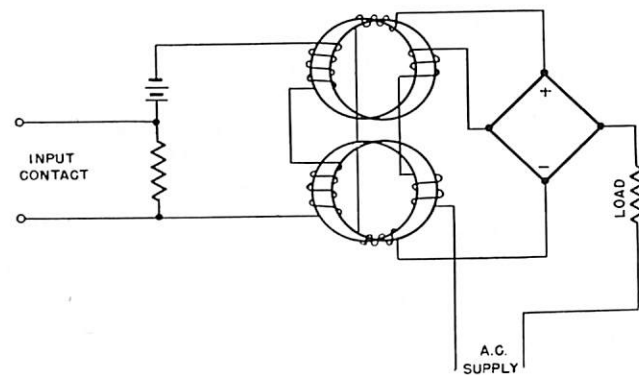

FIGURE 6—Full wave biased magnetic amplifier.

ure (9) (a) and (b) are basically the same as that shown in Figure (1). 9 (a) is used on single phase; 9 (b) on 3-phase Y connected. This circuit is probably the easiest to understand in that it operates similar to a full wave electron tube rectifier. Assuming the arrows were plates of an 80 type tube rectifier, and the other section the cathode. As the voltage builds up in the positive direction in either leg, current will start flowing through the corresponding rectifier alternatively through the load. This current is limited to a very small amount due to the large inductance of the winding. This reactance continues to be large as long as the core can store energy. When the core becomes saturated the impedance drops to about that of an air core coil, and the current rises to a large value. During the remainder of the cycle the current is limited by the load. The control winding

varies the amount of saturation, and consequently the output. The rectifiers in each control line maintain a directional relationship which assists the control winding in varying the saturation levels, which in turn increases the amplification for a given input. These coils of course, as are those of all magnetic amplifiers, are wound in inductive opposition to cancel any possible inductive reaction into the control coil. When these devices are used in highly reactive loads there may be a possibility of losing control. In this instance, another rectifier is shunted across the load, connected in the same polarity as the load rectifiers. This dissipates the stored energy in the inductive load. Resistors and capacitors could be used for this purpose but with a loss of efficiency.

Figure 10 shows one of the most universally used circuits. The output is AC with good wave form, power factor and efficiency.

Figure 11 is similar to Figure 10 except that the resonance effect between the a-c windings and capacitors is used to increase the gain. Amplifications of 10 to the 12th power have been obtained with one stage under laboratory conditions, using Mumetal as core material.<sup>4</sup>

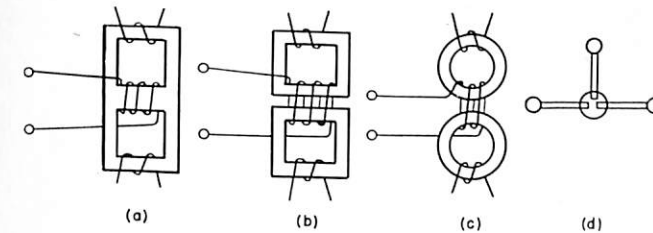

FIGURE 7—Different core patterns.

Considerably greater gains can be obtained using core material with a more vertical saturation loop. Theoretically if this power gain were additive, starting with a common carbon microphone output of 1 watt, one amplifier would be capable of controlling a large portion of the electrical power generated in the U.S. today. In laboratory tests using this circuit, signals of less than ten to the minus 12 watts were amplified to one kw. A stabilized push pull circuit should be used if very small inputs are to be amplified. This amplifier is suited mainly for high impedance loads. The amplification factor is many times that obtained with bridge or center tapped circuits. This is accomplished with little sacrifice of response speeds. This circuit is sometimes referred to as a "voltage doubler". The resonance effect is very important in this equipment but will not be reviewed here since it is available in other publications.

<sup>4</sup> See Item No. 4 in the bibliography.

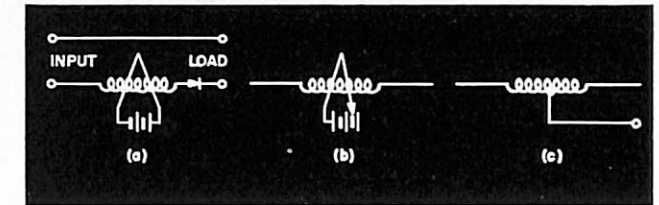

FIGURE 8.

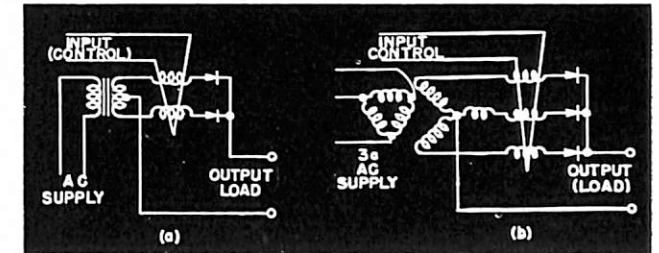

FIGURE 9—Internal feedback power amplifier circuits with d-c output.

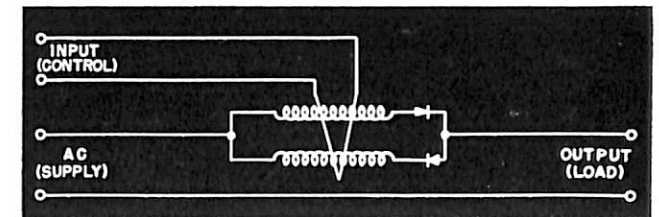

FIGURE 10.

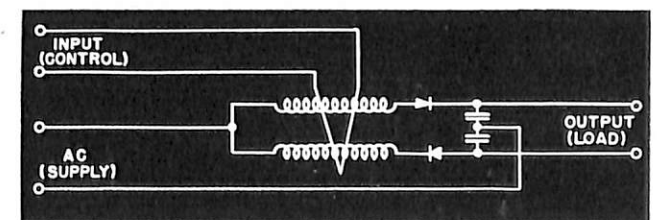

FIGURE 11.

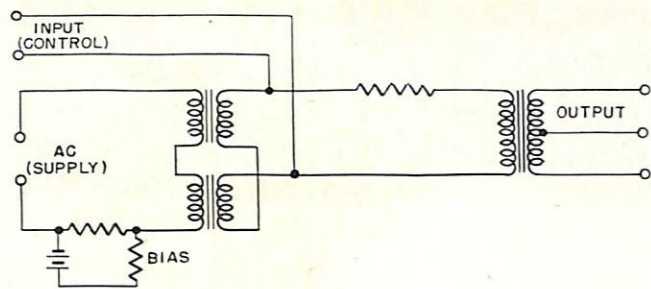

FIGURE 12—Voltage amplifier.

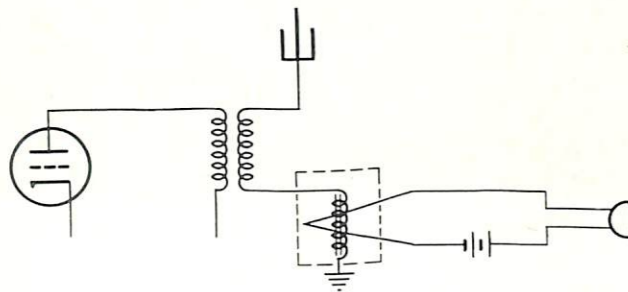

FIGURE 13—Magnetic amplifier used as an r-f modulator.

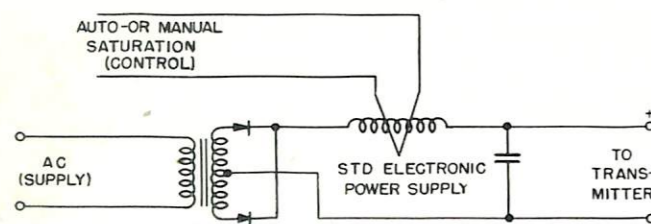

FIGURE 14—Swinging choke.

Figure 12 is a voltage amplifier.<sup>5</sup> The input may be a slowly varying DC or AC. The output is a replica of the supply voltage. The amplitude and phase depend upon the potential and polarity of the input. Voltage gains up to 10 million per stage have been obtained with this circuit. The operation of the amplifier is described as follows: The a-c power source energizes two toroidal coils whose primaries are connected in series aiding, and whose secondaries are connected in series opposing. The two coils are balanced so that when the d-c signal is zero, the net voltage across the output terminals is zero. That is, the voltage induced in the secondary of the left-hand coil is equal in magnitude and opposite in phase to that induced in the secondary of the coil on the right.

If, however, a d-c signal is applied, it has the effect of producing a magnetic bias in opposite directions on the two cores. This results in an unbalance of the flux in the two cores. Therefore, the a-c voltages induced in the two secondaries are no longer equal and a resultant a-c voltage appears across the output terminals. This particular magnetic amplifier is described in a U.S. patent as a variable flux range transformer, to be distinguished from the variable mutual type transformer. The amplifier is in a field by itself, often used in connection with magnetic loops.

Figure 13 is a schematic diagram of the magnetic amplifier used as an r-f modulator over a decade ago. This unit consisted of two coils wound over a special core. The heavy coil carried the RF, and the light coil, with a greater number of turns, carried the microphone current. The variation of carbon current, changed the impedance of the antenna current path to ground in proportion to the amplitude and frequency of the input. This unit was used to a limited extent during the first world war, and by amateurs in the 1000-kc band shortly after, until the more efficient tube modulation system became popular. At HF, of course, this device would act similar to a condenser. Most of the RF would short

<sup>5</sup> See Item No. 2 in the bibliography.

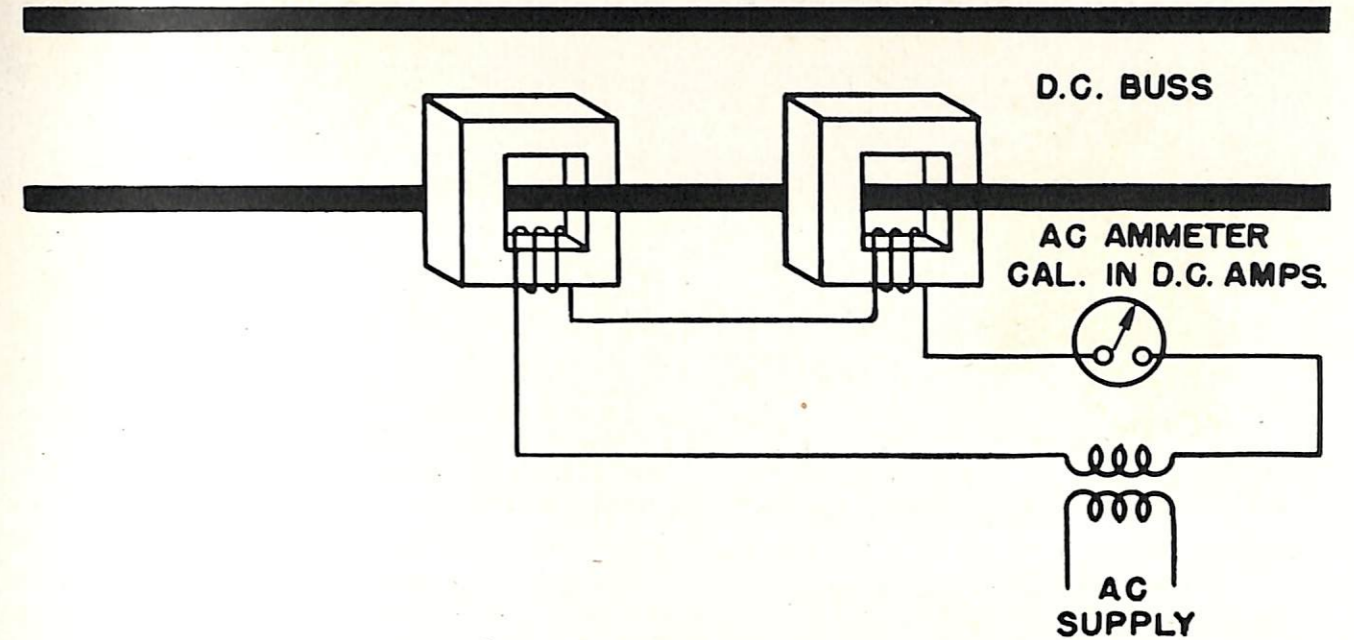

FIGURE 15—Swinging choke of Figure 14 used as a current transducer.

circuit to ground, without being acted upon, unless special precautions were taken. The HF application covers a wide field and is beyond the scope of this article. Figure 14 is a swinging choke, another device often used by amateurs in small radio transmitters to improve the voltage stability. Under key down conditions, the increased current tends to saturate the core, producing a condenser input effect, thus raising the voltage. An auxiliary winding is shown which could be added to balance this regulation for a more uniform output. Due to the series rectifiers which cause unidirectional flux conditions, this would be classified as a self-saturating (internal feedback) device with provisions for original saturation (DC) control.

Figure 15 shows the principles of using this device as a current transducer.<sup>6</sup>

Figure 16 shows conventional amplifiers with bridge type rectifiers. These circuits are basically the same and are usually the first to be evaluated for application. They are simple and do not require a transformer. They operate well into either resistive or inductive loads without a reactive protecting device. The disadvantages are mainly that they provide only a rectified d-c output, use more rectifiers, and do not isolate the load from the power source. These circuits provide a good wave form. The efficiency and the stability are also high. Figure 16 (b) may also be series connected. (Series considered superior for high speed response). 16 (a) operates the same as 16 (c) the series rectifiers simply being on the opposite ends of the coils.

<sup>6</sup> See Item No. 3 in the bibliography.

FIGURE 16—Conventional amplifiers with bridge type rectifiers.

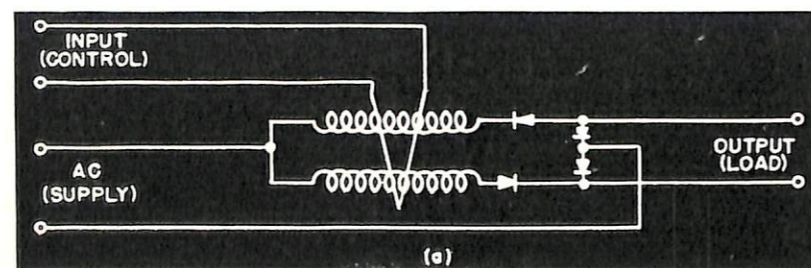

FIGURE 16 (a).

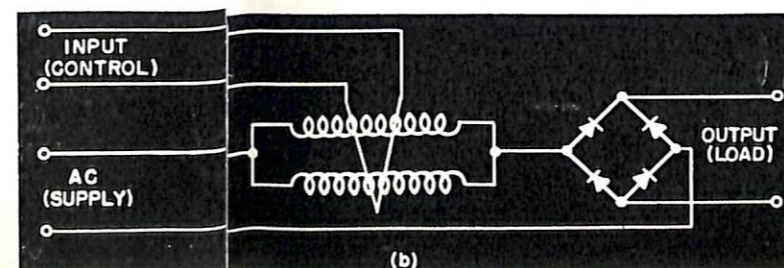

FIGURE 16 (b).

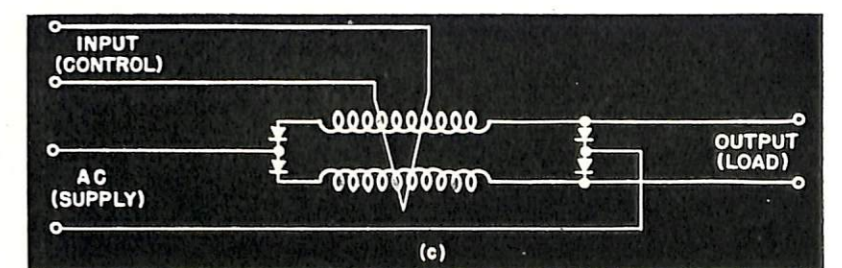

FIGURE 16 (c).

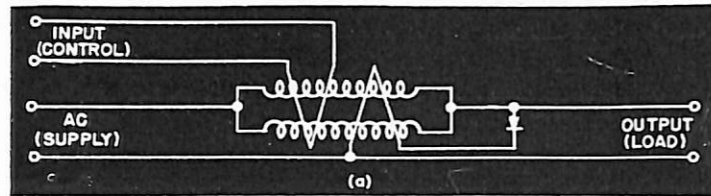

FIGURE 17 (a).

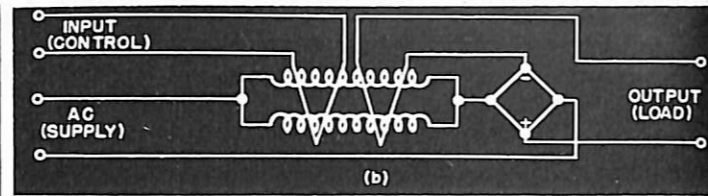

FIGURE 17 (b).

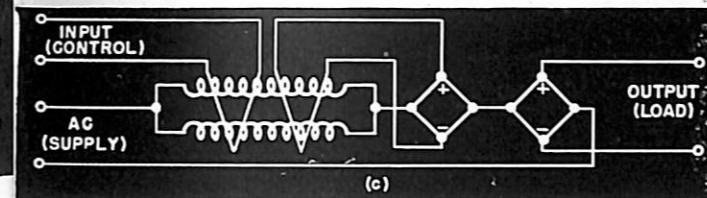

FIGURE 17 (c).

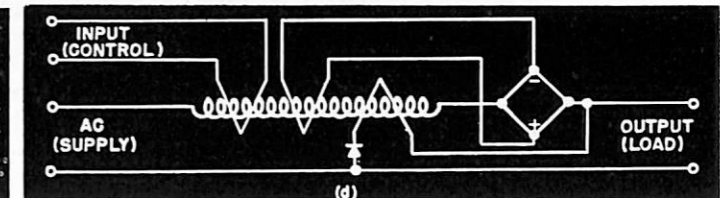

FIGURE 17 (d).

Figure 17 shows conventional feed back circuits. 17 (a) is a sketch drawn originally for school purposes showing how this amplifier can be used without the load power passing through the rectifier and still obtain self saturating action for special purposes. This is actually an "external feedback circuit". The feedback coil may be connected opposing or aiding determined by requirements. This connection is occasionally used in conjunction with other windings as an auxiliary stabilizing influence connected as a bridge circuit. A reactor utilizing this principle in part, has been used to control 50,000 kw. This is the same circuit shown in Figure 29 for HF. 17 (b) shows a unit with series or external feed back. 17 (c) is another multiple arrangement found in a toy train control unit. 17 (d) is similar but without shunt load

feed, found on a d-c lathe motor. Feedback circuits are usually divided into two basic types namely, "internal" and "external." The internal feedback type is that type in which the rectifier is placed in series with the load winding of the device in such a manner that the low current will be unidirectional through said winding so as to cause unidirectional flux to exist in the core linking said winding. External feedback refers to feedback generated by feeding back some of the final controlled output to either the load or control coils. (17) (b) is an example of a series external load winding.

The circuit of Figure 18 is commonly used for variable speed reversing drives where excitation to the generator is varied from zero to maximum in either direction. The polarity and amplitude of the input control signal determines the speed and direction. The two rectifiers across the field absorb the inductive peaks that may react back into the amplifier. Without control excitation the current in each generator field is equal, but in opposite direction, resulting in zero flux. The polarity and amount of unbalance of the generator fields determine the directivity and velocity of the reversing motor being supplied by this generator. The drive motor is usually of the permanent field type.

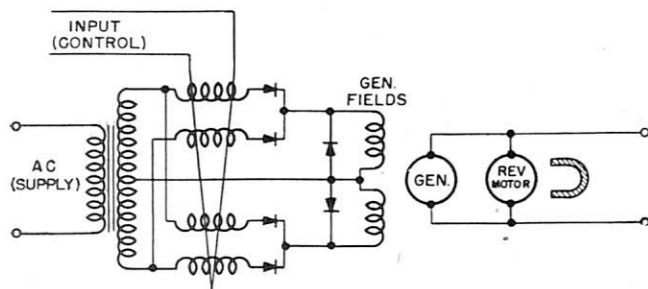

FIGURE 18—Variable speed reversing drives.

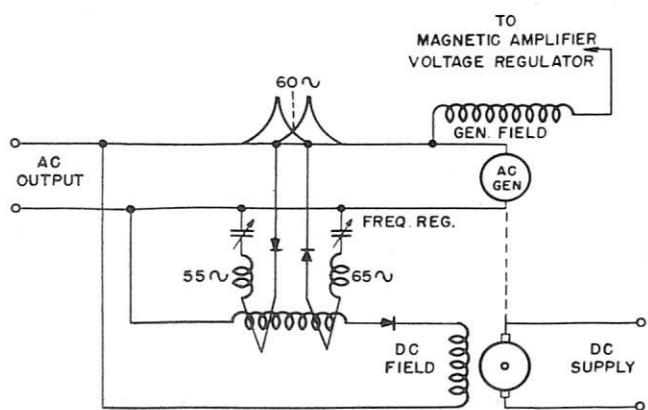

FIGURE 19—Figure 18 used for frequency control.

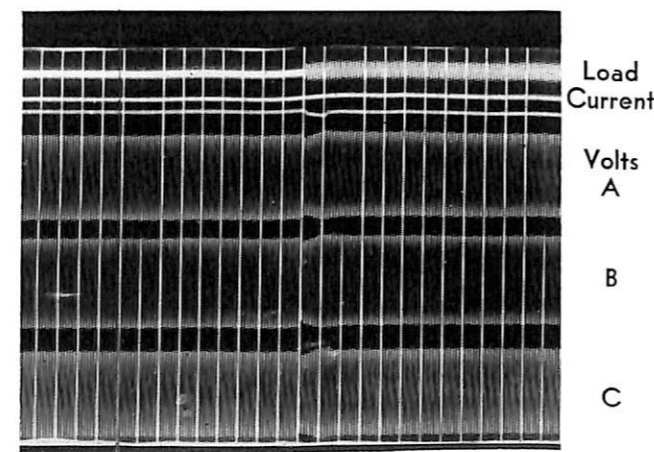

FIGURE 21—Oscillograph patterns of output wave forms from a 100-kw submarine generator controlled by magnetic amplifiers.

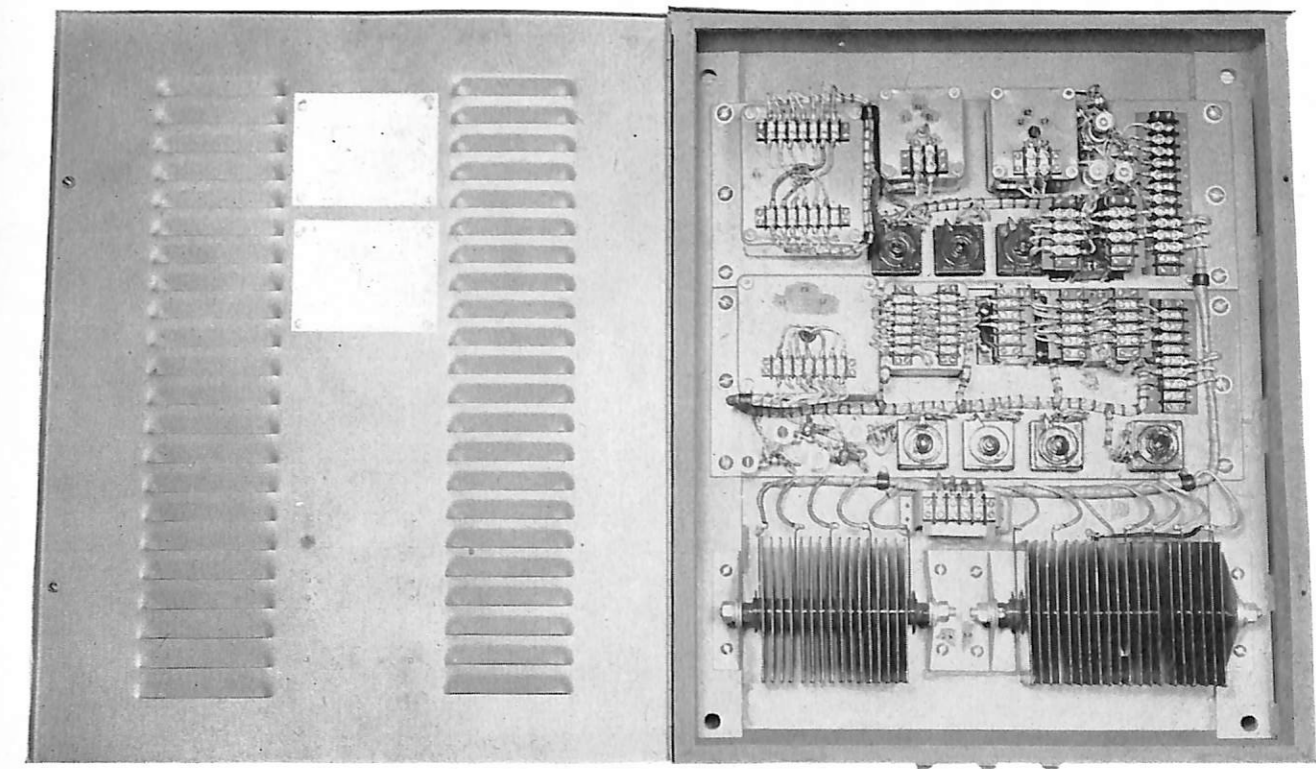

FIGURE 20—D-C motor speed regulator and a-c generator voltage regulator combined in one cabinet.

DC to the control windings. Figure 20 shows a commercial regulating unit incorporating both voltage and frequency control. Figure 21 contains oscillograph patterns of output wave forms from a 100-kw submarine generator controlled by magnetic amplifiers utilizing the above principles. This generator maintains frequency under all load conditions within 1/4 of 1%, with a d-c input variation from 175 to 350 volts. Output voltage

regulation is maintained to within 1/2 of 1%. Frequency sensitive relays are also being manufactured using this principle. When generator speeds are to be precision controlled for ship synchronous timing instruments and

Figure 22 contains schematic diagrams showing the general principles of operation in servo applications—Two or more stages with multiple control coils are usually required in actual installations.

The operating characteristics of one 400-cycle production unit are as follows:

Velocity error coefficient	1/32 sec. max.
Slewing speed (maximum)	60 deg/sec.
Static error	1/10 deg.
Corner freq.	8 cycles per sec.

22 (a) is a basic sketch of a d-c drive servo system, while 22 (b) and (c) are a-c schematics.

Figure 23 is a photograph of a rectifier type servo

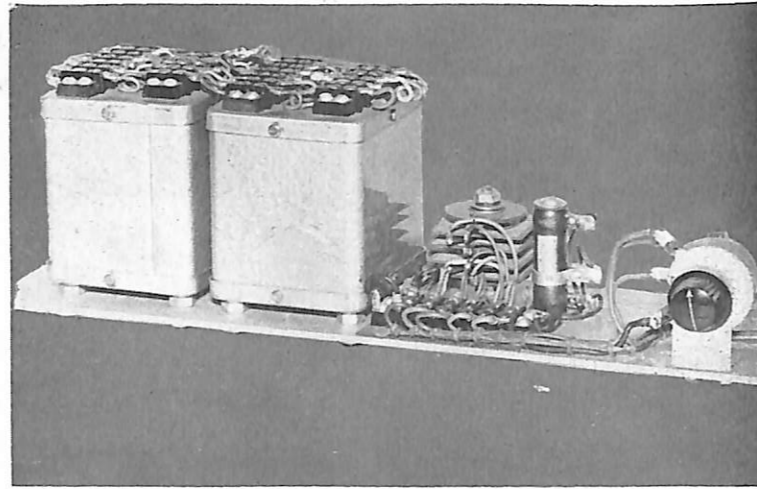
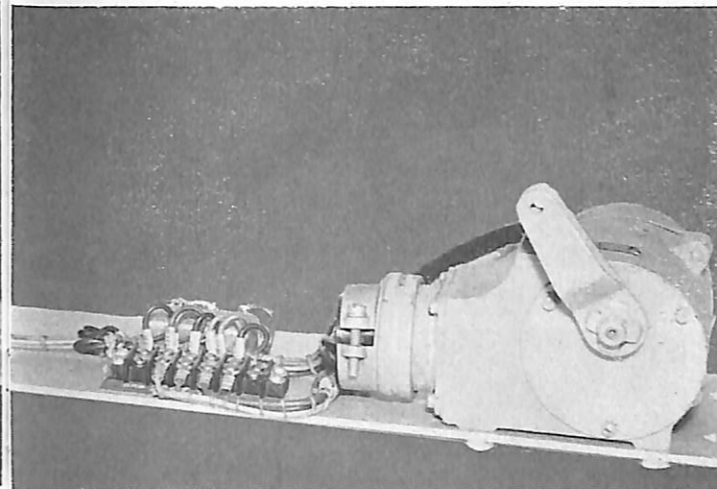

FIGURE 23 — Rectifier type servo complete with



actuator developed for airborne application.

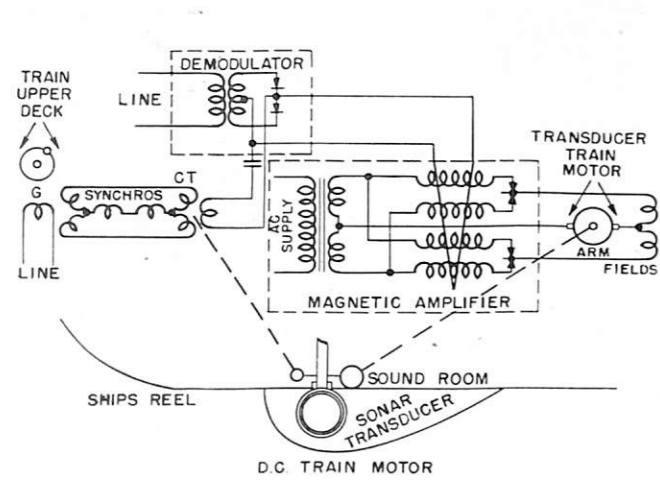

FIGURE 22 (a).

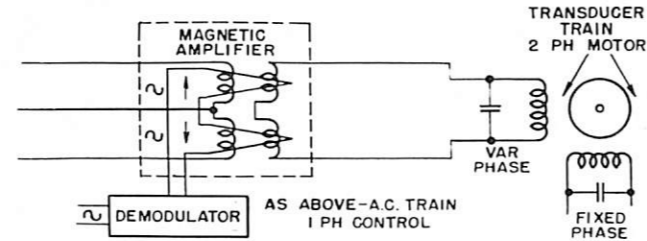

FIGURE 22 (b).

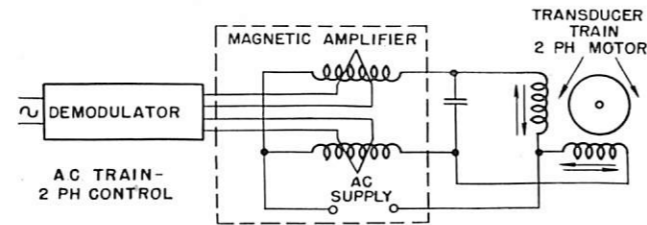

FIGURE 22 (c).

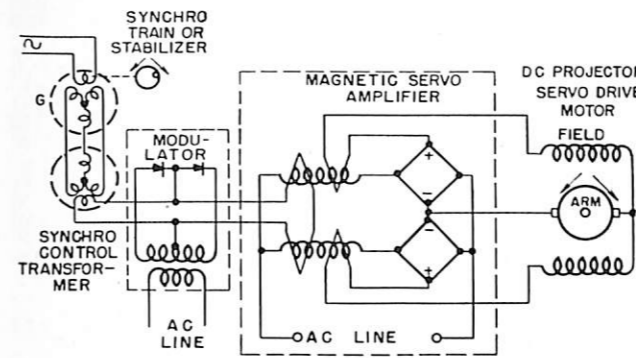

FIGURE 24 (a).

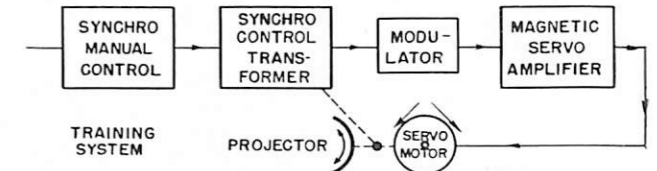

FIGURE 24 (b).

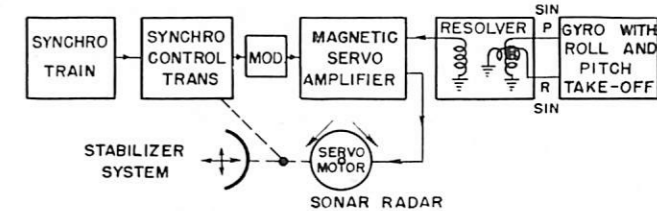

FIGURE 24 (c).

FIGURE 25 (a)—Thyratron training control.

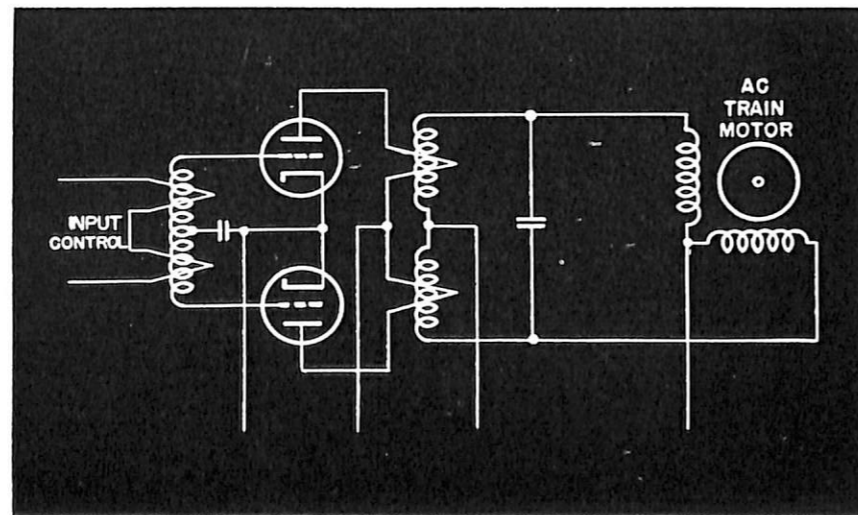
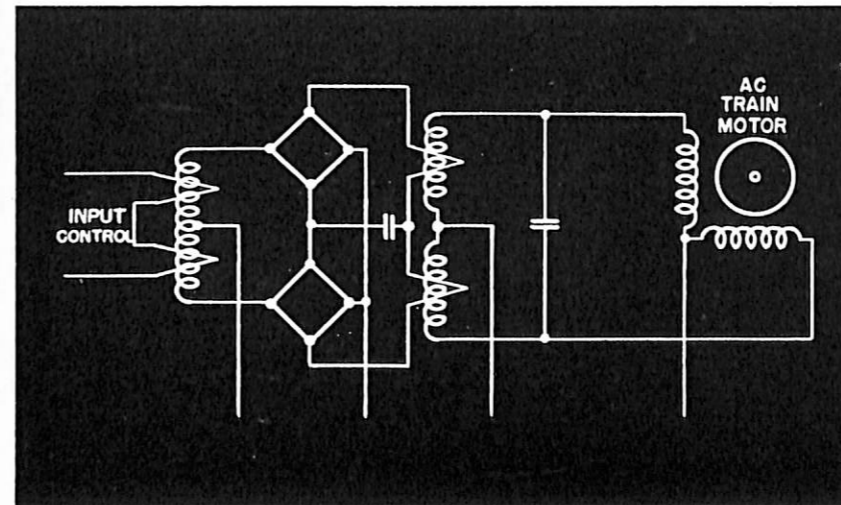

FIGURE 25 (b)—Figure 25 (a) modified for magnetic amplification.



complete with actuator being developed for airborne applications.

Figures 24 (a), (b) and (c) show stabilizer applications.

Figure 25 (a) shows a standard thyratron training control.

Figure 25 (b) shows the same circuit modified for magnetic amplification. This is a relatively simple conversion as most of the components designed for the thyratron will also match the magnetic amplifier. This conversion can almost be simplified to the extent of providing a rectifier adapter to plug into the thyratron sockets.



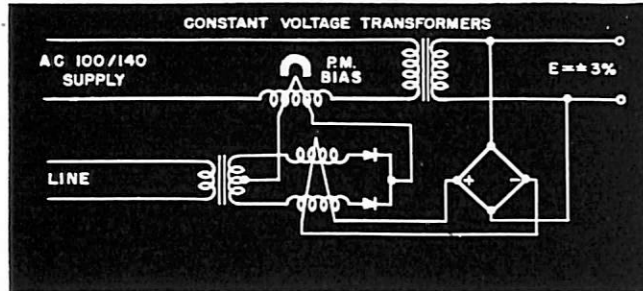

FIGURE 26 (a).

Figure 26 shows principles used in voltage control applications.

26 (a) shows a two-stage magnetic amplifier application using a permanent magnet to maintain a reference bias.

26 (b) is a single stage obtaining some gain advance from a non-linear regulating device.

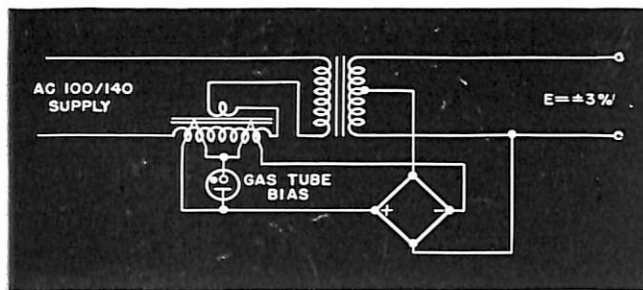

FIGURE 26 (b).

26 (c) obtains regulation by comparing the d-c output to the p.m. reference a-c input.

26 (c) obtains regulation by comparing the d-c output to the p.m. reference a-c input.

26 (d) is identical to (c) except for the power coil bias.

26 (e) has voltage regulation which in this instance,

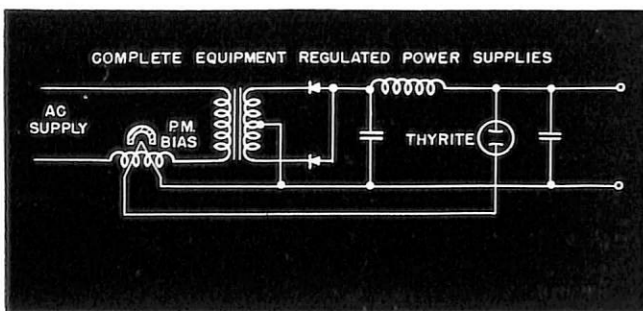

FIGURE 26 (c).

applies only to the plate supply—the filaments (if used for electron tube equipment) are not controlled. This application is basically the same as that shown in Figure 14. The swinging choke in this instance is automatically controlled by the gas tube or other reference device. When the output voltage rises, the current in the feedback control coil also increases. This control coil is

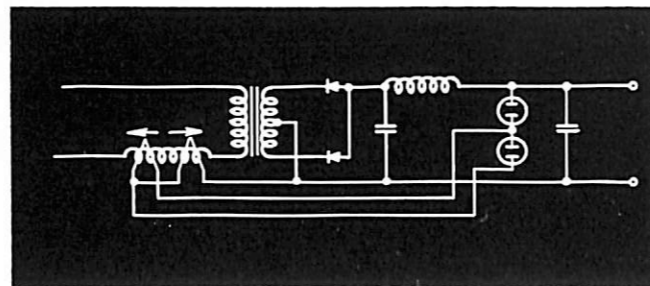

FIGURE 26 (d).

connected so as to oppose the natural saturation of the rectifier load, which in effect transfers the output condenser back and forth from the opposite sides of the choke. In other words when the core is saturated the filter supply becomes condenser input which normally would increase the voltage output.

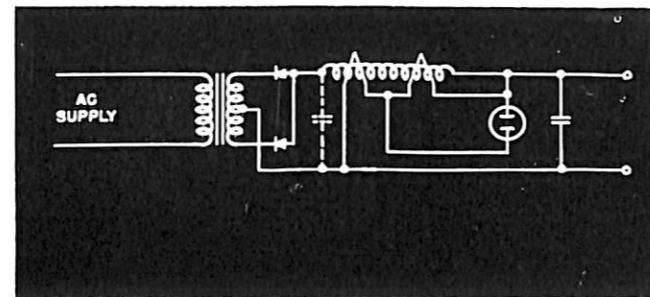

FIGURE 26 (e).

26 (f) is an automatic amplifier regulator found in a European telephone exchange. Coil A maintains a reference voltage. Coil B is across the voltage being regulated. Coil C is the self exciting winding. A slight difference in current relationship between A and B will have a marked effect on the impedance of the main reactor, consequently the d-c output voltage will change until the relationship is again equalized. Since the voltage across A is constant, the current in winding B, and

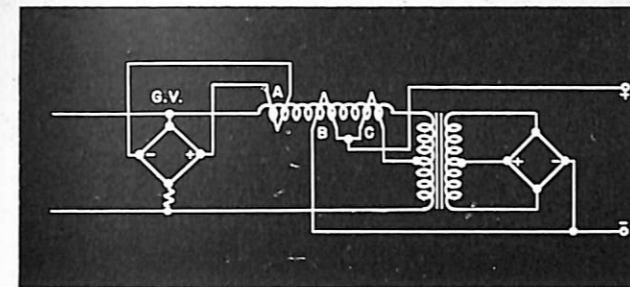

FIGURE 26 (f).

hence the output voltage will also be maintained constant.<sup>7</sup>

26 (g) and (h) show the fundamentals of voltage controls applied to conventional generators. The principles of operation are similar to the transformer controls previously described.

Figure 27 is a schematic diagram of a circuit used to

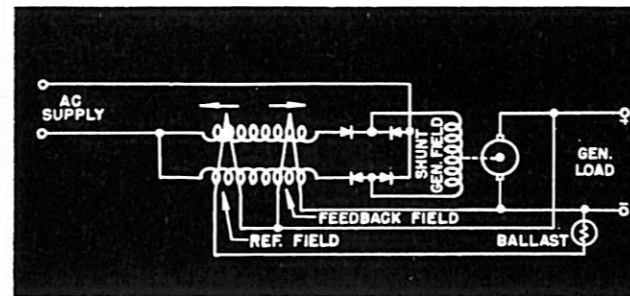

FIGURE 26 (g).

synchronize pump strokes. This circuit is also applicable to many other types of training equipment.

Figure 28 is a schematic diagram of a reactor drive-A spring-loaded bellows type differential pressure pickup mechanically coupled by a positive drive to a synchro

<sup>7</sup> See Item No. 16, bibliography.

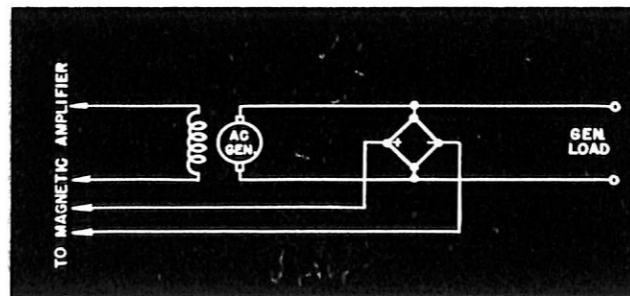

FIGURE 26 (h).

which provides the error signal. Error signal is rectified by a small selenium rectifier and applied to the coils of the saturable reactor. The pickup can provide 10 watts of saturable d-c power for pressure errors of 3 or

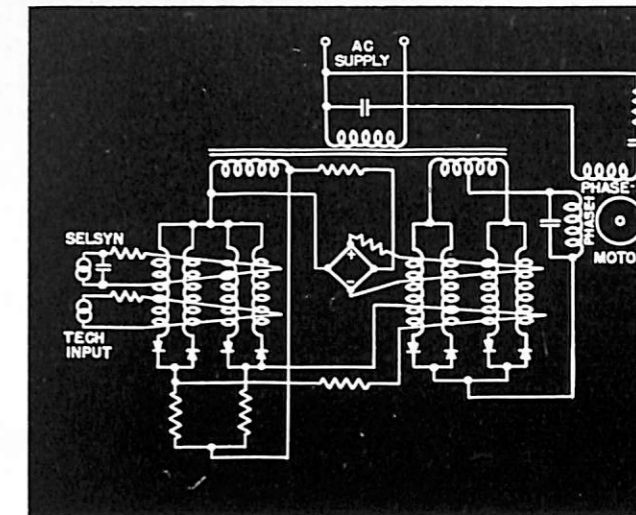

FIGURE 27—Magnetic amplifier used for pump stroke synchronizer on the DD-828.

4 psi. The current transformer connected in series with one leg gives a voltage in proportion to motor current, which is rectified and applied to the control coil which

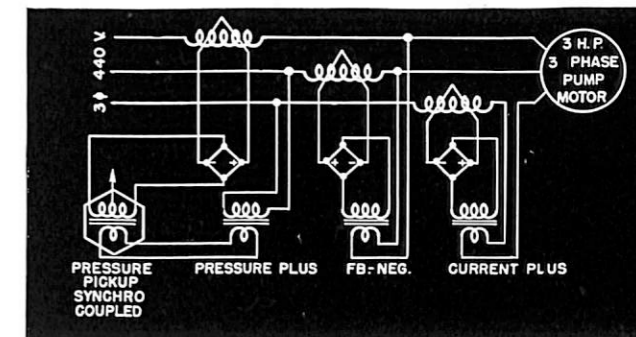

FIGURE 28—Prototype constant pressure pump.

increases saturation at low speeds. A third transformer is connected across two of the motor terminals, rectifier and feed back as negative feed back. This prevents the reactors from losing control and also prevents hunting. This device is functioning with a pressure accuracy of 2 psi and free from oscillations over the entire flow range at pressures between 150 and 200 psi.<sup>8</sup>

<sup>8</sup> See Item No. 11, bibliography.

(to be concluded in our next issue)

## GCA REPORTS

Navy GCA units have logged over 400,000 approaches, including many "saves" of lost or disabled aircraft. Behind the success of the GCA program is its outstanding record of reliable service. A summary of GCA maintenance reports for the past twelve months reveals that GCA units were inoperative due to the equipment failure for less than *six hours* for every *one thousand hours* that the equipment was energized. This excellent service record does not come about by chance. Dependability was planned into the GCA system and is "paying off". The following features of the GCA program will indicate how it is being done—today.

1—A major portion of the electronic equipment in the system has been duplicated in the form of two channels. Under normal operating conditions one channel is maintained in an operating state while the other is held in standby. In the event of failure of the operating channel, the standby channel may be switched into the circuit and emergency repairs made without loss of control or operating efficiency.

2—GCA units are equipped with one LF, three HF and three VHF communication units. GCA can receive anywhere between 2.0 and 9.0 megacycles and transmit 2.0 to 18.1 megacycles, and also transmit and receive 250 to 500 kilocycles. Should reception be poor on VHF the operator can transmit simultaneously on VHF and MHF if requested to do so by the pilot. Remember all that is required is that the aircraft have a receiver in operating condition.

3—GCA units have three back up sources of power. The prime mover carries two deisel generator sets, each of which can supply the complete load, and a transformer and regulator so that 110-volt or 220-volt station power can be used when available.

4—GCA equipment includes a spare parts truck which serves as a complete field repair shop for the unit. An extensive inventory of parts are carried with the unit and repairs and maintenance can be performed when necessary in a matter of minutes and seconds, during actual operations.

5—GCA operation requires constant performance under rigorous conditions and the necessity of maintaining control over approaching aircraft without interruption. The time for maintenance is before a breakdown. Complete periodic checkout and maintenance schedules have been established for each unit. Skilled maintenance personnel pursue a rigorous program of continuous checking, detecting, analyzing and replacing and correcting defective or improperly functioning parts and circuits. The "Ounce of Prevention" for GCA units means an average of *546 hours of preventive maintenance for every 1000 hours* that equipment is energized.

6—The Navy has set up GCA overhaul centers at the Mare Island and Philadelphia Naval Shipyards. All units are periodically scheduled for complete overhaul at one of the two yards. The units are completely stripped and then reassembled and field checked before being placed back in an operational status.

7—The Navy employs field engineers whose primary job is troubleshooting GCA units. These engineers stationed at the overhaul centers, are on call at all times to travel to any field GCA unit which develops troubles beyond the scope of the assigned personnel. In addition, these engineers give each unit complete annual check-outs in the field.

8—GCA not only has the equipment but it has the men of the caliber required to maintain the high operational standards required. All personnel are specially trained and qualified in their respective duties in GCA operation. By CNO directives, only graduates of the GCA School, at Olathe, Kansas are authorized to operate and maintain GCA equipment.

GCA's record shows that it is **READY, WILLING** and **ABLE** to assist you. Get to know your GCA Unit—the unit assigned to your station. The personnel will welcome the opportunity to acquaint you with GCA. They will be glad to show you the equipment and demonstrate how it works. They have a GCA operational film they will screen for you and a specially prepared manual for your use. Let them show you what GCA can mean to you. Fly GCA approaches, feel it out for yourself. Your GCA Units stand ready to serve YOU. **YOU CAN DEPEND ON GCA!**

## On the next page . . . . .

"This kite is to be raised when a thunder-gust appears to be coming on. . . . As soon as any of the thunder clouds come over the kite, the pointed wire (fixed to the top of the kite) will draw the electric fire from them, and the kite, with all the twine, will be electrified, and the loose filaments of the twine, will stand out every way, and be attracted by an approaching finger. And when the rain has wetted the kite and twine, so that it can conduct the electric fire freely, you will find it stream out plentifully from the key on the approach of your knuckle. At this key the phial may be charged; and from electric fire thus obtained, spirits may be kindled, and all other electric experiments be performed, which are usually done by the help of a rubbed glass globe or tube, and thereby the sameness of the electric matter with that of lightning completely demonstrated."

—Benjamin Franklin's letter to Peter Colinson,  
Oct. 19, 1752.

# the FLEET SPEAKS

RESTRICTED

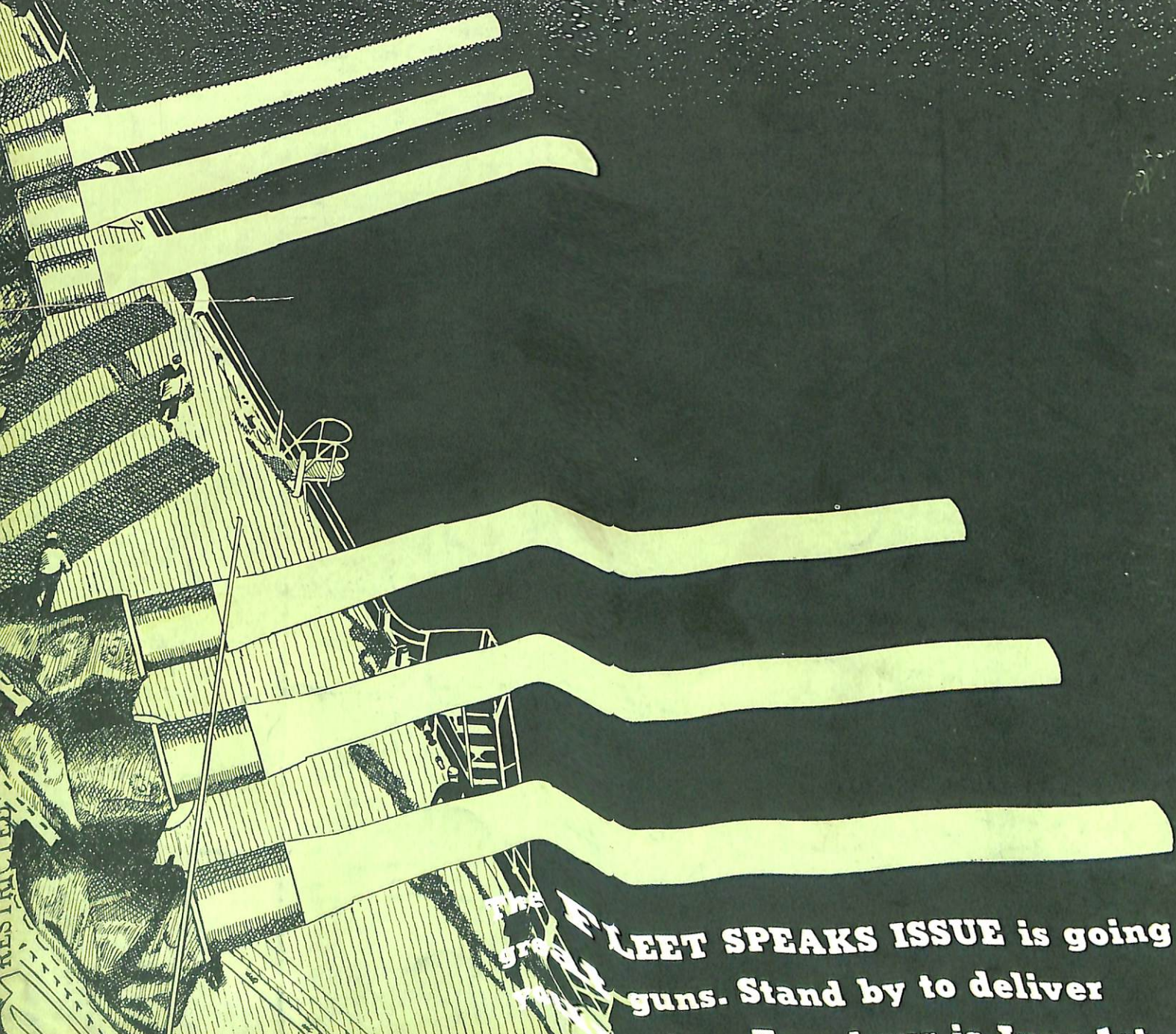

The **FLEET SPEAKS** ISSUE is going  
guns. Stand by to deliver  
Zero hour is June 1st.