

CHAPTER 7

LOS SYSTEM DESIGN

This chapter includes simplified procedural steps for establishing a LOS system to satisfy certain communication requirements between two points. The curves and nomographs are based on theoretical and empirical results; such readily predictable factors as free-space loss may differ from the calculated amount because of peculiar local conditions, and one cannot predict results exactly, because so many variables exist. However, by applying the methods and procedures presented here, an operational system may be successfully designed, installed, and operated.

Procedures for designing a LOS communications circuit can be organized into four major steps: determination of basic system requirements; analysis of proposed system configuration to determine path length, frequency, and optimum site location; prediction of system performance based on type of equipment used, path length, and required channel capacity, and actual installation procedures.

7.1 SYSTEM REQUIREMENTS

The first step in planning a LOS system between two given site locations is clarification of system requirements. The following questions should be answered:

- o Will the link be used for voice, teletype, or high-speed data transmission?
- o What is the required channel capacity?
- o What is the minimum acceptable reliability?
- o What carrier frequencies are available to be used?
- o What is the required system availability?

With the answers to these questions, the system designer can select a basic transmitter and antenna as a first approximation.

7.2 SYSTEM CALCULATIONS

Before system predictions can be attempted, certain system calculations must be made to determine operating parameters peculiar to the particular system. System design is a process of balancing system gains with system losses to provide a minimum usable signal (MUS) at the receiver. The system losses are Free-Space Loss, Coupling Loss, and Miscellaneous System Losses. System gains are Transmitter Gain,

Antenna Gain, and Diversity Gain. Such things, therefore as path length and receiver sensitivity must be known. Methods for determination of these parameters are presented in the following paragraphs.

7.2.1 System Losses

a. Free Space Loss. The attenuation (L_{FS}) between two isotropic radiators (in dB) is:

$$L_{FS} = 37 + 20 \log D + 20 \log f \quad (7-1)$$

where D = distance (in statute miles)

f = frequency (in megahertz)

The requirements for true Free-Space Loss to be realized as presented in Equation 7-1 are:

- o No large obstacles intervene between the antennas along an optical line-of-sight.
- o No alternate transmission path can be followed by a substantial fraction of the radiated energy.
- o The intervening atmosphere has a constant index of refraction so that no bending of the wave occurs at the frequency used.
- o The intervening atmosphere does not absorb energy from the wave at the frequency used.

These conditions are closely approximated for the case of LOS systems where the total loss can be considered to be Free-Space Loss. For the case where the receiver is beyond the line-of-sight, an additional loss called Scatter Loss must be added to the Free-Space Loss.

b. Miscellaneous Losses. There are always losses associated with transmission lines, duplexers, etc. To allow for these losses in system design, a figure of 4 dB is usually given for systems using 1 kHz and using waveguide, and 6 dB is used for 2 kHz systems which use waveguides.

If the transmitter is more than 100 feet from the antenna, add to the miscellaneous loss additional transmission line losses.

7.2.2 Minimum Usable Signal (MUS)

When system losses have been calculated, system gain requirements must be evaluated to determine optimum system design based on requirements. The minimum usable

signal, MUS, is a minimum signal level at the receiver input terminals which will provide a usable receiver output signal. The present state-of-the-art is such that a receiver output may be provided even if the transmitter signal is not received at the antenna. (Output will be developed from galactic, man-made, and thermal noise.) At LOS communication frequencies, galactic and man-made noise are of little consequence and are not considered in system calculations. However, thermal noise developed in the antenna and receiver input section, receiver generated noise, and a margin of signal-to-noise ratio required for FM threshold detection must be analyzed in developing the system design. The relationship of these factors is:

$$\text{MUS} = \text{thermal noise} + 10 \log \text{ of the receiver} \quad (7-2)$$

bandwidth + receiver noise figure + FM

threshold value carrier to noise.

It has been determined that thermal noise is evenly distributed throughout the microwave spectrum and equals KT watts per hertz of bandwidth where:

$$K = \text{Boltzman constant, } 1.37 \times 10^{-23}$$

$T =$ Effective temperature in degrees Kelvin (for a typical

microwave application 80° F , which equals 300°

Kelvin, is used)

Thus noise power = 4.10^{-25} watt or $KT = -204 \text{ dBW}$ per Hz of bandwidth.

Since thermal noise is continuous and equal throughout the spectrum, a wider bandwidth will "see" more noise and subsequently require a higher minimum usable signal at the receiver input to overcome this noise. This factor is accounted for in the MUS calculations (Equation 7-3) by the second factor (10 log of the receiver bandwidth). In LOS systems this is usually a significant factor since bandwidth may be several MHz. The receiver front end will contribute noise to a system also, and this is accounted for in the third factor in the formula: receiver noise figure; high quality maser and parametric amplifiers will introduce as little as 2 dB noise; with more conventional vacuum tube amplifiers, the figure may be 8 to 12 dB. For an FM system the threshold level (fourth factor in Equation 7-3) is defined as the received input power which produces about a 10 dB RMS signal-to-noise ratio; to provide this margin the MUS must be increased by 10 dB. Using these factors, then, the MUS becomes:

$$\text{MUS} = -204 + 10 \log \text{ BW} + \text{RNF} + 10 \text{ dB} \quad (7-3)$$

where BW = bandwidth

RNF = receiver/noise figure

7.2.3 System Gains

When system losses have been estimated, and the minimum receiver signal requirements established, system design parameters to provide the necessary gains must be calculated.

- a. Transmitter Gain. The gain of a power amplifier transmitted is given by:

$$G_{TR} = 10 \log \left(\frac{P}{1} \right) \text{ dBW} \quad (7-4)$$

where P = RF power output in watts

Note that in order to standardize the system calculation, all gains are determined in dBW (1 watt = odBW reference).

- b. Antenna Gain. Antenna gain is determined by:

$$G_A = (20 \log f + 20 \log D_A - 52.6) \text{ dB} \quad (7-5)$$

where G_A = antenna gain over an isotropic radiator in dB

f = frequency in megahertz

D_A = diameter of reflector in feet

c. Diversity Gain. To minimize the affects of fast fading, the designer may use a form of diversity. The fast fading (multipath) phenomenon does not affect signals of different frequency or over different paths in a correlated manner. To reduce the overall affect of rapid fading, a diversity scheme can be used, whereby two or more essentially non-correlated signals are combined to produce a signal which is freer of fades than any individual signal. All types of diversity require the use of additional receivers and various other equipments; however, it is economical to use diversity on LOS systems where continuous, reliable service is required. By the use of maximal-ratio combiners, a gain in the median signal level can be obtained. The gain is theoretically 3.8 dB for dual-diversity, 6.0 dB for triple diversity and 7.2 for quadruple-diversity.

Quadruple-diversity is most economically obtained by using a form of space and polarization diversity. The four space paths are achieved by transmitting signals in the horizontal plane from one antenna and in the vertical plane from a second antenna. On the receiving end, two antennas are used, each antenna having dual-polarized feed horns for receiving signals in both planes of polarization. The net effect is to produce four independent signal paths which provide a diversity order of four.

Figure 7-1 shows the curves for dual-, triple-, and quadruple-diversity crossing the 50 percent reliability line at 3.8, 6.0, and 7.2 dB, respectively. The use of more

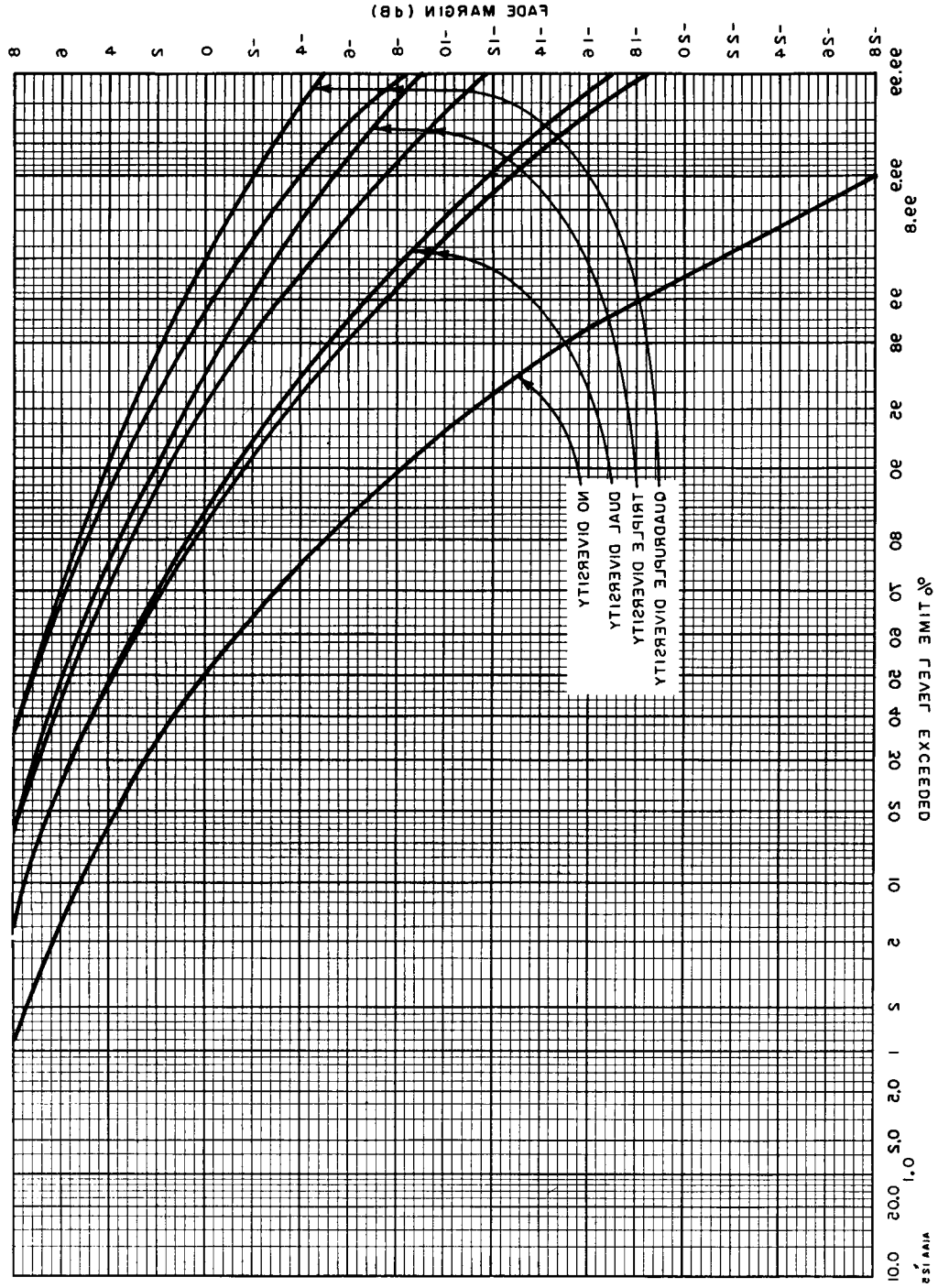

Figure 7-1. Short Term Fade Margin

than one antenna or more than one propagation path in conjunction with combining type receivers, therefore, produces a system gain of several dB.

7.2.4 System Performance

When the system gains and losses are tabulated, their algebraic total is the median received signal level. If this level is equal to the MUS, the system will function. However, the received signal will fluctuate rapidly, and will be obscured by noise at every fade. The reliability of such a system would be 50 percent, which is unsatisfactory for most military applications. If the median received signal is greater than the MUS, a fade equal to the difference between median received signal level and MUS will be absorbed without loss of the modulated information. The greater the difference of median received signal level and MUS (this difference is termed fade margin), the less is the likelihood that the received signal level will drop below the MUS.

7.2.5 Pre-emphasis (FM)

Pre-emphasis and the channel-loading factor are important considerations in determining the channel noise. While only a brief description of each is presented at this time, their use in the calculation of channel noise will be reserved for later paragraphs.

In order to assure that each channel has as near as possible the same signal-to-noise ratio, it is necessary to have the same deviation ratio in each channel. As the modulation frequency increases, the deviation ratio decreases. Thus, pre-emphasis must be added to make the frequency deviation in each channel a function of modulation frequency as well as modulation voltage. If the pre-emphasis is used, there is a gain in signal-to-noise in the top channel due to the increased deviation. A good engineering approximation is 4 dB average gain in a system using pre-emphasis over a system without pre-emphasis.

7.2.6 Channel Loading Factor

The load on a multi-channel system in terms of the number of telephone, teletype, and data channels in use will vary slowly with time. The multichannel system is also subjected to a rapidly varying instantaneous load resulting from the combination of the voltages in the various channels. A busy channel is one in which communications energy is actually flowing to a customer at the far end of the system. In the case of a telephone connection, busy channel time will be spent in ringing the far end, the near end talker upholding his portion of the conversation, and the rest of the time the talker at the far end will be talking, each pausing for breath and waiting between words and sentences. The fraction of time a busy telephone channel is active (termed activity factor) is obviously much less than one-half; thus indications are that a maximum telephone activity factor is 0.25.

7.3 SYSTEM CALCULATION EXAMPLE

To clarify the use of formulas and methods, a sample system calculation will be made. The system will be designed with line-of-sight calculations and consists of a path

approximately 28 miles long in which the transmitter and receiver antennas are separated by path obstacles.

This system requires 72 full duplex voice channels and has been assigned a carrier frequency of 2 MHz between points A and B. The noise level must not exceed 38 dBa0 in any channel and the minimum acceptable carrier-to-noise ratio is 10 dB. The system must have a reliability of no less than 99.99 percent. As a first approximation, system design may be based on calculations, but noise levels in each channel must also be found to be within limits before the design can be accepted.

To begin, site information must be obtained. The site under consideration is located in the Mediterranean area; adequate topographic maps have been assembled and a path profile has been drawn from these. Terminal A was found to be 6450 feet above sea level and terminal B was found to be 3970 feet above sea level. The 28 mile path is within a temperate climate. These figures are obtained from maps, but should be verified by a site survey.

The basic approach will be to design a system such that the following equation will be satisfied:

$$\begin{aligned} \Sigma \text{ Gains} &= \text{Losses} + \text{MUS} + \text{Fade Margin} && (7-6) \\ &= \text{Losses} + \text{AMUS (Actual Minimum Usable Signal)} \end{aligned}$$

First, the terms on the right-hand side of equation 7-6 will be determined, then equipment will be selected which will provide the necessary gains to overcome their losses and produce the required reliability. The only piece of equipment which must be selected at this time prior to determining terms on the right side of equation 7-6 is the antenna. For paths of about 30 miles, a good starting antenna would be one which possessed a 2-foot dish. Consideration must be given in each case, to the number of channels required and geographical location (arctic regions being more lossy than temperate regions). Thus, initial consideration will be given to use of a 2-foot dish.

To begin system calculations, certain preliminary calculations must be made. These include the determination of the Great Circle Distance, the equivalent distance and the receiver bandwidth. These preliminary calculations appear in the following paragraphs.

Table C-1 in Appendix C is a convenient form for recording system parameters. The first calculation in the system design is determination of the Great Circle Distance. This can be determined by the method presented in Appendix D and has been found to be:

Great Circle Distance - 28.55 Miles

The Great Circle Distance will be used in the determination of Free-Space Loss and Scatter Loss.

The power spectrum of a FM radio carrier is dependent on the modulating waveform and the deviation ratio. Medhurst has shown that for a normally distributed modulating waveform and sufficiently large deviation ratio, the RF power spectrum of the FM carrier is Gaussian. This is true since the RF energy in a particular frequency band is proportional to the percentage of time that the instantaneous carrier frequency remains in that band.

The first decision to be made in the choice of bandwidth is the RMS deviation corresponding to the channel test tone, realizing that a high deviation yields a high FM improvement as well as a higher threshold. CCIR Recommendation Number 274 calls for the following RMS frequency deviation per channel, without pre-emphasis, for line-of-sight and near line-of-sight systems. (To be used as an indicator only for tropo-scatter systems):

MAXIMUM NUMBER OF CHANNELS	RMS DEVIATION PER CHANNEL (KHZ)
24	35
60	50, 100, 200
120	50, 100, 200

A multichannel FM system which uses no pre-emphasis has a per channel deviation ratio inversely proportional to the channel frequency in the baseband. The channel deviation ratio for a sine wave test tone with a peak value equal to the channel level which, when exceeded, is considered as instantaneous channel overload, is:

$$m_c = \frac{\sqrt{2} \Delta F_c}{f_c} \quad (7-7)$$

where, ΔF_c is the RMS frequency deviation of the main carrier in Hz and F_c is the frequency in Hz of the channel sine wave modulating voltage in the baseband.

The RMS deviation of the RF carrier by the multichannel signal can be determined by taking the square root of the sum of the squares of the per channel mean deviations of the RF carrier. The RMS multichannel deviation will vary as the mean multichannel power. The peak deviation of the carrier may be determined by:

$$\Delta F_c \text{ (peak)} = \sqrt{2} \Delta f_1(N) \text{ Hz} \quad (7-8)$$

where

Δf = RMS deviation per channel in Hz

N = number of channels

$$1(N) = \text{antilog} \frac{L(N)}{20}$$

$$\Delta F_c \text{ (peak)} = \text{peak carrier deviation}$$

The bandwidth may then be determined by entering figure 7-2 with the deviation ratio or by using (7-9) below:

$$3 \text{ dB bw} = 2 (\Delta F_c \text{ (peak)} + 2f_m) \quad (7-9)$$

where: f_m = maximum modulating frequency in Hz (see table 7-1)

As an example, consider 72 channels with an RMS deviation of 100 kHz per channel. The load factor, $L(N)$, from figure 7-3, is 18.1 dB, thus $1(N)$ is about 8.05. Then the peak carrier deviation, $\Delta F_c \text{ (peak)}$ is found from (7-8) above;

$$\Delta F_c \text{ (peak)} = 1.414(100)(8.05)$$

$$\cong 1140 \text{ kHz}$$

The top channel frequency is 300 kHz so that the peak deviation ratio from (1) above is:

$$m_p = \frac{1140}{300} \cong 3.8.$$

The 3 dB bandwidth may now be determined using (7-9) above

$$3 \text{ dB bw} = 2(1140 + 600)$$

$$\cong 3480 \text{ kHz}$$

The bandwidth may also be determined by use of figure 7-2. Entering with a deviation ratio, m_p , of 3.8, curve (A) shows a ratio $\frac{b}{\Delta F_c \text{ (peak)}}$ of about 3.9, so the flat band-

width is about 4440 kHz; Curve (B) shows a ratio $\frac{b}{\Delta F_c \text{ (peak)}}$ of about 3.05, so that

the 3 dB bandwidth of 3480 kHz of equation (7-9) is verified; Curve (C) shows a ratio $\frac{b}{\Delta F_c \text{ (peak)}}$ of about 2.38, so the flat bandwidth for a distortion-to-signal ratio of -80 dB is about 2710 kHz. The 3 dB bandwidth required in the IF, b_{IF} , is about 3.5 MHz.

In the general case, the rms deviation per channel should be chosen so that the peak deviation ratio is around 3. The result of several cases is shown in table 7-1.

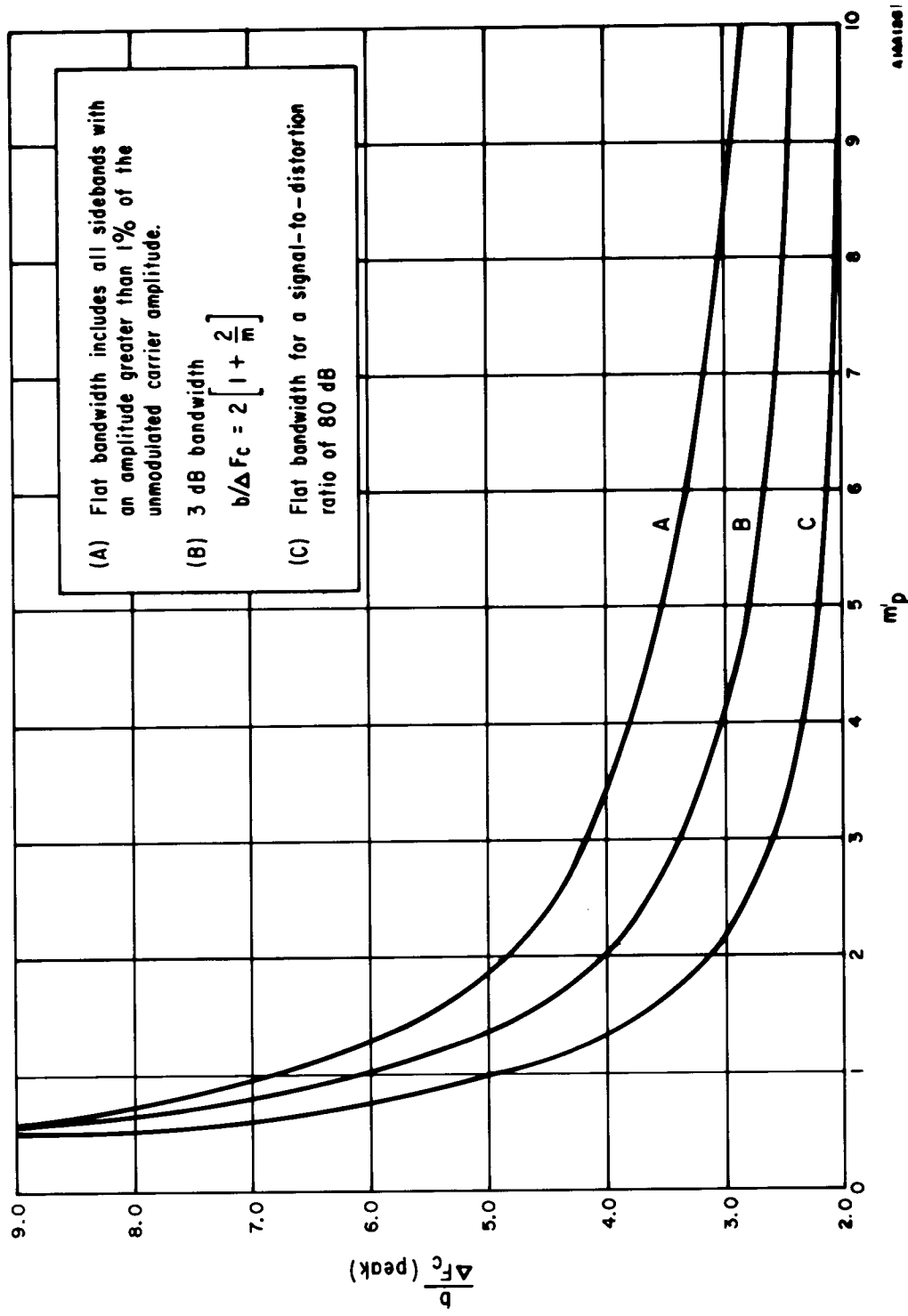

Figure 7-2. Bandwidth Determination

Table 7-1. Results of RMS Deviation Per Channel

NUMBER OF CHANNELS	MAXIMUM MODULATION FREQUENCY	LOADING FACTOR $L(N)$ IN dB	$1(N)$	RMS DEVIATION PER CHANNEL (Hz)	PEAK CARRIER DEVIATION (Hz)	F_c (PEAK) fm	3 dB BAND-WIDTH, b, IN Hz	$B(DB) = 10 \text{ LOG } b$
12	60	15.8	6.2	25 35	219 306	3.6 5.1	680 850	58.3 59.3
24	108	16.8	6.9	25 35	244 324	2.3 3.2	920 1120	59.6 60.5
36	156	17.2	7.25	35 50	360 514	2.3 3.3	1345 1650	61.3 62.2
48	204	17.5	7.5	35 50 100	372 532 1060	1.8 2.6 5.2	1560 1880 2940	61.9 62.7 64.7
60	252	17.8	7.8	50 100	550 1100	2.2 4.4	2110 3210	63.2 65.1
72	300	18.1	8.0	50 100 200	570 1140 2280	1.9 3.8 7.6	2340 3480 5760	63.7 65.4 67.6
120	492	19.1	9.3	50 100 200	1310	2.7	4580	66.0

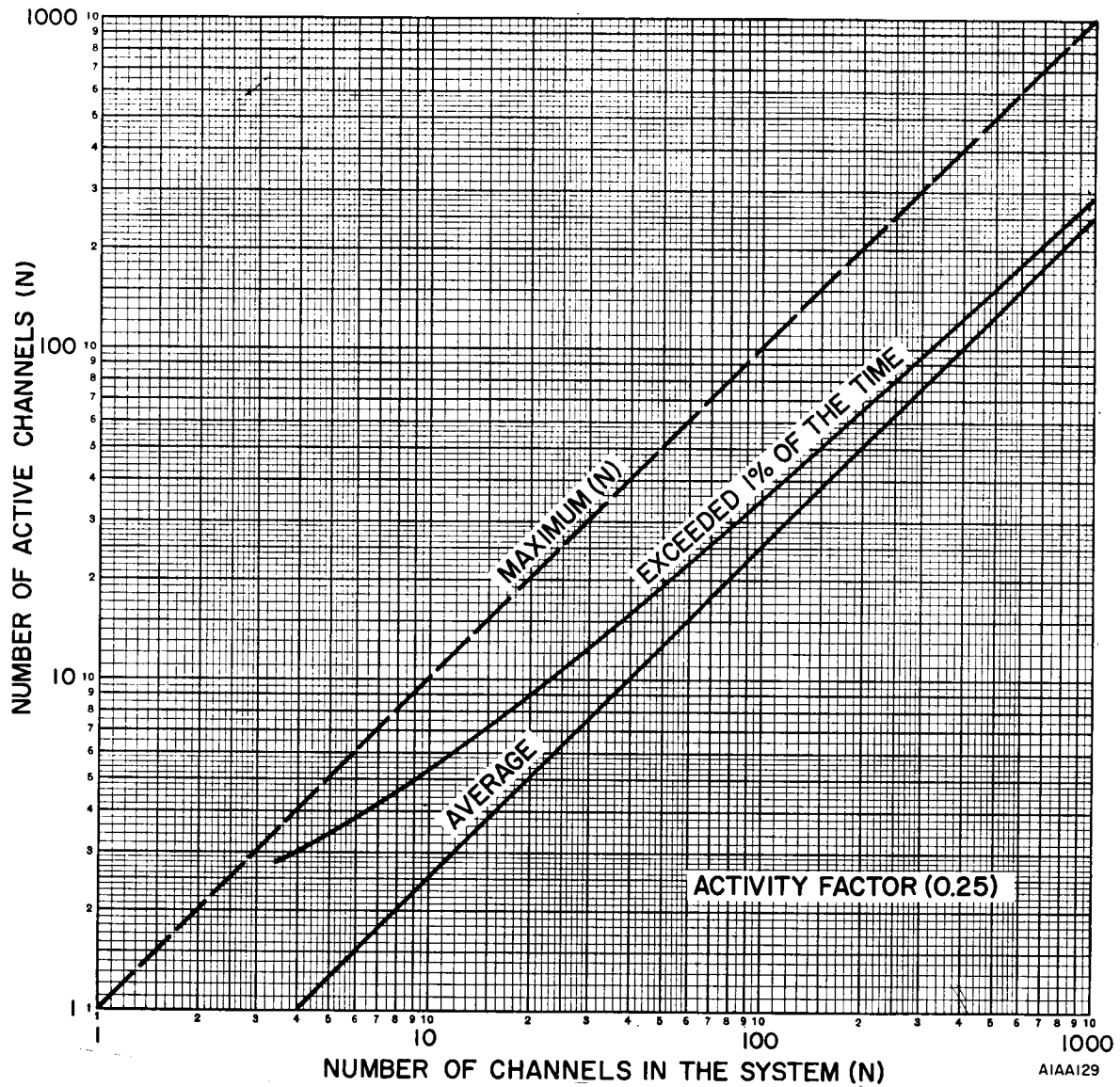

Figure 7-3. Number of Active Channels as a Function of the Number of Channels in the System

AIAA129

7.3.1 System Losses

Now we are ready to compute systems losses. The first loss considered is Free-Space Loss, obtained from Appendix A or from the relationship:

$$\begin{aligned}
 L_{\text{FS}} &= 37 + 20 \log D + 20 \log f & (7-10) \\
 &= 37 + 20 \log 28.55 + 20 \log 1965 \\
 &= 37 + 28.96 + 65.87 \\
 &= 131.83
 \end{aligned}$$

Free Space Loss = 132 dB

To the above loss we add the allowance (6 dB) for all miscellaneous losses (transmission lines, etc.)

Miscellaneous Losses = 6 dB

The losses are tabulated as shown below:

Losses	
Free-Space	132.0 dB
Miscellaneous	6.0 dB
Total Losses	138.0 dB

7.3.2 Actual Minimum Usable Signal

With the system losses determined, attention will now be given to the evaluation of the Actual Minimum Usable Signal (AMUS). The AMUS is composed of two factors:

- o the MUS
- o the additional gain required for obtaining the desired reliability (fade margin).

The minimum usable signal, MUS, is obtained from:

$$\begin{aligned}
 \text{MUS} &= -204 \text{ dBW} + 10 \log \text{BW} + (\text{receiver noise figure in dB}) & (7-11) \\
 &+ (\text{carrier-to-noise ratio in dB}) \\
 &= -204 + 10 \log 3.2 \times 10^6 + 12 + 10 \\
 &= -204 + (10) (6.505) + 22
 \end{aligned}$$

MUS = -117 dBW

The MUS represents the minimum usable signal level, in dB, for a system possessing 50 percent propagation reliability. The receiver noise-figure is 12 dB, and the carrier-to-noise ratio is 10 dB (by definition) for FM systems.

Since ordinary military systems require a propagation reliability greater than 50 percent, the MUS must be adjusted to meet the requirement. For the system under consideration, the adjustment necessary to increase the reliability to 99.99 percent is 38.0 dB as obtained from figure 2-30. Therefore:

$$\text{Fade Margin} = 38.0 \text{ dB}$$

Thus, the AMUS for this system is:

$$\begin{aligned} \text{AMUS} &= \text{MUS} + \text{additional gain to obtain 99.99\%} && (7-12) \\ &\quad \text{reliability (fade margin)} \\ &= -117 + 38 \\ &= -79 \text{ dB} \end{aligned}$$

7.3.3 System Design Parameters (System Gains)

Combining the total losses with the AMUS, equation 7-6 reveals that the system must produce a minimum gain of 59 dB if it is to be acceptable.

$$\text{Required Gains} = \text{Losses} + \text{AMUS} \quad (7-13)$$

$$\text{Required Gains} = 138 - 79 = 59 \text{ dB}$$

Gains. System gain is a function of transmitter power, antenna diameter, order of diversity and (when present) knife-edge gain.

A 1-watt transmitter is first considered and has a gain of 0 dB.

$$G_{\text{TR}} = 10 \log \left(\frac{1\text{w}}{1\text{w}} \right) = 0 \text{ dB} \quad (7-14)$$

Antenna gain, obtained from Appendix A or Equation 7-15, is:

$$\begin{aligned} G_{\text{A}} &= 20 \log f + 20 \log D_{\text{A}} - 52.6 && (7-15) \\ &= 20 \log 1965 + 20 \log 2 - 52.6 \\ &= 19 \text{ dB} \end{aligned}$$

System antenna gain is $(19.0) (2) = 38 \text{ dB}$.

Next, the order of diversity is given consideration. First, consider dual diversity. From figure 7-1, it is seen that a gain of 3.8 dB is realized if dual diversity is used. This calculation is median path loss; therefore, enter curve at 50 percent time level. Therefore:

$$\text{Diversity Gain} = 3.8 \text{ dB}$$

Tabulating the above gains, a total gain of 41.8 dB is obtained:

Transmitter (1-watt)	0 dB
Antenna (2')	38.0
Diversity (dual)	3.8
Total Gain	41.8 dB

Comparing the total system gain (41.8 dB) with that required for 99.99 percent reliability (59.0 dB), indicates that the system does not meet the requirements. The next consideration is to find the simplest and cheapest method of obtaining the required increase. This may be accomplished by reducing the losses (difficult in most cases) or increasing the gains.

There are three direct methods of increasing gains: increasing the order of diversity; increasing antenna size; or increasing transmitter power.

7.3.4 Balance

Quadruple diversity may be used instead of dual diversity. With quadruple diversity a gain of 7.2 dB (3.4 dB over dual diversity) (see figure 7-1) is realized.

Retabulating system gain using the increase in gain due to quadruple diversity yields a total gain of 45.2 dB, as follows:

Transmitter (1-watt)	0.0 dB
Antenna (2')	38.0
Diversity (Quadruple)	7.2
Knife-Edge	0.0
Total Gain	45.2 dB

Again, comparing system gain (45.2 dB) with the gain required for 99.99 percent reliability (59.0 dB) indicates that further adjustment will be necessary.

Increasing antenna size will next be considered. Consider the use of 4-foot reflectors in place of 2-foot reflectors. As determined from equation 7-15, a gain of 50 dB (2) (25.0) results from this consideration.

Retabulating system gain using the increase in gain due to the larger antenna yields:

Transmitter (1-watt)	0.0 dB
Antenna	50.0 dB
Diversity (Quadruple)	7.2 dB
Total Gain	57.2 dB

Again, comparing system gain (57.2 dB) with the gain required for 99.99 percent reliability (59.0 dB) indicates that still further considerations will be necessary.

The third possibility of obtaining an increase in gain is through the use of higher power transmitters. If 2-watt instead of 1 watt transmitters are used, the system will experience a 3 dB gain (3 dB over a 1 watt transmitter). This will increase the total system gain to 60.2 dB, which exceeds the 59 dB required for 99.99 percent reliability. Thus, the requirements have been met.

Very often only one or two of the above considered methods for increasing gain will be sufficient to meet requirements. In such a case, the method selected to obtain the required reliability should be based on cost, availability of equipment and materials, ease of maintenance, and space and height limitations, as well as equipment dependability and power requirements. The three methods of achieving the required reliability must be analyzed in the light of the peculiarities of the individual sites.

Quadruple diversity may be effected without additional antennas by simultaneously transmitting horizontal and vertical modes. Both modes are received on each receiving antenna, using dual polarized horns feeding into combining-type receivers. This is an economical method of requiring only two additional waveguide runs and two additional receiver-combiners. The total space requirement is only slightly greater. Increased maintenance is necessary, causing additional down time which decreases reliability unless spare receiver(s) are provided.

The use of larger antennas is effective in providing increased gain. However, cost and space requirements are increased. Air hazards are also presented with the use of larger antennas. This method, however, provides increased gain with little additional maintenance or post-installation cost.

Transmitters of greater power may be considered as a means to increase the received signal level. However, additional building space is required for heat exchangers and prime power requirements are greatly increased. Replacement cost of klystrons over several years might prove to be very high.

7.3.5 Channel S/N Calculations

After reliability considerations have been established and a favorable system design completed, it is necessary to compute the expected channel noise. According to the DCA System Performance Specifications, the channel noise objective is 38 dBaO. The requirement states that:

...noise in any channel shall not exceed 38 dBa median at zero relative level (25,000 picowatts) in any channel during the worst month, and shall not exceed 49 dBa at zero relative level (316,000 picowatts) in any channel for more than 1.0 percent of the worst month.

The channel noise (Signal-to-Noise ratio (S/N)) may be computed after the Carrier-to-Noise (C/N) ratio of the path has been determined. The relationship between channel S/N and system C/N in an FM system is determined primarily by the bandwidth required for the particular type of information being transmitted and the degree of deviation produced in the system.

The Carrier-to-Noise defines the power relationship that exists between the received signal level and the noise. The total median C/N is obtained by adding the reliability fade margin (additional gain required for desired reliability) to the defined Carrier-to-Noise ratio of 10 dB.

In this case:

$$\begin{aligned} C/N &= 10 + 38.0 \\ &= 48 \text{ dB} \end{aligned}$$

With the total median C/N known, the S/N ratio may be obtained from:

FOR SSB

$$S/N = C/N + 10 \log \left(\frac{BW}{bw} \right) - L \quad (7-16)$$

FOR FM

$$S/N = C/N + 20 \log (\text{Modulation Index}) + 10 \log \left(\frac{BW}{2bw} \right) + PF - L - MUX \quad (7-17)$$

where,

C/N = Total Median C/N Ratio

BW = Receiver IF Bandwidth

bw = Voice Channel Bandwidth

L = Channel Loading Factor

PF = Pre-emphasis Gain

MUX = Multiplex Equipment Noise Insertion

For the system under consideration:

Modulation Index = 3

C/N = 48 dB

BW = 3.2 MHz

bw = 4 kHz

PF = 4 dB

L = 10.8 dB (See figure 7-4)

MUX = 2 dB (average factor)

Thus,

$$\begin{aligned}
 S/N &= 48 + 20 \log 3 + 10 \log \left(\frac{3.2 \times 10^6}{8 \times 10^3} \right) + 4 - 10.8 - 2 \\
 &= 20 \log 3 + 10 \log (4 \times 10^2) + 39.2 \\
 &= (20) (.466) + (10) (2.602) + 39.2 \\
 &= 9.54 + 26.02 + 39.2 \\
 &= 74.76 \text{ dB}
 \end{aligned}$$

Thus, the S/N ratio has been computed. Before proceeding to the determination of channel noise, it is important to briefly consider the meaning of the S/N ratio.

The term "signal-to-noise ratio" (S/N) originated in single-channel communications practice and generally took into consideration only background or residual noise in a single radio channel. With the growth of multichannel communications, it is also used to express total intermodulation and residual noise in a single radio channel and is frequently referred to as "per-channel flat signal-to-noise ratio." Basically, it expresses the ratio, in dB, of signal power to total noise power in a channel. It does not take into account the actual interfering affect of noise on the signal in complete circuits.

The channel noise factor is expressed in dBa0 Decibels adjusted, or dBa, originated in the telephone industry as an expression of overall system noise performance.

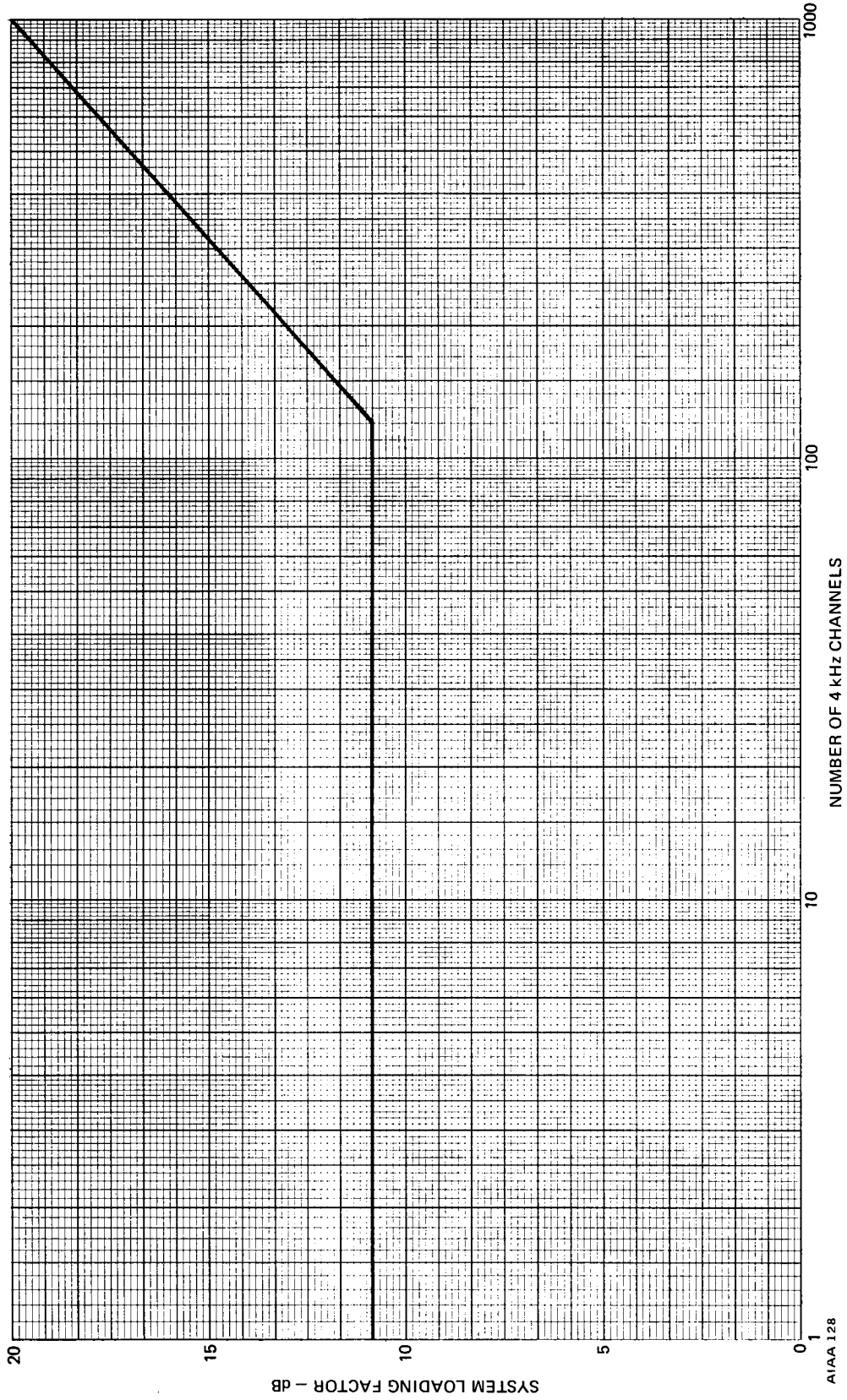

Figure 7-4. System Loading Factor

Strictly speaking, the term dBa implies that the frequency response or weighting of the voice frequency equipment used is "F1A" weighting. This method of noise performance is especially practical. It takes into account not only special types of noise or noise in particular items of equipment, but also the affects of all system noise.

By definition, dBa refers to decibels of noise power above a reference noise power, with an adjustment factor included to compensate for weighting. Even though the equipment from which F1A weighting was derived has been superseded by newer equipment having better performance, F1A weighting continues to be used extensively because it provides a very close approximation to the performance of most telephone equipment.

The reference noise power to which dBa is referred is -85 dBm. To obtain dBa0, it is only necessary to calculate how many dB above this reference power the signal is. For flat voice channels, the corrected reference level is $-85 + 3$ or -82 dBm. Therefore, in this case

$$\text{dBa0} = 82 - (\text{S/N}) = 82 - 74.76 = 7.24 \text{ dBa0} \quad (7-18)$$

The allowable median noise in a real LOS hop specified by DCAC-330-175-1 is based on its actual length as follows:

hop length in NMI	Allowable Noise
$L > 151$ NMI	$3.33 L$ pWpO
$27 < L < 151$ NMI	$2.76 L$ pWpO + 85.5 pWpO
$L < 27$ NMI	160 pWpO

Where L is the hop length in nautical miles.

Therefore, for a 28.55 mile hop the allowable noise is:

$$= 2.76 (28.55) + 85.5 \text{ pWpO}$$

$$= 164.4 \text{ pWpO}$$

$$\text{or } 16.6 \text{ dBaO}$$

Thus, a channel having a S/N ratio of 74.76 dB exhibits 7.24 dBaO noise. The allowable median noise is 16.6 dBaO and the channel noise requirement is met.

If the value of the channel noise factor did not meet the minimum specified for the system, it would be necessary to increase the basic peak channel deviation, or the pre-emphasis, or base the signal reliability on a greater C/N ratio. The choice will depend on the flexibility of the particular equipments involved. The affect on the bandwidth of adjusting the deviation ratio is shown in table 7-1.

The system calculations presented in this paragraph are provided as a guide and are a compilation of the most recent and reliable data available.

The data sheets (table 7-2) illustrate the foregoing example. Blank data sheets are included in Appendix C.

7.4 FREQUENCY PLANNING

In the design of any microwave communications system involving the use of two or more radio frequencies, it is necessary to develop a plan of frequency allocation that will preclude the possibility of interference. Such interference may be defined as the reception of an undesired signal with, or in place of, the desired signal. This undesired signal, or interference, should be considered in terms of its source and permissible level at the receiver.

Types of Undesired Signals. There are three types of undesired signals which must be considered by the system planner, two of which are directly under his control. The undesired signals are:

- o Signals arriving at two or more receivers from two or more transmitters operating from the same location and in the same direction, that is, signals traveling parallel paths. These signals will arrive at about the same signal level, and will be affected equally by any fade that may occur along their path (assuming that frequency separation is not too great). These parallel signals will cause interference at the receivers unless the transmitting frequencies are chosen with the RF and IF rejection characteristics of the particular equipment in mind.

- o Signals from other transmitters at the same station in close proximity to the receivers. The desired signal, in this case, may be very weak as compared with the signal radiated from the nearby transmitter (for example, -75 dBm as compared with 0 dBm). Also, the undesired signal is generally not subject to atmospheric fading, as is the desired signal. Allowing for a fading margin of 30 dB, the desired signal level might be as low as -105 dBm. Because of these factors, the frequency separation between the undesired locally transmitted signal and the desired received signal must be great enough to allow sufficient attenuation (about 25 dB) of the undesired signal below the minimum level of the desired signal.

- o Signals originating from sources external to, or unrelated to, the microwave system under consideration. These undesired signals are the most difficult to eliminate. Military microwave systems, or commercial systems operating in the vicinity of military installations, may have interference from certain types of radar or other super-high-frequency equipment. In some instances, an undesired signal may be the fundamental frequency of the radar equipment, and, in certain types of radar, the peak amplitude of this signal may be as much as 60 dB above the peak RF output of the microwave equipment. Since it is improbable that a change in radar frequency can be effected, it follows that the microwave system frequency allocation must be reconsidered.

Table 7-2. LOS System Data Sheet

FROM: **Site A**TO: **Site B**

I. SYSTEM REQUIREMENTS

Type of Transmission (Voice, TTY, etc.) -----	Full Duplex Voice
Number of Voice Channels -----	72
Desired Reliability -----	99.99
Maximum Allowable Channel Noise 6000 mi. cct. ---	37 dBaO
Maximum Modulating Frequency, FM -----	400 kHz
RF Carrier Frequency, F -----	1965 MHz
Modulation Index -----	3
Site Coordinates:	

LA $\underline{\quad}$ ° $\underline{\quad}$ ' $\underline{\quad}$ " N Lat $\underline{\quad}$ ° $\underline{\quad}$ ' $\underline{\quad}$ " W Long
 LB $\underline{\quad}$ ° $\underline{\quad}$ ' $\underline{\quad}$ " N Lat $\underline{\quad}$ ° $\underline{\quad}$ ' $\underline{\quad}$ " W Long

II. PRELIMINARY CALCULATIONS

Great Circle Distance, D ----- **28.55 Miles**
 Revr. Bandwidth, BW = $2(\Delta F_p + F_m)$ ----- **3.2 MHz**

III. LOSSES - dB

	Trial	Change	Change	Change
	1	Dual To Quad	Ant. 2' - 4' -	Xmtr 1 - 2 Watts
Free-Space Loss, $L_{FS} = 37 + 20 \log D$ (miles) + $20 \log f$ (MHz) -----	132.0	132.0	132.0	132.0
Misc. Transmission Loss -----	6.0	6.0	6.0	6.0
TOTAL LOSSES -----	138.0	138.0	138.0	138.0

IV. MINIMUM USABLE SIGNAL, MUS

= $204 \text{ dBW} + 10 \log \text{ BW} + 12 \text{ dB} + 10 \text{ dB}$ --- **-117 dBW**

V. ADDITIONAL GAIN REQUIRED FOR 99.99%

RELIABILITY (FADE MARGIN) ----- **+38 dB**

VI. ACTUAL MINIMUM USABLE SIGNAL, AMUS

= MUS + FADE MARGIN ----- **-79 dB**

Table 7-2. LOS System Data Sheet (Continued)

Trial	Change	Change	Change
1	Dual To Quad	Ant. 2' - 4' -	Xmtr 1 - 2 Watts
59	59	59	59

VII. TOTAL REQUIRED GAIN in dBW
= TOTAL LOSSES + AMUS -----

Trial	Change	Change	Change
1	Dual To Quad	Ant. 2' - 4' -	Xmtr 1 - 2 Watts
0	0	0	3.0
38.0	38.0	50.0	50.0
3.8	7.2	7.2	7.2
41.8	45.2	57.2	60.2

VIII. GAINS - dBW

Xmtr Gain, $G_{TR} = 10 \log P_{IT}$ -----
Antenna Gain, $G_A = 20 \log f + 20 \log D_A - 52.6$ -----
Diversity Gain, G_{DIV} -----
TOTAL GAIN -----

IX. SYSTEM FEASIBILITY

(Compare Step VIII and Step VII)

Adjustment Required

X	X	X
OK	X	

X. MEDIAN CARRIER-TO-NOISE RATIO, C/N
= FADE MARGIN + 10 dB ----- 48.0 dB

XI. SIGNAL-TO-NOISE RATIO, S/N
= C/N + $10 \log \left(\frac{BW}{bw} \right) + 20 \log (\text{Modulation Index})$
+ PF - L - MUX ----- 74.76 dB

XII. CHANNEL NOISE FACTOR
= 82 - S/N ----- 7.24 dBaO

XIII. ALLOWABLE MEDIAN NOISE

L > 151 NMI ----- 3.33 L pWpO
27 < L < 151 NMI ----- 2.76 L + 85.5 pWpO
L < 27 NMI ----- 160 pWpO
MAX ALLOWABLE NOISE ----- 16.6 dBaO

XIV. SUMMARY

Desired Reliability: 99.99% Actual Reliability: 99.99%
Max. Allowable Channel Noise: 15.6 dBaO Actual Channel Noise: 7.24 dBaO

Table 7-2. LOS System Data Sheet (Continued)

Recommended Design Parameters:Transmitter Power: 2 wattsAntenna Size: 4 feetDiversity, order
of: Quadruple**GENERAL NOTES**

o The maximum modulating frequency is the sum of the minimum modulating frequency (60 kHz); the voice channel bandwidth (a product of the number of voice channels and the nominal 4 kHz spacing); and the spacing between basic supergroups (12 kHz).

o See Appendix D if Great Circle distance must be determined exactly (to five place accuracy). Otherwise, measurements from a map with + 10-mile accuracy will suffice.

o To allow for losses associated with transmission lines, coupling, transition, duplexers, etc., a figure of 4 dB is given for systems using 1 kHz and a figure of 6 dB is used for 2 kHz systems.

o In this equation 12 dB = receiver-noise figure and 10 dB = C/N figure. These are approximate values and may be changed to fit the specific case. For instance, if parametric amplifiers are used, the 12 dB receiver-noise figure is changed to 2 dB.

o In this equation C/N is that computed in Step X, BW is that computed in Step II, bw = voice channel bandwidth, PF = pre-emphasis gain, L = channel loading factor, and MUX = multiplex equipment noise insertion (about 2 dB.).

In the case of interference resulting from harmonics of nearby transmitters operating on a lower frequency, it is necessary to locate the offending equipment and attempt modifications or adjustments to suppress or prevent the generation of harmonics. If this cannot be done, it will become necessary to employ harmonic waveguide filters to eliminate the interference. Problems of this nature must be solved on an individual basis through cooperation with the cognizant government or commercial agency. The above types of interference and additional types are discussed in chapter 3. For additional information in reference to the Utilization of Frequency Spectrum, consult NAVELEX 0101, 106 "Electromagnetic Compatibility and Electromagnetic Radiation Hazards."

7.4.1 Frequency Assignment

When developing a radio-frequency allocation plan for a complex system, allowance should be made for the maximum number of channels that may be required by future expansion. This will permit orderly system expansion with the minimum amount of modification, and will eliminate major readjustments which might otherwise be required. Frequency assignment for military objectives (refer to DCAC 330-175-1) include channel spacing, transmit-receive frequency separation and IF interference.

a. Channel Spacing. The minimum RF channel spacing for any microwave system shall be as follows:

No. Voice Channels	Channel Separation
36	5.6 MHz
60	11.2 MHz
120	14.0 MHz
300 (or more)	29.0 MHz

b. Transmit-Receive Frequency Separation. If a transmitter and receiver are operated at the same frequency in the same station, the loss between the transmitter and receiver must be greater than 120 dB. All "go" channels shall be in one-half of the band, and all "return" channels shall be in the other half of the band. The terms "go" and "return" are used only to distinguish between the two directions of transmission.

For adjacent RF channels in the same half of the band, different polarization shall be used alternately. This means that the odd-numbered channels in both directions of transmission on a given section shall use H(V) polarization, and the even-numbered channels shall use V(H) polarization.

In order to prevent interference between the transmit and receive antennas on opposite sides of a station, each channel shall be shifted in frequency (frogged) as it passes through a repeater station as shown in table 7-3.

The minimum separation between a transmit and receive carrier frequency on a single hop shall be as shown in table 7-4.

c. IF Interference. The center frequency and the channel spacing of the RF carrier frequencies shall be chosen so as to prevent interference due to harmonics of the shift frequency. That is, harmonics cannot occur at f_n , the channel frequency, or at $f_n \pm 70$ MHz when the IF is 70 MHz.

Table 7-3. Minimum Frequency Shift as Channel Passes Through Station

NO. VOICE CHANNELS	RF CARRIER FREQUENCY, kHz	
	2 to 4	6 to 8
120 or less	120	161
300 or greater	213	252

Table 7-4. Minimum Spacing Between a Transmit and Receive Carrier Frequency at a Single Station. (Minimum Guard Channel Width Between Upper and Lower Half of the Allocated RF Band.)

NO. VOICE CHANNELS	RF CARRIER FREQUENCY, kHz	
	2 to 4	6 to 8
60 - 120	49	30
120	68	44.5

7.4.2 Frequency Plan

The Defense Communication Agency recommends the use of one of two frequency plans for the military, to be used under appropriate circumstances. The DCA frequency plans are illustrated in figures 7-5 and 7-6.

The DCA specifies that the frequency channels shall be assigned on a hop-by-hop basis such that the median value of the unwanted signal in the receiver, due to using the same or adjacent frequency channels in two relay sections shall be at least 10 dB below the inherent noise level of the receiver.

When the system requirement is such that a large number of voice channels must be handled and it is necessary to use all the RF carrier channels on a single hop, frequency plan 2 (illustrated in figure 7-6) is recommended. However, when the number

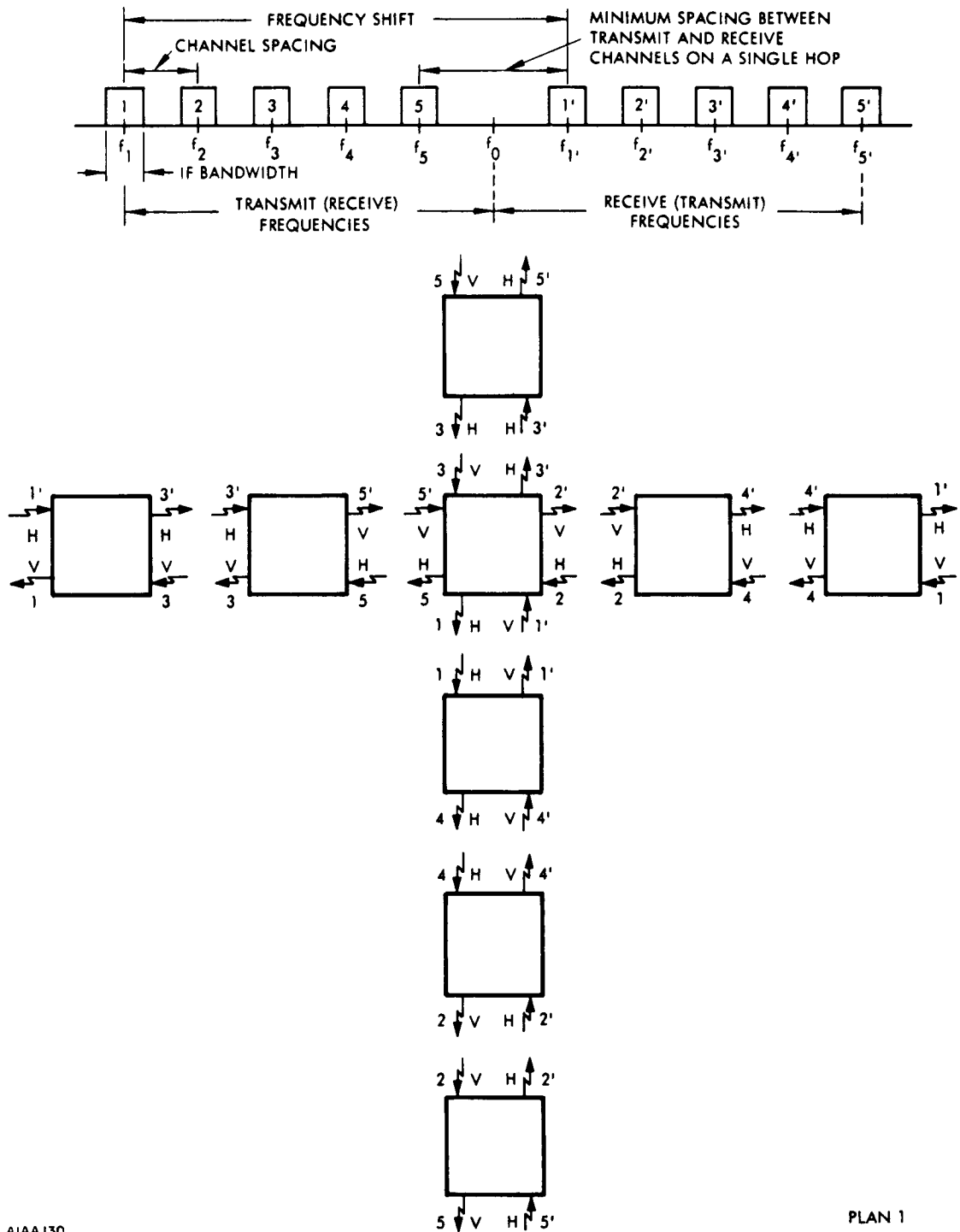

A1AA 130

PLAN 1

Figure 7-5. Recommended Frequency Plan for Small Capacity System (120 or Less Voice Channels)

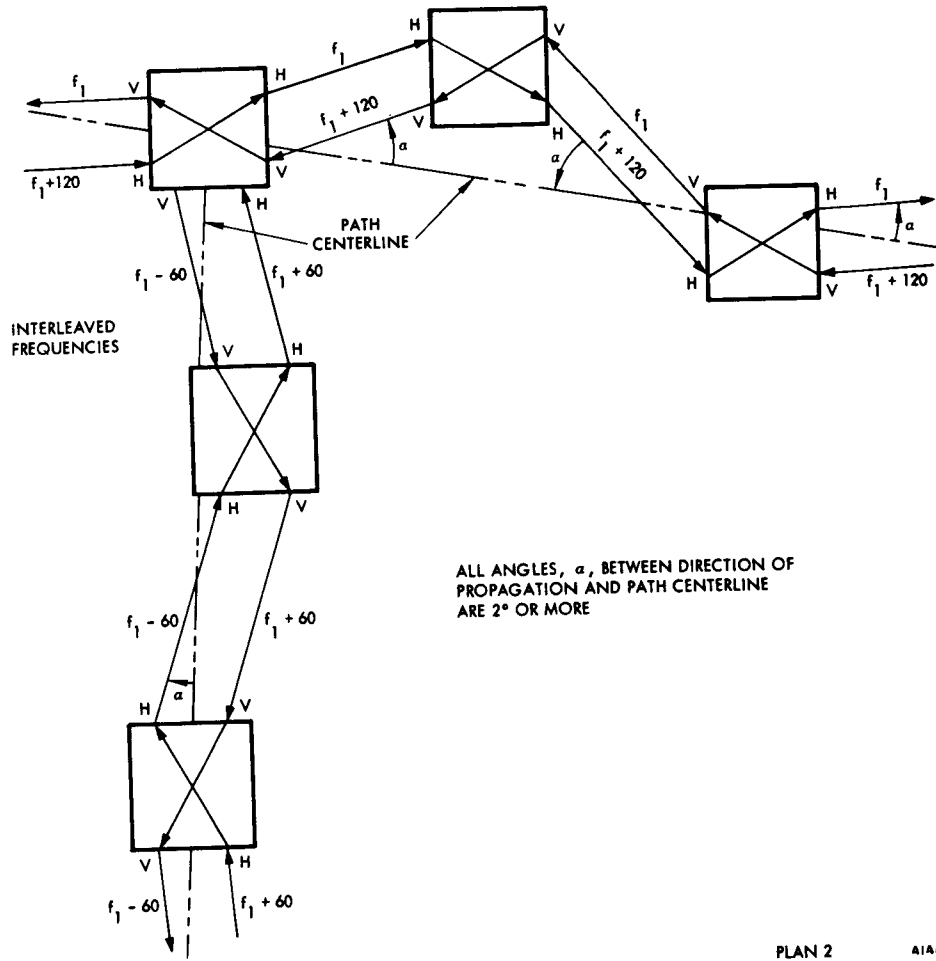

Figure 7-6. Recommended Frequency Plan for Large Capacity System (120 or More Voice Channels)

of voice channels is small, interference may be minimized by using frequency plan 1 (illustrated in figure 7-5), where alternate channels are used on alternate hops.

A basic computer model which may be used in developing frequency plans is included in Appendix H.

7.5 EQUIPMENT SELECTION CRITERIA

This paragraph provides information to be used for the specification and selection of a microwave system and associated equipments. Each item in the system is described in terms of its function, operating and physical parameters, and compliance with specifications. A summary of the specifications for major items of equipment is presented in table 7-5.

7.5.1 Antenna Systems

Antenna systems include some or all of the following equipments:

a. Antennas

- (1) Parabolic (or modified parabolic) reflectors
- (2) Antenna feed devices
- (3) Passive reflectors
- (4) Radomes with and without heating elements.

b. Waveguide Components

- (1) Rigid waveguide
- (2) Flexible waveguide
- (3) Waveguide switches
- (4) Ferrite load isolators
- (5) Circulators
- (6) Duplexers
- (7) Diplexers.

c. Pressurizing and Dehydrating Equipment. Military microwave communications systems occupy the following frequency bands:

Table 7-5. Specification of Major Items of Equipment (Sheet 1 of 2)

SUBSYSTEM AND COMPONENT	FUNCTION	KEY PARAMETERS	APPLICABLE SPECIFICATIONS FROM DCAC 330-175-1	SPECIFIED BY EQUIPMENT DESIGNER
<p>Antenna System</p> <p>Transmission Line/Waveguide</p> <p>Antenna Reflector</p> <p>Antenna Feed Horn</p> <p>Dehydrator and Pressurization Equipment</p>	<p>Transmission line transfers composite transmit signal from power amplifier via duplexer to the antenna feed horn for radiation; transfers composite receive signal from the antenna feed horn via the duplexer to the receiver input.</p>	<p>Antenna</p> <ol style="list-style-type: none"> Type Characteristic Impedance VSWR <p>Transmission Line</p> <ol style="list-style-type: none"> Type Characteristic Impedance VSWR 	<ol style="list-style-type: none"> Para. 3.2.2.5.6.1 Para. 3.2.2.5.6.1.1 Para. 3.2.2.5.6.1.2 <ol style="list-style-type: none"> Para. 3.2.2.5.6.2 Para. 3.2.2.5.6.2.1 Para. 3.2.2.5.6.2.2 	<p>Dual Diversity</p> <p>Diameter of reflector</p> <p>Type of transmission line</p> <p>Spacing for diversity</p>
<p>Receiving Equipment</p> <p>Low Noise Pre-amp</p> <p>Mixer</p> <p>IF Amplifier</p> <p>Combiner</p> <p>FM Demodulator</p>	<p>Detects transmitted signals, amplifies them to required level, separates and recovers the composite information signal through demodulation.</p>	<ol style="list-style-type: none"> RF Input Impedance Frequency Stability Image and out-of-band frequency rejection Intermediate frequency characteristic <ol style="list-style-type: none"> IF center frequency Output Impedance 	<ol style="list-style-type: none"> Para. 3.2.2.5.6.3.1 Para. 3.2.2.5.6.3.2 Para. 3.2.2.5.6.3.3 Para. 3.2.2.5.6.3.4 	
<p>Transmitting Equipment</p> <p>Exciter (RF Oscillator)</p> <p>Power Amplifier</p>	<p>Generates RF carrier, amplifies modulated carrier to desired level.</p>	<ol style="list-style-type: none"> RF Output Impedance Carrier Frequency Stability Spurious Emission Suppression Pre-emphasis <p>Characteristic</p>	<ol style="list-style-type: none"> Para. 3.2.2.5.6.4.1 Para. 3.2.2.5.6.4.2 Para. 3.2.2.5.6.4.3 Para. 3.2.2.5.6.4.4 	<p>Output Frequency</p> <p>Power Output</p> <p>Radio Frequency Bandwidth</p> <p>Deviation Capability</p>
<p>Multiplex Equipment</p> <p>Baseband Amplifiers</p> <p>Group-Through-Filters</p> <p>Group-Modems</p> <p>Group Patchboard</p> <p>Group Distributing Frames</p> <p>Supergroup Modems</p> <p>Multiplex Frequency Gen.</p>	<p>Accepts voice, telegraph, and/or data channel outputs from terminal subsystem; heterodynes and amplifies signals to provide composite, wide-band frequency division signal to transmitter for carrier modulation.</p> <p>Accepts received composite wideband frequency-division signal from receiver; separates and demodulates voice, telegraph and/or data channel signals comprising composite signal; amplifies and provides channel information in original form for reproduction or transmission to user by termination subsystem.</p>	<ol style="list-style-type: none"> Input and Output Impedance levels and frequencies Noise and interference Envelope Delay Distortion Total Noise Harmonic Distortion Stability of Multiplex Frequency Generator Net Loss Variation Gain Change for Output Level Increase Maximum Overall Change in Audio Frequency 	<ol style="list-style-type: none"> Table 3.2.2.5.1.2 of Standards Para. 3.2.2.5.2.2 Para. 3.2.2.5.1.1.2 Para. 3.2.2.5.1.1.3 Para. 3.2.2.5.1.1.4 Para. 3.2.2.5.1.1.9 Para. 3.2.2.5.1.1.6 Para. 3.2.2.5.1.1.5 Para. 3.2.2.5.1.1.8 	<p>Number and arrangement of channels, groups, and supergroups.</p>

Table 7-5. Specification of Major Items of Equipment (Sheet 2 of 2)

SUBSYSTEM AND COMPONENT	FUNCTION	KEY PARAMETERS	APPLICABLE SPECIFICATIONS FROM DCAC 330-175-1	SPECIFIED BY EQUIPMENT DESIGNER
Termination Equipment Circuit Condition Monitoring Facilities VU meters and other level indicators Distortion measuring equipment Patching Facilities Distribution Frames Filters and channel termination sets Signalling Equipment Control Monitoring Equipment; i. e., fault alarm and automatic switch equipment	Interface control between and within multiplex subsystem and user's line.	1. Input and Output Impedance levels, and frequencies	1. Para. 3.2.2.5.1.2	As required
Power Generating Equipment Generators Switchgear Distribution Equipment Starting Equipment	Supply primary ac power for all technical electrical and electronic equipment and for all non-technical site requirements. Supply auxiliary power to technical load and various elements of nontechnical load.	1. Frequency regulation 2. Voltage regulation 3. Total load	1. Para. 3.6.1	Total primary power required
Environmental Control Heating and Air Conditioning Humidifiers and dehumidifiers Ventilation Air Filtering	Maintain proper environment - temperature, humidity, etc., for equipment and personnel comfort.	1. Temperature 2. Humidity 3. Pressure	1. Para. 3.6.1	As required

NAVELEX 0101, 112

- (1) 744 - 985 MHz
- (2) 1.7 - 1.85 GHz
- (3) 2.3 - 2.4 GHz
- (4) 4.4 - 5.0 GHz
- (5) 7.125 - 8.4 GHz
- (6) 13.5 - 16.5 GHz

The most common antenna used in LOS systems operating over these frequency ranges is the parabolic reflector incorporating either a horn or dipole feed device. However, it is impractical to use dipole feeds above 3 GHz. Parabolic reflectors to cover the frequencies listed are available in diameters of 4, 6, 8, 10, and 12 feet.

Horn feeds are manufactured in both rectangular and circular configurations. The rectangular horn is energized from rectangular waveguide and circular type is usually energized from circular waveguide.

Feed devices are linearly polarized in either the vertical or horizontal plane (plane polarization), polarized in both planes (dual polarization), or circularly polarized (rotating).

Feed methods for parabolic reflectors are classified either front feed or rear feed and are illustrated in figure 7-7.

Plane and dual polarized feed horns are shown in figure 7-8. A plane polarized dipole feed is shown in figure 7-9. A parabolic reflector with "offset" feed (see figure 7-10).

Antennas less than 50 feet above ground are usually mounted on a mast or tower when used at the frequencies listed above. When antennas, operating at the higher microwave frequencies, are to be elevated more than 50 feet, various considerations point to the following advantages gained from using a parabolic dish and passive reflector combination (see figure 7-12).

- o Long runs of expensive waveguide and associated pressurizing systems are eliminated.
- o Maintenance procedures are reduced.
- o High standing wave ratios present in long waveguide runs are reduced.
- o The free space and reflector losses are less than losses resulting from long waveguide runs.

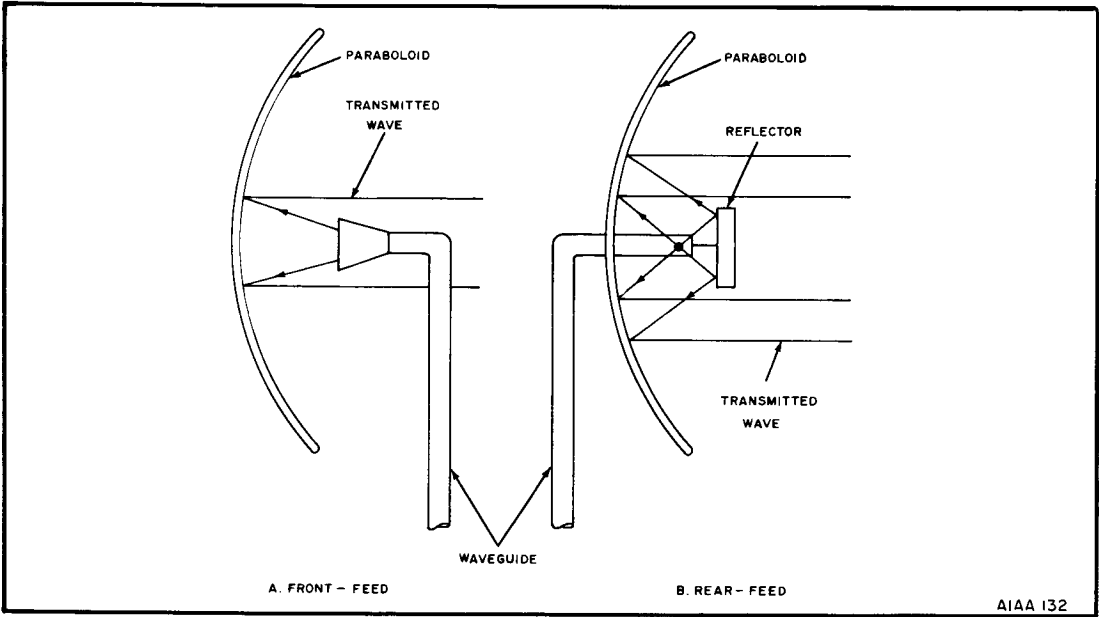

Figure 7-7. Parabolic Reflector Feed Methods

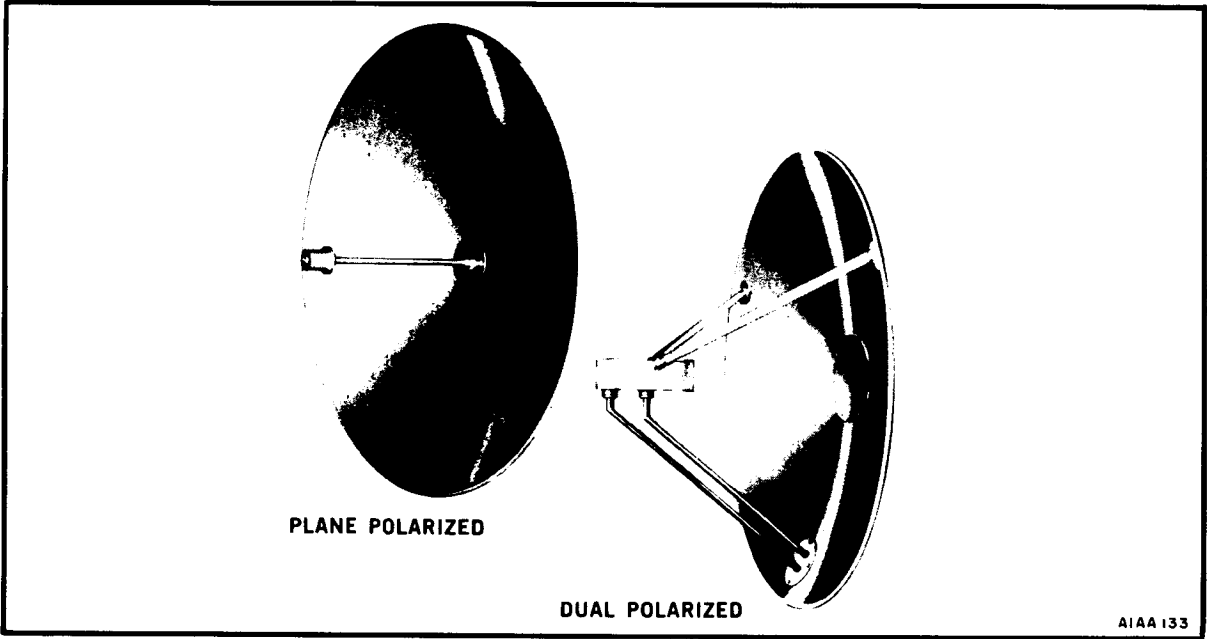

Figure 7-8. Polarized Feed Horns

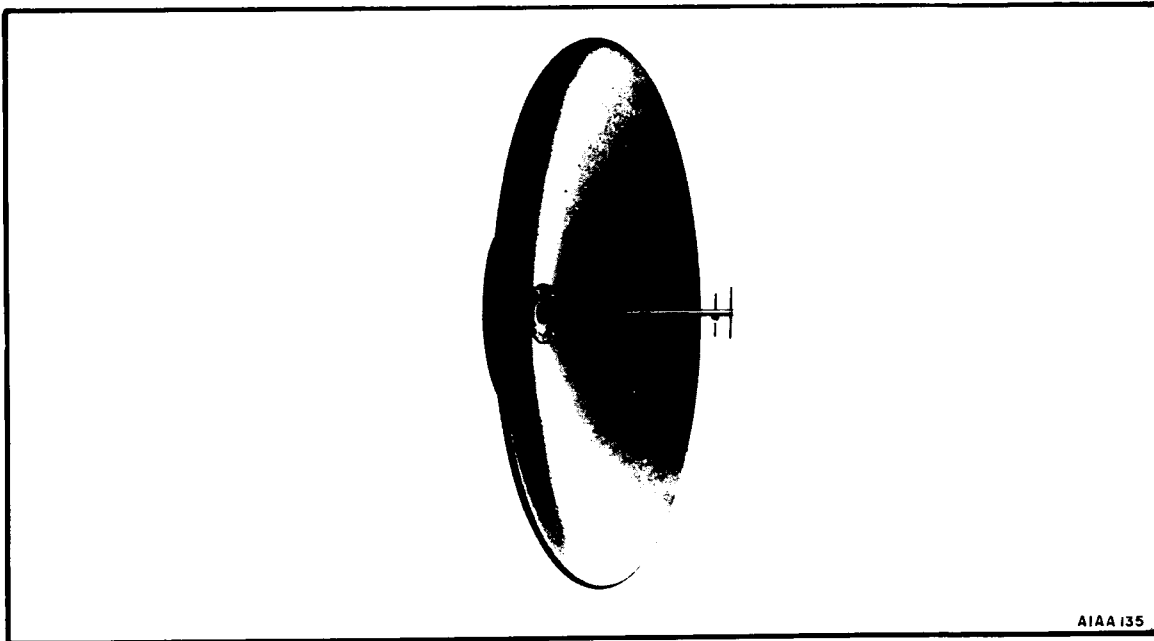

Figure 7-9. Plane Polarized Dipole Feed

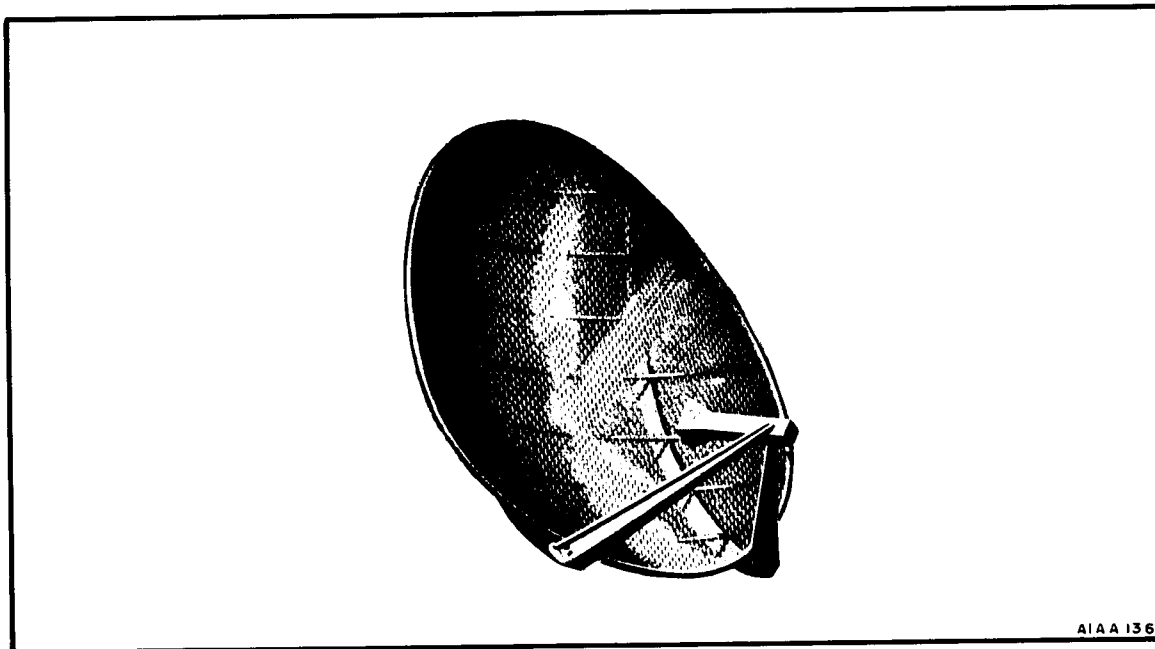

Figure 7-10. Offset Antenna
(Modified Parabolic Dish With Offset Feed)

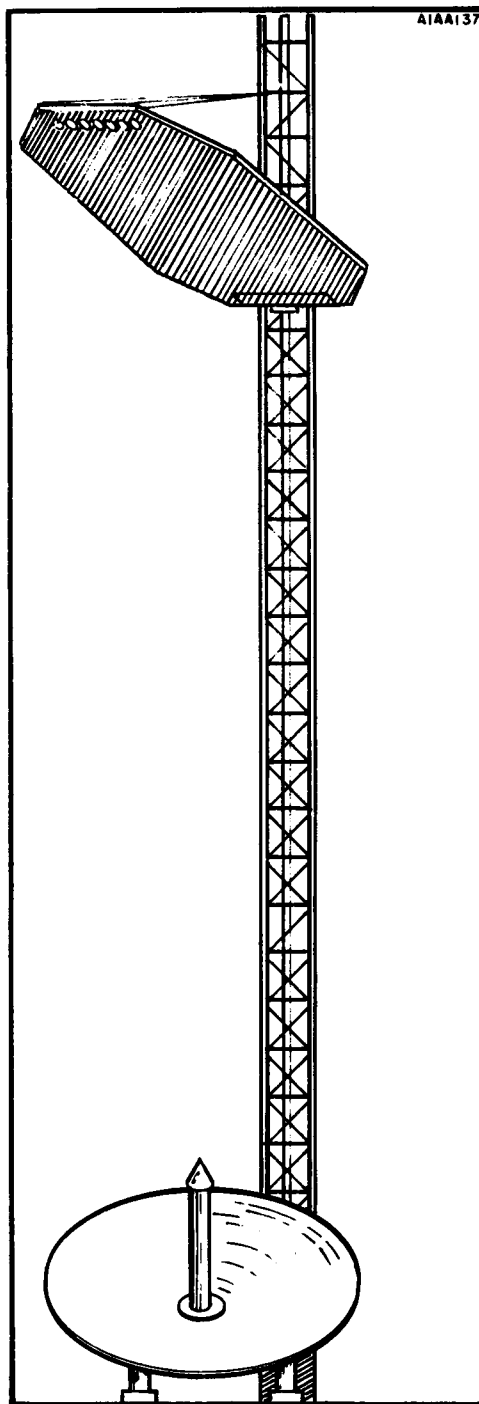

Figure 7-11. Parabolic Antenna and Passive Reflector Combination

Figures 7-12 and 7-13 depict some typical site layouts using passive reflectors. Figure 7-12 shows a standard layout with the parabolic antenna mounted near the tower base and the passive reflector atop the tower. A site layout where the equipment shelter is located at a lower elevation than the tower is illustrated in figure 7-13. This layout eliminates the need for a high tower to clear the obstruction between sites.

7.5.2 Transmission Lines/Waveguide

Three types of waveguides are available for use in microwave systems: standard rectangular, elliptical, and circular. Typical installation using these types of waveguide are shown in figure 7-14.

Data of rigid rectangular waveguide for the frequency range 3 to 10 GHz is presented in table 7-6, and an attenuation graph of high-conductivity waveguide is shown in figure 7-15.

For installations that use primary and standby microwave equipment, waveguide switches are used to connect either the primary or the standby equipment to the antenna, and to properly terminate the output of the unused equipment. Waveguide switches are usually electrically operated to provide for automatic switching applications.

A ferrite load isolator provides isolation between a signal source and its load with a resulting increase in power and improved frequency stability. The ferrite device accomplishes these results by reducing the standing wave ratio in the transmission line linking the signal source to the load. By placing the load isolator in the RF oscillator branch of the waveguide tee that links the antenna to the klystron RF oscillator and receiver input circuits, the RF oscillator is isolated from the other two branches of the tee.

When it is necessary to couple two or three microwave equipments to a single antenna, a waveguide circulator is used. This device, illustrated in figure 7-16, is similar to a duplexer. With an antenna connected to one arm and three microwave equipments connected to the other arms, or two equipments and shorting plate connected to the other arms, the following apply:

Attenuation from arms 1 to 2, 2 to 3, 3 to 4, and 4 to 1 is about 0.5 dB in each instance.

Attenuation between other combinations of arms is on the order of 20 dB.

7.5.3 Line Pressurization/Dehydration

Installations of rigid line are pressurized and dehydrated to eliminate chances of moisture accumulation and resulting changes in impedance or short circuits within the run. Dehydration is extremely important in runs subject to temperature changes due to either climatic conditions or indoors/outdoors runs. Dehydration will be accomplished with an automatic compressor/dehydrator unit.

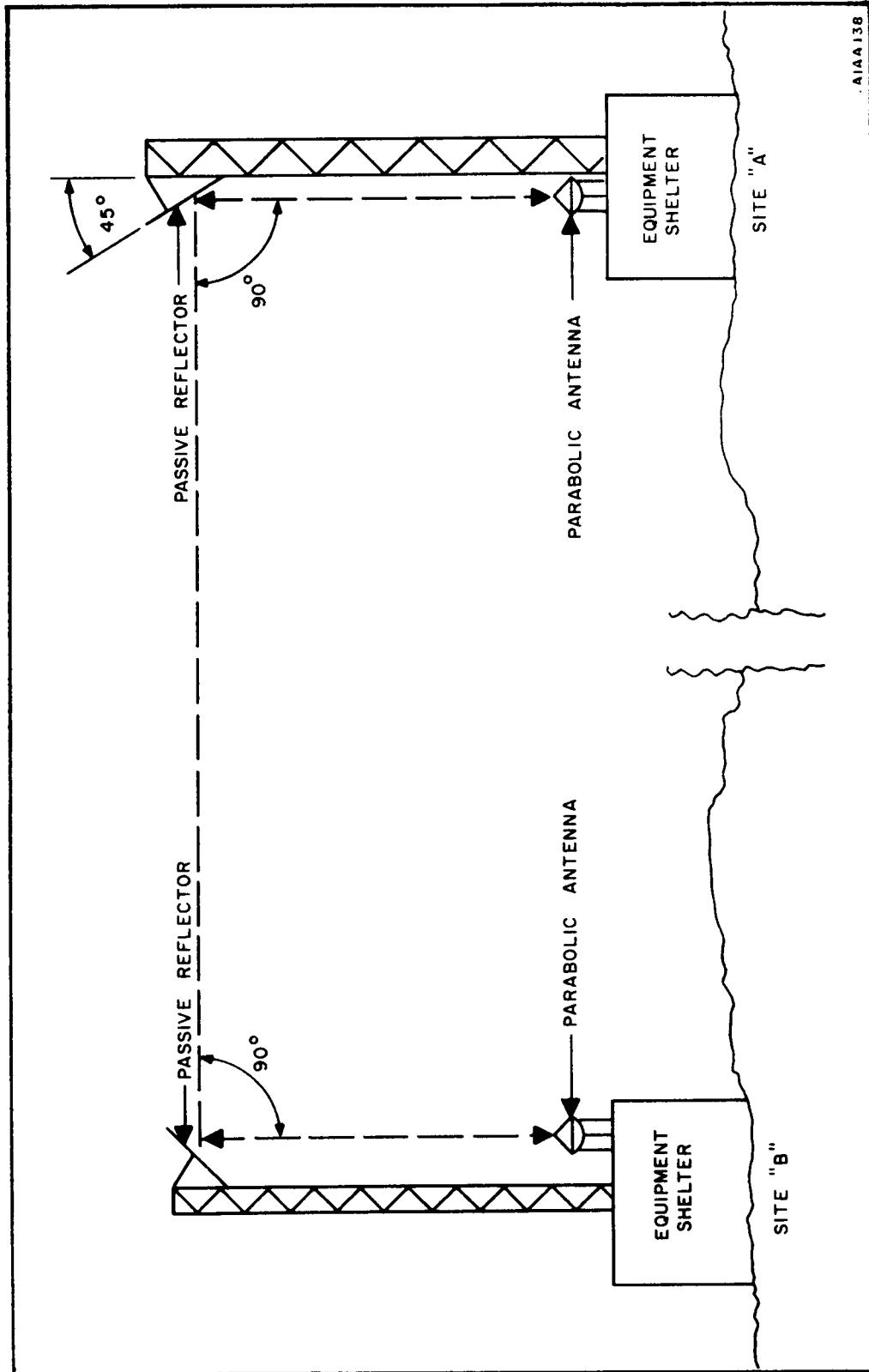

Figure 7-12. Passive Reflector Antenna Systems, Typical (Example 1)

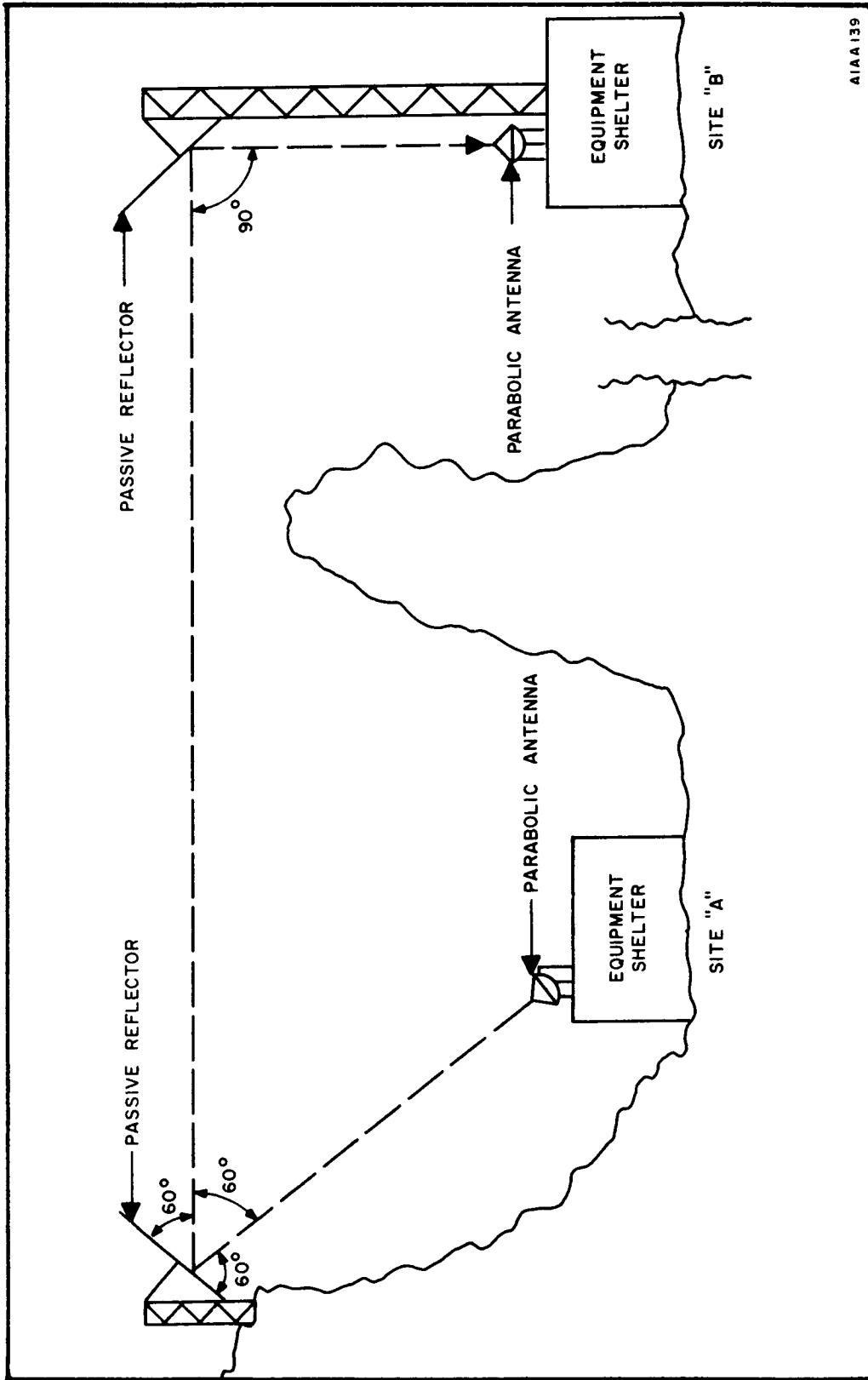

Figure 7-13. Passive Reflector Antenna System, Typical (Example 2)

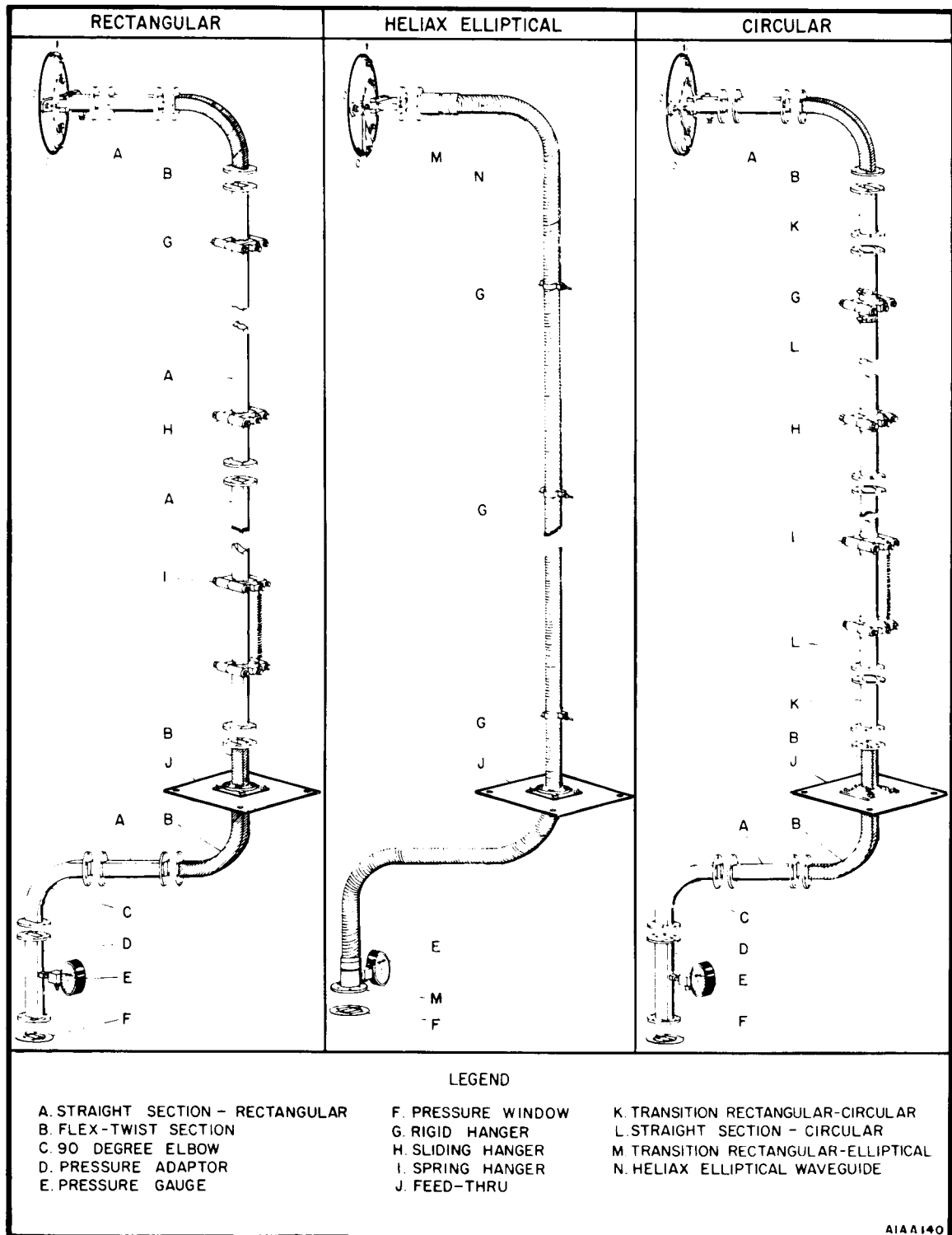

Figure 7-14. Waveguide Installations, Typical

Table 7-6. Rigid Rectangular Waveguide and Fittings

EIA WC Designation ()	Recommended Operating Range for TE ₁₀ Mode		Cut-off for TE ₁₀ Mode		Range in $\frac{2\lambda}{\lambda_c}$	Range in $\frac{\lambda_g}{\lambda}$	Theoretical cw power rating to lowest to highest frequency megawatts	Theoretical attenuation (db/100 ft)	Material Alloy	JAN WC Designation ()/U	JAN FLANGE DESIGNATION		EIA WC Designation ()	DIMENSIONS (inches)				Wall Thickness Nominal
	Frequency KHz	WaveLength (cm)	Frequency KHz	WaveLength (cm)							Choke ()/U	Cover ()/U		Inside	Tol.	Outside	Tol.	
340	2.20-3.30	13.63-9.08	1.736	17.27	1.58-1.05	1.78-1.22	3.1-4.5	.877-.572 .751-.492	Brass Alum.	112 113	553 554	340	3.400-1.700	±.005	3.560-1.860	±.005	0.080	
284	2.60-3.95	11.53-7.59	2.078	14.43	1.60-1.05	1.67-1.17	2.2-3.2	1.102-.752 .940-.641	Brass Alum.	48 75	54A 58A	284	2.840-1.340	±.005	3.000-1.500	±.005	0.080	
229	3.30-4.90	9.08-6.12	2.577	11.63	1.56-1.05	1.62-1.17	1.6-2.2					229	2.290-1.145	±.005	2.418-1.273	±.005	0.064	
187	3.95-5.85	7.59-5.12	3.152	9.50	1.60-1.08	1.67-1.19	1.4-2.0	2.08-1.44 1.77-1.12	Brass Alum.	49 95	148B 406A	187	1.872-0.872	±.005	2.000-1.000	±.005	0.064	
159	4.90-7.05	6.12-4.25	3.711	8.078	1.51-1.05	1.52-1.19	0.79-1.0					159	1.590-0.795	±.004	1.718-0.923	±.004	0.064	
137	5.85-8.20	5.85-8.20	4.301	6.970	1.47-1.05	1.48-1.17	0.56-0.71	2.87-2.30 2.45-1.94	Brass Alum.	50 106	343A 440A	137	1.372-0.622	±.004	1.500-0.750	±.004	0.064	
112	7.05-10.00	4.25-2.99	5.259	5.700	1.49-1.05	1.51-1.17	0.35-0.46	4.12-3.21 3.50-2.74	Brass Alum.	51 68	51 131A	112	1.122-0.497	±.004	1.250-0.625	±.004	0.064	

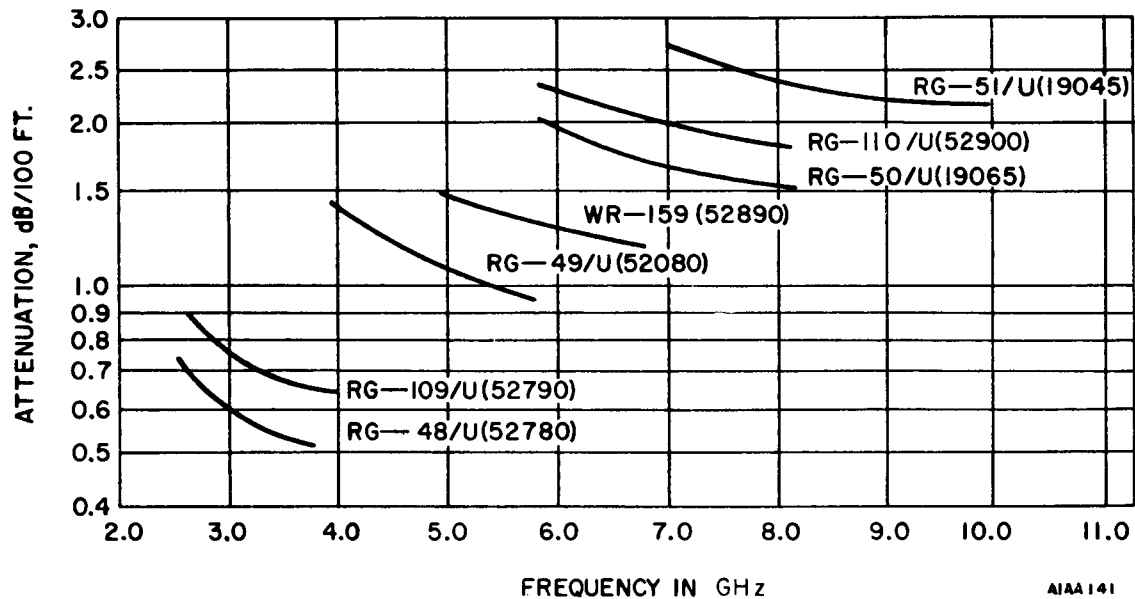

Figure 7-15. Attenuation of Oxygen - Free High Conductivity Waveguide

7.5.4 Radio Equipment

A microwave radio relay link is composed of two terminal stations and, in most cases, a number of repeater stations. Terminal stations are situated at the ends of a communication link and the repeater stations between.

The RF portion of a terminal and repeater station consists of RF transmitters, RF receivers, and associated power supplies, terminal and repeater stations, or between repeater stations.

Remodulating and IF heterodyne repeaters are used:

- o A remodulating repeater consists of two terminal radio equipments back-to-back, the receiver output from one feeding the transmitter input of the other.
- o In the heterodyne type of repeater, the incoming carrier is heterodyned down to frequency which may be easily amplified (usually 70 MHz), and after amplification heterodyned back up to the transmitting frequency.

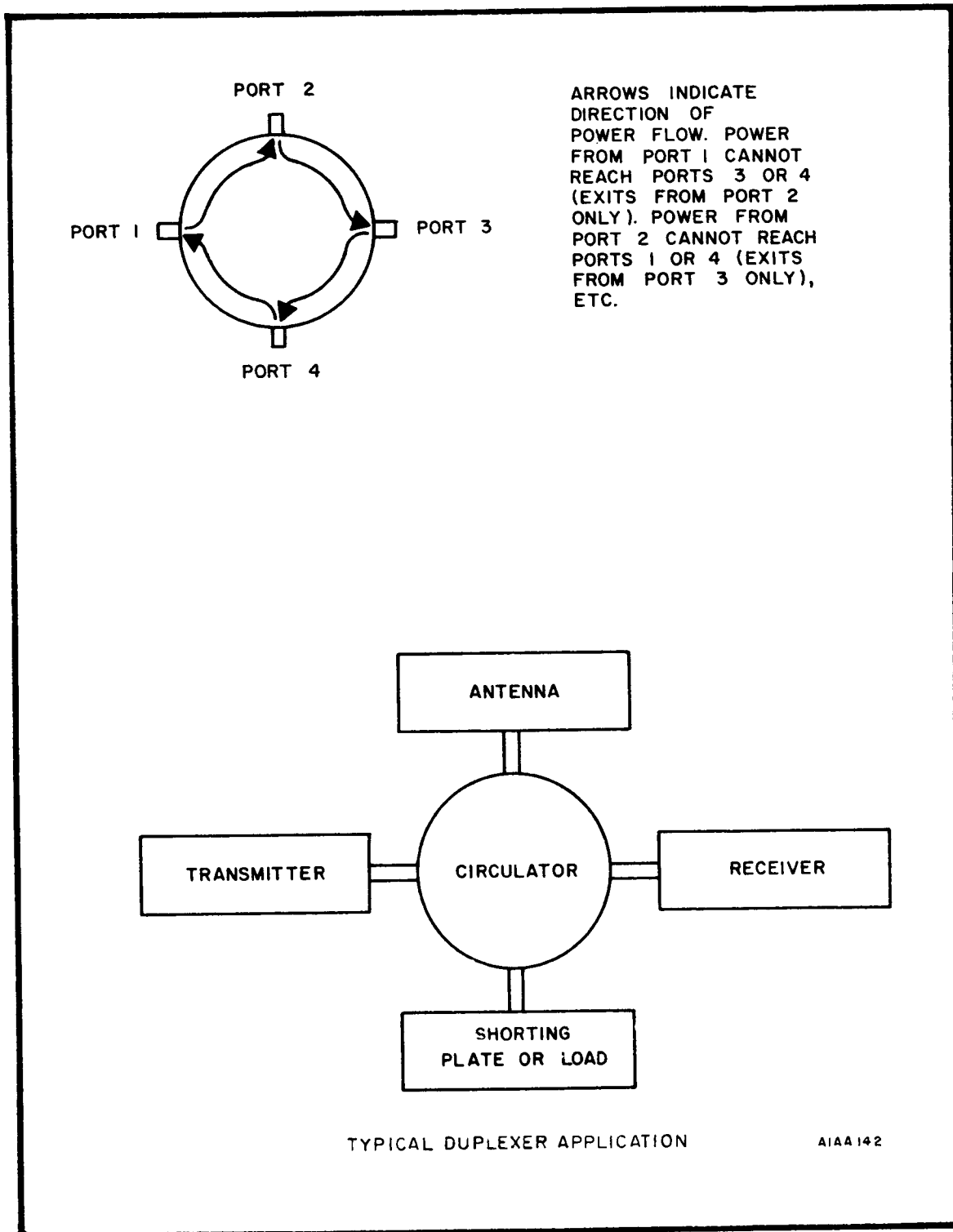

Figure 7-16. Four - Port Circulator

The RF equipments in terminal and repeater stations are basically the same. Terminal equipment can be converted to repeater equipment and vice versa by making a few wiring changes on terminal boards provided for this purpose. Microwave equipments currently available reflect the latest "state-of-the-art" techniques in solid-state design and packaging and comply with the applicable portions of DCAC 330-175-1.

- a. Transmitter. In general, a microwave transmitter includes:
- o Exciter baseband group.
 - o Modulator group.
 - o Power amplifier.
 - o Power supplies.

In a typical microwave transmitter (see figure 7-17) the exciter baseband group includes a pilot oscillator and pilot tone detector for alarm functions, pre-emphasis network, and an insertion amplifier. The modulator group includes the klystron oscillator, linearizer, filters, automatic frequency control circuitry (AFC), and a power monitor. In operation, the output of a telephone multiplex terminal which consists of frequency multiplexed AM carrier signal, is applied to the terminal transmitter. This input signal (baseband signal) could also be a television signal or any other form of signal that is to be transmitted over a microwave radio path. A pre-emphasis network emphasizes the high baseband frequencies relative to the low, to gain certain signal-to-noise advantages in the radio system. The insertion amplifier accepts the pre-emphasized signal, amplifies and applies it to the klystron oscillator in the modulator group. With this method, the input signal from the multiplexer directly modulates the output frequency of the transmitter resulting in a frequency modulated wave. Since the klystron modulation characteristic becomes nonlinear with increasing deviation, a "linearizer" couples a nonlinear reactive component back into the klystron cavity and compensates for its nonlinearity. This "linearization" technique allows optimum performance for modulation densities as high as 1200 channels.

The transmitter output signal (on the order of 1 watt) is passed through an output filter to reduce spurious emissions to a negligible level, and then applied to the antenna. When higher power (5 watts) is required, particularly in heterodyne applications, a traveling wave tube (TWT) is used as a final amplifier. This device, comparable to a klystron, as far as ease of tuning and life-expectancy is concerned, can provide up to 40 dB of RF gain.

Modern microwave transmitters are designed to exhibit a high degree of frequency stability. Crystal-referenced AFC systems can correct transmitters to within 0.002 percent of their assigned output frequency. DCS Standard DCAC 330-175-1 states that carrier frequency stability shall be controlled to within 0.01 percent for all operating conditions. This degree of stability is required for full route development and for interference coordination with other systems. By sampling the RF output and mixing it with a crystal reference frequency, AFC is obtained. By sampling

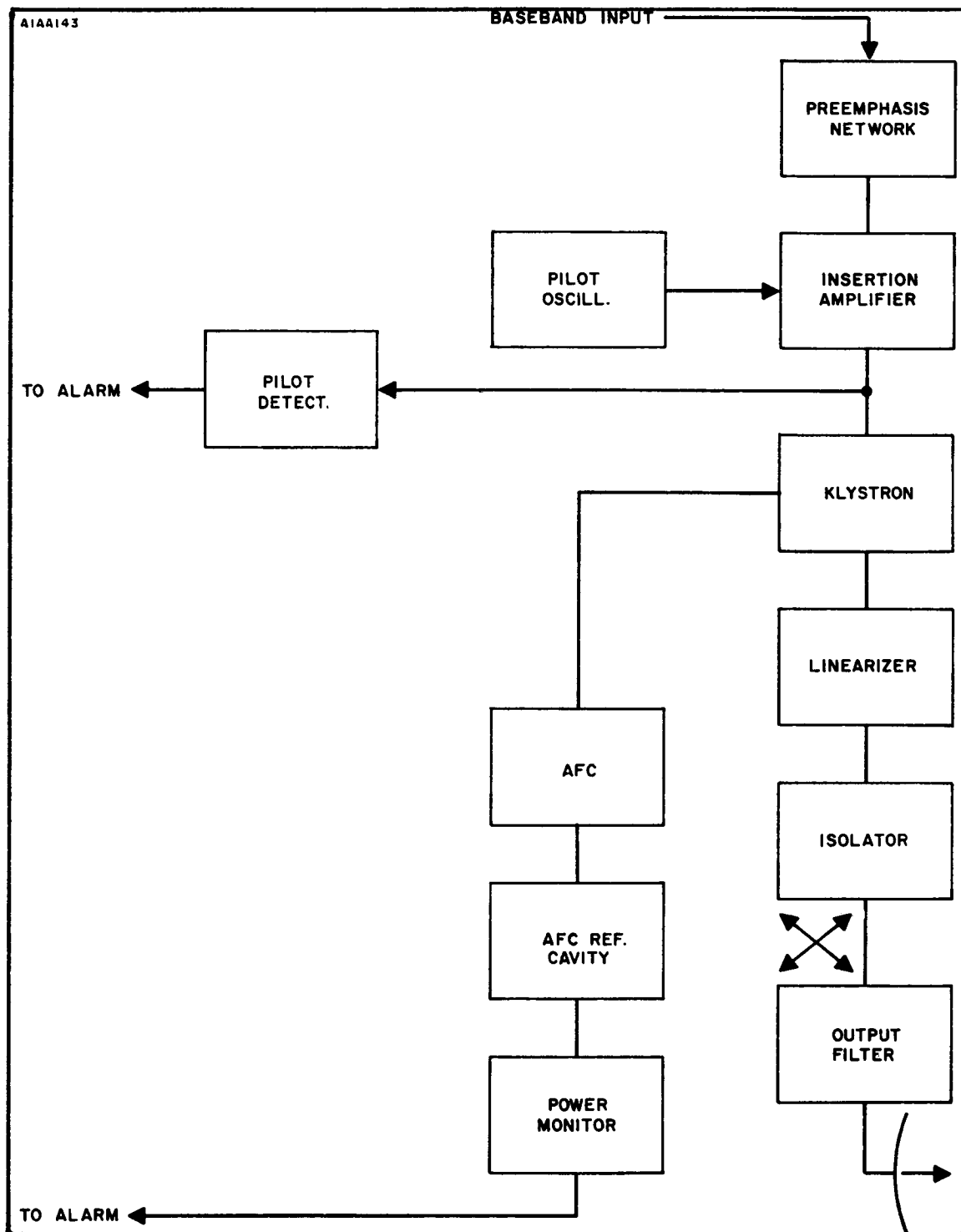

Figure 7-17. Microwave Transmitter, Typical

the RF output and mixing it with a crystal reference frequency, AFC is obtained. The resultant signal is converted to a lower frequency and applied to a discriminator. The DC error voltage output from this discriminator is amplified and applied to the klystron repeller grid.

Typical transmitter system performance specifications are shown in Table 7-7.

Table 7-7. Typical Transmitter Characteristics

PARAMETER	DESCRIPTION
Operating Frequency Range:	5.9 to 7.2 GHz 7.2 to 8.5 GHz
Type of Modulation:	FM (CCIR pre-emphasis)
Power Source:	24 VDC 48 VDC (optional) 115/230 VAC
Power Output:	+30 dBm (1 watt) min.
Frequency Stability:	$\bar{+}0.01\%$; $\bar{+}0.002\%$ with AFC option
Carrier Deviation:	$\bar{+}3$ MHz
Input Impedance:	75 ohms unbalanced
Sensing Options:	RF carrier level, continuity pilot
Rack Dimensions:	Height: 8 feet Width: 19 inches Depth: 18 inches

b. Receiver. A microwave receiver consists of:

- o RF-IF Group
- o Local Oscillator Group
- o Demodulator Group
- o Receiver Baseband Group.

The RF-IF group includes a preselector filter, ferrite, isolator, mixer, and IF amplifier. The local oscillator group consists of a klystron oscillator and automatic frequency control (AFC) circuitry. The demodulator group consists of a limiter, discriminator, and de-emphasis circuitry. The receiver baseband group includes a pilot detector, noise limiting circuitry, a baseband amplifier, filters, and demultiplexing equipment.

In operation, a signal from the antenna passes through a waveguide preselector, that provides a high IF image rejection ratio and eliminates interference from adjacent RF channels, and enters a waveguide filter tuned to its frequency. The filter bandpass is designed to reject all unwanted signals. The signal next passes through a ferrite isolator which minimizes intermodulation noise and holds the antenna system VSWR to a reasonable value (less than 1.2:1) in accordance with DCAC 330-175-1 requirements. The incoming signal is mixed with the local oscillator output to produce the standard 70 MHz IF frequency. The IF output is amplitude limited and applied to an AFC discriminator, the output of which is used to control the frequency of the klystron oscillator. The limiter output is also applied to a signal (IF) discriminator, a de-emphasis circuit, and a noise muting (squelch) circuit that disconnects the baseband amplifier and demultiplexing equipment if system noise increases above a preset level. After the squelch circuit, the signal is passed to the baseband amplifier and then to the demultiplexing equipment where the original intelligence is retrieved.

Typical characteristics of a microwave receiver are shown in table 7-8.

Table 7-8. Typical Receiver Characteristics

PARAMETER	DESCRIPTION
Receiver	
Noise Figure	14 dB or less
Local Oscillator	Reflex Klystron with AFC loop
Preselector	5-section waveguide filter
IF Center Frequency	70 MHz
RF Bandwidth	15 MHz 3-dB bandwidth, standard receiver optional narrow band IF filters for low traffic application
Peak Deviation	- +3 MHz
Capability	
Output Impedance	75 ohms unbalanced; 26 dB minimum return loss

A block diagram of a typical microwave receiver is shown in figure 7-18. Though not shown in the diagram, sensing and alarm functions are integral to all microwave communications.

7.5.5 Alarm Functions

In the transmitter these functions are provided by applying a pilot tone to the baseband input and monitoring the output. The power output of the klystron is also monitored. These monitored signals are applied to logic circuits that determine whether a variation in pilot tone or klystron power is a fault condition. If standby equipment is available, its condition will also be indicated. In the event of a transmitter failure, automatic switchover is effected. Should primary power fail, automatic switchover to a battery bank takes place. Usually terminal connections are available for remote switching of transmitters. Local control of switchover is accomplished by means of a manual switch. Pilot lights indicate which terminal unit is on the air and alarm contact provide for remote alarm.

In the receiver, the desired signal usually passes through a pilot bandstop filter and a standby switch prior to entering the demultiplexer. The standby switch connects the demultiplex circuits. A pilot bandpass filter and pilot detector are connected across the baseband output to monitor receiver operation. The output of this detector and the local oscillator power monitor are applied to an alarm sensing and switching unit. If either monitor indicates a fault and a fade does not exist, the switching unit will transfer to standby operation, if the standby unit itself is not at fault. As in the transmitter, both local and remote alarms as well as local control are provided.

Sensing Options:	Baseband noise level, continuity pilot; RF carrier level
Power Source:	24 VDC, 48 VDC (optional) 115/230 VAC
Frequency Stability:	$\bar{0}.01\%$; $\bar{0}.002\%$ with AFC option

7.5.6 Standby Equipment

A high degree of system reliability can be obtained when "standby" equipment is used to supplement the primary equipment. However, standby equipment should only be specified for stations where the greatest benefit will be realized, for example, an isolated station difficult to reach under adverse conditions. Automatic switching equipment (as mentioned previously) is available to place the standby equipment in operation if primary equipment fails.

7.5.7 Signalling

In-band signalling at 2600 Hz and 2280 Hz is commonly used in the United States and Europe, respectively. The 2600 Hz tone has been used commercially for some years,

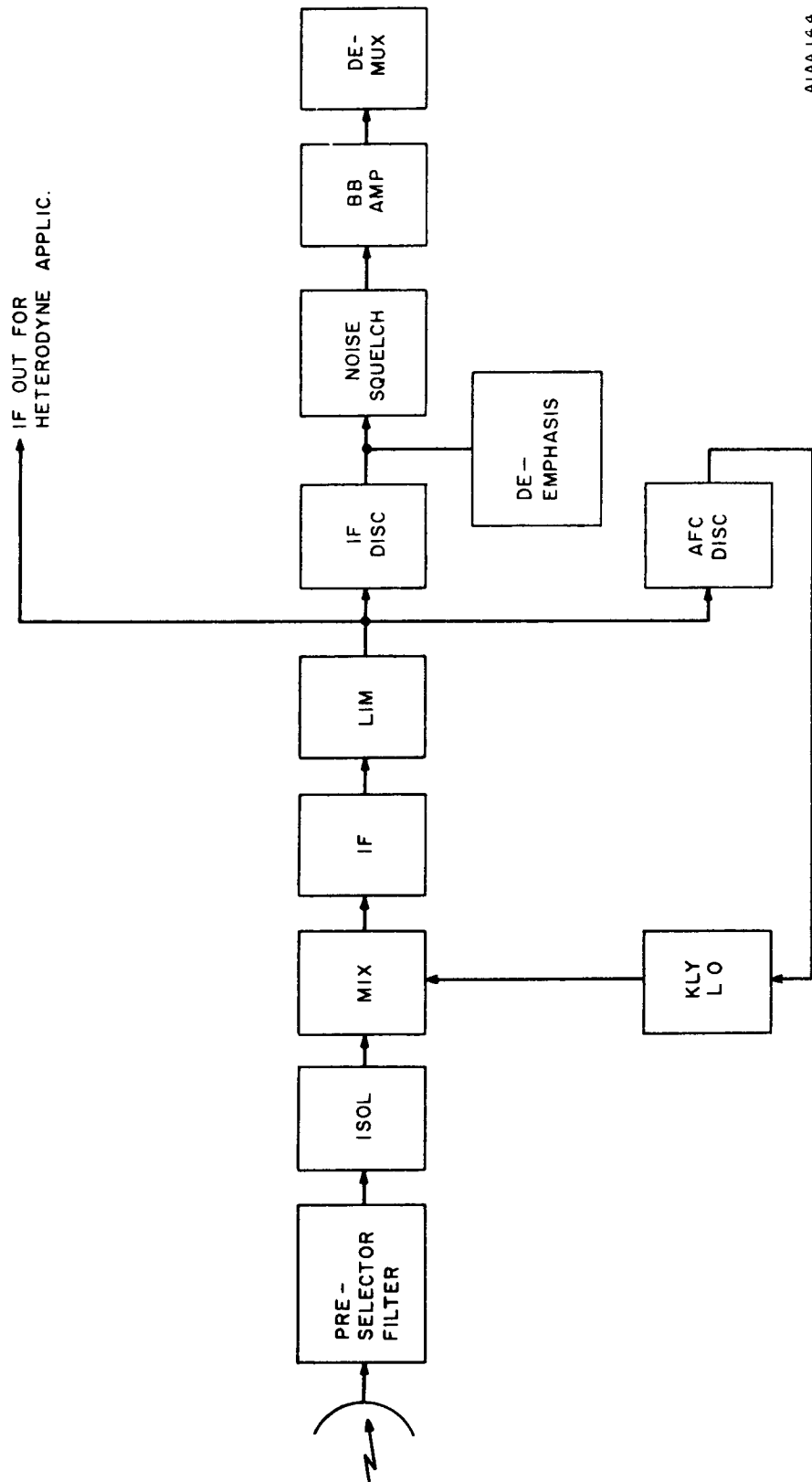

A1AAA144

Figure 7-18. Microwave Receiver (No Diversity and Alarms), Typical

and where interface is required with this equipment, provisions for this form of signalling must be made. The International Telegraph and Telephone Consultative Committee (CCITT) provides for 2280 Hz "in-band" signalling on international circuits. With either type the entire voice band is available for intelligence at all times except during the signalling period. With "out-of-band" signalling, as specified by DCA Standards, the voice band is continuously available but with a narrower bandwidth to permit insertion of 3825 Hz tones. Regardless of the type of signalling selected (in-band or out-of-band), E and M signalling is normally provided on the user's lines. Ringdown, loop signalling, or subscriber signalling may also be provided depending on the user's equipment. Typical in-band signalling and ringdown loop signalling facilities are illustrated in figure 7-19.

7.5.8 Order Wire

In most relay systems, one voice channel will be withheld from voice transmission order to use it as a service wire, or order wire. This channel will inform the nearest terminal station of a fault existing at a relay station, together with some indication of the type of fault existing. A complicated system of blocking is used, so that two repeaters cannot "report" trouble at the same time, which would happen in the event of a failure of one station disrupting the operation of an adjoining station.

7.5.9 Spare Parts

During the course of preventive maintenance inspections, it will be noted from time to time that the performance of some components has deteriorated. Rather than wait for the component to become weaker or to fail completely and cause system interruptions, it is considered good maintenance practice to replace such weak components during the inspection. Although components are replaced before their full service life has been realized, service interruptions can be avoided in this manner. This practice will, in turn, increase the expected replacement parts cost for an operating system; however, the increase is justified on the basis of increased system reliability and the saving of additional manpower costs that would be incurred in making special rush trips to unattended stations to restore station operation.

Based on the known degree of component reliability of current installations, and considering a preventive maintenance program such as that described above, it can be expected that in a year's time a microwave system will require replacement parts equal in cost from 1 to 2 percent of the initial cost of the equipment, and replacement tubes equal in quantity from 25 to 30 percent of the total number of operating tubes. The tube replacement ratio, as noted above, is considerably higher than the part replacement ratio. This is generally to be expected because tubes have a higher failure incidence rate; and also, the relative performance of operating tubes is more easily checked than the relative performance of other components, so that more frequent tube replacements naturally result.

Supply depots should be established at convenient locations along the microwave system so that maintenance personnel will have the most frequently needed spare parts and supplies available. The stock carried at these depots should include components,

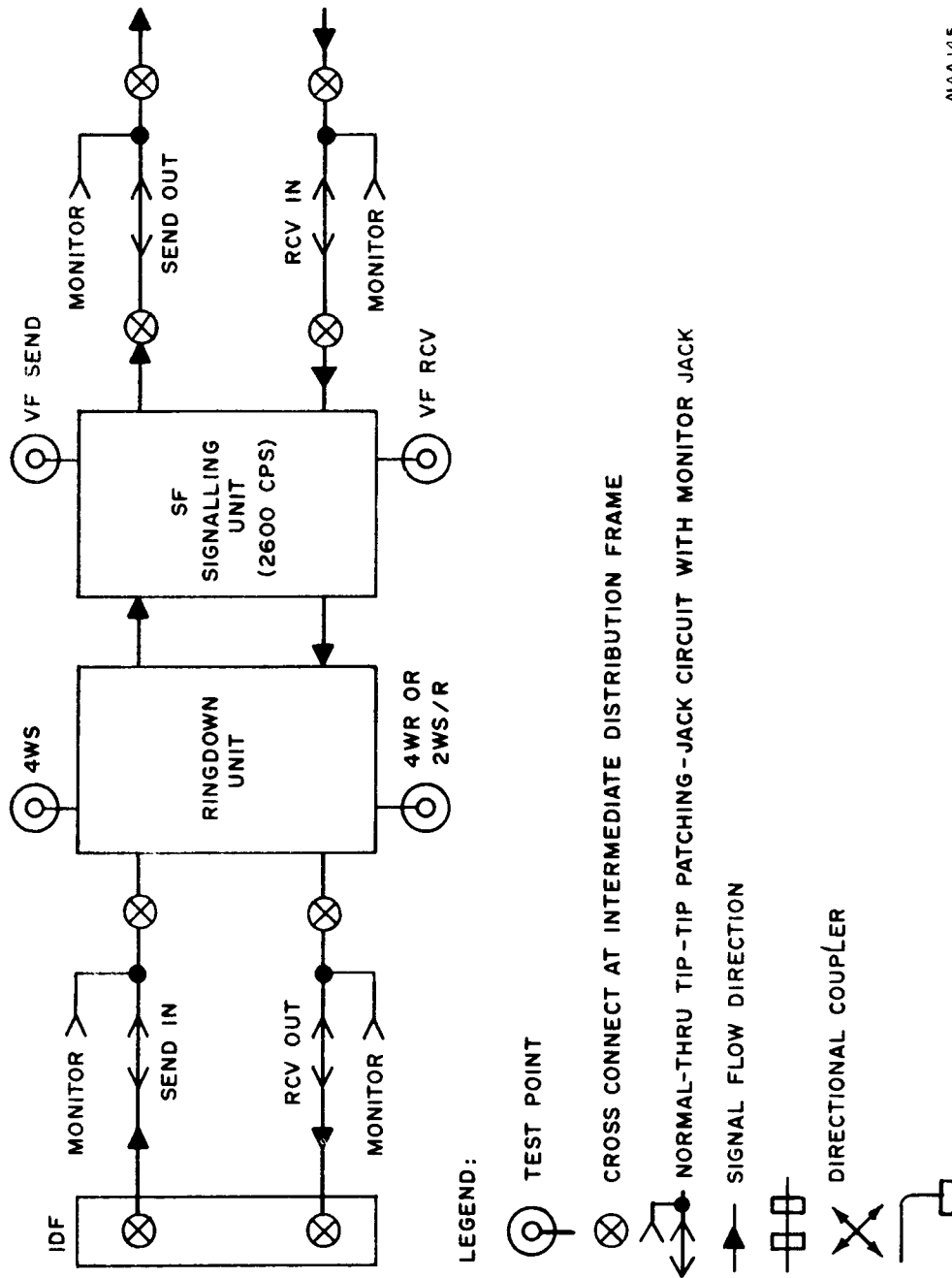

AN44145

Figure 7-19. Jackfield and Signalling and Termination Units

subassemblies, and other parts that experience shows to have a high replacement factor. Some parts, such as tubes, crystals, critical relays, etc., should be stocked at the stations themselves in a ratio of at least 1:1.

7.5.10 Test Equipment

In order to properly test and service a microwave communications system, maintenance personnel should have a thorough understanding of the equipment's physical make-up, operational characteristics, capabilities, and limitations, and should be familiar with the circuit theory of operation. It is equally important that the proper test equipment be available for utilization by these personnel. Each field maintenance man should be equipped for making routine measurements. Typical equipments recommended for this purpose include a microwave test set, an IF/MF test set, a multimeter, and an oscilloscope; these units must be compatible with the microwave system in which they are used. As the area of maintenance progresses from on-site field maintenance to depot maintenance, the quantity and requirements of the test equipment to perform the maintenance procedures will increase.

A list of test equipment for use in the alignment and adjustment of a typical microwave communications system is given in table 7-9. This list is for use with systems employing microwave equipment and time-division multiplex equipment. It includes the type of test equipment necessary, and the required characteristics of this equipment. Those pieces of equipment which are applicable for general field maintenance are indicated with an asterisk (*).

Table 7-10 lists the test equipment required for laboratory (depot maintenance) measurements for a typical microwave system employing microwave equipment and time-division multiplex equipment. The item numbers under the EQUIPMENT NEEDED heading refer to the test equipment itemized in table 7-9.

7.5.11 Tools Required for Maintenance

It is important that maintenance personnel have a thorough understanding of the equipment utilized in the system, and that they have the proper test equipment to perform the required maintenance checks. In addition to the above, the maintenance personnel must have the proper tools to efficiently repair the malfunctioning equipment when the defects are located. Of course, the maintenance man should know how to properly use the tools required for maintenance.

Table 7-11 lists the quantity and type of tools generally included in a tool kit required by a field serviceman to properly maintain a microwave communications system. In addition to these tools, the special tools indicated in the equipment manuals should be included.

Table 7-12 lists the type of tools required at a typical microwave station. The quantity of these tools will depend on the amount and type of equipment installed. The special tools indicated in the equipment manuals should also be included. Where the maintenance schedules require work on gasoline engine-generators, shelters, towers, etc.,

additional tools may be required, depending on the type of equipment and hardware involved.

The tools required at a microwave system centralized maintenance depot are essentially the same as those required at a microwave station. However, the quantity of these tools will depend on the number of maintenance personnel assigned to the depot, the work load at the depot, and the type and quantity of equipment utilized in the system. In addition, special equipment such as a spray-painting equipment, a drill press, and other shop equipment may be required at the depot to facilitate the overhaul of the microwave system electronic and electrical equipment.

Table 7-9. Typical Test Equipment, List of

ITEM NO.	EQUIPMENT	NECESSARY CHARACTERISTICS
1	*Signal generator	Range: 10 Hz to 1 MHz; max output; 3V into 600 ohms.
2	*Multimeter	Volts: 2.5 to 1000V full scale (dc: 20K ohm/V, ac: 1K ohm/V); resistance: 0 to 0.6 megohm; current: 100 μ a to 10 AMP. full scale.
3	*Vacuum-tube voltmeter	Volts: 1.5 to 1500V full scale (dc: 10 megohms, ac: 5 megohms); resistance: 0 to 100 megohms.
4	Oscilloscope	Vertical: 0.1V/in. (peak to peak), 3-dB bandwidth 10 Hz to 1 Hz; driven sweep or recurrent sweep 0.15 sec to 4 μ sec; voltage and time calibration.
5	Variable autotransformer	1.72 kva; nominal input: 115V, 60 Hz; output: 0 to 135V, 10 AMP. (max. 15 AMP.).
6	Square-wave generator	Freq: 100 kHz; max. output: 8V into 600 ohms; sync output.
7	Signal generator	Range: 70 to 110 mHz; max. output: 20 mv to 53 ohms.
8	Visual-alignment generator	Range: 70 to 110 mHz; max. sweep width: 15 mHz; marker osc; crystal calibrator; max. output: 50 mv
9	*Test sound-powered handset	4-wire; separate trans and rec plugs; impedance: 600 ohms.
10	*Volume-level indicator	Scale: minus 20 to plus 3 vu; scale zero: plus 4 to plus 20 vu in 28-vu steps; impedance: 7500 ohms.
11	Variable attenuator	Range: 2 to 20 dB; max. VSWR: 1.2; line: RG 50/U; freq range: 5.9 to 7.8 kmHz.
12	Directional coupler	Nominal coupling: 30 dB; line: RG 50/U; freq range: 5.9 to 7.8 kmHz.
13	Detecting section	Max VSWR: 1.5; line: RG 50/U; freq range: 5.9 to 7.8 kmHz.
14	Standing-wave detector	Slotted section: 8-25/32 in. insertion length; broad-band probe; line: RG 50/U; freq range: 5.9 to 7.8 kmHz.
15	Matching load	Max. VSWR: 1.05; line: RG 50/U; freq range 5.9 to 7.8 kmHz.
16	Cavity frequency meter	Loaded Q: 7000; accuracy: 0.01 percent freq range: 5.9 to 7.8 kmHz.
17	Directional coupler	Nominal coupling: 24 dB; line: RG 50/U; freq range: 5.9 to 7.8 kmHz.
18	Power meter	Range: 0.02 to 5 mw; accuracy: 5 percent of full scale.

Table 7-9. Typical Test Equipment, List of (Continued)

ITEM NO.	EQUIPMENT	NECESSARY CHARACTERISTICS
19	Silicon diode	Use with item 13 when item 13 is used as a crystal detector.
20	Barretter	Use with item 13 when item 13 is used as a barretter mount.
21	*Microwave test set	Range: 5825 to 7725 mHz (6 bands); FM modulation 1000 Hz, 0 -- 15-mHz deviation; power meter; freq meter; two transducers.
22	Klystron power supply	Input: 117V, 60 Hz; outputs (regulated): minus 750, 100 ma; minus 1075 VDC; variable - 75 v; 6.3 VAC isolated from ground.
23	Step attenuator	Range: 0 to 100 dB in 1 - dB steps; impedance: 600 ohms; audio.
24	Step attenuator	Range: 10 to 51 dB in 1 - dB steps; impedance: 53.5 ohms; freq: 50 to 110 mHz.
25	Standard voltmeter	DC; scales (full): 1.5, 15, and 150V; accuracy: 0.5 percent.
26	Standard voltmeter	DC; scales (full): 200, 500, and 1000V; accuracy: 0.5 percent.
27	*Standard voltmeter	AC; scales (full): 150 and 300V, rms; accuracy: 0.5 percent.
28	Noise meter (optional)	Range: minus 6 to plus 85 dBm; impedance: 600 ohms; "FIA" frequency weighting.
29	*Klystron tuning tool	Special insulated tool.
30	*Capacitor tuning tool	Corning Glass capacitor tool.
31	*Low-capacity screw driver	Insulated handle; small metal blade.
32	*Coaxial cable	RG 59/U (AN number).
33	*Coaxial cable	RG 55/U (AN number).
34	*Connector	UG 260/U, BNC plug (AN number).
35	*Connector	N. T. 49195, UHF plug (AN number).
36	*Test lead	Hook-up wire; pin plugs, test prods.

Table 7-10. Test Equipment for Laboratory
(Depot Maintenance) Measurement

MEASUREMENTS	EQUIPMENT NEEDED (ITEM NO.)
MICROWAVE RADIO RELAY EQUIPMENT	
R-F Section	
Transmitter power	21
Transmitter frequency	21
Received signal strength	21
A-G-C vs received signal calibration	21
Klystron (bench tuning)	4, 11, 12, 13, 16, 18, 19, 20, 22, & 33
Wave-guide phaser and variable attenuator	2, 4, 11, 13, 15, 17, 19, 21, 22, & 33
Wave-guide discriminator	4, 15, 16, 17, 22, & 33
Wave-guide receiver leg	2, 3, 4, 11, 13, 16, 17, 19, 22, 31, & 33
Wave-guide transmitter tee	4, 11, 12, 13, 14, 16, 19, 22, & 33
I-F Section	
Signal-to-noise ratio	1, 3, 4, 7, 21, & 32
I-F discriminator	7, 8, 24, & 34
I-F sensitivity	2, 7, & 24
Receiver bandpass	7, 8, & 24
Video Section	
Video response	1, 4, & 23
Transient response	4 & 6
Insertion	1, 4, 9, & 23
Feed-back loop	1, 4, & 23
Modulation capability	1 & 4
Hum, ripple, and distortion	1, 3, 4, 23, 28, & 29
Miscellaneous Sections	
Power supplies	2 & 5
Servo chassis	2
Blowers	2
Heaters	2
Controls	2
TIME-DIVISION MULTIPLEX EQUIPMENT	
Over-all sensitivity (back-to-back)	1, 9, & 10
Channel characteristics	1, 3, 4, 23, 28, 29, 32, & 35
All other tests and measurements	2, 4, & 35
TELEPHONE EQUIPMENT	
Circuit noise	32
Circuit level	3, 9, & 32
SHELTER EQUIPMENT	
Lighting	2
Motor-generators	2 & 20
Primary power lines	2 & 30

Table 7-11. Field Maintenance Tool Kit, Typical

QTY	ITEM	QTY	ITEM
1	Tool case	1	Quickwedge screwdriver
1	1/4-in. utility electric drill	1	Scriber, double point
1	Threading kit, including taps and dies	1	Point screwdriver
	4-40 10-32 8-32	1	4-1/2 in. screwdriver, narrow
	6-32 1/4"-20	1	Solder gun
1	Plastic utility box, 9 compartments	1	Flashlight, with batteries
1	Drill gauge	1	Extension cord, 15 ft
2	No. 44 Drill	1	Alignment tool
2	No. 36 Drill	1	Hex and spline wrench kit
2	No. 33 Drill	1	Multimeter
2	No. 29 Drill	1	Soldering aid
2	No. 28 Drill	1	Tube puller
2	No. 21 Drill	1	7-pin tube straightener
2	No. 19 Drill	1	9-pin tube straightener
2	No. 11 Drill	1	Wire stripper
2	No. 7 Drill	1	Wrench kit
2	1/4-in. Drills	1	Slip pliers
12	Each - bolt w/nut and lockwasher	1	Hand Clamp tool
	4-40 3/4" 8-32-1"	1	6-ft pocket rule
	8 32 1" 10 32-1"	1	Roll rosin-core solder, 1 lb.
1	No. 410 Channel-lock gripping pliers	1	No. 99 Xcelite tool roll
1	No. TH-6 Hold-E-Zee screwdriver	1	Klystron tuning tool
1	No. TH-4 Hold-E-Zee screwdriver	1	IF discriminator tuning tool
1	No. TH-7 Hold-E-Zee screwdriver	1	Capacitor tuning tool
1	No. PS-2 Hole-E-Zee screwdriver	1	Roll electric tape
1	Small ball peen hammer	1	60-watt soldering iron with small tip
1	Diagonal cutters	1	Center punch
1	Pair long-noise pliers	1	File kit
1	6-in. adjustable wrench	1	Gram gauge
1	Electrician's knife	1	Burnishing tool

Table 7-12. Station Maintenance Tools, Typical

ITEM	TYPE
Channel-lock gripping pliers	9-1/2 in.
Screwdriver	6-in.
Screwdriver	4-in.
Screwdriver	8-in.
Screwdriver	1-3/4 in, stubby
Screwdriver	Phillips No. 2503 (for Phillips screws No. 10 to No. 16 incl)
Screwdriver	Phillips No. 2502 (for Phillips screws No. 5 to No. 9 incl)
Nail hammer	
Diagonal cutters	6-in.
Long-noise pliers	6-in.
Adjustable wrench	8-in.
Adjustable wrench	6-in.
Adjustable wrench	4-in.
Scriber	8-in, double point, style 3
Pocket screwdriver	2-in.
Narrow screwdriver	6-in.
Solder gun	
Flashlight	2-cell
Flashlight batteries	
Extension cord	15-ft.
Alignment tool	
Tool roll	Xcelite No. 99 or equivalent
Hex and spline wrench kit	
Multimeter	
Sound-powered handset	
Soldering flux	
Tube puller	7-pin
Tube puller	9-pin
Pin straightener	7-pin
Pin straightener	9-pin
Wire stripper	
Offset ratchet handles and interchangeable adapters	
Offset screwdriver	4-in.
Tool case	
Soldering iron	150-watt
Temperature regulating stand	
Needle-nose pliers	5-in.
Combination pliers	6-in.
Dental mirror	
Socket contact gauge	
Neon circuit tester	
Capacitor tuning tool	
Klystron tuning tool	
Oil can and lubricating oil	3-in-1 type or equivalent
Coil tuning tool	
Pocket knife	
End wrench, ignition	3/8-in.
Ball peen hammer	1/2 lb.
Thermometer	Outdoor type with Fahrenheit scale
Mill file	10-in.
Paint brush	2-in.
Solder, rosin core	
Soldering paste	
Friction tape	
Polar relay adjusting tools, as follows:	
(1) contact burnisher	26S-C
(2) tool	34D
(1) file	KS-2662
(1) gauge	74D

