

## CHAPTER 3

# RADIO EQUIPMENT

The equipments discussed and illustrated in this chapter are selected as representative of the many models and types of radio transmitters, receivers, and auxiliary equipments used in the fleet today. No attempt is made to cover all of the equipments in use.

Modern shipboard radio equipments must be rugged construction for long service life. This equipment must be capable of transmitting and receiving over a wide range of frequencies and distances, while operating in any one of several modes. Because of limited space aboard ships and of ship's motion on rough seas, compactness and ruggedness are among the factors considered in designing these equipments.

### TRANSMITTERS, TRANSMITTER-RECEIVERS, AND TRANSCEIVERS

A transmitter-receiver comprises a separate transmitter and receiver mounted in the same rack or cabinet. The same antenna may be used for the transmitter-receiver arrangement. When so used, the capability for simultaneous operation of both the transmitting and receiving equipments does not exist. The equipments may be operated independently, using separate antennas.

A transceiver is a combined transmitter and receiver in one unit which uses switching arrangements in order to utilize parts of the same electronic circuitry for both transmitting and receiving. Hence, a transceiver cannot transmit and receive simultaneously.

### MF, AND HF TRANSMITTERS

Transmitters operating in the medium- and high-frequency bands of the frequency spectrum are used chiefly for communication at medium and long ranges. Some transmitters in these bands, however, are designed for short-range communication. In most instances, short-range transmitters have a lower output

power than those designed for communication at medium and long ranges.

In the following descriptions of specific equipment capabilities, the term "short range" (or "distance") means a measurement less than 200 miles; "medium range" is between 200 and 1500 miles; and "long range" exceeds 1500 miles. These values are approximates, because the range of a given equipment varies considerably according to terrain, atmospheric conditions, frequencies, and time of day, month, and year.

Some transmission equipment has a capability of radio teletype emission. The older equipment employed RFCSRATT (radiofrequency carrier shift radioteletype). The newer equipment has employed AFTSRATT (audiofrequency tone shift radioteletype). The old designation FSK (frequency shift keyer) is to be replaced with the above designators since it is more descriptive (reference JANAP 195H). This is covered more in detail in the next chapter on teletype equipment.

### Transmitters AN/SRT-14, -15, and -16

Transmitting sets AN/SRT-14, -15, and -16 are a series of shipboard transmitters designed for medium- and long-range communications. The AN/SRT-14 (fig. 3-1A) is the basic transmitter in the series, with a power output of 100 watts. By adding a power booster to the basic transmitter, it becomes the AN/SRT-15 (fig. 3-1B). The AN/SRT-15 has an optional output power of either 100 or 500 watts. Transmitter set AN/SRT-16 (fig. 3-1C) consists of two AN/SRT-14 equipments plus the booster, furnishing two entirely independent transmitting channels of 100-watt output, with the 500-watt booster available for use with either channel when desired.

All three transmitters cover the frequency range 0.3 to 26 MHz, and may be used for CW, radiotelephone, radioteletype, and facsimile

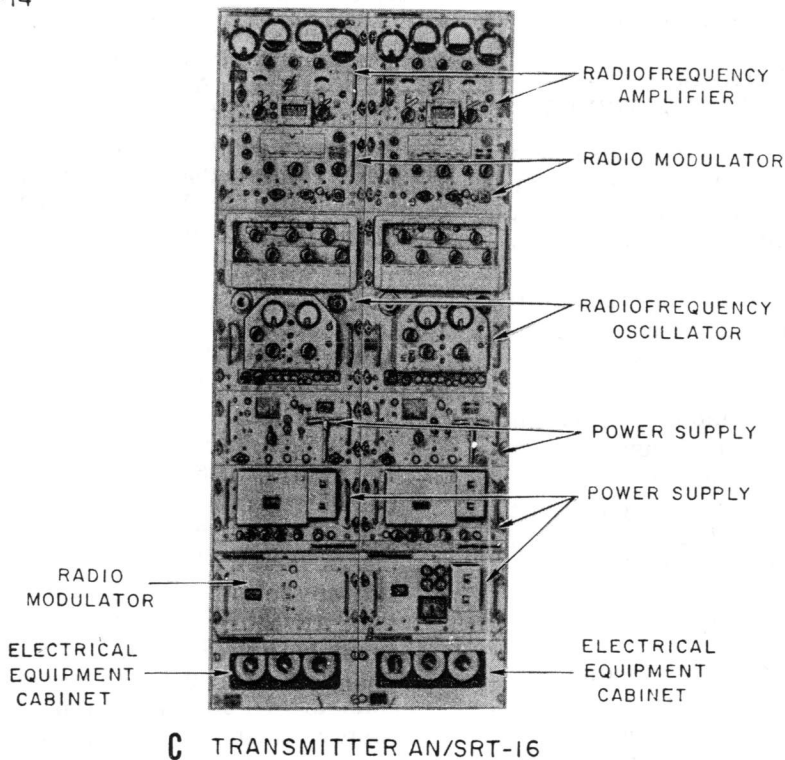
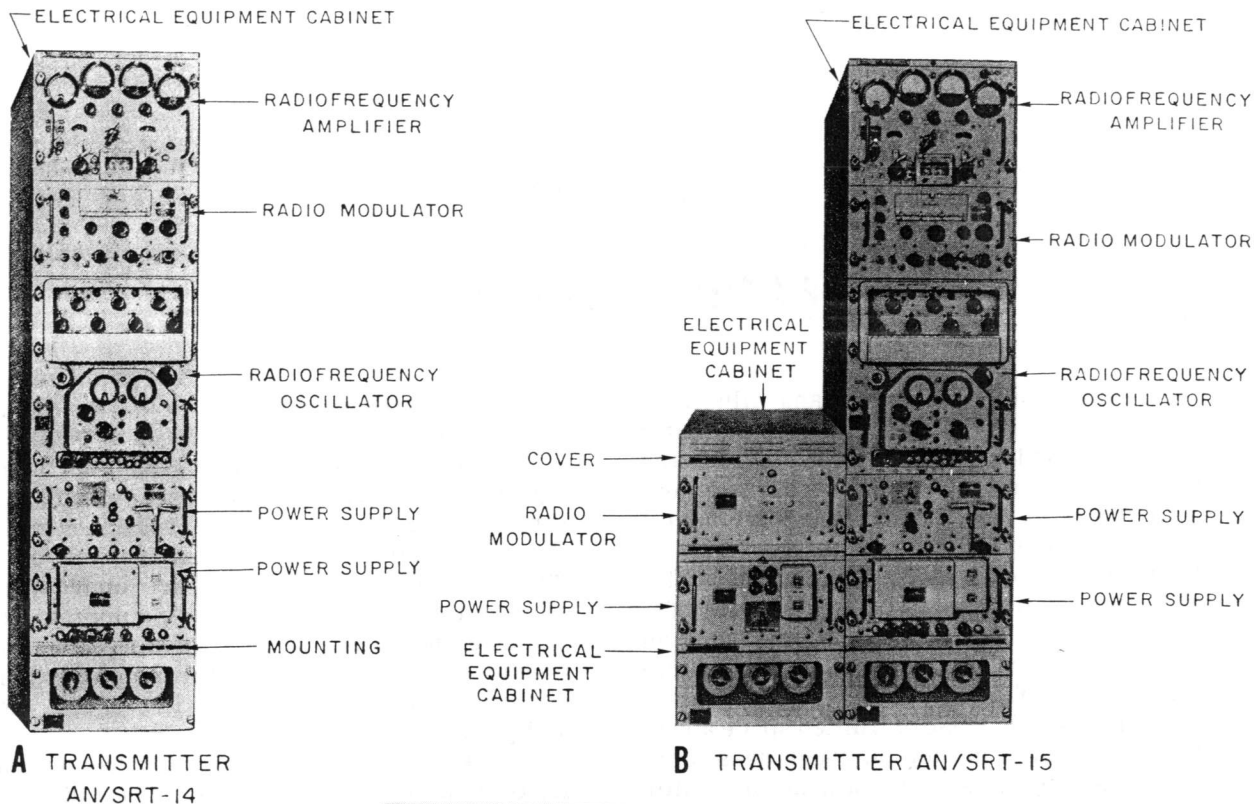

Figure 3-1.—Radio Transmitter AN/SRT-14, -15, -16.

1.144.1-.3

tra  
how  
or f  
ran  
MH  
Tr  
  
tra  
que  
can  
but  
and  
a p

transmissions. The 500-watt output power, however, is available only when the AN/SRT-15 or the AN/SRT-16 is operating in the frequency range of 2 to 26 MHz; at frequencies below 2 MHz, output is limited to 100 watts.

#### Transmitter AN/WRT-1A

The AN/WRT (fig. 3-2) is a shipboard transmitter designed for operation in the frequency range 300 to 1500 kHz. This equipment can transmit CW, RFCS, MCW and voice signals, but it has no SSB capability. When used for CW and RFCS transmissions, the transmitter has a power output of 500 watts. Voice operation,

however, reduces the available power to approximately 125 watts.

Because of operating in the medium frequencies with a substantial power output, the AN/WRT-1A lends itself well for communicating over long distances during the hours of darkness. Its range is reduced to medium distances during daylight hours.

#### Transmitter AN/WRT-2

Radio transmitter AN/WRT-2 (not illustrated) is similar in size and appearance to the AN/WRT-1A. It covers the frequency spectrum between 2 and 30 MHz, and has an average power output of 500 watts for CW, AFTS, and compatible AM modes of operation. When operating as a single-sideband transmitter, it produces 1000 watts. An additional feature of the AN/WRT-2 is that it provides independent sideband operation. This mode of operation permits simultaneous transmission of both sidebands, each one carrying separate intelligence.

Actual transmitter output values as gained from feedback from the fleet indicate that the power output levels are substantially lower than those cited above. Personnel must ensure that the transmitter is properly maintained and that optimum tuning exists for all operating modes. (Refer to Chapter 2, Table 2-2, "Classifications of Radio Emissions," for more detail on the modes of operation for the following radio sets.)

As indicated by its operating frequencies and power outputs, the AN/WRT-2 is used for medium- and long-range communications.

#### Transmitter-Receiver AN/SRC-23(V)

The AN/SRC-23(V) (fig. 3-3) is a single channel HF transmitter-receiver communications system which operates in the 2-30 MHz range. The transmitter-receiver is automatically tuned and capable of local or remote control in either simplex or duplex modes of operation for AM, CW, USB, LSB, ISB, AFTS, voice, or data. The equipment has a 1 KW power output; however, an alternate 5 KW RF power output may be obtained using a 5 KW linear power amplifier.

Designed especially for shipboard installations, this transmitter-receiver group may also be used for shore-base installations and consists of eight basic units located within a cabinet.

The front panel of the transmitter control unit (fig. 3-3) provides the controls for manually selecting the modes of operation for the transmitter and amplifier group.

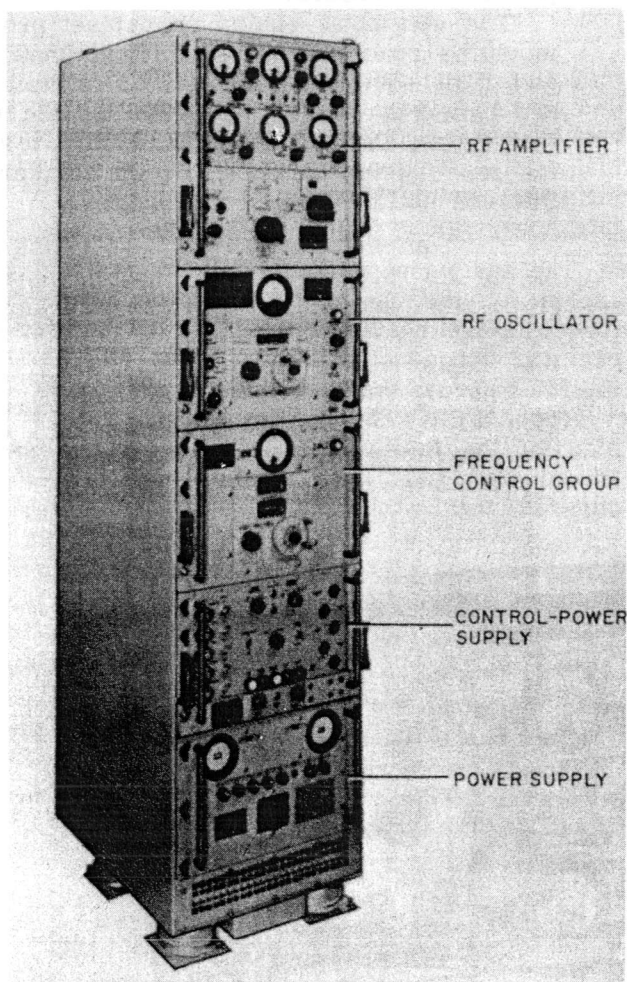

32.278(76)

Figure 3-2.—Radio Transmitter AN/WRT-1A.

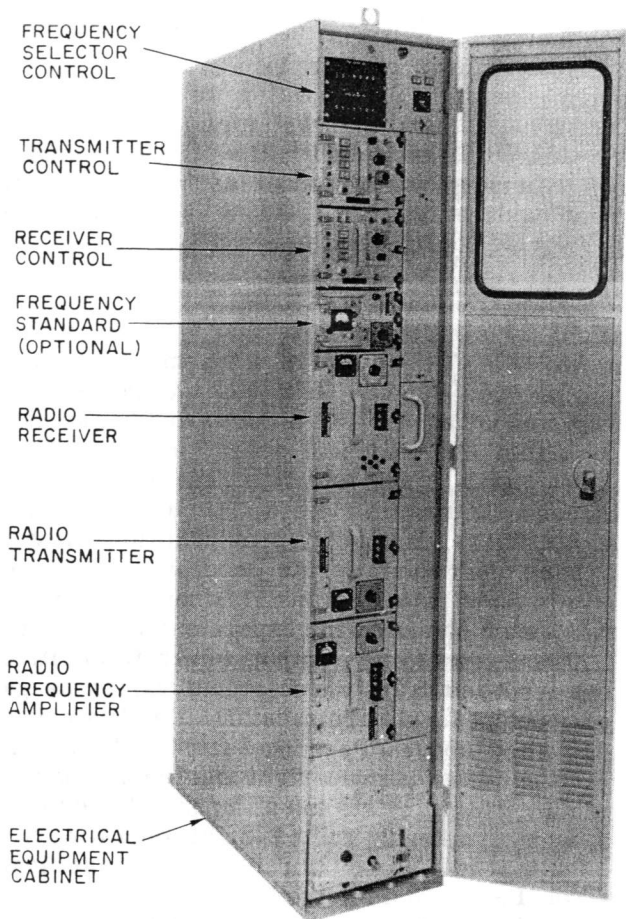

The receiver control unit provides controls for operating the receiver.

The frequency selector control unit provides the selector switches for selecting the desired operating frequency for the transmitter and receiver units.

The radiofrequency amplifier unit receives the signal from the transmitter and amplifies it to 1,000 watts.

The frequency standard unit is optional equipment, which may be installed in the cabinet when external frequency standard equipment is not supplied. It provides an unmodulated 100-kHz output frequency used for calibrating the radio transmitter and receiver. In case of power failure, an internal 28 VDC battery in this unit will automatically supply power for two hours.

The electrical equipment cabinet provides mounting space for all of the functional units and other equipment, such as a heat exchanger and blower for cooling the system, patch terminal strips, thermal alarm indicators, a warning panel, primary power circuit breaker, and interconnection system components.

The equipment is completely transistorized except for the use of two electron tubes. A frequency-synthesizer provides transmitter-receiver frequencies separated at 500 hertz intervals across the band.

The AN/SRC-23(V) is a single-channel version of the four-channel service test NTDS (Naval Tactical Data System) AN/SRC-16, covered later in the chapter.

120.64

Figure 3-3.—Radio-Transmitter-receiver AN/SRC-23(V).

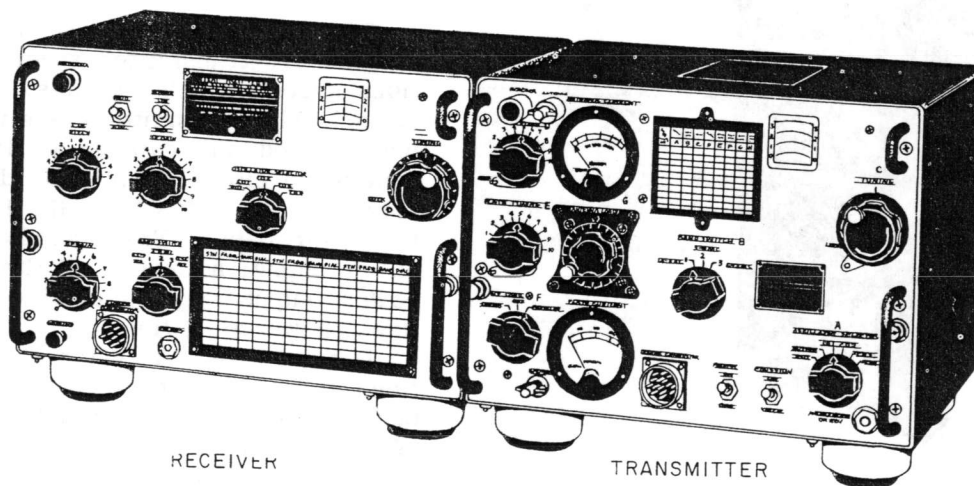

Figure 3-4.—Radio Transmitter-receiver Model TCS-( ).

76.22

Transmitter-Receiver Model TCS-( )

The model TCS-( ), (fig. 3-4) is a small transmitter-receiver that has been in use for many years for short-range communications. It has an output power of 10 watts for radio-telephone and 25 watts for CW. The TCS-( ) has a frequency range of 1.5 to 12 MHz. Its frequency-determining section may be either crystal-controlled or tuned by a continuously variable oscillator, whichever is more desirable. Transmitter and receiver use the same antenna, which is switched from receiver to transmitter by a relay when the transmitter is keyed. Although it is being replaced by the AN/URC-35, the TCS-( ) is still used aboard ships of many types.

Transmitter-Receiver AN/WRC-1 ( )

Another radio set that covers the frequency range 2 to 30 MHz is the AN/WRC-1( ) transmitter-receiver (fig. 3-5). It has a maximum power output of 100 watts, and is capable of transmission and reception on upper sideband, lower sideband, continuous wave, amplitude modulation, radioteletype, and independent sideband modes of operation.

An outstanding feature of the AN/WRC-1( ) is that it has an automatic antenna tuning system. This system automatically tunes the antenna to the transmitter's output frequency, thereby assuring maximum transfer of power

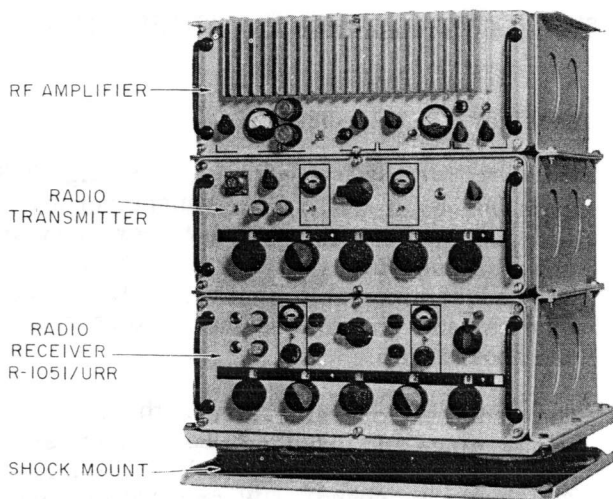

76.61

Figure 3-5.—Radio Transmitter-receiver AN/WRC-1.

at all times. Manual controls are provided for fine tuning for maximum power output.

Transmitter AN/URT-24

When the receiver unit is removed from the AN/WRC-1( ) transmitter-receiver the remaining units form the AN/URT-24 transmitter. When used as an AN/URT-24, the top two units in figure 3-5 (RF amplifier and radio transmitter) are seated directly on the shock mount, thus eliminating the receiver unit.

The transmitter is used for short range communications.

Transmitter AN/URT-23(V)

The AN/URT-23(V) is a long and medium range transmitter which operates as a 1 KW single-sideband transmitter (fig. 3-6). The

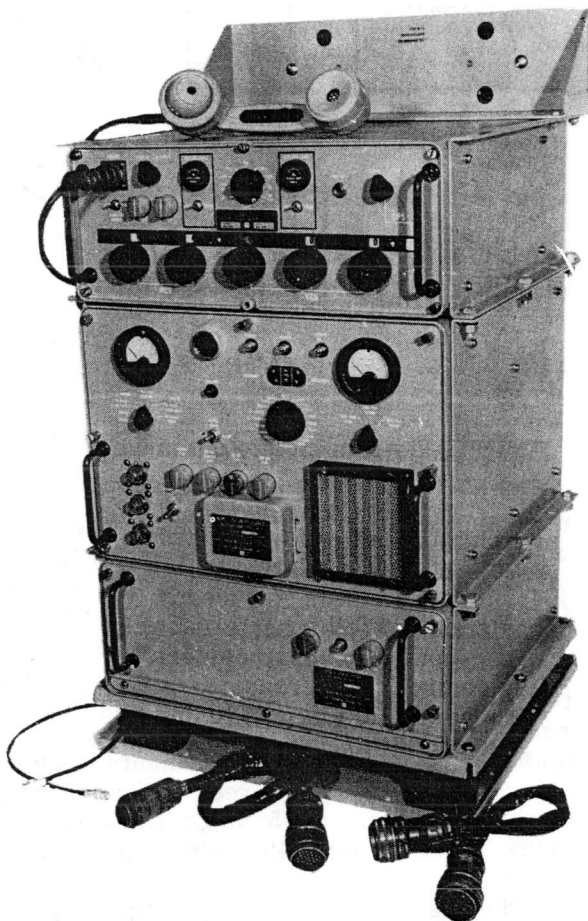

120.65

Figure 3-6.—Radio Transmitter AN/URT-23(V) (with 60 hertz power supply).

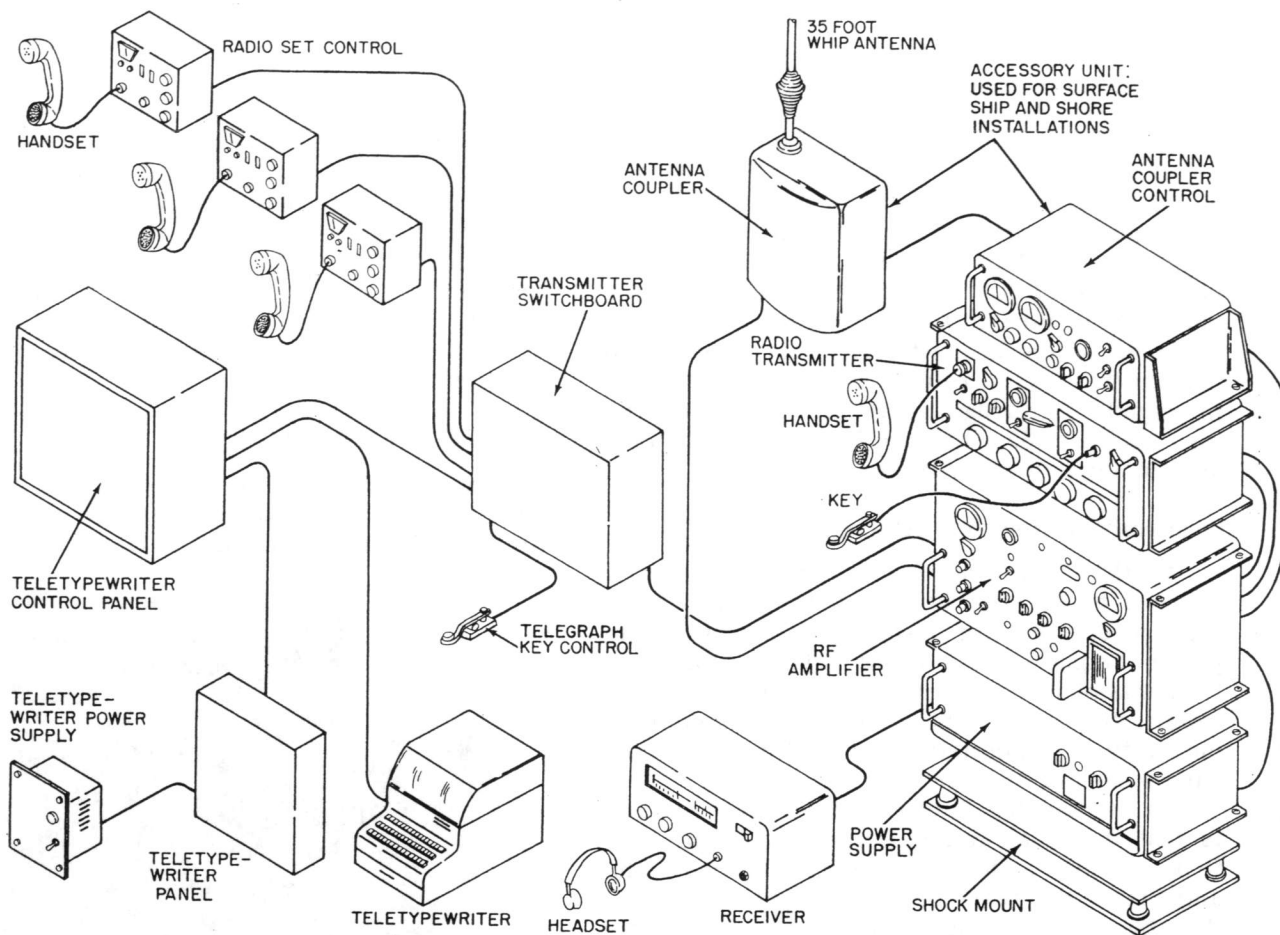

120.66

Figure 3-7.—A complete communications system for Radio Transmitter AN/URT-23(V).

normal configuration provides voice, continuous wave, and radio teletypewriter transmissions in the 2-30 MHz frequency range. A frequency standard (either internal or external), with crystal-controlled synthesizers is used for frequency control. The transmitter is equipped to provide automatic (digital) tuning to the correct frequency within a frequency band. Two optional power supply equipments permit the use of any one of three, 3-phase primary power sources: 115 volts line-to-line 400 hertz or 208 or 440 volts line-to-line 60 hertz.

The major units of the AN/URT-23(V) may be stack or rack mounted for installation aboard ship or for shore installations to form a complete communications system as illustrated in figure 3-7.

#### Transceiver AN/URC-58(V)

The AN/URC-58(V) radio set (fig. 3-8) is a single sideband (SSB) transceiver for general-purpose voice and CW communications and may be used for ship and shore fixed installations, semiportable applications such as in vehicles, and amphibious landing craft, and for use aboard ship.

The radio set operates in the 2 to 15 MHz frequency range and provides transmission and reception on single sideband (selectable upper and lower sideband), CW and AM (compatible) signals. This equipment operates from a nominal primary power input of 115/230 volts, 50 to 60 hertz, single phase and either 12 or 24 VDC power, providing a power output of

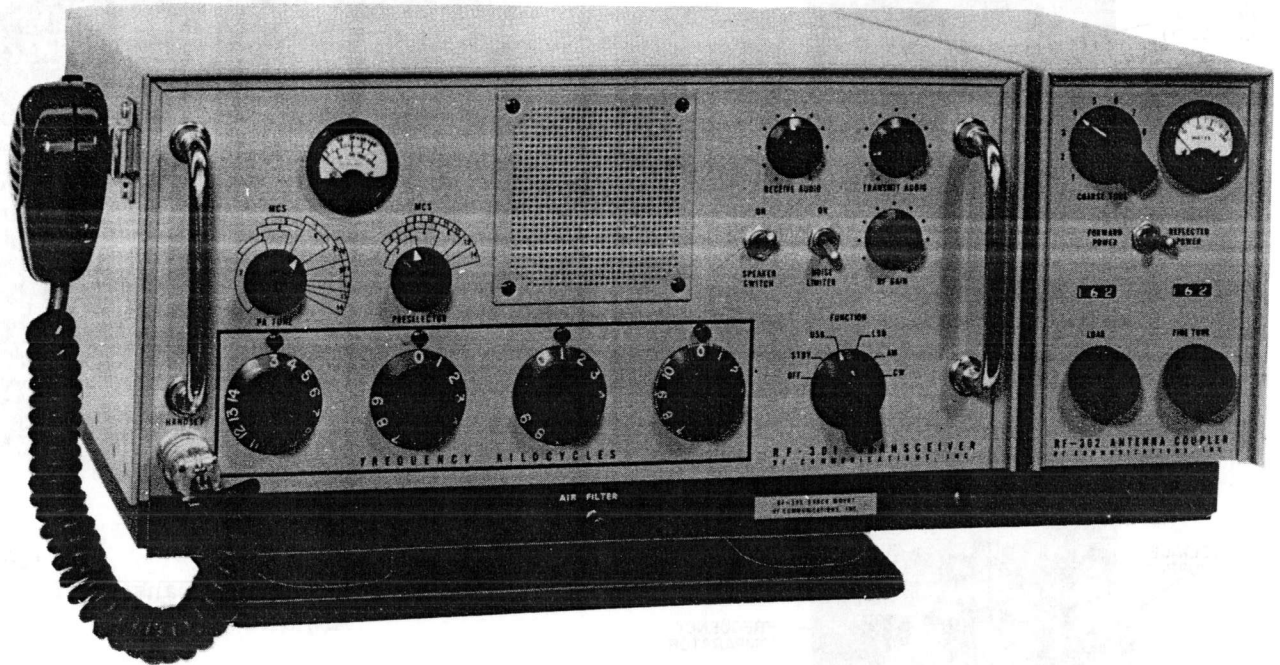

Figure 3-8.—Radio Transceiver AN/URC-58(V).

120.67

100 watts. Audio and keying facilities are provided for both local and remote operation. The transceiver is a triple-conversion super-heterodyne receiver and transmitter tunable over the entire frequency range in 1 kHz increments.

The frequency range of 2 to 30 MHz is covered in four bands. The desired operating frequency in kHz is tunable in 100 Hz increments on a direct-reading frequency counter. Frequency accuracy and stability are controlled by a self-contained frequency standard. Provisions are also made for using an external frequency standard.

Transceiver AN/URC-32B

Radio Transceiver AN/URC-32B (fig. 3-9) is a manually operated radio communication equipment for operating in the 2 to 30 MHz (high-frequency) range. With a power output of 500 watts, this transceiver is capable of transmitting signals over long distances. It is designed for single-sideband transmission and reception on upper sideband, lower sideband, or the two independent sidebands simultaneously, with separate AF and IF channels for each sideband. In addition to SSB operation, provisions are included for compatible AM (carrier plus upper sideband), CW, or tone-shift keying (AFTS). The AFTS mode of operation is used for sending radioteletype (RATT) and facsimile (FAX) signals.

Because of its versatility and power, the AN/URC-32B is installed on most Navy ships having a requirement for communicating over long distances. It is being replaced by the AN/URT-23.

Transceiver AN/URC-35

Designed primarily for mobile operations, the AN/URC-35 (fig. 3-10) has continuous wave transmitting capabilities, but is used chiefly for voice communications over short and medium distances. These portable sets are found aboard vehicular and small surface craft, and aboard regular Navy ships for emergency use.

ARL



120.66

3-8) is r gen- ations red in- ch as ft, and

5 MHz on and upper atible) om a volts, 12 or put of

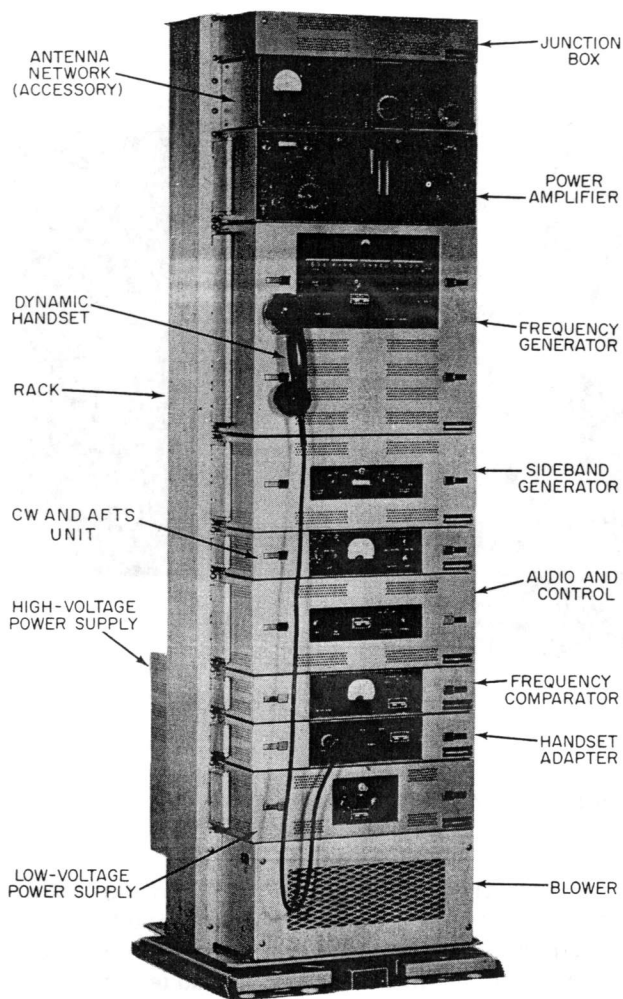

32.135  
Figure 3-9.—Radio Transceiver  
AN/URC-32B.

The AN/URC-35 is a general-purpose HF radio set for transmitting and receiving SSB, AM, and CW signals in the 2 to 30 MHz spectrum.

The receiver and transmitter are automatically tuned to the same frequency at all times by common electronic assemblies. All components in the electronic assemblies are transistorized, except the RF amplifiers.

Optional power requirements are met by either internal or external 28 VDC battery supply or by 115 VAC. Three different antennas may be employed: a 15-foot probe or

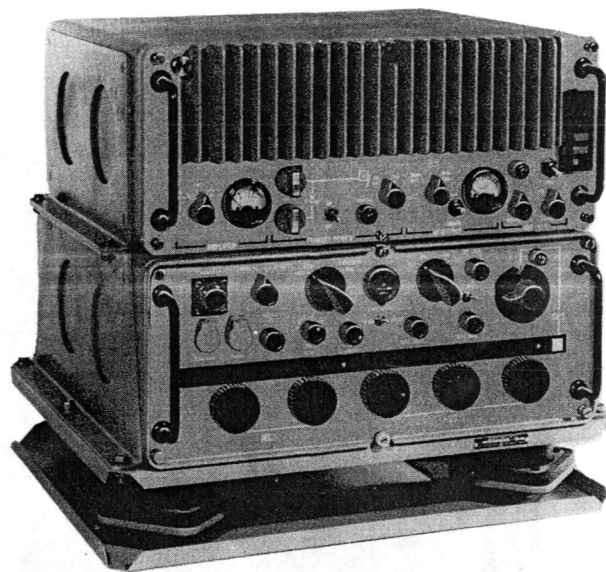

120.68  
Figure 3-10.—Radio Transceiver  
AN/URC-35.

whip, a 25-foot whip, or a 35-foot whip type antenna.

#### Transmitter-Receiver AN/SRC-16

Communications central AN/SRC-16 (fig. 3-11) is a shipboard, single-sideband communications system with a frequency range of 2 to 30 MHz. In addition to the normal voice, CW, and AFTS communications, the system provides high-frequency reception and transmission for terminal equipment such as HCCS (high-capacity communications system) and NTDS (Navy Tactical Data System). The system uses dual single-sideband equipment and both sidebands are available for use independently for either voice or multitone signals. The system operates on four independent channels, each channel consisting of a single-sideband receiver, a single-sideband transmitter (exciter), and a 500-watt PEP linear power amplifier. The frequency of each receiver and transmitter is phase locked to a system primary frequency standard.

Two transmitters, two receivers, one power amplifier, and one frequency standard are located in each of the two cabinets in the communications central (fig. 3-11).



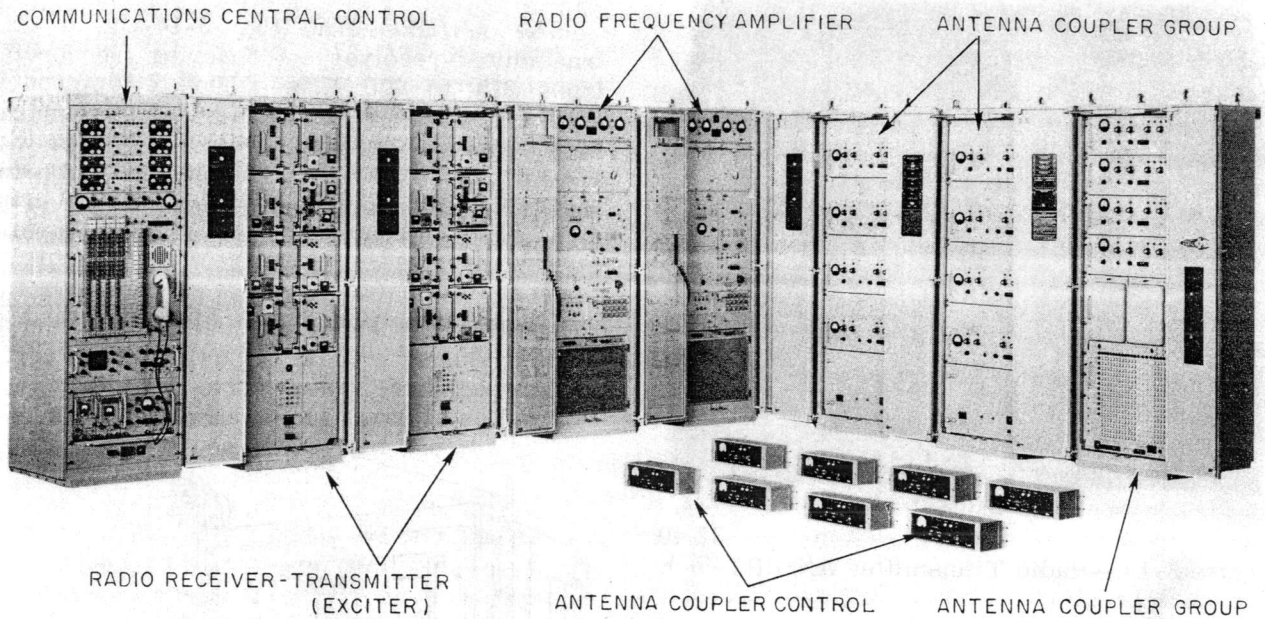

Figure 3-11.—Communications Central AN/SRC-16 (doors open).

120.69

VHF TRANSMITTERS

Transmissions in the VHF range normally are restricted to line-of-sight distances. Under certain atmospheric conditions, they have been received at considerably longer distances—500 miles or more.

Shipboard installations of VHF equipments are retained for emergency communications, and for communication with allied forces that have not yet converted to UHF equipments. The VHF equipment is also being used as a backup to UHF equipment.

Tranceiver AN/VRC-46

The AN/VRC-46 transceiver (fig. 3-12) was developed for Signal Corps use, but has been adopted for shipboard and amphibious naval gun fire support and joint communications with tactical Army and Marine Units ashore.

The AN/VRC-46 is a narrow-band FM transceiver capable of 24 VDC or 115 VAC operation in the 30 to 76 MHz (very high frequency) range. It is used for short-range, two-way radiotelephone communications. It replaces the older AN/SRC-10 through -15 wideband FM transceivers.

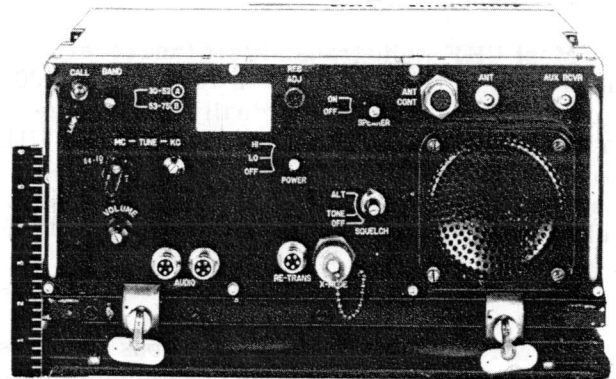
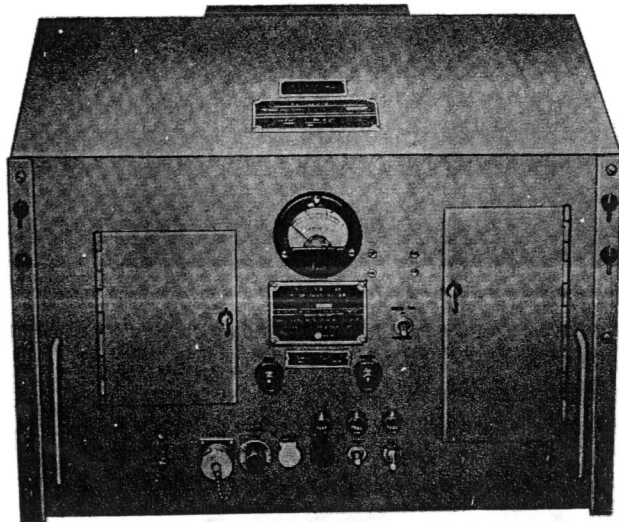

Figure 3-12.—Radio Transceiver AN/VRC-46.

120.70

Transmitter AN/URT-7( )

The AN/URT-7( ) (fig. 3-13) is a crystal-controlled VHF transmitter that operates in the frequency range 115 to 156 MHz. Although mountings for four crystals are provided, permitting rapid selection of any one of four frequencies, the transmitter must be retuned each time the frequency is changed.



32.40

Figure 3-13.—Radio Transmitter AN/URT-7( ).

With a power output of 30 watts, this equipment provides two modes of operation: radiotelephone and MCW.

UHF TRANSMITTERS

Most UHF radio transmitters (and receivers) used by the Navy operate in the 225- to 400-MHz frequency range. Actually, this range of frequencies covers portions of both the VHF band and the UHF band. For convenience, however, radio equipments operating within this frequency range are considered to be UHF equipments.

The effective range of UHF normally is limited to line of sight distances, however, under certain atmospheric conditions UHF has been received at considerably longer distances—500 miles or more.

Transmitter Model TED

The model TED is a crystal-controlled, single-channel, UHF transmitter that operates in the frequency range 225 to 400 MHz. This transmitter is similar to the VHF transmitter AN/URT-7 described earlier and illustrated in figure 3-12.

The TED has an output power of 15 watts. An RF power amplifier (AM-1365/URT, not shown) boosts the output power to 100 watts.

Transmitter-Receiver AN/GRC-27A

The AN/GRC-27A (fig. 3-14) is a UHF transmitter-receiver set covering frequencies from 225 to 400 MHz. This equipment is used for radiotelephone and MCW communications from ship-to-ship, ship-to-shore, or with aircraft. The AN/GRC-27A is installed principally in carriers and antisubmarine warfare ships, whose primary missions involve the control of aircraft.

The transmitter has a power output of 100 watts. It has three crystal-controlled

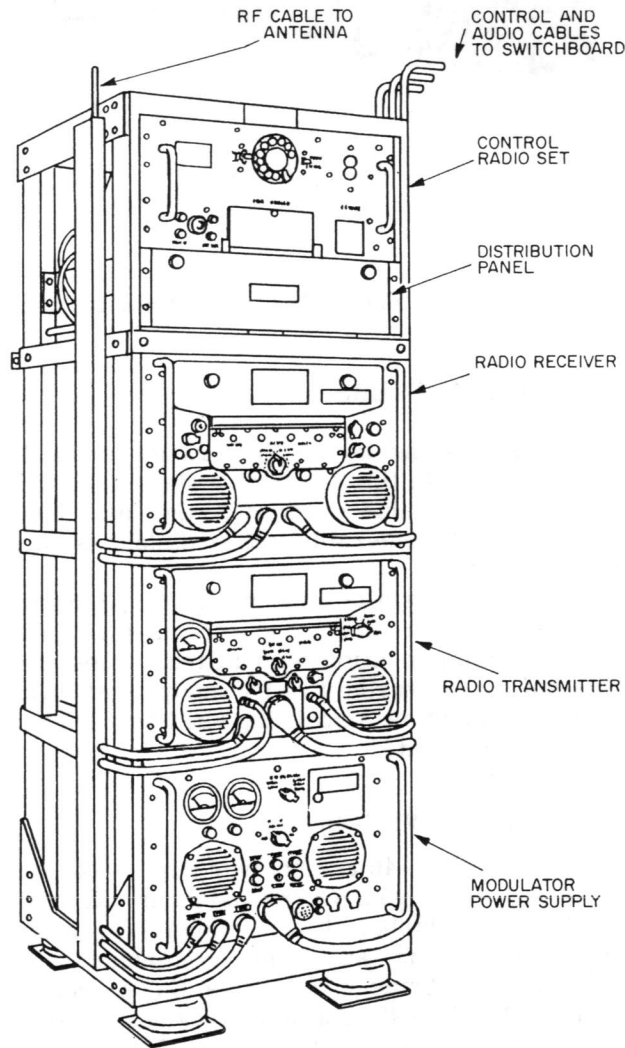

32.109.2

Figure 3-14.—Radio Transmitter-receiver AN/GRC-27A.

oscil  
cryst  
requ  
mk  
cryst  
quen  
out  
10 c  
man  
10 p  
auto  
auto  
at t  
othe  
Only  
mati  
of th  
7  
1750  
hete  
cryst  
to th  
auto  
2 to  
J  
the  
fror  
  
Rad  
AN/  
  
(fig  
facci  
tion  
The  
duc  
wit  
cap  
a ti  
can  
ren  
a  
pow  
  
uni  
nat  
SR  
car  
cei  
Th  
cra  
two  
oth

oscillators, using a total of 38 crystals. These crystals, located within the transmitter, do not require handling by the operator. From the combination and multiplication of these 38 crystal frequencies are produced 1750 frequencies spaced at 100 kHz intervals throughout the transmitter's frequency range. Any 10 of these 1750 frequencies can be preset manually with selector switch dials. Of the 10 preset frequencies, one then can be selected automatically by a telephone-type dial. The automatic selection can be made either locally at the transmitter or from a remote unit at other locations, such as CIC and the bridge. Only 2 to 7 seconds are required to shift automatically from one channel to another in any of the 10 preset channels.

The receiver also operates on any of the 1750 channels. It is a triple-conversion superheterodyne and has crystal oscillators using 38 crystals in a system separate from but similar to that used in the transmitter. Here, again, automatic shifting of channels is done in about 2 to 7 seconds.

Both transmitter and receiver normally use the same antenna. A relay switches the antenna from one to the other.

#### Radio Transceiver Sets AN/URC-9( ), AN/SRC-20( ), -21( )

Radio set AN/URC-9( ), used separately (fig. 3-15) is a UHF transceiver that provides facilities for AM radiotelephone communications in the frequency range 225 to 400 kHz. The equipment is crystal-controlled and produces 1750 frequencies at 100 kHz intervals within its frequency range. Although it is capable of operating on only one frequency at a time, any 20 of the 1750 available frequencies can be preset for immediate selection from remote positions. Channel selection requires a maximum of 8 seconds. This set has a power output of approximately 20 watts.

When modified by the addition of certain units (fig. 3-15), the AN/URC-9( ) is redesignated either AN/SRC-20( ), (fig. 3-15) or AN/SRC-21( ) (fig. 3-16). These modified sets can be connected to similar sets so that received signals are retransmitted automatically. This feature is useful when a ship (or aircraft) is serving as a relay station between two stations that cannot communicate with each other directly.

The difference between the AN/SRC-20( ) and the AN/SRC-21( ) is that the AN/SRC-20( ) has a linear power amplifier unit that increases the 20-watt power output from the AN/URC-9( ) to a 100-watt output.

#### PORTABLE AND PACK RADIO EQUIPMENT

Because portable and pack radio sets must be lightweight, compact, and self-contained, they usually are powered by battery or hand generator, have low output power, and are either transceivers or transmitter-receivers. Navy ships carry a variety of these radio sets for emergency and amphibious communications. The numbers and types of this equipment vary according to the individual ship.

#### Transmitter AN/CRT-3A

Radio transmitter AN/CRT-3A, popularly known as the "Gibson girl," is a rugged emergency transmitter carried aboard ships and aircraft for use in lifeboats and liferafts. It is shown in figure 3-17. No receiving equipment is included.

The transmitter operates on the international distress frequency (500 kHz) and the survival craft communication frequency (8364 kHz).

The complete radio transmitter, including the power supply, is contained in an aluminum cabinet that is airtight and waterproof. The cabinet is shaped to fit between the operator's legs, and has a strap for securing it in the operating position.

The only operating controls are a three-position selector switch and a pushbutton telegraph key. A handcrank screws into a socket in the top of the cabinet. The generator, automatic keying, and automatic frequency changing are all operated by turning the handcrank. While the handcrank is being turned, the set automatically transmits the distress signal SOS in Morse code. The code sequence consists of six groups of SOS followed by a 20-second dash, transmitted alternately on 500 kHz and 8364 kHz. The frequency automatically changes every 50 seconds. These signals are intended for reception by two groups of stations, each having distinct rescue functions. Direction-finding stations cooperating in long-range rescue operations normally make use of 8364 kHz, whereas aircraft or ships locally engaged

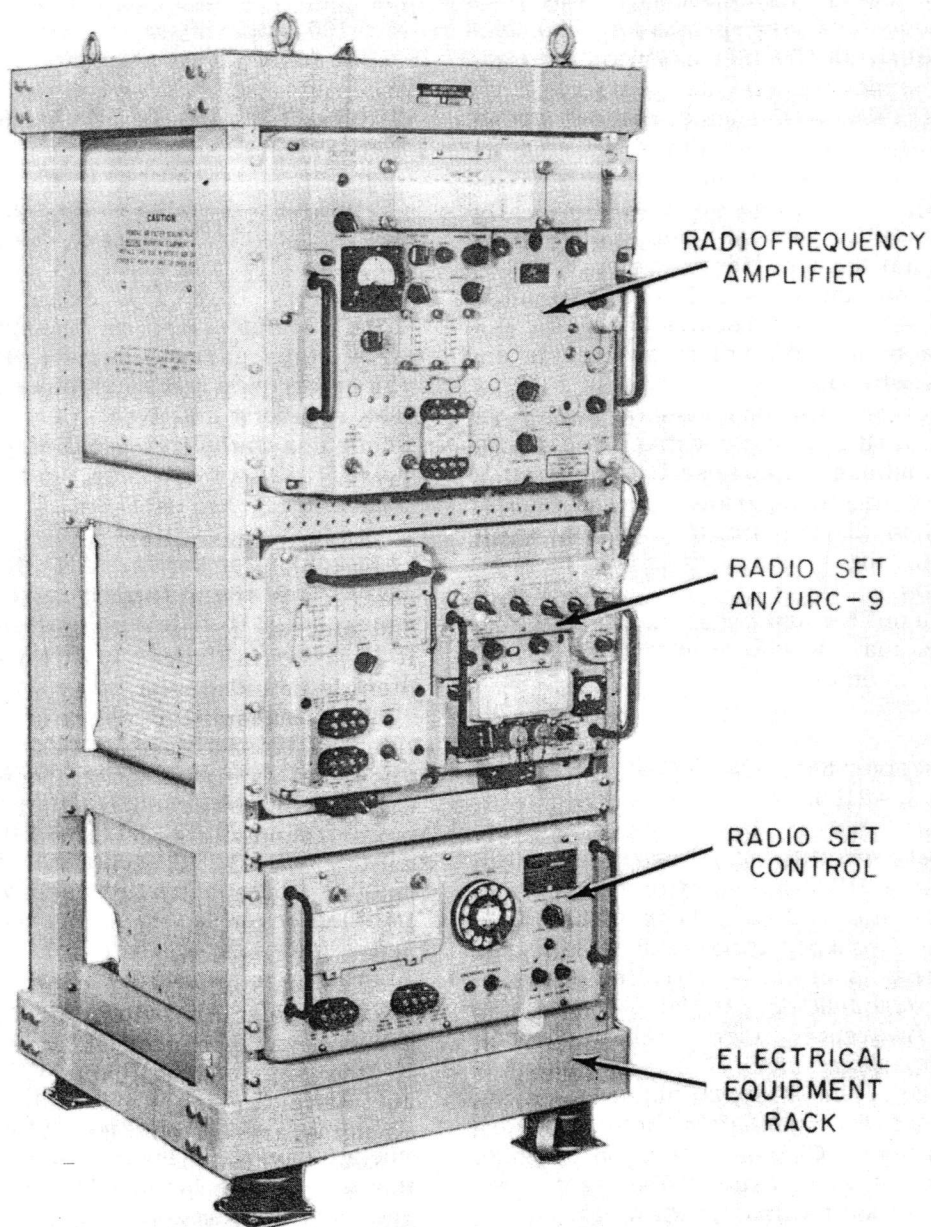
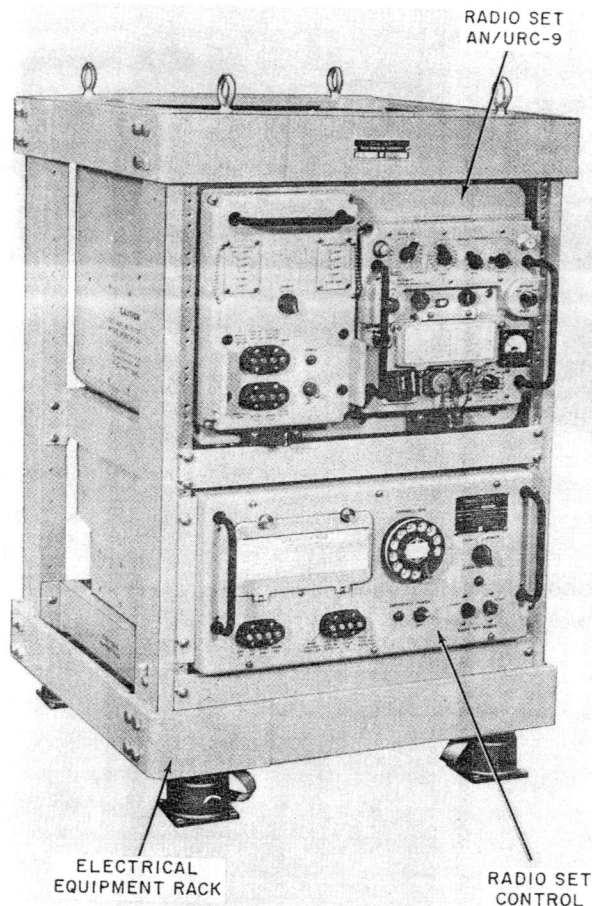
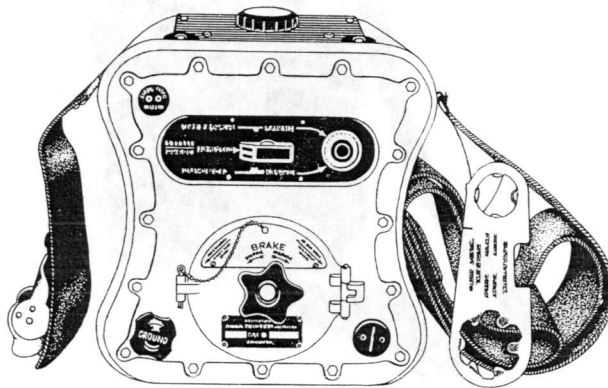

Figure 3-15.—Radio Transceiver AN/SRC-20.

50.160



50.161  
Figure 3-16.—Radio Transceiver AN/SRC-21.



76.32  
Figure 3-17.—Emergency lifeboat Radio Transmitter AN/CRT-3A.

in search and rescue missions make use of the 500 kHz signals.

Besides the automatic feature, the transmitter can be keyed manually, on 500 kHz only, by means of the pushbutton telegraph key.

Additional items (not shown) packaged with the transmitter include the antenna, a box kite and balloons for supporting the antenna, hydrogen-generating chemicals for inflating the balloons, and a signal lamp that can be powered by the handcrank generator.

The equipment floats, and is painted brilliant orange-yellow to provide greatest visibility against dark backgrounds.

#### Transceiver SCR-536( )

Radio transceiver SCR-536( ), (fig. 3-18) is a low-power, battery-operated transceiver used for voice communication over very short distances (1 to 3 miles). The equipment is crystal-controlled, and operates on a preset frequency in the range of 3.5 to 6 megahertz. The operating frequency is varied by changing the crystal and certain other frequency-determining components within the set. Usually, these changes are made by a technician.

The set is energized by extending the telescopic antenna. When thus energized, it functions as a receiver. Applying pressure on the press-to-talk switch (located on the side of the set) shifts the equipment from a receive condition to a transmit condition. The set remains in the transmit condition as long as the switch is held depressed.

Weighing only 5-1/2 pounds, this portable set comes equipped with a carrying strap. Often the set is used as a means of communication by personnel moving about on foot, as while on shore patrol. Also, it serves as a means of communication between small boats and their parent ships.

#### Transceiver AN/PRC-10( )

The AN/PRC-10( ) portable radio set (not illustrated) provide voice communications for amphibious operations. These are man-pack FM equipment sets.

Total frequency coverage of the AN/PRC-10( ) is between 38 and 54.9 MHz with an output power of approximately 1 watt. These portable sets have an effective range of approximately 5 miles.



120.7

Figure 3-18.—Radio Transceiver SCR-536( ).

## Transceiver AN/PRC-25

The AN/PRC-25 is a VHF man-pack miniaturized radio set (fig. 3-19) now being used. It weighs only 22 pounds with batteries, and replaces three sets (AN/PRC-8-9-10) that cover a frequency range of 20 to 55 megahertz. The AN/PRC-25 is an FM transceiver that operates in the 30- to 76-megahertz range and provides 920 channels spaced at 50 kilohertz intervals, with a power output of 2 watts. Stable frequencies are generated for both the transmitter and receiver by a frequency synthesizer.

The unit is transistorized throughout, with the exception of one tube in the transmitter power output stage. A future version will be completely solid state. With 25 modular plug-in subassemblies, the set is easy to service.

## Transceiver AN/URC-4( )

The AN/URC-4( ) (fig. 3-20) is a compact, portable transceiver. It is small enough to allow the combined transmitter and receiver to be grasped and held with one hand. This unit is connected by a short cable to its battery case, which is approximately the size of the transceiver.

The complete set is intended to be carried in a special vest type garment worn by airmen while they are on flight missions. It also may be dropped by parachute to personnel in distress.

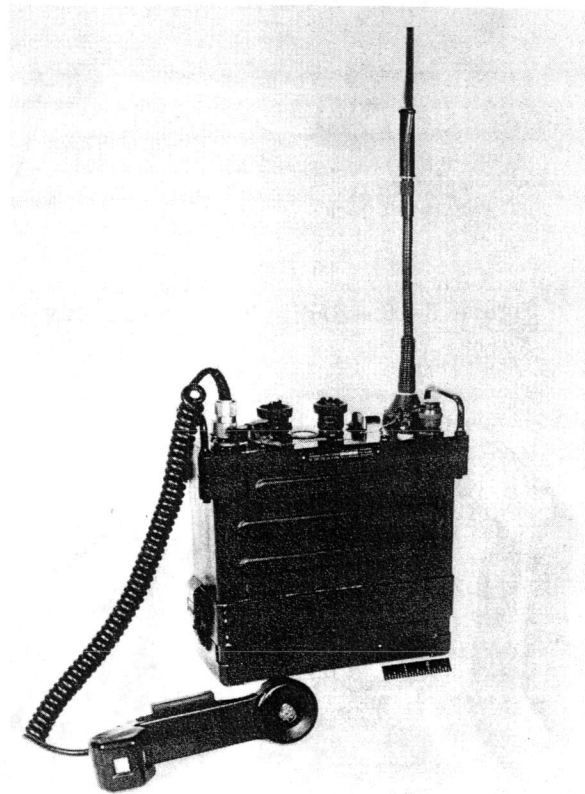

120.5

Figure 3-19.—Radio Transceiver AN/PRC-25.



120.6  
Figure 3-20.—Radio Transceiver AN/URC-4 ( ).

The principal use of this set in the Navy is for extremely short-distance distress communication between lifeboats (or liferafts) and searching rescue aircraft or ships.

This transceiver is a crystal-controlled equipment that provides voice and MCW transmissions over two frequency ranges within the VHF band. Frequencies covered are between 120 and 130 MHz and between 240 and 260 MHz. The operating frequency of the set is determined by a single crystal, which must be changed each time the frequency is changed. The set is pretuned, and can be operated by anyone familiar with its purpose.

#### Transceiver AN/PRC-41

Radio set AN/PRC-41 (fig. 3-21) is a watertight, lightweight, portable UHF equipment that may be operated on any of 1750 channels spaced 100 kHz apart in the 225- to 400 MHz range. Its only mode of operation is AM voice, which it supplies at an average output power of 3 watts. Although designed principally for man-pack operation, the set also may be used for fixed station and vehicular operation when complemented by certain accessories. When not in use, the equipment is disassembled and stowed in a compartmentized aluminum transit case similar to an ordinary suitcase.

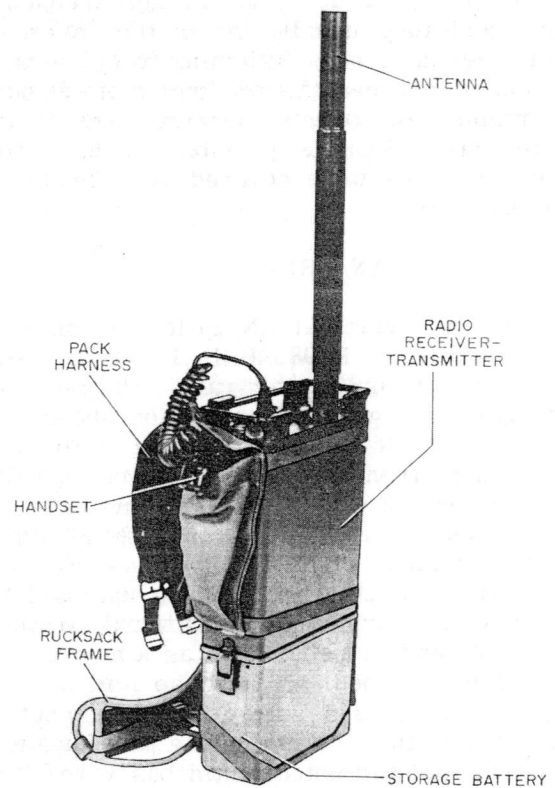

120.5  
Figure 3-21.—Radio Transceiver AN/PRC-41.

## RECEIVERS

Modern Navy radio receivers are easy to operate and maintain. They are capable of receiving several types of signals and can be tuned accurately over a wide range of frequencies. Because they are not required to produce or handle large currents and voltages, their size is relatively small when compared to the size of most transmitters.

Unlike the receiving units of the transceivers described earlier, the radio receivers discussed in this section are separate equipments that are capable of independent operation.

Receivers with radioteletype capabilities are able to copy either radiofrequency carrier shift or audiofrequency tone shift radioteletype transmission information.

## VLF, LF, MF, AND HF RECEIVERS

Most radio receivers operating in the VLF, LF, MF, and HF bands of the frequency spectrum

are of the continuous tuning type. They are tunable to any frequency within their frequency range, and they usually cover this range in several tuning bands. Switching from one band to another changes the receiver's frequency-determining components, permitting more accurate tuning than is possible if the entire frequency range were covered by a single set of components.

#### Radio Receiver AN/BRR-3

Radio receiving set AN/BRR-3 consists of radio receiver R-988/BRR-3, connectors, clamps, and mounting hardware. The receiver is designed for general application aboard all types of U. S. Navy vessels. It covers the frequency range from 14 to 30 kHz and is normally used to receive either on-off keying (ICW or A1) or radioteletype (RFCS or AFTS) types of transmission. The receiver also has the capabilities of receiving facsimile signals (FAX or F4) when provided with additional terminal equipment, and of being used as a homing device when equipped with a Loop Antenna. It is a superheterodyne receiver, the output of which is supplied at a headphone jack for audio monitoring of Interrupted Continuous Wave (ICW) signals. Figure 3-22 shows the radio receiving set and accessory equipment.

#### Radio Receiver AN/SRR-19A

The AN/SRR-19A is a low frequency multi-channel shipboard radio receiver for the 30-300 kHz frequency range (fig. 3-23). This dual-conversion superheterodyne receiver is intended for single sideband, multichannel radio teletypewriter broadcasts, AM and CW reception.

Receiver operation is characterized by extreme stability, permitting long periods of unattended operation. Counter type tuning dials facilitate accurate tuning to a desired frequency, and frequency errors caused by drift in the local oscillators are removed by drift-cancellation circuits. The receiver can be incrementally tuned in steps of 10 hertz or continually tuned (between increments) with partial drift-cancellation during continuous tuning.

#### Radio Receiver AN/SRR-11

Radio receiver AN/SRR-11 (fig. 3-24) is a modern communication receiver used in all

types of Navy ships. The frequency range is divided into five bands from 14 to 600 kilohertz.

The AN/SRR-11 receiver is used for monitoring low and medium frequencies, such as the international distress frequency (500 hertz). Its most general use, however, is for receiving the VLF and LF transmissions of the fleet broadcasts. This receiver can be used for CW, MCW, and AFTS or RFCSRATT and FAX reception.

#### Radio Receiver RBA

The RBA receiver (fig. 3-25) has been used for many years aboard ship. Although being replaced, many of these old receivers are still in service. The frequency coverage of the RBA is 15 to 600 kHz.

The RBA is a TRF (tuned radiofrequency) receiver. The receiver may be used for CW, MCW, and voice signals, but because of its high selectivity, the RBA is not recommended for radiotelephone use. Most RBA receivers can receive radioteletype and facsimile signals also. The receiver has high sensitivity and good selectivity. As shown in figure 3-25, the power supply is a separate unit from the receiver.

#### Radio Receiver AN/WRR-3B

Radio receiver AN/WRR-3B (fig. 3-26) is a dual-conversion superheterodyne receiver for surface craft and submarine installations. It receives CW, MCW, and radioteletype signals.

The receiver covers the frequency range from 14 to 600 kilohertz in five bands. They are—

- Band 1, 14 to 30 kHz
- Band 2, 30 to 63 kHz
- Band 3, 63 to 133 kHz
- Band 4, 133 to 283 kHz
- Band 5, 283 to 600 kHz

The frequency to which the receiver is tuned is read directly from drum type dials.

An internal calibration circuit provides calibration points at each 10 kHz tuning point within the tuning range of the receiver.

#### Radio Receiver AN/WRR-2B

Another shipboard radio receiver for use over the MF/HF bands is the AN/WRR-2B



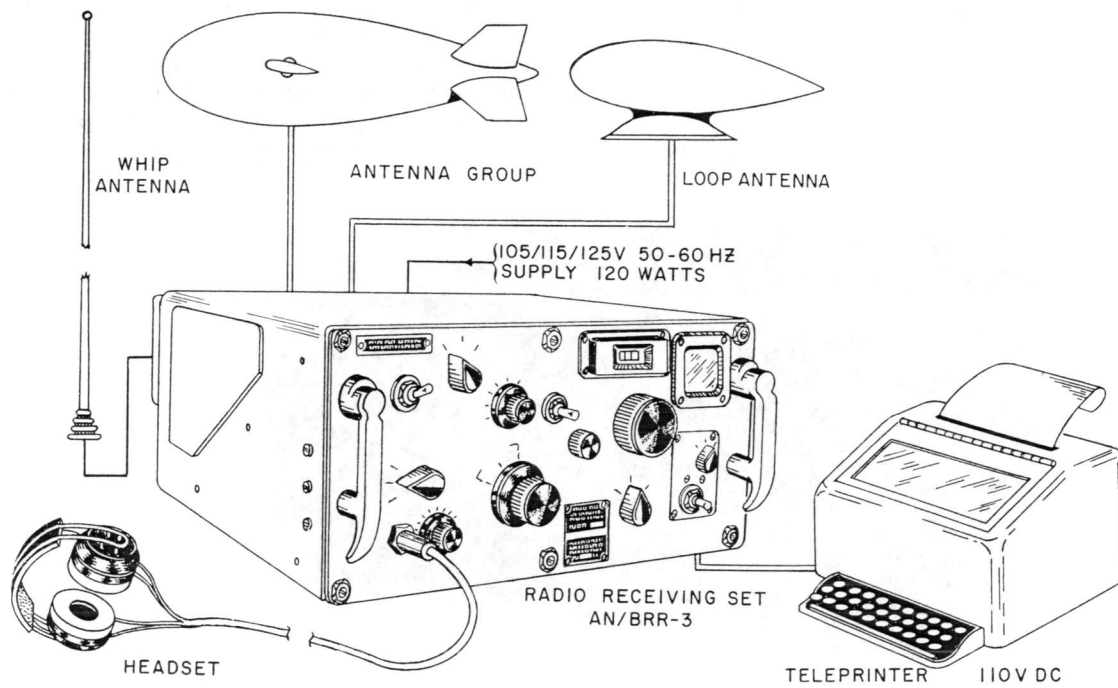

Figure 3-22.—Radio Receiving Set AN/BRR-3 and accessory equipment.

120.72

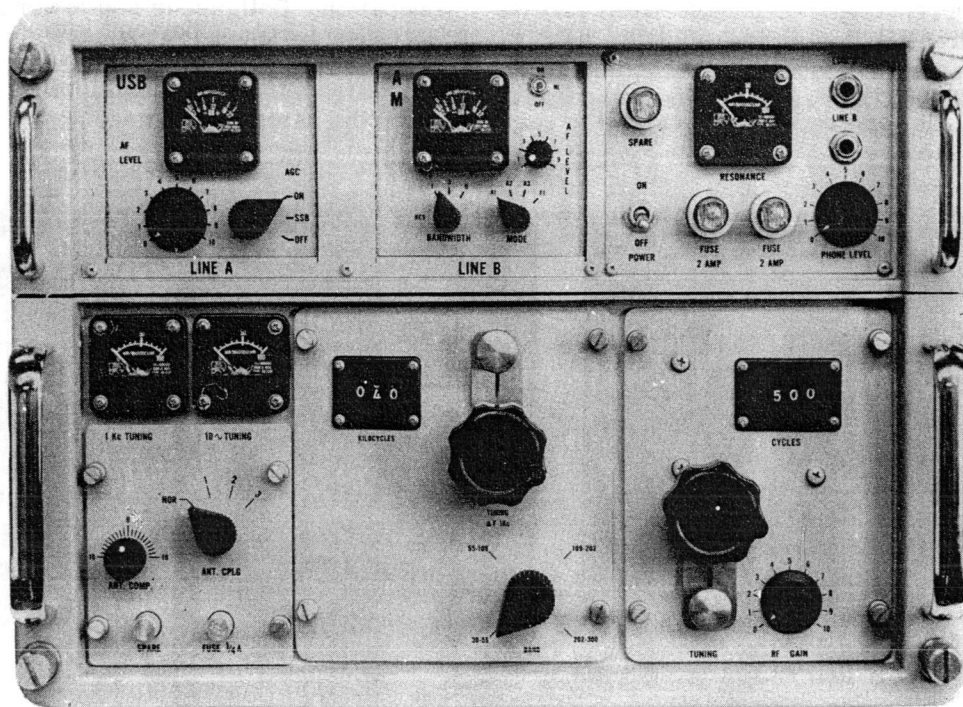

Figure 3-23.—Radio Receiver AN/SRR-19A.

120.73

(fig. 3-27). The same receiver, with rack mounting for shore station use, is called AN/FRR-59.

The AN/WRR-2B is a triple-conversion superheterodyne receiver. It covers the frequency range 2 to 32 MHz. This modern

In order to meet strict frequency tolerances, a frequency standard, having a low frequency and very stable oscillator, generates a very accurate fundamental frequency (and harmonics) to provide frequency reference check points throughout the 2 to 32 MHz frequency

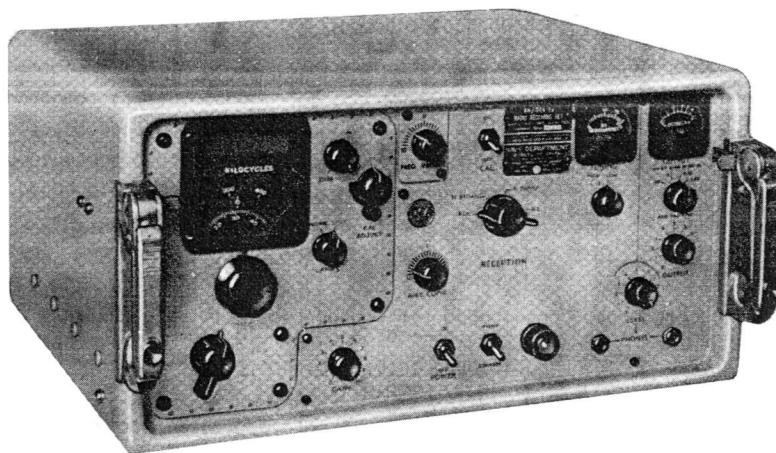
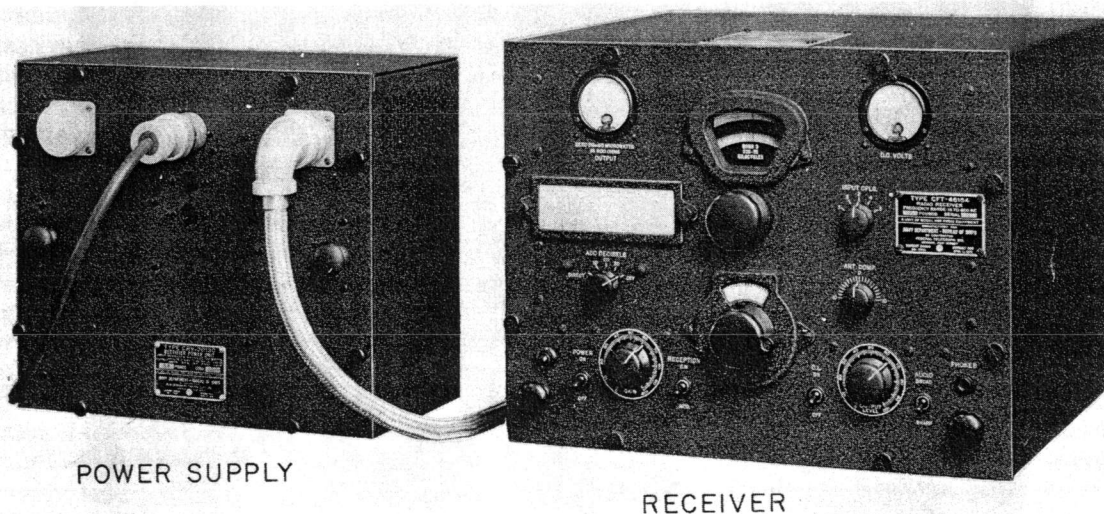

Figure 3-24.—Radio Receiver AN/SRR-11.

1.157

receiver is intended primarily for the reception of single-sideband transmissions with full carrier suppression. It can be used also to receive conventional amplitude-modulated signals of various types, including CW, MCW, voice, facsimile, and radioteletype.

range. This facilitates accurate tuning and a high degree of stability over long periods of operation. Both upper and lower sideband channels can be used simultaneously for receiving two different channels of intelligence or to receive the same intelligence.



POWER SUPPLY

RECEIVER

Figure 3-25.—Radio Receiver RBA with power supply.

34.17



F



t  
f  
c  
k  
i

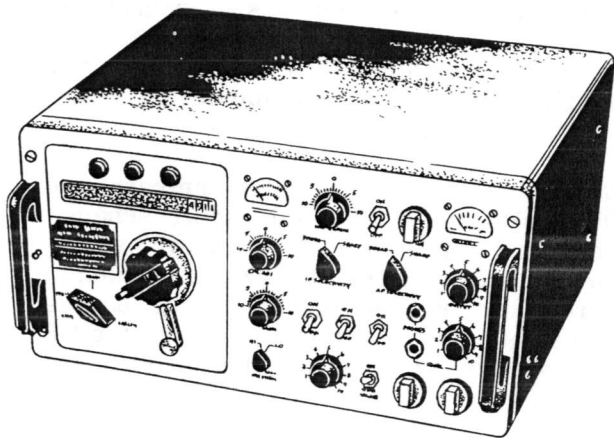

76.26  
Figure 3-26.—Radio Receiver AN/WRR-3B.

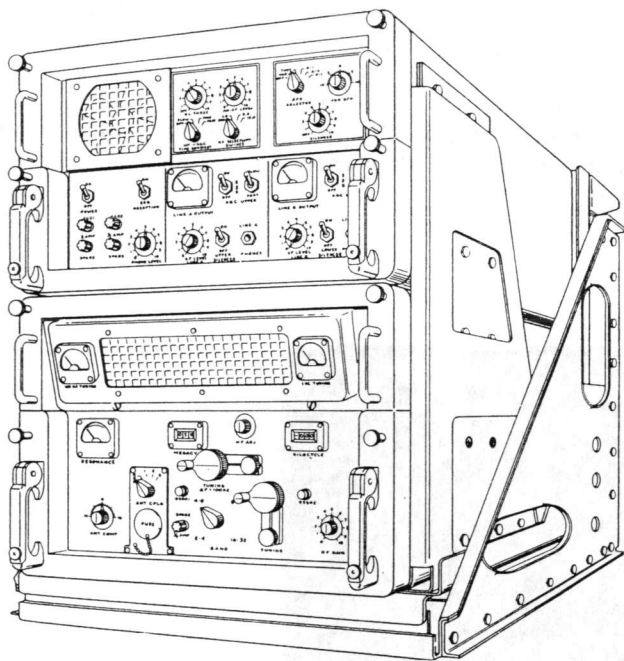

50.40  
Figure 3-27.—Radio Receiver AN/WRR-2B.

Other features of the receiver also contribute to its high performance. Any error in frequency resulting from drift in the local oscillator is removed before the last conversion by a drift-canceling circuit. Receiver tuning is in 0.5 kHz steps. Through the use of an

interpolation oscillator, each 0.5 kHz increment is scanned either continuously or in 1 kHz steps. Counter type tuning dials permit accurate pre-setting to any desired frequency.

The frequency range of 2 to 32 MHz is covered in four bands: band 1, 2.0 to 4.0 MHz; band 2, 4.0 to 8.0 MHz; band 3, 8.0 to 16.0 MHz; and band 4, 16.0 to 32.0 MHz.

Radio Receiver AN/URR-44

The AN/URR-44 (fig. 3-28) is an eleven tube superheterodyne type radio receiving set designed for use aboard all types of naval surface ships and at naval shore stations. The receiver is designed for voice modulated signal reception on standard broadcast and shortwave bands within the frequency range of 540 kHz to 18.6 MHz.

Radio Receiver R-390A/URR

Operating in the frequency range 500 kHz to 32 MHz, radio receiver R-390A/URR (fig. 3-29) is a high-performance receiver for both shipboard and shore station use. It can receive CW, MCW, AM, radiotelephone, radioteletype, and facsimile signals.

The receiver is a superheterodyne type, with multiple-frequency conversion. In the frequency range from 500 kHz to 8 MHz, it uses triple conversion. Double conversion is used in the range from 8 to 32 MHz.

The tuning knob turns an arrangement of gears and shafts to select the frequency to which the receiver is tuned. A counter type

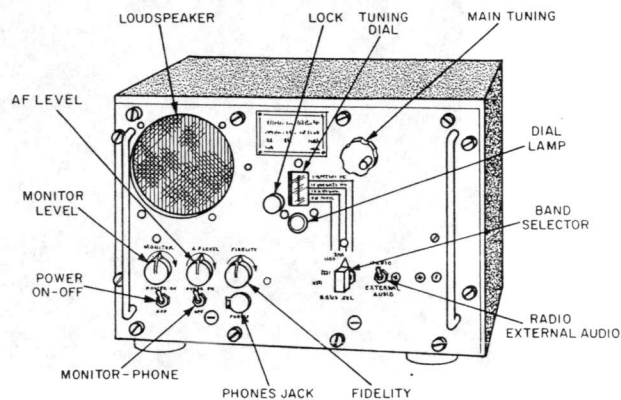

120.74  
Figure 3-28.—Radio Receiver AN/URR-44.



superheterodyne receiver capable of receiving any type of radio signal in the frequency range 2 to 30 MHz. It can be used as an independent receiver, or, in conjunction with a transmitter, it can be used to form a transmitter-receiver combination, similar to the Radio Set AN/WRC-1( ) described earlier.

Basically a crystal-controlled equipment, the R-1051B/URR uses a digital tuning scheme. An additional fine tuning control provides continuous tuning between 100 kHz increments. This receiver utilizes printed circuit boards and is completely transistorized, except for RF amplifier tubes. It is designated as standard equipment for use aboard all ships.

34.15

Figure 3-29.—Radio Receiver R-390A/URR.

frequency indicator dial is provided. The dial is calibrated in kilohertz.

#### Radio Receiver R-1051B/URR

The R-1051B/URR (fig. 3-30) is one of the newer radio receivers. It is a versatile

#### VHF AND UHF RECEIVERS

In most instances, radio receivers covering the VHF (and UHF) range are operated as crystal-controlled equipments. They are tuned easily and quickly. Once tuned, they operate efficiently for long periods of time without further attention. The trend is that modern transceivers will probably be replacing more radio receivers of this frequency range in the future.

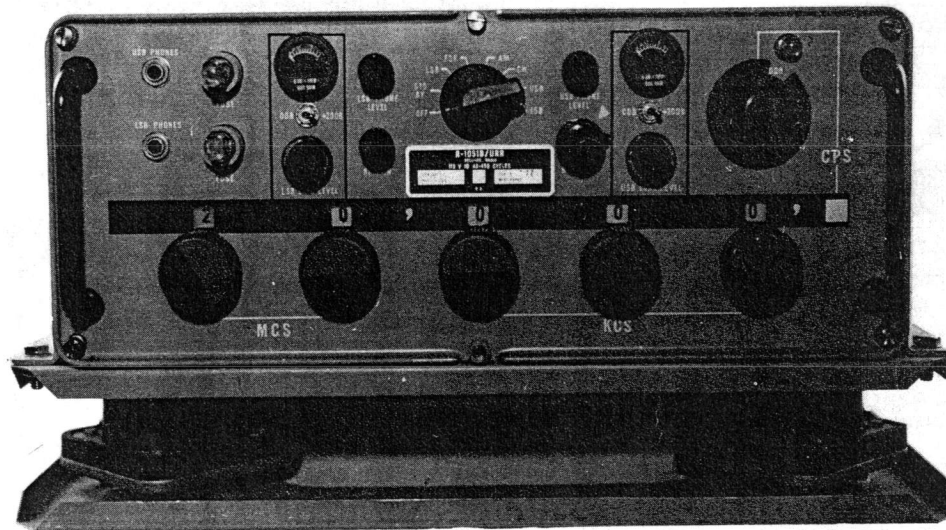

Figure 3-30.—Radio Receiver R-1051B/URR.

120.8

## Radio Receiver AN/URR-21( )

The AN/URR-21( ) receiver (fig. 3-31) is used for receiving amplitude-modulated radiotelephone signals, in a portion of the VHF band, from 115 to 156 MHz. It is a crystal-controlled superheterodyne receiver. Although the receiver dial is calibrated continuously, only four channels can be tuned within the frequency range for a given set of four individually selectable crystals. The four crystals are plugged into a crystal holder on the receiver chassis inside the cabinet. Special features include a front panel dial detent mechanism for rapid selection of channels, and continuous tuning of all RF circuits by means of a single tuning control.

## Radio Receiver AN/URR-27( )

Radio receiving set AN/URR-27 (fig. 3-32) provides for reception of amplitude-modulated voice and MCW transmission in the 105 to 190 MHz frequency range. You will note that this range of frequencies slightly exceeds that of the VHF transmitters, which cover a band from 115 to 156 MHz.

The AN/URR-27( ) is a superheterodyne receiver, designed chiefly for operation as a pretuned, single-channel, crystal-controlled receiver. Continuously variable manual tuning is also available. A single tuning control is used for tuning to any frequency for either crystal-controlled or manual tuning operation.

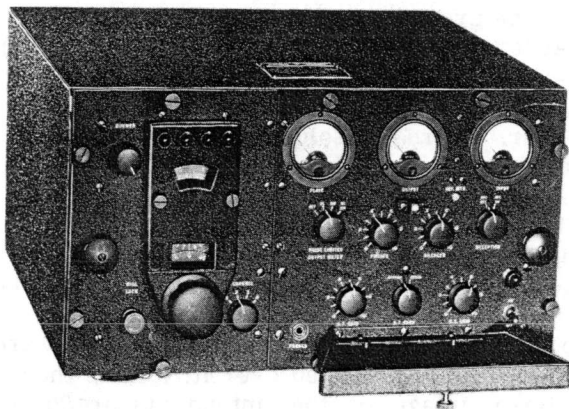

Figure 3-31.—Radio Receiver AN/URR-21( ).

32.56

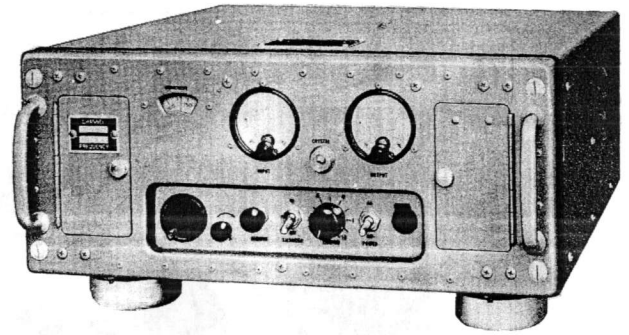

Figure 3-32.—Radio Receiver AN/URR-27( ).

32.42

## Radio Receiver AN/URR-35C

Radio receiver AN/URR-35C (fig. 3-33) is equipped for radiotelephone and MCW reception for use in tactical communications aboard ship. Although the frequency range of 225 to 400 MHz includes the upper portion of the VHF band, the receiver is commonly called UHF equipment. Designed mainly for single channel, crystal-controlled operation, it may also be used as a continuously variable manual tuned receiver. This receiver is easy to tune and features single tuning controls for tuning to any frequency within its range, for either crystal-controlled or manual tuning. It is a double conversion, pretuned, single-channel, superheterodyne receiver.

The AN/URR-35C receiver is commonly employed with the TED transmitter. This combination is commonly referred to by operators and technicians as a TED/RED group.

## SHIPBOARD ANTENNAS

Antennas used for radio communications are so varied in design that it is impractical to describe every antenna you may encounter aboard ship. Consequently, this section deals mainly with the use and physical appearance of some of the more common shipboard communication antennas. Any technical discussion of antenna theory is avoided, when possible. To understand why a particular antenna is suited for use at one frequency (or range of frequencies), yet is unsuited for others, you must have a knowledge of the relationship

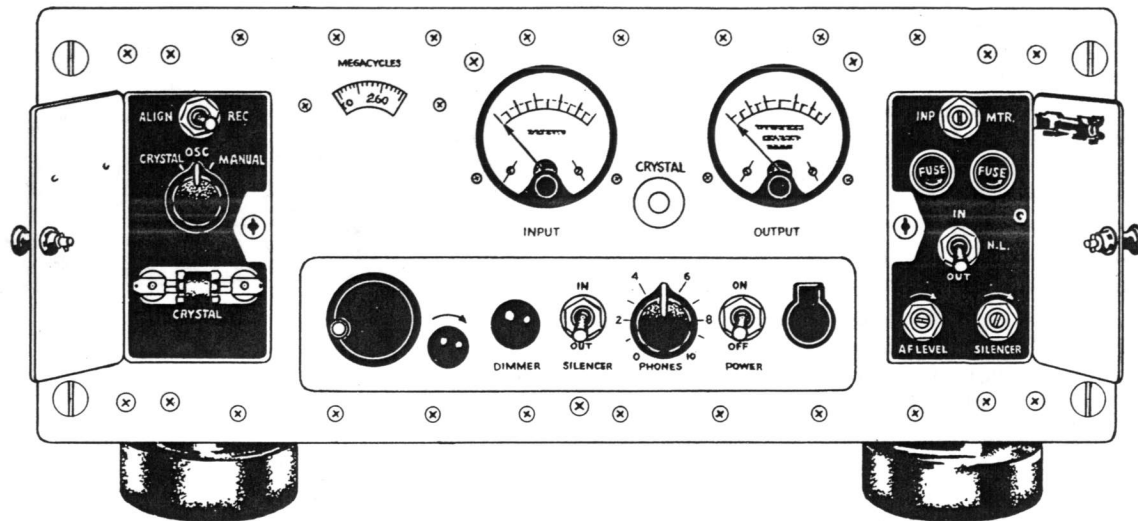

Figure 3-33.—Radio Receiver AN/URR-35C.

32.45

between an antenna's length and the frequency at which it is radiating.

The strength of the radio wave radiated by an antenna depends on the length of the antenna and the amount of current flowing in it. Because the antenna is a circuit element having inductance, capacitance, and resistance, the largest current is obtained when the inductive and capacitive reactances (opposition to the flow of alternating current) are tuned out; that is, when the antenna circuit is made resonant at the frequency being transmitted.

The shortest length of wire that will be resonant at any particular frequency is one just long enough to permit an electric charge to travel from one end of the wire to the other end and back again in the time of one cycle. The distance traveled by the charge is one wavelength. Because the charge must travel the length of the wire twice, the length of wire needed to have the charge travel one wavelength in one cycle is half a wavelength. Thus, the halfwave antenna, sometimes called a dipole, doublet, or Hertz is the shortest resonant length and is used as the basis for most antenna theory.

An antenna can be made resonant by two methods: (1) adjusting the frequency to suit a given antenna length; or, as usually is more practicable, (2) adjusting the length of the antenna wire to accommodate a given frequency.

Every time the transmitter is changed to a new frequency, it is, of course, impractical to lengthen or shorten an antenna physically. The antenna length may be changed electrically, however, by a process known as tuning, or loading, the antenna.

The dipole—a center-fed, half-wave antenna—is the basis for many complex antennas. When used for transmitting high frequencies, it usually is constructed of wire. At very high and ultrahigh frequencies, the shorter wavelength permits construction with metal rods or tubing. Because the dipole is an ungrounded antenna, it may be installed far above the ground or other absorbing structures.

At low and medium frequencies (below MHz), half-wave antennas are rather long for use aboard ship. Another basic type of antenna, however, affords a solution to the problem of undue length. It is the quarter-wave (Marconi) antenna.

The earth is a fairly good conductor for medium and low frequencies, and acts as a large mirror for the radiated energy. The result is that the ground reflects a large amount of energy that is radiated downward from an antenna mounted over it. It is as though a mirror image of the antenna is produced, the image being located the same distance below the surface of the ground as the actual antenna is located above it. Even in high-frequency

range (and higher), many ground reflections occur, especially if the antenna is erected over highly conducting earth or salt water.

Utilizing this characteristic of the ground, an antenna only a quarter-wavelength long can be made into the equivalent of a half-wave antenna. If such an antenna is erected vertically and its lower end is connected electrically to the ground, the quarter-wave antenna behaves like a half-wave antenna. Here, the ground takes the place of the missing quarter-wavelength, and the reflections supply that part of the radiated energy that normally would be supplied by the lower half of an ungrounded half-wave antenna.

Another method of operating a vertical quarter-wave antenna is to use a ground plane with the antenna. The ground plane usually is made of wires or rods extending radially from the base of the antenna. Actually, the ground plane substitutes for the ground connection, thereby establishing the ground level at the base of the antenna. Thus, the antenna can be installed on masts or towers high above ground. Ground plane antennas of this sort are used mostly for VHF and UHF communications.

Although discussions of antennas ordinarily concern those used for transmitting, an efficient transmitting antenna for any particular frequency is also an efficient receiving antenna for that same frequency. It must be remembered, however, that there may be other limitations affecting the use of an antenna for both transmitting and receiving.

Problems not usually present in land installations arise when antennas are installed on board ship. Most of the masts, stacks, and other structures above decks are connected electrically (grounded) to the ship's hull and, through the hull, to the water. To obtain adequate coverage from the antenna, it must be installed so that minimum distortion of the radiation pattern results from grounded structures.

The antennas described in the next six topics are only a sampling of the antennas used in the Navy. They are typical of the antennas you can expect to find installed aboard most Navy ships.

#### WIRE ANTENNAS

Wire antennas (fig. 3-34) are installed on board ship for medium- and high-frequency

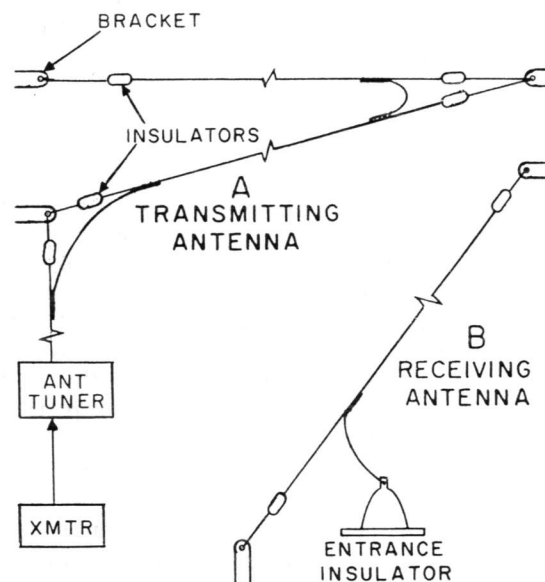

Figure 3-34.—Shipboard wire antennas. 1.46

coverage. Normally, they are not cut for a given frequency. Instead, a wire rope is strung either vertically or horizontally from a yardarm (or the mast itself) to outriggers, another mast, or to the superstructure. If used for transmitting, the wire antenna is tuned electrically to the desired frequency.

Receiving wire antennas usually are installed forward on the ship, rising nearly vertically from the pilothouse top to brackets on the mast or yardarm. They are located as far as possible from the transmitting antennas so that a minimum of energy is picked up from the local transmitters. The transmission line (lead-in) for each receiving antenna terminates in antenna transfer panels in the radio spaces.

Transmission lines of the transmitting antenna may be of coaxial cable or copper tubing. They are supported on standoff insulators and in some instances, are enclosed in rectangular metal ducts called antenna trunks. Each transmission line connects with an individual transmitter or with an antenna multicoupler (discussed later).

Metal rings, antenna knife switches, antenna hardware, and accessories associated with transmitting antennas are painted red. Hardware and accessories used with receiving antennas are painted blue. This color scheme

is a safety precaution, and indicates, at a glance, whether an antenna is used for radiating or receiving.

### WHIP ANTENNAS

Whip type antennas have replaced many wire antennas in the frequency range 1.8 to 30 MHz. Because they are essentially self-supporting, whip antennas may be installed in many locations aboard ship. They may be deck-mounted, or they may be mounted on brackets on the stacks or superstructure (fig. 3-35). Whip antennas commonly used aboard ship are 25, 28, or 35 feet in length, and are made up of several sections.

On aircraft carriers, whip antennas located along the edges of the flight deck can be tilted. The tilting whip is pivoted on a trunnion, and is equipped with a handle for tilting and erecting the antenna. A counterweight at the base of the antenna is heavy enough to nearly balance the antenna in any position. The antenna may be locked in either a vertical or horizontal position. Where antennas have water drain holes, it is most important to keep them unplugged during freezing operations.

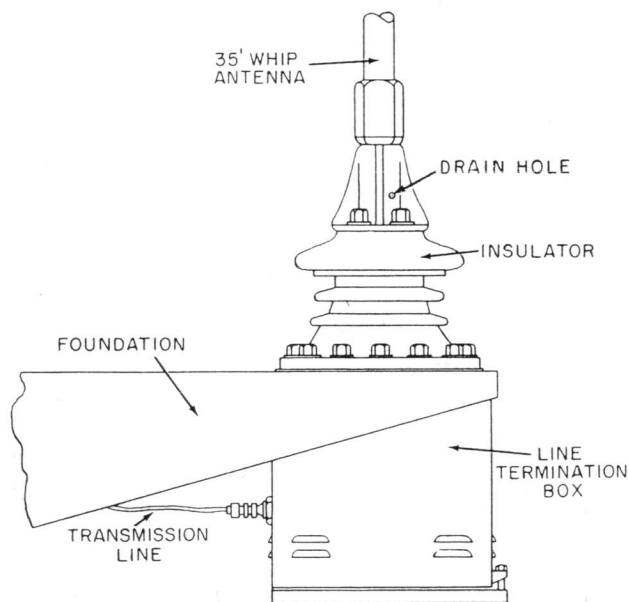

Figure 3-35.—Whip antenna.

1.47

### FAN ANTENNA

The fan antenna (fig. 3-36) is highly suitable for shipboard installation. It is known as a broadband antenna since it is capable of radiating over a wide range of frequencies. The fan antenna was designed principally for use in the low-frequency range, but it also performs satisfactorily in the high-frequency band with proper multicouplers.

The antenna usually consists of four radiating elements (wires) that are cut for one-quarter wavelength at the lowest frequency to be transmitted. Whether one or all of these elements are fed energy by the transmitter, the overall effect of the paralleled elements is to increase the radiating surface. Effectively, the fan antenna is a single radiator whose diameter is substantially large in comparison to its length.

### SLEEVE ANTENNA

The sleeve antenna (fig. 3-37), originally developed to fill the need for a versatile, long-distance antenna ashore, now is installed aboard many ships. Essentially, the sleeve antenna is a grounded, quarter-wave antenna that operates over a wide range of frequencies in the high-frequency band. Although similar in appearance to the whip antenna, it is identified

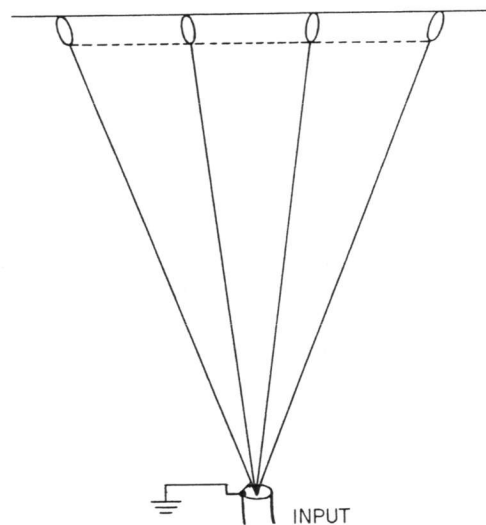
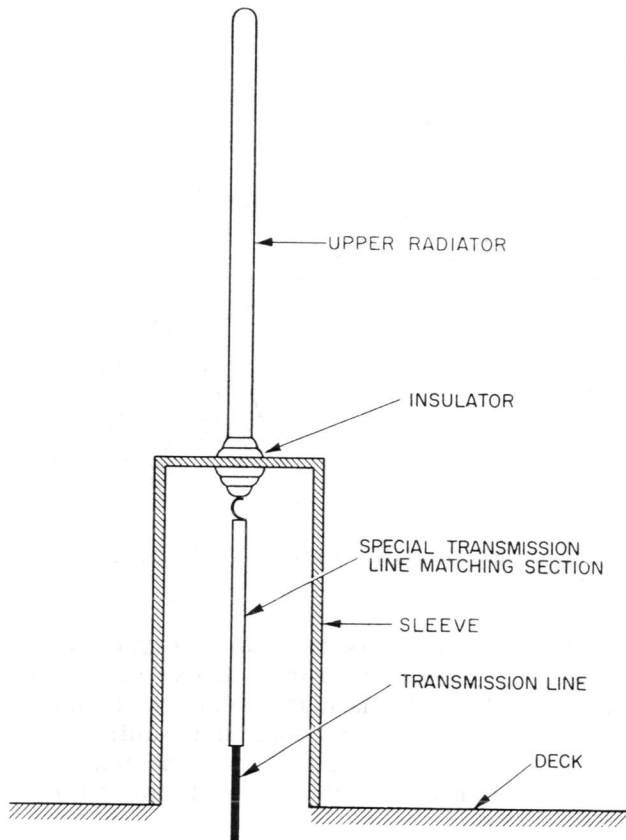

Figure 3-36.—Fan antenna.

25.126





25.217

Figure 3-37.—Sleeve antenna (shipboard).

easily by the large diameter sleeve at its base. The sleeve usually is welded to the deck or superstructure of the ship.

#### CONICAL MONOPOLE ANTENNA

Another broadband antenna used extensively is the conical monopole shown in figure 3-38. Like the sleeve antenna, it is used both ashore and aboard ship.

When operating at frequencies near the lower limit of the high-frequency band, the conical radiates in much the same manner as a regular vertical antenna (omnidirectional on the horizontal plane). At the higher frequencies the lower cone section radiates, and the effect of the top section is to push the signal out at a low angle. The low angle of radiation causes the skywave to return to the earth at great distances from the antenna. Hence, the conical

monopole antenna is well suited for long-distance communication in the high-frequency range.

#### VHF-UHF ANTENNAS

At VHF and UHF frequencies, the shorter wavelength makes the physical size of the antenna relatively small. Aboard ship these antennas are installed as high and as much in the clear as possible.

For best results in the VHF and UHF ranges, both transmitting and receiving antennas must be mounted on the same plane (vertically or horizontally). Vertically mounted

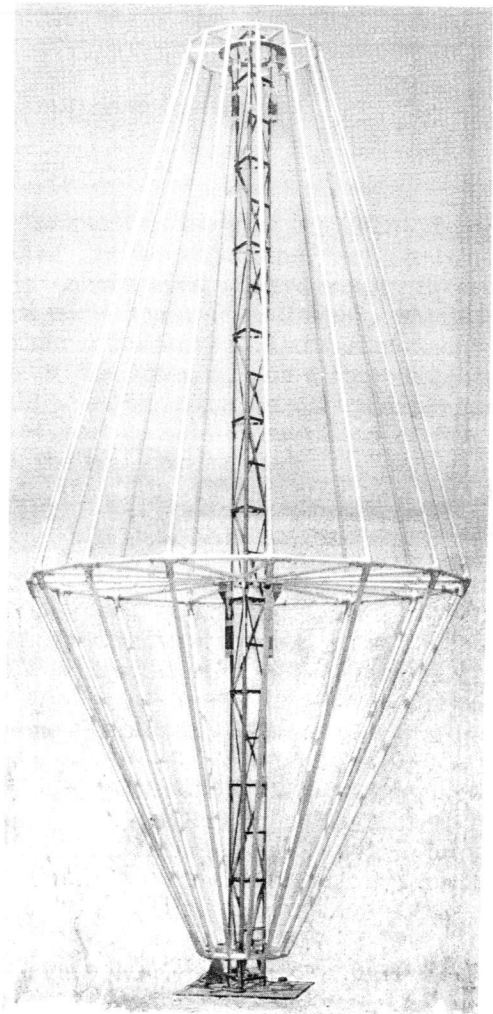

25.214

Figure 3-38.—Conical monopole antenna.

antennas are used for all ship-to-ship, ship-to-shore, and air-ground VHF-UHF communications. Usually, either a vertical half-wave dipole or a vertical quarter-wave antenna with ground plane is used.

The VHF antenna commonly installed aboard ships is Navy type 66095, shown in figure 3-39. The horizontal portion of the antenna does not radiate, but acts as a mounting arm for the antenna and as an enclosure for the antenna feedline. The antenna is installed with the radiating portion in the vertical position. The antenna works with any transmitter and receiver operating in the frequency range 100 to 156 MHz.

An antenna frequently used with UHF installations is the AT-150/SRC (fig. 3-40). This

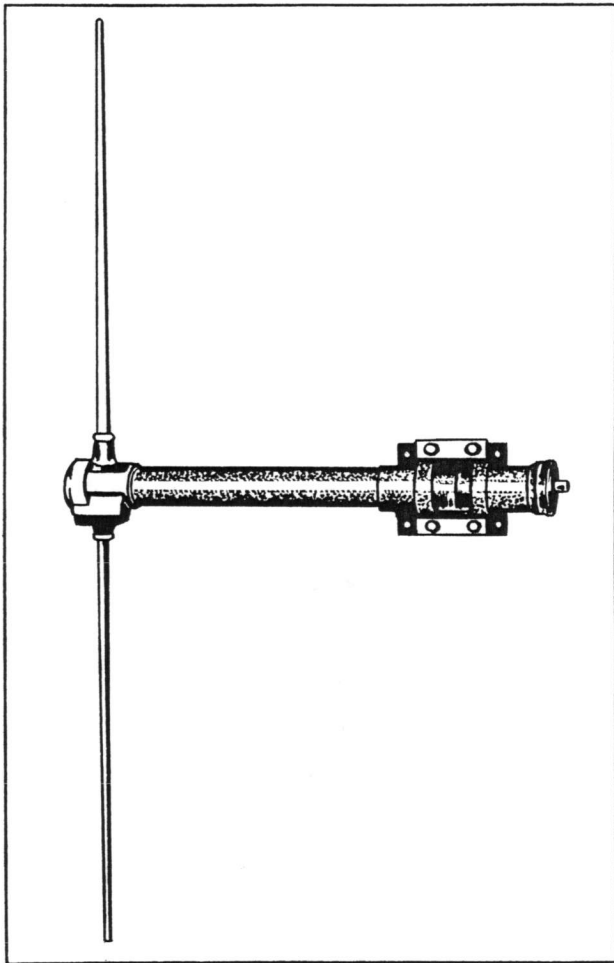
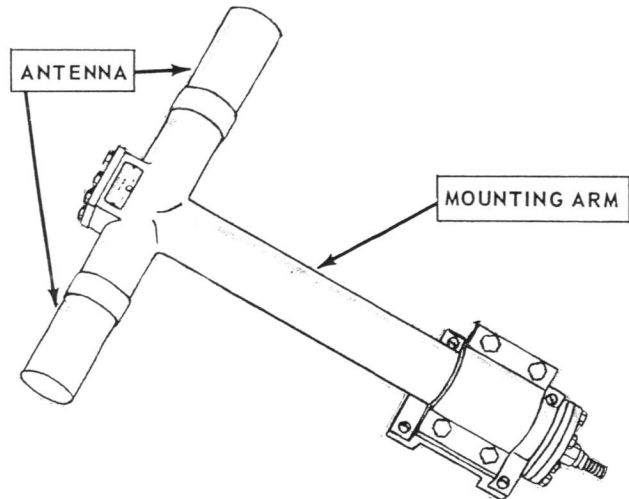

Figure 3-39.—VHF antenna NT-66095.

120.10



25.219

Figure 3-40.—UHF Antenna AT-150/SRC.

antenna is of the half-wave (dipole) type, and it covers the frequency range 225 to 400 MHz. Like the VHF antenna just described, the horizontal (longer) section does not radiate, but serves as a mounting arm for the antenna. The antenna is mounted so that the radiator is vertical.

The AS-390/SRC (fig. 3-41) is another UHF antenna that operates at frequencies between 225 and 400 MHz. It is a quarter-wave antenna with a ground plane. The ground plane consists of a round plate (called a counterpoise) and eight equally spaced drooping radials (rods). The antenna is mounted vertically.

The AS-1018/URC (fig. 3-42) is an additional 225 to 400 MHz antenna often installed aboard ships. This antenna is the UHF version of the broadband sleeve antenna and is capable of radiating over a wide range of frequencies. The antenna provides essentially a horizon-to-90° overhead, 360° circular radiation pattern. The antenna is vertically polarized and has lower half power points on or below the horizon. The vertical upward propagation needed to fill the cone of silence is horizontally polarized.

The AS-1018/URC consists basically of the polyester fiberglass 6-foot mast (fig. 3-42A), the two-element colinear dipole array, and the internal transmission line (fig. 3-42B).

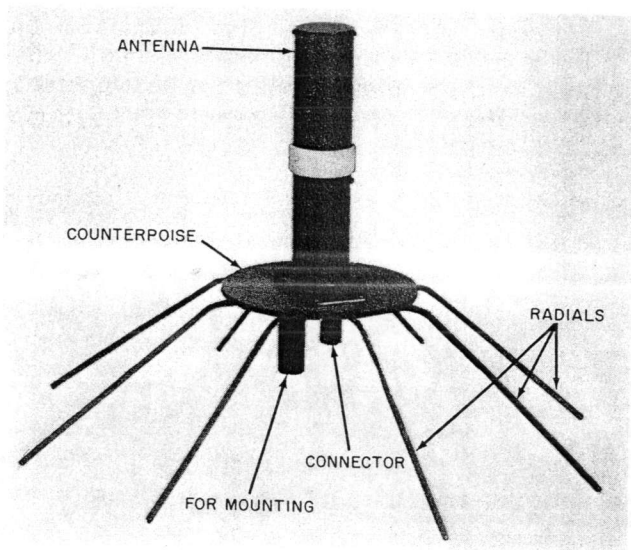

25.220

Figure 3-41.—UHF Antenna AS-390/SRC.

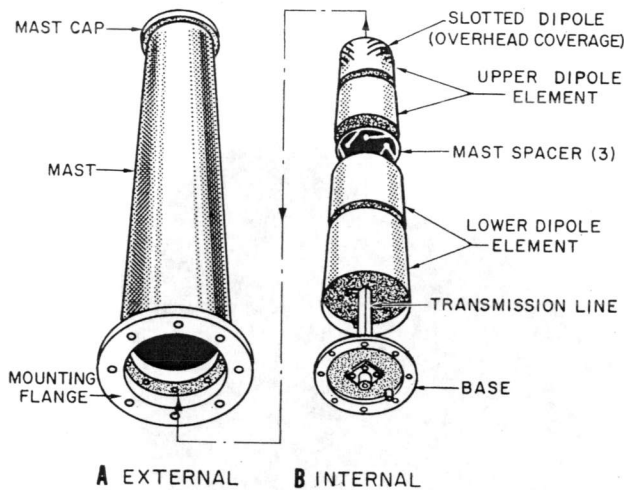

109.44(120)

Figure 3-42.—UHF Antenna AS-1018/URC.

### AUXILIARY EQUIPMENT

The term "auxiliary" often is misleading, particularly in the field of electronics. In most instances, material categorized as auxiliary equipment is essential to the efficient operation of an overall system. But, because it is subordinate to the primary equipments,

such as transmitters, receivers, and antennas, it is classified as an auxiliary.

Some of the more prominent auxiliary equipments used in communication systems are discussed in the ensuing topics of this chapter.

### ANTENNA TUNING

Antenna systems are generally not ideal from the standpoint of position, efficiency, and antenna lengths, because of space limitations and the crowded conditions which are often characteristic of naval vessels. Frequently, a relatively short whip antenna may be employed, even for frequencies at the low end of the high frequency range.

Some transmitters are equipped with tuning devices which manually or automatically tune the antenna to the selected transmitter frequency. Proper tuning is necessary in order to obtain maximum transfer of power from the transmitter to the antenna.

### Antenna Coupler AN/SRA-22

The antenna coupler AN/SRA-22 (fig. 3-43) is used for whip and other radio antennas normally encountered aboard ship. It consists of the antenna tuner (fig. 3-43A), which is an all weather completely sealed unit mounted near the base of the antenna, and a remote control (fig. 3-43B), which contains all controls and indicators for complete operation of the coupler from the transmitter rack.

The AN/SRA-22 operates on a 120 VAC, 60 hertz power source in the 2 to 30 MHz frequency range. This coupler was originally designed for the AN/URC-32 transmitter, but may be used with other transmitters. Being manually tuned equipment, it will probably be replaced by the AN/URA-38 antenna coupler.

### Antenna Coupler AN/URA-38

The AN/URA-38 antenna coupler group consists of an antenna coupler and an antenna coupler control unit (fig. 3-44). The group is an automatic antenna tuning system intended primarily for surface ship and shore use with Radio Transmitting Set AN/URT-23(V). However, the equipment design includes provisions for manual and semiautomatic tuning, thus, making the system readily adaptable for use with other high power radio transmitters in the high-frequency range. The manual tuning

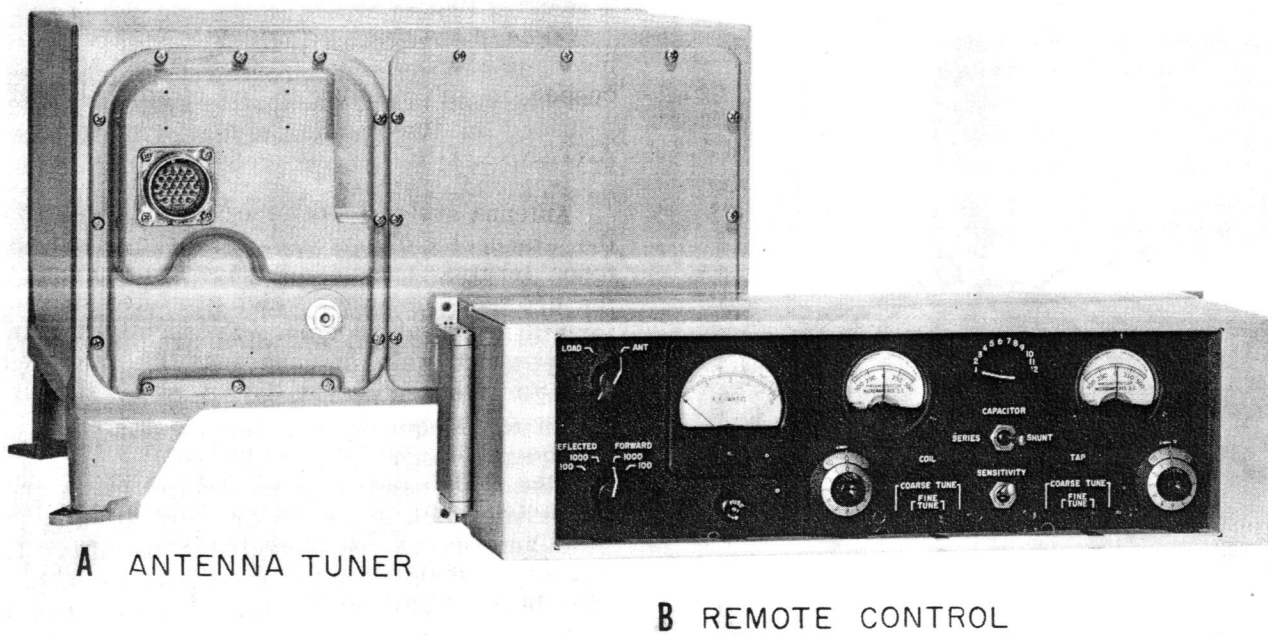

A ANTENNA TUNER

B REMOTE CONTROL

Figure 3-43.—Antenna Tuning Coupler AN/SRA-22.

120.75

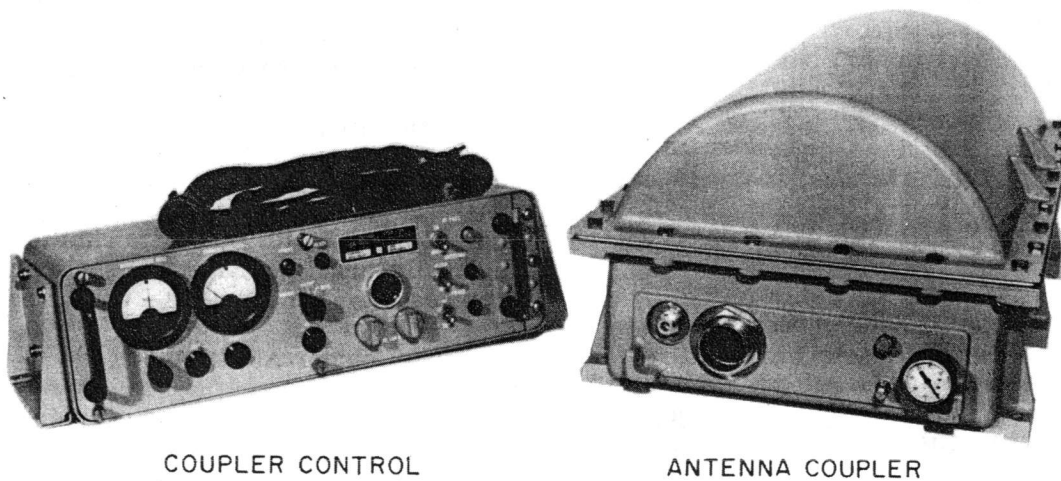

COUPLER CONTROL

ANTENNA COUPLER

Figure 3-44.—Antenna Tuning Coupler AN/URA-38.

120.76

capability is useful if a failure occurs in the automatic tuning circuitry. The AN/URA-38 can also be tuned without the use of RF power

(referred to as silent tuning). This method is useful in installations where radio silence must be maintained, except for brief transmission

periods. The control signals from the antenna coupler control unit automatically tune the antenna coupler matching network. A low power CW signal is required for tuning.

During manual and silent operation, tuning is accomplished by the radioman operating the controls located on the antenna coupler control unit.

#### ANTENNA MULTICOUPLERS

Because of the large number of transmitters and receivers on board ships, it is infeasible to use a separate antenna for each equipment. One satisfactory approach to the problem is provided by multicouplers.

Antenna multicouplers are devices that permit the simultaneous operation of several transmitters or receivers into (or from) the same antenna. The term "multicoupler" is descriptive of two or more couplers stacked or grouped together to form a single equipment, which then is connected to a broadband antenna. A separate coupler is required for each transmitter or receiver. Normally, the same antenna cannot be used for both transmitting and receiving simultaneously unless proper frequency separation and/or a duplexing system is employed.

#### Multicouplers AN/SRA-13, -14, -15, -16

Four antenna coupler groups that operate in the MF-HF range are the AN/SRA-13, -14, -15, and -16. They provide complete coverage of frequencies between 2 and 26 MHz. The frequency coverage afforded by each multicoupler is as follows: AN/SRA-13, 2 to 6 MHz; AN/SRA-14, 4 to 12 MHz; AN/SRA-15, 6 to 18 MHz; and AN/SRA-16, 9 to 26 MHz.

Typical of this group is the AN/SRA-15, which is illustrated in figure 3-45. The four couplers comprising the multicoupler provide for the simultaneous operation of four transmitters (each with 500-watt power output) into a single broadband antenna. As long as there is adequate separation between the operating frequencies, the four transmitters connected to the multicoupler may be operated anywhere in the frequency range from 6 to 18 MHz. Separation of 10 percent of the highest operating frequency is considered sufficient, however, a 15 percent figure provides better power

transfer and decreases the chance of damage to the equipment in case of temporary malfunction.

#### Multicoupler AN/SRA-23

Antenna multicoupler AN/SRA-23, (fig. 3-46) consists of three couplers and associated control and blower units. The couplers cover the frequency range 2 to 27 MHz in three frequency bands. Each coupler operates in a different band. These bands are 2 to 6 MHz, 5 to 15 MHz, and 9 to 27 MHz. The coupler group was developed for use with 500-watt transmitters, but, with minor adjustments, it is capable of handling transmitters with 1000-watt outputs.

One coupler group accommodates only one transmitter. Provisions are made, however, for connecting up to eight of these groups together to form a multicoupler system. This arrangement permits the simultaneous operation of eight transmitters into a single broadband antenna.

#### Multicouplers CU-691/U and CU-692/U

Both the CU-691/U and the CU-692/U are VHF-UHF multicouplers operating at

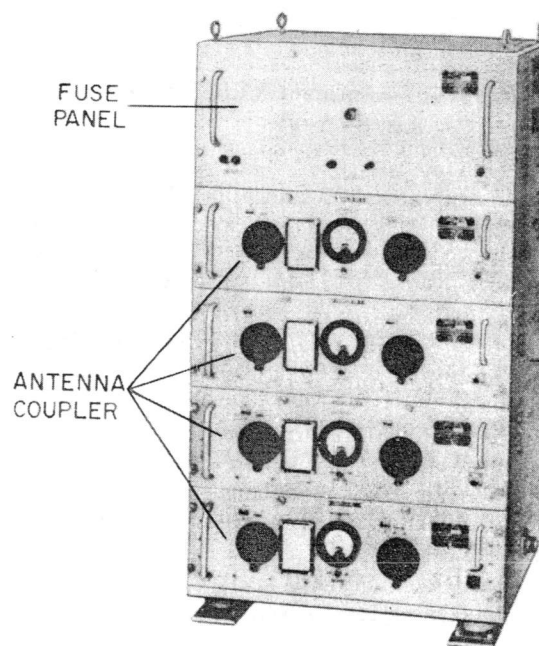

120.11  
Figure 3-45.—Antenna Multicoupler AN/SRA-15.

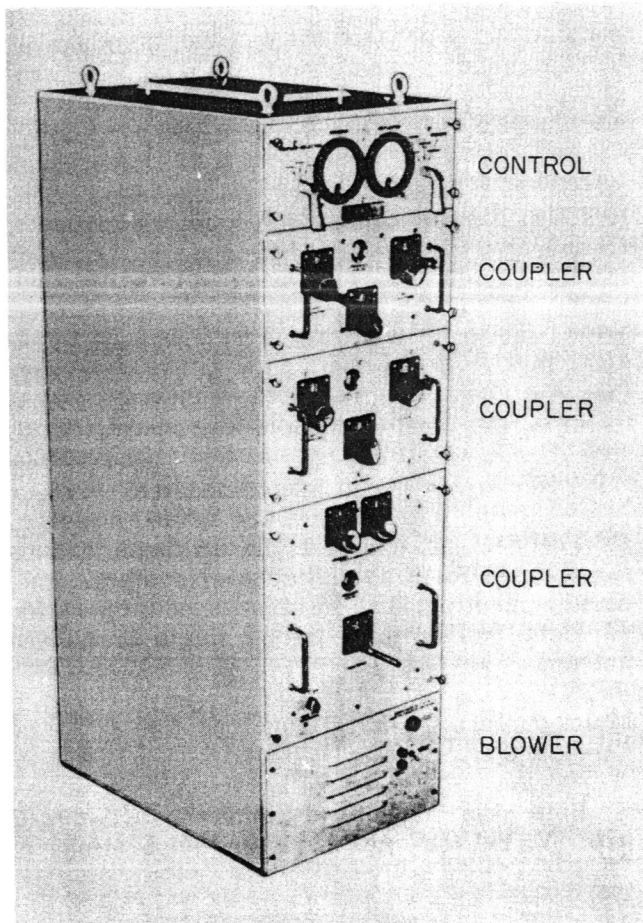

120.12  
Figure 3-46.—Antenna Multicoupler AN/SRA-23.

frequencies between 225 and 400 MHz. Except for their physical dimensions and the number of channels, the two sets are identical. The CU-691/U provides for the operation of four transmitters or receivers, whereas the CU-692/U accommodates only two. Both multicouplers are tuned manually. The CU-691/U is shown in figure 3-47.

Like most VHF-UHF couplers, the performance characteristics of these two types of couplers require that operating frequencies on the common antenna be separated by approximately 15 MHz.

Receiving Multicouplers AN/SRA-12

The AN/SRA-12 (fig. 3-48) filter assembly multicoupler provides seven radiofrequency

channels in the frequency range from 14 kHz to 32 MHz. Any or all of these channels may be used independently of any of the other channels, or they may operate simultaneously. Connections to the receivers are made by means of coaxial patch cords, which are short lengths of cable with plugs attached to each end.

A set of nine plug-in type filter subassemblies is furnished with the equipment, but only seven of them may be installed at one time. The seven filters installed are selected to cover the most-used frequency bands.

TRANSMITTER AND RECEIVER TRANSFER PANELS

Transmitter and receiver transfer panels are an integral part of every shipboard radio system. They make it possible to connect

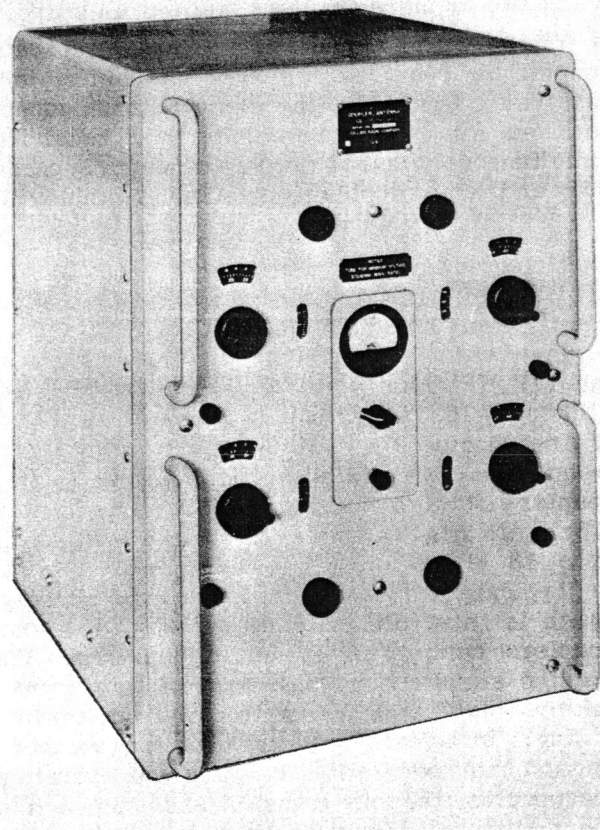

120.14  
Figure 3-47.—UHF Antenna Multicoupler CU-691/U.

t  
p  
f  
p  
a  
s  
  
R  
S  
  
S  
s  
t  
i  
s  
w  
o  
t  
h  
a  
o  
z  
s  
  
t  
o  
r  
t  
r  
n  
b  
s  
i  
r  
t

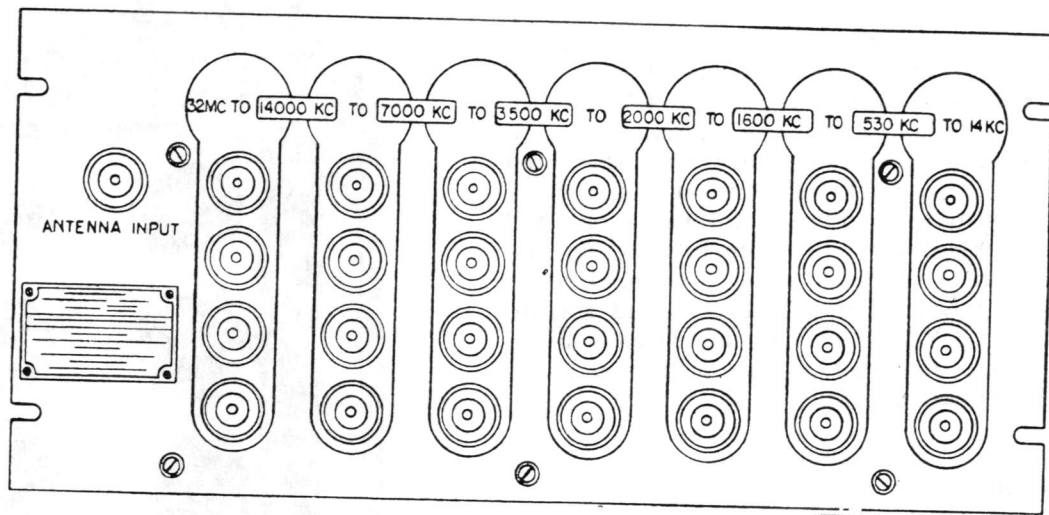

Figure 3-48.—Electrical Filter Assembly AN/SRA-12.

1.115

transmitters and receivers to remote control points located throughout the ship. These transfer panels formerly were of the cumbersome patch cord type, but those currently installed aboard ships are of the switchboard type described here.

#### Receiver Transfer Switchboard SB-82/SRR

Receiver transfer switchboard, type SB-82 SRR, (fig. 3-49) has five vertical rows of ten single-throw (ON-OFF) switches that are continuously rotatable in either direction. One side of each switch within a vertical row is wired in parallel with the same sides of the other nine switches within the row. Similarly, the other side of each switch is wired in parallel horizontally with the corresponding sides of each of the other four switches in a horizontal row. This method of connecting the switches permits a high degree of flexibility.

In general, there are more remote stations than radio receivers, hence the audio outputs of five receivers are fed to the five vertical rows, and ten remote stations are connected to the ten horizontal rows. With this arrangement, a selected receiver output is connected to any or all of the remote stations by closing the proper switch(es). When one switchboard is inadequate for accommodating all of the receivers and remote stations installed in a ship, several of these

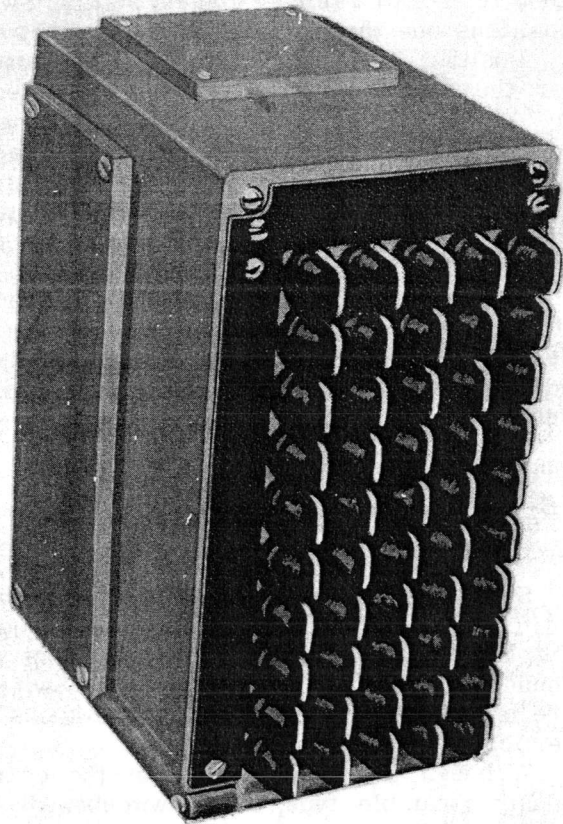

Figure 3-49.—Receiver Transfer Switchboard SB-82/SRR.

36.69

switchboards are mounted together and interconnected so that they form a bank of switchboards.

The knob of each switch is marked with a heavy white line to provide visual indication of whether the switch is in the ON or OFF position. Switchboards are always installed with the line positioned vertically when the switch is open (off). To further standardize all installations, receivers usually are connected to the vertical rows of switches, and remote stations are connected to the horizontal rows.

Identification of the Receivers and remote stations is engraved on the laminated bakelite label strips fastened along the top and left edges of the panel front.

#### Receiver Transfer Switchboard SB-973/SRR

A recent model receiver transfer switchboard is the SB-973/SRR (fig. 3-50). This switchboard contains 10 seven-position rotary selector switches. Each switch or operating knob relates to a remote control station. Switch positions one through five relate to receivers.

Position X on each switch serves to transfer the remote control stations connected to the original switchboard to the corresponding switches in additional switchboards. In this manner, any one of a number of receivers can be connected to any of the ten remote control stations. An additional switchboard is needed for each five additional receivers.

Switchboards providing facilities for additional remote control stations are mounted in vertical sequence, whereas those containing additional receivers are mounted in horizontal sequence.

#### Transmitter Transfer Switchboard SB-83/SRT

Transmitter transfer switchboard, type SB-83/SRT, (fig. 3-51) has five vertical rows of ten switches. Radio transmitters are wired to the five vertical rows; remote stations are connected to the ten horizontal rows. Switches are off when the white lines on the knobs are vertical.

Although the switches are of the continuously rotatable type, most switchboards are equipped with a spring-loaded, mechanical interlock that allows the switches to be closed by turning the knobs in a clockwise direction.

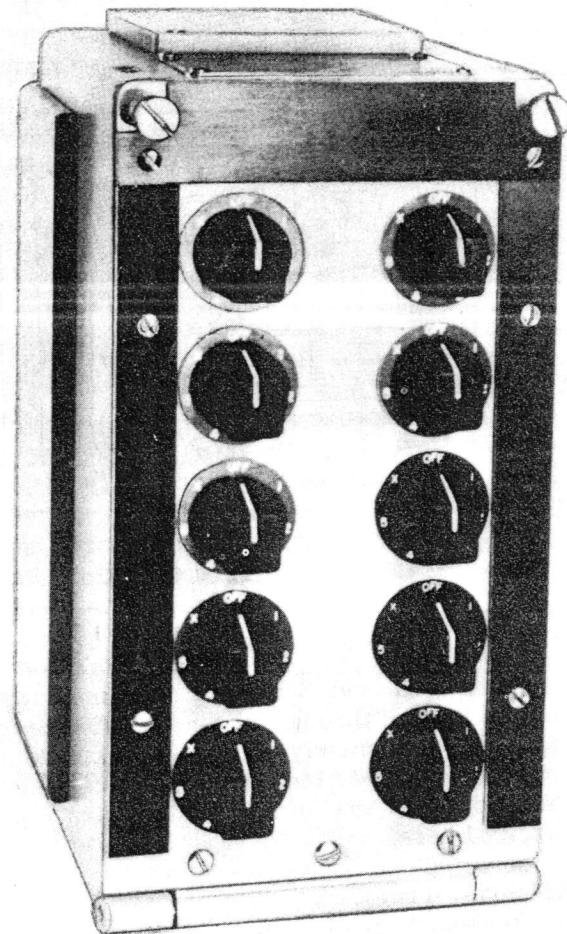

Figure 3-50.—Receiver Transfer  
Switchboard SB-973/SRR.

120.16

The switches are then opened by turning the knobs counterclockwise. The interlock also prevents additional switches in each horizontal row from being closed when any one of the five switches in that row is closed already. This arrangement prevents serious damage that is certain to result from two or more transmitters feeding a single remote-control station at the same time.

By wiring several of these boards together, facilities are available for transferring any transmitter to any or all remote control stations.

#### Transmitter Transfer Switchboard SB-863/SRT and SB-988/SRT

The models SB-863/SRT and SB-988/SRT transmitter transfer switchboards are replacing



REMOTE-CONTROL UNITS

To operate radio transmitters from remote locations requires the use of remote-control units. Most of these units are used as radio-phone units. (RPUs). They provide for energizing and deenergizing transmitters, for connecting microphones, handsets, chestsets, telegraph keys, and headphones, and for controlling the audio output level (volume) of radio receivers. Some units also enable remote selection of radio channels when they are utilized to control multichannel transmitters and receivers (such as the model AN/GRC-27).

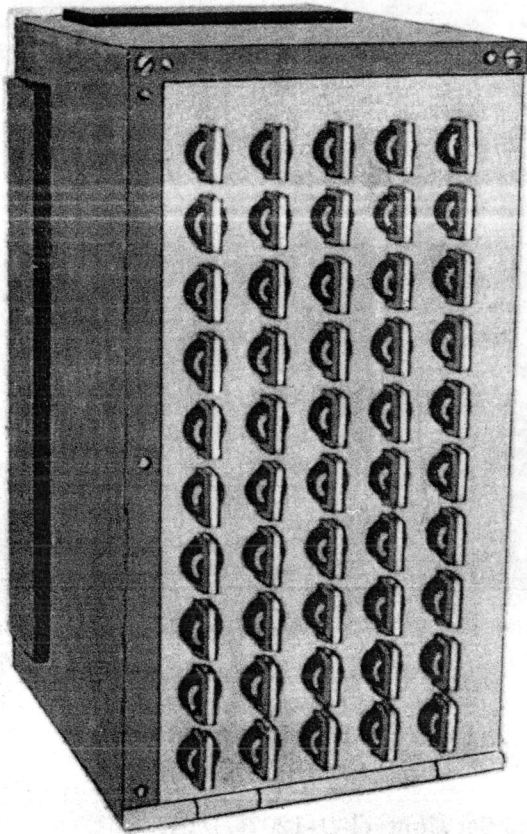

Figure 3-51.—Transmitter Transfer Switchboard SB-83/SRT.

36.70

the SB-83/SRT in shipboard installations. Except for their transmitter-handling capacity, these two newer switchboards are identical. The SB-863/SRT (fig. 3-52) handles up to 19 transmitters, whereas the SB-988/SRT (not illustrated) handles only 6.

Both of these switchboards have 10 rotary selector switches in two vertical columns. Each rotary switch corresponds to a remote-control station, and each switch position either corresponds to a controlled transmitter or serves to transfer the remote station to an adjacent switchboard. The remote station assigned each rotary switch and the transmitter assigned each switch position are identified on the bakelite plates attached to the front of each switchboard.

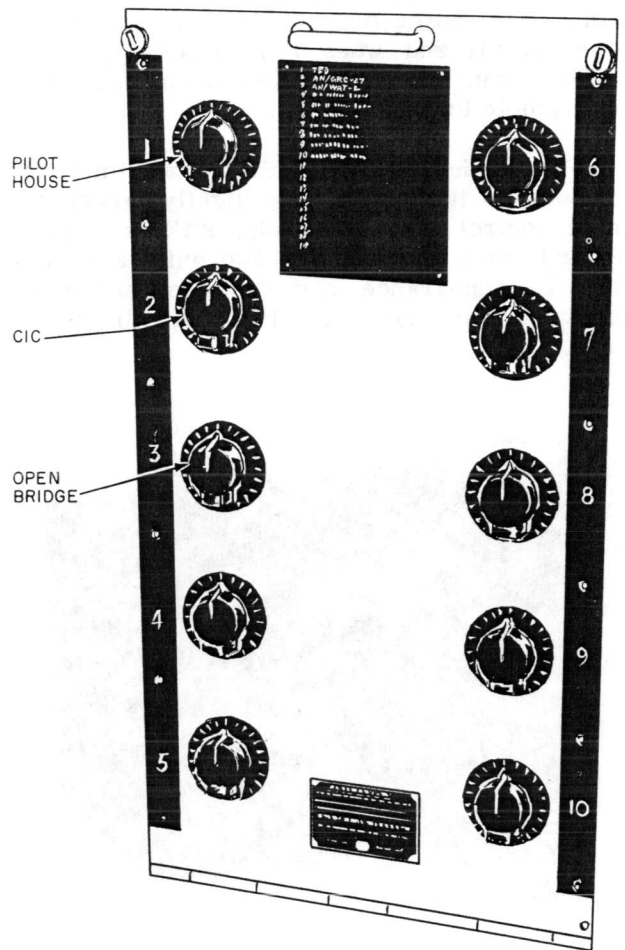

Figure 3-52.—Transmitter Transfer Switchboard SB-863/SRT.

70.64

## Radio Set Control C-1138( )/UR

Radio set control C-1138( )/UR (fig. 3-53) is a remote-control unit designed for installation in protected locations, as in the CIC or pilothouse. This unit contains a start-stop switch for turning a transmitter on or off, jacks for connecting a handset or chestset, microphone, headphones, or telegraph key, a volume control for the headphone or loudspeaker, and indicator lamps for transmitter-on (power) and carrier-on indications. Although provisions are made for CW operation, the unit seldom is used for this purpose. In most instances it is utilized for radiotelephone communications.

By means of transmitter and receiver transfer switchboards, as many as four of these remote-control units may be connected to the same transmitter or receiver. This arrangement is utilized when it is necessary that a radio channel be controlled from more than one remote location.

The model C-1138( )/UR is an improved version of the older and slightly larger remote-control unit NT-23500, still in service aboard many ships. The two units are similar in appearance and function, hence the older set is not described nor illustrated here.



Figure 3-53.—Radio Set Control C-1138( )/UR.

7.40.2A

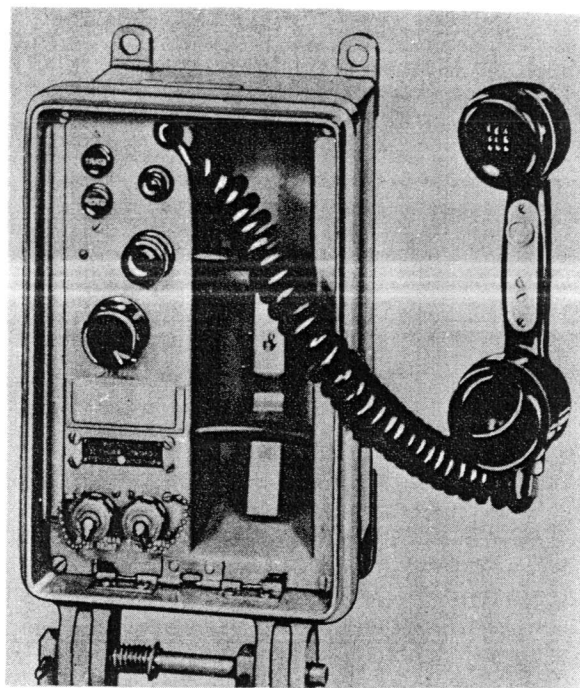

Figure 3-54.—Radio Set Control C-1207( )/UR.

7.40

## Radio Set Control C-1207( )/UR

Radio set control C-1207( )/UR, (fig. 3-54) is designed for installation in areas that are exposed to the weather. Access to its controls is obtained by opening the front cover, which is hinged to the unit. The controls, consisting of a handset, a transmitter start-stop switch, and a receiver volume control, are mounted on the front panel of the unit. Also mounted on the panel are two indicator lamps that provide visual indication of whether the transmitter power and carrier-on circuits are energized or deenergized, and two jacks for connecting a chestset and a set of headphones.

When connected to a standard shipboard transmitter and receiver, the C-1207( )/UR permits remote control of the following functions: (1) energizing and deenergizing the transmitter, (2) voice modulating the transmitter input, and (3) controlling the receiver's audio level to the earphone(s). As many as

four of these units may be connected to the same transmitter and receiver.

#### Control Panel Telegraph Key SB-315B/U

Control panel telegraph key SB-315B/U (fig. 3-55) contains the components and circuitry necessary to control the operation of a radio transmitter from a remote position. Located on the plastic control panel are (1) a toggle switch for turning the transmitter on or off, (2) an indicator light that glows red when the transmitter is on, (3) a telegraph key that provides a means for keying the transmitter, and (4) a key jack that provides for an auxiliary telegraph key.

This combination control panel and telegraph key is used in conjunction with a CW or MCW transmitter for the purpose of transmitting messages in international Morse code.

#### Remote-Control/Indicator Unit NT-23496

Although designed for use with a now obsolete transmitter-receiver combination, the remote-control/indicator unit NT23496 still is used aboard many ships for controlling multichannel transmitters and receivers. The unit, illustrated in figure 3-56, is capable of handling a transmitter and two receivers simultaneously. This arrangement permits guarding two radio channels, with the transmitter available for use on either channel. By operating an equipment selector switch and a dial-type channel selector, the operator can select any of ten preset radio channels on any multichannel transmitter or receiver controlled by the unit. A set of the usual remote controls is provided for each equipment operated by the remote-control unit.

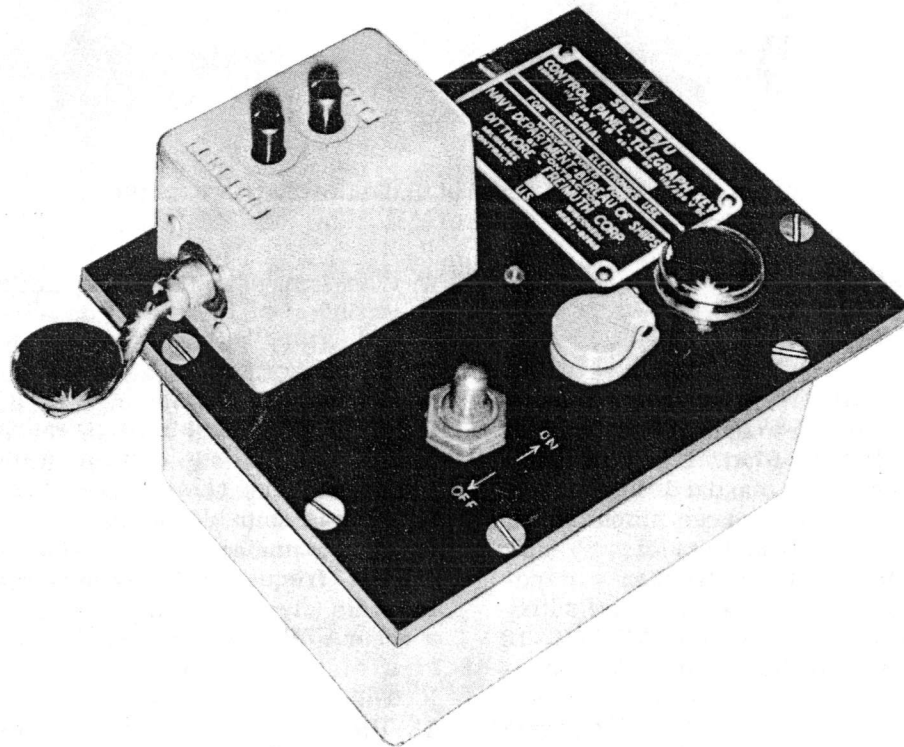

Figure 3-55.—Control Panel Telegraph Key SB-315B/U.

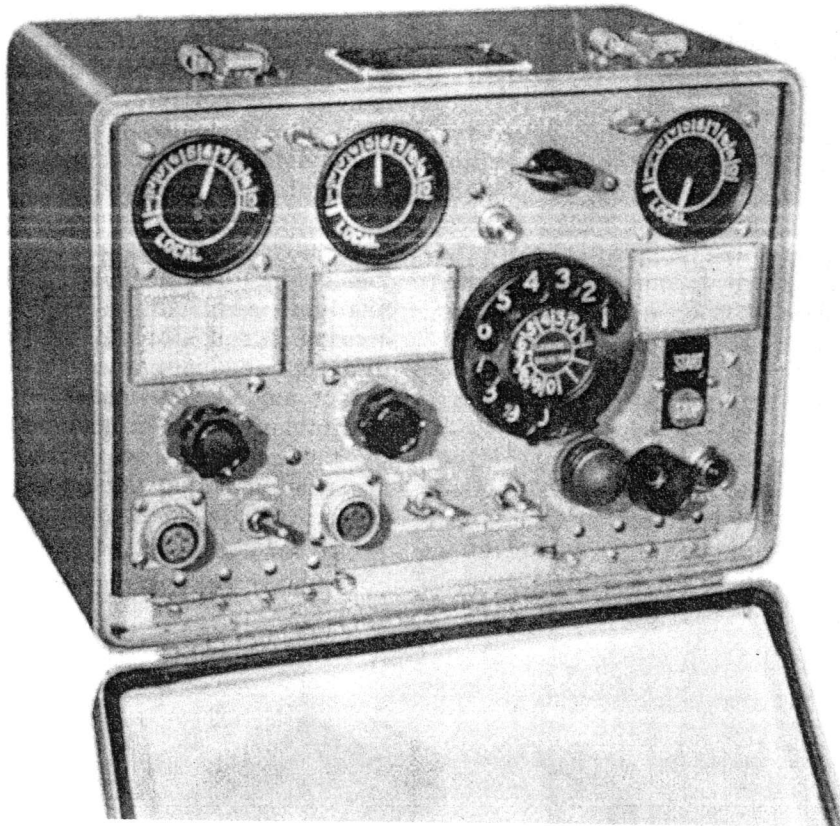

Figure 3-56.—Remote-Control/Indicator Unit NT-23496.

20.17

Frequency Standard AN/URQ-10 and  
Frequency Distribution Amplifier  
AM-2123/U

One of the latest frequency standards is the AN/URQ-10 (fig. 3-57A). This compact highly stable frequency standard is designed for continuous-duty use aboard ships and at shore facilities. It has three fixed output frequencies: 5 MHz, 1 MHz, 100 kHz.

Because it is intended as a frequency standard against which other frequency-generating equipment can be compared, the AN/URQ-10 is energized and calibrated at special calibration laboratories. Once it is placed in operation and calibrated properly, the frequency standard must not be turned off. Any interruption in its operation will cause a change in its output frequencies. Hence, the equipment

is transferred to the using activity while still operating.

A battery, which is built into the equipment, maintains operation during the time the frequency standard is in transit. It also supplies power to the unit in the event of power failure aboard ship. When fully charged, the battery is capable of operating the equipment for approximately 6 hours.

The frequency distribution amplifier AM-2123/U (fig. 3-57B) is designed to provide a means of distributing the precision frequencies of a frequency standard to many remote locations aboard ship.

The three frequency channels from the AN/URQ-10 are accepted by the AM-2123/U which can provide 12 channels of output frequencies in any combination of the three input frequencies (5 MHz, 1 MHz, 100 kHz).

ch:

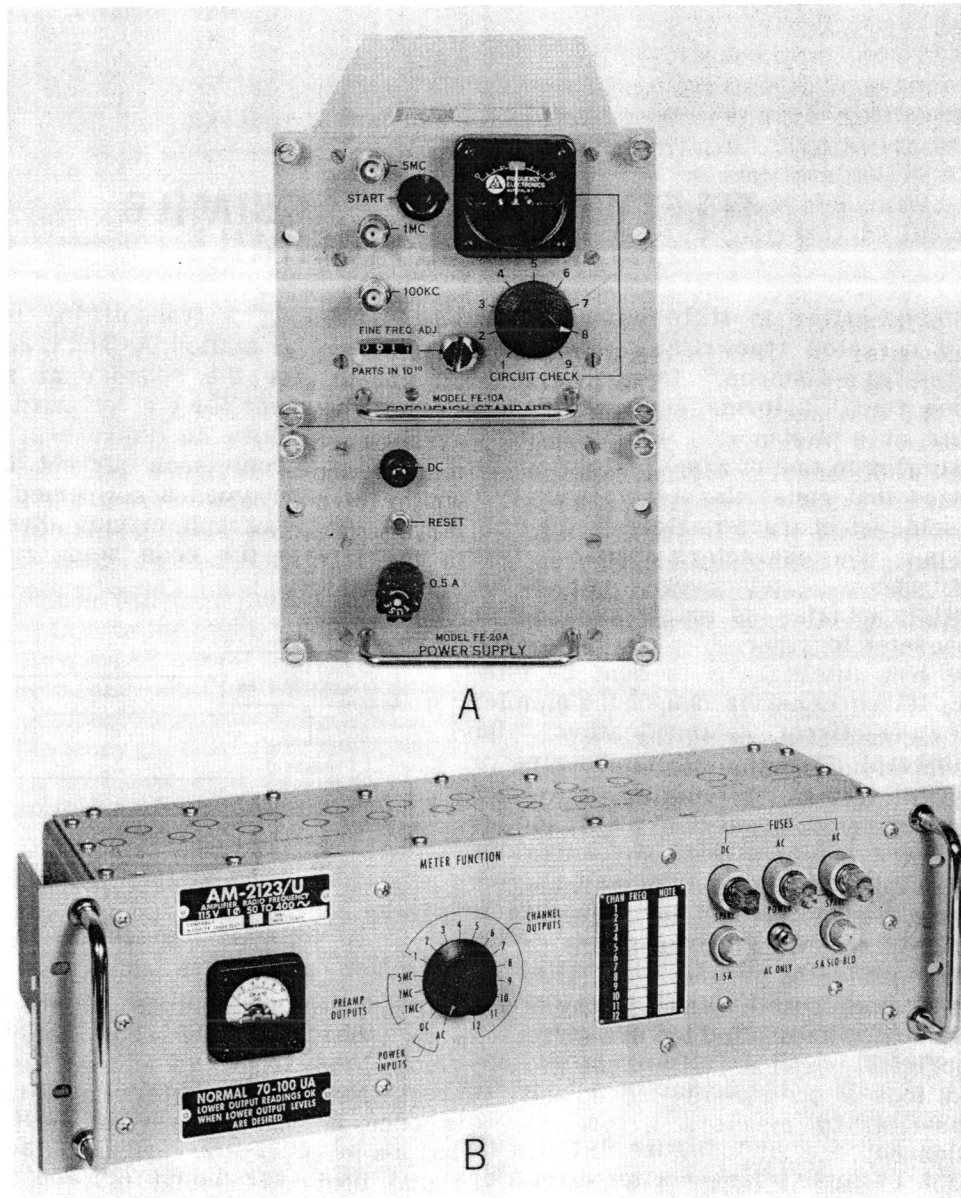

Figure 3-57.—Frequency Standard equipment.

120.77

ADDITIONAL RADIO EQUIPMENT

The radio equipments described in this chapter have been mostly of the general-

purpose communication type. Additional and more specialized types of radio equipment are discussed in the next chapter.