

*

NAVSHIPS 900,121(A)

SHIPBOARD ANTENNA DETAILS

CHAPTER 6

ANTENNA SYSTEMS

BUREAU OF SHIPS

NAVY DEPARTMENT

*

Page Numbers	Change in Effect	Page Numbers	Change in Effect
Title Page	Original	6-1 to	
A Page	Original	6-170	Original
i Page	Original	i-1 to i-2	Original

TABLE OF CONTENTS

SECTION 6-1
INTRODUCTION

Paragraph	Page
1. Purpose.....	6-1
2. Arrangement.....	6-1
3. Classification.....	6-1

SECTION 6-2

SHIPBOARD ANTENNA SYSTEMS.....	6-3
--------------------------------	-----

SECTION 6-3

SUBMARINE ANTENNA SYSTEMS.....	6-137
--------------------------------	-------

SECTION 6-1

INTRODUCTION

1. PURPOSE

The purpose of these "Antenna Systems" is to supply a convenient and summarized reference of typical antenna systems that are now being used with various equipments.

The systems deal mainly with the type of antenna, RF cable or waveguide, and connectors that are used in installations. When more complete **information** is desired, it will be necessary to consult instruction books, drawings or specifications listed in the accompanying bills of materials.

2. ARRANGEMENT.

This chapter has been arranged so that corrected pages or new pages may be added from time to time. The antenna systems are divided into two groups; one group for surface craft installations and one group for submarine installations. In each group the pages are arranged alphabetically according to AN nomenclature and model letters. When a new system is added insert it in its proper **alphabetical** place.

3. CLASSIFICATION.

This entire chapter is UNCLASSIFIED.

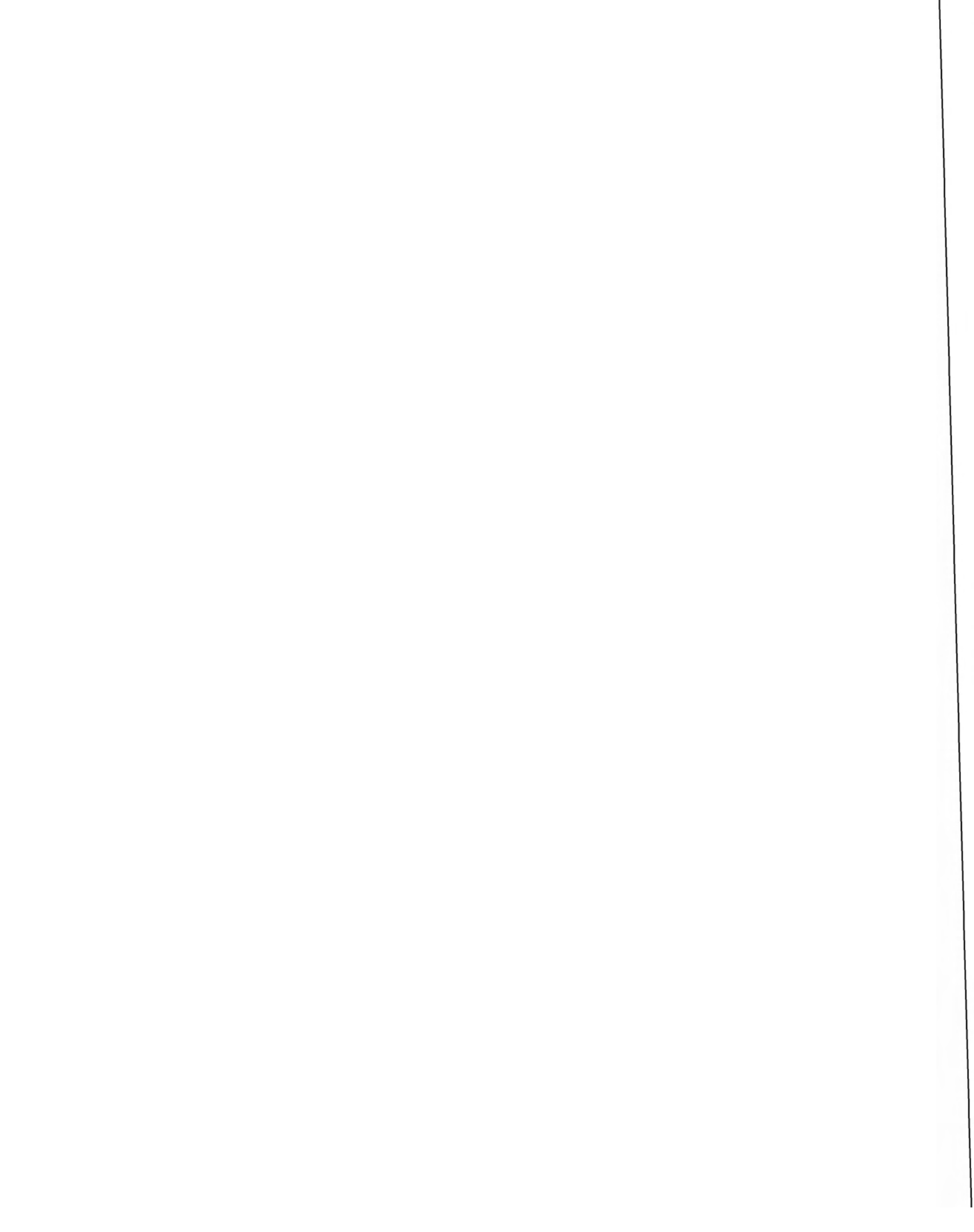

**SECTION 6-2
SHIPBOARD ANTENNA SYSTEMS**

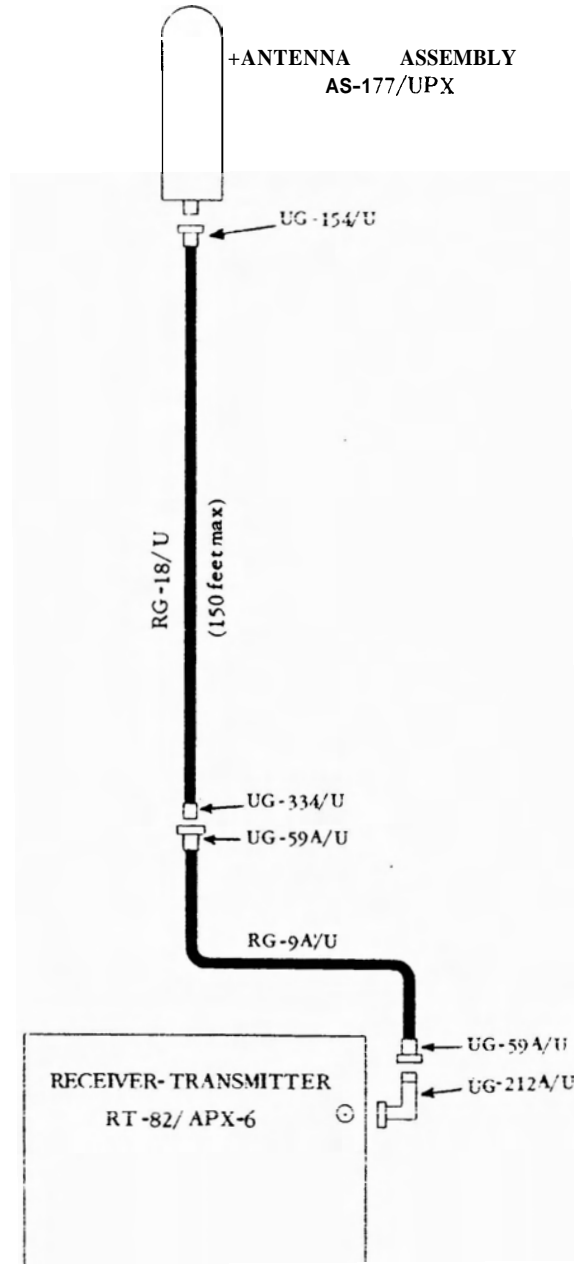

TYPICAL SHIPBOARD ANTENNA SYSTEM FOR RADAR SET AN/APX-6

BILL OF MATERIALS

Name	Type	No. Req'd	Standard Navy Stock Number	Instruction Book, Specification or Drawing
Receiver - Transmitter	RT-82/APX-6	1		
Antenna Assembly	AS-177/UPX	1	F16-A-51930-2101	NavShips 91597
R F Cable	RG-9A/U		G15-C-12200-525	JAN-C-17A
R F Cable	RG-18/U		G15-C-12200-750	JAN-C-17A
Connector, plug	UG-154/U	1	17-C-71422-3137	RE 49F 284L
Connector, jack	UG-334/U	1	17-C-73115-8769	RE 49F 447A
Connector, plug	UG-59A/U	2	17-C-71418-8250	RE 49F 225G
Connector, adapter	UG-212A/U	1	17-C-674448652	RE 49F 349E

June 30, 1954

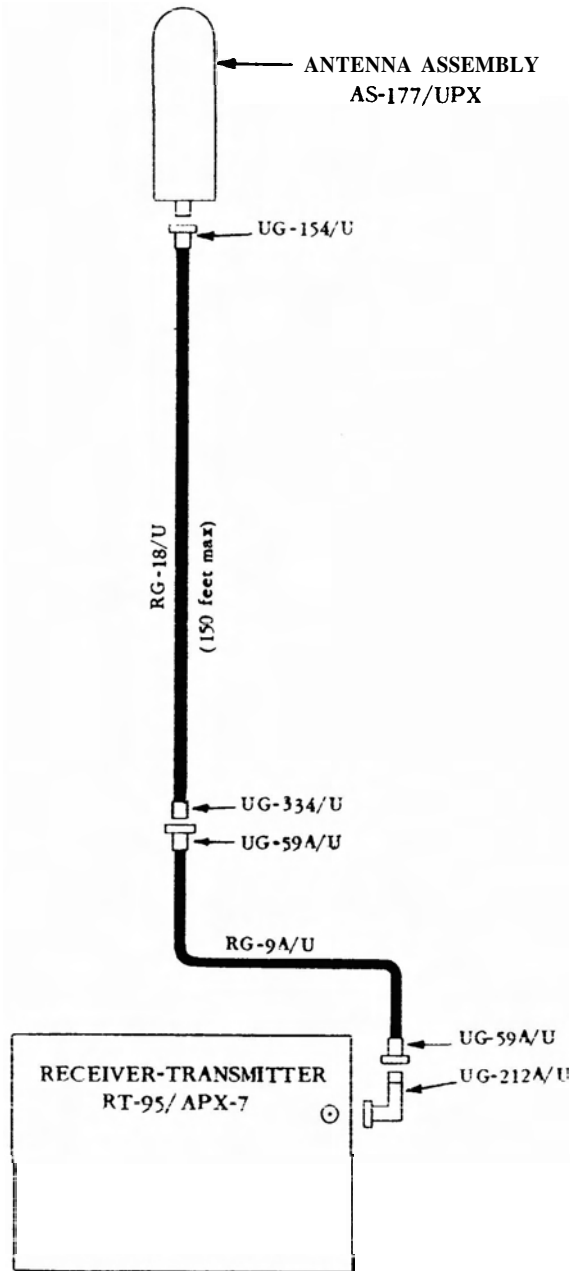

TYPICAL SHIPBOARD ANTENNA SYSTEM FOR RADIO SET AN/APX-7

BILL OF MATERIALS

Name	Type	No. Req'd	Standard Navy Stock Number	Instruction Book, Specification or Drawing
Receiver - Transmitter	RT-95/APX-7	1		NavShips 91001
Antenna Assembly	AS-177/UPX	1	F16-A-51930-2101	NavShips 91597
RF Cable	RG-9A/U		G15-C-12200-525	JAN-C-17A
RF Cable	RG-18/U		G15-C-12200-750	JAN-C-17A
Connector, plug	UG-154/U	1	17-C-71422-3137	RE 49F 284L
Connector, jack	UG-334/U	1	17-C-73115-8769	RE 49F 447A
Connector, plug	UG-59A/U	2	17-C-71418-8250	RE 49F 225G
Connector, adapter	UG-212A/U	1	17-c -67444-8652	RE 49F 349E

June 30, 1954

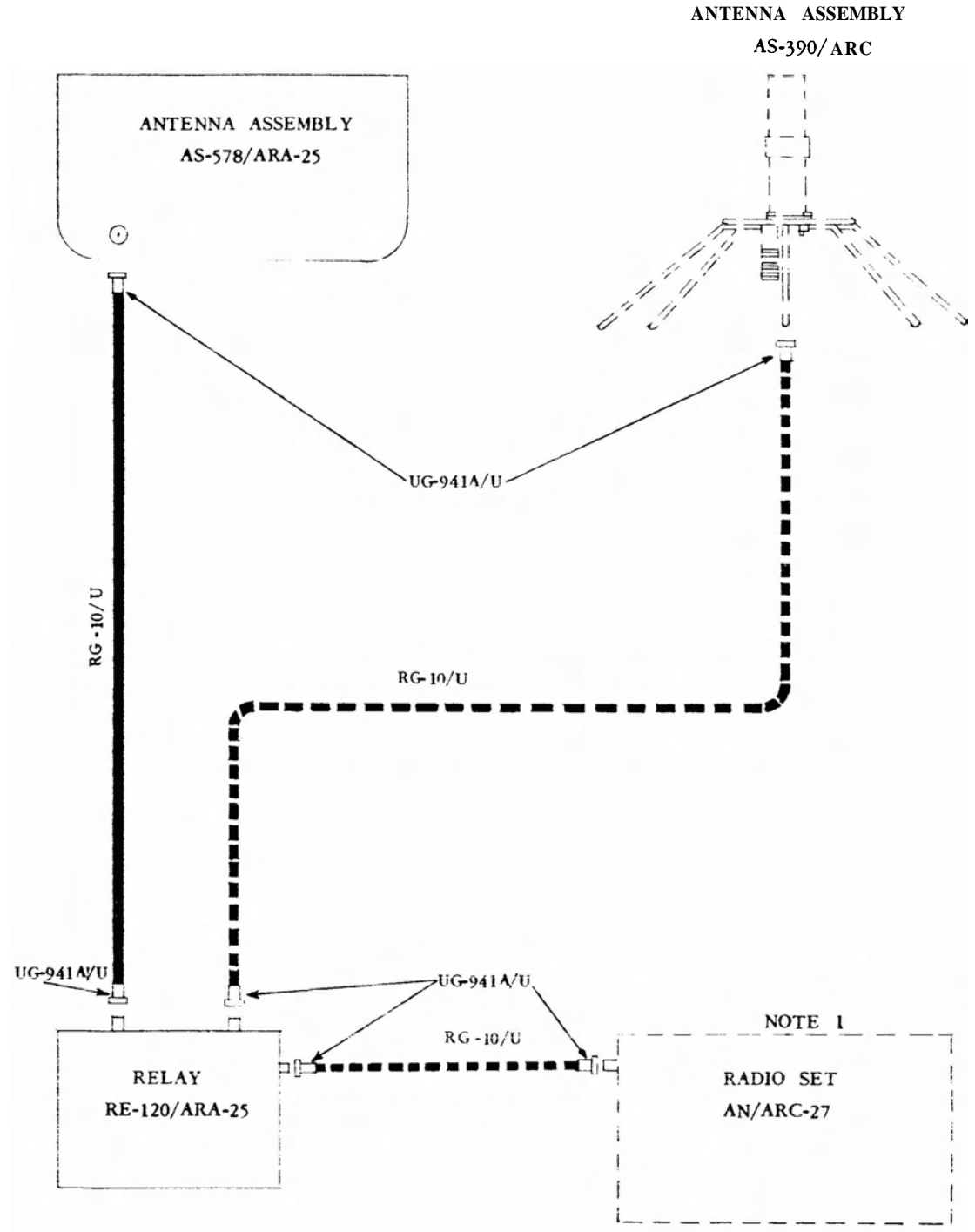

TYPICAL SHIPBOARD ANTENNA SYSTEM FOR DIRECTION FINDER AN/ARA-25

BILL OF MATERIALS

Name	Type	No. Req'd	Standard Navy Stock Number	Instruction Book, Specification or Drawing
Antenna Assembly	AS-578/ARA-25	1		AN16-30ARA25-1
Relay	RE-120/ARA-25	1		AN16-30ARA25-I
RF Cable	RG-10/U		G15-C-12200-625	JAN-C-17A
Connector, plug*	UG-941A/U			RE 49D 215

* Consists of UG-21D/U Connector plus Armor Clamp, MX-1286/U..

NOTES

1. Direction Finder Group AN/ARA-25 is used in conjunction with Radio Set AN/ARC-27 and its associated antenna.

June 30, 1954

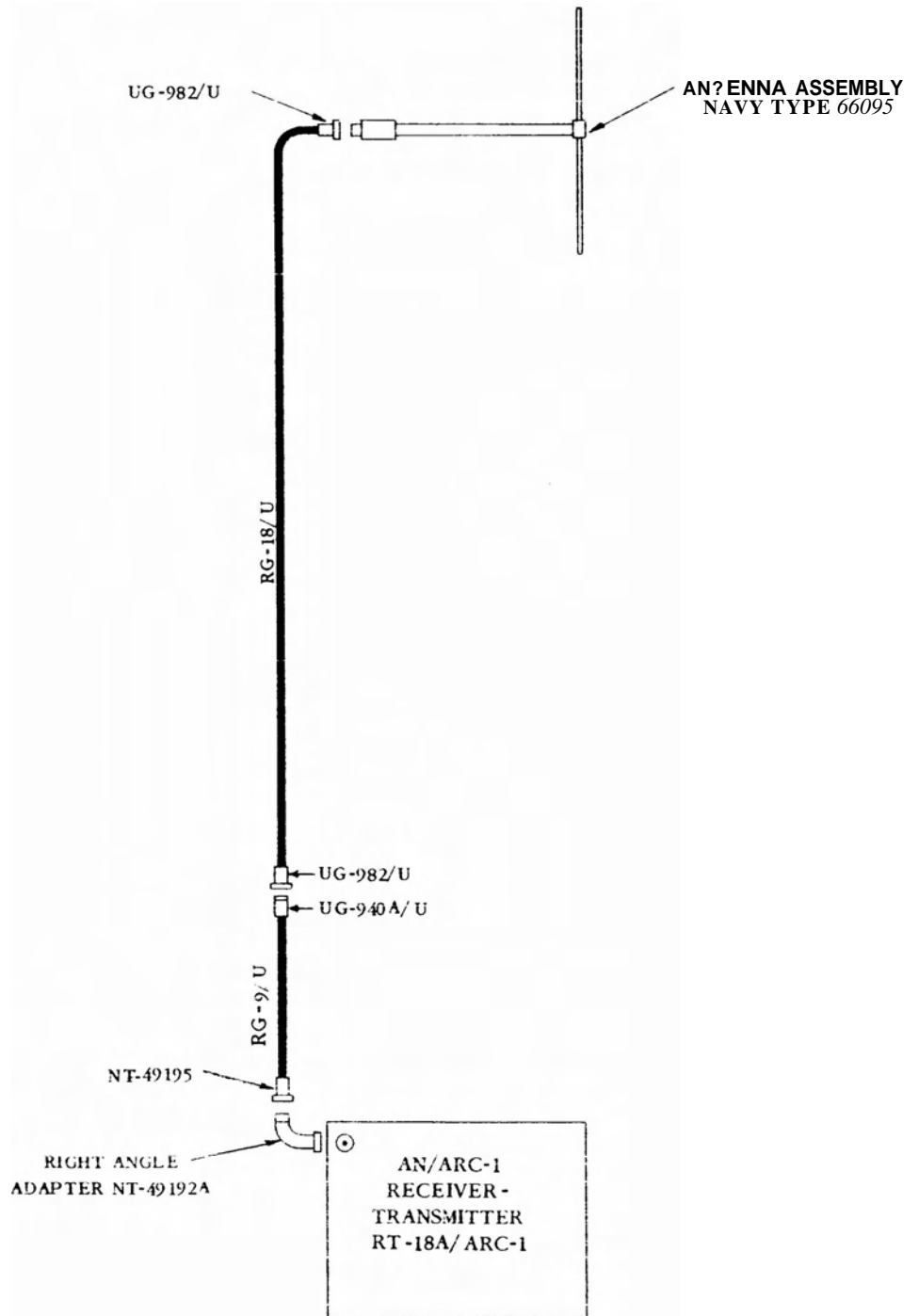

TYPICAL SHIPBOARD ANTENNA SYSTEM FOR AN/ARC-1 RADIO EQUIPMENT

BILL OF MATERIALS

Name	Type	No. Req'd	Standard Navy Stock Number	Instruction Book, Specification or Drawing
AN/ARC-1 Receiver - Transmitter	RT-18A/ARC-1	1		NavShips 98215
Antenna Assembly	66095	1	F16-A-48586-5351	NavShips 900,474
RF Cable	RG-9/U		G15-C-12200-500	JAN-C-17A
RF Cable	RG-18/U		G15-C-12200-750	JAN-C-17A
Connector, adapter	49192A	1	17-C-674441300	RE 49F 168
Connector, plug	49195	1	17-C-71414-2800	RE 49F 167
Connector, jack*	UG-940A/U	1		
Connector, plug**	UG-982/U	2		RE 49D 215

* Consists of UG-23D/U Connector with Armor Clamp, MX-564A/U.

** Consists of UG-167D/U Connector with Armor Clamp, MX-1441/U.

May 31, 1954

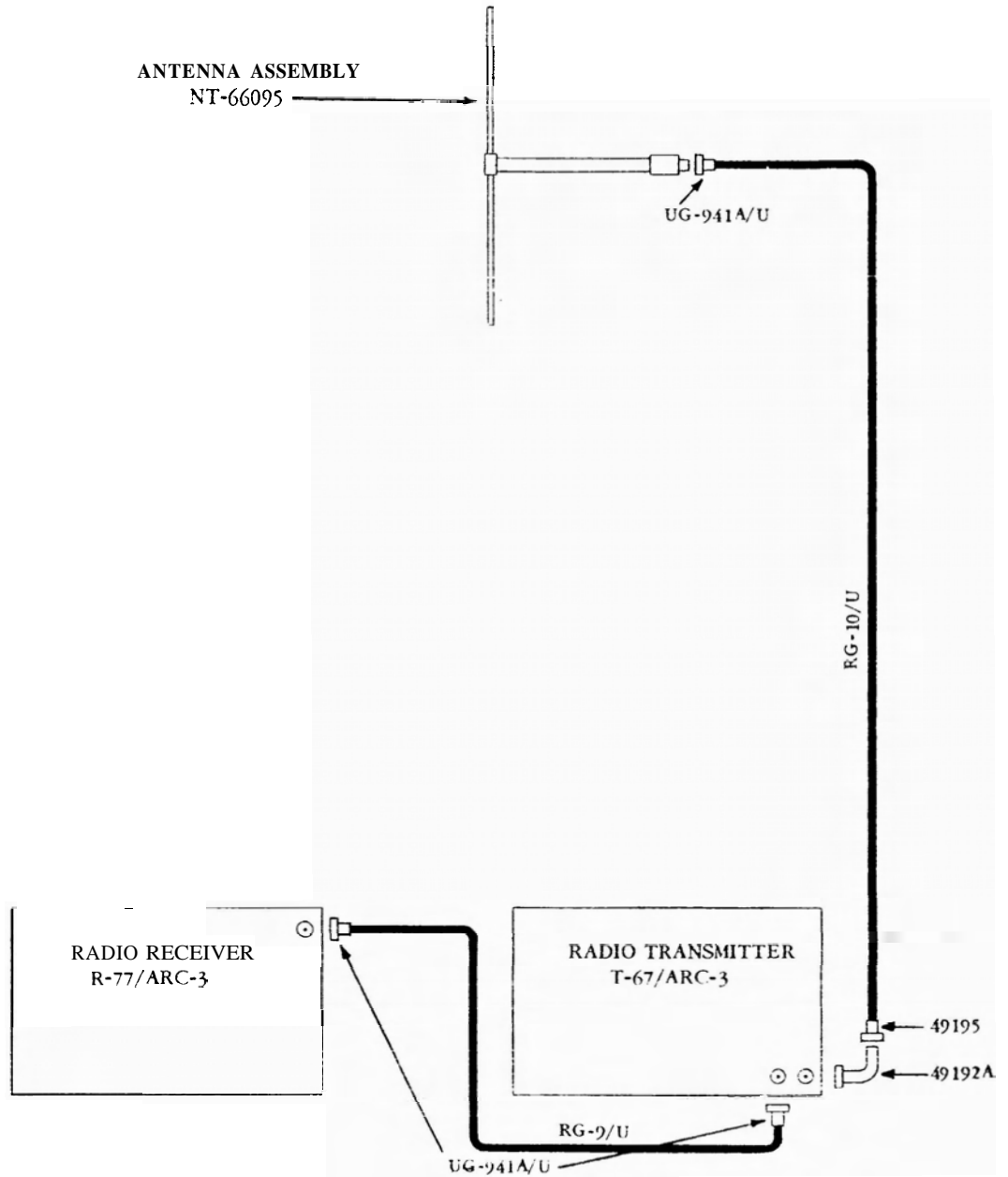

TYPICAL SHIPBOARD ANTENNA SYSTEM FOR RADIO SET AN/ARC-3

BILL OF MATERIALS

Name	Type	No. Req'd	Standard Navy Stock Number	Instruction Book Specification or Drawing
AN/ARC-3 Receiver	R-77/ARC-3	1		AN 16-30 ARC-3
AN/ARC-3 Transmitter	T-67/ARC-3	1		AN 16-30 ARC-3
Antenna Assembly	NT-66095	1	F16-A-48586-5351	NavShips 900,474
R F Cable	RG-9/U		G15-C-12200-500	JAN-C-17A
R F Cable	RG-10/U		G15-C-12200-625	JAN-C-17A
Connector, Plug*	UG-941A/U	1		
Connector, Plug	49195	1	17-C-71414-2800	RE 49F 167
Right Angle Adapter	49192A	1	17-C-67444-1300	RE 49F 168

* Consists of UG-21D/U Connector, plus Armor Clamp MX-1286/U.

June 30, 1954

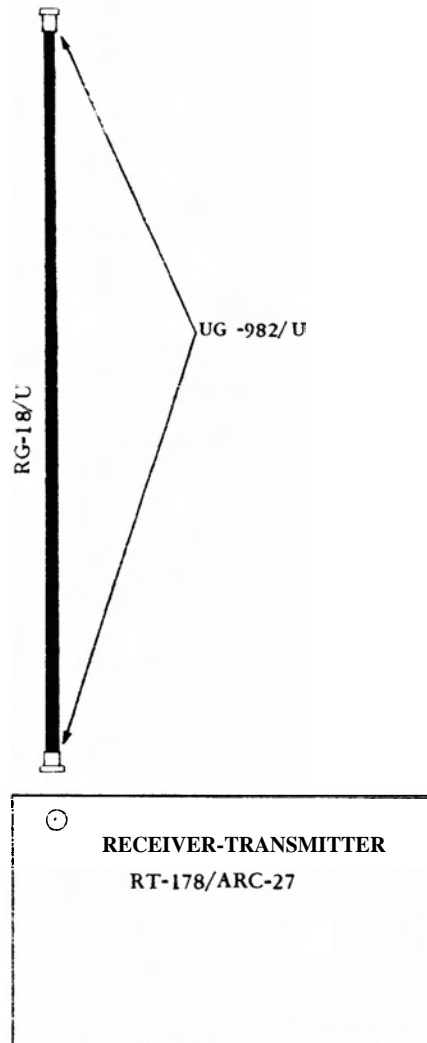
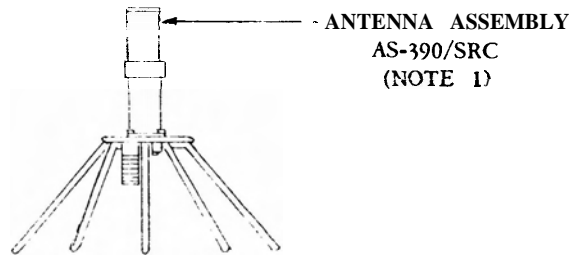

TYPICAL SHIPBOARD ANTENNA SYSTEM FOR AN/ARC-27 RADIO SET

BILL OF MATERIALS

Name	Type	No. Req'd	Standard Navy Stock Number	Instruction Book, Specification or Drawing
Receiver-Trans. AN/ARC-27	RT-178/ARC-27			AN16-30ARC27-3
Antenna Assembly	AS-390/SRC	1	F16-A-53590-1001	NavShips 91338
RF Cable	RG-18/U		G15-C-12200-750	JAN-C-17A
Connector, plug*	UG-982/U	2		RE 49D 215

* Consists of UG-167D/U Connector plus Armor Clamp, MX-1441/U.

NOTES

1. Antenna AT-150/SRC can also be used with Receiver-Transmitter RT-178/ARC-27.

June 30, 1954

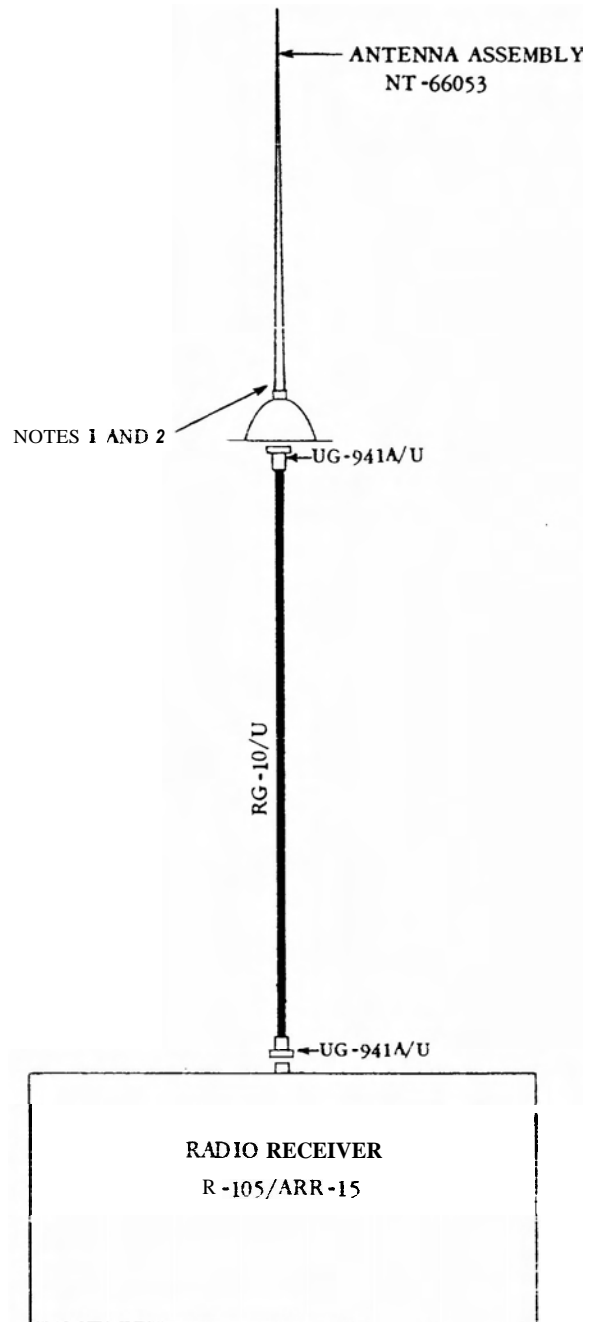

TYPICAL SHIPBOARD ANTENNA SYSTEM FOR RADIO SET AN/ARR-15

BILL OF MATERIALS

Name	Type	No. Req'd	Standard Navy Stock Number	Instruction Book, Specification or Drawing
AN/ARR-15 Receiver	R-105/ARR-15			AN16-30ARR15-3
Antenna	66046 or		N16-A-54370-1150	RE 66F 499
	66053		F16-A-54370-1075	RE 100F 181 or RE 66F 392
Antenna (Wire)	7-#18 Phos Brz		N16-W-3740-1	MIL-W-17211

NOTES

- Whip Antenna 66046 or 66053 or 7-#18 phosphor bronze wire antenna may be used with Receiver R-105/ARR-15.
- Radio Receiver R-105/ARR-15 can also be connected to the Antenna Relay of the associated Transmitter.

June 30, 1954

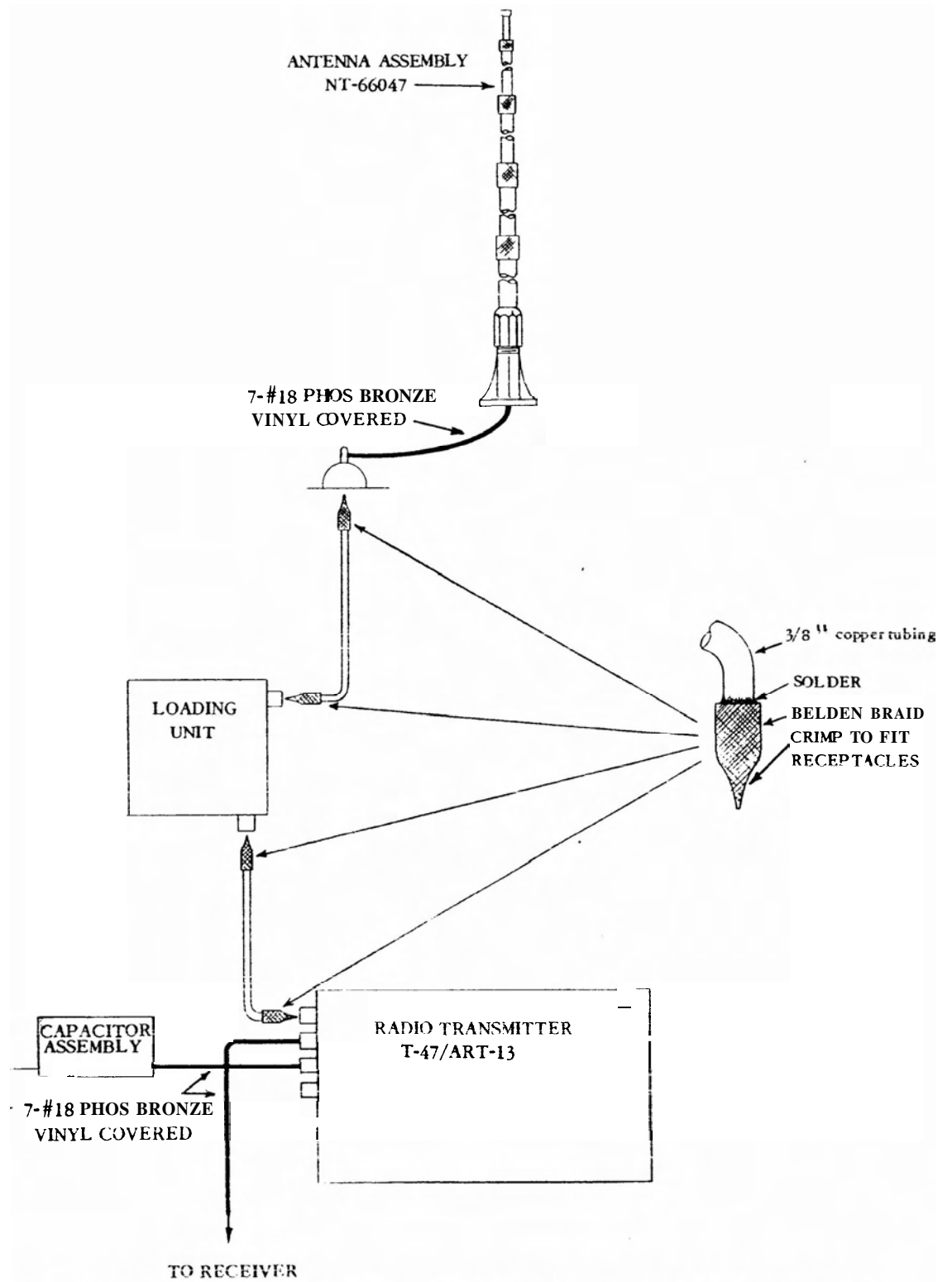

TYPICAL SHIPBOARD ANTENNA SYSTEM FOR RADIO SET AN/ART-13

BILL OF MATERIALS

Name	Type	No. Req'd	Standard Navy Stock Number	Instruction Book, Specification or Drawing
Radio Transmitter	T-47/ART-13	1		AN 08-30ART 13-5
Loading Unit		1		AN 08-30 ART 13-5
Capacitor Assembly		1		AN 08-30 ART 13-5
Antenna Assembly	66047	1	N16-A-54370-1250	RE 66F 499
Wire Rope	7 #18 Phos Bronze		N16-W-3740-1	MIL-W-17211
3/8" Copper Tubing				
Belden Braid				

June 30, 1954

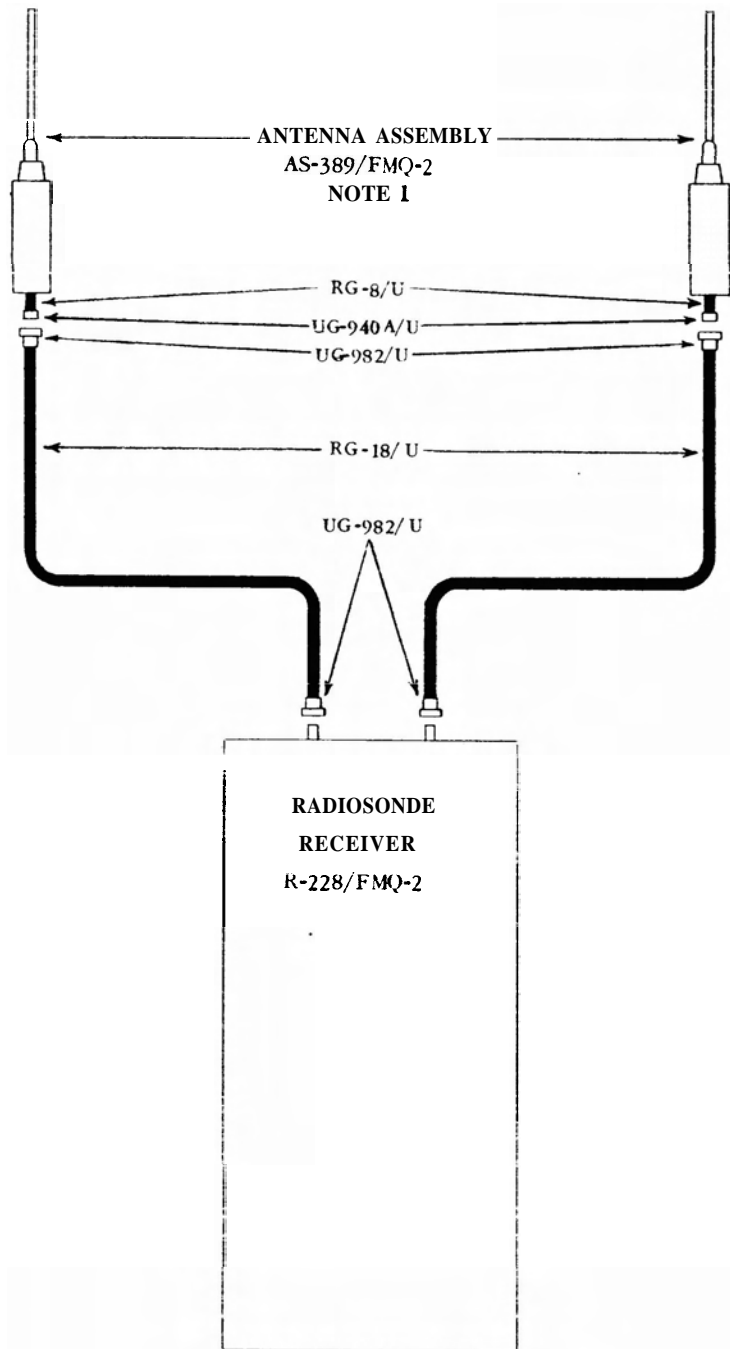

TYPICAL SHIPBOARD ANTENNA SYSTEM FOR RADIOSONDE RECEIVER AN/FMQ-2

BILL OF MATERIALS

Name	Type	No. Req'd	Standard Navy Stock Number	Instruction Book, Specification or Drawing
AN/FMQ-2 Radio_sonde Receiver	R-228/FMQ-2	1	F16-R-32616-5501	NavShips 91266(A)
Antenna Assembly	AS-389/FMQ-2	2	F16-A-45196-1811	NavShips 91266(A)
RF Cable	RG-8/U		15-C-12200-600	JAN-C-17A
RF Cable	RG-18/U		G15-C-12200-750	JAN-C-17A
Connector, jack*	UG-940A/U	2		
Connector, plug**	UG-982/U	4		RE 49D 215

- * Consists of UG-22D/U connector with Armor Clamp, MX-564A/U
 ** Consists of UG-167D/U Connector with Armor Clamp, MX-1441/U

NOTES

- One antenna is mounted on port side and one on starboard side. Each should cover as great a portion of 360° as possible.

June 30, 1954

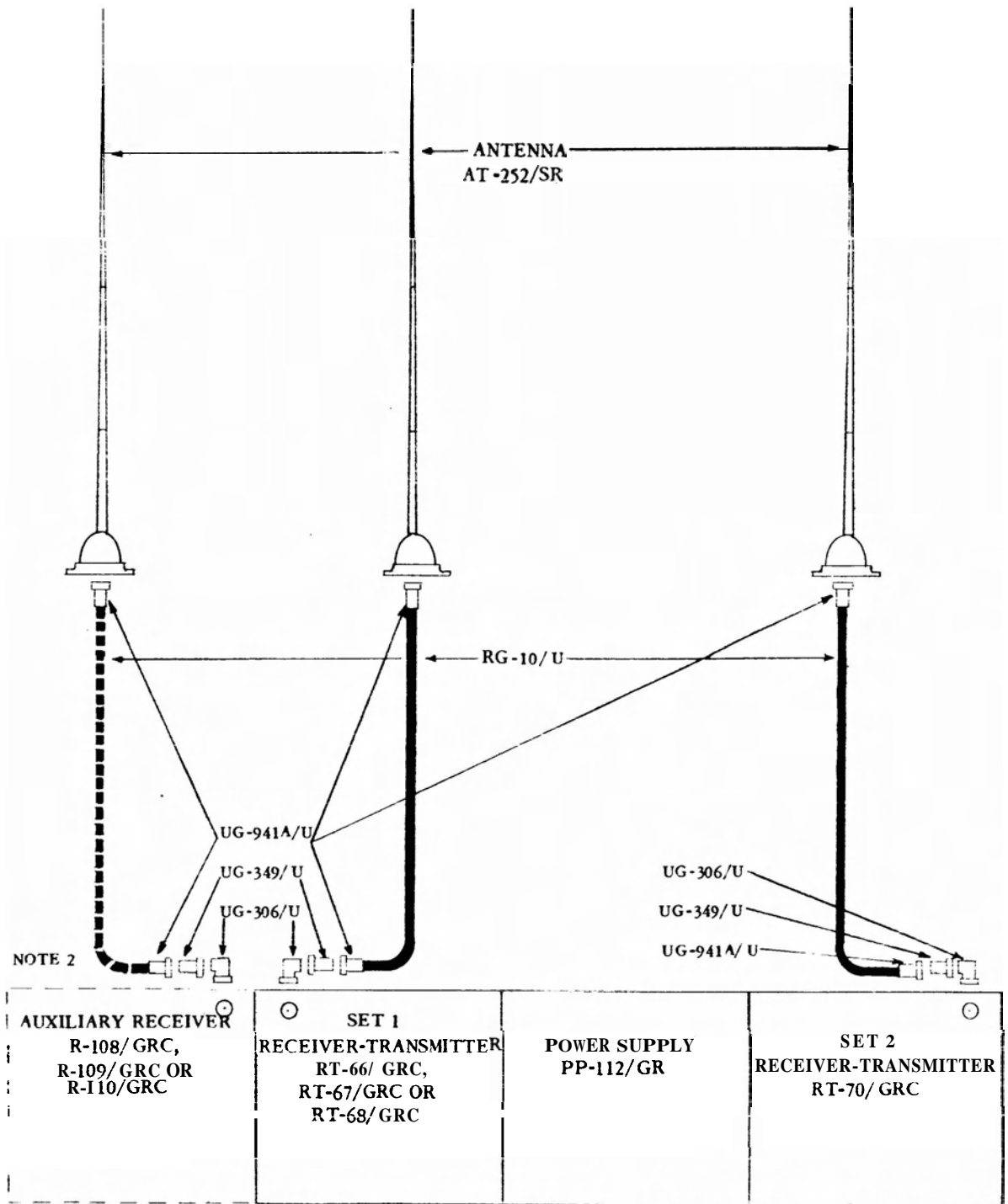

TYPICAL SHIPBOARD ANTENNA SYSTEM FOR RADIO SETS AN/GRC-3 THROUGH -8

BILL OF MATERIALS

Name	Type	No. Req'd	Standard Navy Stock Number	Instruction Book, Specification or Drawing
Radio Equipment AN/GRC-3 thru 8				TM11-284
Antenna AN/SRA-3	AT-252/SR		N16-A-54463-5150	NavShips 91292
RF Cable	RG-10/U		G15-C-12200-625	JAN-C-17A
Connector, plug*	UG-941A/U			

* Consists of **UG-21D/U** Connector plus Armor Clamp, **MX-1286/U**

NOTES

1. For **AN/GRC-3** and 4 use full length of **AT-252/SR (125")**. For **AN/GRC-5** and 6 cut **AT-252/SR** to **89"** in length. For **AN/GRC-7** and 8 cut **AT-252/SR** to **58"** in length.
2. A third Antenna **AT-252/SR** is required for Radio Sets **AN/GRC-3, 5, 7** if auxiliary Receivers **R-108/GRC, R-109/GRC,** or **R-110/GRC** are used with these sets respectively.

June 30, 1954

ANTENNA ASSEMBLY
NT-66053, 66046, 66047

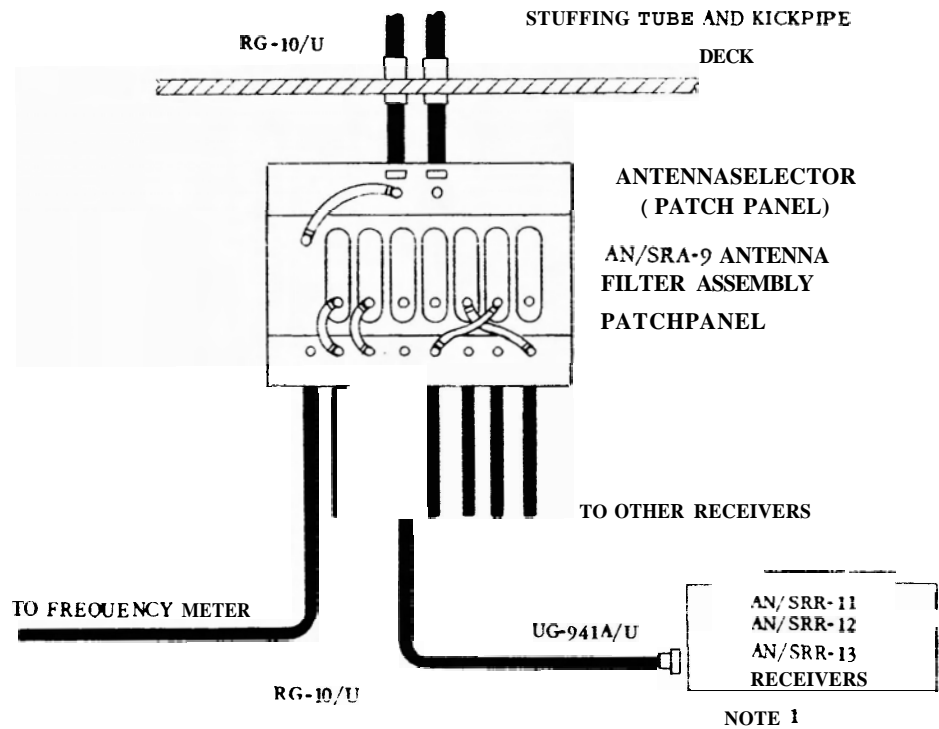
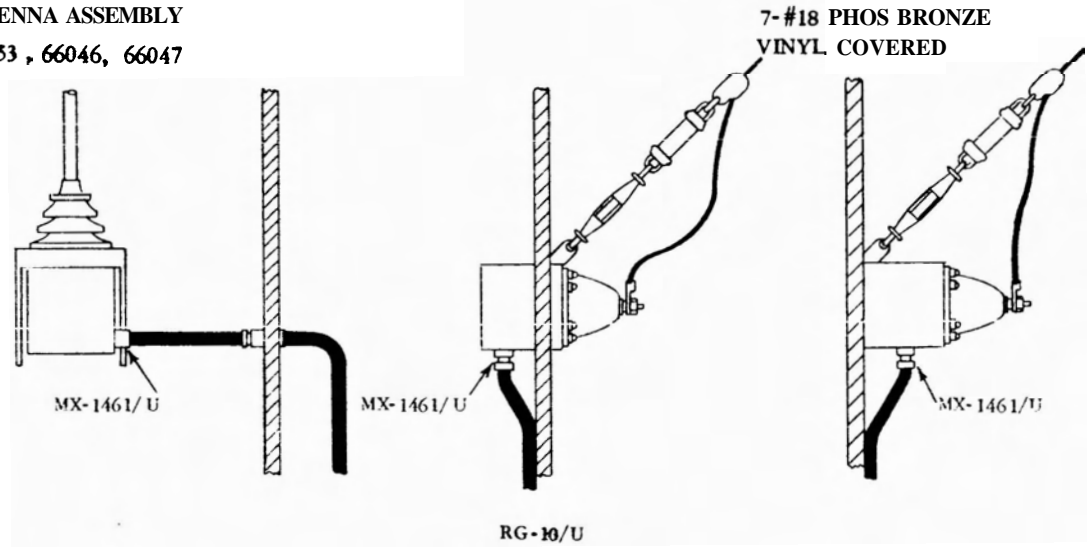

TYPICAL SHIPBOARD ANTENNA SYSTEMS FOR RECEIVERS USING AN/SRA-9 FILTER

BILL OF MATERIALS

Name	Type	No. Req'd	Standard Navy Stock Number	Instruction Book, Specification or Drawing
Antenna Filter Assembly	AN/SRA-9	1		NavShips 91770
Antenna Selector Patch Panel		1		
Patch Panel		1		
Antenna Assembly	66053, 66046 or 66047	1	N16-A-54370-1075 N16-A-54370-1150 N16-A-54370-1250	RE 66F 449 RE 66F 392
Wire Antenna	7-#18 Phos Bronze	2	N16-W-3740-1	MIL-W-17211
RF Cable	RG-10/U		G15-C-12200-625	JAN-C-17A
Connector, plug*	UG-941A/U			

* Consists of **UG-21D/U** Connector plus Armor Clamp **MX-1286/U**.

NOTES

1. Any receivers, such as the RBA, RBB, RBC, which are in the frequency range of the filter may be used with the **AN/SRA-9** Filter Assembly.

June 30, 1954

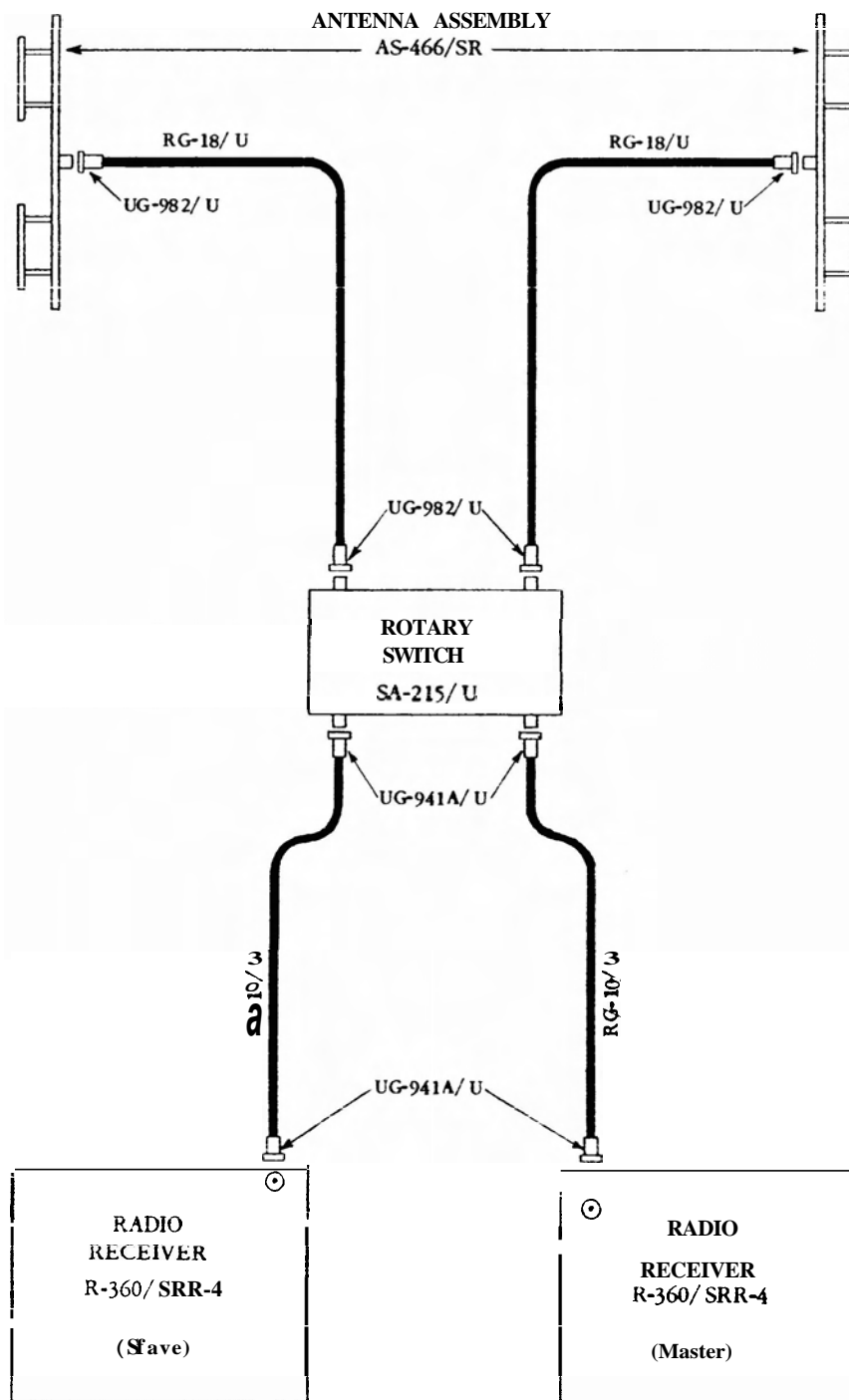

TYPICAL SHIPBOARD ANTENNA SYSTEM FOR AN/SRR-4 AEW EQUIPMENT

BILL OF MATERIALS

Name	Type	No. Req'd	Standard Navy Stock Number	Instruction Book, Specification or Drawing
Radio Receiver	R-360/SRR-4	2	F16-R-30899-7021	NavShips 91410(A)
Rotary Switch	SA-215/U	1	F17-S-60905-1001	
Antenna Assembly	AS-466/SR	2	F16-A-55157-6412	NavShips 91410(A)
R F Cable	RG-10/U		G15-C-12200-625	JAN-C-17A
R F Cable	RG-18/U		G15-C-12200-750	JAN-C-17A
Connector, plug*	UG-941A/U	4		
Connector, plug**	UG-982/U	4		RE 49D 215

* Consists of UG-21D/U Connector plus Armor Clamp, MX-1286/U.

** Consists of UG-167D/U Connector plus Armor Clamp, MX-1441/U.

June 30, 1954

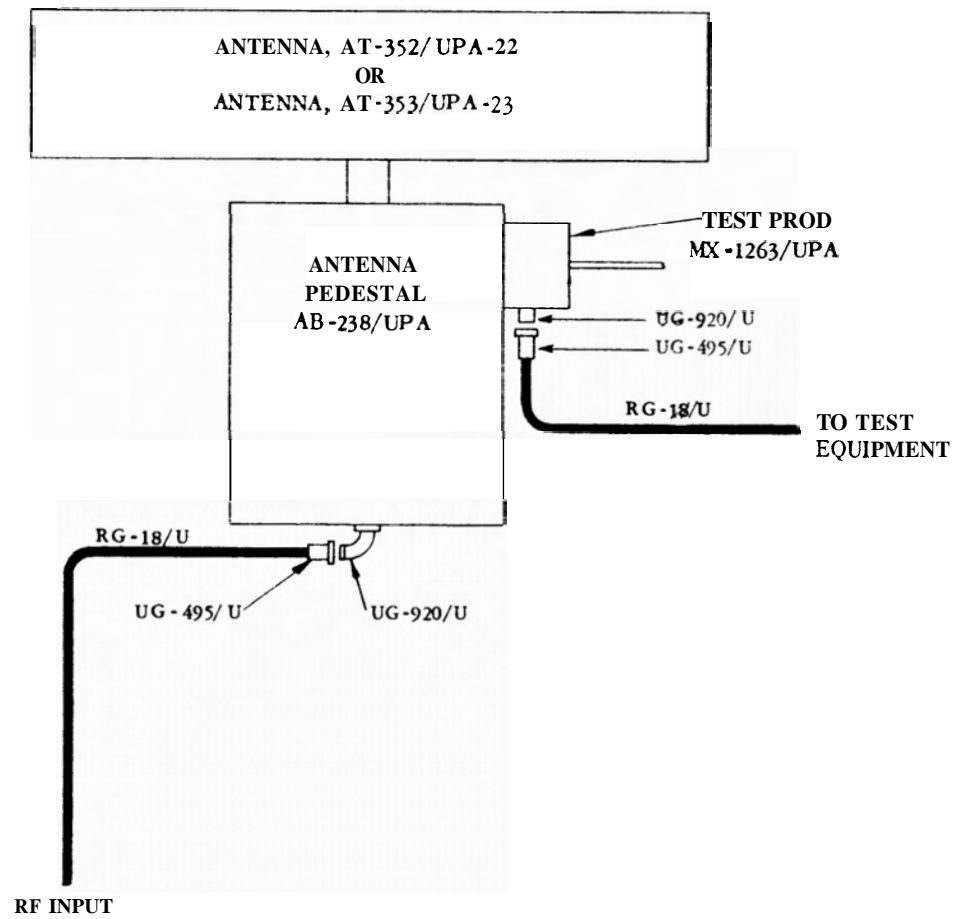

TYPE G SHIPBOARD INSTALLATION FOR ANTENNA AN/UPA-22 AND AN/UPA-23

BILL OF MATERIALS

Name	Type	No. Req'c	Standard Navy Stock Number	Instruction Book, Specification or Drawing
Antenna Pedestal	AB-238/UPA	1	F16-P-23801-1033	NavShips 91516(A)
Antenna	AT-352/UPA-22	1	F16-A-52014-6835	NavShips 91516(A)
	or AT-353/UPA-23		F16-A-52014-6825	NavShips 91516(A)
Test Prod	MX-1263/UPA	1	F16-A-53616-5551	NavShips 91516(A)
RF Cable	RG-18/U		G15-C-12200-750	JAN-C-17A
Connector, plug	UG-920/U	2		
Connector, plug	UG-495/U	2	17-C-71419-7885	RE 43F 536

June 30, 1954

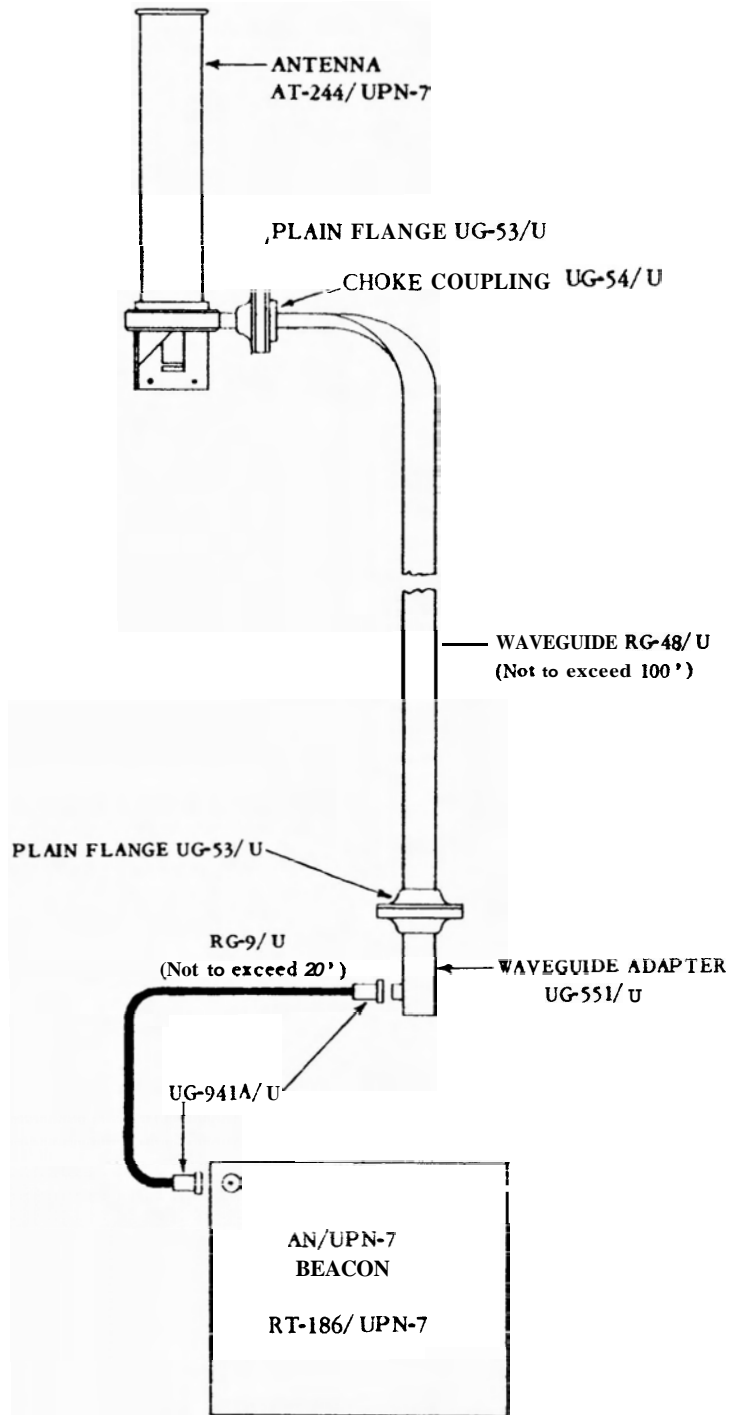

TYPICAL SHIPBOARD ANTENNA SYSTEM FOR RADAR BEACON AN/UPN-7

BILL OF MATERIALS

Name	Type	No. Req'd	Standard Navy Stock Number	Instruction Book, Specification or Drawing
Receiver-Transmitter	RT-186/UPN-7	1	F16-R-34998-3451	RE 36F 2003
Antenna	AT-244/UPN-7			
RF Cable	RG-9/U		G15-C-12200-500	JAN-C-17A
Waveguide	RG-48/U		16-W-20550-4052	JAN-W-85A
Choke Coupling	UG-54/U		N16-RC-22960-54 (ESO Stock No.)	RE 49F 204
Plain Flange	UG-53/U		16-F-659511-181	RE 49F 204
Coaxial-Waveguide Adapter	UG-551/U	1		CS-847
Connector, plug*	UG-941A/U	2		

* Consists of UG-21D/U Connector with Armor Clamp, MX-1286/U.

June 30, 1954

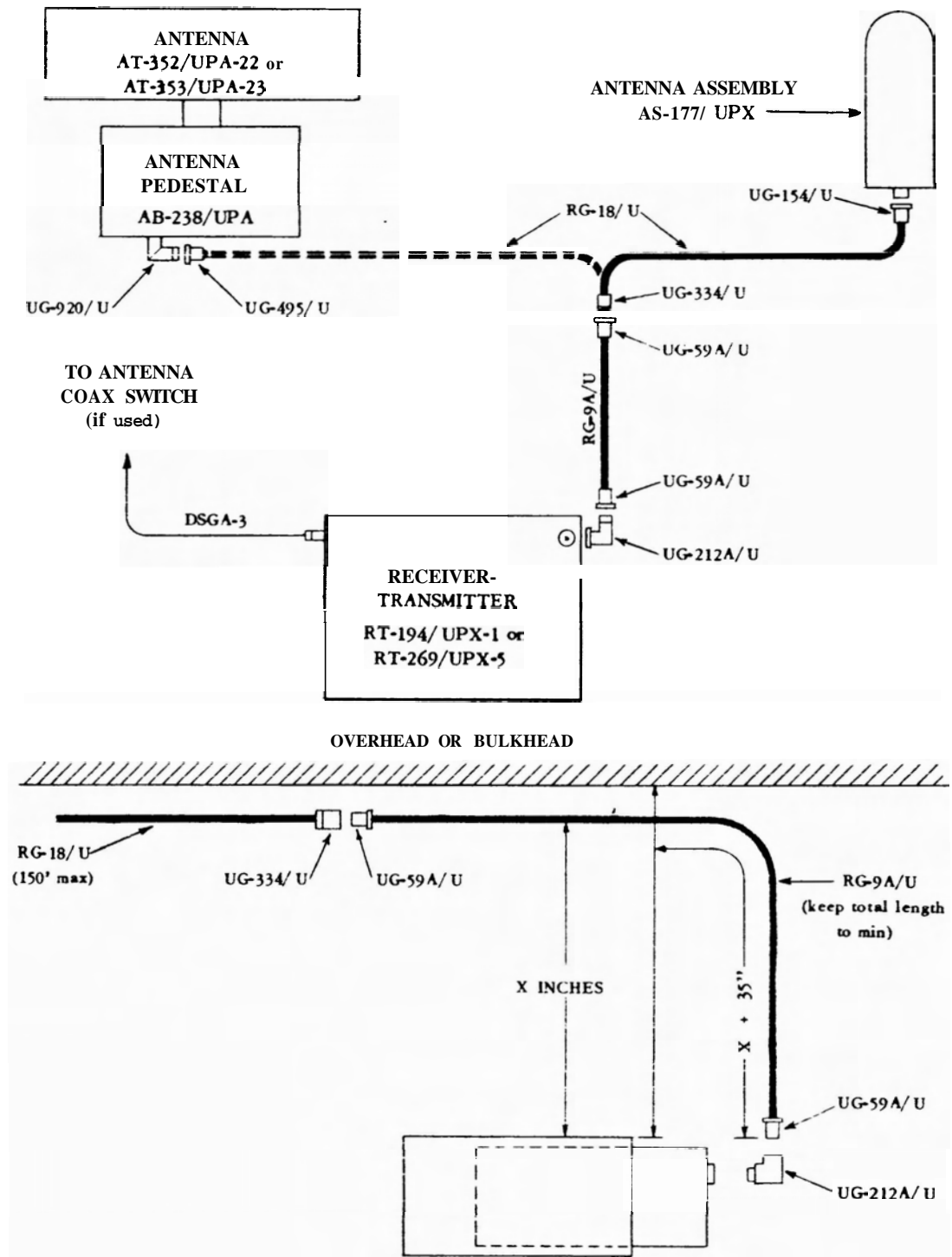

TYPICAL SHIPBOARD ANTENNA SYSTEM FOR AN/UPX-1 AN/UPX-5 EQUIPMENT

BILL OF MATERIALS

Name	Type	No. Req'd	Standard Navy Stock Number	Instruction Book, Specification, or Drawing
AN/UPX-1 or 5 Receiver-Transmitter	RT-194/UPX-1 or RT-269/UPX-5		F16-R-34973-1001	NavShips 91343
Antenna Assembly	AS-177/UPX	1	F16-A-51930-2101	NavShips 91597
Antenna	AT-352/UPA-22 or AT-353/UPA-23	1	F16-A-52014-6835	NavShips 91516(A)
			F16-A-52014-6825	NavShips 91516(A)
RF Cable	RG-9A/U		G15-C-12200-525	JAN-C-17A
RF Cable	RG-18/U		G15-C-12200-750	JAN-C-17A
Cable	DSGA-3		G15-C-10298-441	MIL-C-2194
Connector, plug	UG-59A/U		17-C-714184250	RE 49F 225G
Connector, plug	UG-154/U		17-C-71422-3137	RE 49F 284L
Connector, adapter	UG-212A/U		17-C-674444 652	RE 49F 349E
Connector, jack	UG-334/U		17-C-73115-8769	RE 49F 447A
Connector, plug	UG-495/U		17-C-71419-7885	RE 49F 536

June 30, 1954

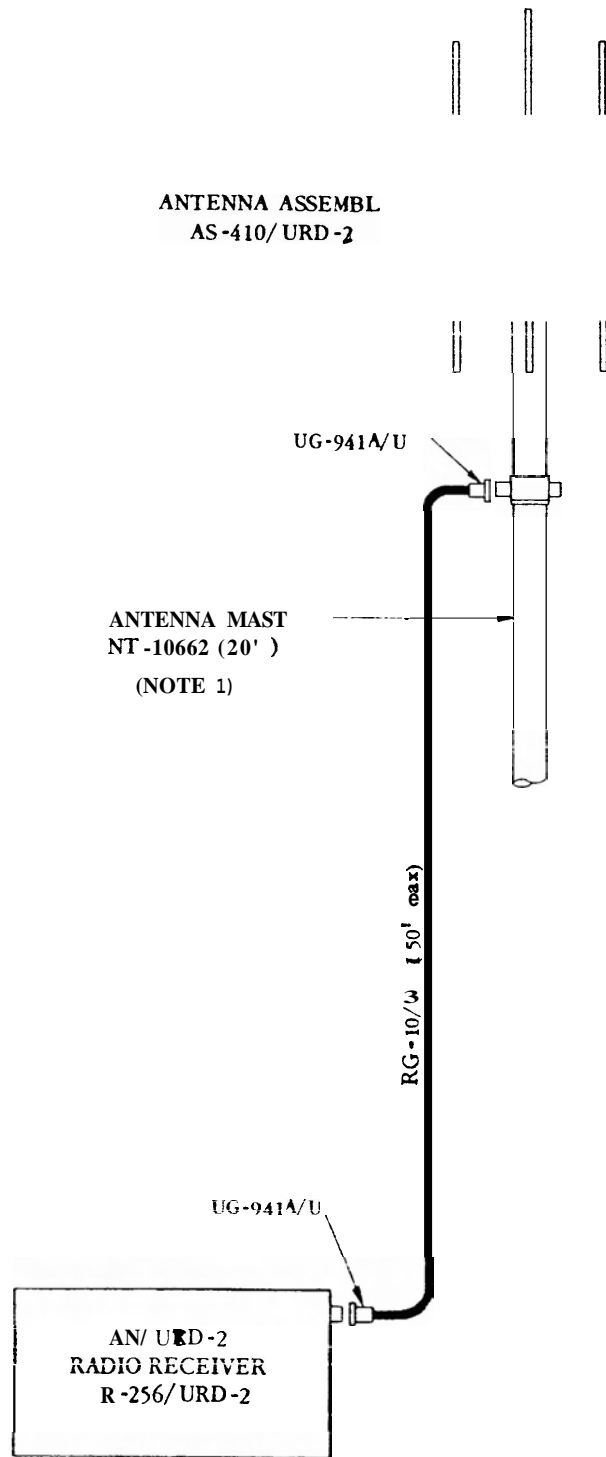

TYPICAL SHIPBOARD ANTENNA SYSTEM FOR AN/URD-2 DIRECTION FINDER

BILL OF MATERIALS

Name	Type	No. Req'd	Standard Navy Stock Number	Instruction Book, Specification or Drawing
Radio Receiver	R-256/URD-2	1	F16-R-31968-1584	NavShips 91198
Antenna Assembly	AS-410/URD-2	1	F16-A-55186-2377	NavShips 91198
Antenna Mast	10662	1	16-M-150299-875	NavShips 91198
RF Cable	RG-10/U		G15-C-12200-625	JAN-C-17A
Connector. plug*	UG-941A/U	2		

* Consists of UG-21D/U Connector with Armor Clamp MX-1286/U.

NOTES

1. It is not necessary to use Antenna Mast NT-10662.

June 30, 1954

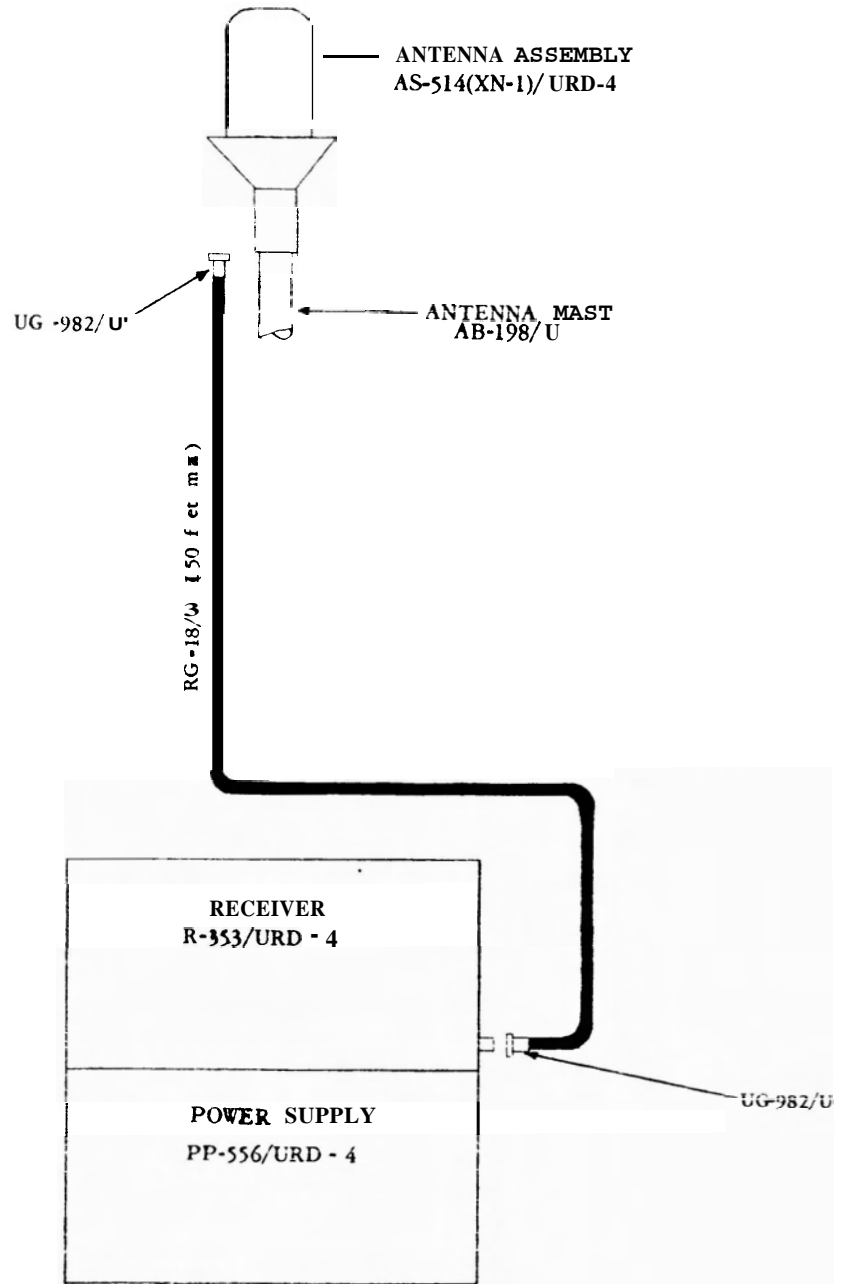

TYPICAL SHIPBOARD ANTENNA SYSTEM FOR DIRECTION FINDER AN/URD-4

BILL OF MATERIALS

Name	Type	No. Req'd	Standard Navy Stock Number	Instruction Book, Specification or Drawing
AN/URD-4 Receiver	R-353/URD-4	1	16-R-31680-9601	NavShips 91912
AN/URD-4 Power Supply	PP-556/URD-4	1		NavShips 91912
Antenna Assembly	AS-514/URD-4	1		NavShips 91912
Antenna Mast	AB-198/U	1		NavShips 91912
RF Cable	RG-18/U		G15-C-12200-750	JAN-C-17A
Connector, plug*	UG-982/U	2		RE 49D 215

* Consists of UG-167D/U Connector plus Armor Clamp, MX-1441/U.

June 30, 1954

6-38,

UNCLASSIFIED

ORIGINAL

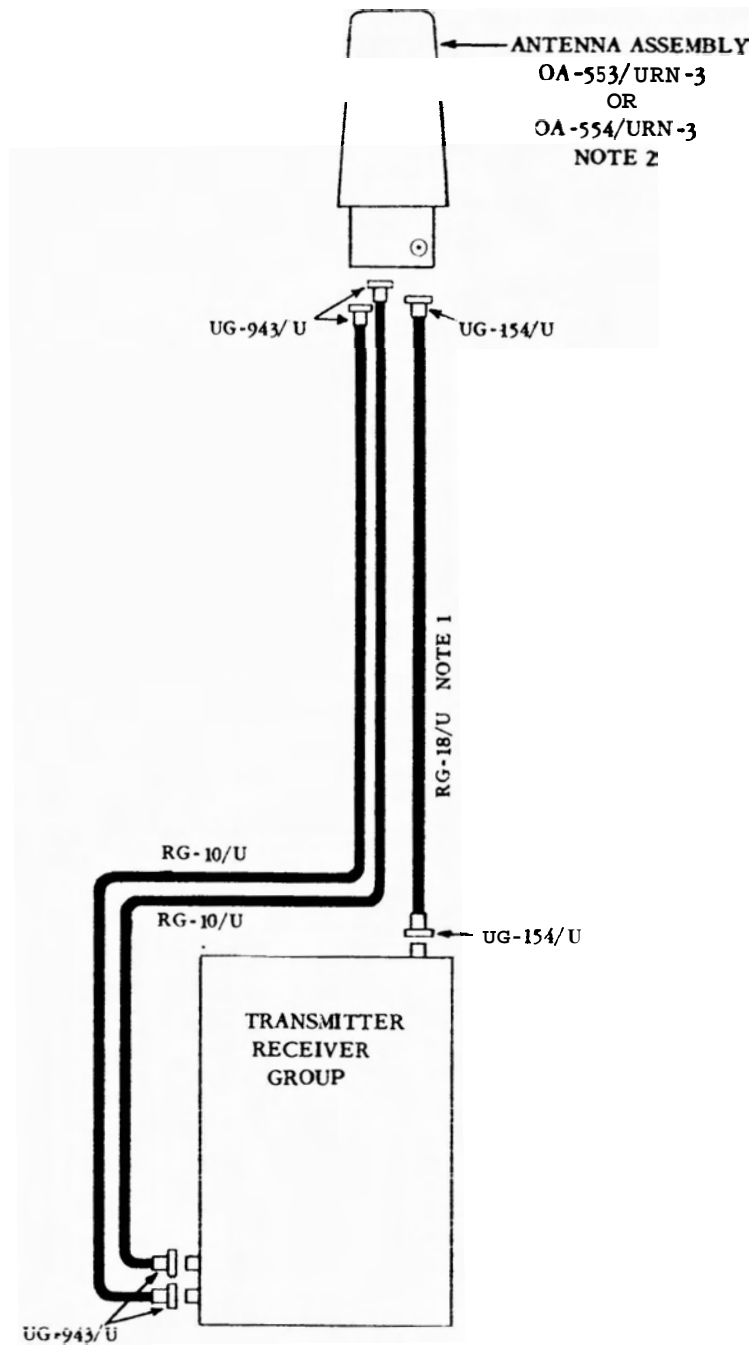

TYPICAL SHIPBOARD ANTENNA SYSTEM FOR RADIO NAVIGATION SET AN/URN-3

BILL OF MATERIALS

Name	Type	No. Req'd	Standard Navy Stock Number	Instruction Book, Specification or Drawing
Transmitter Receiver Group	AN/URN-3	1		NavShips 91599
Antenna Assembly	OA-553/URN-3	1		NavShips 92139
	OA-554/URN-3			
RF Cable	RG-10/U		G15-C-12200-625	JAN-C-17A
RF Cable	RG-18/U		G15-C-12200-750	JAN-C-17A
Connector, plug	UG-154/U	2	17-C-71422-3137	RE 49F 284L
Connector, plug*	UG-943/U	4		

* Consists of UG-573/U Connector plug Armor Clamp MX-1286/U.

NOTES

1. If the RG-18/U cable run exceeds 75 feet use RG-128/U rigid coaxial line.
2. Antenna Assembly OA-553/URN-3 is used for the low-band and Antenna Assembly OA-554/URN-3 is used for the high-band.

June 30, 1954

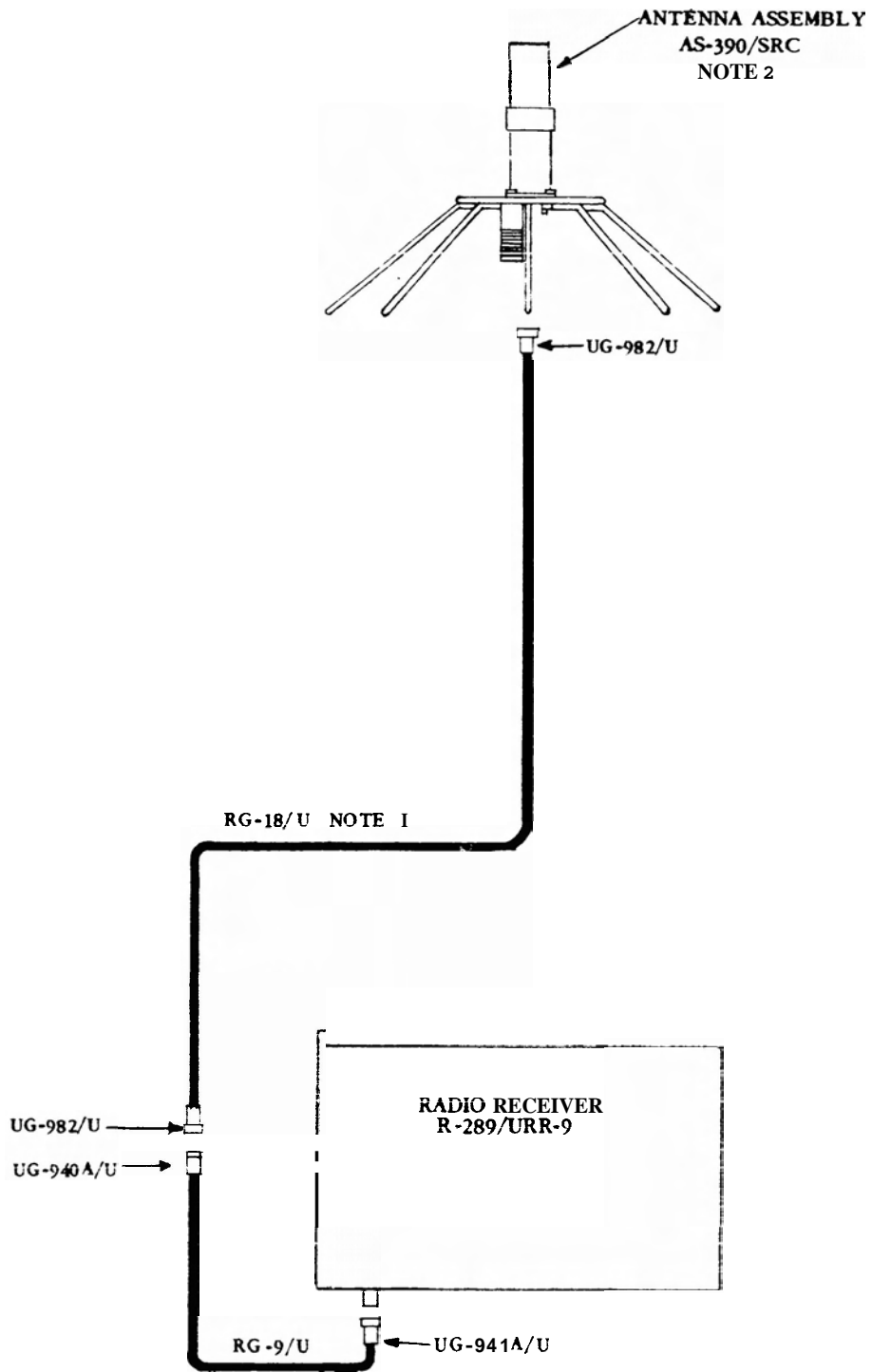

TYPICAL SHIPBOARD ANTENNA SYSTEM FOR RADIO SET AN/URR-9

BILL OF MATERIALS

Name	Type	No. Req'd	Standard Navy Stock Number	Instruction Book, Specification or Drawing
AN/URR-9 Receiver	R-289/URR-9	1	16-R-31680-8401	NavShips 91201
Antenna Assembly	AS-390/SRC	1	F16-A-3590-1001	NavShips 91338
RF Cable	RG-9/U		G15-C-12200-500	JAN-C-17A
RF Cable	RG-18/U		G15-C-12200-750	JAN-C-17h
Connector, plug*	UG-941A/U	1		
Connector, jack**	UG-940A/U	1		
Connector, plug***	UG-982/U	2		RE 49D 215

- * Consists of **UG-21D/U Connector** plus Armor Clamp, **MX-1286/U**.
 ** Consists of **UG-23D/U Connector** plus Armor **Clamp, MX-564A/U**.
 *** Consists of **UG-167D/U Connector** plus Armor Clamp, **MX-1441/U**.

NOTES

1. Limit cable length to 200 feet. For short runs (100 feet or less) **RG-10/U** may be used in place of **RG-18/U**. **UG-941A/U** Connector is used with **RG-10/U** Cable.
2. Antenna **AT-150/SRC** can also be used with Radio Receiver **R-289/URR-9**.

June 30, 1954

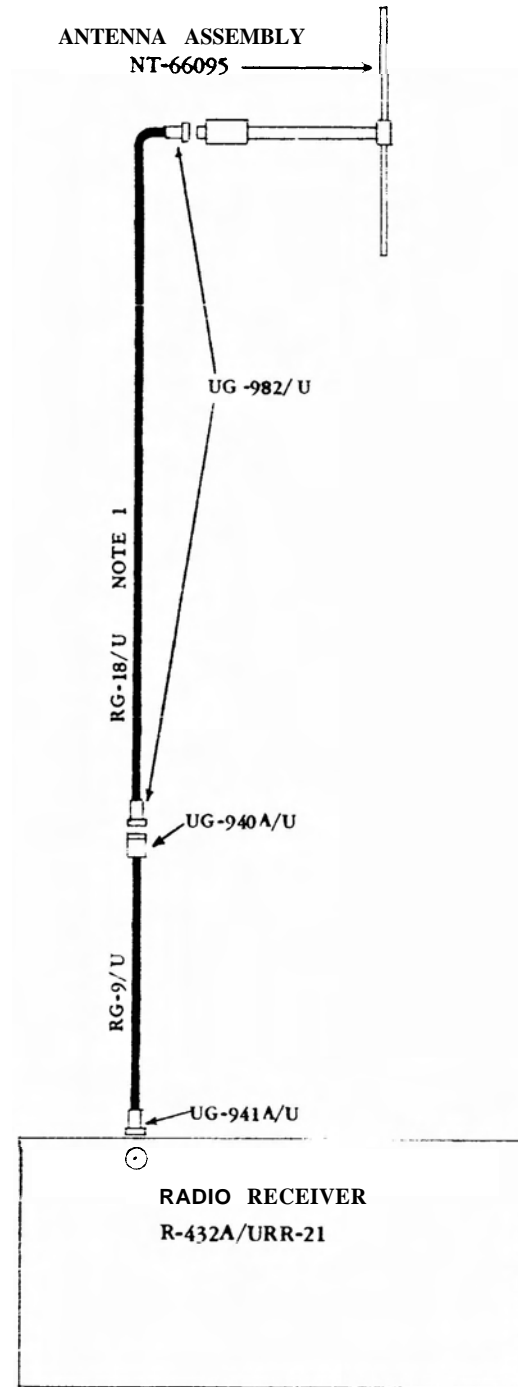

TYPICAL SHIPBOARD ANTENNA SYSTEM FOR RADIO SET AN/URR-21A

BILL OF MATERIALS

Name	Type	No. Req'd	Standard Navy Stock Number	Instruction Book, Specification or Drawing
AN/URR-21A Receiver	R-432A/URR-21	1		NavShips 91642(A)
Antenna Assembly	NT-66095	1	F16-A-48586-5351	NavShips 900,474
RF Cable	RG-9/U		G15-C-12200-500	JAN-C-17A
RF Cable	RG-18/U		G15-C-12200-750	JAN-C-17A
Connector, plug*	UG-941A/U			
Connector, jack**	UG-940A/U			
Connector, plug***	UG-982/U			RE 49D 215

*

Consists of UG-21D/U connector plus Armor Clamp, MX-1286/U..

Consists of UG-23D/U connector plus Armor Clamp, MX-564A/U.

Consists of UG-167D/U connector plus Armor Clamp, MX-1441/U.

NOTES

1. Limit cable length to 200 feet. For short runs (100 feet or less) RG-10/U may be used in place of RG-18/U. UG-941A/U Connector is used with RG-10/U Cable.

June 30, 1954

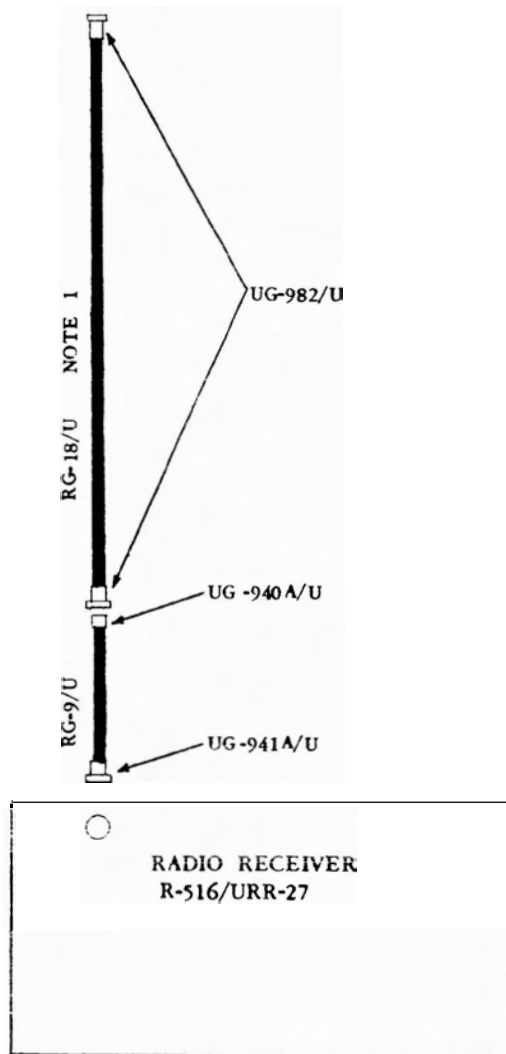
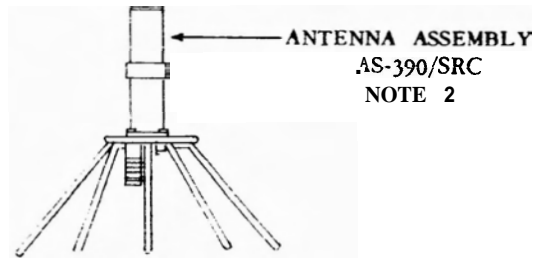

TYPICAL SHIPBOARD ANTENNA SYSTEM FOR RADIO SET AN/URR-27

BILL OF MATERIALS

Name	Type	No. Req'd	Standard Navy Stock Number	Instruction Book, Specification or Drawing
AN/URR-27 Receiver	R-516/URR-27	1		NavShips 91771
Antenna Assembly	AS-390/SRC	1	F16-A-53590-1001	NavShips 91338
RF Cable	RG-9/U		G15-C-12200-500	JAN-C-17A
RF Cable	RG-18/U		G15-C-12200-750	JAN-C-17A
Connector, plug*	UG-941A/U	1		
Connector, jack**	UG-940A/U	1		
Connector, plug+**	UG-982/U	2		RE 49D 215

- * Consists of **UG-21D/U Connector** plus Armor Clamp, **MX-1286/U**.
 ** Consists of **UG-23D/U connector** plus Armor Clamp, **MX-564A/U**.
 *** Consists of **UG-167D/U Connector** plus Armor Clamp, **MX-1441/U**.

NOTES

1. Limit cable length to 200 feet. For short runs (100 feet or less) **RG-10/U** may be used in place of **RG-18/U**. **UG-941A/U** Connector is used with **RG-10/U** Cable.
2. Antenna **AT-150/SRC** can also be used with Radio Receiver **R-516/URR-27**.

June 30, 1954

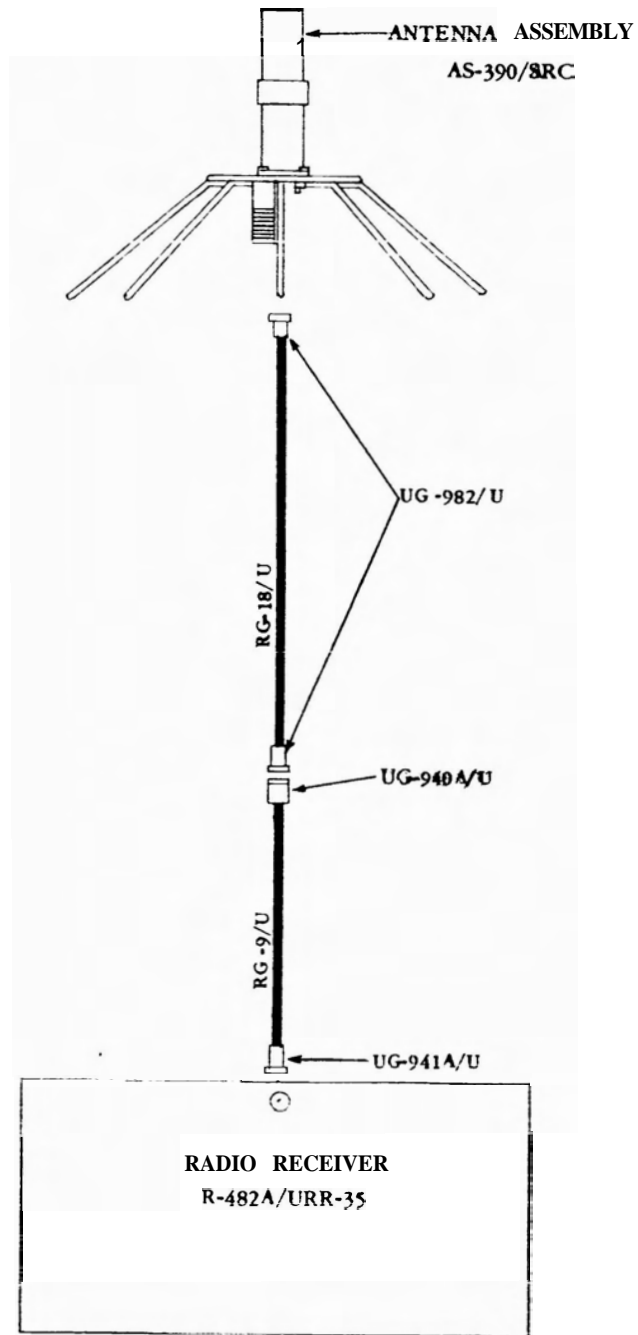

TYPICAL SHIPBOARD ANTENNA SYSTEM FOR RADIO SET AN/URR-35A

BILL OF MATERIALS

Name	Type	No. Req'd	Standard Navy Stock Number	Instruction Book, Specification or Drawing
AN/URR-35A Receiver	R-482A/URR-35	1		NavShips 92022
Antenna Assembly	AS-390/SRC	1	F16-A-53590-1001	NavShips 91338
RF Cable	RG-9/U		G15-C-12200-500	JAN-C-17A
RF Cable	RG-18/U		G15-C-12200-750	JAN-C-17A
Connector, plug*	UG-941A/U	1		
Connector, jack**	UG-940A/U	1		
Connector, plug***	UG-982/U	2		RE 49D 215

* Consists of ~~UG-21D/U~~ Connector plus Armor Clamp, ~~MX-1286/U~~.

** Consists of ~~UG-23D/U~~ Connector plus Armor Clamp, ~~MX-564A/U~~.

*** Consists of ~~UG-167D/U~~ Connector plus Armor Clamp, ~~MX-1441/U~~.

NOTES

1. Limit cable length to 200 feet. For short runs (100 feet or less) ~~RG-10/U~~ may be used in place of ~~RG-18/U~~. ~~UG-941A/U~~ Connector is used with ~~RG-10/U~~ Cable.
2. Antenna ~~AT-150/SRC~~ can also be used with Radio Receiver ~~R-482A/URR-35~~.

June 30, 1954

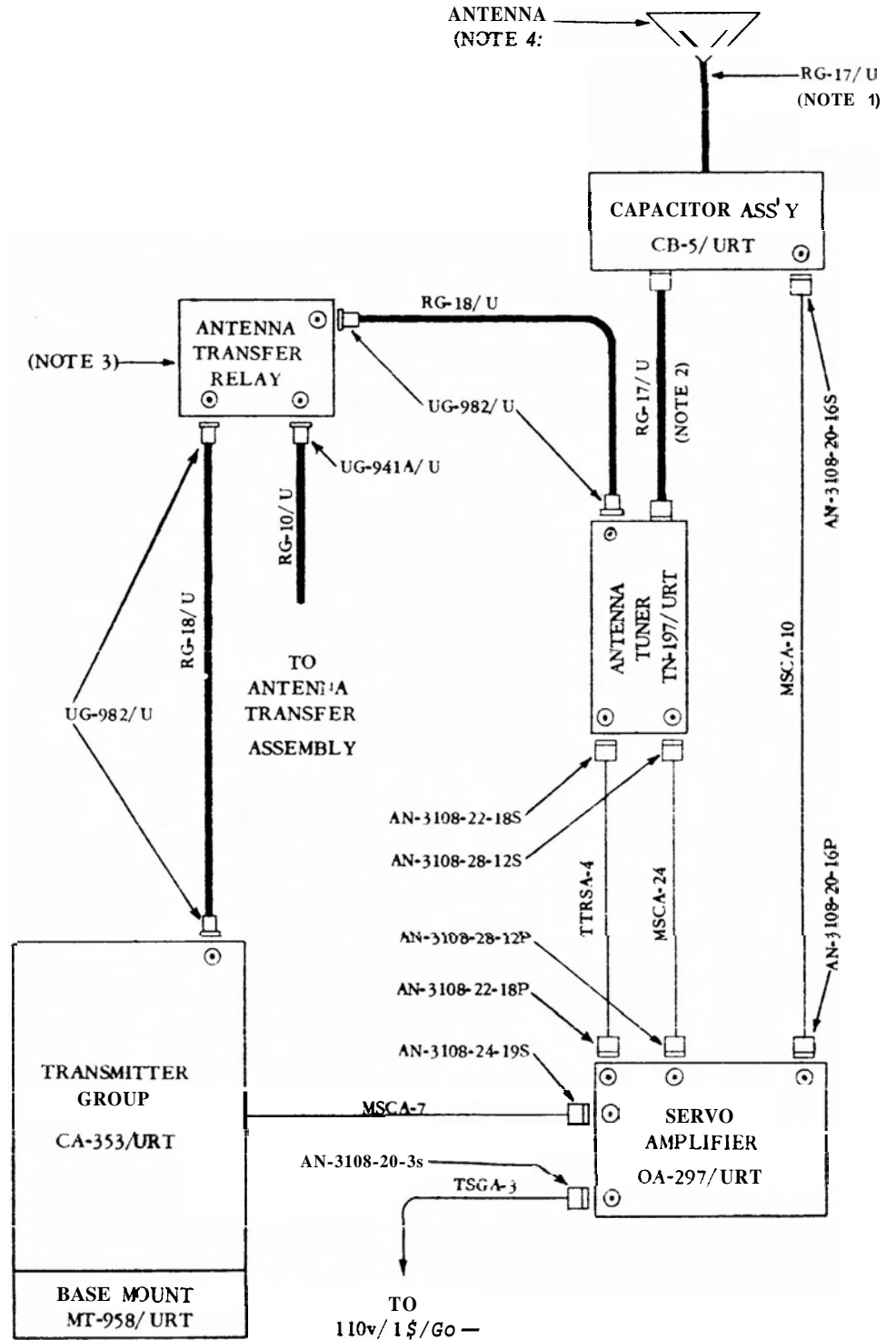

TYPICAL SHIPBOARD ANTENNA SYSTEM FOR AN/URT-2 RADIO TRANSMITTER

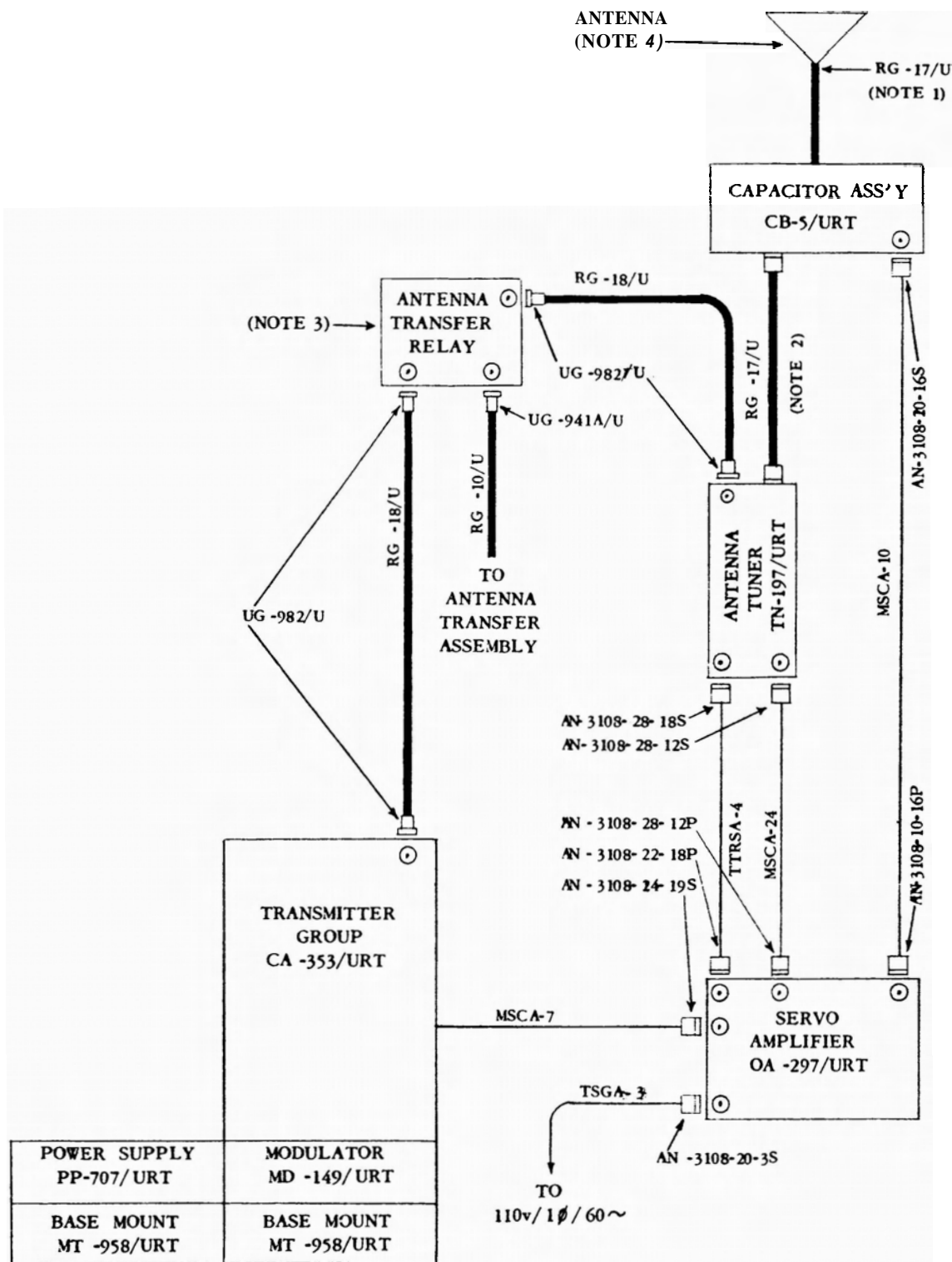

TYPICAL SHIPBOARD ANTENNA SYSTEM FOR AN/URT-3 RADIO XMITTER

UNCLASSIFIED

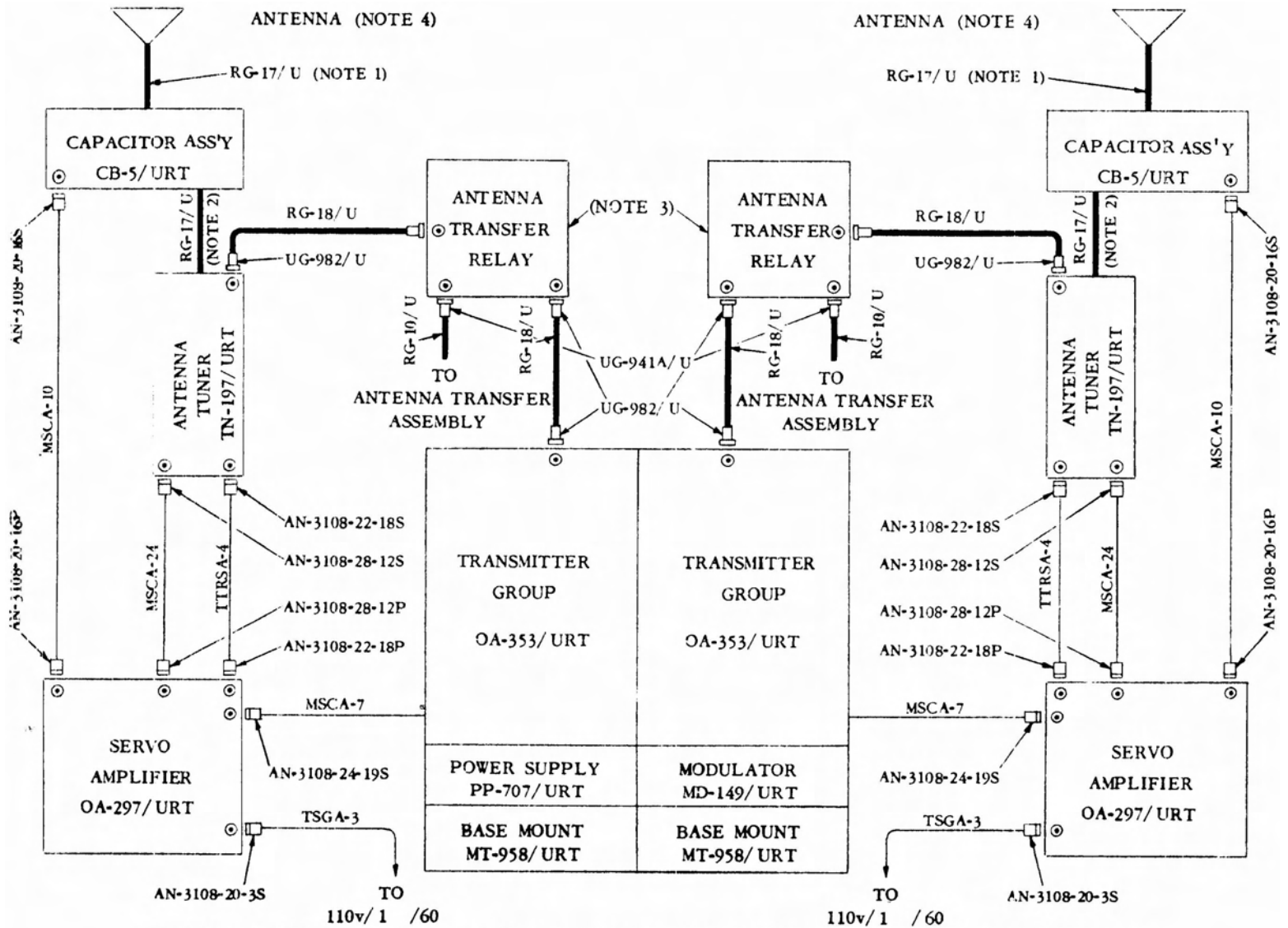

TYPICAL SHIPBOARD ANTENNA SYSTEM FOR AN/URT-4 RADIO TRANSMITTER

BILL OF MATERIALS

Name	Type	No. Req'd	Standard Navy Stock Number	Instruction Book Specification or Drawing
Transmitter Group	OA-353/URT			RE 10H 2021
Power Supply	PP-707/URT			RE 10H 2021
Modulator	MD-149/URT			RE 10H 2021
Base Mount	MT-958/URT			RE 10H 2021
Antenna Tuner	TN-197/URT			RE 10H 2021
Servo Amplifier	OA-297/URT			RE 10H 2021
Capacitor Ass'y Box	CB-5/URT			RE 10H 2021
Antenna: 35" whip or	66047		F16-A-54370-1250	RE 66F 449
"L" Type Wire Antenna	5/16" (6 x 19) Wire Rope		G22-R-200	
Antenna Transfer Relay				
Antenna Transfer Assembly				
R F Cable	RG-10/U		15-C-12200-625	JAN-C-17A
R F Cable	RG-17/U		15-C-12200-725	JAN-C-17A
R F Cable	RG-18/U		15-C-12200-750	JAN-C-17A
Connector, plug*	UG-941A/U			
Connector, plug**	UG-982/U			RE 49D 215
Cable	MSCA-7		G15-C-5680-700	MIL-C-2194
Cable	MSCA-10		G15-C-5680-1000	MIL-C-2194
Cable	MSCA-24		G15-C-5680-2400	MIL-C-2194
Cable	TTRSA-4		G15-C-10674	MIL-C-915
Cable	TSGA-3		G15-C-10299-461	MIL-C-2194
AN Connector	AN 3108-20-16S		N17-C-70066-3792	AND 10430

June 30, 1954

BILL OF MATERIALS

Name		No. Req'd	Standard Navy Stock Number	Instruction Book, Specification or Drawing
AN Connector	AN 3108-20-16P			
AN Connector	AN 3108-22-18S			
AN Connector	AN 3108-22-18P			
AN Connector	AN 3108-22-12S		N17-C-70082-5653	AND 10433
AN Connector	AN 3108-28-12P			
AN Connector	AN 3108-24-19S			
AN Connector	AN 3108-20-3S		N17-C-70041-2391	AND 10430

* Consists of UG-21D/U with Armor Clamp, MX-1286 /U.

** Consists of UG-167D/U with Armor Clamp, MX-1441/U.

NOTES

1. Antenna lead is RG-17/U with the vinyl jacket and shield removed. The cable length should not be more than 10 feet. The cable should be kept a minimum of 2 inches from metal objects it crosses, 6 inches from deck or bulkhead, and supported by insulators every 18 inches.
2. Connecting lead between the Capacitor Assembly Box and Antenna Tuner is RG-17/U with the vinyl jacket and shield removed. Maximum length is 5 feet. Plugs furnished with equipment.
3. Antenna Transfer Relay and Antenna Transfer Assembly are used only when the antenna is to be used for receiving as well as transmitting. RG-18/U may be used in place of RG-10/U if the proper adapters are used. (Relay presently under development.)
4. Either a 35 foot whip antenna (NT-66047) is used or an "L" type wire antenna (60 to 175 feet long),
5. The control cables between the servo amplifier and the antenna tuner or the capacitor assembly shall not exceed 100 feet in length. If it is absolutely necessary to exceed 100 feet in length for these cables, precautions shall be taken to insure against an increase in the voltage drop in these circuits.

June 30, 1954

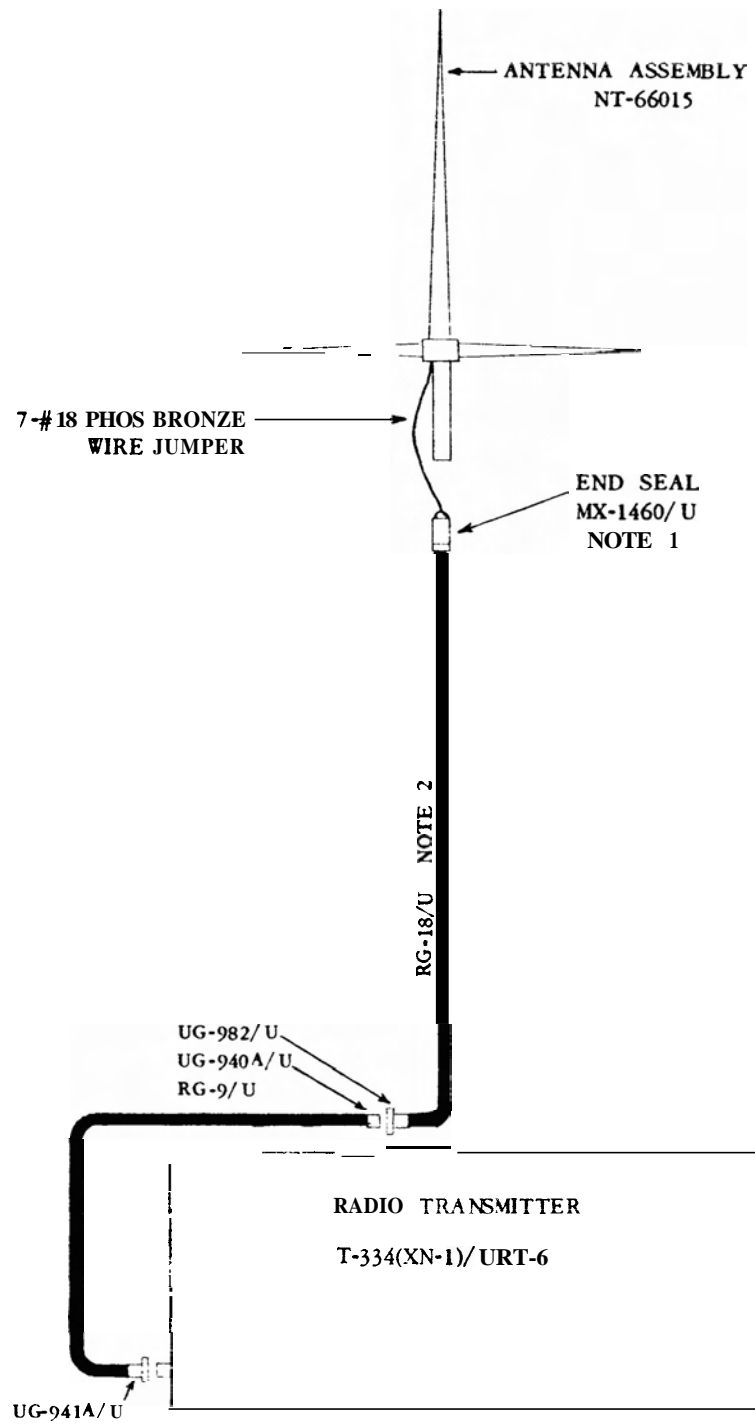

TYPICAL SHIPBOARD ANTENNA SYSTEM FOR RADIO SET AN/URT-6(XN-1)

BILL OF MATERIALS

Name	Type	No. Req'd	Standard Navy Stock Number	Instruction Book, Specification
AN/URT-6(XN-1) Transmitter	T-334(XN-1)/ URT-6	1		NavShips 91576
Antenna Assembly	NT-66015	1	F16-A-53581-6301	NavShips 900,590
RF Cable	RG-9/U		G15-C-12200-500	JAN-C-17A
RF Cable	RG-18/U		G15-C-12200-750	JAN-C-17A
Connector, plug*	UG-941A/U	1		
Connector, jack**	UG-940A/U	1		RE 49D 215
Connector, plug***	UG-982/U	1		RE 49D 215
End Seal	MX-1460/U	1		
Wire Jumper	7-#18 Phos brz		N16-W-3740-1	MIL-W-17211

* Consists of UG-21D/U Connector plus Armor Clamp, MX-1286/U.

** Consists of UG-23D/U connector plus Armor Clamp, MX-564A/U.

*** Consists of UG-167D/U Connector plus Armor Clamp, MX-1441/U.

NOTES

1. Ground end seal lug to ground plane elements.
2. Limit cable length to 200 feet. For short runs (100 feet or less) RG-10/U may be used in place of RG-18/U. UG-941A/U Connector is used with RG-10/U Cable.

June 30, 1954

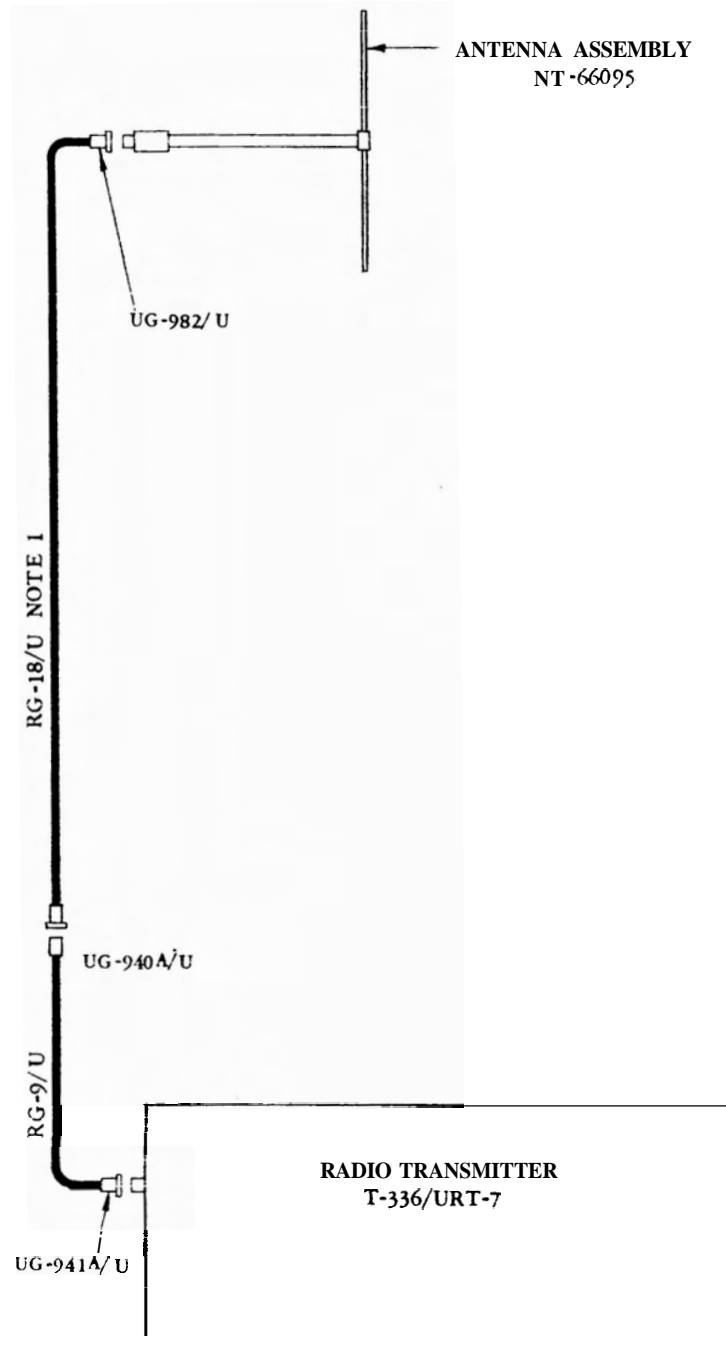

TYPICAL SHIPBOARD ANTENNA SYSTEM FOR RADIO SET AN/URT-7(XN-1)

BILL OF MATERIALS

Name	Type	Qty Req'd	Standard Navy Stock Number	Instruction Book, Specification or Drawing
AN/URT-7(XN-1) Transmitter	T-336/URT-7	1		NavShips 91684
Antenna Assembly	NT-66095	1	F16-A-48586-5351	NavShips 900,474
RF Cable	RG-9/U		G15-C-12200-500	JAN-C-17A
RF Cable	RG-18/U		G15-C-12200-750	JAN-C-17A
Connector, plug*	UG-941A/U	1		
Connector, jack**	UG-940A/U	1		
Connector, plug***	UG-982/U	2		RE 49D 215

* Consists of **UG-21D/U Connector** plus Armor Clamp, **MX-1286/U**.

** Consists of **UG-23D/U Connector** plus Armor Clamp, **MX-564A/U**.

*** Consists of **UG-167D/U Connector** plus Armor Clamp, **MX-1441/U**.

NOTES

1. Limit cable length to 300 feet. For short runs (100 feet or less) **RG-10/U** may be used in place of **RG-18/U**. **UG-941A/U** Connector is used with **RG-10/U** Cable.

June 30, 1954

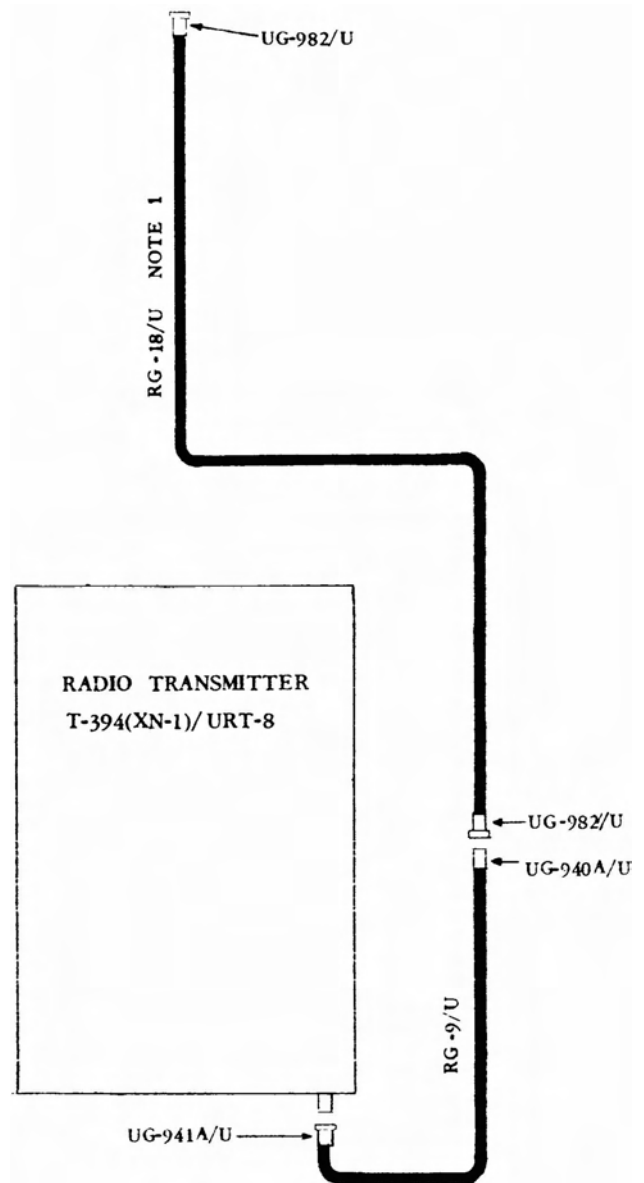
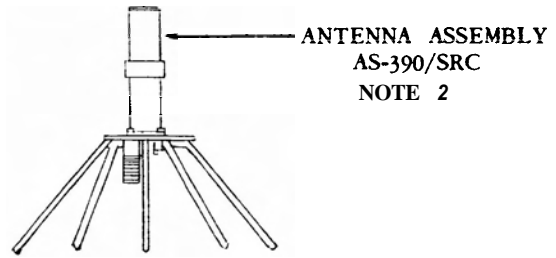

TYPICAL SHIPBOARD ANTENNA SYSTEM FOR RADIO SET AN/URT-8(XN-1)

BILL OF MATERIALS

Name	Type	No. Req'd	Standard Navy Stock Number	Instruction Book, Specification or Drawing
AN/URT-8(XN-1) Transmitter	T-394(XN-1)/URT-8	1		NavShips 91917
Antenna Assembly	AS-390/SRC	1	F16-A-53590-1001	NavShips 91338
RF Cable	RG-9/U		G15-C-12200-500	JAN-C-17A
RF Csble	RG-18/U		G15-C-12200-750	JAN-C-17A
Connector, plug*	UG-941A/U	1		
Connector, jack**	UG-940A/U	1		
Connector, plug*+*	UG-982/U	2		RE 49D 215

*

* Consists of **UG-21D/U** Connector plus Armor Clamp, **MX-1286/U**.

** Consists of **UG-23D/U** Connector plus Armor Clamp, **MX-564A/U**.

*** Consists of **UG-167D/U** Connector plus Armor Clamp, **MX-1441/U**.

NOTES

1. Limit length of cable to 200 feet. For short runs (100 feet or less) **RG-10/U** may be used in place of **RG-18/U**. **UG-941A/U** Connector is used with **RG-10/U** Cable.
2. Antenna **AT-150/SRC** can also be used with Radio Transmitter **T-394(XN-1)/URT-8**.

June 30, 1954

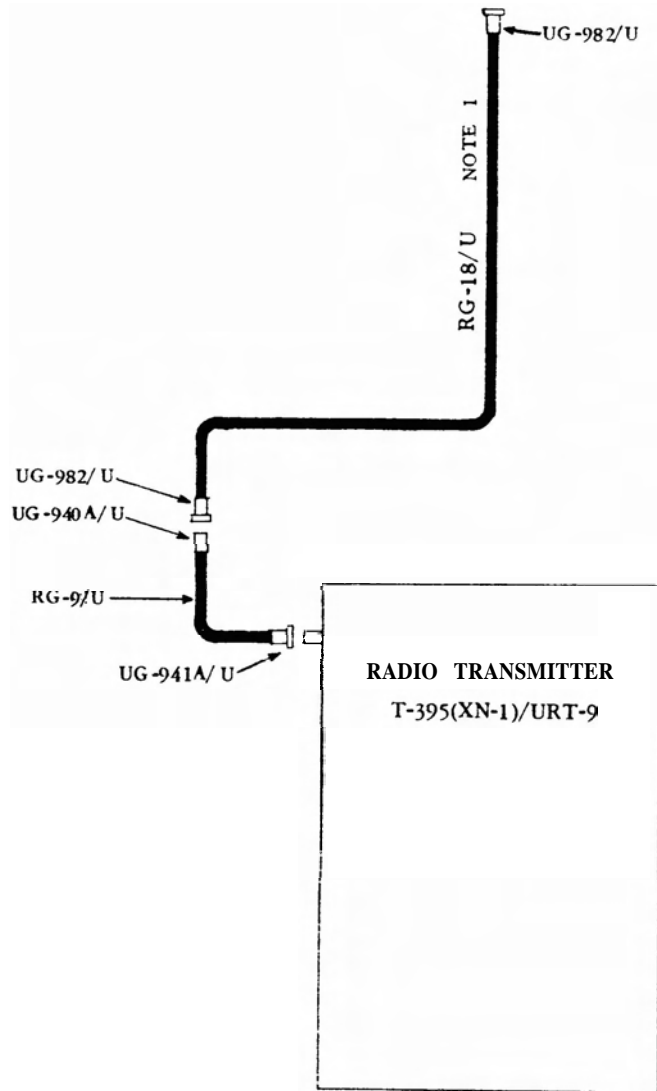
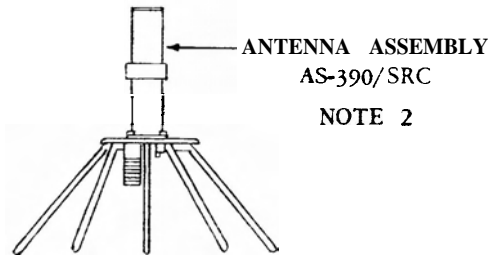

TYPICAL SHIPBOARD ANTENNA SYSTEM FOR RADIO SET AN/URT-9(XN-1)

BILL OF MATERIALS

Name	Type	No. Req'd	Standard Navy Stock Number	Instruction Book, Specification or Drawing.
AN/URT-9(XN-1) Transmitter	T-395(XN-1)/URT-9	1		NavShips 91846
Antenna Assembly	AS-390/SRC	1	F16-A-53590-1001	NavShips 91338
RF Cable	RG-9/U		G15-C-12200-500	JAN-C-17A
RF Cable	RG-18/U		G15-C-12200-750	JAN-C-17A
Connector, plug*	UG-941A/U	1		
Connector, jack**	UG-940A/U	1		
Connector, plug***	UG-982/U	2		RE 49D 215

- * Consists of UG-21D/U connector plus Armor Clamp, MX-1286/U.
 ** Consists of UG-23D/U connector plus Armor Clamp, MX-564A/U.
 *** Consists of UG-167D/U Connector plus Armor Clamp, MX-1441/U.

NOTES

1. Limit cable length to 200 feet. For short runs (100 feet or less) RG-10/U may be used in place of RG-18/U. UG-941A/U Connector is used with RG-10/U Cable.
2. Antenna AT-150/SRC can also be used with Radio Transmitter T-395(XN-1)/URT-9.

June 30, 1954

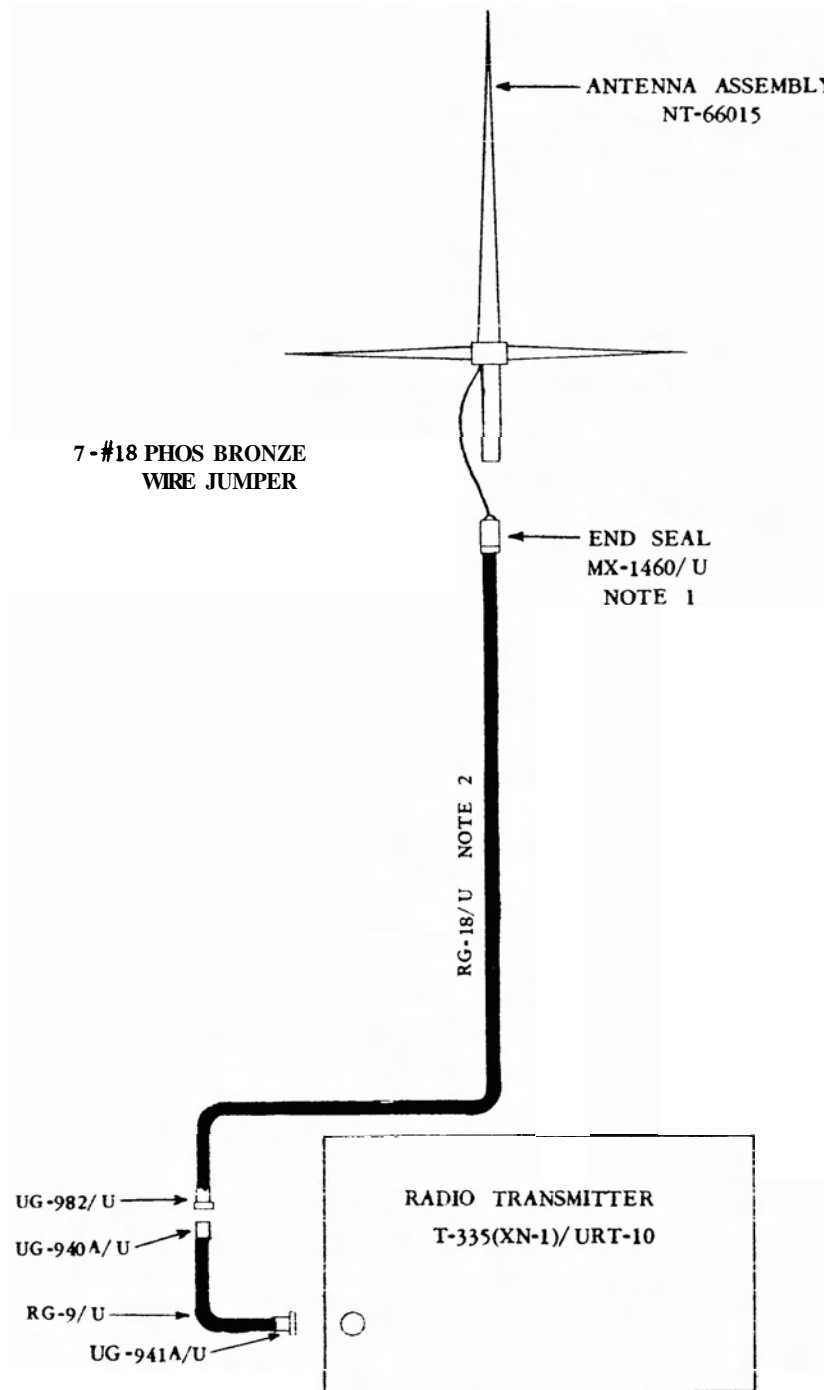

TYPICAL SHIPBOARD ANTENNA SYSTEM FOR RADIO SET AN/URT-10(XN-1)

BILL OF MATERIALS

Name	Type	No. Req'd	Standard Navy Stock Number	Instruction Book, Specification or Drawing
AN/URT -10(XN-1) Transmitter	T-335(XN-1)/URT-10	1		NavShips 91623
Antenna Assembly	NT-66015	1	F16-A-53581-6301	NavShips 900,590
RF Cable	RG-9/U		G15-C-12200-500	JAN-C-17A
RF Cable	RG-18/U		G15-C-12200-750	JAN-C-17A
Connector, plug*	UG-941A/U	1		
Connector, jack**	UG-940A/U	1		
Connector, plug***	UG-982/U	1		RE 49D 215
End Seal	MX-1460/U	1		
Wire Jumper	7-#18 Phos Brz		N16-W-3740-1	MIL-W-17211

- * Consists of UG-21D/U Connector plus Armor Clamp, MX-1286/U.
 ** Consists of UG-23D/U Connector plus Armor Clamp, MX-564A/U.
 *** Consists of UG-167D/U Connector plus Armor Clamp, MX-1441/U.

NOTES

1. Ground end seal lug to ground **plane** elements.
2. Limit cable length to 200 feet. For short runs (100 feet or less) RG-10/U may be used in place of RG-18/U. UG-941A/U Connector is **used** with RG-10/U Cable.

June 30, 1954

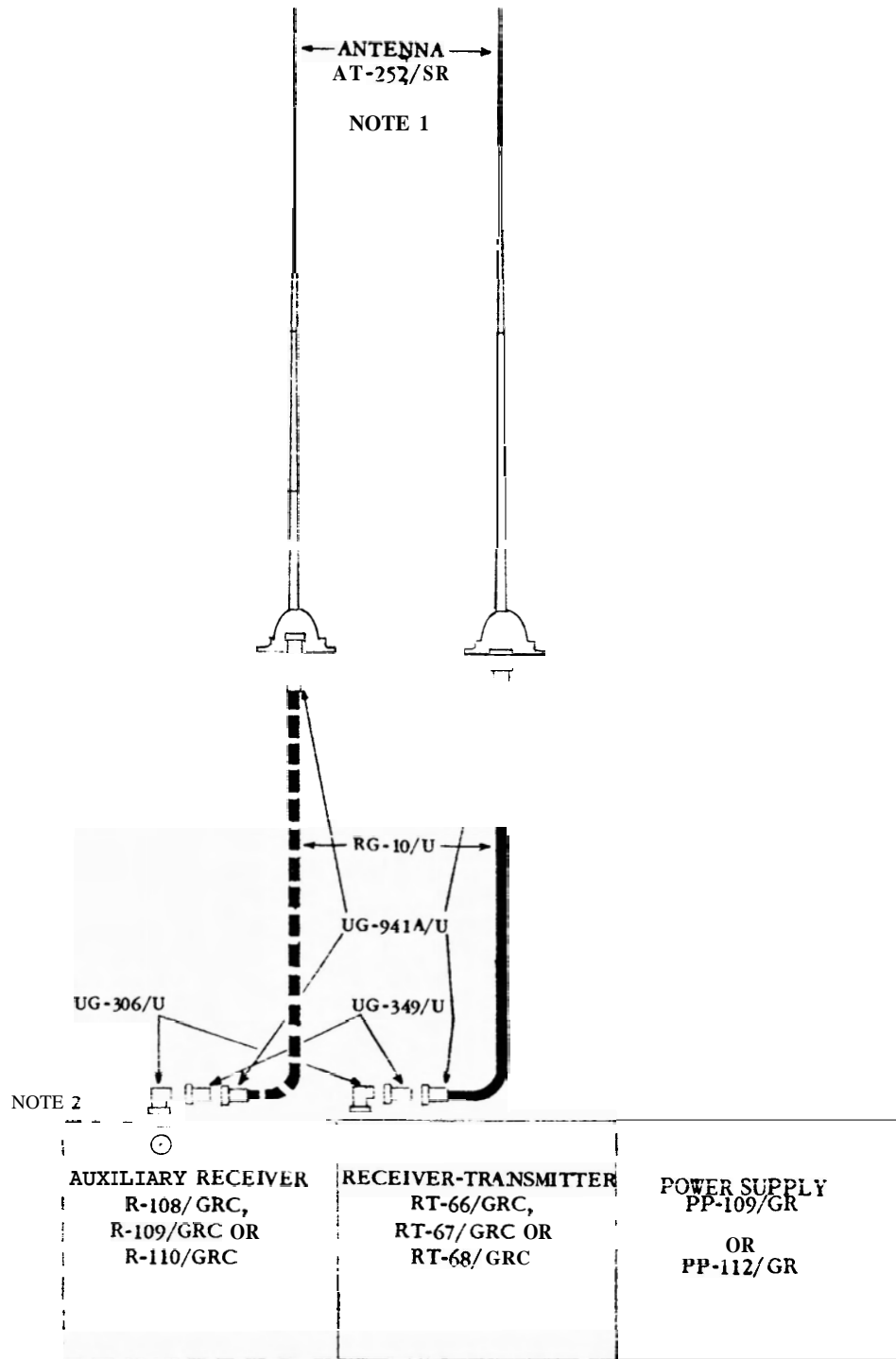

TYPICAL SHIPBOARD ANTENNA SYSTEM FOR RADIO SETS AN/VRC-16, 17, 18

BILL OF MATERIALS

Name	Type	No. Req'd	Standard Navy Stock Number	Instruction Book, Specification or Drawing
Radio Equipment AN/VRC-16, 17, 18				TMI 1-611
Antenna AN/SRA-3	AT-252/SR	1	N16-A-54463-5150	NavShips 91292
RF Cable	RG-10/U		G15-C-12200-625	JAN-C-17A
Connector, adapter	UG-306/U	1	17-C-67443-6230	
Connector, plug	UG-349/U	1	17-C-67991-2929	RE 49F 461A'
Connector, plug*	UG-941A/U	2		

* Consists of UG-21D/U Connector plus Armor Clamp, MX-1286/U.

NOTES

1. For AN/VRC-16 use full length of AT-252/SR (125"). For AN/VRC-17 cut AT-252/SR to 89" in length. For AN/VRC-18 cut AT-252/SR to 58" in length.
2. A second Antenna AT-252/SR is required for Radio Sets AN/VRC-16, 17, 18 if auxiliary Receivers R-108/GRC, 109/GRC, or 110/GRC are used with these sets respectively.

June 30, 1954

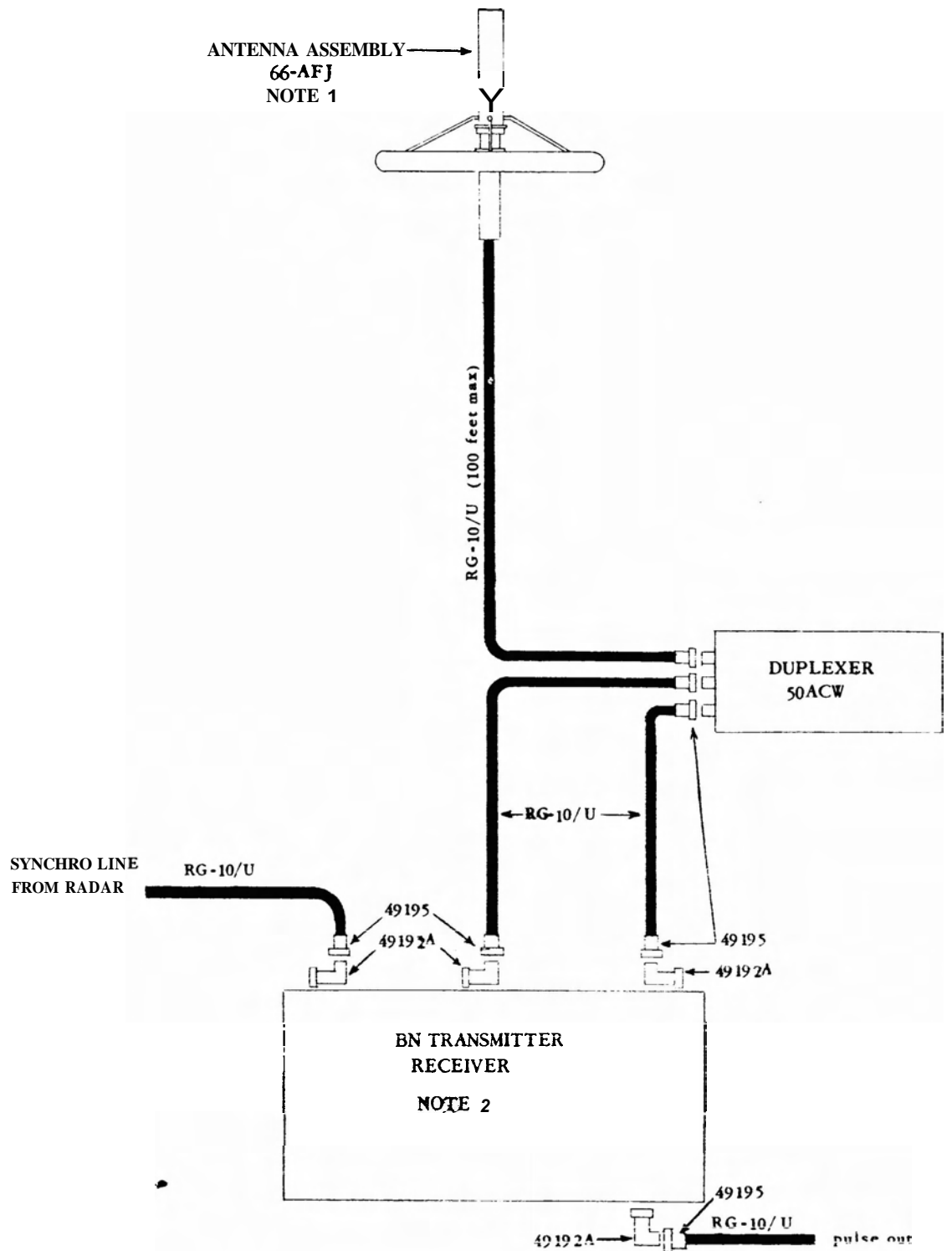

TYPICAL SHIPBOARD ANTENNA SYSTEM FOR BN TRANSMITTER RECEIVER

BILL OF MATERIALS

Name	Type	No. Req'd	Standard Navy Stock Number	Instruction Book, Specification or Drawing
Transmitter - Receiver BN	46ACW	1	16-A-39224-1001	NavShips 95125
Duplexer	50ACW	1	16-D-86711-6101	NavShips 95125
Antenna Assembly	66-AFJ	1	F16-A-52285-7805	NavShips 918. 8
RF Cable	RG-10/U		G15-C-12200-625	JAN-C-17A
Connector, plug	49195	8	17-C-71414-2800	RE 49F 167
Connector, adapter	49192A	4	17-C-67444-1300	RE 49F 168

NOTES

1. Antenna 66-ACG may be used in place of Antenna **66-AFJ**.
2. **The BK Equipment is** installed in the same manner.

June 30, 1954

6-68

UNCLASSIFIED

ORIGINAL

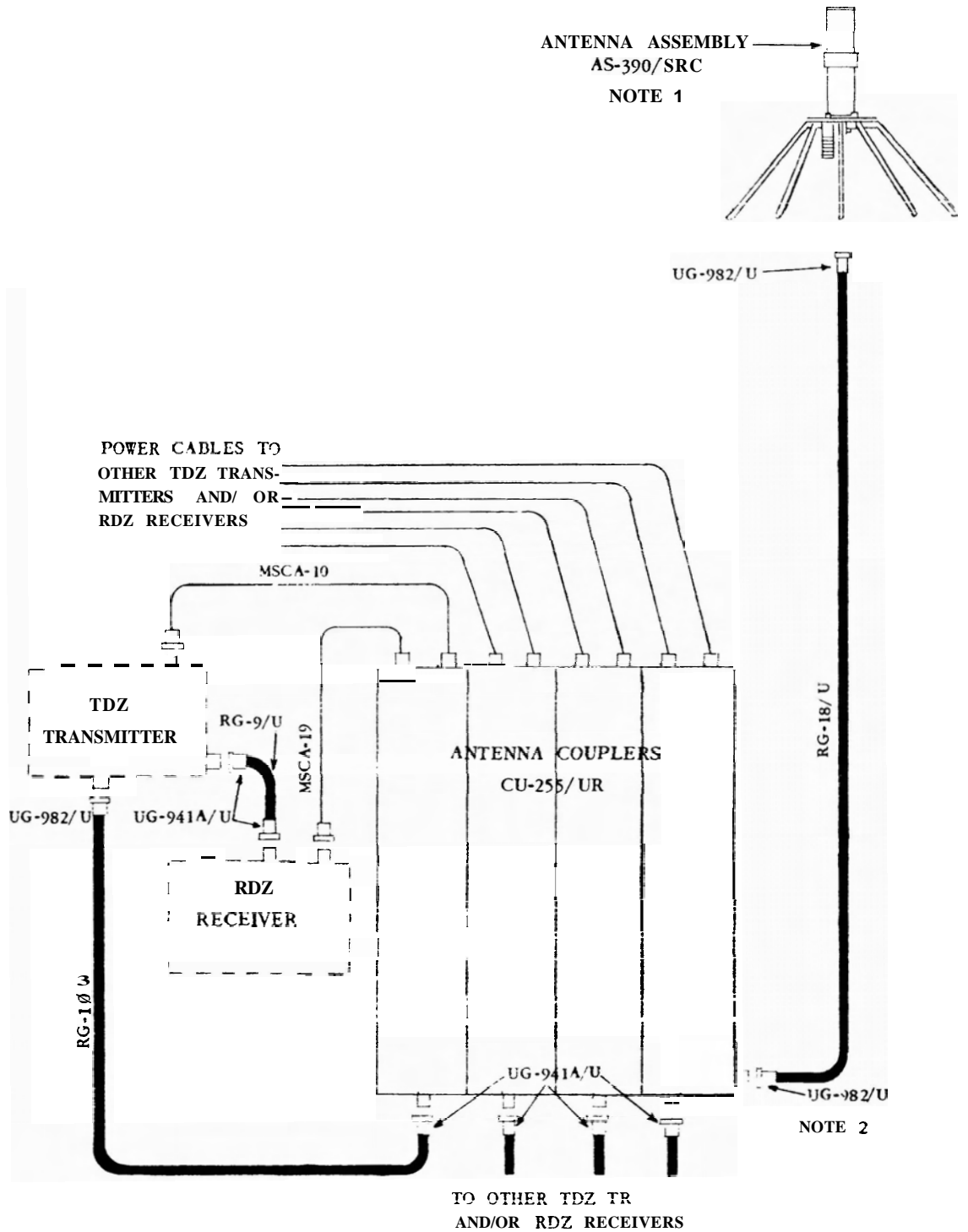

TYPICAL SHIPBOARD ANTENNA SYSTEM FOR ANTENNA COUPLERS CU-255/UR

BILL OF MATERIALS

Name	Type	No. Req'd	Standard Navy Stock Number	Instruction Book, Specification or Drawing
Antenna Coupler	CU-255/UR		F16-C-91733-5481	MIL-A-15706 (Ships)
Antenna Assembly	AS-390/SRC	1	F16-A-53590-1001	NavShips 91338
RF Cable	RG-9/U		G15-C-12200-500	JAN-C-17A
RF Cable	RG-10/U		G15-C-12200-625	JAN-C-17A
RF Cable	RG-18/U		G15-C-12200-750	JAN-C-17A
Power Cable	MSCA-10		G15-C-5680-1000	MIL-C-2194
Power Cable	MSCA-19		G15-C-5680-1900	MIL-C-2194
Connector, plug*	UG-941A/U			
Connector, plug**	UG-982/U			RE 49D 215
Connector, plug	AN 3108B-22-14S			MIL-C-5015
Connector, plug	AN-3108B-22-14P		N17-C-70207-6098	MIL-C-5015

- * Consists of UG-21D/U Connector plus Armor Clamp, MX-1286/U.
 ** Consists of UG-167D/U Connector plus Armor Clamp, MX-1441/U.

NOTES

1. Antenna AT-150/SRC can also be used with Antenna Coupler CU-255/UR.
2. Connector UG-27/U may be used if cable run requires it.

June 30, 1954

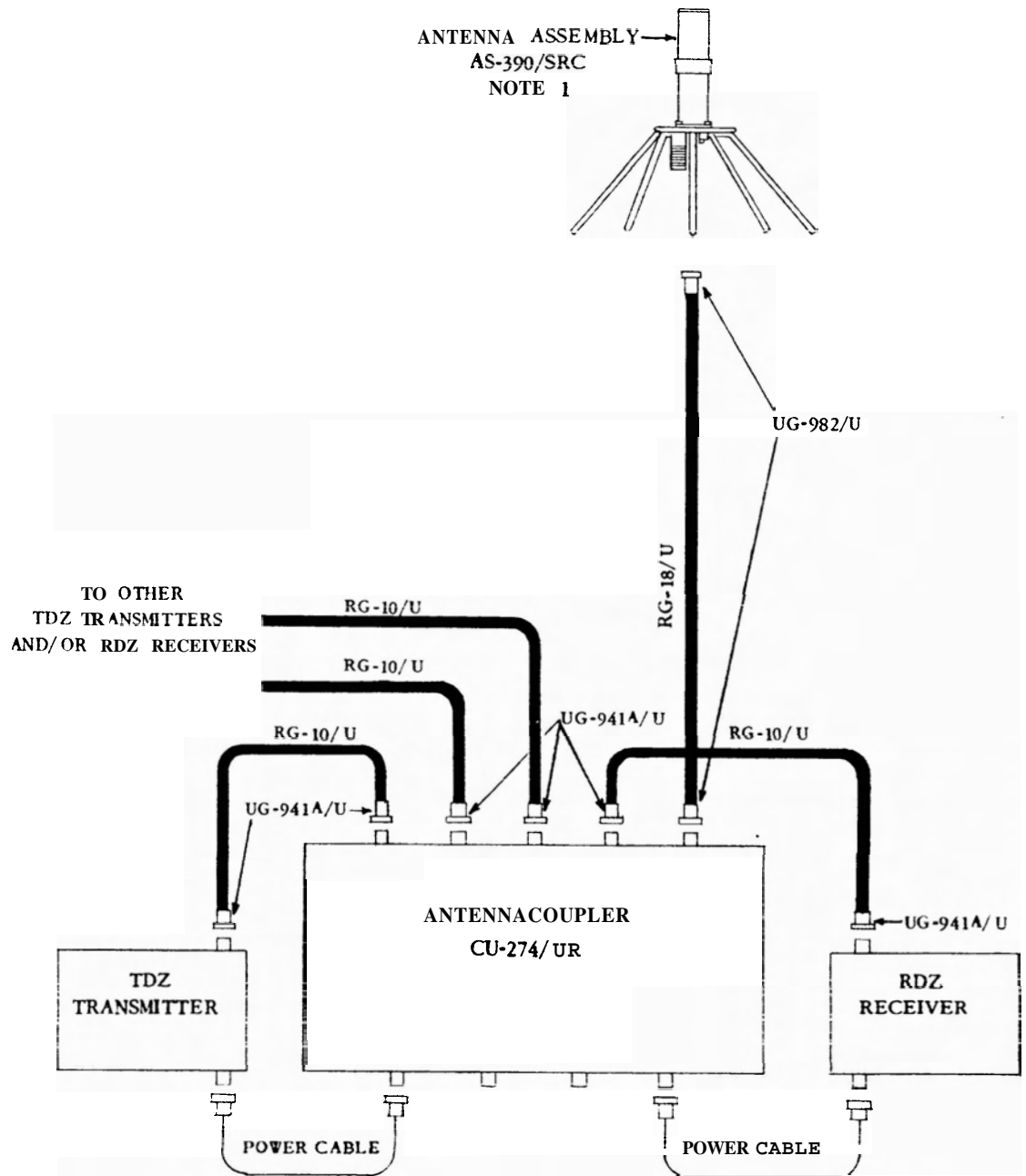

TYPICAL SHIPBOARD ANTENNA SYSTEM FOR ANTENNA COUPLER CU-274/UR

BILL OF MATERIALS

Name	Type	No. Req'd	Standard Navy Stock Number	Instruction Book, Specification or Drawing
Antenna Coupler	CU-274/UR			NavShips 91860
Antenna Assembly	AS-390/SRC	1	F16-A-53590-1001	NavShips 91338
R F Cable	RG-9/U		G15-C-12200-500	JAN-C-17A
R F Cable	RG-10/U		G15-C-12200-625	JAN-C-17A
R F Cable	RG-18/U		G15-C-12200-750	JAN-C-17A
Connector, plug*	UG-941A/U			
Connector, plug**	UG-982/U	2		

* Consists of UG-21D/U Connector plus Armor Clamp, MX-1286/U
 ** Consists of UG-167D/U Connector plus Armor Clamp, MX-1441/U

NOTES

1. Antennas AT-150/SRC, AS-468/U, or AS-493/U can also be used with Antenna Coupler CU-274/UR.

June 30, 1954

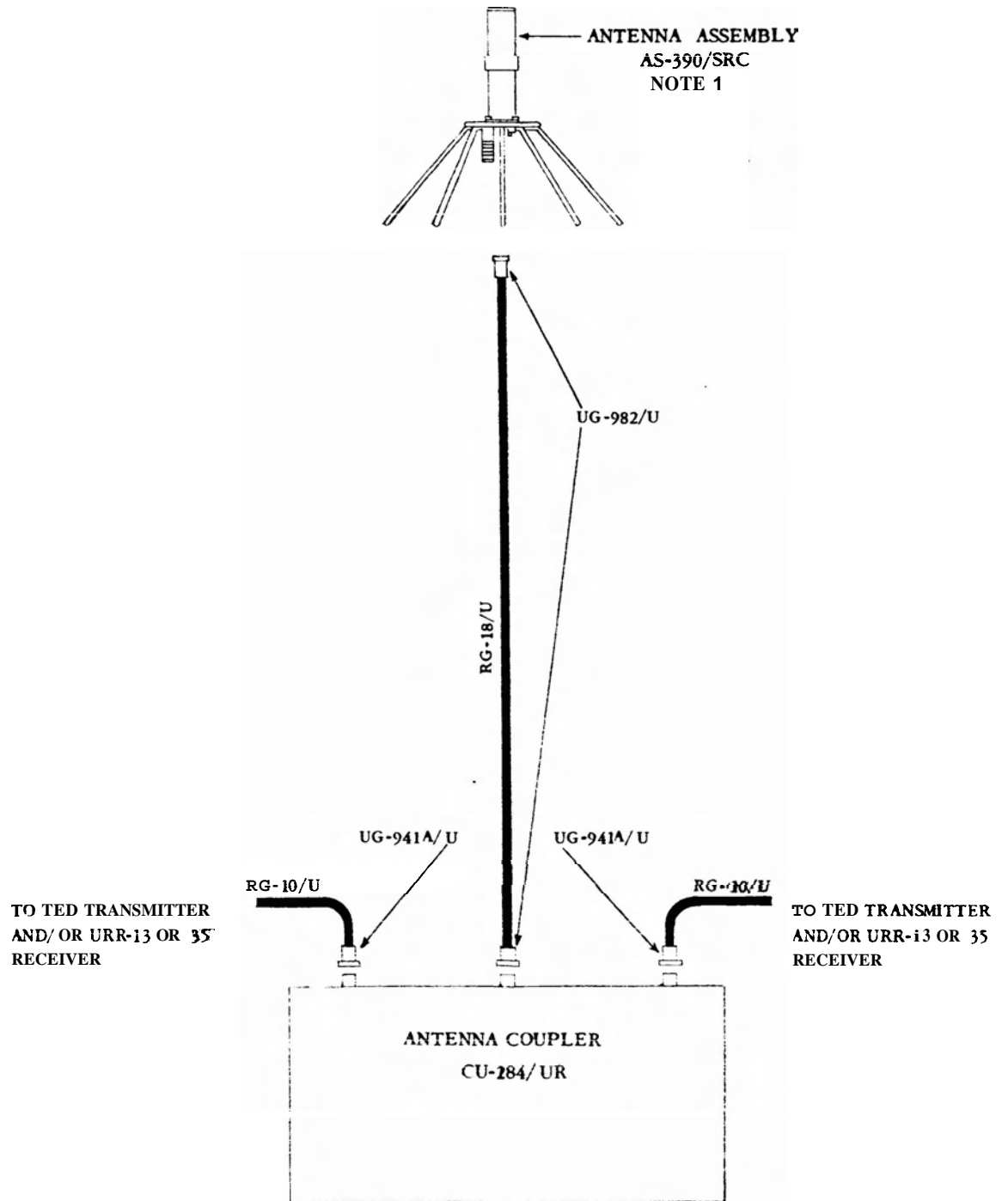

TYPICAL SHIPBOARD ANTENNA SYSTEM FOR ANTENNA COUPLER CU-284/UR

BILL OF MATERIALS

Name	Type	No. Req'd	Standard Navy Stock Number	Instruction Book, Specification Drawing
Antenna Coupler	CU-284/UR			NavShips 91790
Antenna Assembly	AS-390/SRC	1	F16-A-53590-1001	NavShips 91338
R F Cable	RG-10/U		G15-C-12200-625	JAN-C-17A
R F Cable	RG-18/U		G15-C-12200-750	JAN-C-17A
Connector, plug*	UG-941A/U			
Connector, plug**	UG-982/U	2		RE 49D 215

- * Consists of UG-21D/U Connector plus Armor Clamp, MX-1286/U
 ** Consists of UG-167D/U Connector plus Armor Clamp, MX-1441/U

NOTES

1. Antennas AT-150/SRC, AS-468/U or AS-493/U can also be used with Antenna Coupler CU-284/UR.

June 30, 1954

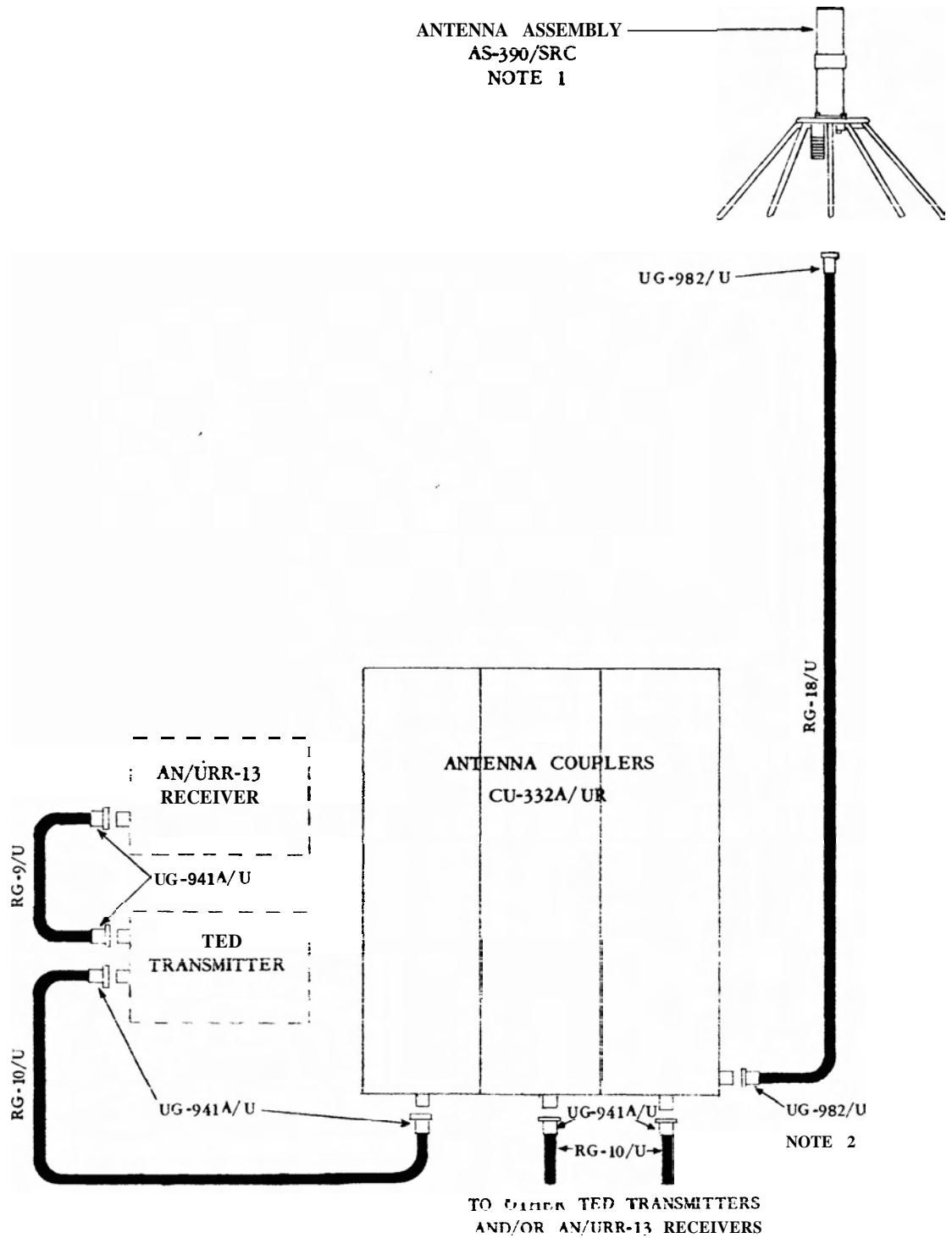

TYPICAL SHIPBOARD ANTENNA SYSTEM FOR ANTENNA COUPLERS CU-332A/UR

BILL OF MATERIALS

Name	Type	No. Req'd	Standard Navy Stock Number	Instruction Book, Specification or Drawing
Antenna Coupler	CU-332A/UR		F16-C-91773-5601	NavShips 91745
Antenna Assembly	AS-390/SRC		F16-A-53590-1001	NavShips 91338
R F Cable	RG-9/U		G15-C-12200-500	JAN-C-17A
R F Cable	RG-10/U		G15-C-12200-625	JAN-C-17A
R F Cable	RG-18/U		G15-C-12200-750	JAN-C-17A
Connector, plug*	UG-941A/U			
Connector, plug**	UG-982/U			RE 49D 215

- * Consists of UG-21D/U Connector plus Armor Clamp, MX-1286/U
 ** Consists of UG-167D/U Connector plus Armor Clamp, MX-1441/U

NOTES

1. Antenna AT-150/SRC can also be used with Antenna Coupler CU-322A/UR.
2. Connector UG-27/U may be used if cable run requires it.

June 30, 1954

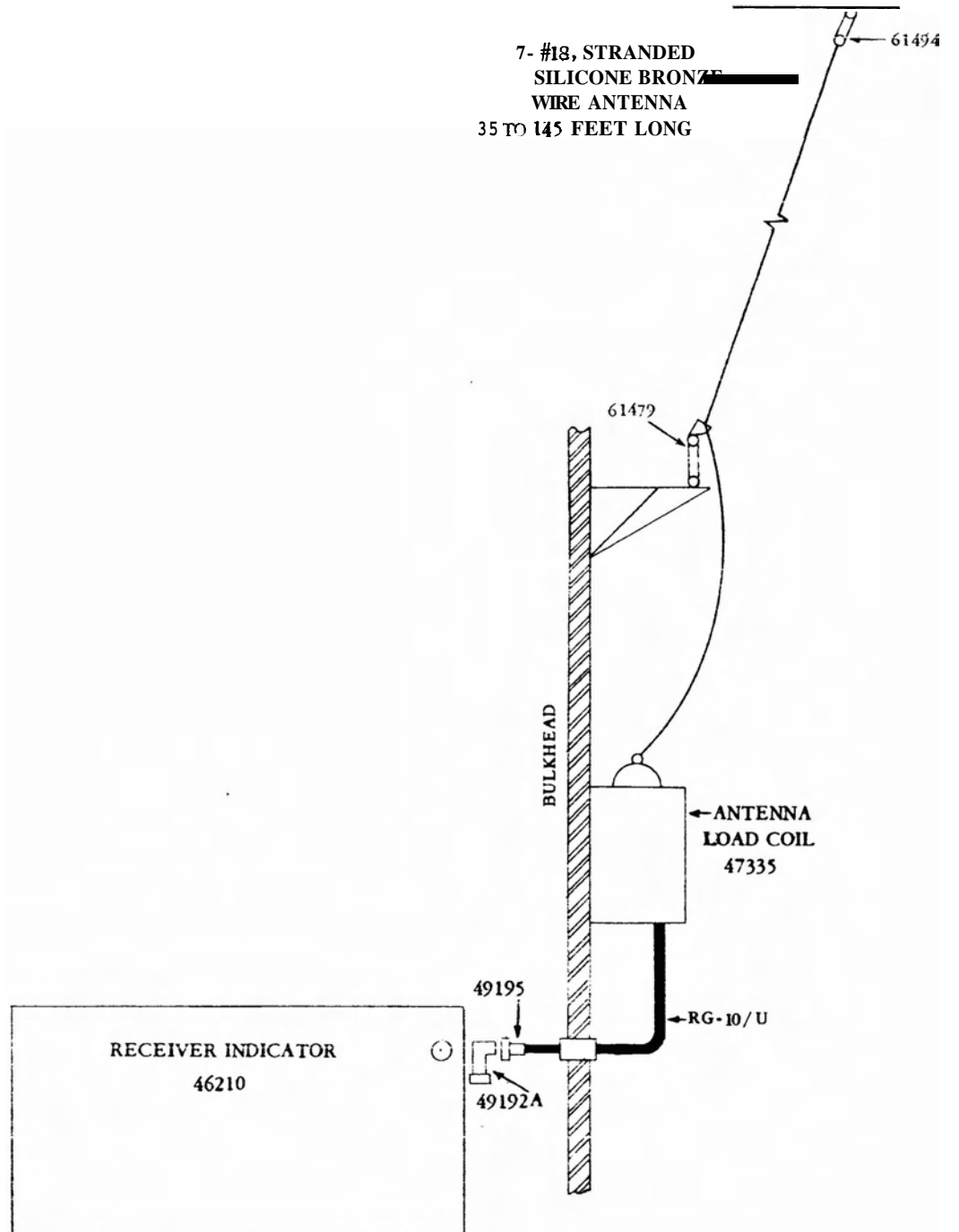

TYPICAL SHIPBOARD ANTENNA SYSTEM FOR DAS RECEIVER INDICATOR

BILL OF MATERIALS

Name	Type	No. Req'd	Standard Navy Stock Number	Instruction Book, Specification or Drawing
Indicator-Receiver DAS	46210	1	16-R-32497-174	1 Ship's 225A
Antenna Loading Coil	47335	1	16-C-75321-4641	Ship's 225A
Wire Rope Vertical Antenna	7-#18 Silicone Bronze	1		
RF Cable	RG-10/U		G15-C-12200-625	JAN-C-17A
Connector, plug	49195	1	17-C-71414-280	CRE 49F 167
Connector, adapter	49192A	1	17-C-674441300	RE 49F 168
Insulators	61494	1	N17-1-72547-3001	RE 61AA 301
	61479	1	N17-I-72505-3001	RE 61AA 299

June 30, 1954

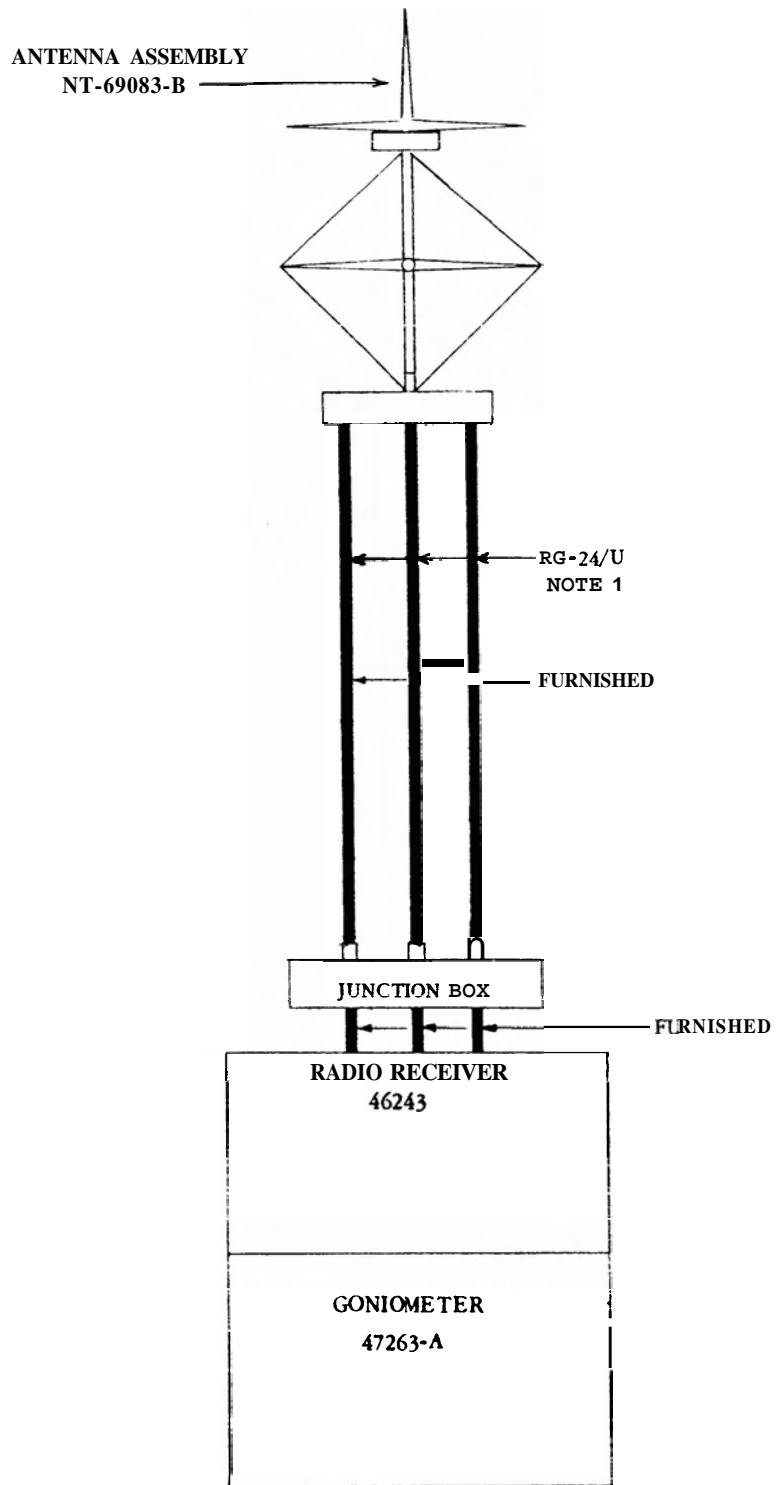

TYPICAL SHIPBOARD ANTENNA SYSTEM FOR DAU RADIO DIRECTION FINDER

BILL OF MATERIALS

Name	Type	No. Req'd	Standard Navy Stock Number	Instruction Book, Specification or Drawing
Radio Receiver	CFT-46243	1	16-R-32164-2371	NavShips 900,801
Goniometer	CFT-47263-A	1	16-G-77108-5651	NavShips 900,801
Antenna Assembly	CFT-69083B	1	F16-A-55223-570C	NavShips 900,801
RF Cable	RG-24/U		15-C-12217-75	JAN-C-17A
Junction Box		1		

NOTES

1. The three pieces of **RG-24/U** are to be of the same electrical length,
2. The DAQ is installed in the same manner.

June 30, 1954

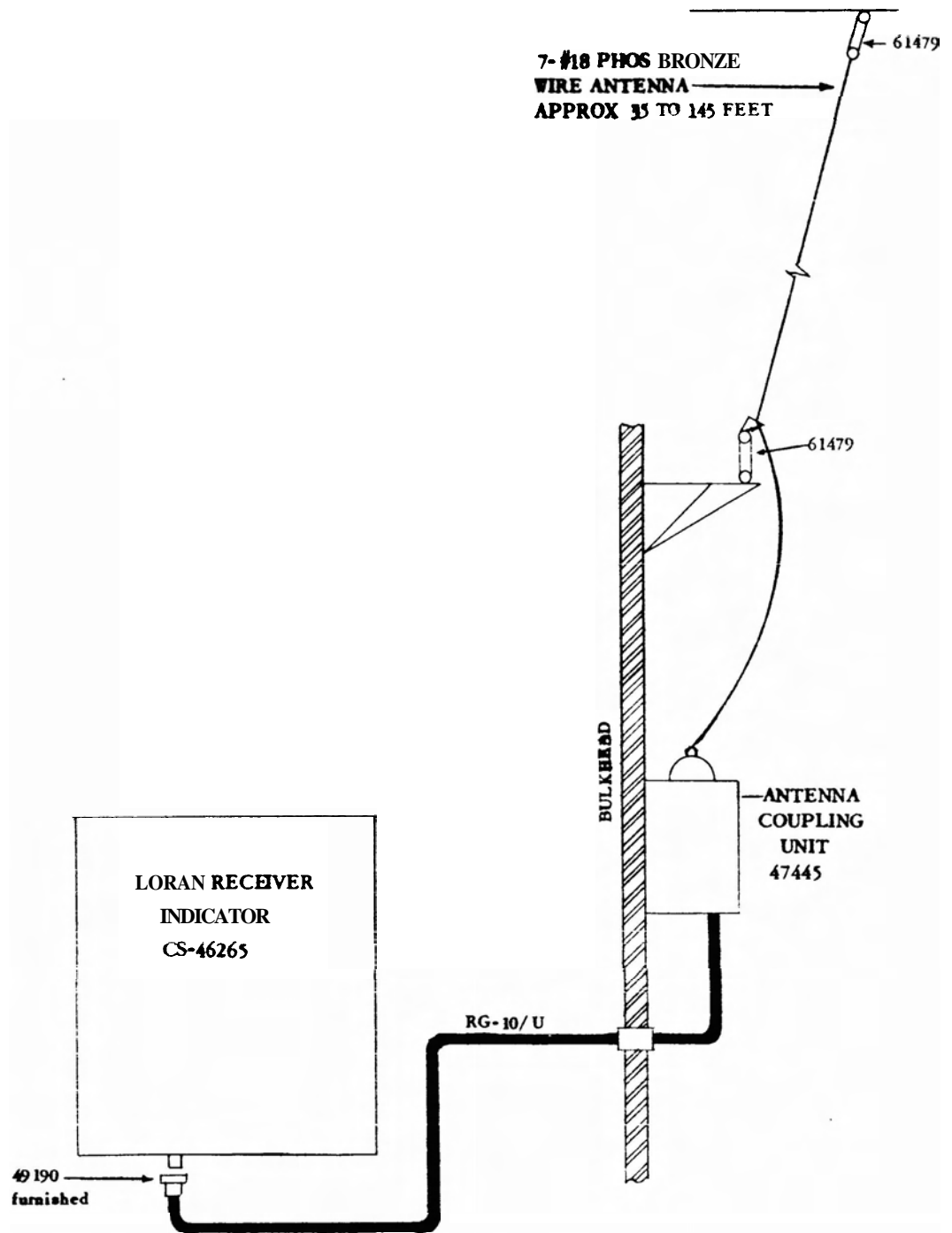

TYPICAL SHIPBOARD ANTENNA SYSTEM FOR DBE LORAN EQUIPMENT

BILL OF MATERIALS

Name	Type	No. Req'd	Standard Navy Stock Number	Instruction Book, Specification or Drawing
Receiver - Indicator DBE	46265	1	16-R-32497-1749	NavShips 900,659
Antenna Coupling Unit	47445	1	16-C-91718-8081	NavShips 900,659
Wire Rope Vertical Antenna	7-#18 Phos Bronze	1	N16-W-3740-1	MIL-W-17211
RF Cable	RG-10/U		G15-C-12200-625	JAN-C-17A
Insulator	61479	1	N17-I-72505-3001	R E 61AA 299

Jun 30, 1954

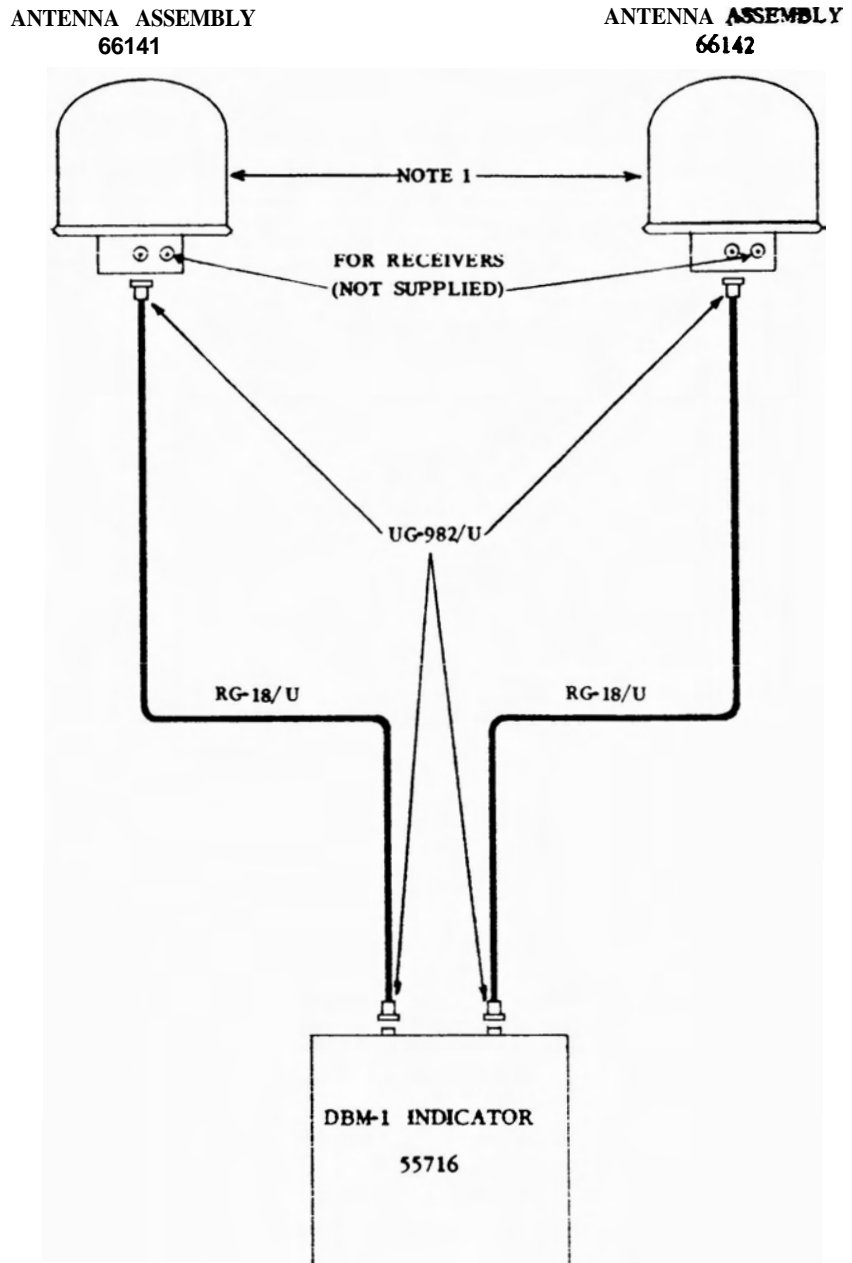

TYPICAL SHIPBOARD ANTENNA SYSTEM FOR DBM-1 EQUIPMENT

BILL OF MATERIALS

Name	Type	No. Req'd	Standard Navy Stock Number	Instruction Book, Specification or Drawing
Direction Finder DBM-1	55176	1	16-C-90341-109	NavShips 900, 587A
Antenna Assembly	66141	1	F16-A-55226-1025	NavShips 900, 587A
Antenna Assembly	66142	1	F16-A-55287-8301	NavShips 900, 587A
R F Cable	RG-18/U		G15-C-12200-750	JAN-C-17A
Connector, plug*	UG-982/U	4		

* Consists of ~~UG-167D/U~~ Connector plus Armor Clamp MX-1441/U.

NOTES

1. Antenna Assembly 66141 is for low frequencies, 90-1200 mc and Antenna Assembly 66142 is for high frequencies, 1000-5000 mc.

June 30, 1954

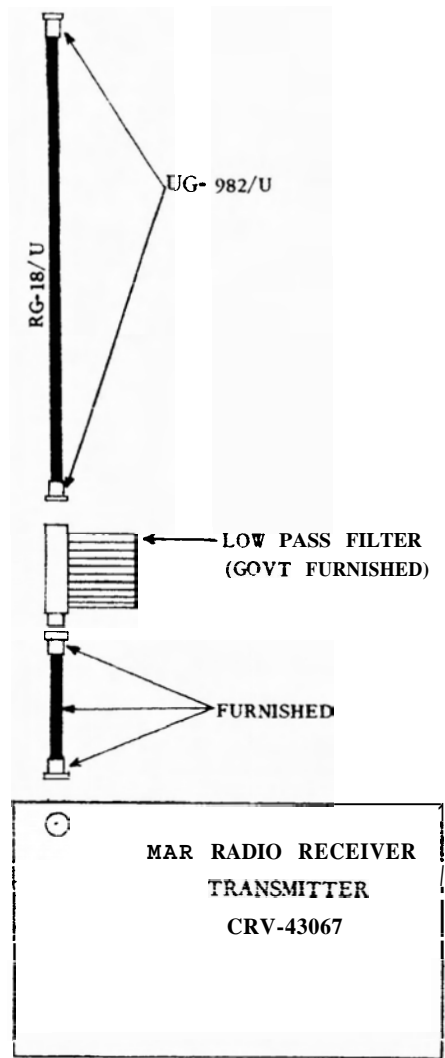
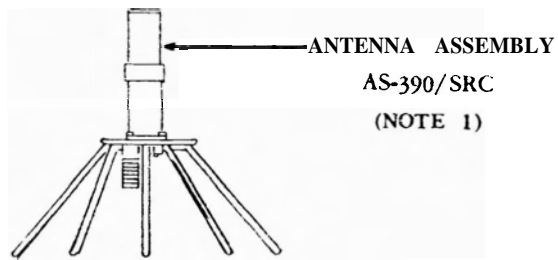

TYPICAL SHIPBOARD ANTENNA SYSTEM FOR MAR RADIO EQUIPMENT

BILL OF MATERIALS

Name	Type	No. Req'd	Standard Navy Stock Number	Instruction Book, Specification or Drawing
MAR Radio Receiver - Transmitter	CRV-43067		16-R-35360-8004	NavShips 900,719(A)
Antenna Assembly	AS-390/SRC	1	F16-A-53590-1001	NavShips 91338
RF Cable	RG-18/U		G15-C-12200-750	JAN-C-17A
Connector, plug*	UG-982/U	2		RE 49D 215

* Consists of UG-167D/U connector plus Armor Clamp. MX-1441/U.

NOTES

1. Antenna AT-150/SRC can also be used with Receiver - Transmitter CRV-43067.

June 30, 1954

6-86

UNCLASSIFIED

ORIGINAL

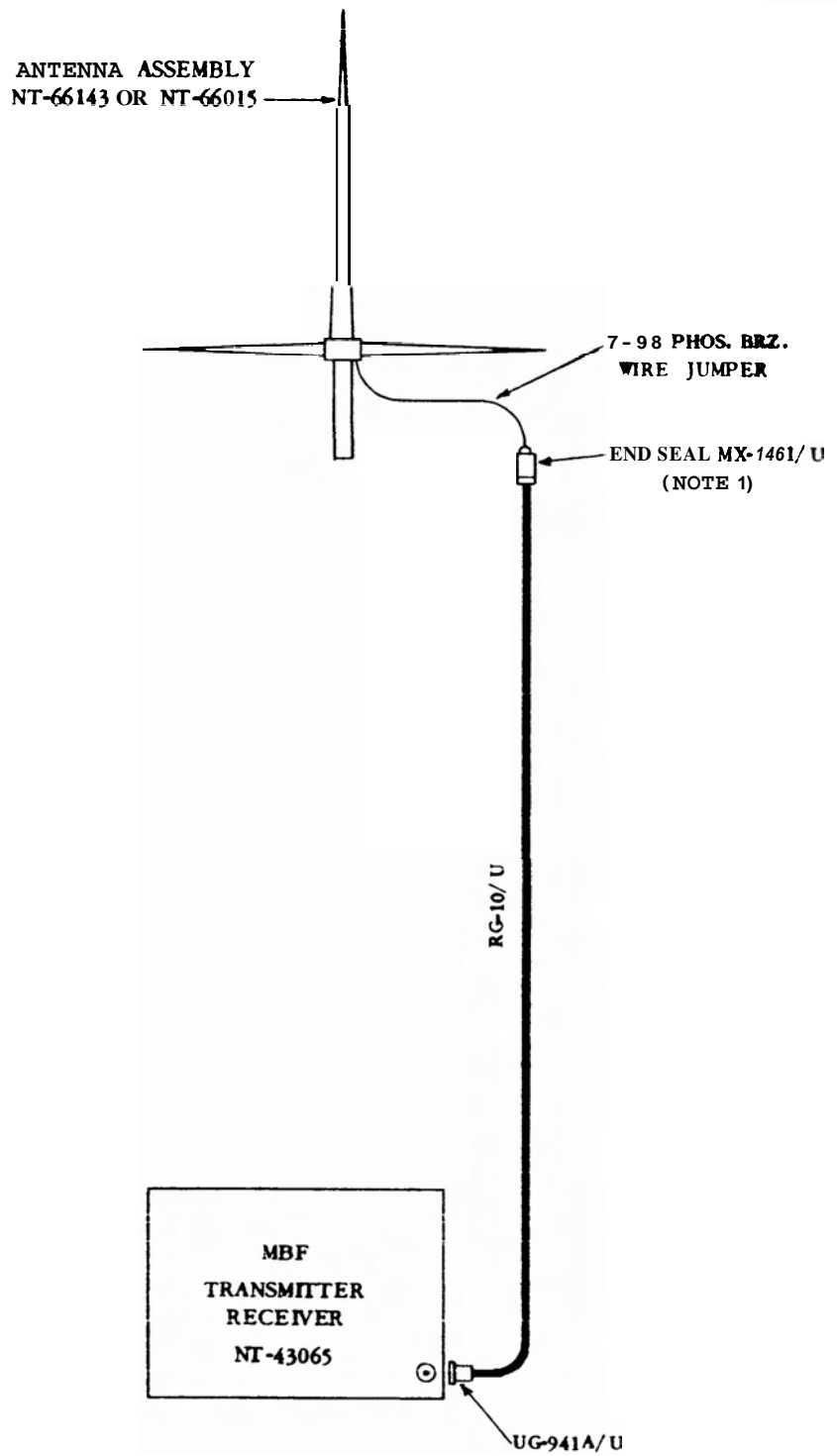

TYPICAL SHIPBOARD ANTENNA SYSTEM FOR MBF RADIO EQUIPMENT

BILL OF MATERIALS

Name	Type	No. Req'd	Standard Navy Stock Number	Instruction Book, Specification
MBF Transmitter-Receiver	43065	1	16-R-35395-8703	NavShips 900,508 NavShips 95134
Antenna Assembly	66143 or 66015	1	6-A-52273-2501 F16-A-53581-6301	NavShips 900,590
RF Cable	RG-10/U		G15-C-12200-625	JAN-C-17A
Wire Jumper	7-#18 Phos Brz		N16-W-3740-1	MIL-W-17211
End Seal	MX-1461/U	1		RE 49D 237
Connector, plug*	UG-941A/U	1		

* Consists of **UG-21D/U** Connector plus Armor Clamp, **MX-1286/U**.

NOTES

1. Ground end seal lug to ground plane elements.
2. **RG-18/U** may be used in place of **RG-10/U** if length of RF line causes an excessive attenuation.

June 30, 1954

6-88

UNCLASSIFIED

ORIGINAL

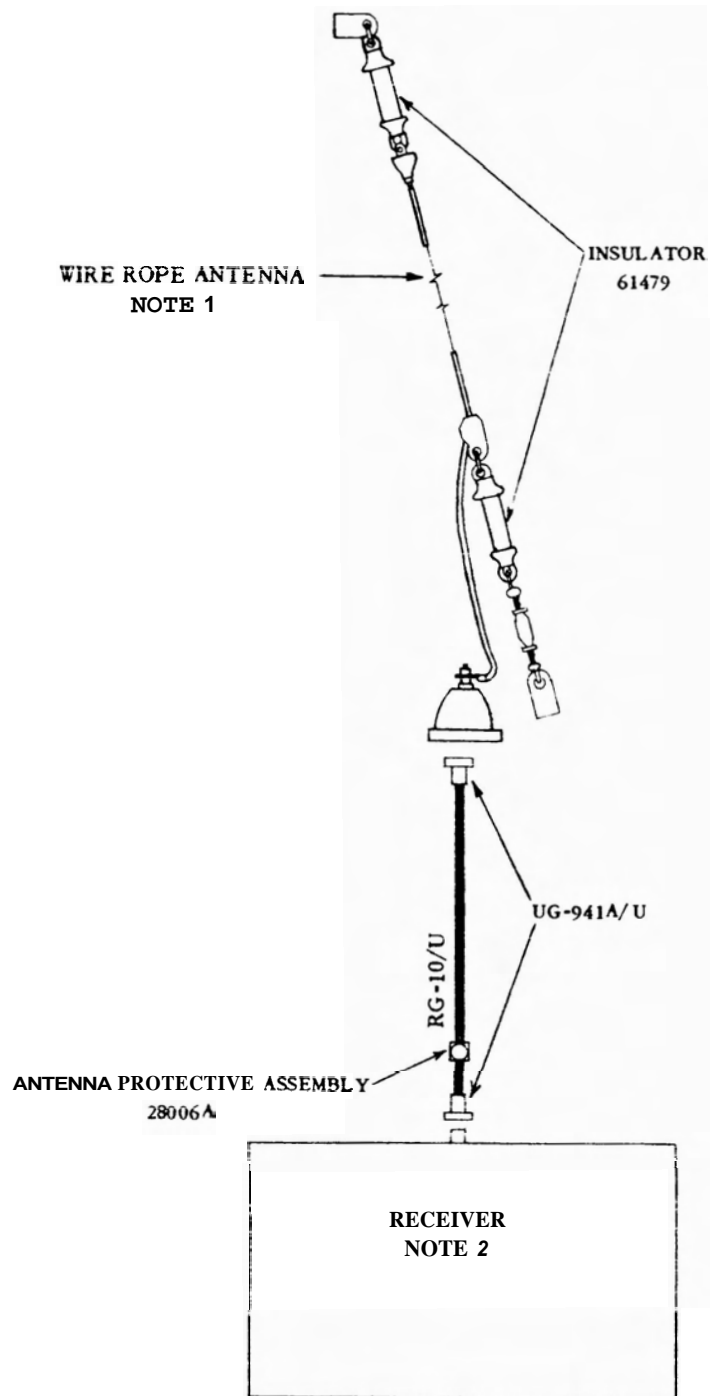

TYPICAL SHIPBOARD ANTENNA SYSTEM FOR RADIO RECEIVERS

BILL OF MATERIALS

Name	Type	No. Req'd	Standard Navy Stock Number	Instruction Book, Specification or Drawing
Receiver		1		
Wire Rope Antenna	Receiving	1		NavShips 900, 121(A) Chapter 2
RF Cable	RG-10/U		G15-C-12200-625	JAN-C-17A
Connector, plug*	UG-941A/U	2		
Insulator	NT-61479	2	N17-I-72505-3001	RE 61AA 299
Antenna Protective Assembly	NT-28006A	1		RE 28J 119

* Consists of **UG-21D/U** Connector plug Armor Clamp MX-1286/U.

NOTES

1. For details of this receiving antenna refer to Chapter 2 (page 28 and page 38) of this manual.
2. This installation may be applied to the following receivers, RAO, RBA, RBB, RBC, RBH, RBL, RBM, RBO, RBS, RAK, RAL, AN/SRR-11, AN/SRR-12, AN/SRR-13.

June 30, 1954

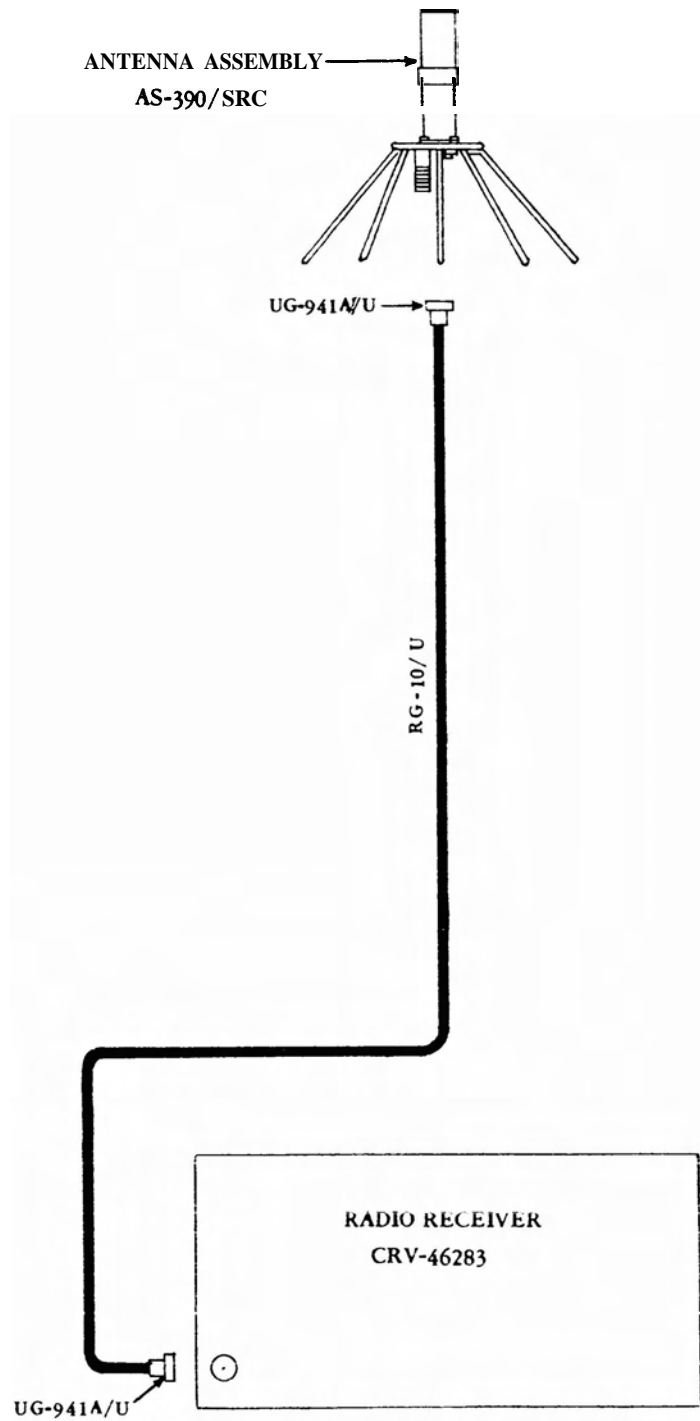

TYPICAL SHIPBOARD ANTENNA SYSTEM FOR RADIO RECEIVER RDR

BILL OF MATERIALS

Name	Type	No. Req'd	Standard Navy Stock Number	Instruction Book, Specification or Drawing
Radio Receiver RDR	46283	1	16-R-31680-9561	NavShips 900, 841(A)
Antenna Assembly	AS-390/SRC	1	F16-A-53590-1001	NavShips 91338
RF Cable	RG-10/U		G15-C-12200-625	JAN-C-17A
Connector, plug*	UG-941A/U	2		

* Consists of UG-21D/U Connector with Armor Clamp, MX-1286 /U.

NOTES

1. RG-18/U may be used in place of RG-10/U if the length of RF line causes an excessive attenuation.

June 30, 1954

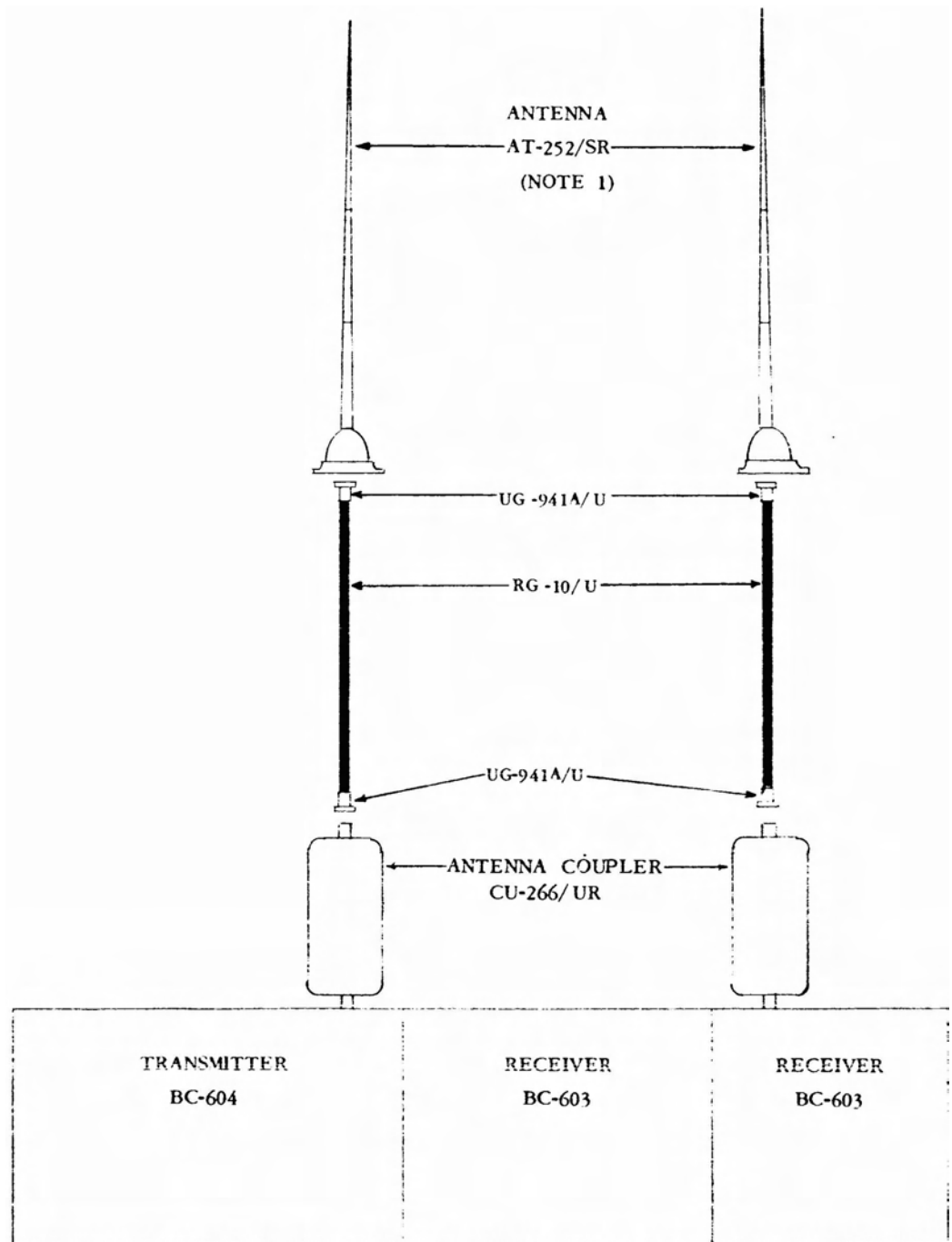

TYPICAL SHIPBOARD ANTENNA SYSTEM FOR RADIO SETS SCR-508 AND SCR-528

BILL OF MATERIALS

Name	Type	No. Req'd	Standard Navy Stock Number	Instruction Book, Specification or Drawing
SCR-508 Transmitter	BC-604	1		TM11-600
SCR-508 Receiver	BC-603	2		TM11-600
Antenna	AT-252/SR	2	N16-A-54463-5150	NavShips 91292
Antenna Coupler	CU-266/UR	2	N16-C-91727-9345	NavShips 91292
RF Cable	RG-10/U		G15-C-12200-625	JAN-C-17A
Connector, plug*	UG-941A/U	4		

* Consists of UG-21D/U Connector plus Armor Clamp, MX-1286/U.

NOTES

1. For Radio Set SCR-508 use full length of Antenna AT-252/SR (125").

June 30, 1954

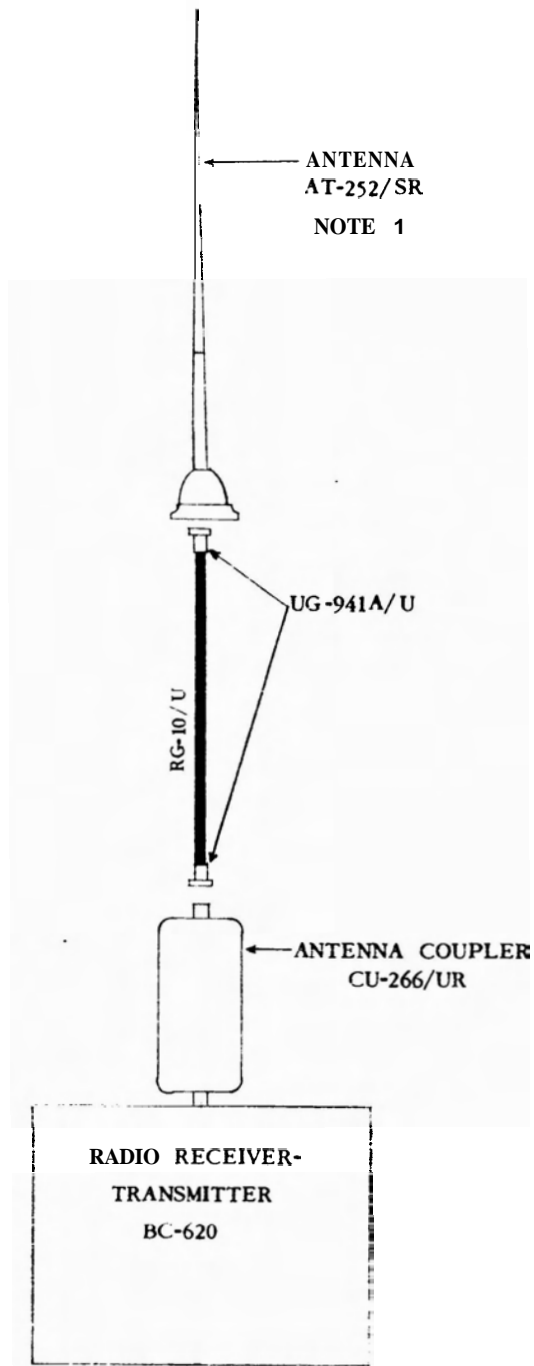

TYPICAL SHIPBOARD ANTENNA SYSTEM FOR RADIO SET SCR-510

BILL OF MATERIALS

Name	Type	No Req'd	Standard Navy Stock Number	Instruction Book, Specification
SCR-510 Trans-Receiver	BC-620	1		TM11-605
Antenna	AT-252/SR	1	N16-A-54463-5150	NavShips 91232
Antenna Coupler	CU-266/UR	1	N16-C-91727-9345	NavShips 91292
RF Cable	RG-10/U		G15-C-12200-625	JAN-C-17A
Connector, plug*	UG-941A/U	2		

* Consists of ~~UG-21D/U~~ Connector plus Armor Clamp ~~MX-1286/U~~.

NOTES

1. For Radio Set **SCR-510** use full length of Antenna **AT-252/SR** (125").

June 30, 1954

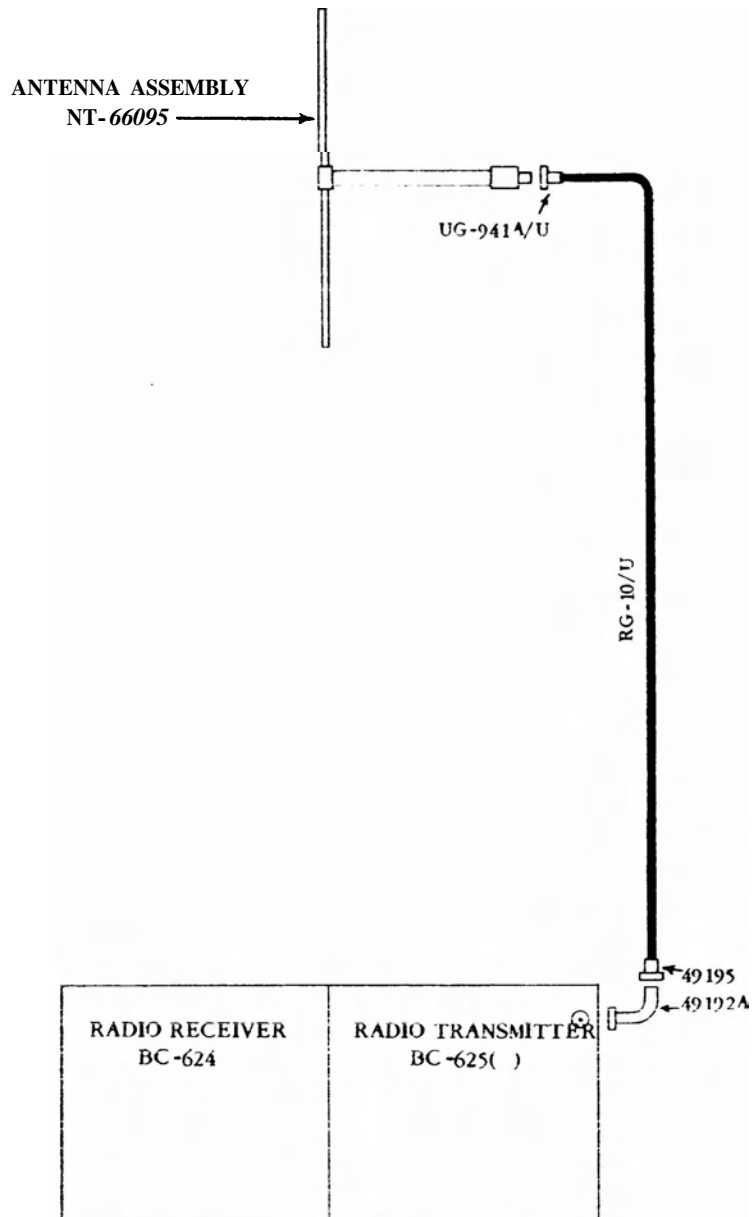

TYPICAL SHIPBOARD ANTENNA SYSTEM FOR RADIO SET SCR-522

BILL OF MATERIALS

Name	Type	No. Req'd	Standard Navy Stock Number	Instruction Book, Specification or Drawing
Transmitter SCR-522	BC-625	1		T. O. No. 08-10-105
Receiver SCR-522	BC-624	1		T. O. No. 08-10-105
Antenna Assembly	NT-66095	1	F16-A-48586-5351	NavShips 900,474
R F Cable	RG-10/U		G15-C-12200-625	JAN-C-17A
Connector, Plug*	UG-941A/U	1		
Connector, Plug	NT-49195	1	17-C-714142800	RE 49F 167
Right Angle Adapter	NT-49192A	1	17-C-67444-1300	RE 49F 168

* Consists of **UG-21D/U** Connector, plus Armor Clamp **MX-1286/U**.

June 30, 1954

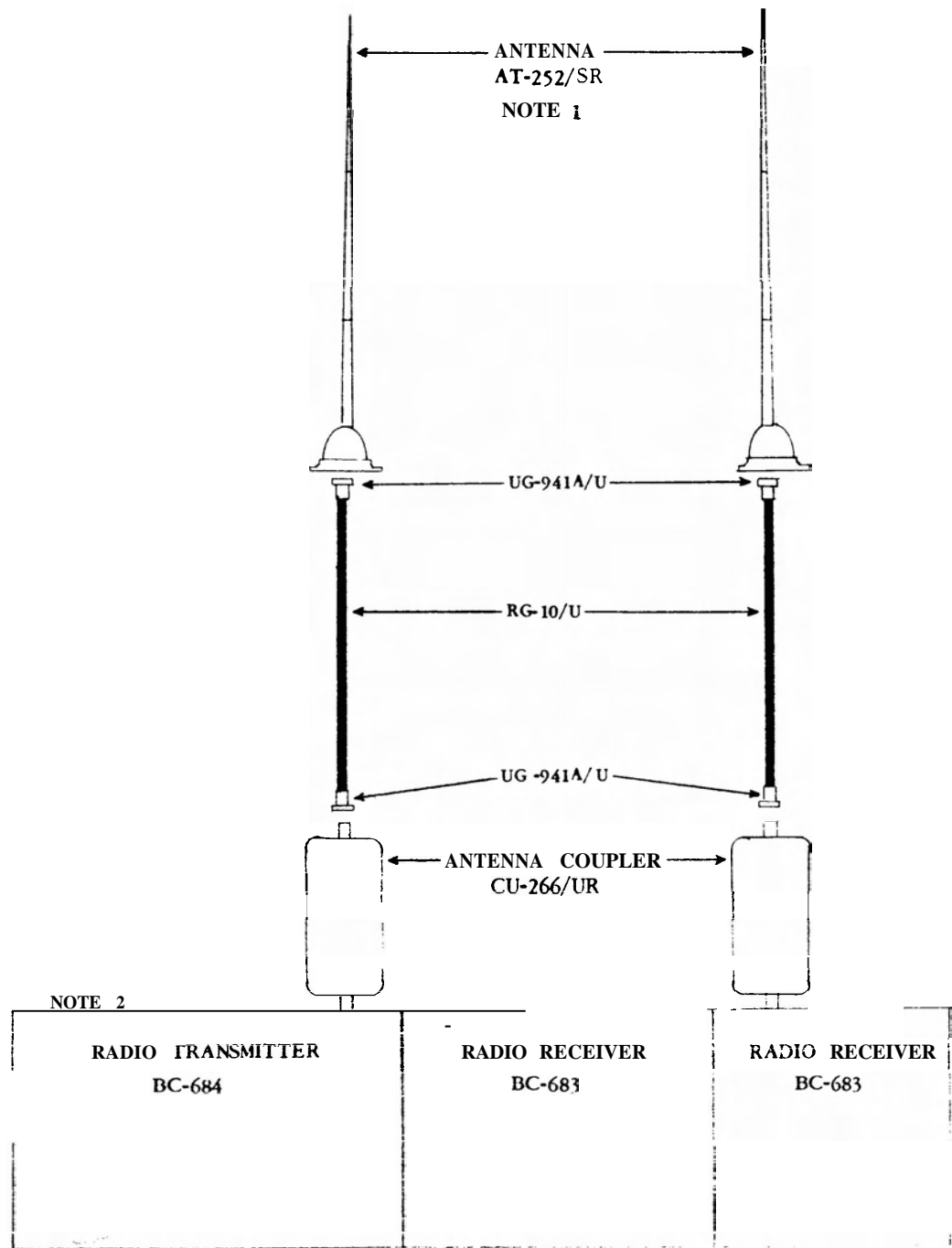

TYPICAL SHIPBOARD ANTENNA SYSTEM FOR RADIO SETS SCR-608 AND SCR-628

BILL OF MATERIALS

Name	Type	No. Req'd	Standard Navy Stock Number	Instruction Book, Specification or Drawing
SCR-608, 628 Transmitter	BC-684	1		TM11-620
SCR-608, 628 Receiver	BC-683			TM11-620
Antenna	AT-252/SR		N16-A-54463-5150	NavShips 91292
Antenna Coupler	CU-266/UR		N16-C-91727-9345	NavShips 91292
R F Cable	RG-10/U		G15-C-12200-625	JAN-C-17A
Connector, plug*	UG-941A/U			

* Consists of UG-~~21D~~/U Connector plus Armor Clamp, MX-1286/U.

NOTES

1. For Radio Sets SCR-608 and SCR-628 cut Antenna AT-252/SR to 89" in length.
2. Radio Set SCR-608 consists of Transmitter BC-684, two Receivers BC-683 and two antennas and couplers. Radio Set SCR-628 consists of Transmitter BC-684, one Receiver BC-683 and one antenna and coupler.

June 30, 1954

6-100

UNCLASSIFIED

ORIGINAL

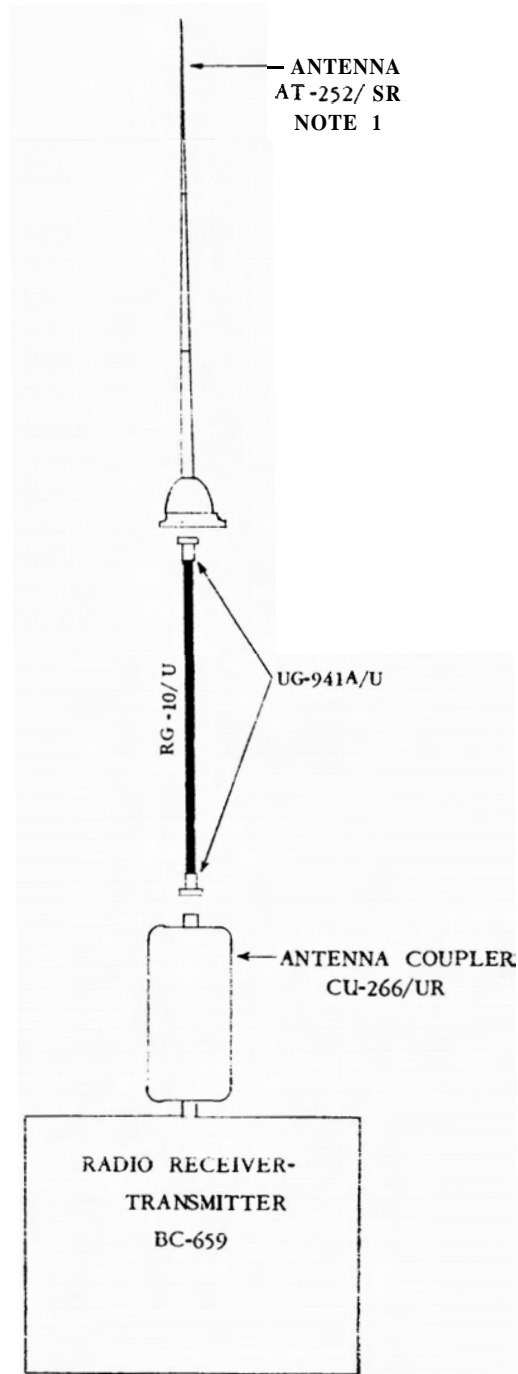

TYPICAL SHIPBOARD ANTENNA SYSTEM FOR RADIO SETS SCR-609 AND SCR-610

BILL OF MATERIALS

Name	Type	No. Req'd	Standard Navy Stock Number	Instruction Book, Specification or Drawing
SCR-609, 610 Trans-Receiver	BC-659	1		TM11-615
Antenna	AT-252/SR	1	N16-A-54463-5750	NavShips 91292
Antenna Coupler	CU-266/UR	1	N16-C-91727-9345	NavShips 91292
RF Cable	RG-10/U		G15-C-12200-625	JAN-C-17A
Connector, plug*	UG-941A/U	2		

* Consists of UG-21D/U connector plus Armor Clamp, MX-1286/U.

NOTES

1. For Radio Sets SCR-609 and SCR-610 cut Antenna AT-252/SR to 89" in length.

June 30, 1954

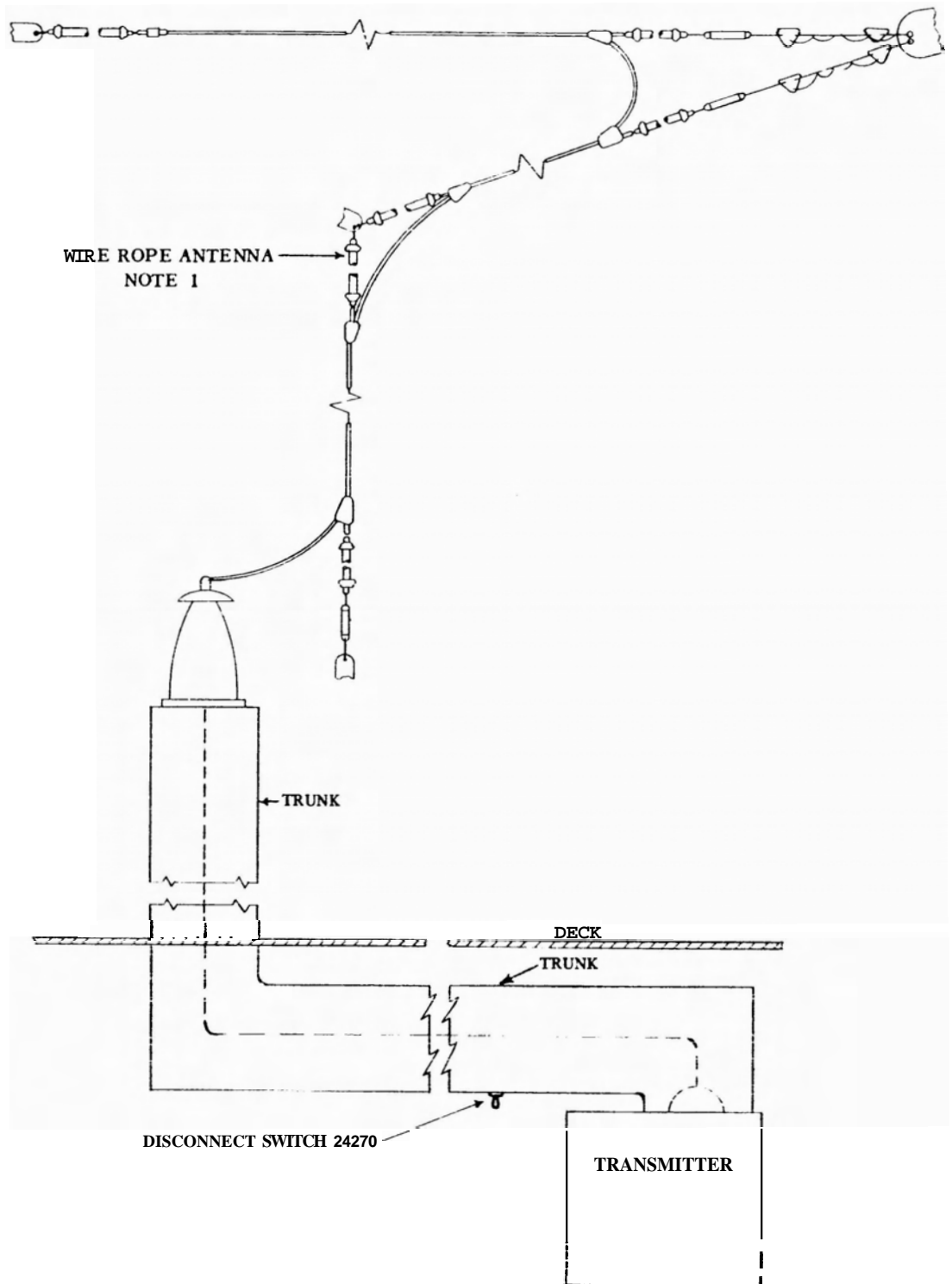

TYPICAL SHIPBOARD ANTENNA SYSTEM FOR RADIO TRANSMITTERS

BILL OF MATERIALS

Name	Type	Nº. Req'd	Standard Navy Stock Number	Instruction Book, Specification or Drawing
Transmitter		1		
Wire Rope Antenna	Transmitting	1		NavShips 900,121(A) Chapter 2

NOTES

1. For details of this transmitting antenna refer to Chapter 2 (pages 54, 57, 59 and 60).of this manual.
2. For antenna trunk size and details refer to Chapter 2 (pages 54, 55 and 56) of this manual.

June 30, 1954

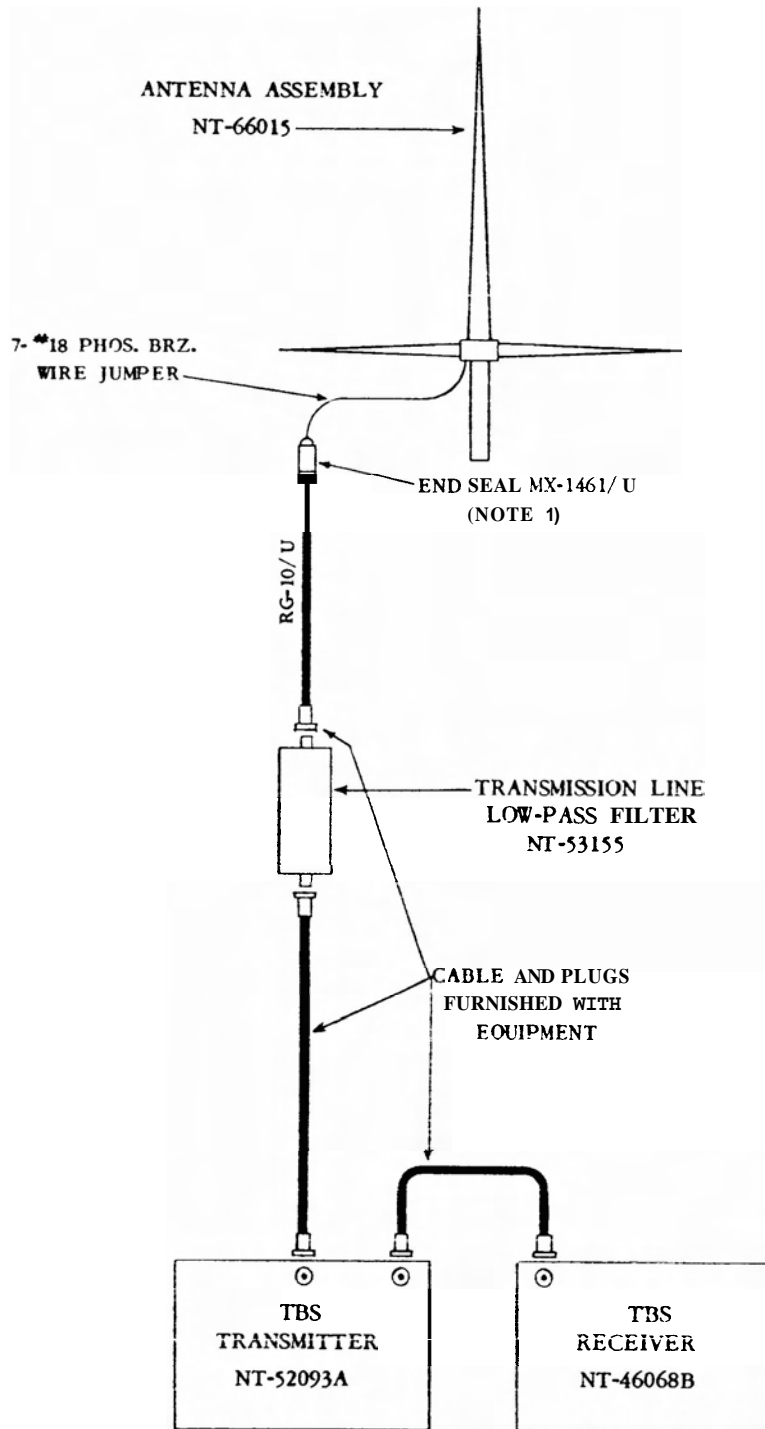

TYPICAL SHIPBOARD ANTENNA SYSTEM FOR TBS RADIO EQUIPMENT

BILL OF MATERIALS

Name	Type	No. Req'd	Standard Navy Stock Number	Instruction Book, Specification or Drawing
TBS Transmitter	52093A	1	F16-T-37247-8915	NavShips 900, 590
TBS Receiver	46068B	1	F16-R -31654-7819	NavShips 900,590
Low-Pass Filter	53155	1	N16-F-2785 (ESO Stock No.)	RA 53F 205C
Antenna Assembly	66015	1	F16-A-535814301	NavShips 900,590
RF Cable	RG-10/U		G15-C-12200-625	JAN-C-17A
End Seal	MX-1461/U	1		RE 49D 237
Wire Jumper	7-#18 Phos Brz		N16-W-3740-1	MIL-W-17211

NOTES

1. Ground end seal lug to ground plane elements.

June 30, 1954

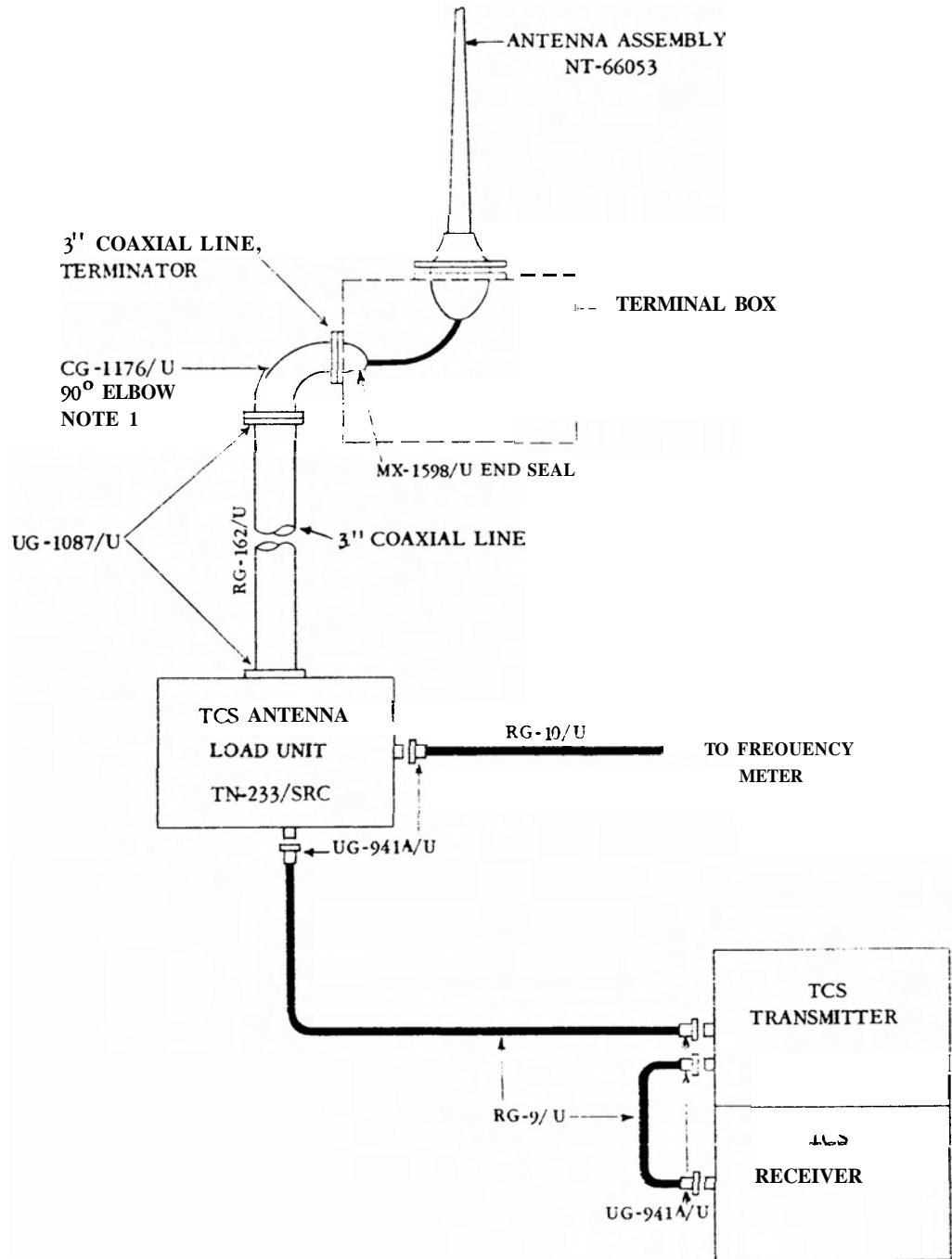

TYPICAL SHIPBOARD ANTENNA SYSTEM FOR TCS RADIO EQUIPMENT

BILL OF MATERIALS

Name	Type	No. Req'd	Standard Navy Stock Number	Instruction Book, Specification or Drawing
TCS Transmitter	52245-A	1	16-T-37676-1333	NavShips 95319
TCS Receiver	46159-A	1	16-R-31924-6276	NavShips 95319
TCS Antenna Loading Unit	TN-233/SRC	1		RE 52C 2010
3" Coaxial Line	RG-162/U	1		RE 52C 2010
3" 90° Elbow	CG-1176/U	1		RE 52C 2010
3" Termination Insulator	MX-1599/U	1		RE 52C 2010
Terminal Box		1		RE 52C 2010
Mast Base		1		RE 52C 2010
Antenna Assembly		1		
R F Cable	RG-9/U		G15-C-12200-500	JAN-C-17A
R F Cable	RG-10/U		G15-C-12200-625	JAN-C-17A
Connector, plug*	UG-941A/U	5		

* Consists of UG-21D/U Connector with Armor Clamp, MX-1286/U

NOTES

1. The 45 degree elbow CG-1177/U may be used in place of the 90 degree elbow, or the installation can be made without any elbow.
2. When it is necessary to pass through a bulkhead use MX-1599/U bulkhead flange.

May 12, 1954

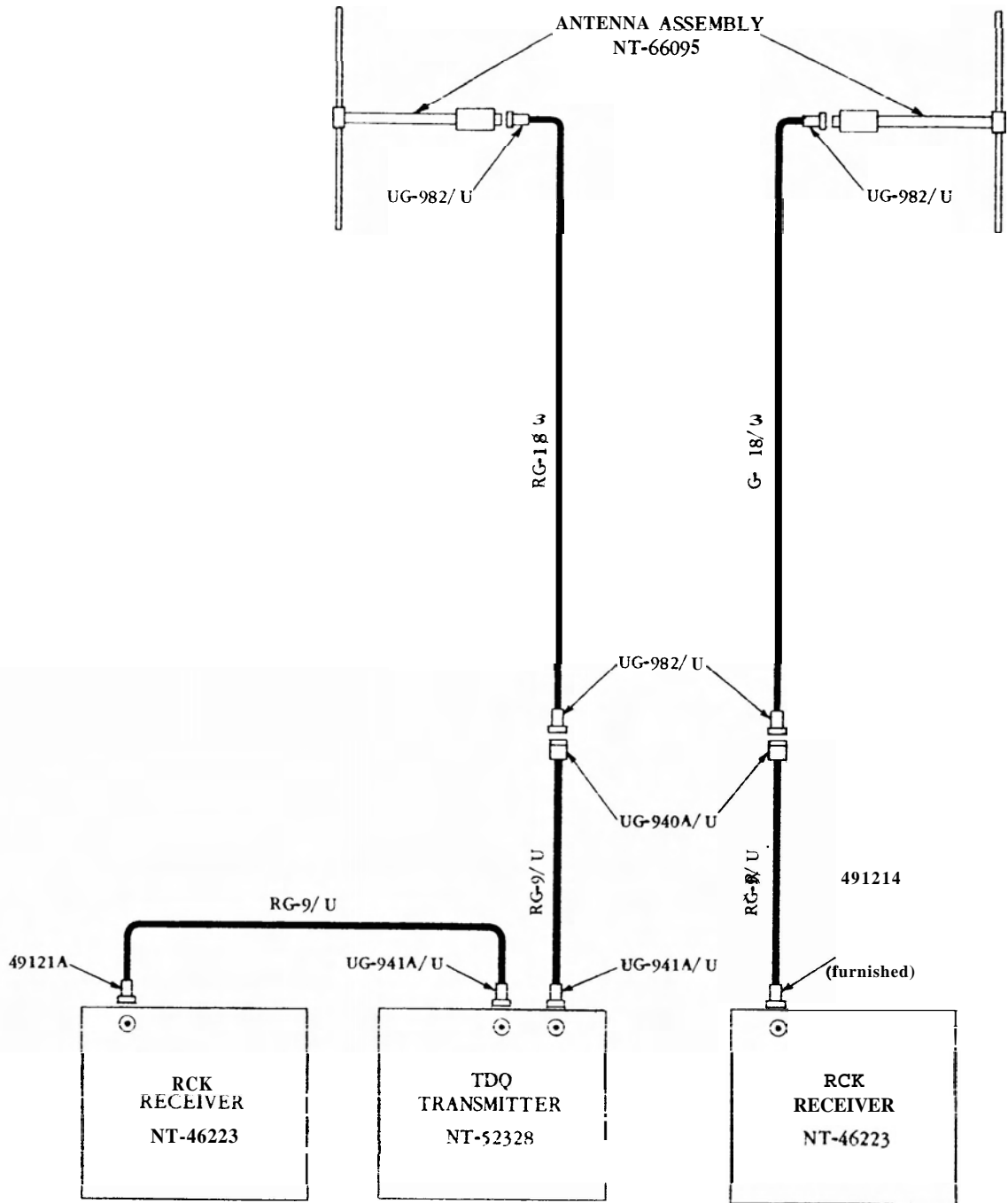

TYPICAL SHIPBOARD ANTENNA SYSTEM FOR TDQ-RCK RADIO EQUIPMENT

BILL OF MATERIALS

Name	Type	No. Req'd	Standard Navy Stock Number	Instruction Book, Specification or Drawing
RCK Receiver	46223	2	F16-R-31669-9573	NavShips 900,288
TDQ Transmitter	52328	1	F17-T-37275-1491	NavShips 900,474
Antenna Assembly	66095	2	F16-A-48586-5351	NavShips 900,474
RF Cable	RG-9/U		G15-C-12200-500	JAN-C-17A
R F Cable	RG-18/U		G15-C-12200-750	JAN-C-17A
Connector, jack *	UG-940A/U	2		
Connector, plug **	UG-941A/U	2		
Connector, plug***	UG-982/U	4		RE 49D 215

- * Consists of UG-23D/U Connector with Armor Clamp, MX-564A/U.
 ** Consists of UG-21D/U Connector with Armor Clamp, MX-1286/U.
 *** Consists of UG-167D/U Connector with Armor Clamp, MX-1441/U.

June 30, 1954

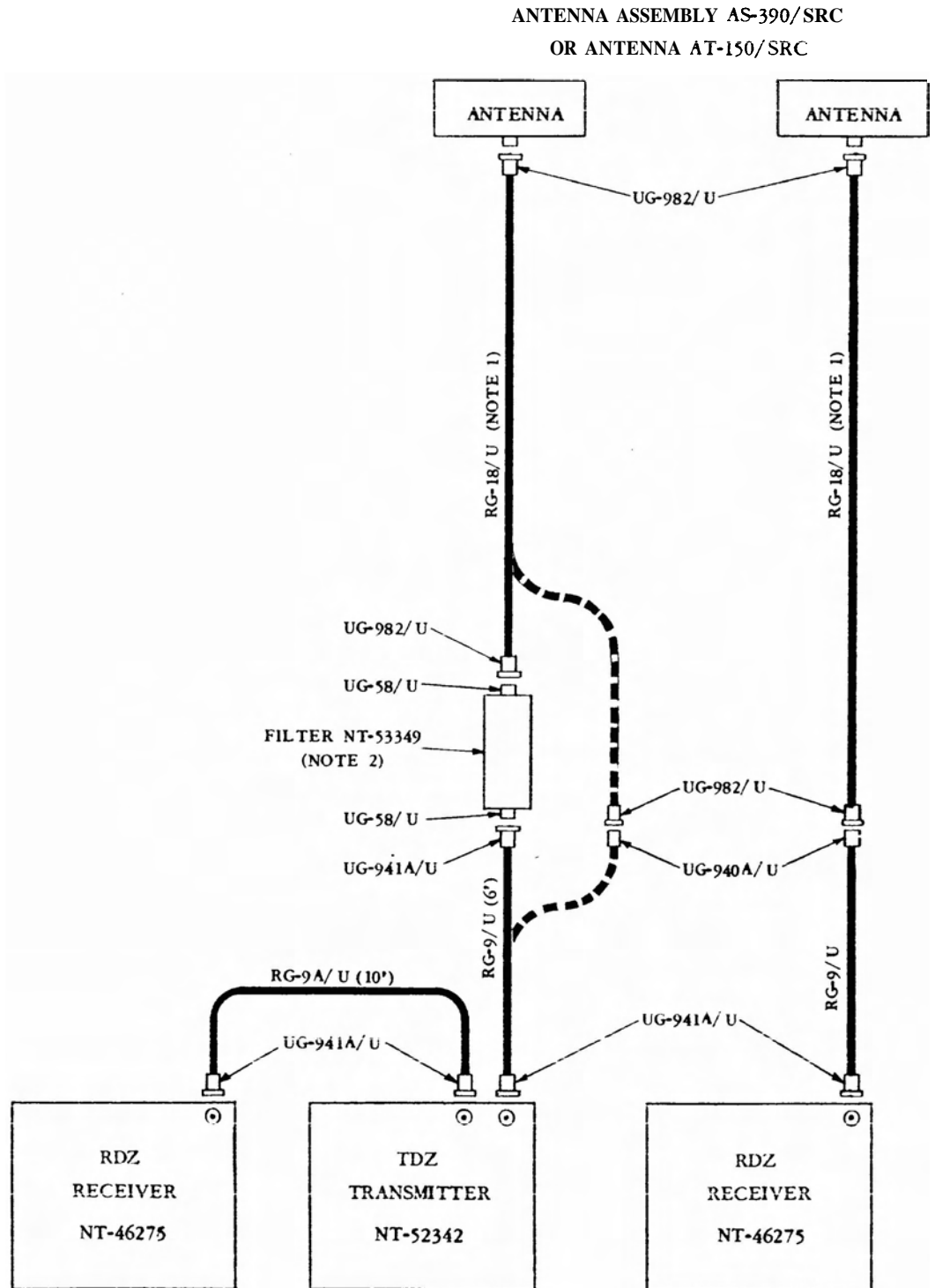

TYPICAL SHIPBOARD ANTENNA SYSTEM FOR-TDZ-RDZ RADIO EQUIPMENT

BILL OF MATERIALS

Name	Type	No. Req'd	Standard Navy Stock Number	Instruction Book, Specification or Drawing
RDZ Receiver	46275	2	F16-R-31678-7491	NavShips 900, 617 NavShips 91338
TDZ Transmitter	52342	1	F16-T-37282-4367	NavShips 900,809
Antenna Assembly	AS-390/SRC	2	F16-A-53590-1001	NavShips 91338
Antenna	AT-150/SRC		F16-A-51990-1201	NavShips 91338
RF Filter	53349	1	N16-F-2748 (ESO Stock No.)	RA 53F 233B
RF Cable	RG-9A/U		G15-C-12200-525	JAN-C-17A
RF Cable	RG-10/U		G15-C-12200-625	JAN-C-17A
RF Cable	RG-18/U		G15-C-12200-750	JAN-C-17A
Connector, jack*	UG-940A/U	2		
Connector, plug**	UG-941A/U	4		
Connector, plug***	UG-982/U	2		RE 49D 215

* Consists of UG-23D/U Connector with Armor Clamp, MX-564A/U.

** Consists of UG-21D/U Connector with Armor Clamp, MX-1286/U.

*** Consists of UG-167D/U Connector with Armor Clamp, MX-1441/U.

NOTES

1. Limit cable length to 200 feet. For short runs (100 feet or less) RG-10/U may be used in place of RG-18/U. UG-941A/U Connector is used with RG-10/U Cable.
2. Filter is used if the harmonic output of the TDZ causes interference on other transmitters or receivers such as radar. If the filter is not used, RG-18/U is used between the antenna and TDZ.

June 30, 1954

ANTENNA ASSEMBLY AS-390/SRC
OR ANTENNA AT-150/SRC

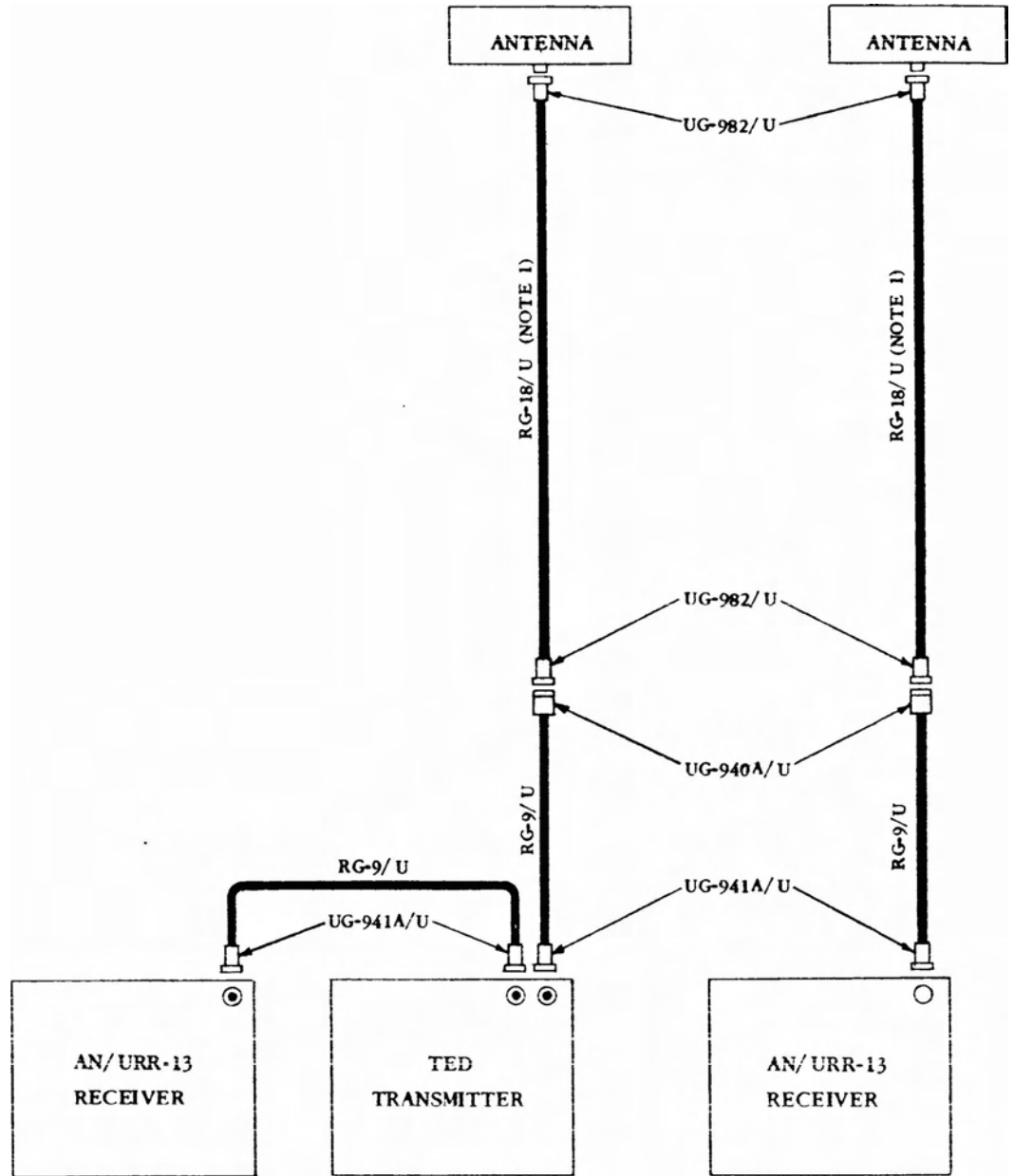

TYPICAL SHIPBOARD ANTENNA SYSTEM FOR TED-AN/URR-13 EQUIPMENT

BILL OF MATERIALS

Name	Type	No. Req'd	Standard Navy Stock Number	Instruction Book, Specification
AN/URR-13 Receiver	R-266/URR-13	2	F16-R-31680-9501	NavShips 91270
TED Transmitter	52373	1	F16-T-37282-4251	NavShips 91357
Antenna Assembly	AS-390/SRC	2	F16-A-53590-1001	NavShips 91338
Antenna	AT-150/SRC		F16-A-51990-1201	NavShips 91338
RF Cable	RG-9/U		G15-C-12200-500	JAN-C-17A
RF Cable	RG-10/U		G15-C-12200-625	JAN-C-17A
RF Cable	RG-18/U		G15-C-12200-750	JAN-C-17A
Connector, jack*	UG-940A/U	2		
Connector, plug**	UG-941A/U	4		
Connector, plug***	UG-982/U	4		RE 49D 215

* Consists of UG-23D/U Connector with Armor Clamp, MX-564A/U.

** Consists of UG-21D/U Connector with Armor Clamp, MX-1286/U.

*** Consists of UG-167D/U Connector with Armor Clamp, MX-1441/U.

June 30, 1954

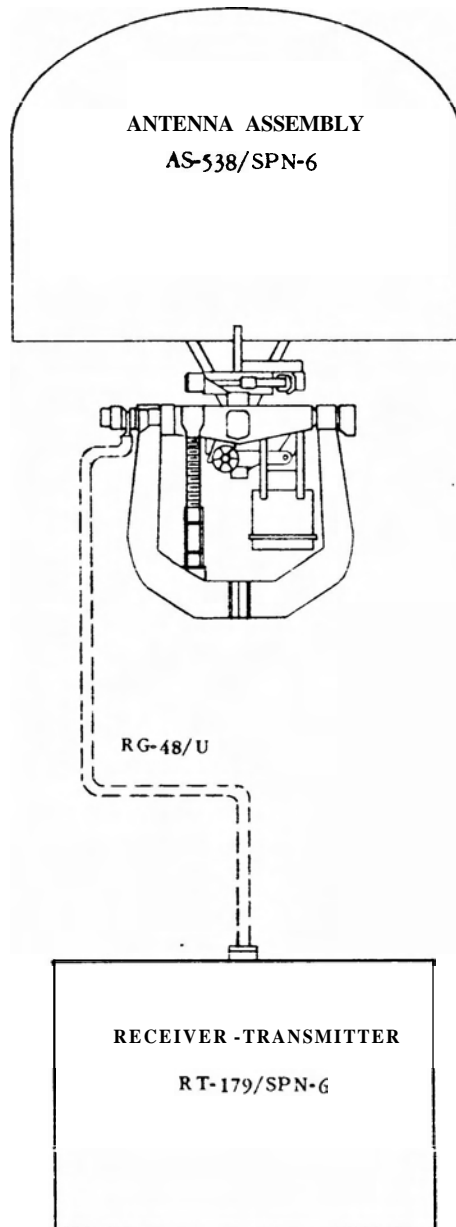

TYPICAL SHIPBOARD ANTENNA SYSTEM FOR RADAR SET AN/SPN-6

BILL OF MATERIALS

Name	Type	No. Req'd	Standard Navy Stock Number	Instruction Book, Specification or Drawing
Antenna Assembly	AS-538/SPN-6	1		NavShips 91810A
Receiver Transmitter	RT-179/SPN-6	1	16R-34974-1001	NavShips 91810A
Waveguide	RG-48/U		ESO N16-W-2375-550	JAN-W-85A

June 30, 1954

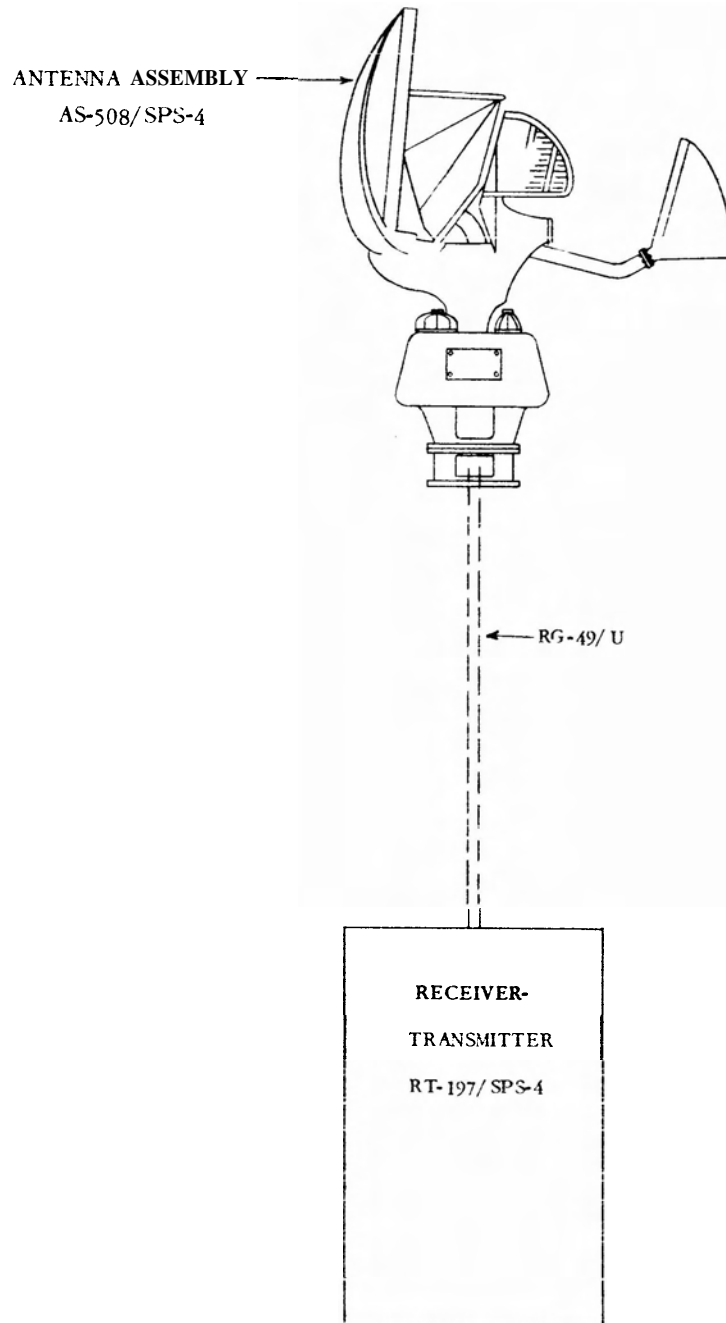

TYPICAL SHIPBOARD ANTENNA SYSTEM FOR RADAR SET AN/SPS-4

BILL OF MATERIALS

Name	Type	No. Req'd	Standard Navy Stock Number	Instruction Book, Specification or Drawing
Antenna Assembly	AS-508/SPS-4	1	16-A-55228-4500	NavShips 91724
Receiver Transmitter	RT-197/SPS-4	1	16-R-35013-3370	NavShips 91724
Waveguide	RG-49/U		16-W-20383-8532	JAN-W-85A

June 30, 1954

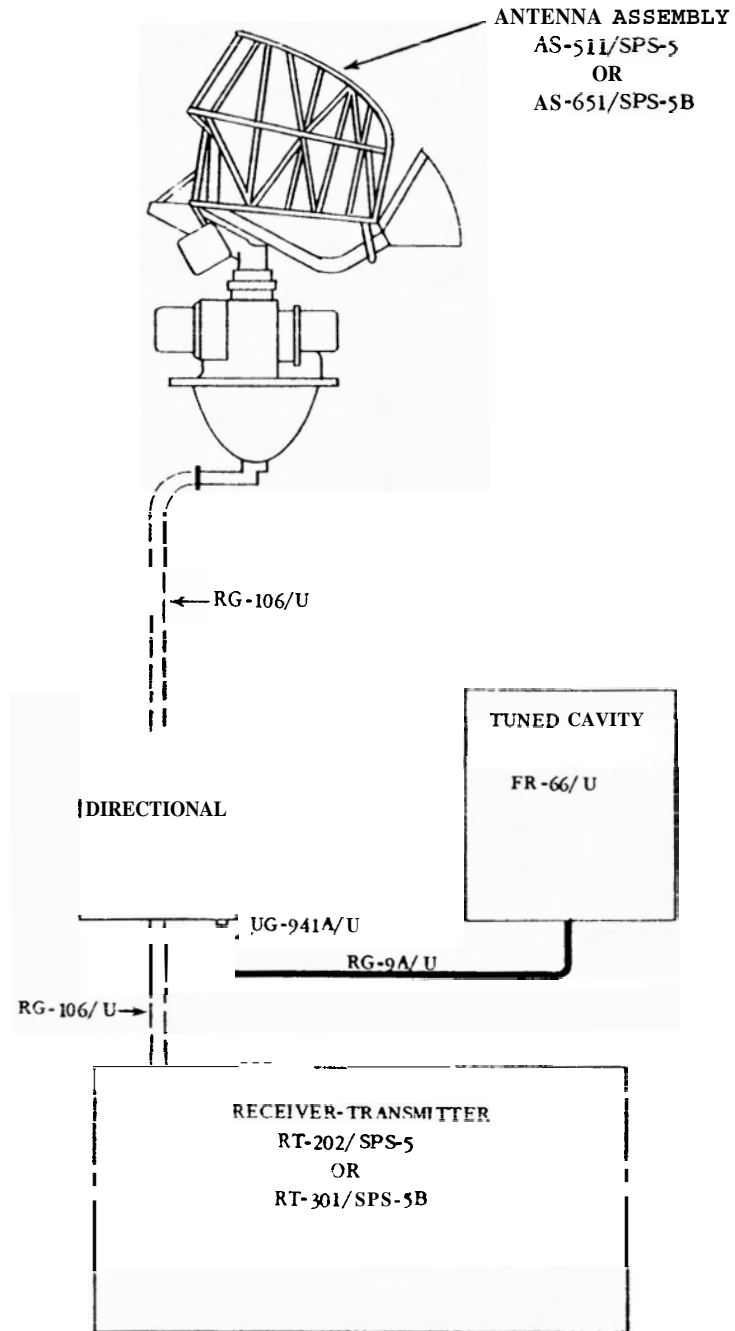

FIGURE 6-11. SHIPBOARD ANTENNA SYSTEM FOR RADAR SET A-5 OR A-5B

BILL OF MATERIALS

Name	Type	No. Req'd	Standard Navy Stock Number	Instruction Book, Specification or Drawing
Antenna Assembly	AS-511/SPS-5		F16-A-53097-9501	NavShips 91634
Antenna Assembly	AS-651/SPS-5B			NavShips 91958
Receiver-Transmitter	RT-202/SPS-6		16-R-35013-3375	NavShips 91634
Receiver-Transmitter	RT-301/SPS-5B			NavShips 91958
Directional Coupler	CU-245/U	1	16-D-57138-7501	NavShips 91634
Tuned Cavity	FR-66/U	1		NavShips 91634
RF Cable	RG-9A/U		G15-C-12200-525	JAN-C-17A
Connector, plug	UG-941A/U	1		
Waveguide	RG-106/U			JAN-W-85A

* Consists of UG-21D/U connector plus Armor Clamp MX-1286/U.

June 30, 1954

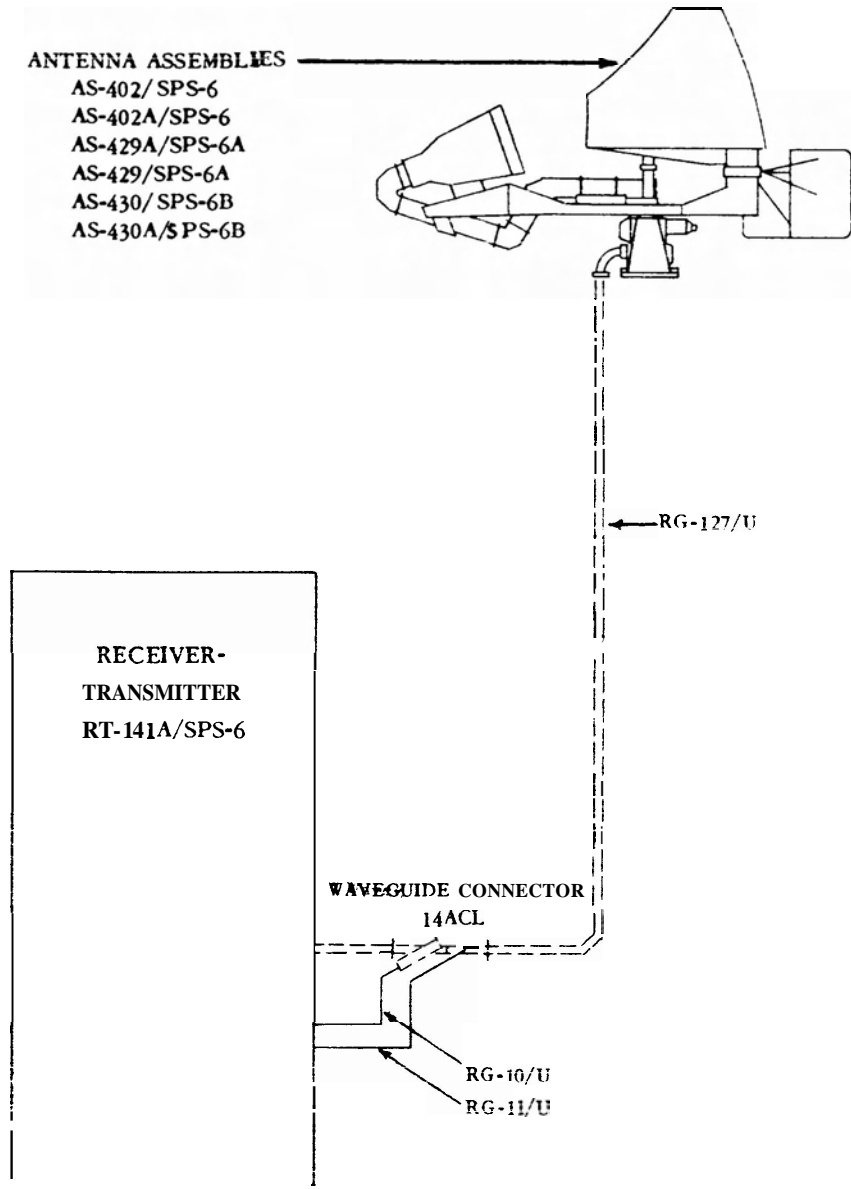
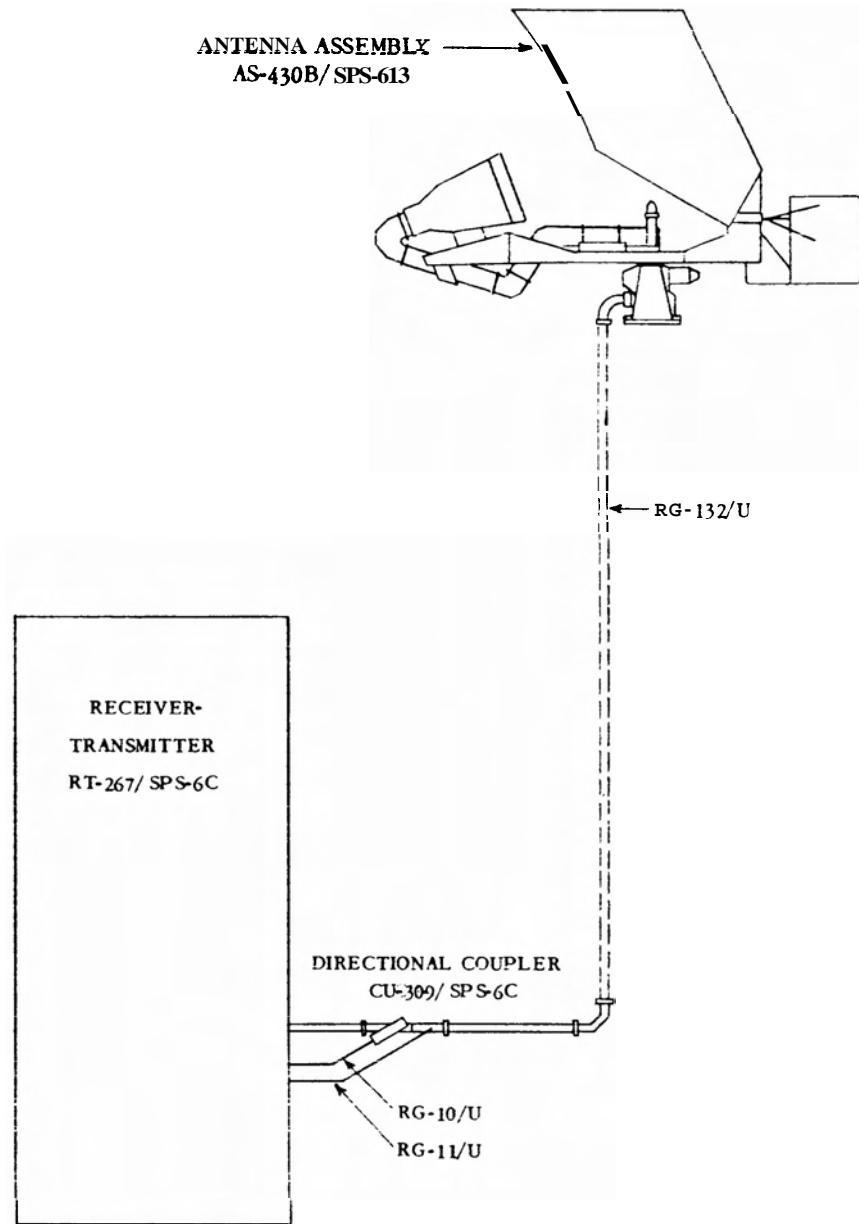

FIGURE 6-12 SHIPBOARD ANTENNA SYSTEM FOR RADAR SETS AN/SPS-6, 6A AND 6B

BILL OF MATERIALS

Name	Type	No. Req'd	Standard Navy Stock Number	Instruction Book, Specification or Drawing
Antenna Assembly	AS-402/SPS-6		F16-52016-2301	NavShips 91801
Antenna Assembly	AS-402A/SPS-6			NavShips 91801
Antenna Assembly	AS-429/SPS-6A			NavShips 91801
Antenna Assembly	AS-429A/SPS-6A			NavShips 91801
Antenna Assembly	AS-430/SPS-6B			NavShips 91801
Antenna Assembly	AS-430A/SPS-6B			NavShips 91801
Receiver-Transmitter	RT-141A/SPS-6		F16-R-35013-3447	NavShips 91801
Waveguide Connector	14ACL		F16-D-57293-8221	NavShips 91801
R F Cable	RG-10/U		G15-C-12200-625	JAN-C-17A
R F Cable	RG-11/U		G15-C-12201-625	JAN-C-17A
Waveguide	RG-127		ESO N16-W-2356-5120	JAN-W-85A

June 30, 1954



TYPICAL SHIPBOARD ANTENNA SYSTEM FOR RADAR SET AN/SPS-6C

BILL OF MATERIALS

Name	Type	No. Req'd	Standard Navy Stock Number	Instruction Book, Specification or Drawing
Antenna Assembly	AS-430B/SPS-6B			NavShips 91620
Receiver Transmitter	RT-267/SPS-6C		F16-B-35001-3401	NavShips 91620
Directional Coupler	CU-309/SPS-6C			NavShips 91620
R F Cable	RG-10/U		G15-C-12200-625	JAN-C-17A
R F Cable	RG-11/U		G15-C-12201-625	JAN-C-17A
Waveguides	RG-132/U			JAN-W-85-9

Jun 30, 1954

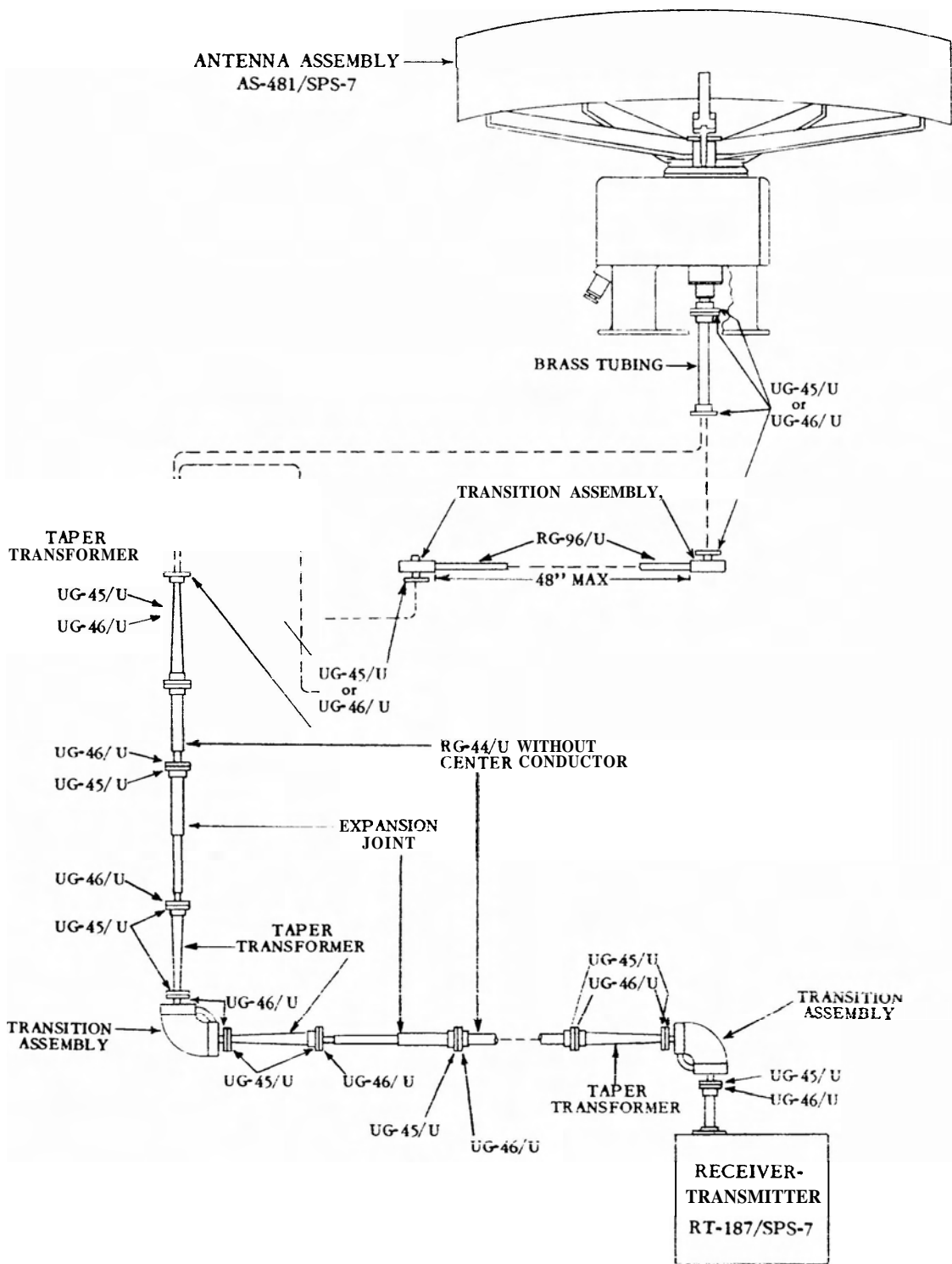

TYPICAL SHIPBOARD ANTENNA SYSTEM FOR AN/SPS-7 RADAR EQUIPMENT

BILL OF MATERIALS

Name	Type	No. Req'd	Standard Navy Stock Number	Instruction Book, Specification or Drawing
Receiver - Transmitter	RT-187/SPS-7	1		NavShips 91324
Antenna Assembly	AS-481/SPS-7	1		
Male Coupling	UG-45/U		17-C-73411-8062	RE 49F 210F
Female Coupling	UG-46/U		17-C-71111-3790	RE 49F 210
Transition Assembly		2		
Transition Assembly		2		
Taper Transformer		4		
Expansion Joint		2		
Waveguide	RG-44/U		16-L-79123-6926	
Waveguide	RG-96/U			

NOTES

1. Waveguide run is limited to four bends.
2. Teflon seals are installed **between** male and female couplings at antenna and transmitter.

June 30, 1954

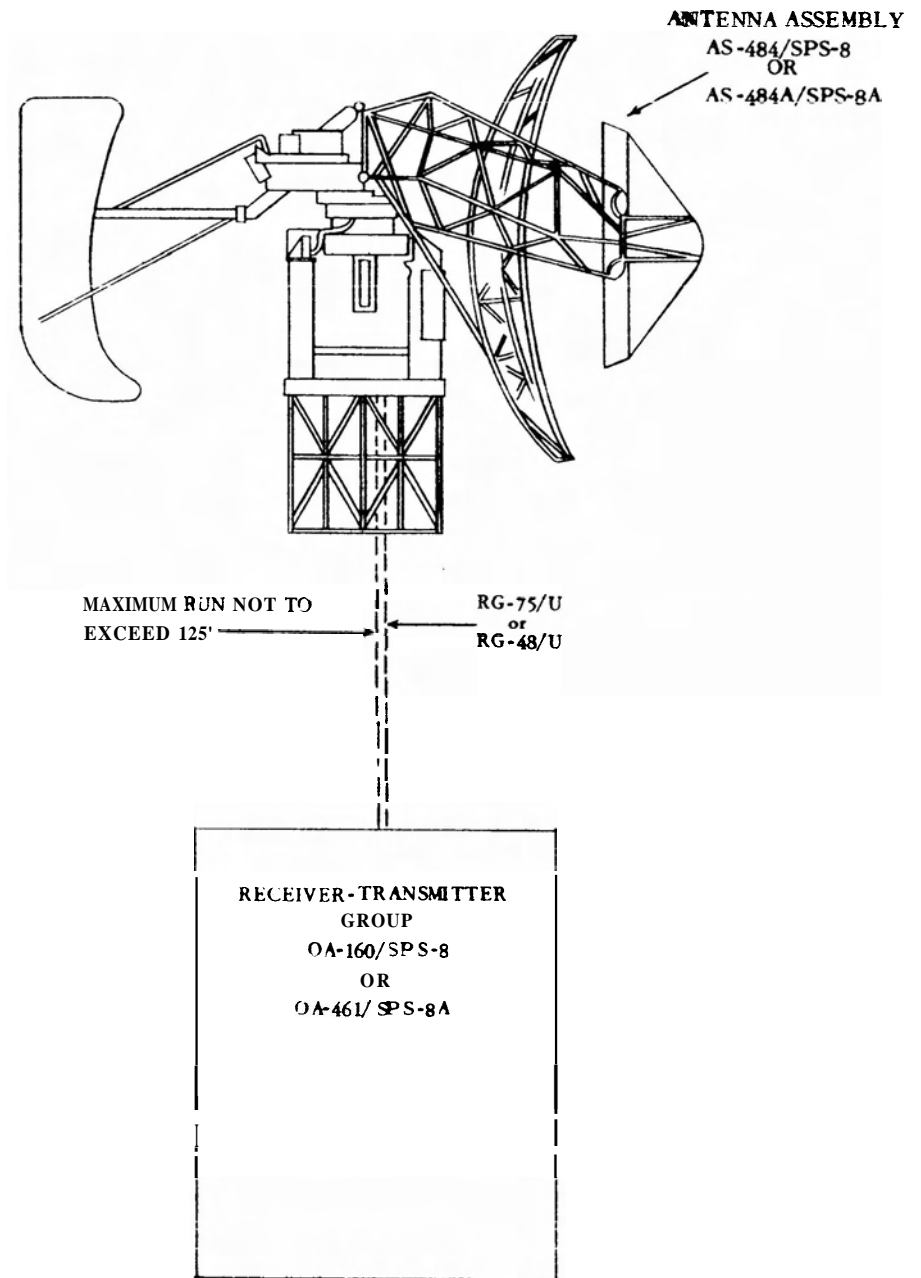

TYPICAL SHIPBOARD ANTENNA SYSTEM FOR RADAR SET AN/SPS-8 OR AN/SPS-8A

BILL OF MATERIALS

Name	Type	No. Req'd	Standard Navy Stock Number	Instruction Book, Specification or Drawing
Antenna Assembly	AS-484/SPS-8			NavShips 91522(A)
Antenna Assembly	AS-484A/SPS-8A		F16-A-53094-3001	NavShips 91988(A)
Receiver-Transmitter Group	OA-160/SPS-8		16-R-35011-9439	NavShips 91522(A)
Receiver-Transmitter Group	OA-461/SPS-8A			NavShips 91988(A)
Radio Frequency Line	RG-48/U or		16-W-20550-4032	JAN-W-85A
	RG-75/U		16-W-20549-8571	JAN-W-85A

June 30, 1954

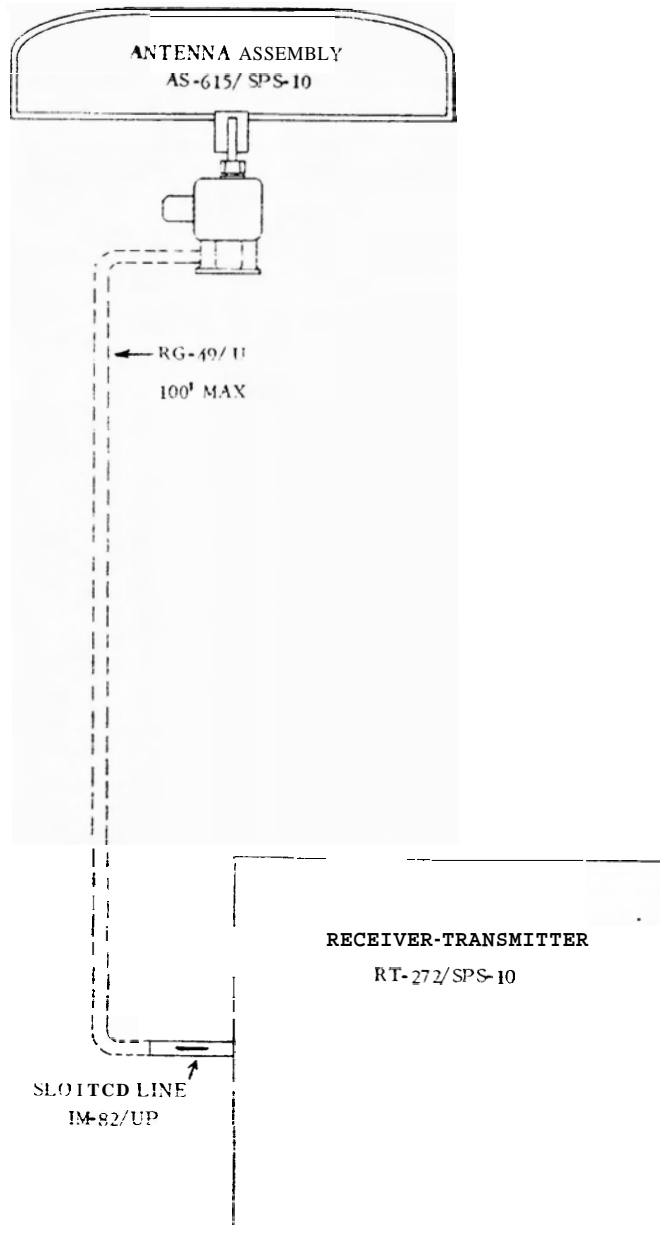

TYPICAL SHIPBOARD ANTENNA SYSTEM FOR RADAR SET AN/SPS-10

BILL OF MATERIALS

Name	Type	No. Req'd	Standard Navy Stock Number	Instruction Book, Specification or Drawing
Antenna Assembly	AS-615/SPS-10	1		NavShips 91921A
Receiver Transmitter	RT-272/SPS-10	1		NavShips 91921A
Slotted Line	IM-82/UP	1		NavShips 91921A
Waveguide	RG-49/U		16-W-20383-8532	JAN-W-85A

June 30, 1954

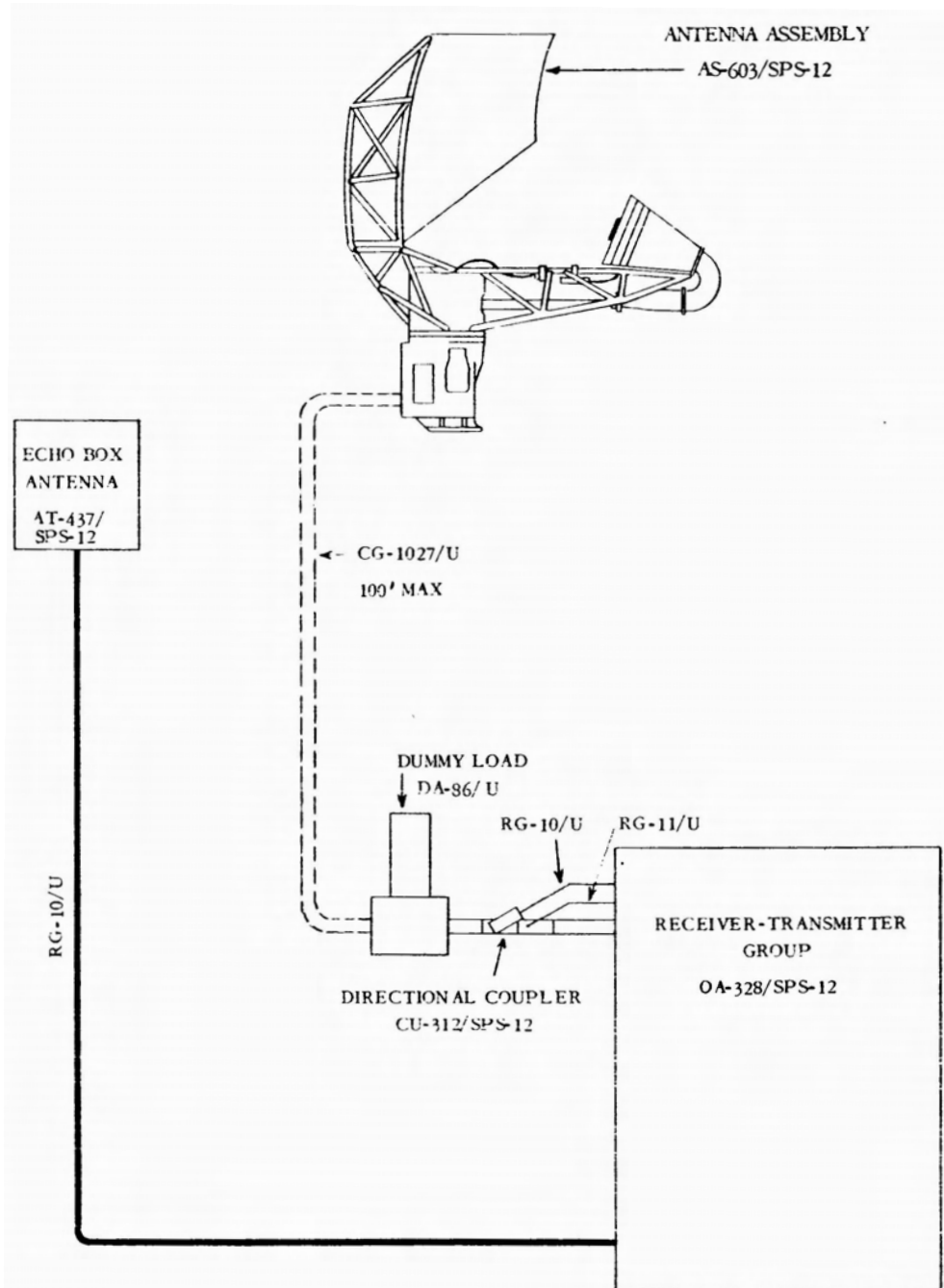

TYPICAL SHIPBOARD ANTENNA SYSTEM FOR RADAR SET AN/SPS-12

BILL OF MATERIALS

Name	Type	No. Req'd	Standard Navy Stock Number	Instruction Book, Specification or Drawing
Antenna Assembly	AS-603/SPS-12	1		NavShips 91949A
Receiver Transmitter	OA-328/SPS-12	1		NavShips 91949A
Dummy Load	DA-86/U	1		NavShips 91949A
Antenna Coupler	CU-312/SPS-12	1		NavShips 91949A
Echo Box Antenna	AT-437/SPS-12	1		NavShips 91949A
RF Cable	RG-10/U		G15-C-12200-625	JAN-C-17A
Radio Frequency Line	CG-1027/U			

June 30, 1954

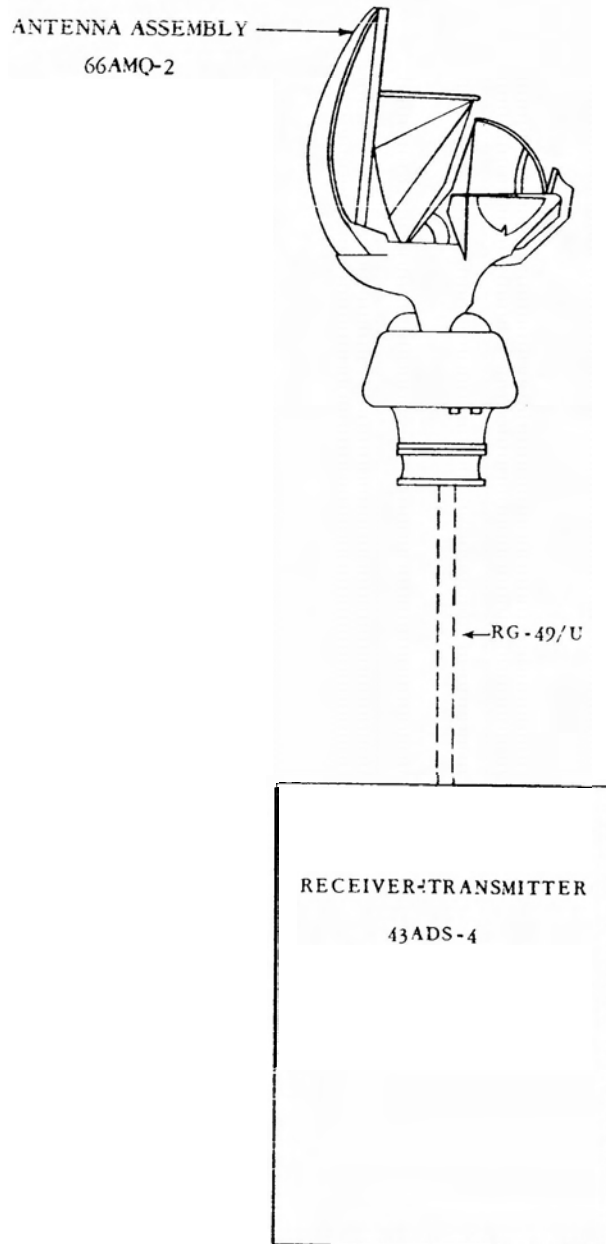

TYPICAL SHIPBOARD ANTENNA SYSTEM FOR RADAR SET SG-6b

BILL OF MATERIALS

Name	Type	No. Req'd	Standard Navy Stock Number	Instruction Book, Specification or Drawing
Antenna Assembly	66AMO-2	1	F16-A-55158-6655	NavShips 91384
Transmitter-Receiver	43ADS-4	1	16-R-35003-3921	NavShips 91384
Radio Frequency Line	RG-49/U		16-W-20383-8532	JAN-W-85A

June 30, 1954

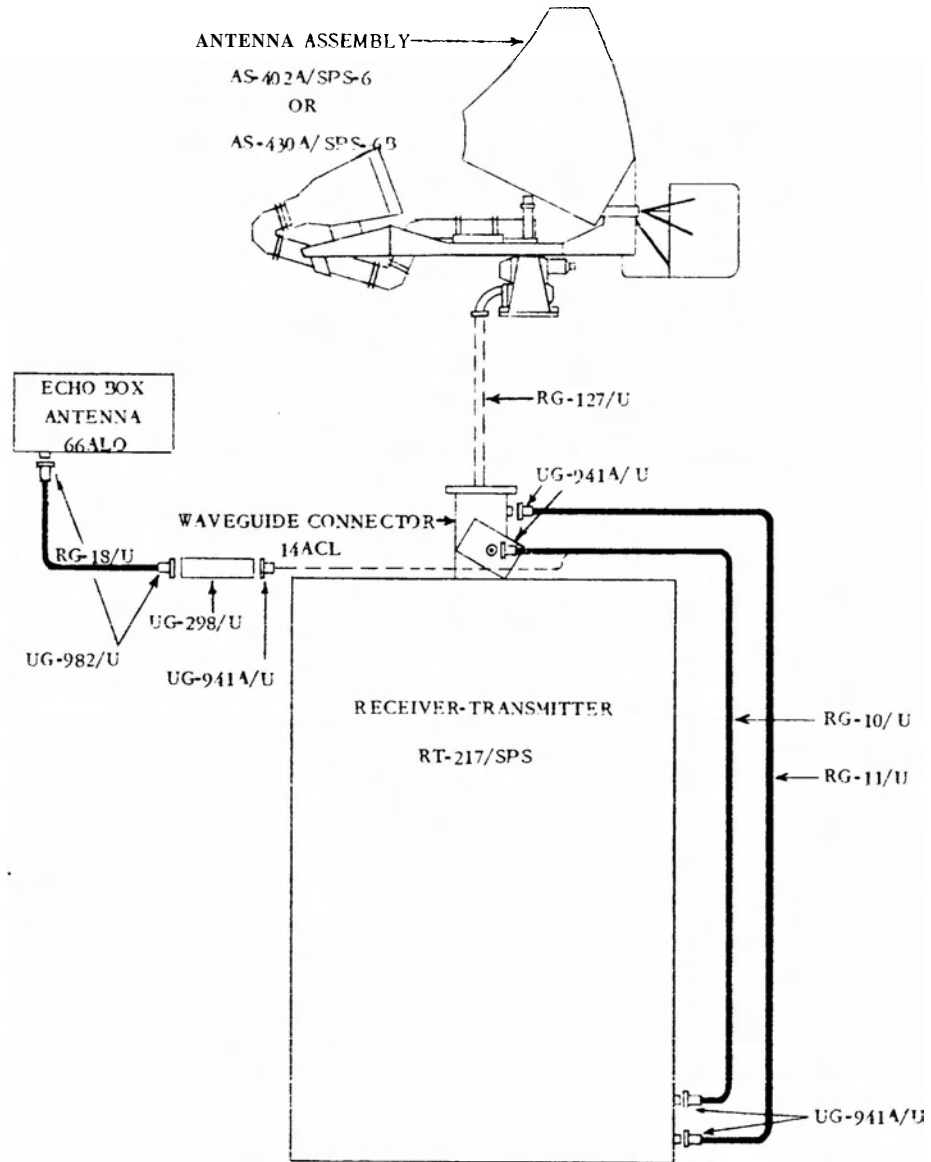

TYPICAL SHIPBOARD ANTENNA SYSTEM FOR RADAR SETS SR-6a AND SR-6b

SILL OF MATERIALS

Name	Type	No. Req'd	Standard Navy Stock Number	Instruction Book, Specification or Drawing
Antenna Assembly	AS-402A/SPS-6			NavShips 900, 989A
Antenna Assembly	AS-430A/SPS-6A			NavShips 900, 989A
Receiver Transmitter	RT-217/SPS	1		NavShips 900, 989A
Echo Box Antenna	66ALO	1	16-A-452143822	RE 65F 2324
RF Cable	RG-10/U		G15-C-12200-625	JAN-C-17A
RF Cable	RG-11/U		G15-C-12201-625	JAN-C-17A
RF Cable	RG-18/U		G15-C-12200-750	JAN-C-17A
Waveguide	RG-127/U		ESO N16-W-2356-5120	JAN-W-85A
Waveguide Connector	14ACL	1	F16-D-57293-8221	JAN-W-85A
Connector, Plug*	UG-941A/U	4		
Connector, Plug**	UG-982/U	2		RE 49D 215
Connector, Adapter	UG-298/U	1		

* Consists of UG-21D/U Connector plus Armor Clamp MX-1286/U

** Consists of UG-167D/U Connector plus Armor Clamp MX-1441/U

June 30, 1954

SECTION 6-3
SUBMARINE ANTENNA SYSTEMS

ORIGINAL

UNCLASSIFIED

6-139

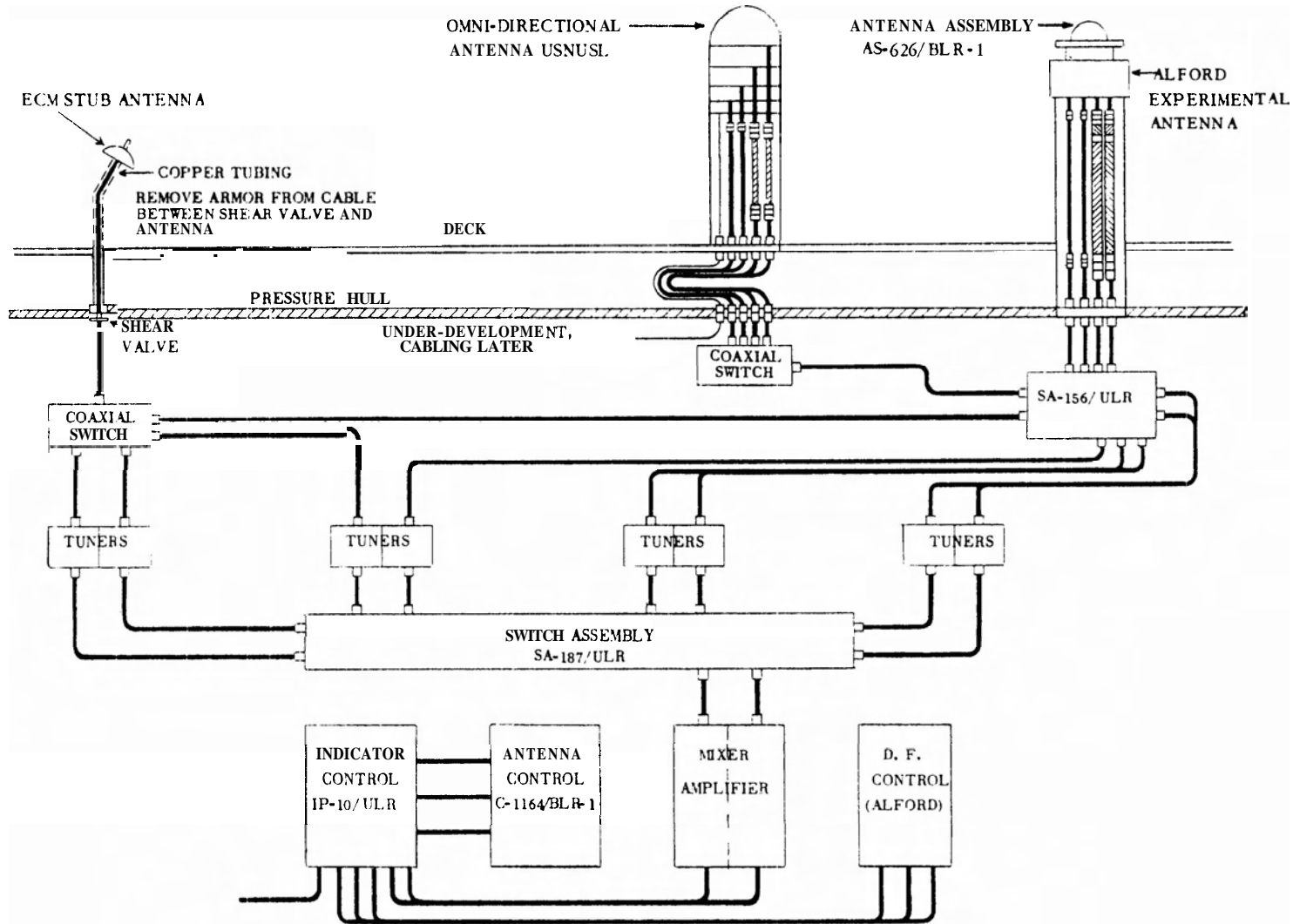

TYPICAL SUBMARINE ANTENNA SYSTEM FOR AN/BLR-1

ANTENNA SYSTEMS

NAVSHIPS 900, 121(A)
UNCLASSIFIED

Section 6-3

BILL OF MATERIALS

Name	Type	No. Req'd	Standard Navy Stock Number	Instruction Book, Specification or Drawing
Coaxial Switch		2		RE 8F 2435
Tuners		8		RE 8F 2435
Switch Assembly	SA-156/ULR	1		RE 8F 2435
Switch Assembly	SA-187/ULR	1		RE 8F 2435
Indicator Control	IP-10/ULR	1		RE 8F 2435
Antenna Control	C-1164/BLR-1	1		RE 8F 2435
Mixer Amplifier		1		RE 8F 2435
DF Control	Alford	1		RE 8F 2435
Antenna Assembly	AS-626/BLR-1	1		RE 8F 2435
Alford Experimental Antenna	Alford	1		RE 8F 2435
Omni-directional Antenna	USNUSL	1		RE 8F 2435
ECM Stub Antenna		1		RE 8F 2435

NOTES

1. For cables and connectors refer to Navy Drawing RE 8F 2435; RE 100D 2017F

June 30, 1954

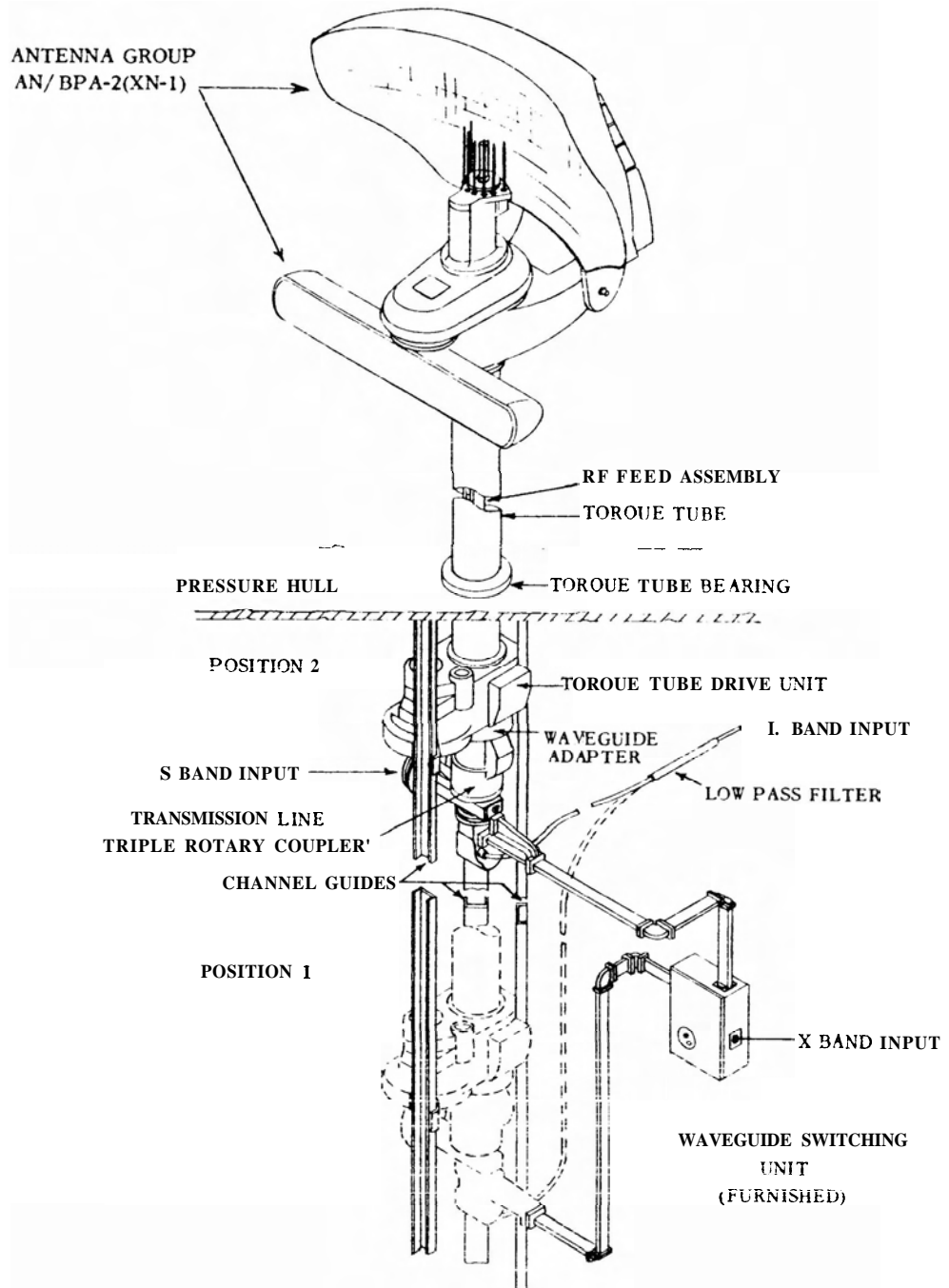

TYPICAL SUBMARINE INSTALLATION OF ANTENNA GROUP AN/BPA-2(XN-1)

BILL OF MATERIALS

Name	Type	No. Req'd	Standard Navy Stock Number	Instruction Book, Specification or Drawing
Antenna Group	AN/BPA-2(XN-1)			NavShips 92136

NOTES

1. Antenna Group AN/BPA-2(XN-1) can be operated at two different heights.

June 30, 1954

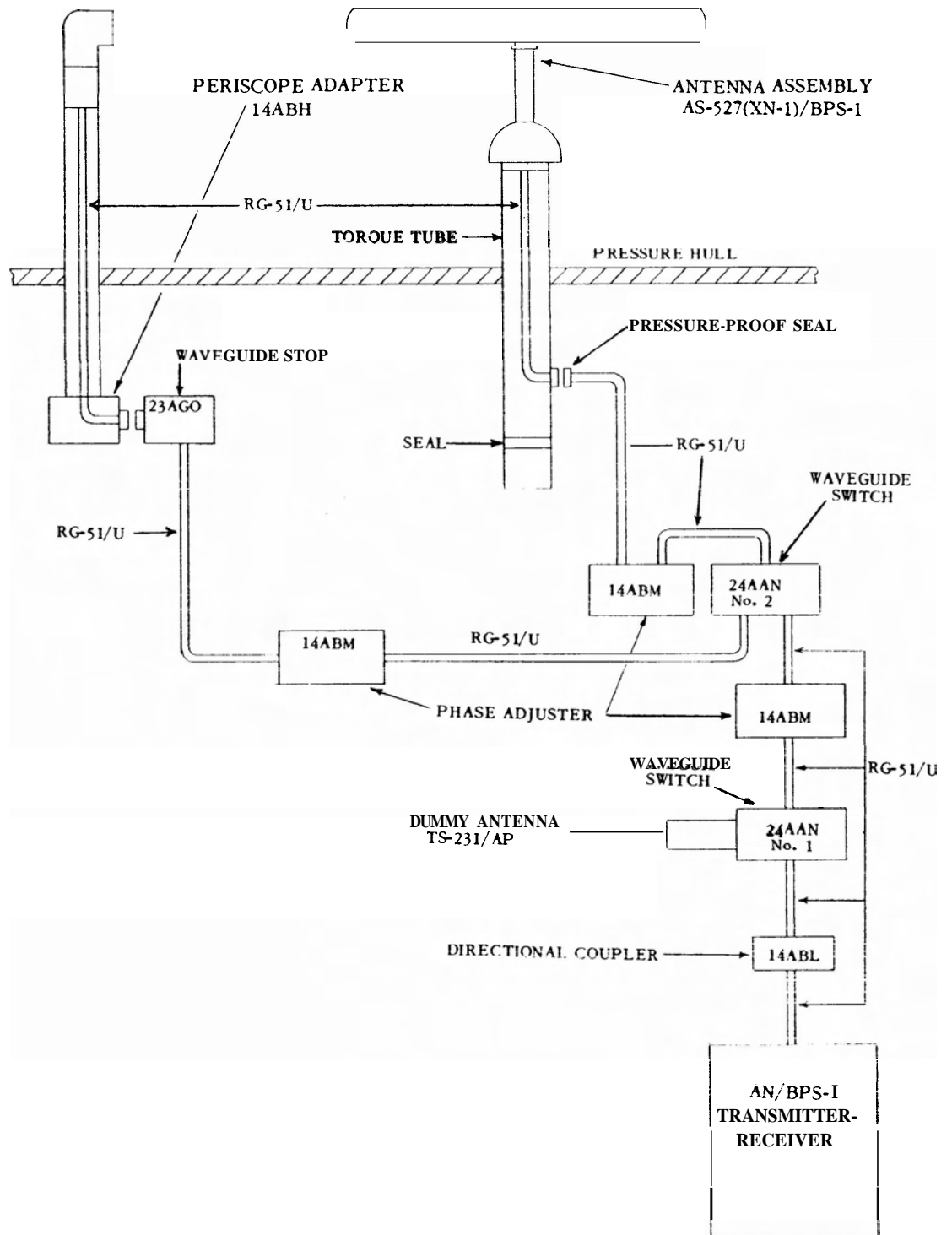

TYPICAL SUBMARINE ANTENNA SYSTEM FOR RADAR SET AN/BPS-1

BILL OF MATERIALS

Name	Type	No. Req'd	Standard Navy Stock Number	Instruction Book, Specification or Drawing
Receiver - Transmitter	AN/BPS-1	1		NavShips 91400
Antenna Assembly	AS-527(XN-1)	1		NavShips 91400
Periscope Adapter	BPS-1 14ABB	1	F16-R-94282-3660	NavShips 900,116
Waveguide Stop	23AGO	1	N16-W-2392-5000 (ESO Stock No.)	RE 8H 2528
Phase Adjuster	14ABM	3	16-T-98126-1004	RE 8H 2528
Waveguide Switch	24AAN	2	16-S-39751-1004	RE 8H 2528
Dummy Antenna	TS-231/AP	1	16-L-86178-9251	RE 8H 2528
Directional Coupler	14ABL	1	16-D-57191-7935	RE 8H 2528
Waveguide	RG-51/U		Signal Corps	MIL-T-85

June 30, 1954

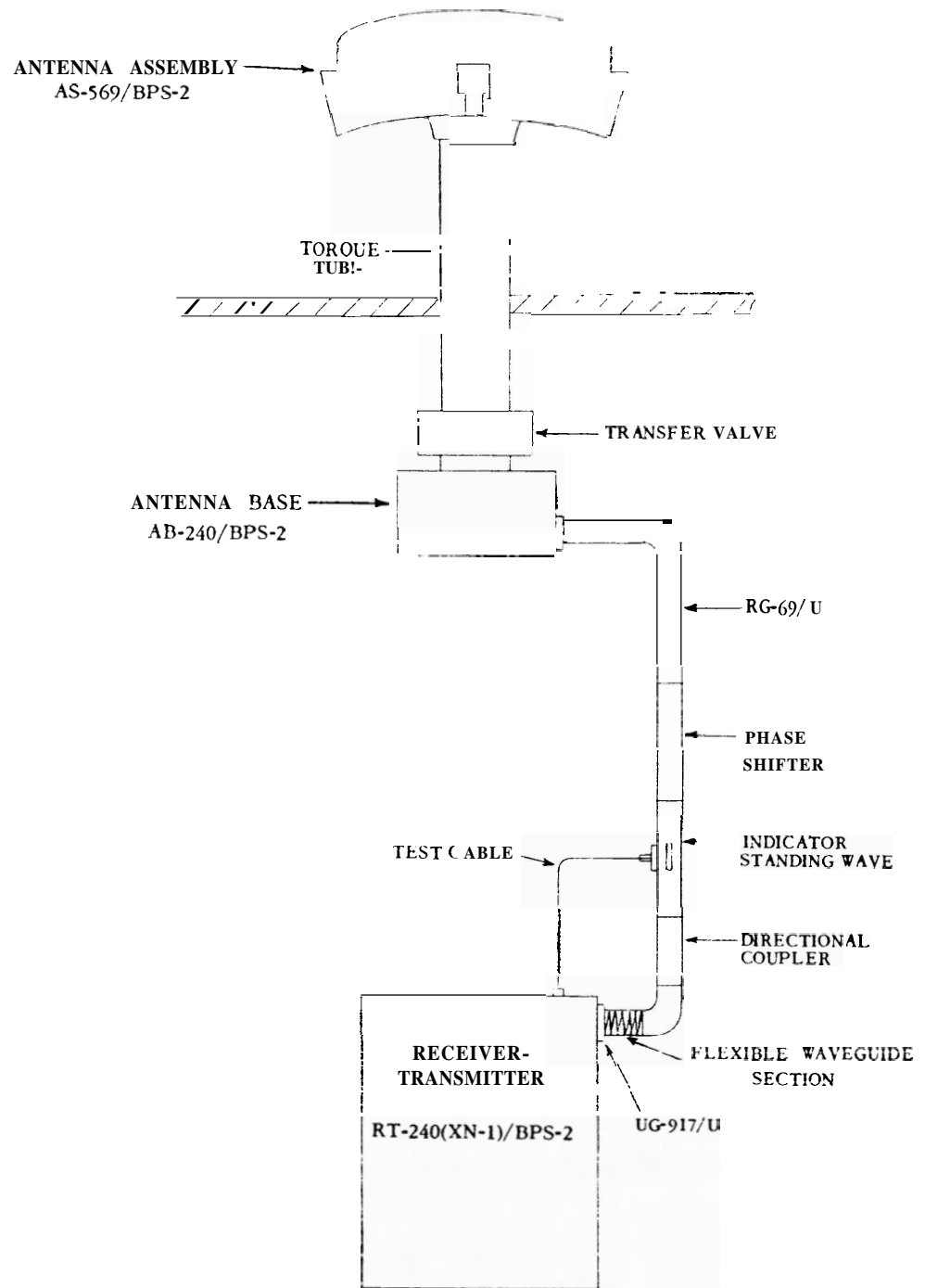

TYPICAL SUBMARINE ANTENNA SYSTEM FOR AN/BPS-2 RADAR EQUIPMENT

BILL OF MATERIALS

Name	Type	No. Req'd	Standard Navy Stock Number	Instruction Book, Specification or Drawing
Receiver - Transmitter	RT-240(XN-1) BPS-2	1		NavShips 91817A
Antenna Assembly	AS-569/BPS-2	1		NavShips 91817A
Transfer Valve		1		NavShips 31817A
Antenna Base	AB-240/BPS-2	1		NavShips 91817A
Flexible Waveguide				NavShips 91817A
Directional Coupler	CU-299/BPS-2	1		NavShips 91817A
Indicator Standing Wave	IM-77/BPS-2	1		NavShips 91817A
Phase Shifter	CU-224/BPS-2	1		NavShips 91817A
Adapter, Coax to Waveguide	UG-917/U	1		NavShips 91817A
Waveguide	RG-69/U		16-W-20776-4032	MIL-T-85

June 30, 1954

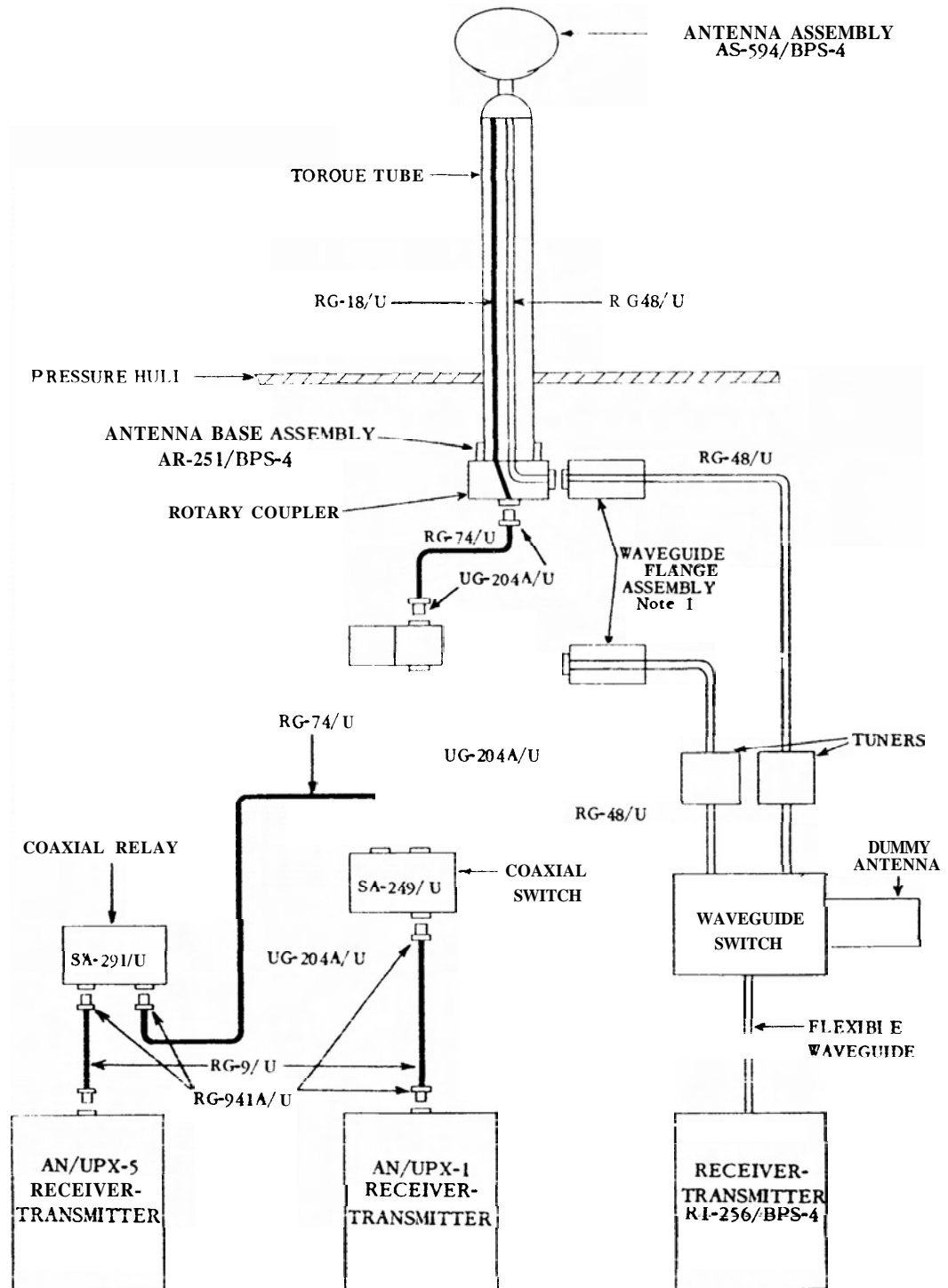

TYPICAL SUBMARINE ANTENNA SYSTEM FOR IFF AND RADAR DETECTIONSEE

BILL OF MATERIALS

Name	Type	No. Req'd	Standard Navy Stock Number	Instruction Book, Specification or Drawing
Receiver-Transmitter	RT-256/BPS-4	1		NavShips 91621
Receiver-Transmitter	RT-194/UPX-1	1	F16-R-34973-1001	NavShips 91343
Receiver-Transmitter	RT-269/UPX-5	1	F16-R-34973-1001	NavShips 91343
Antenna Assembly	AS-594/BPS-4	1		NavShips 91621
Antenna Base Assembly	AB-251/BPS-4	1		NavShips 91621
Rotary Coupler		1		RE 8H 2528
Waveguide Flange Assembly		2		RE 8H 2528
Tuners		2		RE 8H 2528
Waveguide Switch		1		RE 8H 2528
Dummy Antenna		1		RE 8H 2528
RF Filter	F-125/UP	1		RE 8H 2528
Coaxial Switch	SA-249/U	1		RE 8H 2528
Coaxial Relay	SA-291/U	1		RE 8H 2528
RF Cable	RG-9/U		G15-C-12200-500	JAN-C-17A
RF Cable	RG-18/U		G15-C-12200-750	JAN-C-17A
RF Cable	RG-74/U		15-C-12202-675	JAN-C-17A
Waveguide	RG-48/U		N16-W-2375-550 (ESO Stock No.)	MIL-T-85
Flexible Waveguide	01834			
Connector, plug	UG-204A/U	6	17-C-71417-3555	RE 49F 361C
Connector, plug*	UG-941A/U	4		

* Consists of UG-21/U Connector plus Armor Clamp MX-1286/U.

NOTES

1. Antenna **Assembly AS-594/BPS-4** may be operated at two different heights.

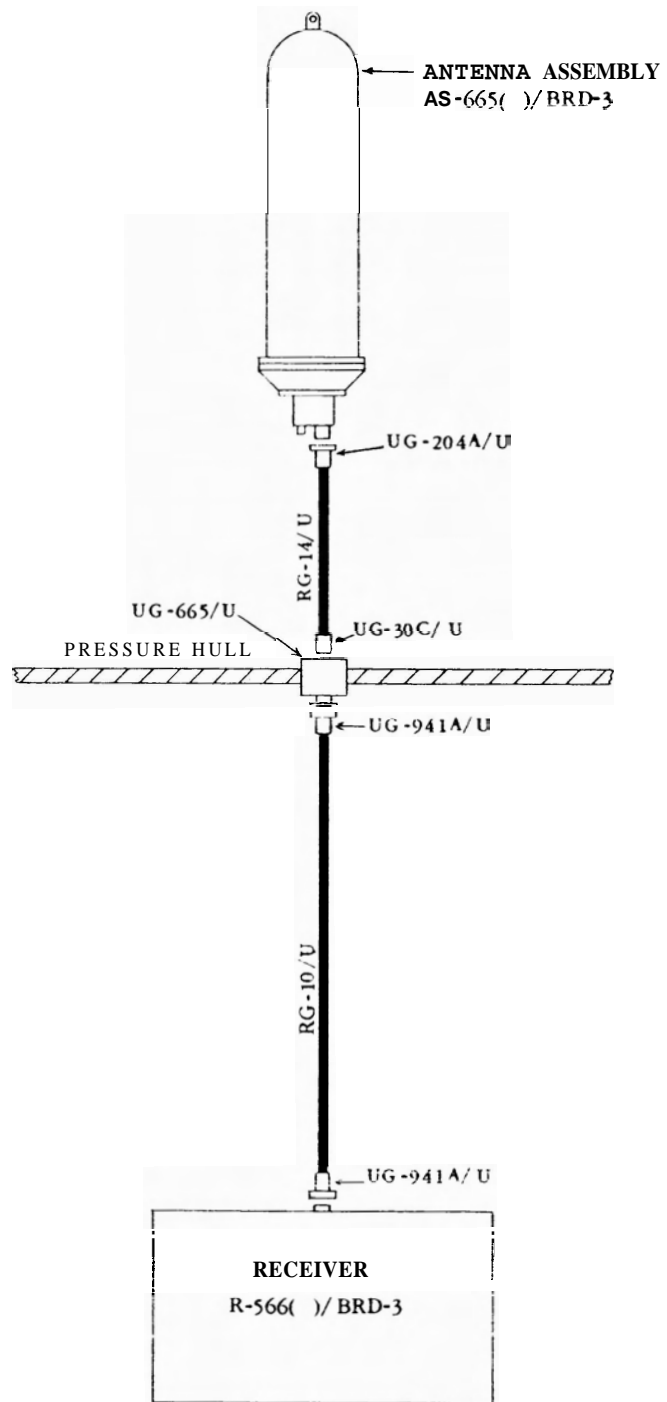

TYPICAL SUBMARINE ANTENNA SYSTEM FOR AN/BRD-3 DIRECTION FINDER

BILL OF MATERIALS

Name	Type	No. Req'd	Standard Navy Stock Number	Instruction Book, Specification or Drawing
Radio Receiver	R-566()/BRD-3	1		NavShips 91912
Antenna Assembly	AS-655()/BRD-3	1		RE 36F 2019
RF Cable	RG-10/U		G15-C-12200-625	JAN-C-17A
RF Cable	RG-14/U		15-C-12200-650	JAN-C-17A
Connector, plug	UG-204A/U	1	17-C-71417-3555	RE 49F 361C
Connector, jack	UG-30C/U	1	17-C-67732-2976	
Hull Fitting	UG-665/U	1		RE 49D 610
(Connector, plug*	UG-941A/U	2		

* Consists of UG-21D/U Connector plus Armor **Clamp** MX-1286/U.

June 30, 1954

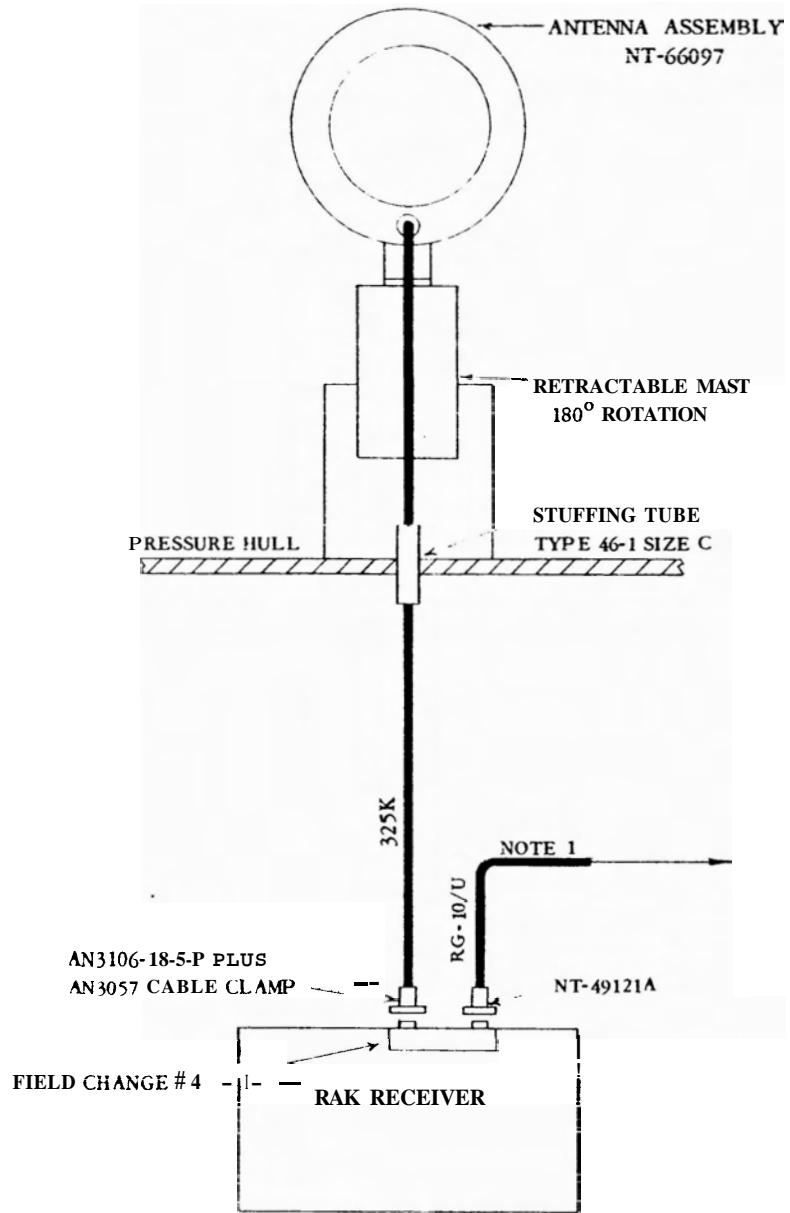

TYPICAL SUBMARINE ANTENNA SYSTEM FOR RADIO RECEIVER RAK

BILL OF MATERIALS

Name	Type	No., Req'd	Standard Navy Stock Number	Instruction Book, Specification or Drawing
Radio Receiver	RAK	1		NavShips 900, 180
Antenna Assembly	66097	1	N16-A-45793-2601	NavShips 900,505
R F Cable	325K		N15-C-2061-3640	NavShips 900,505
Connector, plug	3106-18-5-P	1		
Cable Clamp	3057	1		
Connector, plug	49121A	1	17-C-71120-4869	RE 49F 216B
Stuffing Tube	46-1-C	1	A17-T-10051-206	

NOTES

1. The RG-10/U cable runs to a receiver patch panel for operation of the RAK Receiver from a whip or emergency wire antenna.

June 30, 1954

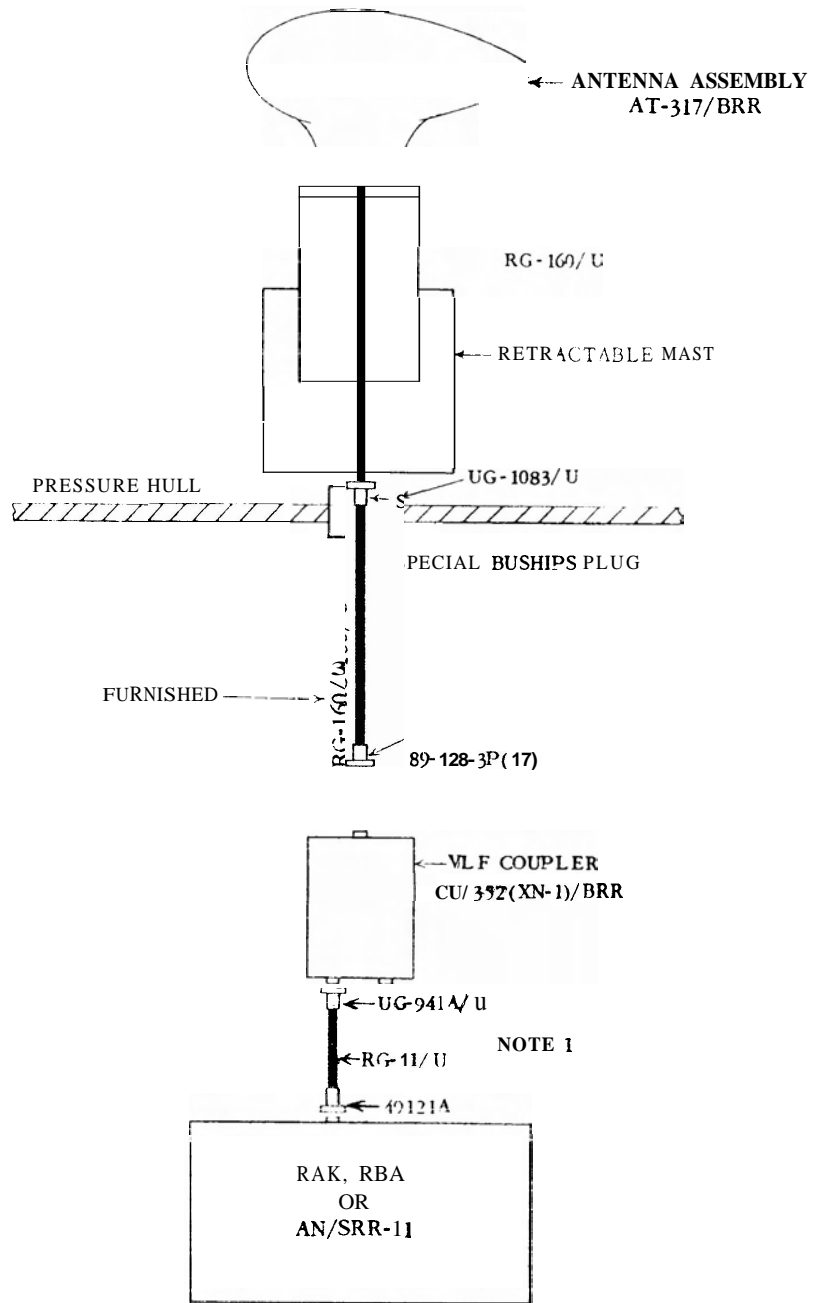

TYPICAL SUBMARINE ANTENNA SYSTEM FOR VLF RADIO RECEIVERS

BILL OF MATERIALS

Name	Type	No. Req'd	Standard Navy Stock Number	Instruction Book, Specification or Drawing
Antenna Assembly	AT-317/BRR	1		NavShips 92084
ULF Coupler	CU-352/BRR	1		
Special BuShips Plug				
Hull Fitting	UG-1083/U	1		
Connector, plug	89-128-3P(17)			
Connector, plug*	UG-941A/U	1		
Connector, plug	49121A	1	17C 67444 1300	RE 49F 168

* Consists of UG-21D/U Connector plug Armor Clamp MX-1286/U

NOTE

1. This cable is furnished with a UG-941 A/U Connector on one end and a 49121A Connector on the other end. If the RAK or RBA receivers are being used connect the UG-941A/U to the UG-58/U Receptacle on the multicoupler and the other end to the receiver. If the AN/SRR-11 is being used connect the 49121A to the 49120 Receptacle on the multicoupler and the other end to the receiver.

June 30, 1954

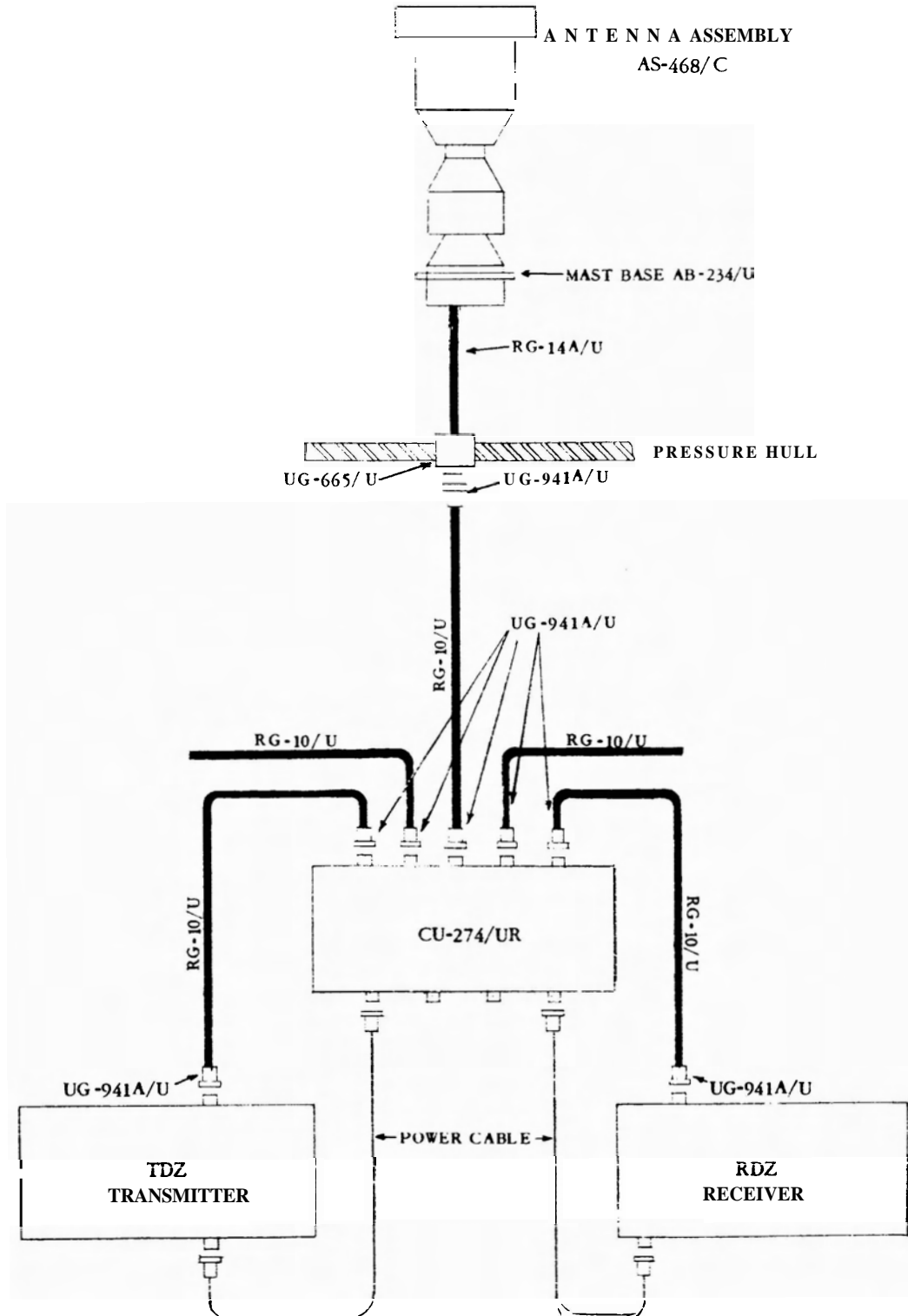

TYPICAL SUBMARINE ANTENNA SYSTEM FOR ANTENNA COUPLER CU-274/UR

BILL OF MATERIALS

Name	Type	No. Req'd	Standard Navy Stock Number	Instruction Book, Specification or Drawing
Antenna Coupler	CU-274/UR	1		NavShips 91860
Antenna Assembly	AS-468/B	1	F16-A-51990-2340	RE 66D 620F
RF Cable	RG-10/U	1	G15-C-12200-625	JAN-C-17A
RF Cable	RG-14/U		15-C-12200-650	JAN-C-17A
Connector, plug *	UG-941A/U			
Hull Fitting	UG-665/U	1		RE 49D 610

* Consists of UG-21D/U Connector with Armor Clamp MX-1286/U.

June 30, 1954

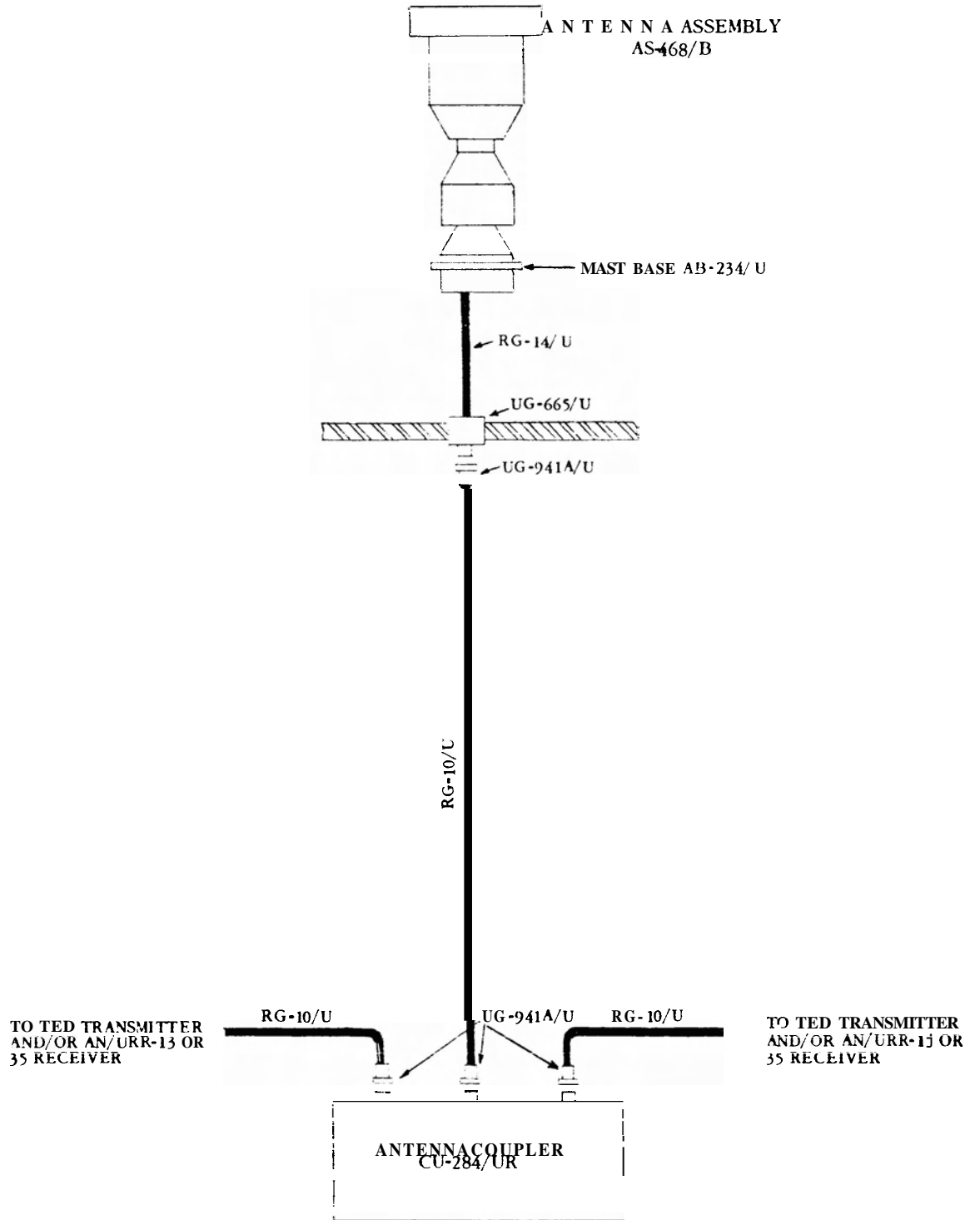

TYPICAL SUBMARINE ANTENNA SYSTEM FOR ANTENNA COUPLER CU-284/UR

BILL OF MATERIALS

Name	Type	No. Req'd	Standard Navy Stock Number	Instruction Book, Specification or Drawing
Antenna Coupler	CU-284/UR	1		NavShips 91790
Antenna Assembly	AS-468/B	1	F16-A-51990-2340	RE 65D 620F
R F Cable	RG-10/U		G15-C-12200-625	JAN-C-17A
R F Cable	RG-14/U		15-C-12200-650	JAN-C-17A
Connector, plug *	UG-941A/U			
Hull Fitting	UG-665/U	1		RE 49D 610

* Consists of UG-21D/U Connector with Armor Clamp MX-1286/U.

June 30, 1954

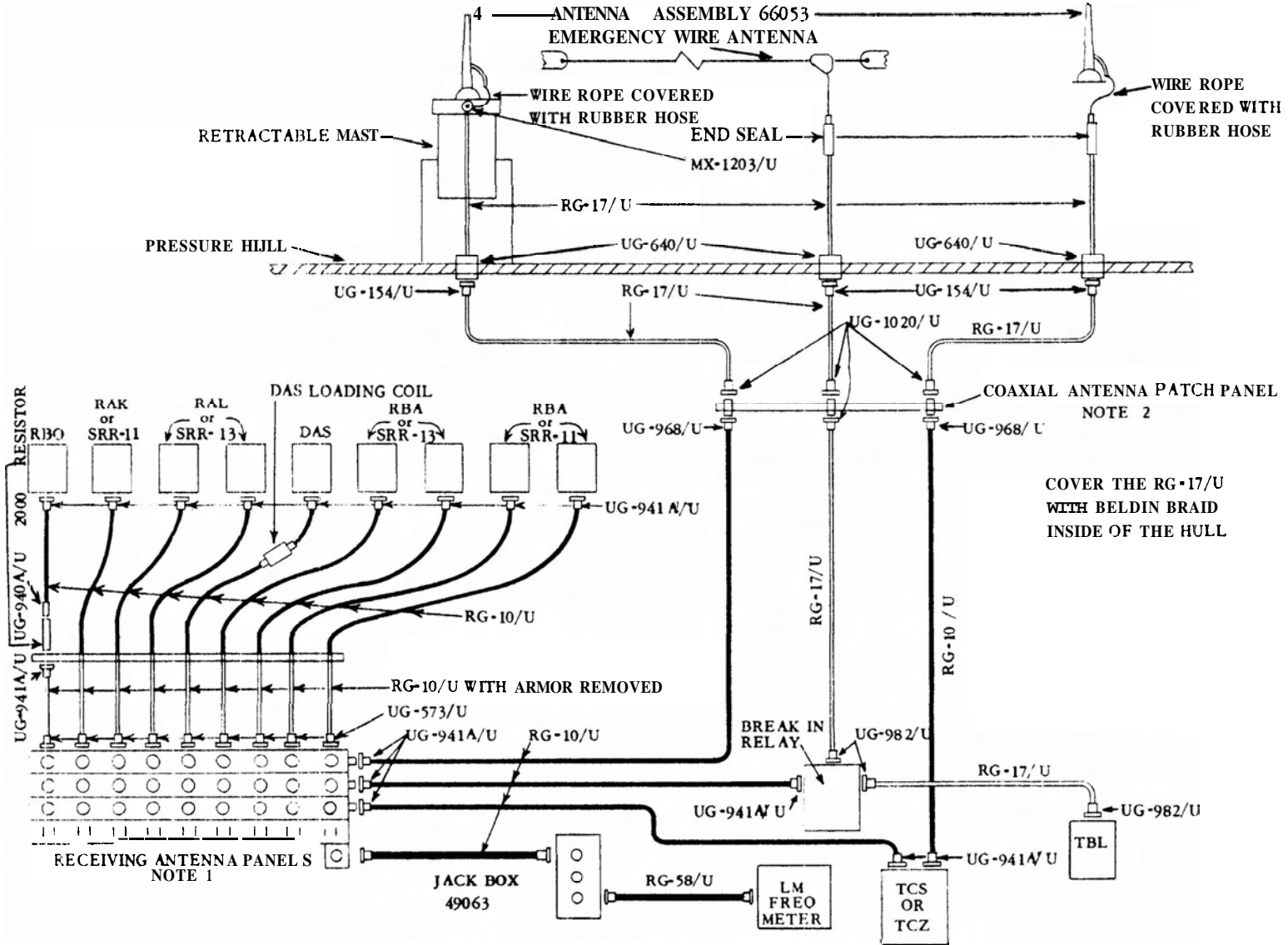

TYPICAL MF-HF ANTENNA SYSTEM FOR SUBMARINES

BILL OF MATERIALS

Name	Type	No. Req'd	Standard Navy Stock Number	Instruction Book, Specification or Drawing
Antenna Assembly	66053	2	F16-A-54370-1075	RE 100F 181 RE 66F 392
Frequency Wire Antenna	7-18# Phos. Bronze	1	N16-W-3740-1	MIL-W-17211
End Seal	MX-1203/U			RE 49F 602
RF Cable	RG-10/U		G15-C-12200-625	JAN-C-17A
RF Cable	RG-17/U		15-C-12200-725	JAN-C-17A
Connector, plug	UG-154/U	3	17-C-71422-3137	RE 49F 284L
Connector, plug	UG-573/U			
Hull Fitting	UG-640/U			RE 49D 630
Connector, plug*	UG-941A/U			
Connector, jack**	UG-940A/U			
Connector, plug***	UG-982/U			
Wire Rope Jumper	7-18# Phos. Bronze	2	N16-W-3740-1	MIL-W-17231

* Consists of UG-21/U Connector plus Armor Clamp MX-1286/U.

** Consists of UG-23/U Connector plus Armor Clamp MX-564A/U.

*** Consists of UG-167/U Connector plus Armor Clamp MX-1286/U.

NOTES

1. For details of receiving antenna panels refer to BuShips Drawing RE 8F 2004.
2. For details of coaxial antenna patch panels refer to BuShips Drawing RE 8F 2004.
3. The receiving antenna panels are to be replaced by the AN/BRA-1 Multicoupler when available.

June 30, 1954

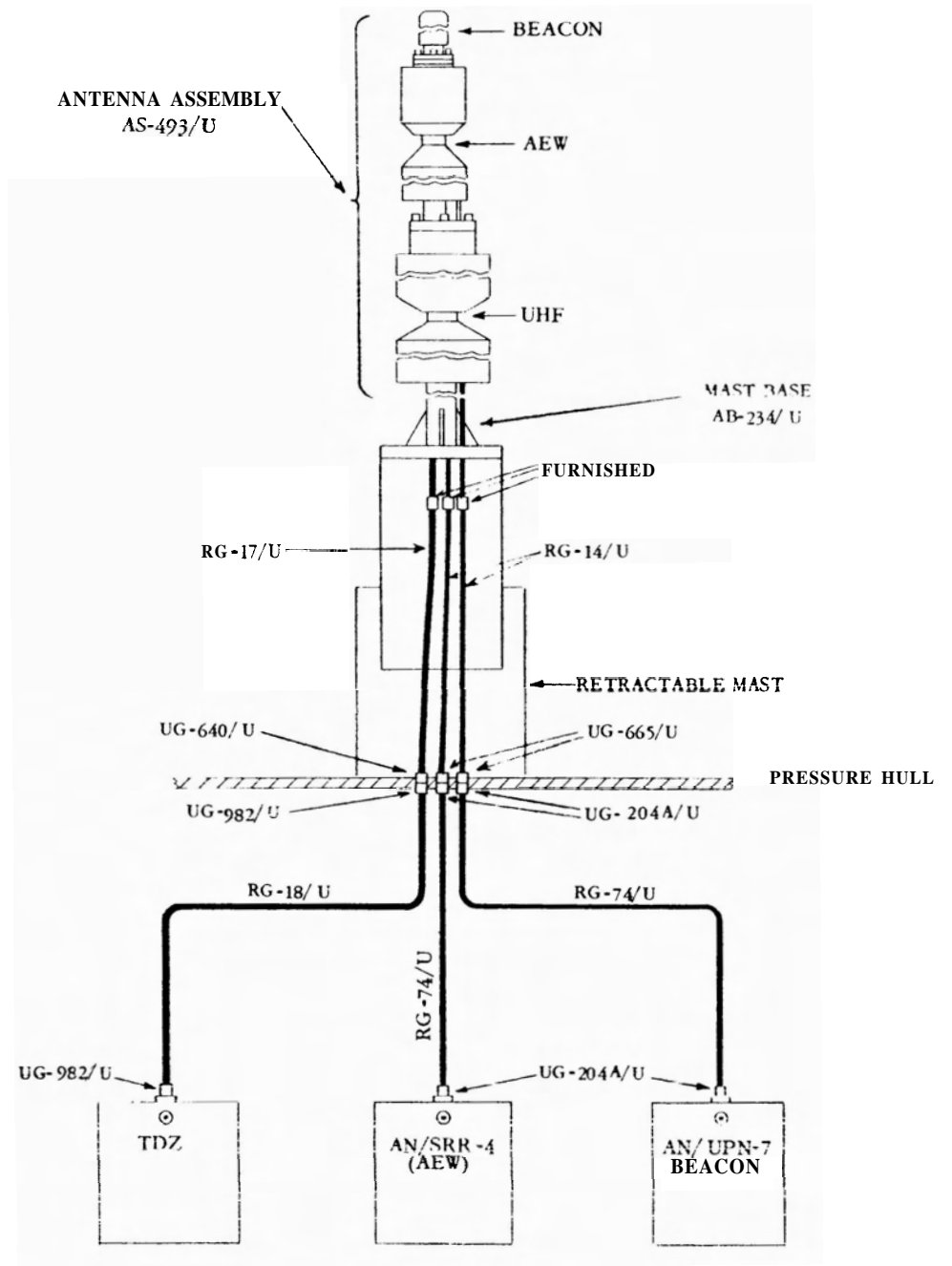

TYPICAL SUBMARINE ANTENNA SYSTEM FOR UHF, AEW AND BEACON EQUIPMENT

BILL OF MATERIALS

Name	Type	No. Req'd	Standard Navy Stock Number	Instruction Book, Specification or Drawing
TDZ Transmitter	52342	1	F16-T-37282-4367	NavShips 900,809
AN/SRR-4 Receiver	R-360/SRR-4	1	F16-R-30899-7021	NavShips 91410(A)
AN/UPN-7 Receiver Transmitter	RT-186/UPN-7	1	F16-R-34998-3451	RE 36F 2003
Antenna Assembly	AS-493/U	1		RE 10J 2072 RE 66F 617E
RF Cable	RG-14/U		15-C-12200-650	JAN-C-17A
RF Cable	RG-17/U		15-C-12200-725	JAN-C-17A
RF Cable	RG-18/U		15-C-12200-750	JAN-C-17A
RF Cable	RG-74/U		15-C-12200-675	JAN-C-17A
Connector, plug	UG-204A/U	4	17-C-71417-3555	RE 49F 361C
Connector, plug *	UG-982/U	2		RE 49D 215
Hull Fitting	UG-640/U	1		RE 49D 603
Hull Fitting	UG-665/U	2		RE 49D 610

* Consists of UG-167D/U Connector plus Armor Clamp, MX-1441/U.

June 30, 1954

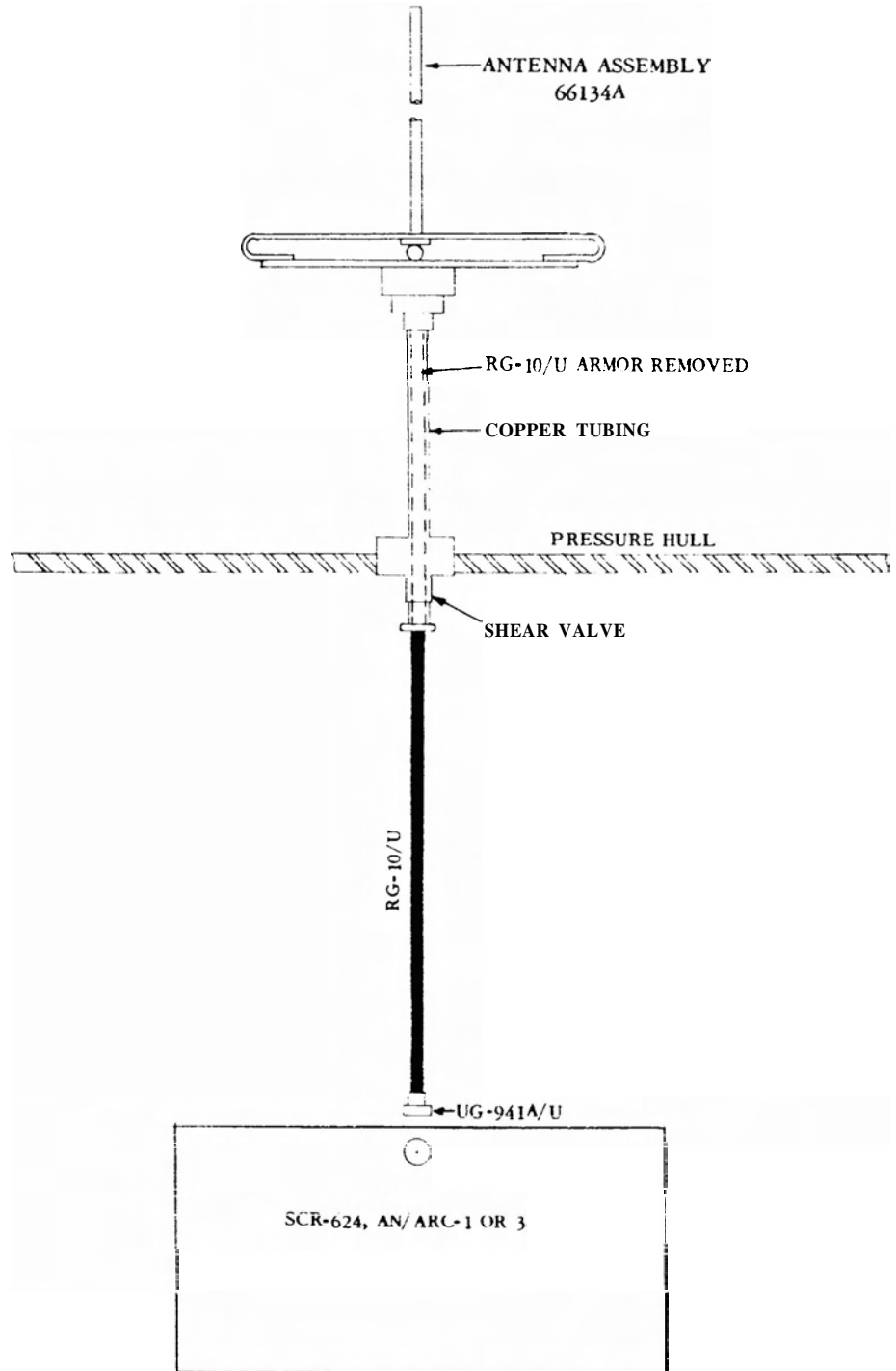

TYPICAL SUBMARINE ANTENNA SYSTEM FOR VHF RADIO EQUIPMENT

BILL OF MATERIALS

Name	Type	No. Req'd	Standard Navy Stock Number	Instruction Book, Specification or Drawing
Antenna Assembly	66134A	1	F16-A-52282-7001	NavShips 91371
Copper Tubing				
RF Cable	RG-10/U		G15-C-12200-625	JAN-C-17A
Connector, plug*	UG-941A/U	1		
Shear Valve		1		

* Consists of UG-21/U Connector with Armor Clamp MX-1286/U.

June 30, 1954

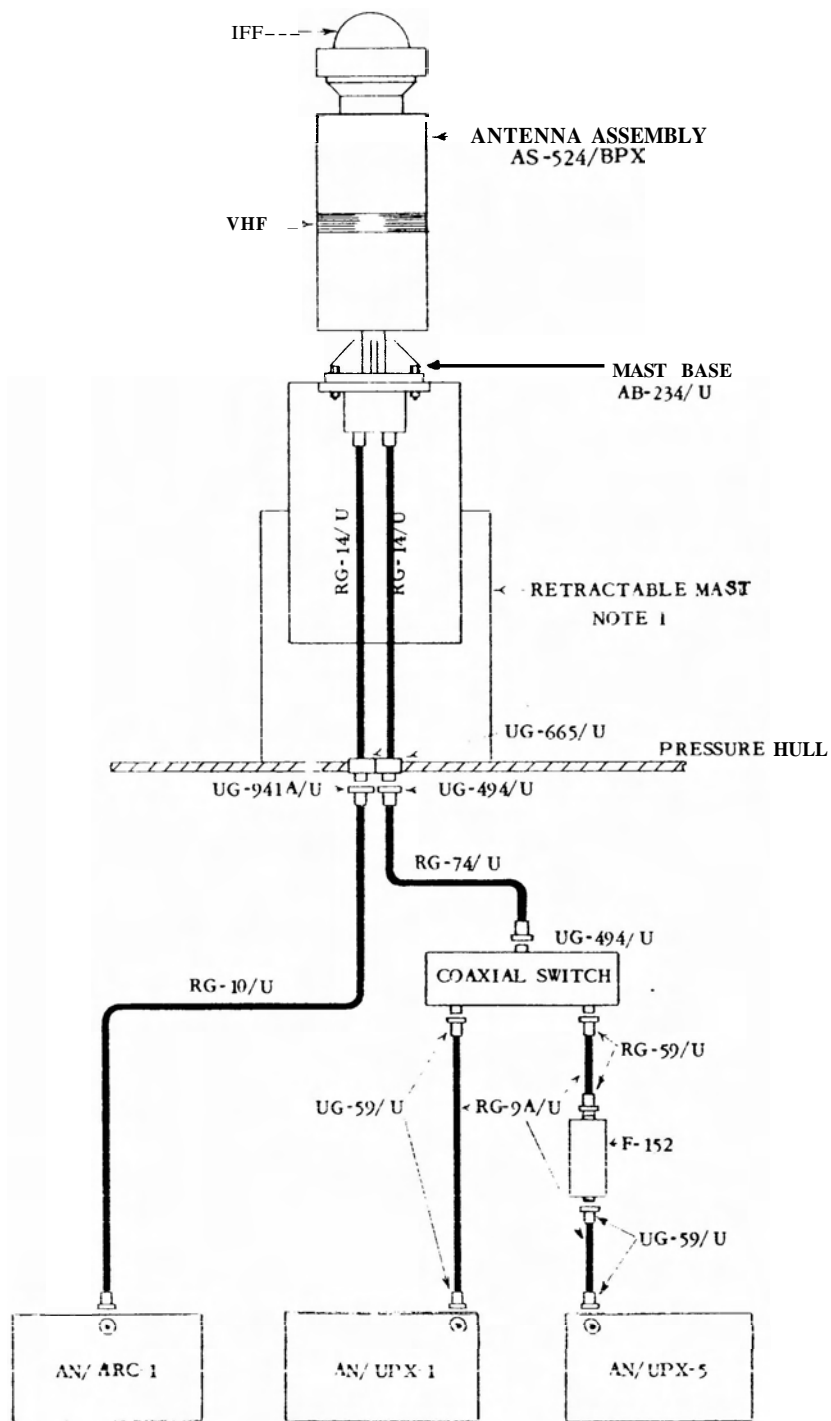

TYPICAL SUBMARINE ANTENNA SYSTEM FOR VHF AND IFF EQUIPMENT

BILL OF MATERIALS

Name	Type	No. Req'd	Standard Navy Stock Number	Instruction Book, Specification or Drawing
AN/ARC-1 Receiver Transmitter	RT-18A/ARC-1	1		NavShips 98215
AN/UPX-1 or 5 Receiver Transmitter	RT-194/UPX-1 or RT-296/UPX-5	1 1	F16-R-34973-1001	NavShips 91343
Coaxial Switch	SA-291			
RF Cable	RG-9A/U		G15-C-12200-525	JAN-C-17A
RF Cable	RG-10/U		C15-C-12200-625	JAN-C-17A
RF Cable	RG-14/U		15-C-12200-650	JAN-C-17A
RF Cable	RG-74/U		15-C-12202-675	JAN-C-17A
Hull Fitting	UG-665/U	2		RE 49D 610
Connector, plug	UG-59/U	6	17-C-71419-1999	RE 49F 225A
Connector, plug	UG-494/U	2	17-C-71417-3545	MIL-C-643
Connector, plug *	UG-941A/U	2		
Antenna Assembly	AS-524/BPX	1		RE 66D 624
Filter	F-152	1		

* Consists of UG-21D/U Connector with Armor Clamp MX-1286/U.

NOTES

1. For details of retractable mast refer to Navy Drawing RE 8H 2087B.

June 30, 1954

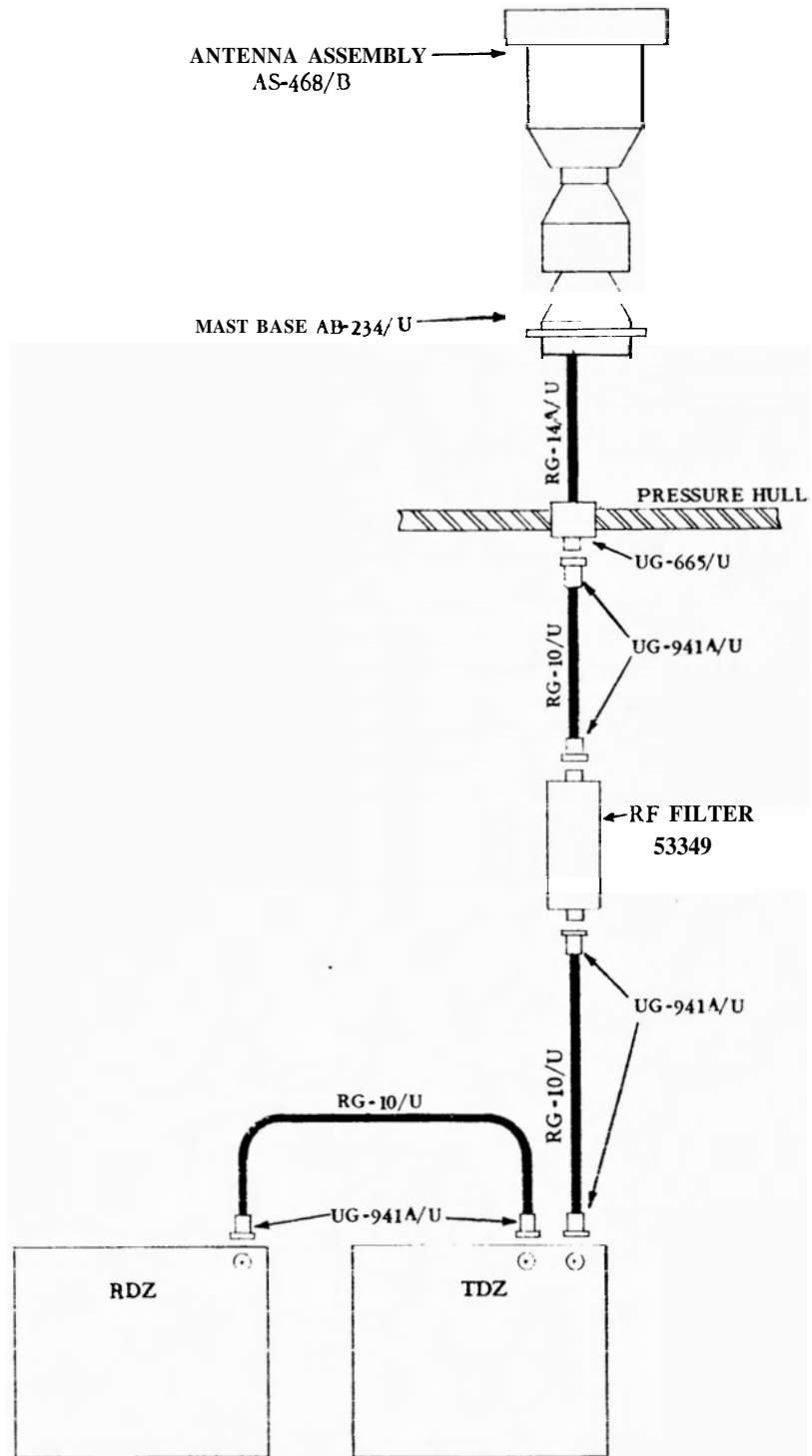

TYPICAL SUBMARINE ANTENNA SYSTEM FOR TDZ-RDZ RADIO EQUIPMENT

BILL OF MATERIALS

Name	Type	No. Req'd	Standard Navy Stock Number	Instruction Book, Specification or Drawing
RDZ Receiver	46275	1	F16-R-31678-7491	NavShips 900, 617 NavShips 91338
TDZ Transmitter	52342	1	F16-T-37282-4367	NavShips 900, 809
Antenna Assembly	AS-468/B	1	F16-A-51990-2340	RE 65D 620F
RF Cable	RG-10/U		G15-C-12200-625	JAN-C-17A
RF Cable	RG-14/U		15-C-12200-650	JAN-C-17A
RF Filter	53349	1	N16-F-2748 (ESO Stock No.)	RA 53F 233B
Connector, plug *	UG-941A/U	6		
Hull Fitting	UG-665/U	1		RE 49D 610

* Consists of UG-21D/U Connector with Armor Clamp MX-1286/U.

June 30, 1954

6-168

UNCLASSIFIED

ORIGINAL

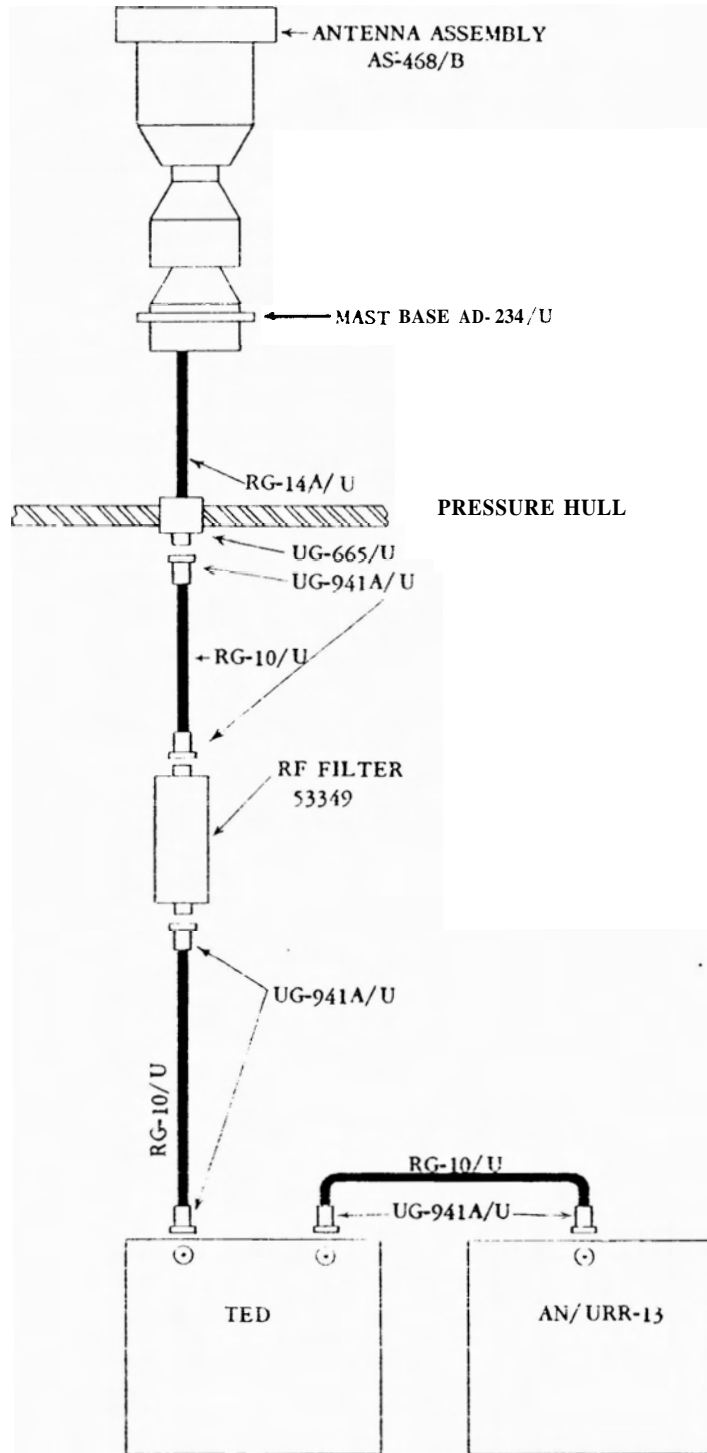

TYPICAL SUBMARINE ANTENNA SYSTEM FOR TED-AN/URR-13 RADIO EQUIPMENT

BILL OF MATERIALS

Name	Type	No. Req'd	Standard Navy Stock Number	Instruction Book, Specification or Drawing
TED Transmitter	52373	1	F16-T-37282-4251	NavShips 91357
AN/URR-13 Rec.	R-266/URR-13	1	F16-R-31680-9501	NavShips 91270
Antenna Assembly	AS-468/B	1	F16-A-51990-2340	RE 65D 620F
RF Cable	RG-10/U		G15-C-12200-625	JAN-C-17A
RF Cable	RG-14/U		15-C-12200-650	JAN-C-17A
Connector, plug *	UG-941A/U	6		
Hull Fitting	UG-665/U	1		RE 49D 610
RF Filter	53349	1	N16-F-2748 (ESO Stock No.)	RA 53F 233B

* Consists of UG-21D/U Connector, with Armor Clamp MX-1286 /U.

June 30, 1954

INDEX

Type	Page	Type	Page
A		A	
AN/APX-6.....	6-5	AN/URT-8.....	6-59
AN/APX-7.....	6-7	AN/URT-9.....	6-61
AN/ARA-25.....	6-9	AN/URT-10.....	6-63
AN/ARC-1.....	6-11, 6-163	AN/VRC-16.....	6-65
	6-165	AN/VRC-17.....	6-65
AN/ARC-3.....	6-13, 6-163	AN/VRC-18.....	6-65
AN/ARC-27.....	6-15		
AN/ARR-15.....	6-17	B	
AN/ART-13.....	6-19	BN.....	6-67
AN/BLR-1.....	6-139	BK.....	6-67
AN/BPA-2(XN-1).....	6-141		
AN/BPS-1.....	6-143	C	
AN/BPS-2.....	6-145	CU-255/UR.....	6-69
AN/BPS-4.....	6-147	CU-274/UR.....	6-71, 6-155
AN/BRD-3.....	6-149	CU-284/UR.....	6-73, 6-157
AN/FMQ-2.....	6-21	CU-332A/UR.....	6-75
AN/GRC-3 to AN/GRC-8.....	6-23		
AN/SRA-9.....	6-25	D	
AN/SRR-4.....	6-27, 6-161	DAS.....	6-77, 6-159
AN/SRR-11.....	6-89, 6-153	DAQ.....	6-79
	6-159	DAU.....	6-79
AN/SRR-12.....	6-89	DBE.....	6-81
AN/SRR-13.....	6-89, 6-159	DBM-1.....	6-83
AN/UPA-22.....	6-29		
AN/UPA-23.....	6-29	M	
AN/UPN-7.....	6-31, 6-161	MAR.....	6-85
AN/UPX-1.....	6-33, 6-147	MBF.....	6-87
	6-165		
AN/UPX-5.....	6-33, 6-147	R	
	6-165	RAK.....	6-89, 6-151
AN/URD-2.....	6-35		6-153, 6-159
AN/URD-4.....	6-37	RAL.....	6-89, 6-159
AN/URN-3.....	6-39	RAO.....	6-89
AN/URR-9.....	6-41	RRA.....	6-89, 6-153
AN/URR-13.....	6-73, 6-75		6-159
	6-113, 6-157	RBB.....	6-89
	6-169	RBC.....	6-89
AN/URR-21A.....	6-43	RBH.....	6-89
AN/URR-27.....	6-45	RBL.....	6-89
AN/URR-35A.....	6-47, 6-73	RBM.....	6-89
	6-157	RBO.....	6-89, 6-157
AN/URT-2.....	6-49		
AN/URT-3.....	6-50		
AN/URT-4.....	6-51		
AN/URT-6.....	6-55		
AN/URT-7.....	6-57		

Type	Page	Type	Page
		R	T
RBS.....	6-89	TBN.....	6-103
RCK.....	6-109	TBS.....	6.103. 6-105
RDR.....	6-91	TBU.....	6-103
RDZ.....	6-69, 6-71, 6.111 6-155, 6-167	TCE.....	6-103
		TCH.....	6-103
		TCJ.....	6-103
		TCK.....	6-103
		TCO.....	6-103
		TCP.....	6-103
		TCQ.....	6-103
		TCS.....	6.107. 6.159
		TCU.....	6-103
		TCX.....	6-103
		TCZ.....	6.103. 6.159
		TDA.....	6-103
		TDB.....	6-103
		TDE.....	6-103
		TDJ.....	6-103
		TDQ.....	6-109
		TDZ.....	6-69, 6-71, 6-111 6-155, 6-161, 6-167
		TED.....	6-73, 6-75, 6-113 6-157. 6-169
		S	
SCR-508.....	6.93		
SCR-510.....	6-95		
SCR-522.....	6.97		
SCR-528.....	6-93		
SCR-608.....	6-99		
SCR-609.....	6-101		
SCR-610.....	6-101		
SCR-624.....	6.163		
SCR-628.....	6-99		
		T	
TAD.....	6-103		
TAJ.....	6-103		
TAQ.....	6-103		
TBA.....	6-103		
TBK.....	6-103		
TBL.....	6.103. 6.159		
TBM.....	6-103		