

DEPARTMENT OF THE ARMY TECHNICAL MANUAL
DEPARTMENT OF THE NAVY PUBLICATION
DEPARTMENT OF THE AIR FORCE TECHNICAL ORDER

TM 11-487A-1
NAVEXOS P-2058
TO 31-3-73

MILITARY STANDARDIZATION HANDBOOK ELECTRONIC COMMUNICATION EQUIPMENT



Initial Increment to MIL-HDBK-161A, 12 March 1964

FSC MISC

DEPARTMENTS OF THE ARMY AND THE NAVY
WASHINGTON, D.C., 12 March 1964

This Military Handbook is issued for the use of all concerned.

By Order of the Secretaries of the Army and the Navy:

Official:

J. C. LAMBERT,
Major General, United States Army,
The Adjutant General.HAROLD K. JOHNSON,
General, United States Army,
Chief of StaffW. A. SCHOECH,
Vice Admiral, United States Navy,
Chief of Naval Material.

Distribution:

Active Army:

USASA (2)	USAARMS (6)	USAEMSA (100)	USAELRDL (24)
CNGB (3)	Letterkenny Army Dep (2)	USA Elt Mat Agcy (100)	Harry Diamond Lab (2)
CofEngrs (10)	Sacramento Army Dep (2)	USAADEA (1)	Natick Lab (4)
CC-E (10)	Lexington Army Dep (2)	Brooklyn Army Tml (2)	USAERDL (2)
CofT (10)	Tobyhanna Army Dep (2)	Boston Army Tml (2)	USA CBR Lab (1)
USAARTYBD (2)	Ft Worth Army Dep (2)	New Orleans Army Tml (2)	WSMR (2)
USARADB (2)	Sharpe Army Dep (3)	Beaver Army Tml (1)	Birmingham Proc Dist (1)
USAAESWBD (2)	Anniston Army Dep (1)	Hampton Roads Army Tml (1)	Birmingham Orlando Br Proc Dist (1)
USAIB (2)	Atlanta Army Dep (1)	Sunny Point Army Tml (1)	Boston Proc Dist (1)
USAMB (2)	Black Hills Army Dep (1)	Kings Bay Army Tml (1)	Boston Springfield Off Proc Dist (1)
USAECOM (50)	Blue Grass Army Dep (1)	Oakland Army Tml (1)	Chicago Proc Dist (1)
USAMC (10)	Charleston Army Dep (2)	APG (2)	Cincinnati Proc Dist (1)
USASMC (20)	Utah Army Dep (1)	Yuma PG (2)	Cleveland Proc Dist (1)
USAMICOM (10)	Columbus Army Dep (1)	USAEFG (6)	Detroit Proc Dist (1)
USAMUCOM (10)	Erie Army Dep (1)	Dugway PG (1)	Los Angeles Proc Dist (1)
USAWECOM (10)	Ft Wingate Army Dep (1)	Jefferson PG (1)	New York Proc Dist (1)
USATECOM (10)	Savanna Army Dep (1)	Erie PG (1)	New York Rochester Ofc Proc Dist (1)
USAMOCOM (10)	Granite City Army Dep (1)	USACDCADA (1)	Philadelphia Proc Dist (1)
USCONARC (10)	Memphis Army Dep (1)	USACDCARMA (1)	St Louis Proc Dist (1)
ARADCOM (2)	Schenectady Army Dep (1)	USACDCARTYA (1)	Philadelphia Pittsburgh Ofc Proc Dist (1)
OS Maj Comd (4)	Pueblo Army Dep (1)	USACDCAVNA (1)	San Francisco Proc Dist (1)
LOGCOMD (2)	Navajo Army Dep (1)	USACDCCAG (1)	Sig Fld Maint Shops (2)
Armies (2) except First USA (4)	New Cumberland Army Dep (1)	USACECDA (Ft Huachuca) (1)	Units organized under following TOE's:
Ft Mason (2)	Red River Army Dep (1)	USACECDA (Ft Monmouth) (1)	11-5 (1) 11-555 (1)
Ft McClellan (2)	Seneca Army Dep (1)	USACDCEA (1)	11-15 (1) 11-558 (1)
Ft Ord (2)	Sierra Army Dep (1)	USACDCIA (1)	11-22 (1) 11-587 (1)
Ft Bragg (2)	Sioux Army Dep (1)	USACDCINTA (1)	11-55 (1) 11-592 (1)
Ft Shafter (1)	Tooele Army Dep (1)	USACDCSWA (1)	11-95 (1) 11-597 (1)
USMA (2)	Umatilla Army Dep (1)	USACDCTA (1)	11-155 (1)
USACGSC (4)	USASCC (2)	USACDCQMA (1)	
USAAMS (6)	USAAVNC (4)	USACDCOA (1)	
USAADS (4)	WRAMC (1)	USACDCBRA (1)	
USAIS (6)	USAADC (1)		
USASCS (10)	BAMC (1)		
USASESCS (6)	USAATC (1)		

NG: State AG (3).

USAR: None.

For explanation of abbreviations used, see AR 320-50.

ELECTRONIC COMMUNICATION EQUIPMENT

	Paragraph	Page
INTRODUCTION		
Purpose.....	1	i
Scope.....	2	i
Arrangement of Content.....	3	i
Appendices.....	4	ii
Details of Coverage.....	5	ii
Type Classification Definitions.....	6	ii
Currency of Information.....	7	iii
Data Not Available.....	8	iii
EQUIPMENT		
Item Indicator Letters.....		iv
List of Type Indicators.....		v
Item Descriptions.....		1
APPENDIXES		
A—Glossary of Abbreviations.....		229
B—Index of Items by Type Numbers.....		233

INTRODUCTION

1. Purpose

This publication presents data and information on the technical, physical, operational, and logistical characteristics of electronic communication equipment used in the Department of Defense. It is intended primarily for the use of standardization, design, development, procurement and maintenance activities of the Department of Defense, and in the technical planning and coordinating of logistical operations involving the use and maintenance of military equipment in a theater of operations.

2. Scope

This publication contains information on electronic communication equipment that is used or is available for use by the Army, the Navy, and the Air Force. It covers radio, switchboards and switching, repeaters and repeating, carrier, teletypewriter, intercommunication and public address, facsimile, light signalling, television, and miscellaneous equipment used for communication and in related systems at all command levels. Equipment covered are end-items, and those component parts thereof, which can be, and are, authorized for use as operating end-items, or which are issued as major operating component parts of two or more end-items.

3. Arrangement of Content

a. Items of equipment are arranged and identi-

This increment supersedes that portion of MIL-HDBK-161 (TM 11-487A) 11 June 1959, covering equipment of the AN/AIC through A/NFRC type. (See paragraph 3, INTRODUCTION.)

fied in accordance with official nomenclature type designations of the Joint Electronics Type Designation System, or "AN/" system, per MIL-STD-196 (latest issue).

b. Items of equipment with service, commercial, or other nomenclature system type designations are arranged under the most appropriate TYPE NUMBER indicators of the AN/system. Within each set, or series, of basic AN/TYPE designations equipment is arranged alphabetically and numerically.

EXAMPLES:

AN/ARC-33	RAG
AN/ARC-34	RBF
AN/ARC-36	RBG
AN/ARC-type	AN/GRR-3
SCR-274	AN/GRR-5
SCR-522	AN/GRR-7
SCR-542	AN/GRR-type
AN/FRR-3	BC-312
AN/FRR-4	R-247/URR
AN/FRR-7	RCF
AN/FRR-type	

Note. Assignment of an item to a particular type designation Grouping is arbitrary, and should not be construed as a limitation or indication that this equipment is suitable for use only as implied by its placement herein.

c. A table of Item Indicator Letters, following this Introduction, is a listing of the meanings assigned to the first, second, and third letters of the three-letter group following the "AN/" of the Joint Electronic Type Designation System.

4. Appendixes

a. Appendix A is a Glossary of Abbreviations used in this publication. The abbreviations are listed in alphabetical order with the exact terminology of the word or phrase for which the abbreviation is used.

b. Appendix B contains a complete listing of all items covered in this publication, arranged in alpha-numerical order by assigned type number, regardless of whether the type number was assigned by a specific department or under the Joint Electronics Type Designation System. Commercial equipments are listed by their makers' identification designation within this appendix. Items that do not have set designations of the "AN/" system can be readily located by reference to appendix B.

5. Details of Coverage

Descriptions of individual items of equipment in this publication are all organized in a standard format following the requirement of MIL-D-19731A.

a. Normally the latest model (or models) of equipment are used as a basis of the descriptive matter. The nomenclature type-designation printed at the top of each page indicates the specific item or model of an item covered. The use of parentheses () in the type-designation is intended to indicate coverage of more than one model of the item; if only specific items are covered, each such item is at the top of each page of that entry.

b. The meaning of the various terms used to describe the status—or type classification—of items of equipment covered in this document are defined in paragraph 6. Also included in this publication are items which have not been assigned formal or official type classification, but which have been issued and are available for, or are in, current use.

c. Where available, a photograph of each item of equipment has been included. Some larger, complex items may be illustrated with stylized drawings. The photograph often does not show the entire equipment—most minor accessories have been deleted from the photographs, and some of the illustrations may not show all the major operating components.

d. Data pertaining to the major units usually covers only the major operating component parts. To conserve space, power equipment often is not

included. Such accessory items as headsets, handsets, and antennas generally are not included. Interconnecting cables and wire, etc., are not listed, even though these may be furnished with the item of equipment. In general, where a complete detailed listing of components is needed, refer to the appropriate supply documents that pertain to the specific item of equipment concerned.

6. Type Classification Definitions

a. U.S. Army Definitions.

- (1) *Standard A (STD-A)*. The most advanced and satisfactory items currently available to fill operational requirements.
- (2) *Standard B (STD-B)*. Items which have limited acceptability to fill operational requirements. These items are normally used and issued as substitutes for Standard A items.
- (3) *Standard C (STD-C)*. Items which have only marginal acceptability for operating requirements, and are being forced out of the system as stocks of more acceptable items become adequate to meet requirements.
- (4) *Limited Production Type (LP)*. An item under development, commercially available, or available from other Government agencies, for which an urgent operational requirement exists and for which no other existing item is adequate; which appears to fulfill an approved qualitative materiel requirement or other DA approved requirements, and to be promising enough operationally to warrant initiating procurement and/or production for troop issue prior to completion of development and/or test or adoption as a standard item.
- (5) *Limited Standard Type (LS)*. Items which are not acceptable for United States Army operational requirements and will not, therefore, be counted as assets against operational requirements. Items in this category will be limited to:
 - (a) Those which are not acceptable to meet operational requirements, but which are useful in training.
 - (b) Those which are not acceptable to meet operational requirements of the United States Army, but which are

being retained to meet peculiar requirements other than those in (a) above. Items will be classified under the provisions of this paragraph only at the request of the Deputy Chief of Staff for Logistics, Department of the Army.

- (6) *Obsolete (OBS)*. Items which are no longer acceptable for United States Army use.
- b. *U.S. Navy Definitions*.
- (1) *Standard*. The most advanced and satisfactory articles adopted are those which are preferred for procurement.
 - (2) *Limited Standard*. Articles which do not have satisfactory military characteristics as standard articles, but are usable substitutes for standard articles. Complete major units will not be procured, but component parts and accessories and complementary articles, even though they may be limited standard articles, may be procured if necessary and economical, to maintain the complete major units in serviceable condition throughout a reasonable life expectancy.
 - (3) *Substitute Standard*. Articles which do not have as satisfactory military characteristics as standard articles and, when necessary, may be procured to supplement the supply of standard articles.
 - (4) *Planned Standard*. Those articles under evaluation which have been indicated by the Ship Characteristics Board for installation through the Ship Improvement Guide or new construction and conversion projects. Approval for service use prior to installation is required for articles in this category.
 - (5) *Obsolescent*. Those articles which do not have satisfactory military characteristics. Complete units, component parts, accessories, and complementary articles normally will not be procured for the specific purpose of maintaining this equipment; however, spare parts common to other equipment in the supply establishment may be used for their maintenance.

- (6) *Obsolete*. Those articles that have been declared unsuitable for their original military purpose. Disposal of stocks of obsolete articles will, in all cases, be expedited.

c. *U.S. Air Force Definitions*.

- (1) *Standard*. An item that meets an established need and is considered suitable for Air Force use.
- (2) *Alternate Standard*. An item that may not be so satisfactory as a standard item, but which is a usable alternate for procurement in quantity in place of the standard item when the standard item cannot be procured in quantities to satisfy Air Force needs.
- (3) *Limited Standard*. An item in stock that is not so satisfactory as either standard or alternate standard items but which is usable in place thereof. Limited standard items may be used until stocks are exhausted. Limited standard end items will not be procured. Additional parts and components may be procured when necessary to maintain the item in serviceable condition.
- (4) *Tentative Standard*. An item that appears promising enough operationally to warrant the risk of initiating production of limited quantities prior to the completion of development or prior to completion of testing.
- (5) *Obsolete*. An item that no longer meets Air Force needs.

7. Currency of Information

Information and data in this publication are current as of the date printed on the first page of coverage for each item of equipment.

8. Data not Available

Blank spaces have been left under appropriate headings, to permit the user of this publication to enter any data that could not be determined during preparation.

ITEM INDICATOR LETTERS

1st Letter Installation	2d Letter Type of equipment	3d Letter Purpose
<p>A—Airborne (installed and operated in aircraft).</p> <p>B—Underwater mobile, submarine.</p> <p>C—Air transportable (inactivated, do not use).</p> <p>D—Pilotless carrier.</p> <p>F—Fixed.</p> <p>G—Ground, general ground use (include two or more ground type installations).</p> <p>K—Amphibious.</p> <p>M—Ground, mobile (installed as operating unit in a vehicle which has no function other than transporting the equipment).</p> <p>P—Pack or portable (animal or man).</p> <p>S—Water surface craft.</p> <p>T—Ground, transportable.</p> <p>U—General utility (includes two or more general installation classes, airborne).</p> <p>V—Ground, vehicular (installed in vehicle designed for functions other than carrying electronic equipment, etc., such as tanks).</p> <p>W—Water surface and underwater.</p>	<p>A—Invisible light, heat radiation.</p> <p>B—Pigeon.</p> <p>C—Carrier.</p> <p>D—Radiac.</p> <p>E—Nupac.</p> <p>*F—Photographic.</p> <p>G—Telegraph or teletype.</p> <p>I—Interphone and public address.</p> <p>J—Electro-mechanical or inertial wire covered.</p> <p>K—Telemetering.</p> <p>L—Countermeasures.</p> <p>M—Meteorological.</p> <p>N—Sound in air.</p> <p>P—Radar.</p> <p>Q—Sonar and underwater sound.</p> <p>R—Radio.</p> <p>S—Special types, magnetic, etc., or combinations of types.</p> <p>T—Telephone (wire).</p> <p>V—Visual and visible light.</p> <p>W—Armament (peculiar to armament, not otherwise covered).</p> <p>X—Facsimile or television.</p> <p>Y—Data Processing.</p>	<p>A—Auxiliary assemblies (not complete operating sets used with or part of two or more sets or sets series).</p> <p>B—Bombing.</p> <p>C—Communications (receiving and transmitting).</p> <p>D—Direction finder, reconnaissance, and/or surveillance.</p> <p>E—Ejection and/or release.</p> <p>G—Fire control or searchlight directing.</p> <p>H—Recording and/or reproducing (graphic meteorological and sound).</p> <p>K—Computing.</p> <p>L—Searchlight control (inactivated, use G).</p> <p>M—Maintenance and test assemblies (including tools).</p> <p>N—Navigational aids (including altimeters, beacons, compasses, racons, depth sounding, approach, and landing).</p> <p>P—Reproducing (inactivated, do not use).</p> <p>R—Receiving, passive detecting.</p> <p>S—Detecting and/or range and bearing, search.</p> <p>T—Transmitting.</p> <p>W—Automatic Flight or Remote Control.</p> <p>X—Identification and recognition.</p>

*Not for United States use except for assigning suffix letters to previously nomenclatured items.

LIST OF TYPE INDICATORS

Type Indicator	Page		Page
AN/AIC.....	1	AN/FCC.....	91
AN/ARA.....	15	AN/FGA.....	107
AN/ARC.....	19	AN/FGC.....	109
AN/ARN.....	67	AN/FGQ.....	154
AN/ARR.....	69	AN/FGR.....	159
AN/ART.....	77	AN/FIC.....	163
AN/BRA.....	85	AN/FRA.....	183
AN/CRT.....	87	AN/FRC.....	193

INTERPHONE EQUIPMENT
AN/AIC-2, -2A

12 November 1958
 Cog Serv: USAF FSN:
 USA Line Item No:

	USA	USN	USAF	USMC
STATUS OR TYPE CLASS.:			L/Std	

Manufacturer:

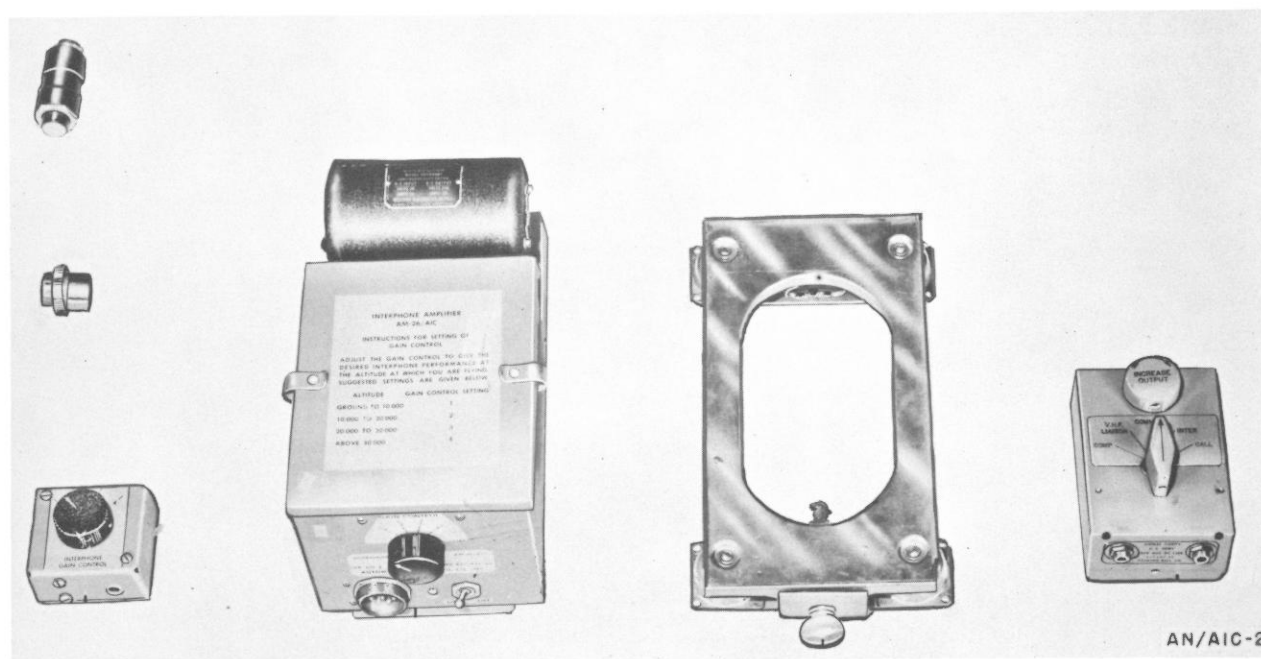

FUNCTIONAL DESCRIPTION:

Interphone Equipments AN/AIC-2 and AN/AIC-2A are lightweight, high altitude (40,000 feet) multiplane aircraft communication units used by interceptor fighters and light medium bombers to provide interphone communication between the various interphone stations. They are operated by a push-to-talk button on the microphone.

The AN/AIC-2 is a high impedance unit used with radio equipment connected for high impedance output; the AN/AIC-2A is a low impedance unit used with radio equipment connected for low impedance output.

RELATION TO SIMILAR EQUIPMENT:

TECHNICAL CHARACTERISTICS:

Facilities: Affords operation of 15 stations (max), each capable of selecting compass, vhf liaison, command, interphone, and call circuits.

Type Controls: Each station has a manual volume control and a 5-position rotary switch for selection of any circuit from the following: compass, vhf liaison, command, interphone, and call. Interphone Amplifier AM-26/AIC can be controlled either by its local gain control or by means of Remote Gain Control C-97/AIC-2. Interphone Amplifier AM-26A/AIC is controlled by Automatic Gain Control C-158/AIC which is included in the amplifier case.

INTERPHONE EQUIPMENT

AN/AIC-2, -2A

Pwr Output: 4w into a 250-ohm load.

Distortion: 6%.

Pwr Requirements: 1.7 amp at 24- to 28-v dc.

Major Units:

AM-26/AIC()

9 $\frac{3}{4}$ " x 5 $\frac{1}{4}$ " x 5 $\frac{1}{8}$ "

6.8 lbs

TUBES, CRYSTALS, TRANSISTORS:

REFERENCE DATA AND LITERATURE:

12R2-2AIC2-2, -14.

INTERPHONE EQUIPMENT

AN/AIC-3

12 November 1958
 Cog Serv: USF FSN:
 USA Line Item No:

	USA	USN	USAF	USMC
STATUS OR TYPE CLASS.:			L/Std	

Manufacturer:

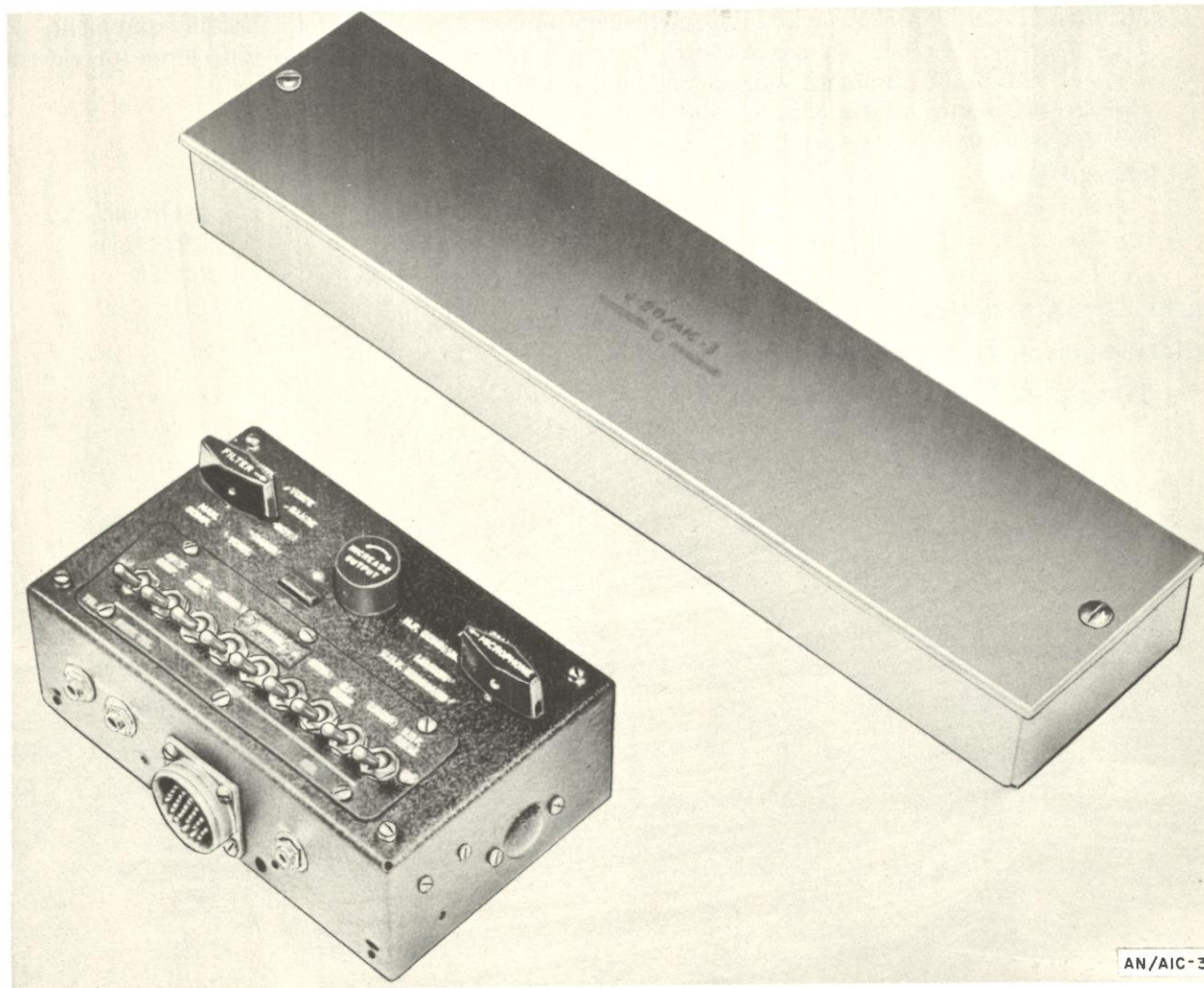
**FUNCTIONAL DESCRIPTION:**

Interphone Equipment AN/AIC-3 is an airborne interplane, intraplane, and air-to-ground intercommunication system having not less than two nor more than five interphone stations. It is designed for aircraft requiring not more than five master stations with all control facilities available at each station. The system normally is supplied for light bombers and cargo aircraft.

This equipment has five functions: voice communications between any or all interphone stations; individual selections at each station of the audio output of eight receivers; means of switching the

INTERPHONE EQUIPMENT

AN/AIC-3

microphone to any one of three transmitters or to interphone; a call facility whereby all positions may be called by voice regardless of the microphone or facility switch setting at any of the call stations; and a filter facility whereby the output signal of the automatic radio compass receiver may be fed through a radio range filter—at each interphone station—to the operator.

RELATIONSHIP TO SIMILAR EQUIPMENT:**TECHNICAL DESCRIPTION:**

Facilities: Affords intraplane and interplane communication and control for radio equipment.

Type Controls: Manual; 3-position switch for voice, range, or both; 5-position switch for vhf command, liaison, hf command transmitters, and interphone call.

Pwr Output: 60 mv at 600 ohms impedance (per unit).

Pwr Requirements: 0.445 amp (per station) at 24- to 28-v dc.

Major Units:

2 to 5	C-166()/AIC-3	$8\frac{3}{4}'' \times 5\frac{3}{4}'' \times 3\frac{3}{16}''$	4.0 lbs ea
2 to 5	F-21/ARA-9	$3\frac{3}{4}'' \times 2\frac{3}{4}'' \times 2\frac{1}{2}''$	1.62 lbs ea
1	J-90/AIC-3	$20\frac{3}{32}'' \times 4\frac{5}{64}'' \times 2\frac{1}{16}''$	3.3 lbs

TUBES, CRYSTALS, TRANSISTORS:**REFERENCE DATA AND LITERATURE:**

TO 12R2-2AIC-14, -1, -2.

12 November 1958
 Cog Serv: ASAF FSN
 USA Line Item No:

USA	USN	USAF	USMC
		L/Std	

STATUS OR TYPE CLASS.:

L/Std

Manufacturer:

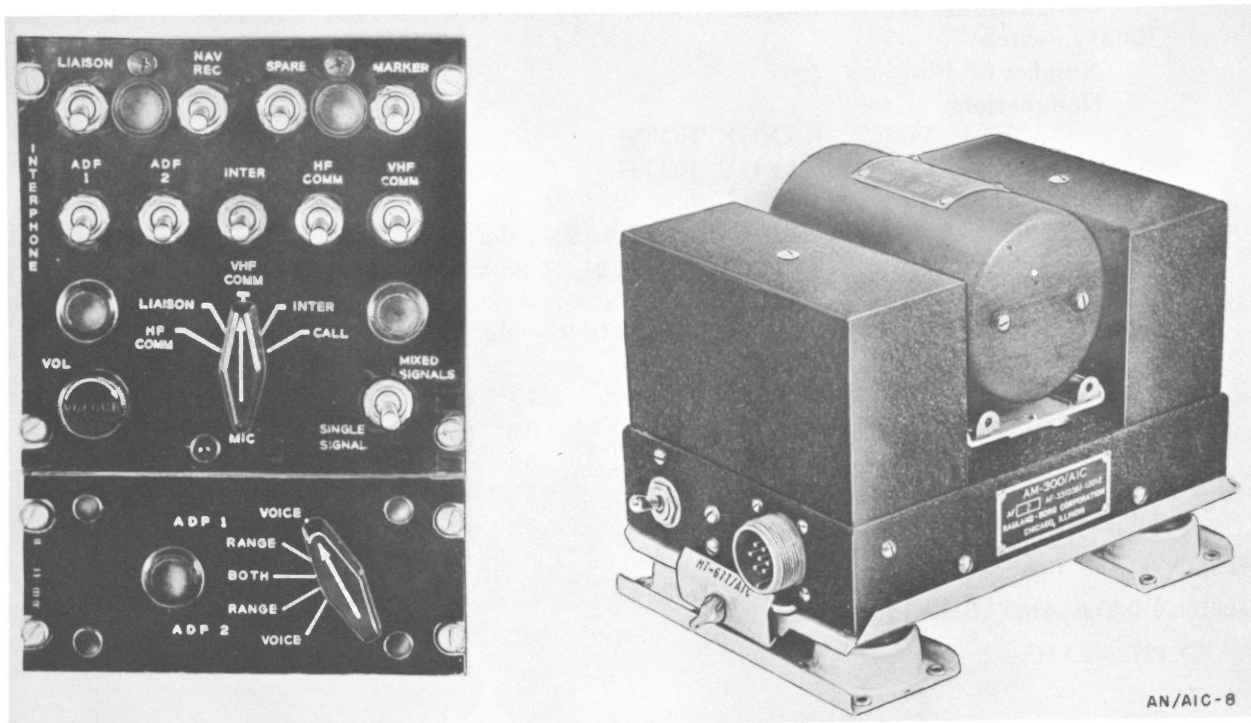

FUNCTIONAL DESCRIPTION:

Intercommunication Set AN/AIC-8 is an aircraft intercommunication and intraplane system having not less than two nor more than five interphone stations, as well as a number of auxiliary stations. The maximum combined total of the interphone and auxiliary stations is 20. The system normally is installed on fighter bombers and cargo, as well as on transport aircraft.

Basically the equipment consists of an audio amplifier (including dynamotor), an interphone control, and filter assembly components.

The filter assembly permits reception of either one or both ADF receivers.

RELATION TO SIMILAR EQUIPMENT:

TECHNICAL DESCRIPTION:

Facilities: Affords voice communication between any or all interphone stations, individual selection at each interphone station of the audio output of eight receivers and of the intercommunication system; also provides a means of switching a microphone to any of three transmitters or the intercommunication system; all stations may be called by voice regardless of the setting of the microphone or the receiver switches at any of the stations.

INTERCOMMUNICATION SET

AN/AIC-8*Type Controls:*

Operation: Manual.

Toggle Switches:

Number: 9.

Designations. LIAISON, NAV REC, SPARE, MARKER, ADF 1, ADF 2, INTER, HF COMM, VHF COMM.

Rotary Switch:

Number of Positions: 5.

Designations: HF COMM, LIAISON, VHF COMM, INTER, CALL.

Rotary Switch:

Number of Positions: 5.

Designations:

ADF 1: VOICE, RANGE, BOTH.

ADF 2: VOICE, RANGE, BOTH.

Pwr Requirements:

AF Amplifier AM-300/AIC: 1.6 amp at 24- to 28-v dc.

Mixer Amplifier AM-142/AIC: 0.16 amp at 24- to 28-v dc.

Interphone Control C-633/AIC-8: 0.2 amp at 24- to 28-v dc.

Filter Assembly F-90/AIC: 0.04 amp at 24- to 28-v dc.

Major Units:

1 (as required)---	AM-300/AIC-----	7½'' x 4 ⁵ / ₁₆ '' x 5 ³ / ₁₆ ''-----	6.3 lbs
1 (as required)---	F-90/AIC-----	5¾'' x 2 ⁵ / ₈ '' x 3¾''-----	
1 (as required)---	C-633/AIC-8-----	5¾'' x 5 ⁵ / ₈ '' x 3¾''-----	2.3 lbs
1 (as required)---	J-139A/AIC-----	3 ³ / ₈ '' x 2'' x 2''-----	.3 lb
1 (as required)---	-----	5¼'' x 6'' x 1¾''-----	1.9 lbs

TUBES, CRYSTALS, TRANSISTORS:**REFERENCE DATA AND LITERATURE:**

TO 12R2-2AIC8-2, -14.

INTERCOMMUNICATION SET
AN/AIC-10, -10A

12 November 1958
Cog Serv: USAF FSN:
USA Line Item No:

	USA	USN	USAF	USMC
STATUS OR TYPE CLASS.:			L/Std	

Manufacturer: Andrea Radio Corp

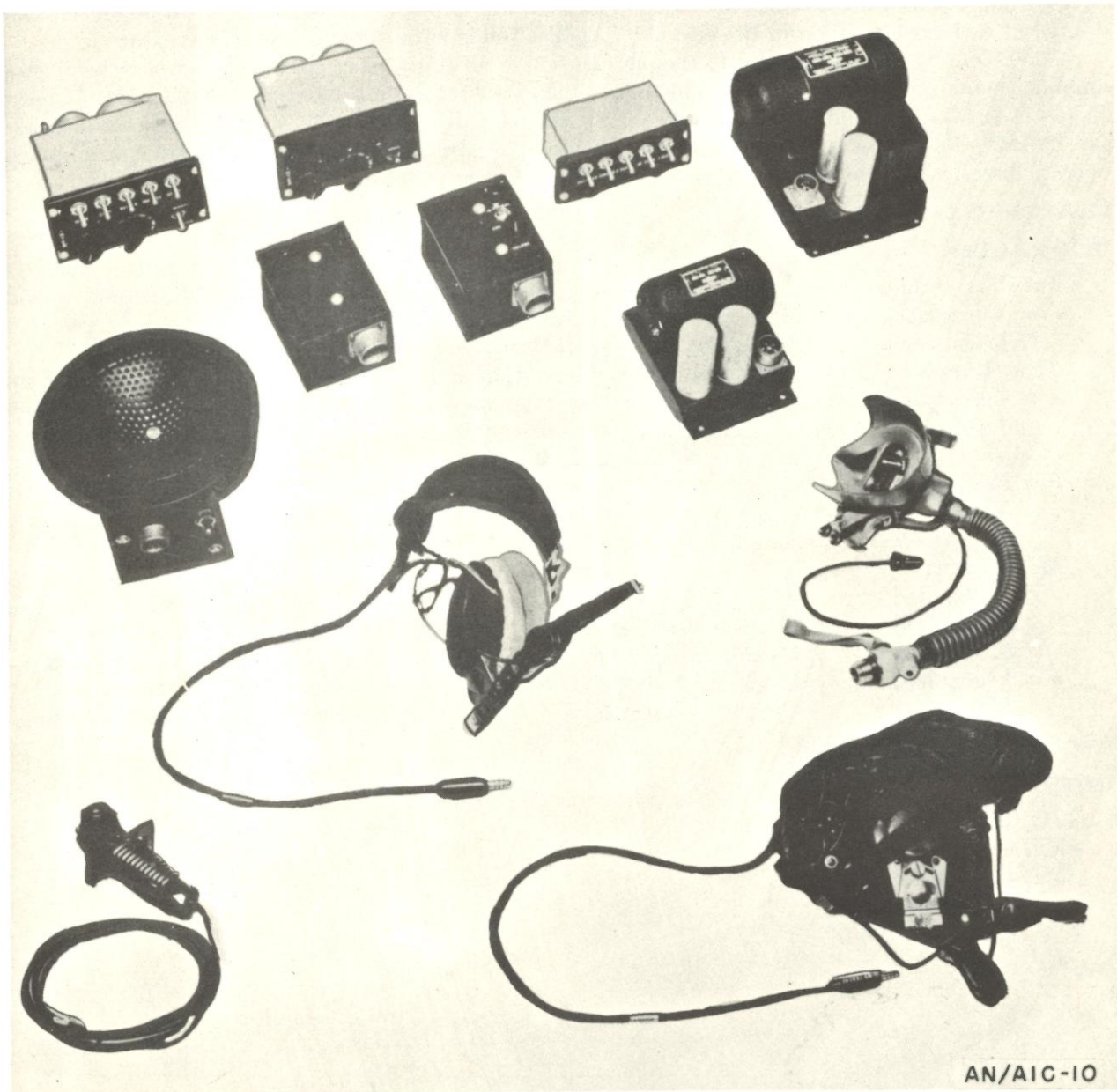

AN/AIC-10

INTERCOMMUNICATION SET

AN/AIC-10, -10A

FUNCTIONAL DESCRIPTION:

Intercommunication Set AN/AIC-10 and AN/AIC-10A are communication equipments designed for maximum exclusion of ambient acoustic distortion and for improved stability at high altitudes. Further, they provide electronic automatic gain control, give good signal-to-noise ratio under extreme noise conditions, and improved intelligibility at high altitudes, with excellent reliability.

These equipments consist of a line of dynamic microphones, connectors, cables, interphone controls and accessories, an amplifier and headsets. An interphone system for any specific aircraft is made up by selecting items from this line of equipment that will provide the particular interphone facilities desired at each crew position in the aircraft. Application is in all types of military aircraft.

The AN/AIC-10A is identical to the AN/AIC-10 in all respects except as follows: a transistorized amplifier is used in place of the vacuum tube amplifier in Interphone Control C-823/AIC-10, Control Panels C-824/AIC-10 and C-825/AIC-10, Relay Assembly RE-94/AIC-10, and Dynamic Loudspeaker LS-184/AIC-10. Dynamotor high voltage power supplies are eliminated since the transistor amplifiers operate directly from the 28-volt direct current aircraft power supply.

RELATION TO SIMILAR EQUIPMENT:

TECHNICAL DESCRIPTION:

Facilities: Affords partial control and intermixing of a maximum of 10 receiver outputs, talking on 6 positions; loudspeaker monitoring and automatic volume compression; automatic gain control; and communication beyond the aircraft through means of radio equipment.

Type Controls: 5 to 10 toggle switches for audio output of 5 to 10 receivers; 6-position rotary switch to permit talking over private interphone, command, liaison, intercommunication, interphone and call circuits; mixing or single-receiver; monitoring; loudspeaker when desired.

Pwr Output: 200 mw (nominal) per interphone station.

Pwr Requirements:

AN/AIC-10: 450 ma at 27.5-v dc (nominal) per interphone station.

AN/AIC-10A: 330 ma at 27.5-v dc (nominal) per interphone station.

Major Units:

As required	AM-843/AIC-10	5 ²¹ / ₃₂ " x 4 ²¹ / ₃₂ " x 2 ³ / ₄ "	2.95 lbs
As required	C-824()/AIC-10	5 ³ / ₄ " x 3 ³ / ₄ " x 6 ²¹ / ₃₂ "	3.3 lbs
As required	C-825()/AIC-10	5 ³ / ₄ " x 3 ³ / ₄ " x 6 ²¹ / ₃₂ "	3.1 lbs
As required	C-826/AIC-10	5 ³ / ₄ " x 2 ⁵ / ₈ " x 3 ⁹ / ₁₆ "	0.9 lb
As required	C-823()/AIC-10	5 ⁷ / ₁₆ " x 3 ⁵ / ₈ " x 4 ³ / ₈ "	2.1 lbs

TUBES, CRYSTALS, TRANSISTORS:

REFERENCE DATA AND LITERATURE:

TO 12R2-2AIC10-1, -2, -4.

MIL-I-26122(USAF).

MIL-I-6699(USAF).

MIL-I-6699A(USAF).

PUBLIC ADDRESS SET

AN/AIC-13

12 November 1958
 Cog Serv: U AF FSN:
 USA Line Item No:

	USA	USN	USAF	USMC
STATUS OR TYPE CLASS.:			Std	

Manufacturer: Radio Corp of America

No Illustration Available

FUNCTIONAL DESCRIPTION:

Public Address Set AN/AIC-13 is an announcing system that provides a communications in areas where the ambient noise level is high. It may be effectively employed in directing loading operations or in giving instructions to maintenance crews. Further, it may be used in providing entertainment and radio reception for passengers or in announcing instructions and messages to flying personnel.

This equipment is designed to be operated with Intercommunication Sets AN/AIC-10, AN/AIC-10A, and AN/AIC-18.

The system can be installed for use in cargo and bomber type aircraft. It provides loudspeaker communication from aircraft to ground or within the aircraft.

RELATION TO SIMILAR EQUIPMENT:

TECHNICAL DESCRIPTION:

Facilities: Audio Frequency Amplifier AM-944/AIC-13 is capable of operating up to four loudspeakers simultaneously. When area and ambient requirements demand more power and more coverage, up to three amplifiers may be operated from Public Address Set Control C-1614/AIC-13. When operating conditions do not require the use of this panel, amplifiers may be connected in parallel, each driving four Magnetic Loudspeakers LS-211/AIC-13. In installations requiring high power external announcing, Audio Frequency Amplifier AM-944/AIC-13 is equipped with relays so that one or another Magnetic Loudspeaker LS-211/AIC-13 may be operated individually or in unison.

Type Controls: Public Address Set Control C-1614/AIC-13 has a volume control circuit arranged so that loudspeaker volume may be directly adjusted or remotely controlled from any loudspeaker position. The control also has a four-position rotary switch for selection of individual or a combination of loudspeakers. Five monitoring facility switches are available to provide radio reception.

Pwr Output: 20 w (nominal) per amplifier.

Pwr Requirements:

Audio Frequency Amplifier AM-944/AIC-13:

Standby: 0.04 amp at 27-v dc.

One Loudspeaker: 1.1 or 1.22 at 27-v dc.

Two Loudspeakers: 1.22 amp at 27-v dc.

Four Loudspeakers: 1.34 amp at 27-v dc.

Public Address Set Control C-1614/AIC-13:

Standby: 0.12 amp at 27-v dc

Monitor Reaction: 0.16 amp at 27-v dc.

P. A. Announce: 0.24 amp at 27-v dc.

Major Units:

1	AM-944/AIC-13	5 $\frac{3}{4}$ " x 5 $\frac{1}{2}$ " x 3 $\frac{3}{4}$ "	5 lbs
1	C-1614/AIC-13	5 $\frac{3}{4}$ " x 3 $\frac{3}{4}$ " x 4"	2 lbs

TUBES, CRYSTALS, TRANSISTORS:

PUBLIC ADDRESS SET

AN/AIC-13

REFERENCE DATA AND LITERATURE:

TO 12R2-2AIC13-2, -3, -4.

MIL-A-25546; MIL-L-25547; MIL-G-25548.

AN/AIC-18

July 1962
 Cog Serv: USAF FSN
 USA Line Item No:

	USA	USN	USAF	USMC
STATUS ON TYPE CLASS.:			Std	
Manufacturer: Andrea Radio Corp				

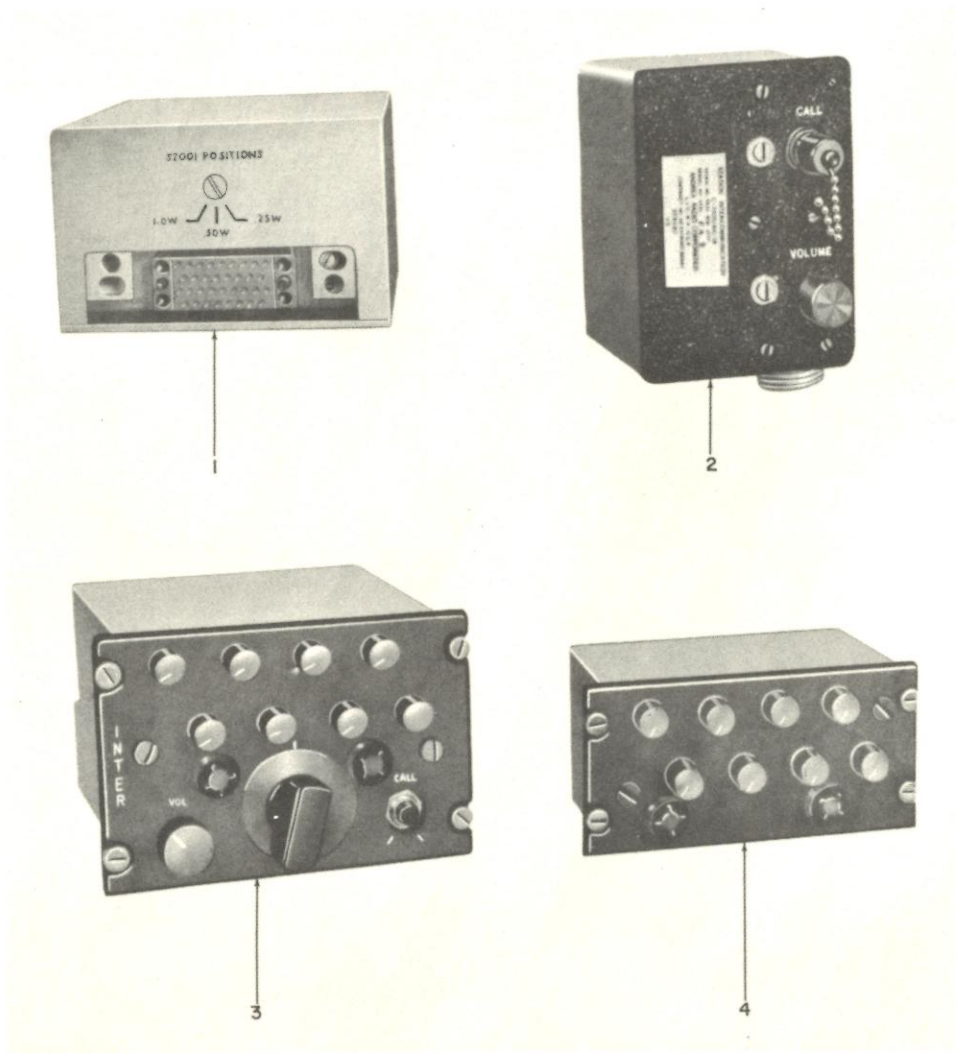

FUNCTIONAL DESCRIPTION:

Intercommunication Set AN/AIC-18 provides high intelligibility intercommunication and radio monitoring facilities for aircraft and ground installations. It also provides for selection, control and modulation of radio transmitters for communication with other airborne, ground, or mobile stations.

RELATION TO SIMILAR EQUIPMENT:

INTERCOMMUNICATION SET

AN/AIC-18

TECHNICAL DESCRIPTION:

Facilities: Any number of Intercommunication Set Controls, Stations and monitor Panels may be used in an installation to provide intercommunication, monitoring and transmitter operation facilities. Five radio transmitters (or transceivers) can be operated and modulated by each Intercom Set Control. Other variations involving public address systems and private interphone facilities are possible.

Type Controls: Selector switch (rotary) selects the desired radio transmitter or interphone line. Call switch connects the amplifier microphone output to call audio line. Hot Mic Talk switch connects amplifier microphone output to hot-mic line for hand free intercommunication. Monitor switch volume controls (7) switches monitored signal on or off and adjusts the signal level.

Pwr Output: 1 w (max) per interphone station.

Pwr Requirements: 27.5 v dc 15 w (nominal).

Major Units:

As required	C-2105/AIC-18	$5\frac{1}{8}'' \times 4\frac{3}{8}'' \times 3\frac{5}{8}''$	2.4
As required	C-2106/AIC-18	$5\frac{3}{4}'' \times 6\frac{25}{32}'' \times 3\frac{3}{4}''$	3.95
As required	C-2322/AIC-20	$5\frac{3}{4}'' \times 4\frac{21}{64}'' \times 2\frac{5}{8}''$	1.3
As required	AM-1964/AIC		
As required	AM-1965/AIC		

TUBES, CRYSTALS, TRANSISTORS:

REFERENCE DATA AND LITERATURE:

TO 12R2-2A1C18-2, -4.

INTERCOMMUNICATION SET
AN/AIC-20

July 1962
 Cog Serv: USAF FSN:
 USA Line Item No:

USA USN USAF USMC

STATUS OR TYPE CLASS:

Manufacturer: Collins Radio Corp

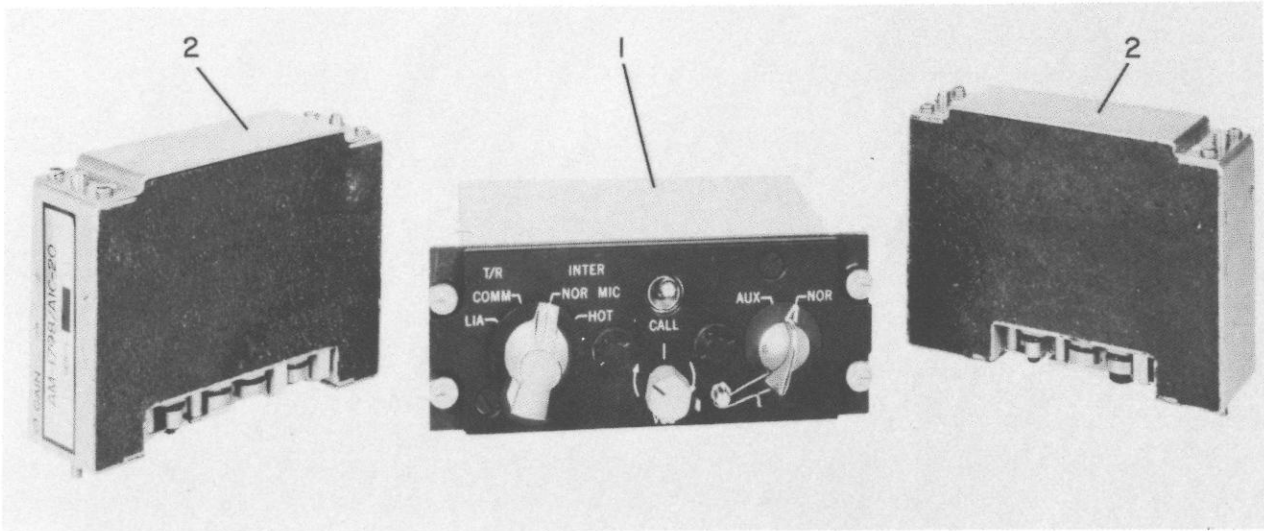

FUNCTIONAL DESCRIPTION:

The purpose of Intercommunication Set AN/AIC-20 is to provide a means of controlling the audio circuits associated with various receivers, transmitters, and audio signal circuits in the aircraft, and to provide interphone communications in the aircraft.

RELATION TO SIMILAR EQUIPMENT:

TECHNICAL DESCRIPTION:

Controls—type and function:

T/R LIA: Permits transmission with liaison transmitter and reception of all receiver outputs.

T/R COMM: Permits transmission with command transmitter and reception of all receiver outputs.

Inter NOR MIC: Permits normal interphone operation upon depression of push-to-talk switch.

Inter Hot MIC: Permits normal interphone operation without use of push-to-talk switch.

Pwr Requirements: +27.5 v DC, 410 ma (max)

Major Units:

1 C-2322/AIC-20	2¼" x 4½" x 5¾"	1.5 lbs
1 AM-1784/AIC-20	1 ²⁷ / ₆₄ " x 3¼" x 4 ²⁷ / ₆₄ "	0.8 lbs
1 AM-1798/AIC-20	1 ²⁷ / ₆₄ " x 3¼" x 4 ²⁷ / ₆₄ "	0.86 lbs

TUBES, CRYSTALS, TRANSISTORS:

REFERENCE DATA AND LITERATURE:

TO 12R5-2ARN61-2

TO 12R2-2AIC20-4

IMPULSE TRANSLATING EQUIPMENT

AN/ARA-15

15 March 1962
 Cog Serv: USN FSN:
 USA Line Item No.:

USA	USN	USAF	USMC
-----	-----	------	------

STATUS OR TYPE CLASS.:

Manufacturer:

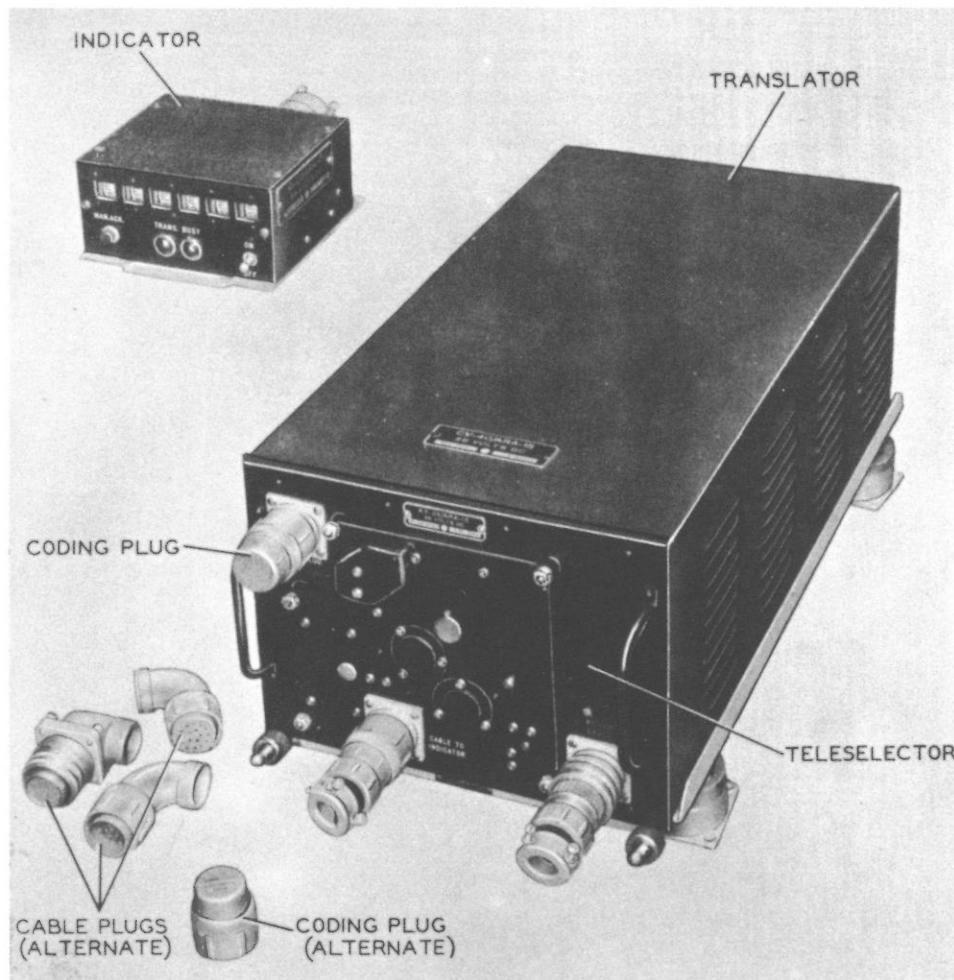

FUNCTIONAL DESCRIPTION:

Impulse Translating Equipment AN/ARA-15 decodes and acknowledges signals from Impulse Keying Equipment Model CXJV, shipborne or shore station equipment. The equipment is used in conjunction with radio communication equipment of the aircraft and of the ship. It will translate a coded message from a ship or shore station and visually display the message in the aircraft. The visual message consists of six ideograms or symbols.

RELATION TO SIMILAR EQUIPMENT:

The equipment is used with, but not part of, Navy Model Impulse Keying and Signaling Equipment CXJV.

IMPULSE TRANSLATING EQUIPMENT

AN/ARA-15

TECHNICAL DESCRIPTION:

Audio Signal Range: 350-3000 cps.

Operating Power Requirements: 28 v dc.

Major units:

1 CV-40/ARA-15

9 $\frac{5}{16}$ " x 11 $\frac{7}{16}$ " x 25 $\frac{3}{8}$ "

34.5 lbs

1 ID-215/ARA-15

2 $\frac{5}{8}$ " x 5 $\frac{3}{32}$ " x 6 $\frac{1}{2}$ "

2.77 lbs

TUBES, CRYSTALS, TRANSISTORS:

REFERENCE DATA AND LITERATURE:

CO-NAVAER 16-30ARA15-507.

15 March 1962
 Cog Serv: USN FSN:
 USA Line Item No.:

USA USN USAF USMC

STATUS OR TYPE CLASS.:

A/Std

Manufacturer: CBJK (43999)

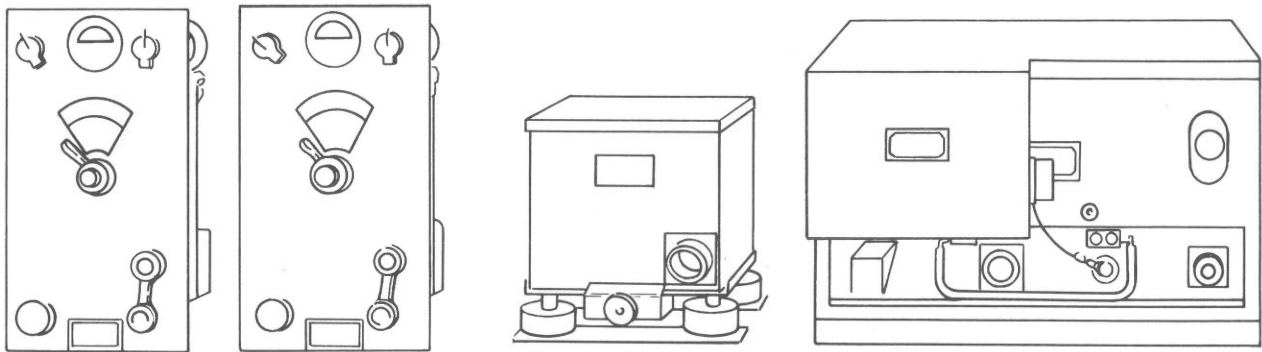

FUNCTIONAL DESCRIPTION:

Remote Tuning Group AN/ARA-19 is used with Radio Compass AN/ARN-6. It provides an accurate means for electrically repositioning the radio compass tuning mechanism without the use of mechanical linkage.

RELATION TO SIMILAR EQUIPMENT:

TECHNICAL DESCRIPTION:

Type of Reception: Voice or cw.

Frequency Range: 100-175 kc.

Operating Power Requirements: 28 v dc at 1.5 amperes.

Major units:

1 C-865A/ARA-19	5 $\frac{3}{4}$ " x 5 $\frac{7}{8}$ " x 8 $\frac{1}{4}$ "	3 $\frac{1}{4}$ lbs
1 C-423/A	4 $\frac{1}{16}$ " x 5" x 9"	3 $\frac{1}{4}$ lbs
1 AM-203/ARA-19	5 $\frac{7}{8}$ " x 5 $\frac{1}{16}$ " x 8 $\frac{7}{32}$ "	4 $\frac{1}{2}$ lbs
1 PD-5/ARA-19	2 $\frac{7}{8}$ " x 6" x 6 $\frac{5}{32}$ "	2 $\frac{1}{2}$ lbs

TUBES, CRYSTALS, TRANSISTORS:

REFERENCE DATA AND LITERATURE:

TO 12R1-2ARA19-2 (Formerly 16-30ARA-19)

RADIO SET

AN/ARC-3()

1 July 1958

Cog Serv: USAF FSN: 5820-395-8892

USA Line Item No.: 637200

USA	USN	USAF	USMC
		L/Std	

STATUS OR TYPE CLASS.:

L/Std

Manufacturer:

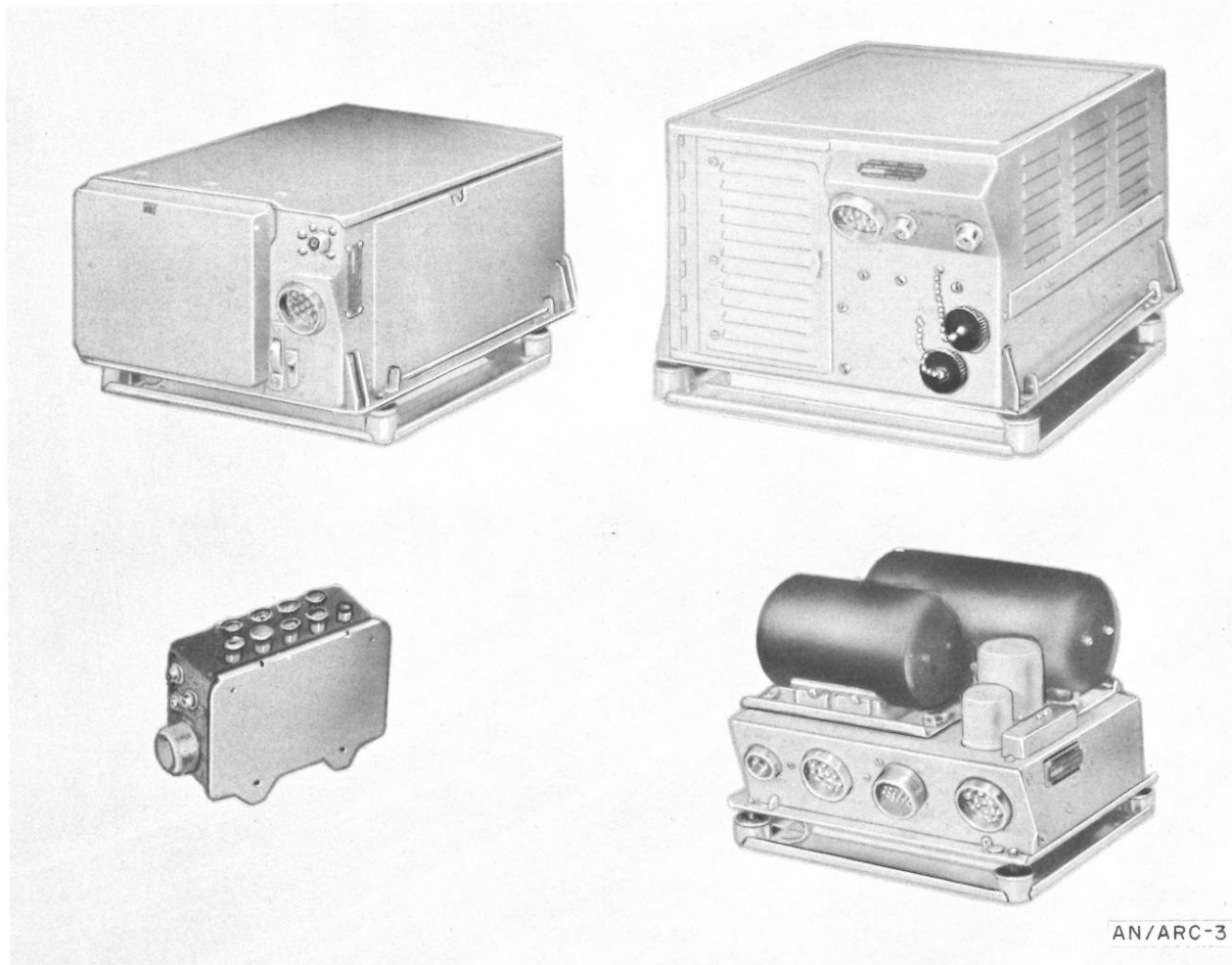

AN/ARC-3

FUNCTIONAL DESCRIPTION:

Radio Set AN/ARC-3() is an airborne command vhf communication system for air-to-ground communication. It operates on any eight preset crystal-controlled channels in the 100- to 156-mc range, by push buttons located on Control Box C-118/ARC-3.

The crystals are capable of operating under conditions of high humidity and temperature.

The transmitter has an output impedance of 52 ohms matching low impedance transmission lines, such as RG-8/U.

It is normally operated with Antenna Mast AN-104-B.

RADIO SET

AN/ARC-3()

RELATION TO SIMILAR EQUIPMENT:

TECHNICAL DESCRIPTION:

Frequency Range in mc: 100 to 156 on any 8 preset crystal-controlled channels.

Type Modulation: am.

Type of Signal: Voice, tone.

Power Output: 8 w.

Power Requirements:

Starting: 3,324 w, 28-32 v dc.

Continuous operation: 385 w, 28-32 v dc.

Major Units:

1 R-77/ARC-3

15½" x 11" x 6"

20.5 lbs

1 C-753A

5¾" x 3⅞" x 6½"

1 T-67/ARC-3

7½" x 15" x 12¼"

21 lbs

TUBES, CRYSTALS, TRANSISTORS:

REFERENCE DATA AND LITERATURE:

TO 12R2-2ARC-3-2

RADIO EQUIPMENT
AN/ARC-5

14 November 1958
 Cog Serv: USN FSN:
 USA Line Item No: 634728

	USA	USN	USAF	USMC
STATUS OR TYPE CLASS.:			Std	
Manufacturer:	Aircraft Radio Corp			

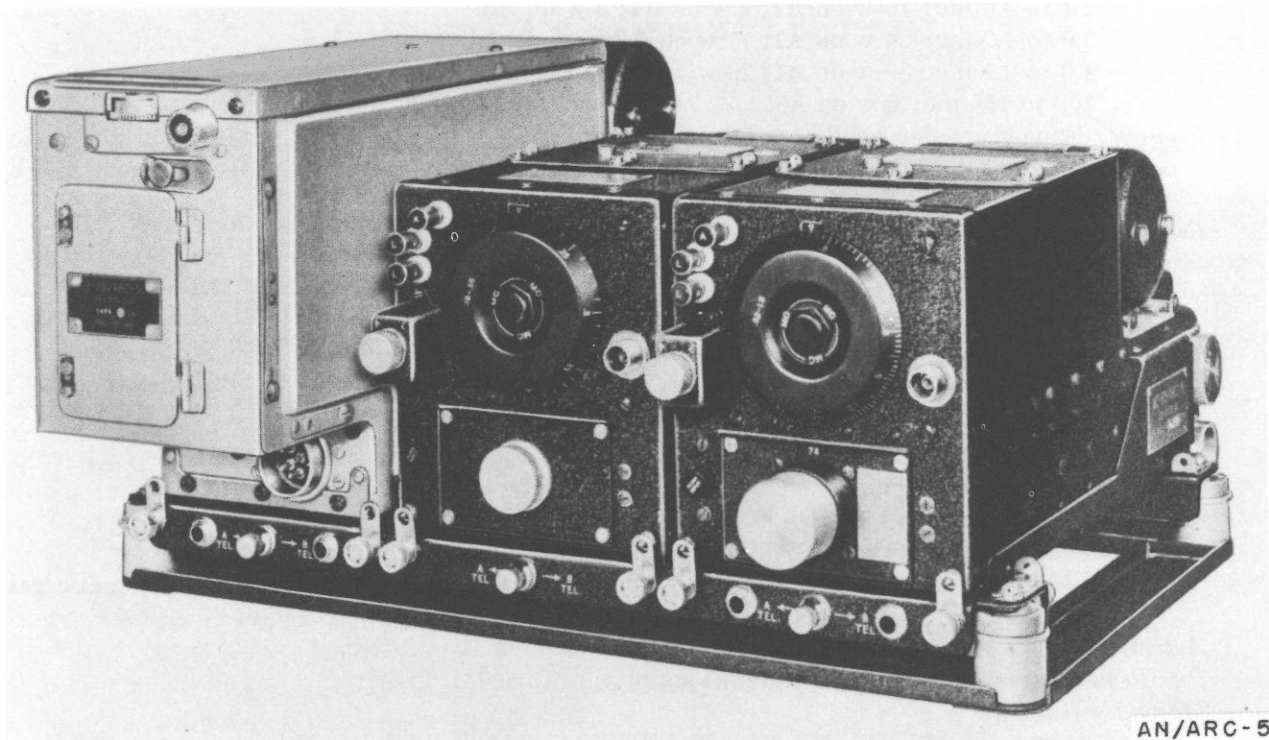
**FUNCTIONAL DESCRIPTION:**

Radio Equipment AN/ARC-5 is a multichannel amplitude modulation transmitting and receiving group designed for installation in aircraft. It is used for general air-to-ground communications, and for reception of instrument landing and navigational signals.

This multiple-unit equipment may employ a maximum of five receivers and eight transmitters, depending upon the type of installation.

RELATION TO SIMILAR EQUIPMENT:**TECHNICAL DESCRIPTION:***Transmitting:**Frequency Range in mc:*

- Radio Transmitter T-15/ARC-5: 0.5 to 0.8.
- Radio Transmitter T-16/ARC-5: 0.8 to 1.3.
- Radio Transmitter T-17/ARC-5: 1.3 to 2.1.
- Radio Transmitter T-18/ARC-5: 2.1 to 3.0.
- Radio Transmitter T-19/ARC-5: 3.0 to 4.0.
- Radio Transmitter T-20/ARC-5: 4.0 to 5.3.

RADIO EQUIPMENT

AN/ARC-5*Transmitting:**Frequency range in mc:*

- Radio Transmitter T-21/ARC-5: 5.3 to 7.0.
- Radio Transmitter T-22/ARC-5: 7.0 to 9.1.
- Radio Transmitter T-23/ARC-5: 100 to 156.

Type Emission: A1, A2, A3.

Pwr Output:

- 2.1 to 3.0 mc: 16 w on A1; 7 w on A2; 5 w on A3.
- 3.0 to 4.0 mc: 24 w on A1; 11 w on A2; 6 w on A3.
- 4.0 to 9.1 mc: 39 w on A1; 20 w on A2; 13 w on A3.
- 100 to 156 mc: 6 w on A3.

Features: Ganged master oscillator and power amplifier circuits; plate and screen grid modulation permits tuning for maximum A3 output; frequency check by magic eye; check of lock tune by crystal resonator.

*Receiving:**Frequency range in mc:*

- Radio Receiver R-23/ARC-5: 0.19 to 0.55.
- Radio Receiver R-24/ARC-5: 0.52 to 1.5.
- Radio Receiver R-25/ARC-5: 1.3 to 3.0.
- Radio Receiver R-26/ARC-5: 3.0 to 6.0.
- Radio Receiver R-27/ARC-5: 6.0 to 9.1.
- Radio Receiver R-28/ARC-5: 100 to 156.

Type: Superheterodyne.

Type Reception: A1, A2, A3.

Sensitivity: 5.0 to 7.0 mv at 30% for 10 mw output.

Features: Automatic or manual sensitivity control, automatic volume control, automatic gain control, remote controlled tuning or lock tune A3 operation.

Antenna: Long fore and aft inverted L or T.

Pwr Requirements: 24- to 28-v dc aircraft supply.

Major Units:

As required: R-23, -24, -25, -26, -27/ARC-5	$11\frac{1}{2}'' \times 4\frac{1}{16}'' \times 5\frac{5}{8}''$	6.0 lbs
As required: R-28/ARC-5	$14'' \times 4\frac{7}{8}'' \times 7\frac{5}{16}''$	17.5 lbs
As required: T-15, -16, -17, -18, -19, -21, -22/ ARC-5.	$12\frac{3}{4}'' \times 5\frac{1}{4}'' \times 7\frac{1}{16}''$	9.0 lbs
As required: T-23/ARC-5	$15\frac{3}{16}'' \times 5\frac{2}{64}'' \times 8\frac{9}{16}''$	12.3 lbs

TUBES, CRYSTALS, TRANSISTORS:**REFERENCE DATA AND LITERATURE:**

AN-08-10-195, NAVAER 08-5Q-95.

RADIO SET
AN/ARC-8

14 November 1958
Cog Serv: USAF FSN:
USA Line Item No: 637300

	USA	USN	USAF	USMC
STATUS OR TYPE CLASS:			L/Std	

Manufacturer: The Hallicraft Co.

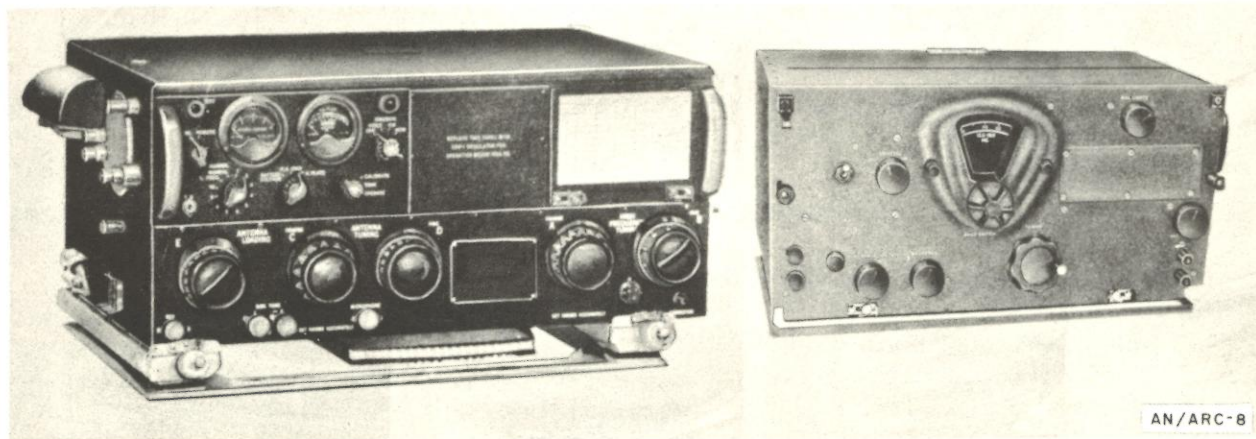

FUNCTIONAL DESCRIPTION:

Radio Set AN/ARC-8 is an airborne, low- and high-frequency communication system for air-to-air and air-to-ground communication. Application of the set is in bomber, air-sea rescue, trainer and cargo aircraft.

This equipment includes Radio Receiving Set AN/ARR-11 and Radio Transmitting Set AN/ART-13(). The AN/ARR-11 contains Radio Receiver BC-348 (), which is designed for local continuous tuning. The AN/ART-13() uses an autotune system that permits rapid selection of any one of 11 preset channels.

Antenna requirements vary with the operating frequency of the equipment. Normally, for high frequency operation a fore-and-aft inverted L or T type antenna is used; and for low frequency operation a trailing wire and Antenna Loading Unit CU-32/ART-13A are used.

RELATION TO SIMILAR EQUIPMENT:

TECHNICAL DESCRIPTION:

Frequency Range in mc:

Transmitter: 0.2 to 0.5; 2 to 18.

Receiver: 0.2 to 0.5 1.5; to 18.

Type Controls: Control Unit C-87/ART-13 provides an OFF-VOICE-CW-MCW switch, an 11-position CHANNEL switch, a pilot lamp, a voice jack, and a key used for keying the transmitter on cw or mcw. A modified version of the key contains a toggle switch that permits selection of two frequencies for each of the 10 high frequency channels of the autotune system-provided Radio Transmitting Set AN/ART-13B is using crystal-controlled operation. For installations having standardized control panels, Control Panel C-405()/A replaces and performs all functions (except key) of Control Unit C-87/ART-13.

Type of Modulation: am.

Type of Emission and Reception: Voice, tone, mcw.

RADIO SET

AN/ARC-8

Pwr Output:

Transmitter:

- 200 kc: 4.0 w.
- 300 kc: 7.5 w.
- 400 kc: 11 w.
- 500 kc: 14 w.
- 600 kc: 18 w.
- 2.0 mc: 30 w.
- 3.0 mc: 60 w.
- 4.0 mc: 80 w.
- 5.5 mc to 13.5 mc: 90 w.
- 15.5 mc: 75 w.
- 18.1 mc: 65 w.

Note: Power output is automatically reduced to one-half its nominal value at altitudes from 20,000 to 25,000 feet.

Receiver: 3 w maximum into 300- or 4,000-ohm resistive load.

Pwr Requirements:

Transmitter: 33 amp at 28 v dc.

Receiver: 1.5 amp at 28 v dc.

Major Units:

C-405()/A	2½'' x 5'' x 2⅝''	1.5 lbs
O-17/ART-13A		
BC-348-()	18'' x 10½'' x 9½''	38 lbs

TUBES, CRYSTALS, TRANSISTORS:

REFERENCE DATA AND LITERATURE:

- 12R2-2ART13-1, -2.
- 12R2-3BC-112.
- 12R2-3BC348-2.

RADIO SET
AN/ARC-21()

14 November 1958
Cog Serv: USAF FSN:
USA Line Item No:

	USA	USN	USAF	USMC
STATUS OR TYPE CLASS.:			L/Std	
Manufacturer: Radio Corp of America				

**FUNCTIONAL DESCRIPTION:**

Radio Set AN/ARC-21() is an airborne liaison type long distance communication system for air-to-air and air-to-ground communication. It is used in bombers, reconnaissance, and air support aircraft. The receiver-transmitter is in a pressurized container to provide full power output at altitudes up to 50,000 feet.

The system provides a total of 44,000 possible frequencies, spaced in increments of 500 cycles, within the tuning range of the set. Any 20 of these channels can be preset in the Radio Set Control C-451()/ARC-21 in any order. As many as five supplementary controls (Radio Set Control C-455/ARC) may also be used for selection of any one of the 20 preset frequencies.

Intercommunication Set AN/AIC-10 is required for input and output circuits. Frequency shift keying for teletype operation requires Frequency Shift Converter CV-357/A and a teletypewriter. The system can operate with Control Keyer Group AN/ARA-26 and auxiliary Radio Set AN/ARR-36.

A fixed wire or flush-mounted aircraft can be used with this equipment. An automatic antenna coupler (type 3,000 or 3,100) is required to match the impedance of the aircraft antenna to the 52-ohm coaxial transmission line used by the system.

RADIO SET

AN/ARC-21()

Radio Set AN/ARC-21 and AN/ARC-21X are identical except for power requirements. The AN/ARC-21 operates from direct current only; the AN/ARC-21X, from both alternating and direct current.

RELATION TO SIMILAR EQUIPMENT:

TECHNICAL CHARACTERISTICS:

Frequency Range in mc: 2 to 24.

Type Controls: Radio Set Control C-451()/ARC-21 provides access to preset frequency control drums, VOLUME control, CONTROL off-on switch, CW TUNE fine tuning control, CW SHARP-CW Broad-VOICE FSK type of operation selector switch, NOISE control, POWER-HI-LOW switch, and a CHANNEL selector switch. Radio Set Control C-455/ARC is a supplementary control unit enabling operations from points other than the Radio Set Control C-451()/ARC-21. Only controls for VOICE operation and channel selection are provided in this unit.

Type Modulation: am.

Type Emission and Reception: cw, voice, frequency shift keying.

Pwr Output:

Transmitter: 100 w (nominal).

Receiver: 900 mw into 200-ohm impedance.

Pwr Requirements:

Dynamotor Assembly DY-50/ARC-21:

Transmit Operation: 59 amp at 27.5-v dc.

Receive Operation: 25 amp at 27.5-v dc.

Tuning Operation: 45 amp at 27.5-v dc.

Pwr Supply PP-298/ARC-21X:

Transmit Operation: 21 amp at 27.5-v dc; 8 amp, 115-v 380- to 1,000-cy ac.

Receive Operation: 17 amp at 27.5-v dc, 2.5 amp, 115-v 380- to 1,000-cy ac.

Major Units:

RT-128/ARC-21; 19'' x 18 $\frac{1}{8}$ '' x 26 $\frac{1}{8}$ ''

C-451()/ARC-21; 7 $\frac{1}{8}$ '' x 5 $\frac{3}{4}$ '' x 5 $\frac{1}{8}$ ''

C-455/ARC; 2 $\frac{5}{8}$ '' x 5 $\frac{3}{4}$ '' x 4 $\frac{1}{2}$ ''

132 lbs

5.34 lbs

1.5 lbs

TUBES, CRYSTALS, TRANSISTORS:

None.

REFERENCE DATA AND LITERATURE:

MIL-R-6471 and MIL-R-6472 (USAF).

RADIO SET
AN/ARC-27

14 November 1958
Cog Serv: USN FSN: 5820-301-4426
USA Line Item No: 636900

	USA	USN	USAF	USMC
STATUS OR TYPE CLASS:	S+d=B		L/Std	

Manufacturer: Collins Radio Co

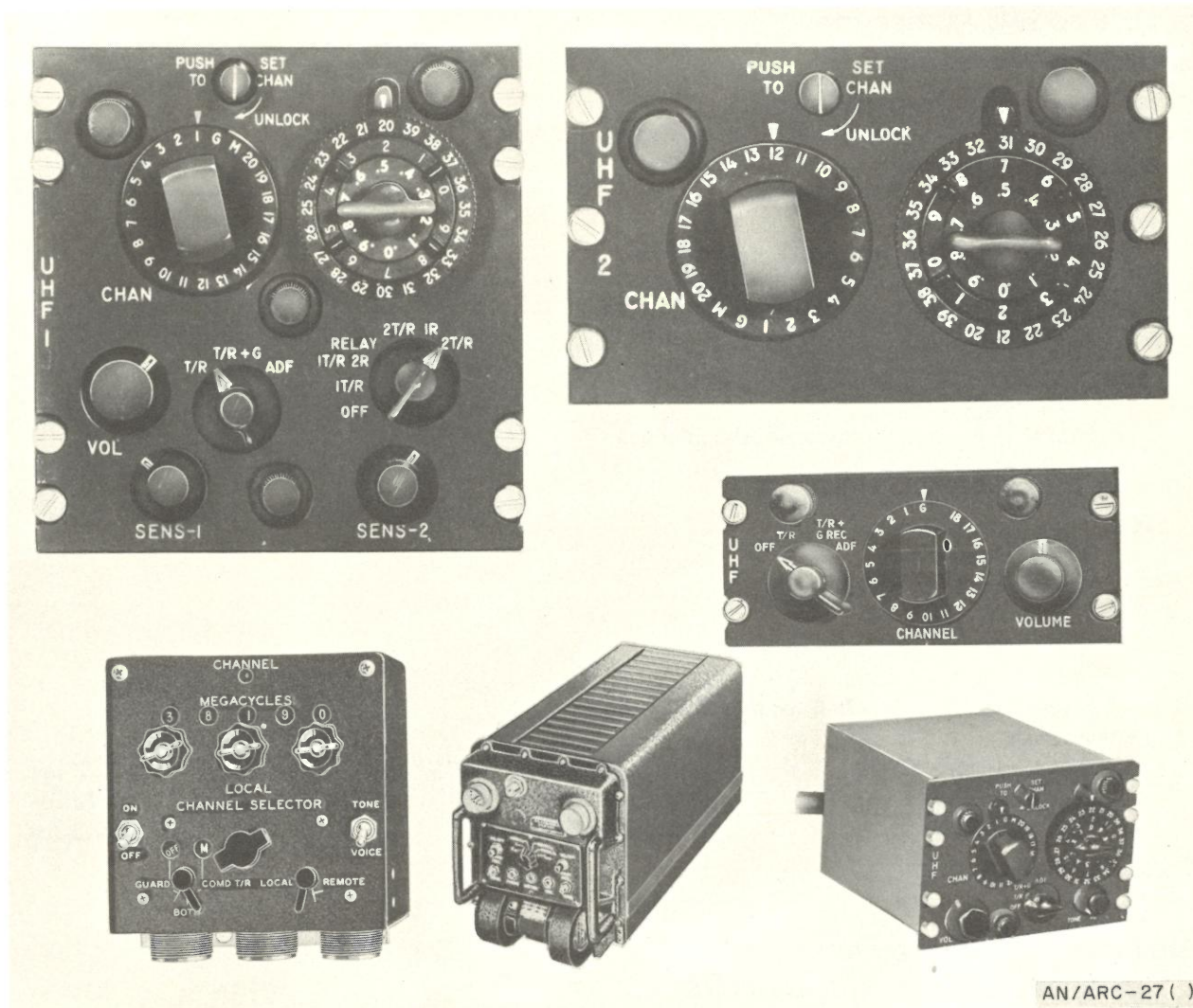

AN/ARC-27 ()

FUNCTIONAL DESCRIPTION:

Radio Set AN/ARC-27 is an airborne, two-way, ultra high frequency command radio equipment for voice or tone signals. It is used for air-to-air, air-to-ship, and ground-to-air communication in all types of fighter, bomber, and cargo aircraft.

The receiving equipment consists of a triple-conversion, superheterodyne unit using three crystal oscillators, and a double-conversion superheterodyne auxiliary guard channel receiver. Both receivers

RADIO SET

AN/ARC-27

work into a common audio output circuit. The triple-conversion receiver operates with Direction Finder Group AN/ARA-25 for navigational purposes, as well as for voice communication.

Provision is made for the remote selection of any one of 19 preset frequencies or for operation on a guard channel frequency, and for constant monitoring of the guard frequency.

Any aircraft antenna using a 52-ohm coaxial transmission line, such as Radio Frequency Cable RG-8/U or RG-58/U, may be used.

This equipment is similar to Radio Set AN/ARC-19, except for difference in channel spacing.

RELATION TO SIMILAR EQUIPMENT:**TECHNICAL CHARACTERISTICS:**

Frequency Range in mc: 225 to 400.

Frequency Channels: 1750; spaced 100 kc apart.

Preset Frequencies: 18.

Approximate Range: Line of sight.

Type Modulation: am.

Type Emission and Reception: Voice or tone.

Transmitter:

Modulation: 90% to 95%.

Pwr Output: 9 w.

Receiver:

Type: Superheterodyne.

Input: 5 uv 30% modulated at 1,000 cps.

Minimum Output: 50 mw.

Maximum Output: 2 w.

Antenna:

Type: Broad-band.

Impedance: 50 ohms.

Pwr Requirements:

Transmitting: 19.1 amp at 27.5-v dc.

Receiving: 16.5 amp at 27.5-v dc.

Channel Switching: 25.5 amp at 27.5-v dc.

Major Units:

RT-178/ARC-27

12 $\frac{3}{8}$ " x 11 $\frac{1}{4}$ " x 27 $\frac{7}{8}$ "

72.2 lbs

C-626/ARC-27

9 $\frac{9}{16}$ " x 6 $\frac{3}{8}$ " x 5 $\frac{1}{2}$ "

9.75 lbs

C-628/ARC-27

2 $\frac{5}{8}$ " x 3 $\frac{5}{8}$ " x 5 $\frac{3}{4}$ "

1.5 lbs

TUBES, CRYSTALS, TRANSISTORS:

None.

REFERENCE DATA AND LITERATURE:

AN 16-30ARC27-3, MIL-R-5068 USN.

RADIO SET
AN/ARC-33

14 November 1958
 Cog Serv: USAF
 USA Line Item No:

	USA	USN	USAF	USMC
STATUS OR TYPE CLASS:			A/Std	
Manufacturer:	Bendix Radio Corp			

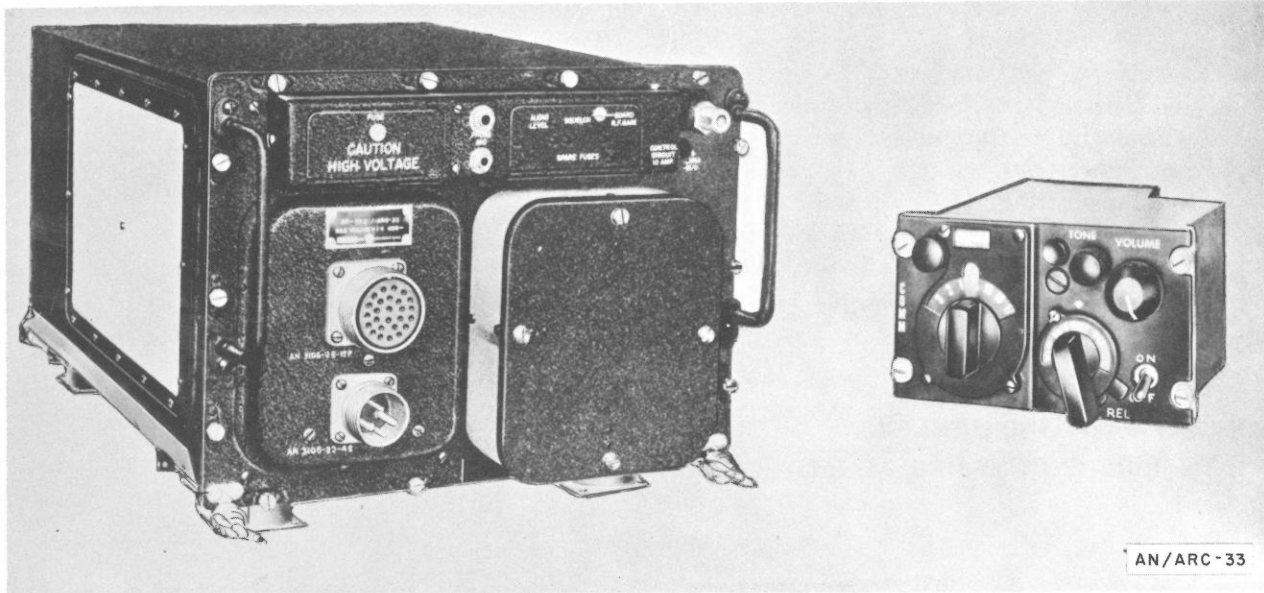

FUNCTIONAL DESCRIPTION:

Radio Set AN/ARC-33 is an airborne command, receiving-transmitting equipment designed for air-to-air and air-to-ground voice communication in the ultra high frequency range. Primary application of the equipment is for voice communication in fighter aircraft at altitudes up to 50,000 feet.

This equipment is normally operated with remote Control Panel C-784/ARC-33, which automatically increases the gain of the modulator speech amplifier with an increase in altitude. The control also permits presetting of any 20 channels of the total range of frequencies. One guard channel in the 238- to 248-megacycles range can be monitored simultaneously with normal operation of the equipment.

Flush-tail cap-type arrays, Antenna AT-256A/ARC, or any other ultra high frequency antenna having a 52-ohm coaxial transmission line, such as Radio Frequency Cable RG-8/U, can be used.

The receiver-transmitter component has been modified for use with Direction Finder Group AN/ARA-25. Remote Channel Indicator ID-572/ARC and associated Control Box C-2006/ARC-33 are designed for use with the AN/ARC-33 installed in fighter aircraft to enable the pilot to select a channel without having to look away from the flight instruments. Additional aircraft wiring is required for this function.

This equipment is interchangeable with, as well as operationally and physically similar to, Radio Set AN/ARC-27.

RELATION TO SIMILAR EQUIPMENT:

RADIO SET

AN/ARC-33

TECHNICAL CHARACTERISTICS:

Frequency Range in mc: 225.0 to 399.9.

Number of Frequencies: 1,750; spaced in increments of 100 kc.

Approximate Operational Range: 75 miles at 3,000 feet-altitude.

Type Controls: Control Panel C-784/ARC-33 provides a guard indicator, a tone pushbutton, a volume control, an on-off switch, a Main-Both-G function switch, a memory cylinder assembly panel, a channel selector switch, and a preset channel indicator. This control is being replaced in USAF aircraft by Control C-2006/ARC-33, functionally and physically similar to Control C-1057A/ARC-34.

Type Modulation: am.

Type Emission and Reception: Voice, tone.

Transmitter Pwr Output: 8w (min).

Pwr Requirements:

Transmitting: 15.5 amp at 27.5-v dc.

Receiving: 12.5 amp at 27.5-v dc.

Peak: 20.25 amp at 27.5-v dc.

Major Units: RT-173A/ARC-33 15 $\frac{3}{16}$ " x 10 $\frac{3}{8}$ " x 21 $\frac{1}{2}$ "; 83.56 lbs.

TUBES, CRYSTALS, TRANSISTORS:

None.

REFERENCE DATA AND LITERATURE:

TO 12R2-2ARC33-1, -2, -4, MIL-R-25061.

RADIO SET
AN/ARC-34

14 November 1958
Cog Serv: USAF FSN: 5820-539-7602
USA Line Item No.: 636800

STATUS OR TYPE CLASS.:

USA

USN

USAF

USMC

Manufacturer: Magnavox Co

L/Std

Radio Corp
of America

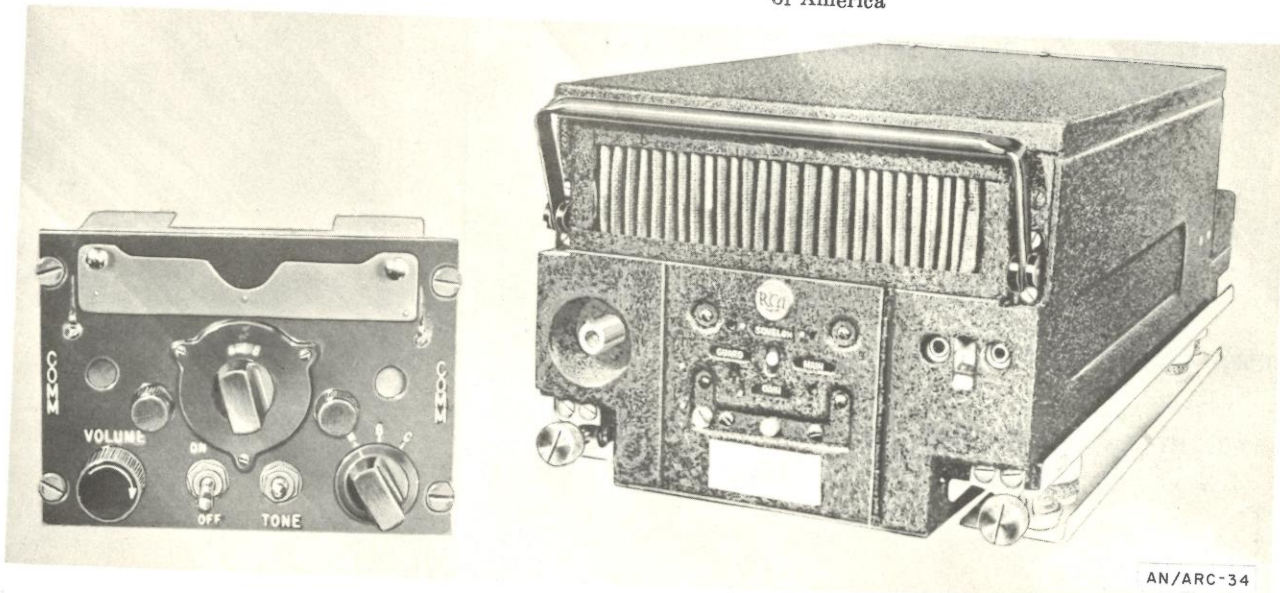

FUNCTIONAL DESCRIPTION:

Radio Set AN/ARC-34 is a miniaturized version of Radio Set AN/ARC-33. It is an airborne command, receiving-transmitting equipment designed for air-to-air and air-to-ground voice communication in the ultra high frequency range. Its primary application is for voice communication in fighter, bomber, reconnaissance and air support aircraft. It will operate at altitudes up to 50,000 feet.

Radio Set Control C-1057/ARC-34 permits presetting, in any order desired, of any 20 channels. One guard channel in the 238- to 248-megacycle range can also be monitored simultaneously with normal operation of the equipment.

The set has 150-ohm impedance, nominal, input and output circuits for use with either Intercommunication Set AN/AIC-10 or Microphone T-17 and Headset HS-33. Other intercommunications systems can be used if the input and output impedances and interwiring can be matched.

Flush-tail cap-type arrays, Antenna AT-256A/ARC, or any other ultra high frequency antenna having a 52-ohm coaxial transmission line, such as Radio Frequency Cable RG-8/U, can be used.

This equipment can operate with Direction Finder Group AN/ARA-25 and Control Keyer Group AN/ARA-26. Remote Channel Indicator ID-572/ARC and associated Radio Set Control C-1057A/ARC-34 are designed for use with the AN/ARC-34 installed in fighter aircraft to enable the pilot to select a channel without having to look away from the flight instruments. Additional aircraft wiring is required for this function.

RELATION TO SIMILAR EQUIPMENT:

RADIO SET

AN/ARC-34

TECHNICAL CHARACTERISTICS:

Frequency Range in mc: 225.0 to 399.9.

Number of Frequencies: 1,750; spaced in increments of 100 kc.

Approximate Operational Range: 75 miles at 3,000 feet altitude.

Type Controls: Radio Set Control C-1057/ARC-34 provides an OFF-MAIN-BOTH-ADF switch and a MANUAL-PRESENT-GUARD switch.

Type Modulation: am.

Type Emission and Reception: Voice, tone.

Transmitter Pwr Output: 8w (min).

Pwr Requirement:

Maximum: 21 amp at 22 to 29-v dc.

Transmitting: 18 amp 27.5-v dc (nominal).

Receiving: 13.5 amp at 27.5-v dc (nominal).

Tuning: 17 amp 27.5-v dc (nominal).

Major Units:

C-1057/ARC-34

$4\frac{7}{8}'' \times 5\frac{3}{4}'' \times 7\frac{1}{10}''$

2.7 lbs

RT-263/ARC-34

$7\frac{9}{16}'' \times 10\frac{1}{8}'' \times 20\frac{1}{16}''$

46.9 lbs

TUBES, CRYSTALS, TRANSISTORS:

None.

REFERENCE DATA AND LITERATURE:

TO 12R2-2ARC34-1, -2, -3, -4, MIL-R-7546C (USAF).

RADIO SET
AN/ARC-36()

14 November 1958
Cog Serv: USAF:
USA Line Item No:

USA USN USAF USMC

STATUS OR TYPE CLASS.:

Std

Manufacturer: Sylvania Electric Products, Inc

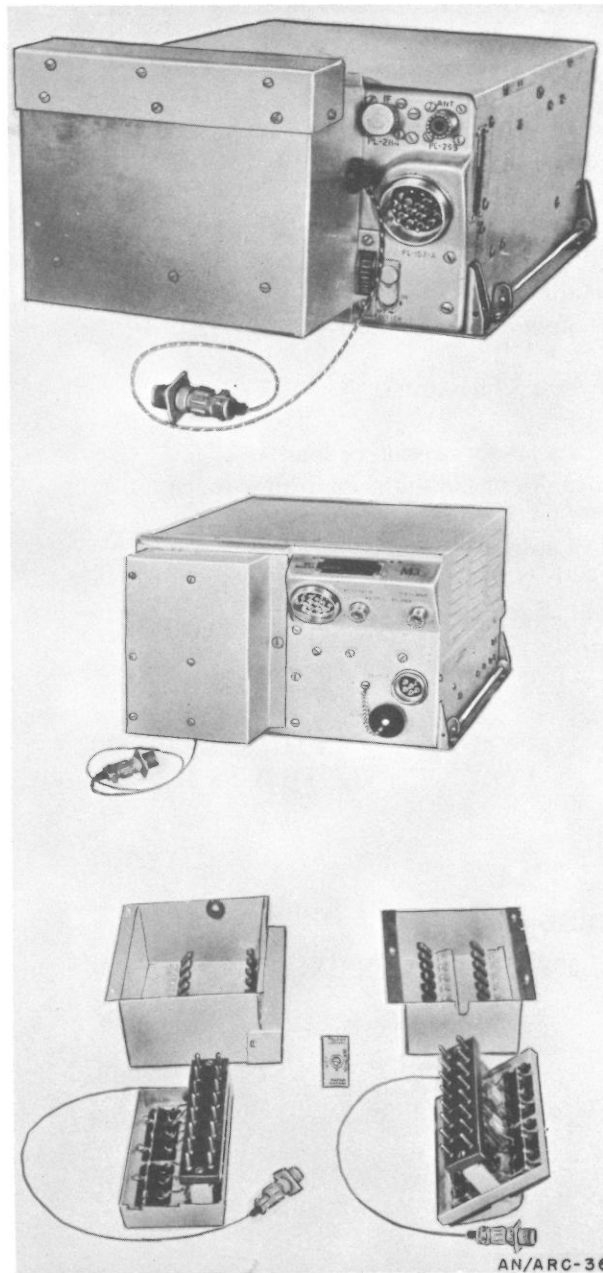

RADIO SET

AN/ARC-36()**FUNCTIONAL DESCRIPTION:**

Radio Set AN/ARC-36() is an airborne communication system for air-to-ground and air-to-air communications in the very high frequency range. Sixteen preset crystal-controlled channels are remotely controlled by Control Box C-118()/ARC-3 or Control Panel C-404()/A.

The transmitter has an output impedance of 52 ohms matching low impedance lines, such as Radio Frequency Cable RG-8/U. It normally operates with Antenna Mast AN-104-B.

This equipment is similar to Radio Sets AN/ARC-3 and AN/ARC-49 except for the number of frequency channels. The AN/ARC-3 has eight, the AN/ARC-36() has 16, and the AN/ARC-49 has 48 channels.

RELATION TO SIMILAR EQUIPMENT:**TECHNICAL CHARACTERISTICS:**

Frequency Range in mc: 100 to 156.

Number of Crystals Required: 32.

Type Controls: Control Box C-118()/ARC-3 provides eight channel selector pushbuttons, an OFF pushbutton, a MIC receptacle, a TEL jack and a Tone button. Control Panel C-404()/A provides a channel selector switch, a tone switch, a volume control, and an ON-OFF switch.

Approximate Operational Range: Line of sight.

Type Modulation: am.

Type Emission and Reception: Voice, tone.

Pwr Output:

Transmitter: 8 w into a 50-ohm resistive load.

Receiver: 600 mw into 50- or 600-ohm load impedance.

Pwr Requirements:

Starting: 3,324 w, 118 amp at 28-v dc.

Transmitting: 12.4 amp 28-v dc.

Receiving: 5.9 amp at 28-v dc.

Major Units:

C-118()/ARC-3	6'' x 2 $\frac{5}{8}$ '' x 6 $\frac{7}{8}$ ''	2.1 lbs
C-404()/A	5'' x 2 $\frac{5}{8}$ '' x 2 $\frac{5}{8}$ ''	0.9 lbs
R-77()/ARC-3	6'' x 11'' x 14 $\frac{5}{16}$ ''	20.5 lbs
T-67()/ARC-3	7 $\frac{1}{2}$ '' x 12 $\frac{1}{8}$ '' x 15 $\frac{1}{4}$ ''	21 lbs

TUBES, CRYSTALS, TRANSISTORS:

None.

REFERENCE DATA AND LITERATURE:

TO 12R2-2ARC-2, -34, -503 MIL-M-5818 (USAF).

March 1964
 Cog Serv: USA FSN: 5821-503-2586
 USA Line Item No: 638000

RADIO SET
AN/ARC-44

	USA	USN	USAF	USMC
STATUS OR TYPE CLASS.:	Std B		Std	

Manufacturer: Admiral Corp

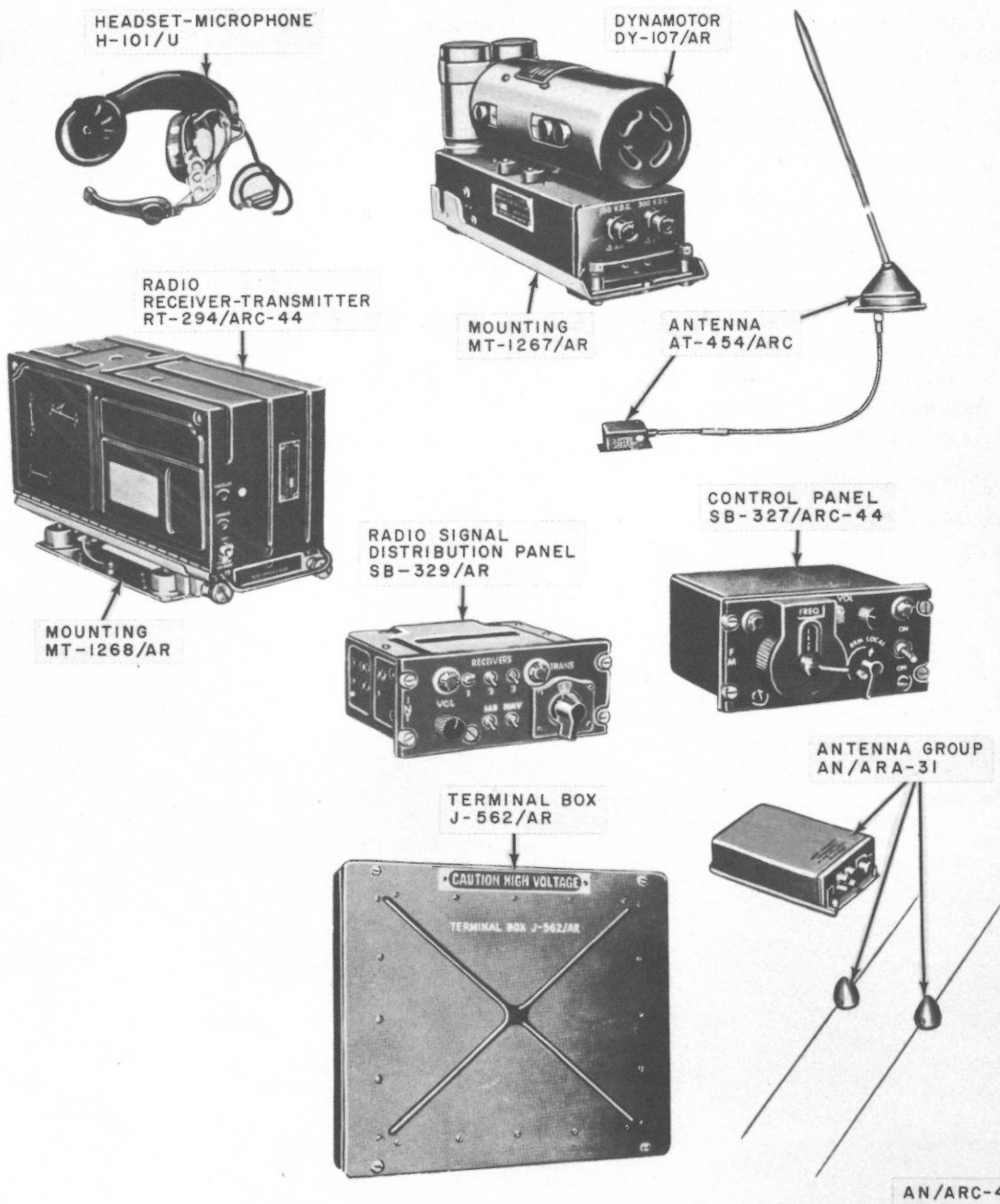

RADIO SET

AN/ARC-44

FUNCTIONAL DESCRIPTION:

Radio Set AN/ARC-44 is a compact fm radio equipment that operates in the vhf range and can be used for communication, retransmission, and homing in Army aircraft.

It consists essentially of a receiver-transmitter that is operated from remote-control panel equipment and a radio distribution panel that enables the selection and operation of as many as six receivers (singly or in combination), three transmitters, or the aircraft interphone channel.

This equipment is capable of functioning as an airborne radio relay station between two stations that cannot communicate with each other because of distance. In such applications, an additional transmitter is required and different receive and transmit channels are used.

RELATION TO SIMILAR EQUIPMENT:

TECHNICAL DESCRIPTION:

Frequency Range in mc: 24 to 51.9 (280 channels, 100 kc apart).

Type Modulation: fm.

Type of Signal: Voice; keyed fm; keyed cw for homing.

Pwr Output: 50 mw (rcvr); 8 w (xmtr).

Pwr Requirements: Dynamotor DY-107/AR: 475 amp, 27 v dc.

Major Units:

As required:	SB-327/ARC-44	3'' x 6'' x 5 $\frac{1}{4}$ ''	2.19 lbs
As required:	RT-294/ARC-44	7 $\frac{1}{4}$ '' x 13 $\frac{7}{8}$ '' x 5 $\frac{1}{8}$ ''	14 lbs
As required:	SB-329/AR	2 $\frac{5}{8}$ '' x 5 $\frac{5}{16}$ '' x 5 $\frac{3}{4}$ ''	1.63 lbs

TUBES, CRYSTALS, TRANSISTORS:

REFERENCE DATA AND LITERATURE:

MIL-R-12483A.

RADIO SET
AN/ARC-49

17 November 1958
Cog Serv: USAF FSN:
USA Line Item No. 638050

	USA	USN	USAF	USMC
STATUS OR TYPE CLASS:			A/Std	
Manufacturer: Sylvania Electric Products Inc				

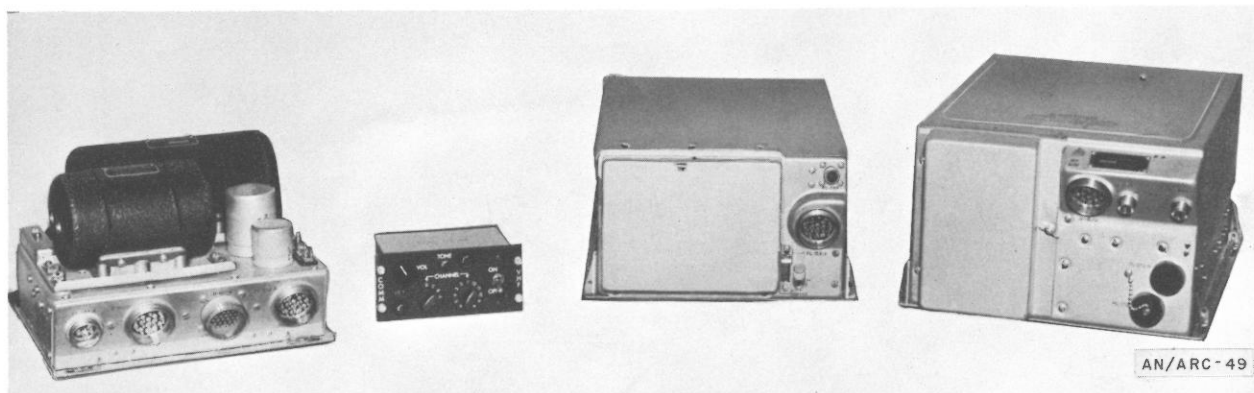
**FUNCTIONAL DESCRIPTION:**

Radio Set AN/ARC-49 is an airborne communication system for air-to-air and air-to-ground communication in the very high frequency range. Forty-eight preset crystal-controlled channels are remotely controlled by Control Radio Set C-1400/ARC-49.

This equipment is similar to Radio Sets AN/ARC-3 and AN/ARC-36() except for the number of frequency channels. The AN/ARC-3 has eight, the AN/ARC-36() has 16, and the AN/ARC-49 has 48 channels.

RELATION TO SIMILAR EQUIPMENT:**TECHNICAL DESCRIPTION:**

Frequency Range in mc: 100 to 150.

Type Controls: Radio Set Control C-1400/ARC-49 provides a VOLUME control, a TONE button, a crystal selector switch, a channel selector, and an ON-OFF switch.

Type Modulation: am.

Type Emission and Reception: Voice, tone.

Pwr Output:

Transmitter: 8 w into a 50-ohm resistive load.

Receiver: 600 mw into 50- or 600-ohm load impedance.

Pwr Requirements:

Continuous Operation: 385 w, 13.75 amp at 28 v dc.

Starting: 3,324 w, 118 amp at 28 v dc.

Transmitting: 12 amp at 28 v dc.

Receiving: 5.5 amp at 28 v dc.

Major Units:

1 R-608/ARC-49	6'' x 11'' x 15 ⁹ / ₁₆ ''	21.5 lbs
1 C-1400/ARC-49	5 ³ / ₄ '' x 2 ⁵ / ₈ '' x 4 ⁵ / ₈ ''	1.5 lbs
1 T-452/ARC-49	7 ¹ / ₂ '' x 12 ¹ / ₈ '' x 15 ¹ / ₄ ''	22.4 lbs

MIL-HDBK-161A/TM 11-487A-1/NAVEXOS P-2058/TO 31-3-73

RADIO SET

AN/ARC-49

TUBES, CRYSTALS, TRANSISTORS:

REFERENCE DATA AND LITERATURE:

TO 12R2 2ARC2 2, 31.
MIL-R-8389(USAF).

RADIO SET
AN/ARC-55

1 July 1958

Cog Serv: USN FSN: 5821-510-4545

USA Line Item No: 636700

	USA	USN	USAF	USMC
STATUS OR TYPE CLASS.:	Std-B	Std		

Manufacturer: Admiral Corp

**FUNCTIONAL DESCRIPTION:**

Radio Set AN/ARC-55 is an airborne, two-way, point-to-point equipment used for air-to-air, air-to-ship, and ground-to-air communication in all types of fighters, bombers, helicopters, and cargo aircraft.

This equipment operates on any one of 18 preset, crystal-controlled frequencies of 1,750 available channels. It consists of a triple-conversion superheterodyne receiver with three crystal oscillators and a double-conversion superheterodyne auxiliary guard channel, both working into a common audio output circuit.

RELATION TO SIMILAR EQUIPMENT:**TECHNICAL CHARACTERISTICS:**

Frequency Range in mc: 225 to 399.9.

Type Modulation: am.

Type of Signal: Voice or tone.

Pwr Output: 9 w.

Pwr Requirements: 25 amp at 24-28-v dc.

RADIO SET

AN/ARC-55

Major Units: RT-349/ARC-55

11" x 9 $\frac{1}{8}$ " x 25 $\frac{1}{16}$ "

57.5 lbs

TUBES, CRYSTALS, TRANSISTORS:

REFERENCE DATA AND LITERATURE:

AN 16-30ARC27-2, -502.

MIL-R-5068C.

RADIO SET
AN/ARC-57

July 1962
 Cog Serv: USAF FSN:
 USA Line Item No:

	USA	USN	USAF	USMC
STATUS OR TYPE CLASS.:			T/Std	
Manufacturer: Magnavox				

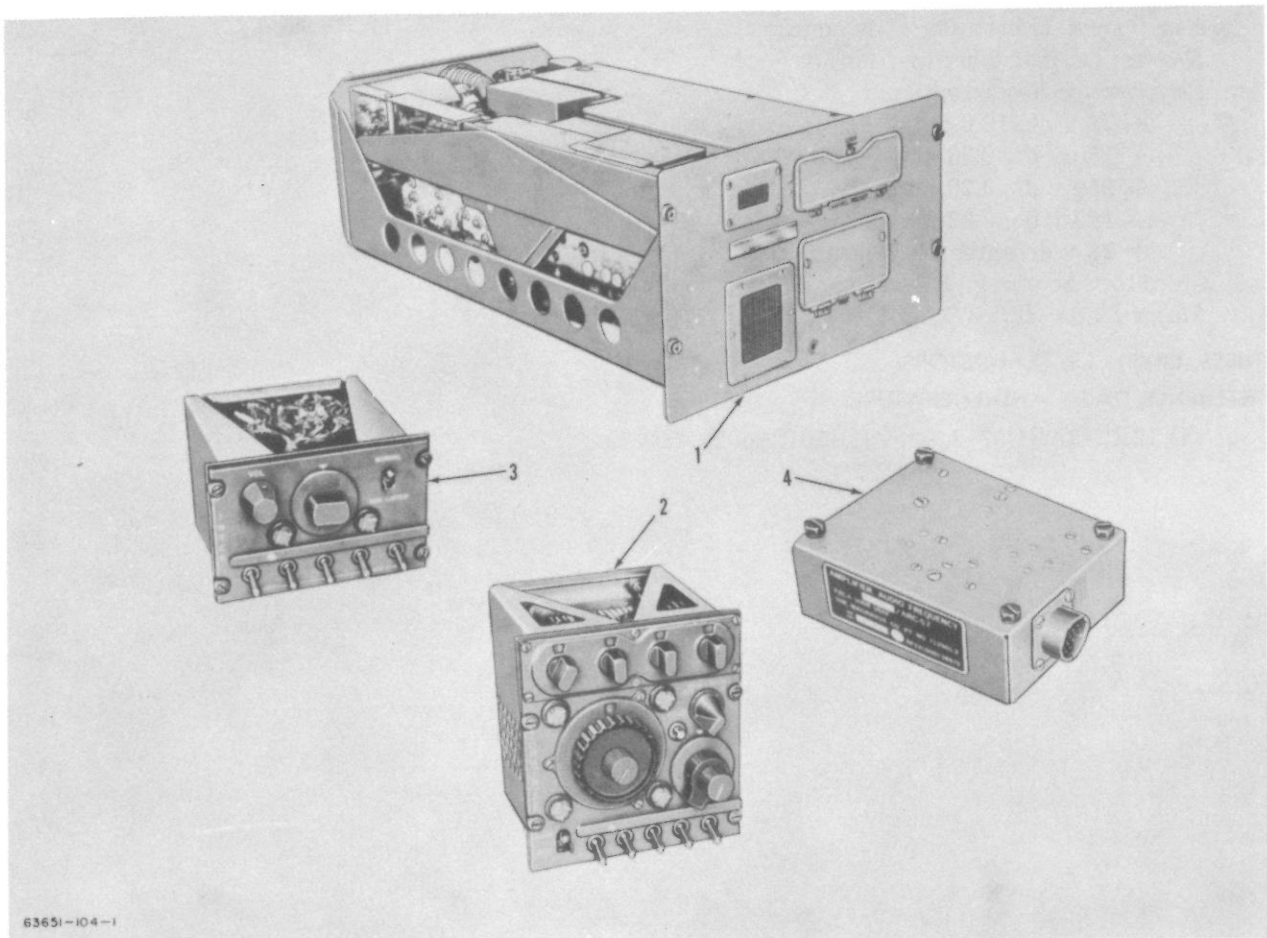

FUNCTIONAL DESCRIPTION:

Radio Set AN/ARC-57 is a lightweight Airborne Communications system that combines a UHF Command Set and an Intercommunications Set. The UHF Command Set provides two-way communication beyond the aircraft on any of 1750 available frequencies, and provides simultaneous monitoring of a fixed guard frequency and a main selected operating frequency. The command also provides an emergency tuning function that permits both transmission and reception (guard frequency) when normal tuning functions fail.

The Intercommunications Set provides push-to-talk and hot-mike interphone communications between the crew members, push-to-talk transmission by any crew member on Command Set, Monitoring

RADIO SET

AN/ARC-57

of as many as six audio facilities at one time by any crew member, and an audible warning tone signal under specific unsafe landing conditions.

RELATION TO SIMILAR EQUIPMENT:

TECHNICAL DESCRIPTION:

Frequency Range in mc: 225 to 399.9.

Type Modulation: am.

Type Signal: Voice or tone.

Pwr Output Transmitter: 8 w (min).

Receiver Output: 200 mw (min).

Performance Requirements:

+ 28 v dc, 18.6 amp.

+ 150 v dc, 0.33 amp.

+ 250 v dc, 0.29 amp.

- 150 v dc, 0.30 amp.

+ 28 v dc unreg., 0.18 amp.

115 v ac unreg., 3.3 amp.

Major Units: RT-377/ARC-57 11 $\frac{3}{8}$ " x 7 $\frac{1}{2}$ " x 22". 41.5 lbs

TUBES, CRYSTALS, TRANSISTORS:

REFERENCE DATA AND LITERATURE:

TO 12R2-2ARC57-2, -3, -4, -501, -502, -503.

RADIO SET
AN/ARC-58

July 1962
 Cog Serv: USAF FSN:
 USA Line Item No:

	USA	USN	USAF	USMC
STATUS OR TYPE CLASS.:			Std	
Manufacturer: Collins Radio				

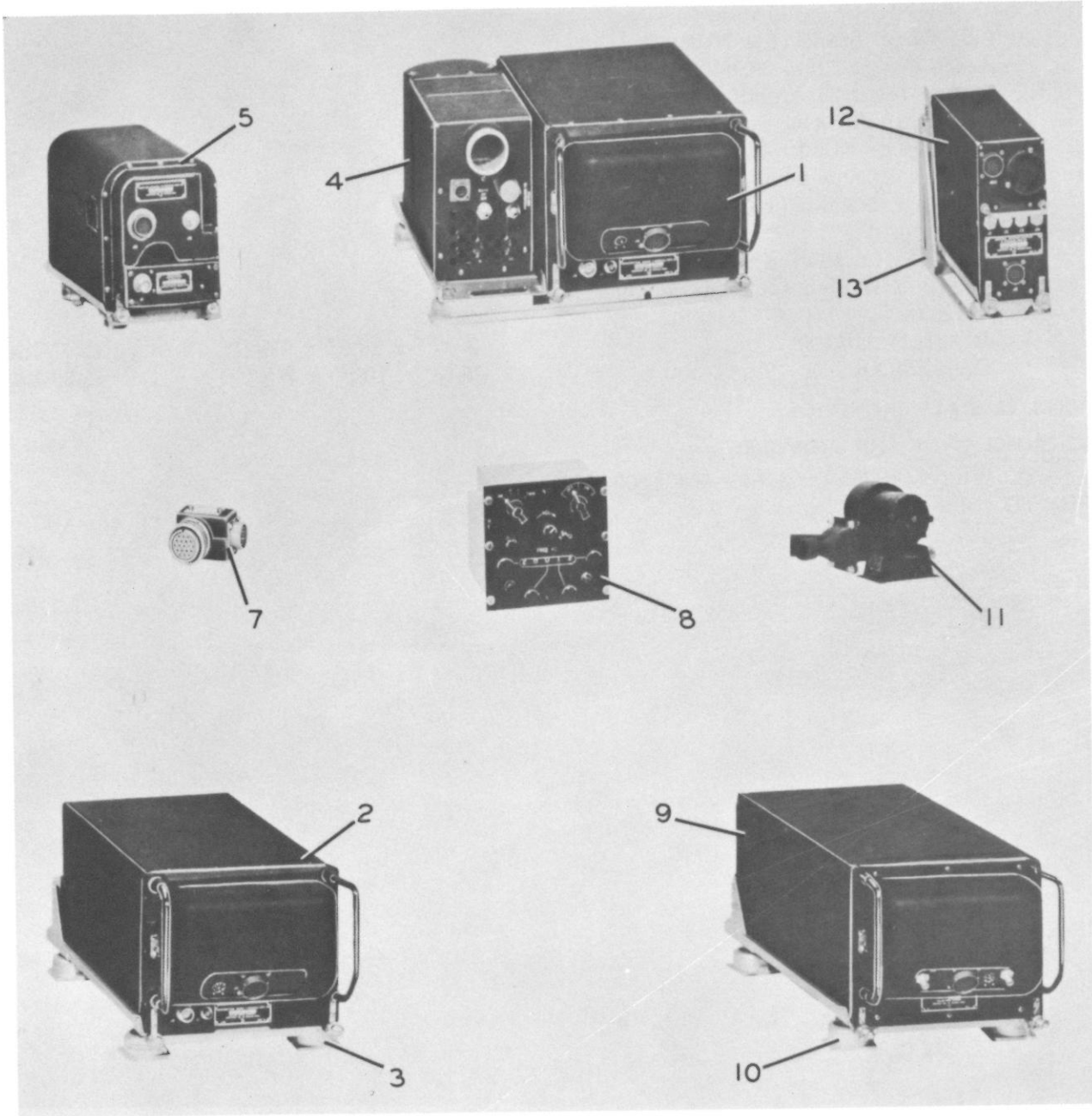

RADIO SET

AN/ARC-58

FUNCTIONAL DESCRIPTION:

Radio Set AN/ARC-58 provides long distance, two-way communications service in the hf band. Design features include improved communicating ability through the use of increased power and single sideband techniques, 28,000 directly selectable frequency channels, automatic tuning and compatibility with existing am facilities. Modular construction is maintained throughout.

RELATION TO SIMILAR EQUIPMENT:

TECHNICAL DESCRIPTION:

Altitude Range: Sea level to 75,000 ft.

Frequency Range: 2.0 to 29.999 mc.

Channeling Time: 20 seconds nominal.

Frequency Stability: One part per million per month.

Temp. Range: -54.0 to +71.0 degrees C.

Pwr Output: 1,000 w nominal.

Audio Output: 200 mw (max).

Sensitivity:

ssb: 1 μ v for 10 db S+N/N Ratio.

am: 2 μ v 10 db S+N/N Ratio.

Major Units:

R-761(A)/ARC-58

OA-2422/ARC-58

25 $\frac{1}{2}$ " x 10 $\frac{1}{4}$ " x 7 $\frac{25}{32}$ "

25 $\frac{3}{8}$ " x 10 $\frac{1}{4}$ " x 7 $\frac{5}{32}$ "

49.75 lbs

46.25 lbs

TUBES, CRYSTALS, TRANSISTORS:

REFERENCE DATA AND LITERATURE:

TO 12R2-2ARC58-2, -3, -4, -501, -502, -503, -504.

TO 12R2-2ARC-4.

1 March 1964
Cog Serv: USA FSN: 5821-543-0643
USA Line Item No: 638200

RADIO SET
AN/ARC-60

USA USN USAF USMC

STATUS OR TYPE CLASSIFICATION

Std-B

Manufacturer: Aircraft Radio Corp

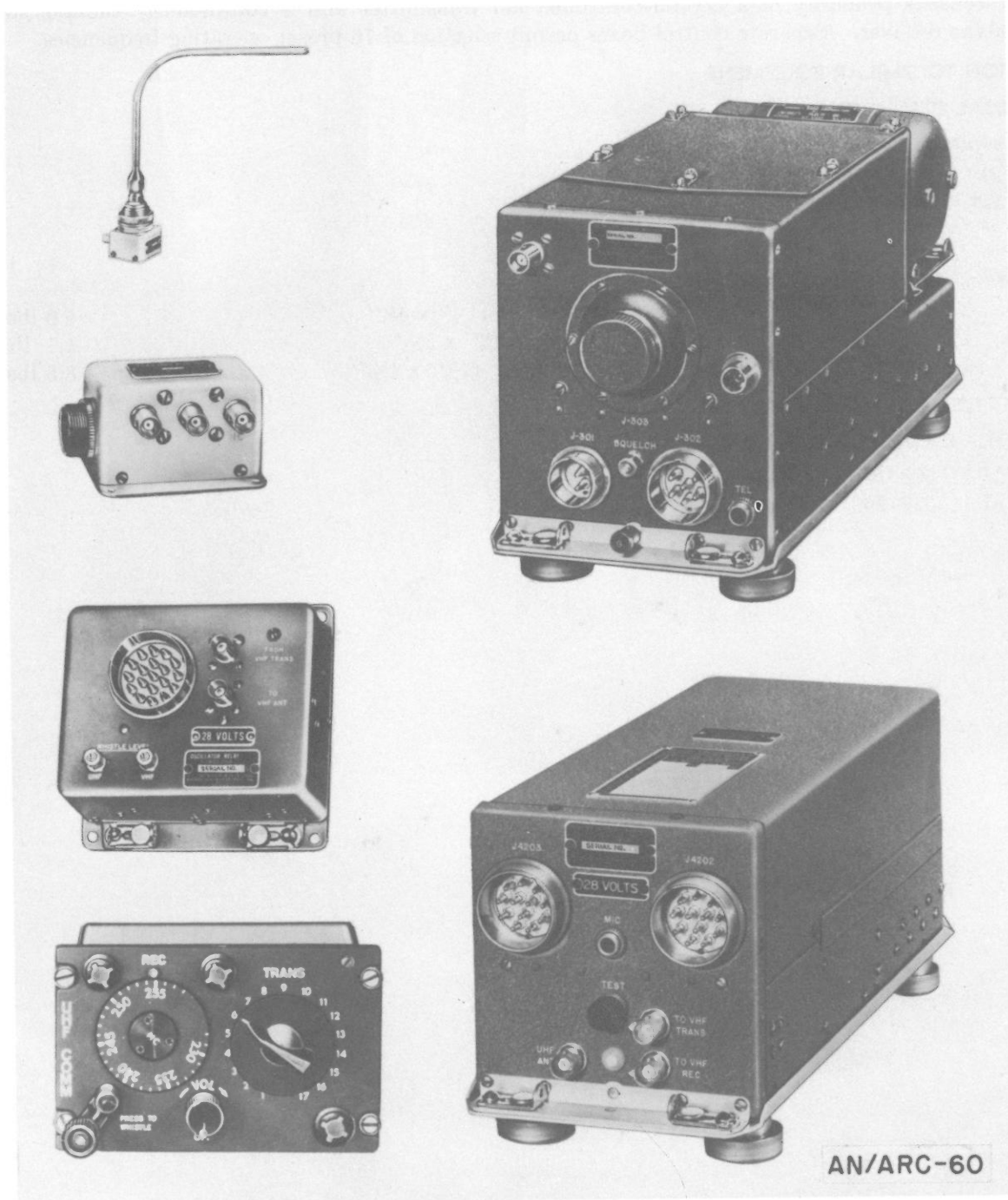

RADIO SET

AN/ARC-60**FUNCTIONAL DESCRIPTION:**

Radio Set AN/ARC-60 is an assemblage of radio and accessory equipment for installation in observation and reconnaissance fixed and rotary wing aircraft of low weight-carrying capability. It provides these aircraft with air-to-ground and air-to-air voice communication in the uhf range.

It consists primarily of a crystal-controlled am transmitter and a continuously tunable super-heterodyne receiver. Separate control boxes permit selection of 16 preset operating frequencies.

RELATION TO SIMILAR EQUIPMENT:**TECHNICAL DESCRIPTION:**

Frequency Range in mc: 228 to 258.

Type Modulation: am.

Type of Signal: Voice.

Pwr Output: 0.5 w. .

Pwr Requirements: 6.8 amp at 28-v dc.

Major Units:

2 CV-431/AR

4 $\frac{3}{4}$ " x 11 $\frac{1}{2}$ " x 4 $\frac{3}{4}$ "

5.9 lbs

1 O-423/AR

5" x 2 $\frac{3}{4}$ " x 5 $\frac{1}{16}$ "

1.1 lbs

1 R-508/ARC

6 $\frac{1}{16}$ " x 11 $\frac{3}{8}$ " x 4 $\frac{5}{16}$ "

8.8 lbs

TUBES, CRYSTALS, TRANSISTORS:**REFERENCE DATA AND LITERATURE:**

TM 11-522-10.

TM 11-522-25.

July 1964
Cog Serv: USAF FSN:
USA Line Item No:

RADIO SET
AN/ARC-63

USA USN USAF USMC

STATUS OR TYPE CLASS.:

Std

Manufacturer: Bendix Radio Division

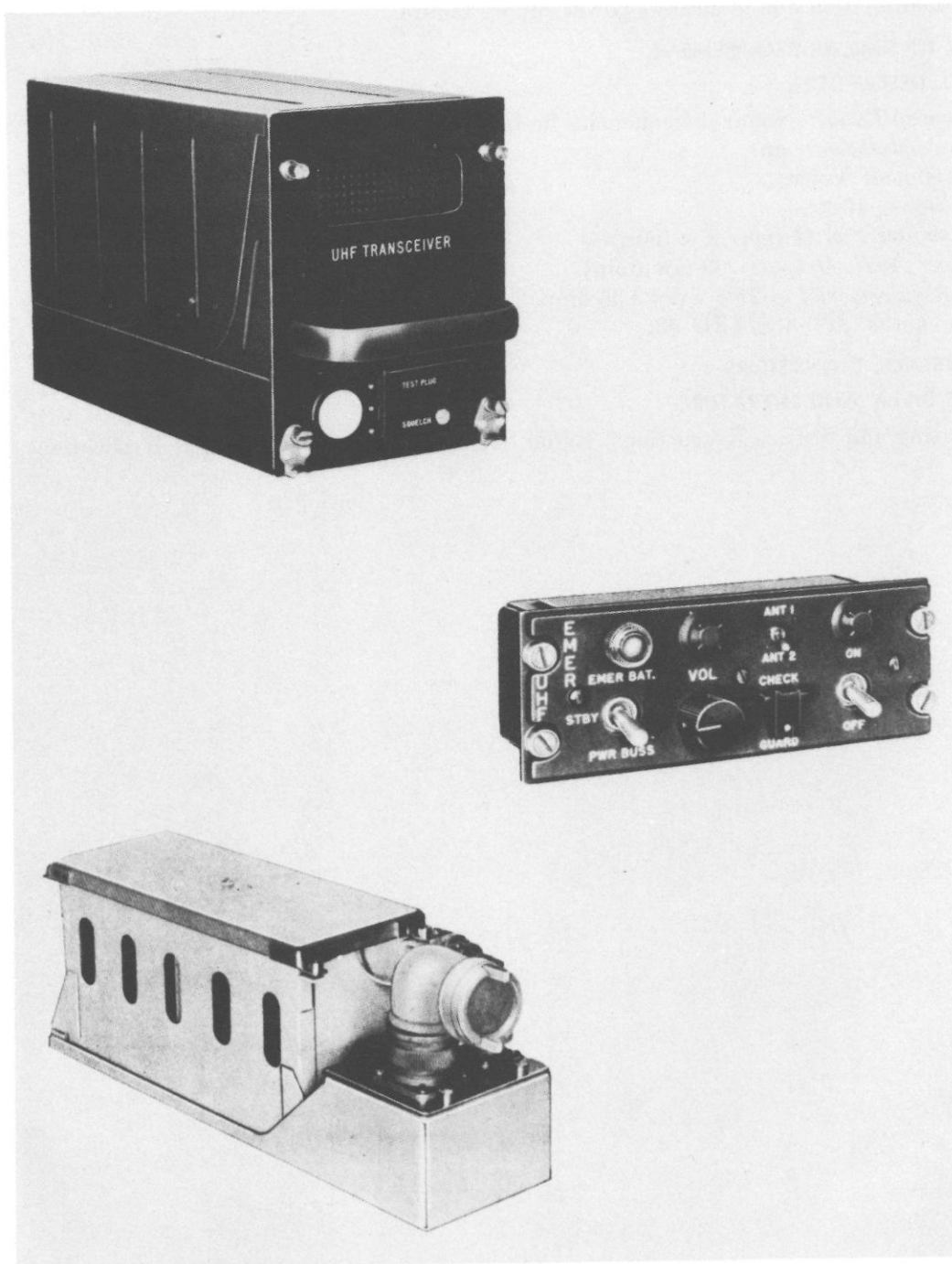

RADIO SET

AN/ARC-63

FUNCTIONAL DESCRIPTION:

Radio Set AN/ARC-63 is a subminiaturized, partially transistorized, single channel uhf communications system. It was developed to provide an emergency and back-up communication facility for all types of aircraft. The Radio Set is available for operation in the event of command system failure or malfunction due to aircraft power supply failure.

RELATION TO SIMILAR REQUIREMENT:

TECHNICAL DESCRIPTION:

Frequency Range: Nominal frequencies lie between 238 and 248 mc.

Type Modulation: am.

Type Signal: Voice.

Stability: ± 10 kc.

Transmitter Pwr Output: 2 w (min).

Receiver Audio Output: 200 mw (min).

Pwr Requirements: +27.5 v dc, 2.55 amp.

Major Units: RT-488/ARC-63.

TUBES, CRYSTALS, TRANSISTORS:

REFERENCE DATA AND LITERATURE:

Operating and Service Instructions, Radio Set AN/ARC-63 (Commercial Publication).

July 1962
 Cog Serv: USAF FSN:
 USA Line Item No:

RADIO SET
AN/ARC-65

USA USN USAF USMC

STATUS OR TYPE CLASS.:

A/Std

Manufacturer: Radio Corporation of America

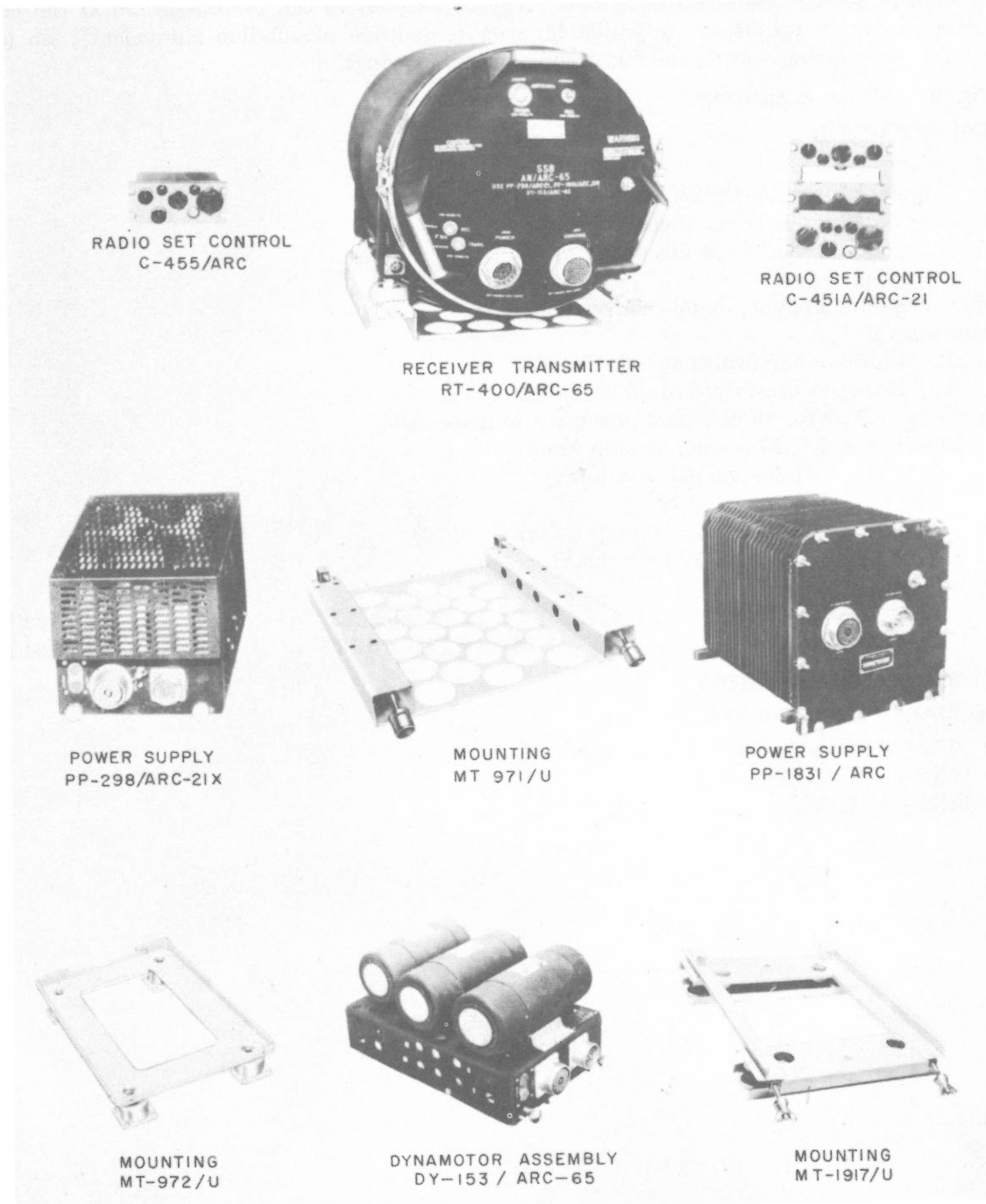

RADIO SET

AN/ARC-65**FUNCTIONAL DESCRIPTION:**

Radio Set AN/ARC-65 permits long-range communication from aircraft to aircraft, or aircraft to ground. Facilities also provide teletype operation with the addition of a teletypewriter and frequency shift keying adapter. The frequency range is from 2 to 23.9995 megacycles in 500-cycle steps, giving a total of 44,000 available frequencies. Any 20 frequencies can be preselected at the control unit. Four modes of operation are available: amc (amplitude modulation equivalent); ssb (single sideband); cw (continuous wave); and fsk (frequency shift keying).

RELATION TO SIMILAR EQUIPMENT:**TECHNICAL DESCRIPTION:***Transmitter:*

Pwr Output: Approximately 230 w (200 w above 16 mc).

Frequency Stability: ± 17 cps (below 10 mc).
 ± 22 cps (above 10 mc).

amc pwr output: 70 w.

Type: Superheterodyne; double conversion.

Selectivity:

4kc Minimum bandwidth at 6 db down.

8kc Maximum bandwidth at 60 db down.

Sensitivity: 1.2 μ v for 10 db signal plus-noise-to-noise ratio.

Pwr Requirements: +27.5 v dc, 59 amp (max).

115 v ac, 0.3 amp (max).

or

+27.5 v dc, 20 amp (max).

115 v ac, 37 amp (max).

Major Units:

1 RT-400/ARC-65

19'' x 18.12'' x 26.12''

132 lbs

1 C-451A/ARC-21

7.12'' x 5.75'' x 5.12''

5.34 lbs

TUBES, CRYSTALS AND TRANSISTORS:**REFERENCE DATA AND LITERATURE:**

TO 12R2-2ARC65-2, -2C, -3, -4, -501.

TO 12R2-2ARC21-514.

TO 12R2-2ARC-502.

RADIO SET
AN/ARC-66

17 November 1958
Cog Serv: USAF FSN
USA LINE ITEM NO:

	USA	USN	USAF	USMC
STATUS OR TYPE CLASS.:			A/Std	

Manufacturer: Radio Corporation of America

No Illustration Available

FUNCTIONAL DESCRIPTION:

Radio Set AN/ARC-66 is an airborne command, receiving-transmitting equipment for air-to-air and air-to-ground voice communication in the ultra high frequency range. This equipment, primarily designed for use in fighter aircraft, is a functional part of Communication-Identification-Navigation Sub-System AN/ASQ-30 and AN/ASQ-31.

This set provides a total of 1,750 crystal controlled frequencies. Any 20 of these channels can be preset in Radio Set Control C-1057/ARC-34. One guard channel in the 238- to 248-mc range can also be monitored simultaneously with normal operation of the set.

Audio input and output circuits are designed for use with Microphone Headset H-78A/AIC. Although this system is not physically similar to Radio Set AN/ARC-34, it uses the same subassemblies, with the exception of a 115-v three-phase, 400-cyc Power Supply PP-1730/ARC-66. Two additional Audio Frequency Amplifier Subassemblies AM-1657/ARC-66 and AM-1658/ARC-66 are incorporated in this equipment.

Flush-tail cap-type arrays, Antenna AT-256A/ARC, or any other ultra high frequency aircraft antenna with a 52-ohm coaxial transmission line, such as Radio Frequency Cable RG-8/U, can be used.

RELATION TO SIMILAR EQUIPMENT:

TECHNICAL DESCRIPTION:

Frequency Range in mc: 225.0 to 399.9.

Number of Frequencies: 1,750; spaced in increments of 100 kc.

Approximate Operational Range: 75 miles at 3,000 feet altitude.

Type Controls: Radio Set Control C-1057/ARC-34 provides an OFF-MAIN-BOTH-ADF switch, a MANUAL-PRESET-GUARD switch, a TONE push button, a preset channel selection knob, four manual frequency knobs, and a volume control.

Type Modulation: am.

Type Emission and Reception: Voice, tone.

Transmitter pwr Output: 8 w (minute).

Pwr Requirements:

Transmitting: 165 va, 115-v ± 10 v 400-cyc 3-phase ac 8 amp at 26.5-v ± 2.5 v dc.

Receiving: 75 va, 115-v ± 10 v 400-cyc 3-phase ac 8 amp at 26.5-v ± 2.5 -v dc.

Tuning: 75 va, 115-v ± 10 v 400-cyc 3-phase ac 9.5 amp 26.5-v ± 2.5 -v dc.

Major Units: RT-423/ARC-66

7 $\frac{1}{2}$ " x 24 $\frac{5}{16}$ " x 11 $\frac{1}{2}$ "

56 lbs

TUBES, CRYSTALS, TRANSISTORS:

REFERENCE DATA AND LITERATURE:

TO 12R2-4-19-2, -3, -4.

RADIO SET
AN/ARC-70()

July 1962
Cog Serv: USAF FSN:
USA Line Item No:

USA	USN	USAF	USMC
STATUS OR TYPE CLASS:			T/Std

Manufacturer: Collins Radio Co.

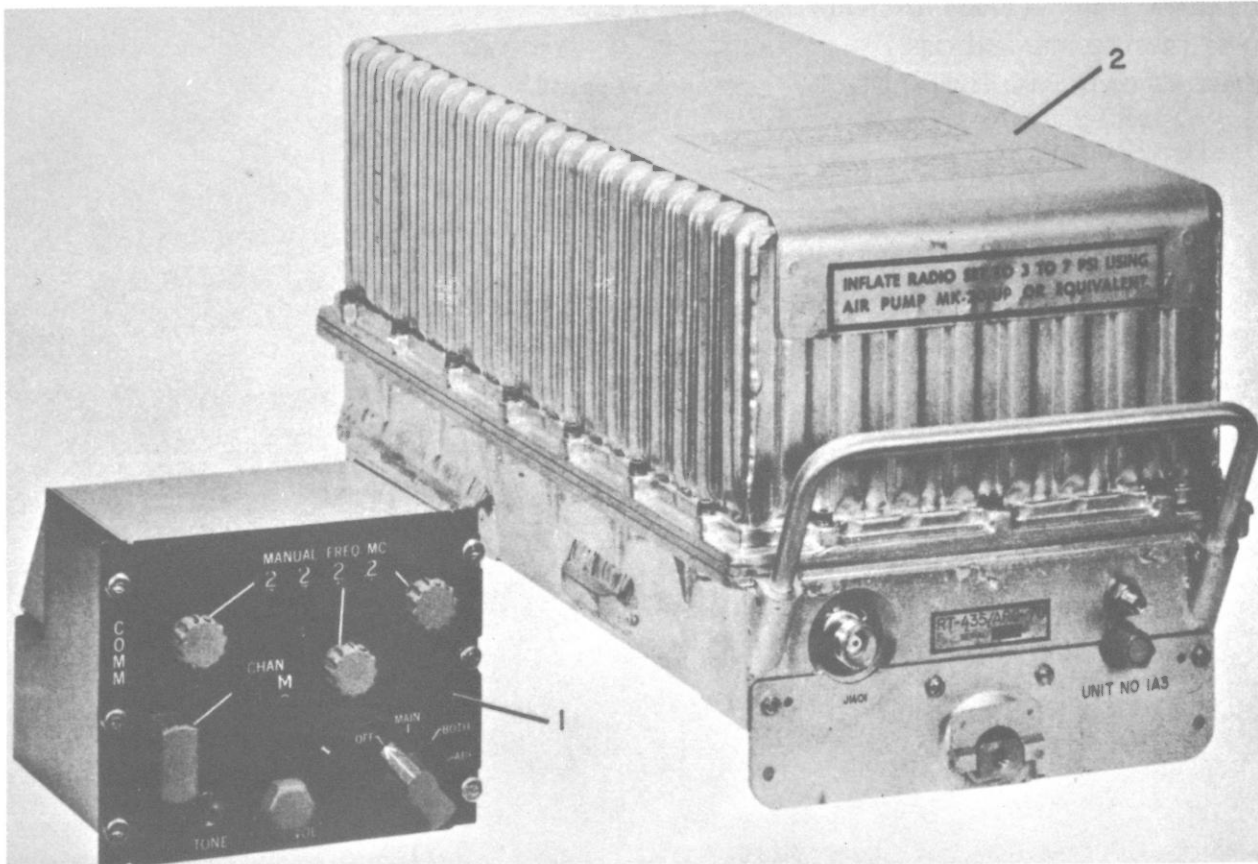

FUNCTIONAL DESCRIPTION:

The purpose of Radio Set AN/ARC-70 is to provide two-way telephone communication double side-band, full carrier between aircraft in flight, aircraft and shore and aircraft and ship. The radio set is capable of transmitting and receiving on any one of 1750 frequency channels, spaced at 100-kc intervals. Facilities are provided to monitor one predetermined frequency of 243 mc (guard).

RELATION TO SIMILAR EQUIPMENT:

TECHNICAL DESCRIPTION:

Frequency Range in mc: 225; to 399.9.

Type Modulation: am.

Type Emission: A2, A3.

Preset Channels: 20.

Transmitter Pwr Output: 16 w (min).

RADIO SET

AN/ARC-70()

Receiver Pwr Output: 50 mw (min).

Pwr. Requirements:

+43 v dc 275 ma.

+130 v dc 320 ma.

+27.5 v dc 10 amp.

-105 v dc 3 ma.

115 v ac 1 phase 0.85 amp.

Major Units: RT-435/ARC-70 7.6'' x 9'' x 22''.

TUBES, CRYSTALS, TRANSISTORS:

REFERENCE DATA AND LITERATURE:

TO 12R2-2ARC70-2, -3, -4.

TO 12P4-2ASQ37-501.

RADIO SET
AN/ARC-74

July 1962
 Cog Serv: USAF FSN:
 USA Line Item No:

	USA	USN	USAF	USMC
STATUS OR TYPE CLASS.:			Std	

Manufacturer: Bendix Radio

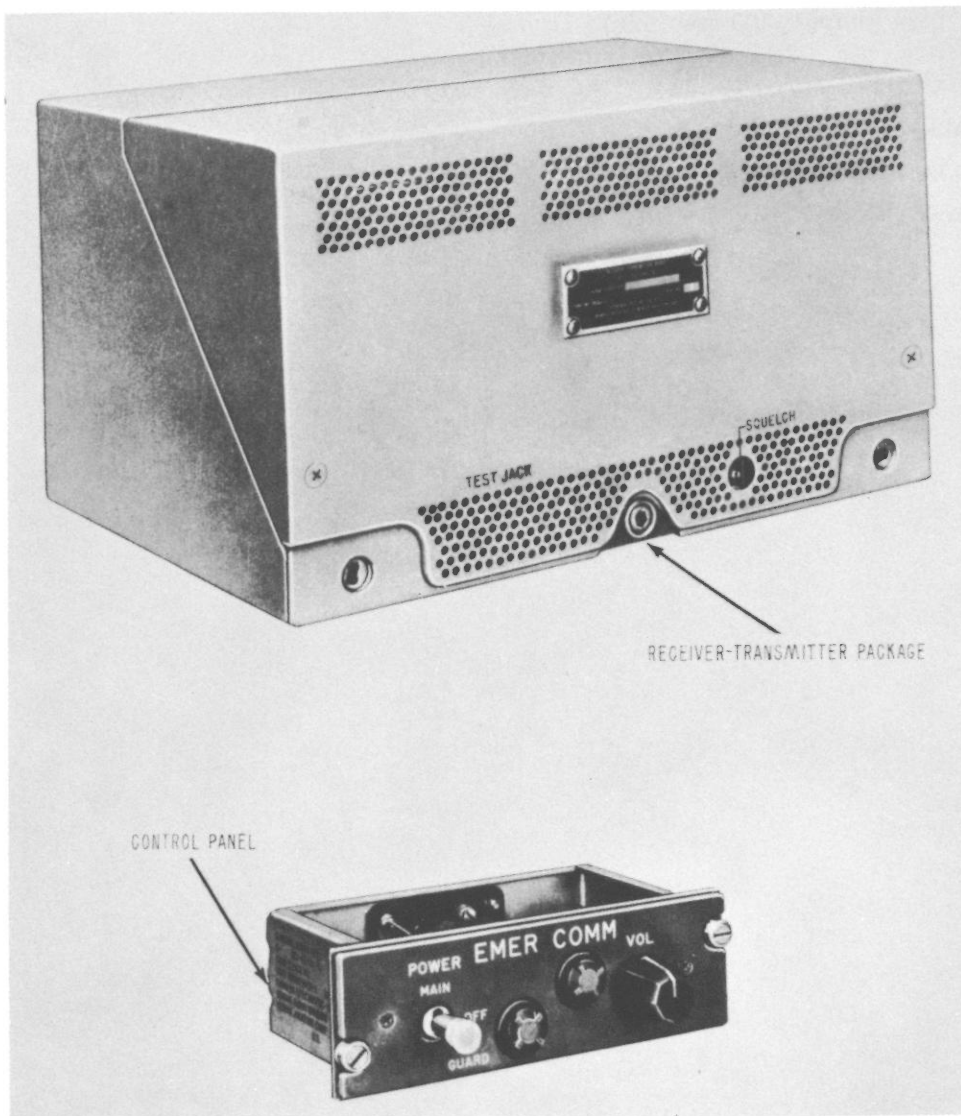

FUNCTIONAL DESCRIPTION:

Radio Set AN/ARC-74 was developed to provide an emergency and back-up communication facility. The radio set is available for operation in the event of failure of the command uhf communication system even if all power, except the 28-volt battery power fails.

RADIO SET

AN/ARC-74

RELATION TO SIMILAR EQUIPMENT:

TECHNICAL DESCRIPTION:

Frequency Range: 238 to 248 mc—Two channel.

Type Modulation: am.

Type Signal: Voice.

Stability: ± 10 kc.

Transmitter Pwr Output: 2 watts (min).

Receiver Audio Output: 200 mw (min).

Pwr Requirements: +28 v dc, 2.75 amps (max).

Major Units: RT-567/ARC-74 5 $\frac{1}{4}$ " x 7 $\frac{5}{8}$ " x 10"

13 lbs

TUBES, CRYSTALS, TRANSISTORS:

REFERENCE DATA AND LITERATURE:

TO 12R2-2ARC74-2, -3, -4, -501.

RADIO SET
AN/ARC-85

July 1962
 Cog Serv: USAF FSN:
 USA Line Item No:

	USA	USN	USAF	USMC
STATUS OR TYPE CLASS.:			Std	
Manufacturer:	Burroughs Corp			

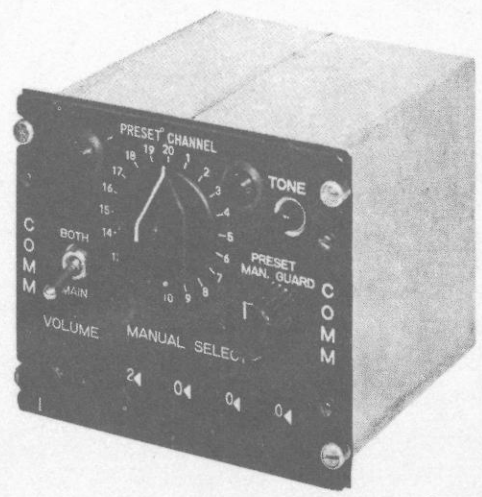
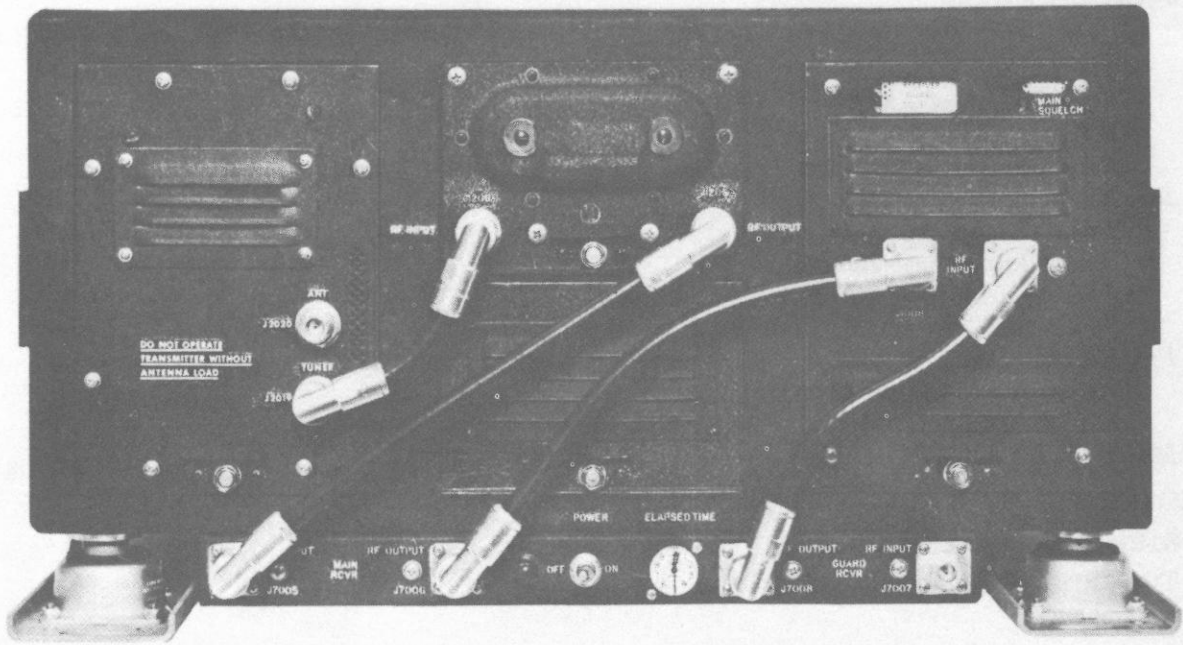

RADIO SET

AN/ARC-85**FUNCTIONAL DESCRIPTION:**

The AN/ARC-85 Command set is a uhf transmitter-receiver which provides aircraft or ground stations with voice or tone modulated transmission capability. The AN/ARC-85 operates in the frequency band of 225-399.9 mc. This 175-mc frequency range is tunable in 1750 discrete frequency increments spaced 0.1 mc apart. The transmitter and receiver are coincidentally servo-tuned to channels selected via radio set control unit which may be located, normally, as much as 50 feet from the receiver-transmitter unit.

RELATION TO SIMILAR EQUIPMENT:**TECHNICAL DESCRIPTION:***Transmitter:**Pwr Output:* 50 w.*Type Emission:* A3, A1.*Frequency Accuracy:* ± 5 kc.*Frequency Range:* 225-399.9 mc.*Receiver:**Audio Output:* 0.5 v rms (min).*Output Impedance:* 200 ohms.*Audio Fidelity:* +1 to -3 db from 300-6000 cps.*Sensitivity:* 5 uv (max), 10 db S+N/N Ratio.*Pwr Requirements:*

115/200 v ac, 3-phase 24 amp.

28 v dc, 5 amp.

Major Units: AN/ARC-8512'' x 23 $\frac{5}{16}$ '' x 21 $\frac{1}{4}$ ''

116 lbs

TUBES, CRYSTALS, TRANSISTORS:**REFERENCE DATA AND LITERATURE:**

TO 12R2-2ARC85-3, -4, -13, -14, -23, -33, -43, -44.

RADIO SET

AN/ARC-Type ARC Type 210

July 1962
Cog Serv: USAF FSN:
USA Line Item No:

USA USN USAF USMC

STATUS OR TYPE CLASS.:

Manufacturer: Aircraft Radio Corp

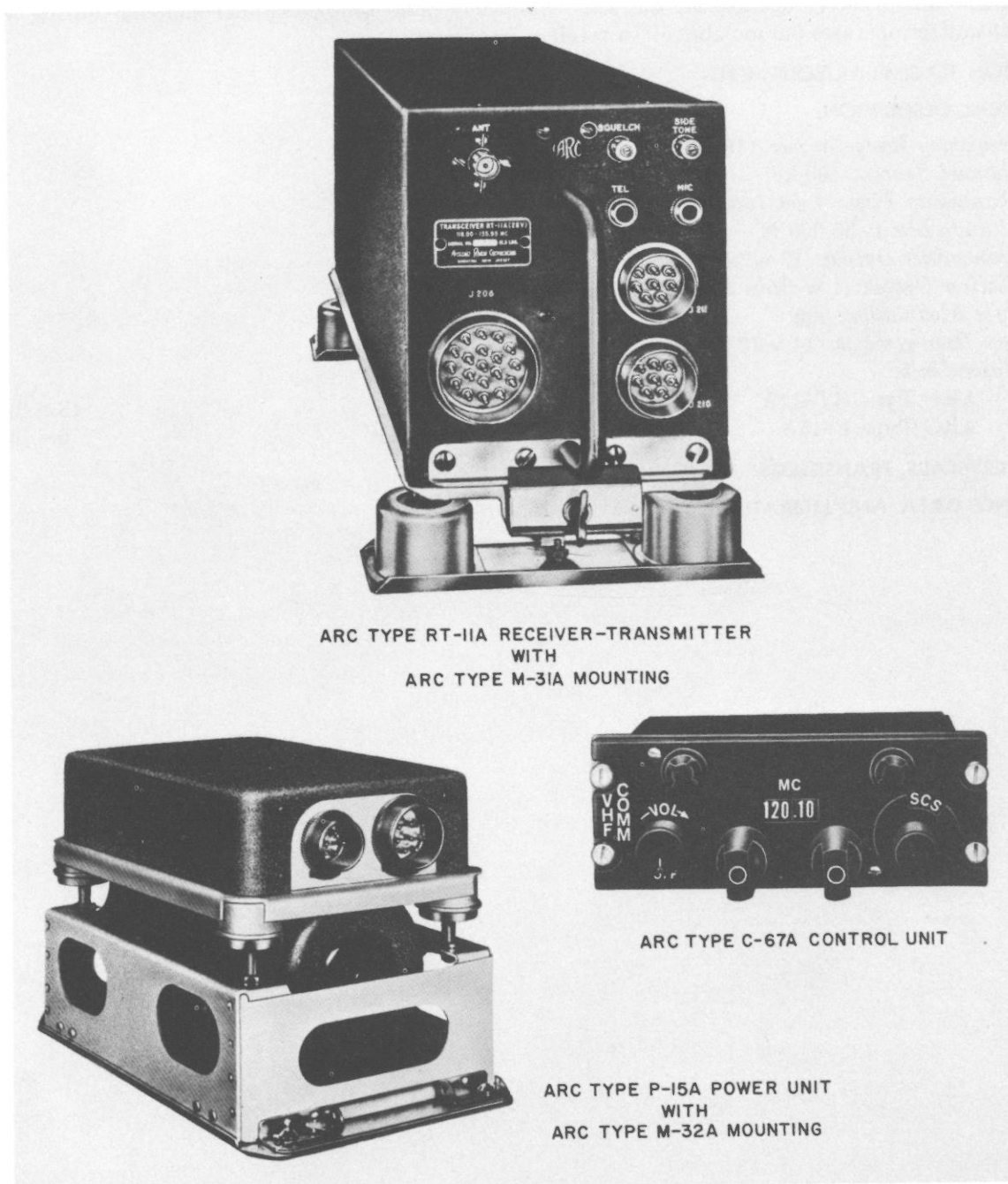

ARC TYPE RT-11A RECEIVER-TRANSMITTER
WITH
ARC TYPE M-31A MOUNTING

ARC TYPE C-67A CONTROL UNIT

ARC TYPE P-15A POWER UNIT
WITH
ARC TYPE M-32A MOUNTING

RADIO SET

**AN/ARC-Type
ARC Type 210**

FUNCTIONAL DESCRIPTION:

The ARC Type 210 vhf Communication Equipment is an airborne, 360-channel, transmitting-receiving system. Two modes of operation are available, single-channel simplex, during which the transmitter and receiver operate on the same frequency, and double-channel simplex, during which the transmitter operates 6.0 mc above the receiver frequency.

RELATION TO SIMILAR EQUIPMENT:

TECHNICAL DESCRIPTION:

Frequency Range in mc: 118 to 135.95.

Channel Spacing: 50 kc.

Channeling Time: 4 sec (max).

Altitude Limit: 30,000 ft.

Transmitter Output: 12 w (min).

Receiver Output: 1 w (into 300 ohms load).

Type Modulation: am.

Pwr Requirements: 14 v 13.2 amp or 28 v 6.5 amp.

Major Units:

ARC Type RT-11A

7½'' x 5'' x 15⅞''

13.8 lbs

ARC Type P-15A

5⅞'' x 5⅞'' x 8⅝''

6.5 lbs

TUBES, CRYSTALS, TRANSISTORS:

REFERENCE DATA AND LITERATURE:

AN/ARC-Type
HACON

July 1962
Cog Serv: USAF FSN:
USA Line Item No.

USA USN USAF USAF USMC

STATUS OR TYPE CLASS.:

Manufacturer: Hughes Aircraft Co.

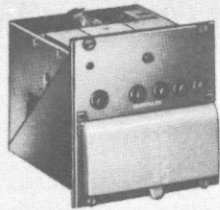

FREQUENCY SELECTOR

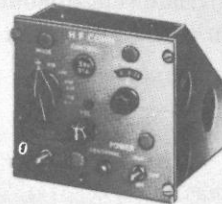

MASTER CONTROL

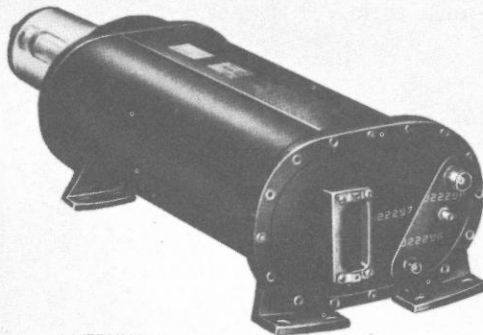

ANTENNA
COUPLER

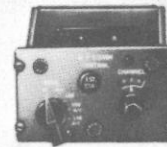

AUXILIARY CONTROL

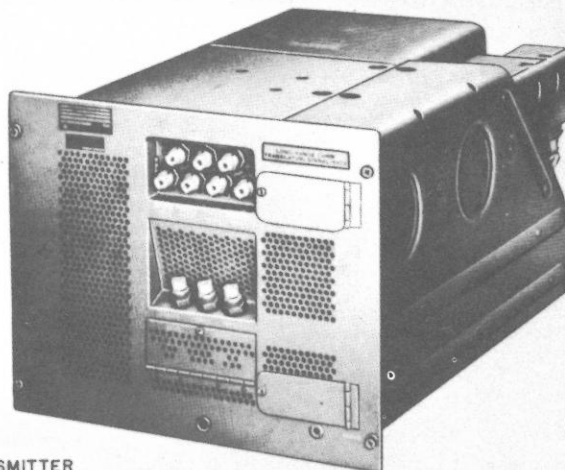

RECEIVER-TRANSMITTER

LONG RANGE COMMUNICATION SYSTEM

**AN/ARC-Type
HACON****FUNCTIONAL DESCRIPTION:**

The Long Range Communication System provides long range, high-frequency radio communication from aircraft to aircraft and aircraft to ground. The system provides both am and single side-band operational capabilities with reliable voice communication facilities for a range up to 5,000 nautical miles. Five modes of transmission and reception are available for selection: am (amplitude modulation); usb (upper side-band); lsb (lower side-band); usb A/C (upper side-band w/Augmented Carrier) and lsb A/C (lower side-band w/Augmented Carrier).

RELATION TO SIMILAR EQUIPMENT:**TECHNICAL DESCRIPTION:**

Frequency Range: 2 to 35.999 mc.

Variable in increments of 1 kc.

Transmitter pwr output: 1000 ± 100 w below 25 mc.

Frequency and accuracy stability: One part in ten million per day.

Tuning and loading time: 16 sec (max).

Preset channels: 20.

Audio Output: 200 mw (min).

Sensitivity: 2 μv 10-db signal plus signal-to-noise ratio.

Pwr Requirements:

+28 v dc, 20 amps (max).

+150 v dc, 1.5 amps (max).

-150 v dc, 0.25 amps (max).

115 v ac 3-phase 400 cyc 24 amp (max).

Major Units:

P/N 331650

11.6'' x 14.0'' x 22''

125.3 lbs

P/N 331700

5.4'' x 5.6'' x 6.5''

3.0 lbs

P/N 332750

5.2'' x 5.8'' x 6.5''

7.1.

TUBES, CRYSTALS, TRANSISTORS:**REFERENCE DATA AND LITERATURE:**

TO 12R2-4-37-2, -501.

TO 12R2-4-35-3, -4.

TO 12R2-4-34-4, -14.

TO 12R2-4-33-3, -4, -501.

TO 12R2-4-32-3, -4, -501, -502.

COMMUNICATIONS SYSTEM

AN/ARC-type HF-101, -102, -103

July 1962
 Cog Serv: USAF FSN:
 USA Line Item No.:

	USA	USN	USAF	USMC
STATUS OR TYPE CLASS.:			T/Std	
Manufacturer:	Collins Radio Corp.			

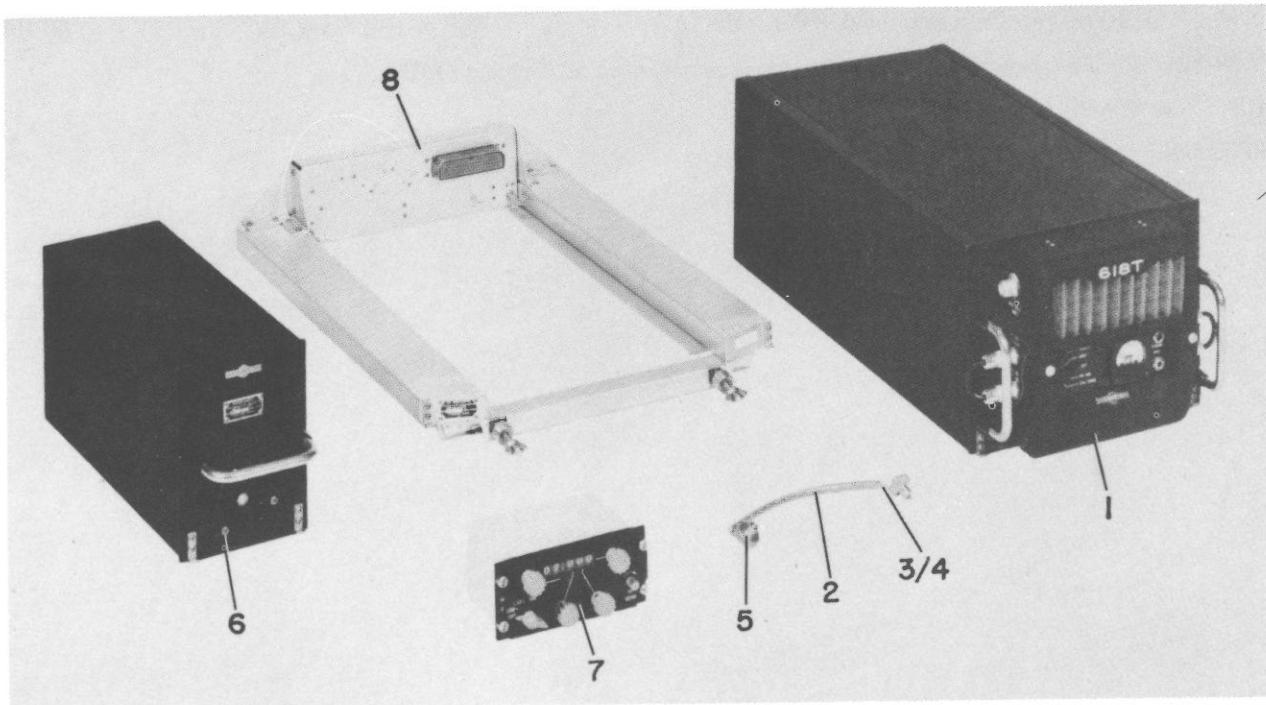

FUNCTIONAL DESCRIPTION:

Radio Receiver-Transmitter Type 618T-() provides either single sideband or compatible am voice reception and transmission. Frequency selection in 1-kilocycle increments over the entire band provides a total of 28,000 operating frequencies. In single sideband operation an option is provided for operation on either the upper or lower sideband.

RELATION TO SIMILAR EQUIPMENT:

TECHNICAL DESCRIPTION:

Altitude Range: To 40,000 ft.
Frequency Range: 2.0 to 29.999 mc.
Frequency Stability: One-part per million per month.
Channeling Time: 8 seconds (max).
RF Pwr Output: ssb: 400 w PEP.
 am: 100 w Carrier.

COMMUNICATIONS SYSTEM

**AN/ARC-Type
HF-101, -102, -103**

Sensitivity: ssb: 1 μv for db.

S+N/N ratio.

am: 3 μv for 6 db S+N/N ratio.

Audio output: 100 mw into 300-ohm load.

Major Units:

1 Receiver-Transmitter 618T-1 (HF101)	7 $\frac{7}{8}$ " x 10 $\frac{1}{8}$ " x 22 $\frac{3}{16}$ "	50 lbs
1 Receiver-Transmitter 618T-2 (HF102)	7 $\frac{7}{8}$ " x 10 $\frac{1}{8}$ " x 22 $\frac{3}{16}$ "	50 lbs
1 Receiver-Transmitter 618T-3 (HF103)	7 $\frac{7}{8}$ " x 10 $\frac{1}{8}$ " x 22 $\frac{3}{16}$ "	50 lbs

NOTE. For new installations, Power Supply is contained in 618T-2 and 618T-3.

TUBES, CRYSTALS, TRANSISTORS:

REFERENCE DATA AND LITERATURE:

TO 12R2-4-42-2, -4.

COMMUNICATIONS SET
AN/ARC-Type
VHF-101

July 1962
 Cog Serv: USAF FSN:
 USA Line Item No:

	USA	USN	USAF	USMC
STATUS OR TYPE CLASSIFICATION			A/Std	

Manufacturer: Collins Radio

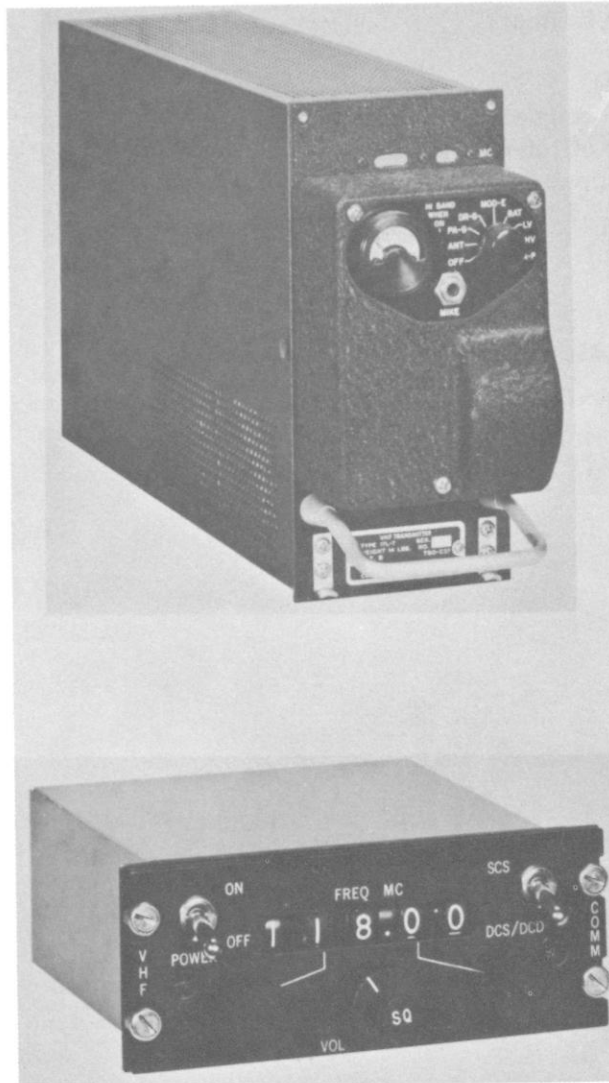

FUNCTIONAL DESCRIPTION:

Communications Set VHF-101 provides voice communications from aircraft to aircraft, or ground, as well as full air traffic control signal system functions. The frequency range is from 116 to 139.95

COMMUNICATIONS SET

**AN/ARC-Type
VHF-101**

megacycles in 50 Kilocycle steps, giving a total of 680 available frequencies. Any frequency available may be selected at the control unit.

Three modes of operation are available; single-channel simplex, double-channel simplex; and double-channel duplex.

RELATION TO SIMILAR EQUIPMENT:**TECHNICAL DESCRIPTION:**

Altitude Range: 30,000 ft. (max).

Type Emission: A3.

Pwr output: 20 w (min).

Stability: $\pm 0.004\%$ of assigned channel frequency.

Audio output: Capable of 100 mw.

Sensitivity: 3 uv max input for 6 db signal-plus-noise to noise ratio.

Pwr Requirements: +27.5 v dc, 11 amp (max).

Major Units:

1 Receiver, 51X-2B

12 $\frac{1}{16}$ " x 3 $\frac{1}{16}$ " x 7 $\frac{1}{2}$ "

10.5 lbs

1 Transmitter 17L-7A

15 $\frac{3}{16}$ " x 3 $\frac{1}{16}$ " x 7 $\frac{5}{8}$ "

14.5 lbs

TUBES, CRYSTALS, TRANSISTORS:**REFERENCE DATA AND LITERATURE:**

TO 12R2-4-28-2, -3, -4.

TO 12R2-4-29-2, -3, -4.

RADIO RECEIVING SET
AN/ARN-30, -30A, -30B

15 March 1962

Cog Serv: USN FSN: 5826-537-3991

USA Line Item No: 658482

	USA	USN	USAF	USMC
STATUS OR TYPE CLASS.:	Std-A		Std	

Manufacturer: CBY (00781)

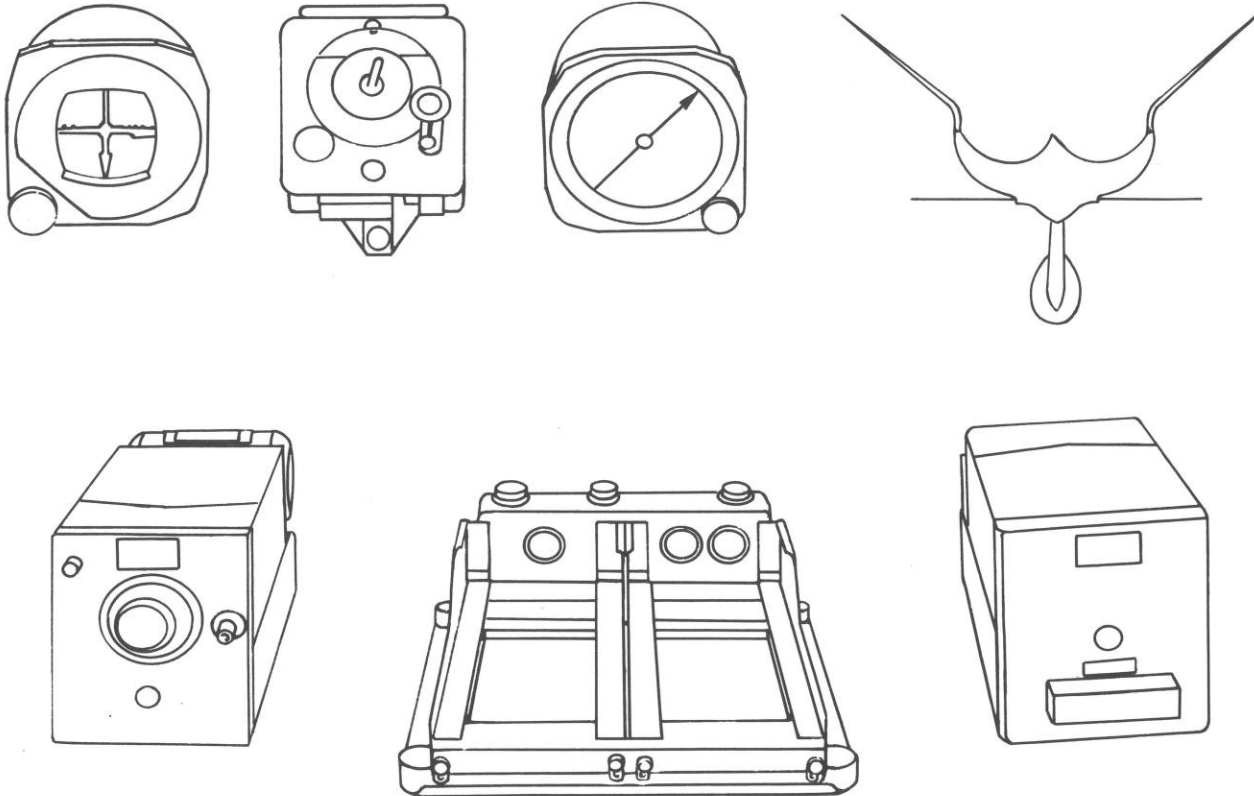
**FUNCTIONAL DESCRIPTION:**

These equipments are airborne navigation-communication receiving systems for use in aircraft equipped with a 28 v dc power source. These equipments are functionally interchangeable, but differ slightly in major components. They provide for vhf omnidirectional radio range (VOR), visual-aural range (VAR), 90-150 cps runway tone localizers (AMP LOC), and voice reception on all frequencies covered by the receiver, simultaneously with the navigation facilities, if desired.

RELATION TO SIMILAR EQUIPMENT:

The AN/ARN-30 is manufacturer's vhf Navigational Receiving Equipment Type 15C. The AN/ARN-30A is manufacturer's Type 15D. The AN/ARN-30B is electrically, mechanically, and functionally interchangeable with AN/ARN-30A, but differs in the radio set control used.

TECHNICAL DESCRIPTION:

Frequency Range: 108-135 mc.

Tuning: Continuous.

RADIO RECEIVING SET

AN/ARN-30, -30A, -30B

Frequency Stability: 0.04 percent (max).

Type Receiver: Superheterodyne.

Audio Output: 170 mw at avc knee (at approximately 6 uv input), 360 mw at 100,000 uv input with 30 percent modulation at 400 cps, into a 300-ohm load.

Sensitivity: 2 uv or better throughout frequency range for (10 mw with 30 percent modulation at 400 cps, into a 300-ohm load).

Selectivity: Total bandwidth 100 kc for 6 db, 350 kc for 60 db.

Intermediate Frequency: 15 mc.

Tuning Accuracy: Better than 0.2 percent.

Operating pwr Requirements: 28 v dc.

Antenna Type: Ramshorn type comprising two broadband antennas.

Dynamotor DY-86/ARN-30 characteristics:

Rated Input Voltage: 25 v dc.

Rated Input Current: 1.7 amp.

Rated Output Voltage: 250 v dc.

Rated Output Current: 85 ma.

Rated Speed: 7,000 rpm.

Altitude Rating: 40,000 ft (max).

Major Units:	AN/ARN-				
	30	30A	30B		
R-445/ARN-30	1	1	1	4 ¹³ / ₁₆ " x 5 ¹ / ₂ " x 11 ¹ / ₂ "	8.6 lbs
CV-217/ARN-30	1			4 ¹³ / ₁₆ " x 5 ¹ / ₂ " x 11 ¹ / ₂ "	4.5 lbs
CV-265/ARN-30A		1	1	4 ²⁷ / ₃₂ " x 5 ⁵ / ₈ " x 11 ¹ / ₂ "	5.8 lbs
AM-609/ARN-30	1			4 ¹³ / ₁₆ " x 5 ¹ / ₂ " x 6 ¹³ / ₁₆ "	4 lbs
ID-48/ARN	1	1	1	3 ¹ / ₄ " x 3 ¹ / ₄ " x 4 ¹³ / ₁₆ "	1.9 lbs
ID-322/ARN-30	1	1	1	3 ¹ / ₄ " x 3 ¹ / ₄ " x 5 ⁵ / ₁₆ "	1.5 lbs

TUBES, CRYSTALS, TRANSISTORS:

REFERENCE DATA LITERATURE:

AN/16-45-132 for (AN/ARN-30).

AN/16-30ARN30-1 for (AN/ARN-30A).

RADIO SET
AN/ARR-15

17 November 1958
 Cog Serv: USN FSN: 5820-665-2538
 USA Line Item No.:

	USA	USN	USAF	USMC
STATUS OR TYPE CLASS.:			Ltd Std	
Manufacturer: Collins Radio Co.				

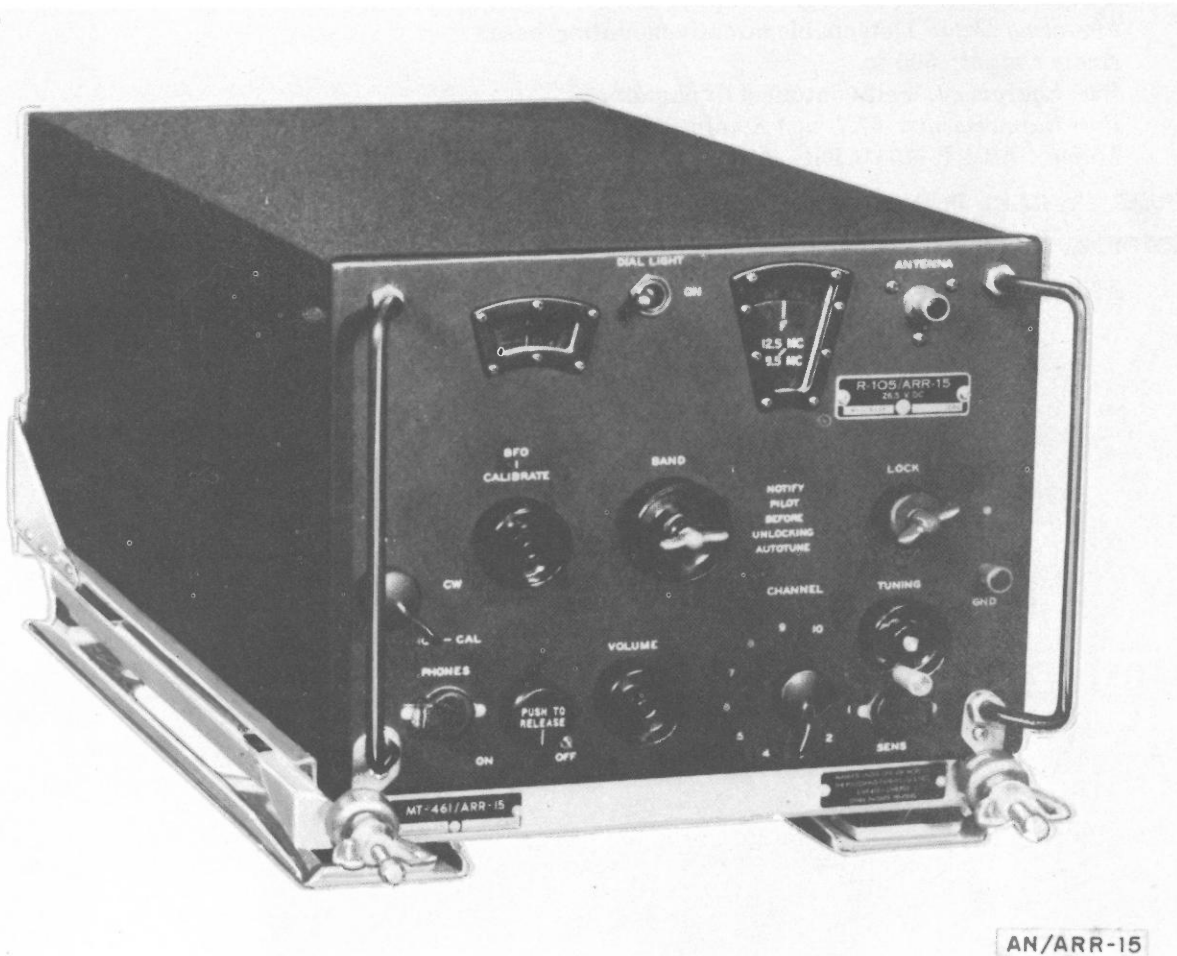

FUNCTIONAL DESCRIPTION:

Radio Set AN/ARR-15 is a general purpose receiver designed for medium high frequency communication. It may be controlled locally or from a remote position.

An autotune system permits automatic mechanical selection of any one of 10 preset crystal-controlled channels within the provided frequency range.

This equipment is similar to Radio Set AN/ARR-15A except that the A model has an electron tube substituted for a crystal.

RELATION TO SIMILAR EQUIPMENT:

RADIO SET

AN/ARR-15

TECHNICAL CHARACTERISTICS:

Frequency Range in mc: 1.5 to 18.5.

Frequency Control: crystal (10 preset channels).

Type Modulation: am.

Type Reception: cw, mcw, voice.

Antenna: Fixed aircraft; 17 to 34 feet long.

Design: Contained in single compact case.

Mounting Data: Detachable aircraft mounting base.

Audio Output: 500 w.

Pwr Equipment: Self-contained dynamotor.

Pwr Requirements: 47.7 w, 1.8 amp at 26.5-v dc.

Major Units: R-105/ARR-15 23 $\frac{1}{4}$ " x 10 $\frac{3}{8}$ " x 9 $\frac{9}{16}$ "

40 lbs

TUBES, CRYSTALS, TRANSISTORS:

REFERENCE DATA AND LITERATURE:

AN 16-30ARR15-3.

RADIO SET
AN/ARR-15A

17 November 1958
 Cog Serv: USN FSN: 5820-642-6829
 USA Line Item No:

	USA	USN	USAF	USMC
STATUS OR TYPE CLASS:			L/Std	
Manufacturer: Collins Radio Co				



AN/ARR-15A

FUNCTIONAL DESCRIPTION:

Radio Set AN/ARR-15A is a general purpose receiver designed to provide preset, multichannel, voice, continuous wave, or modulated continuous wave, pilot or radio operated reception. It is suitable for installation in all types of naval aircraft.

This equipment may be controlled from the receiver panel or from a remote position.

An autotune system permits the selection of any one of 10 channels and may be adjusted to select any 10 frequencies within the range of the set.

Radio Sets AN/ARR-15 and AN/ARR-15A are functionally similar. However, the AN/ARR-15A incorporates an improved autotune unit and minor component changes; an electron tube has been substituted for a crystal.

RELATION TO SIMILAR EQUIPMENT:

RADIO SET

AN/ARR-15A

TECHNICAL DESCRIPTION:

Frequency Range in mc: 1.5 to 18.5 in six bands.

Band A: 1.5 to 2.5 mc.

Band B: 2.5 to 3.5 mc.

Band C: 3.5 to 5.5 mc.

Band D: 5.5 to 8.5 mc.

Band E: 8.5 to 12.5 mc.

Band F: 12.5 to 18.5 mc.

Type Modulation: am.

Type Reception: Voice, mcw, cw.

Operating Temperature Range: -40° C. to $+60^{\circ}$ C.

Altitude: 40,000 feet above sea level (maximum).

Audio Output: 500 mw (maximum).

Pwr Requirements: 26.5 v dc.

Major Units: R-105A/ARR

$7\frac{7}{8}'' \times 10\frac{1}{2}'' \times 21\frac{1}{6}''$

39.5 lbs

TUBES, CRYSTALS, TRANSISTORS:

REFERENCE DATA AND LITERATURE: AN 16-30ARR15-3.

RADIO SET
AN/ARR-36

17 November 1958
 Cog Serv: USAF FSN:
 USA Line Item No:

	USA	USN	USAF	USMC
STATUS OR TYPE CLASS:			L/Std	

Manufacturer: Radio Corporation of America

No illustration available

FUNCTIONAL DESCRIPTION:

Radio Set AN/ARR-36 is an airborne receiving set that can be operated independently of any other communication equipment. It is normally used in conjunction with Radio Set AN/ARC-21 or AN/ARC-21X to provide auxiliary receiving facilities and cross band operation.

The equipment will receive continuous wave and voice transmission, as well as frequency-shift keying transmission when a suitable converter is used.

Remote, automatic tuning is provided in the high frequency range covered by the set. Radio Set Controls C-451/ARC-21 and C-455/ARC-21 may be used with this equipment to provide 20 preset frequencies.

RELATION TO SIMILAR EQUIPMENT:

TECHNICAL DESCRIPTION:

Frequency Range in mc: 2 to 24.

Number of Frequencies: 44,000.

Type Modulation: am.

Type Reception: Voice, cw.

Operational Altitude: 50,000 ft (max).

Pwr Output: 900 mw into 200 ohms impedance.

Pwr Requirements:

Receiving: 9 amp at 27.5 v dc.

Tuning: 12 amp at 27.5 v dc.

Major Units: R-224/ARR-36

10¼" x 12" x 25"

53.4 lbs

TUBES, CRYSTALS, TRANSISTORS:

REFERENCE DATA AND LITERATURE:

TO 12R2-2ARC21-1, -2, -3, -4.

MIL-R-9453.

RADIO RECEIVING SET

AN/ARR-41

15 March 1962
 Cog Serv: USN FSN:
 USA Line Item No:

USA	USN	USAF	USMC
-----	-----	------	------

STATUS OR TYPE CLASS.:

Manufacturer:



FUNCTIONAL DESCRIPTION:

Radio Receiving Set AN/ARR-41 is a general purpose receiver for mounting in larger types of aircraft. The set is capable of receiving am, cw and fsk (when an external converter is used for operation of the printer).

RELATION TO SIMILAR EQUIPMENT:

TECHNICAL DESCRIPTION:

Frequency Range: 190-550 kc and 2-25 mc.

RADIO RECEIVING SET

AN/ARR-41

Reception: A1, A2, A3.

Type Receiver: Superheterodyne with double conversion on all bands except the 2-4 mc band which is single conversion.

Frequency Stability: 190-550 kc Band: ± 2.1 kc. 2-25 mc Band: ± 1.9 kc + 0.01 percent.

Spurious Frequencies: Attenuated by at least 60 db below 5 uv.

Sensitivity: Input of less than 5 uv will produce power output of at least 300 mw into a 300 ohm audio load. Power output will increase to as high as 500 mw with stronger signals.

Signal Plus Noise/Noise Ratio: At least 6 db for radiotelephone and 10 db for cw reception.

Temperature Range: -55 degrees C to +71 degrees C.

Operating Pwr Requirements: 27.5 v dc, 3 amperes above 0 degrees C, 5.8 amperes below 0 degrees C.

Major Units: R-648/ARR-41

7 $\frac{1}{16}$ " x 17" x 13 $\frac{1}{8}$ "

132.5 lbs

TUBES, CRYSTALS, TRANSISTORS:

REFERENCE DATA AND LITERATURE:

NAVAER 16-30ARR41-501, Technical Manual for Radio Receiving Set AN/ARR-41.

17 November 1958
Cog Serv: USN FSN: 5820-665-2307
USA Line Item No.: 657930

RADIO TRANSMITTING SET
AN/ART-13

USA USN USAF USMC

STATUS OR TYPE CLASS:

L/Std

Manufacturer: Collins Radio Co, Inc

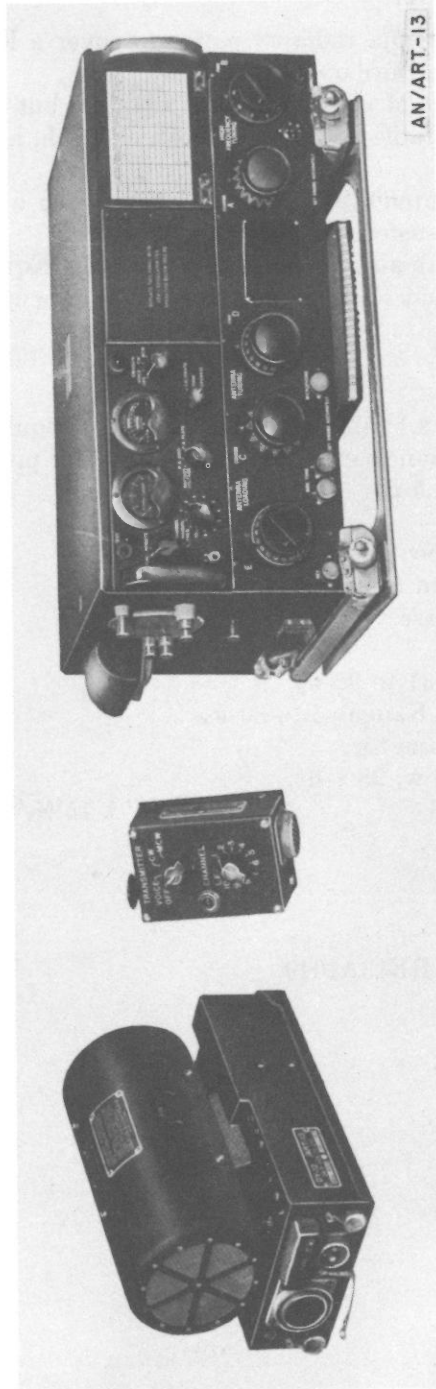

RADIO TRANSMITTING SET

AN/ART-13**FUNCTIONAL DESCRIPTION:**

Radio Transmitting Set AN/ART-13 is a compact, light-weight, radio transmitter for air-ground communication in aircraft. An autotune system permits rapid selection of 10 preset channels within the high frequency range. Selection of operating method is accomplished through a local remote switch by the radio operator or the pilot.

The danger of permitting antenna radiated power to cover a longer range than is necessary has been eliminated by the use of a pressure operated relay.

This equipment includes a set of connectors and adapters but not the necessary interconnecting wires and cables. Microphones, a table-type key, a throttle switch, headphones, and an antenna system are required but not supplied.

Either a trailing long wire antenna or a fixed antenna with a shunt capacitor can be used. A transmitter-to-receiver antenna transfer relay switch is included.

The equipment is identical with aircraft Radio Transmitting Equipment ATC and similar to Radio Transmitting Set AN/ART-13A and Radio Transmitting Equipment TCZ.

RELATION TO SIMILAR EQUIPMENT:**TECHNICAL DESCRIPTION:**

Frequency Range in mc: 2 to 18.1; 0.2 to 1.5 with additional equipment.

Number of Channels: 10 hf channels only; use of a lf oscillator provides an additional channel in the frequency band 0.2 mc to 1.5 mc.

Frequency Control: Crystal.

Type Emission: Voice, cw, mcw.

Keying: Relay keying; 30 wpm (max speed).

Mounting: Shock-mounting base.

Pwr Output:

High Frequency Range: 31 to 90 w.

Optional Low Frequency Range: 5 to 80 w.

Pwr Supply Equipment: Dynamotor.

Pwr Requirements: 770 to 896 w, 28 v dc.

Major Units: 1 T-47/ART-13

11¹/₂" x 15¹/₂" x 23³/₁₆"

67 lbs

TUBES, CRYSTALS, TRANSISTORS:**REFERENCE DATA AND LITERATURE:**

AN 08-30ART13-5.

RE13A583B; EN28/2280-43; RE13A1040.

18 November 1958
Cogn Serv: USAF FSN:
USA Line Item No:

RADIO TRANSMITTING SET
AN/ART-13A

USA USN USAF USMC

STATUS OR TYPE CLASS.:

L/Std

Manufacturer: Collins Radio Co, Inc

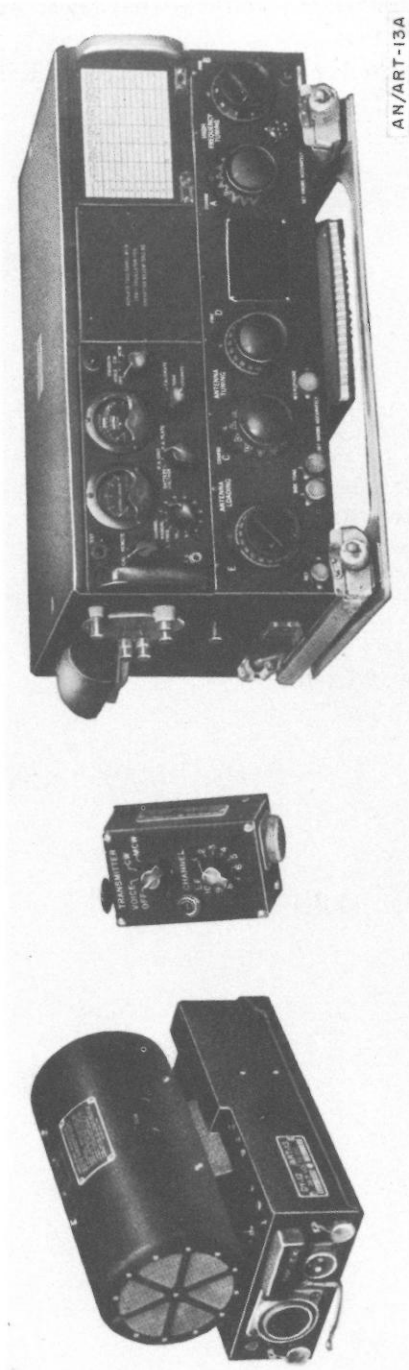

RADIO TRANSMITTING SET

AN/ART-13A

FUNCTIONAL DESCRIPTION:

Radio Transmitting Set AN/ART-13A is designed for air-ground communication in aircraft. It uses an autotune system that permits rapid selection of any one of 11 channels, as well as choice of type of emission. The autotune system can be controlled either by the radio operator or by the pilot.

A pressure operated relay automatically reduces the power output by 50 percent whenever the aircraft reaches an altitude of 25,000 feet.

This equipment is similar to Radio Transmitting Set AN/ART-13 and Aircraft Radio Transmitting Equipment ATC.

RELATION TO SIMILAR EQUIPMENT:

TECHNICAL DESCRIPTION:

Frequency Range in mc:

Low: 0.2 to 1.5.

High: 2 to 18.

Frequency Control: Crystal.

Number of Channels:

Low Frequency: 1.

High Frequency: 10.

Type Modulation: am.

Type Emission: Voice, cw, mcw.

Keying: Relay keying; max speed 30 wpm.

Mounting: Shock-mounting base.

Pwr Output:

Low Frequency: 5 to 80 w.

High Frequency: 31 to 90 w.

Pwr Requirements: 770 to 896 w, 28 v dc.

Major Units:

O-17/ART-13A.

T-47A/ART-03

11 $\frac{1}{2}$ " x 15 $\frac{1}{2}$ " x 23 $\frac{1}{16}$ "

67 lbs

TUBES, CRYSTALS, TRANSISTORS:

REFERENCE DATA AND LITERATURE:

RE13A583B; EN28/2280-43; RE13A1040.

AIRCRAFT RADIO TRANSMITTING EQUIPMENT

AN/ART-Type
GP, GP-2

25 November 1958
 Cog Serv: USN FSN:
 USA Line Item No: (GP-2) 668768

	USA	USN	USAF	USMC
STATUS OR TYPE CLASS.:	Std A (GP-2)			

Manufacturer: RCA Manufacturing Co

**FUNCTIONAL DESCRIPTION:**

Aircraft Radio Transmitting Equipments GP and GP-2 are high-power radio-transmitting equipments for aircraft service featuring compactness, light weight, and unusual flexibility of installation and usage. They are intended primarily for use in observation and scouting airplanes but can be employed in any aircraft equipped with proper power supplies and radiating systems.

Both models are fundamentally identical, differing only in that certain accessories required for an operative installation and furnished with the GP are omitted in the GP-2.

The following equipment is used with, but is not supplied with, Aircraft Radio Transmitting Equipments GP and GP-2: one Alternator NEA-1, NEA-1A, or NEA-2 complete with regulator, one 12-volt storage battery, two 600-ohm headsets, one antenna installation, one low-pass switch, and one Aircraft Radio Receiving Equipment RU-2 or RU-3.

RELATION TO SIMILAR EQUIPMENT:

AIRCRAFT RADIO TRANSMITTING EQUIPMENT

**AN/ART-Type
GP, GP-2**

TECHNICAL DESCRIPTION:

Frequency Range: 350 to 9,050 kc in six bands.

Band A: 350 to 800 kc.

Band B: 800 to 1,500 kc.

Band C: 1,500 to 3,000 kc.

Band D: 3,000 to 4,525 kc.

Band E: 4,525 to 6,500 kc.

Band F: 6,500 to 9,050 kc.

Type Emission: cw, mcw, voice.

Pwr Output:

350 to 500 kc:

 cw and mcw: 85 w.

 Voice: 60 w.

500 to 800 kc:

 cw and mcw: 100 w.

 Voice: 75 w.

800 to 1,500 kc:

 cw and mcw: 125 w.

 Voice: 85 w.

3,000 to 9,050 kc:

 cw and mcw: 125 w.

 Voice: 85 w.

Pwr Requirements: 850 ma, 120-v 600- to 800-cycle ac; 0.5 amp at 12-v dc.

Major Units: Transmitter-Rectifier Unit 52051

52 lbs

TUBES, CRYSTALS, TRANSISTORS:

REFERENCE DATA AND LITERATURE:

15 March 1962
Cog Serv: USN FSN:
USA Line Item No:

ANTENNA TUNING GROUP

AN/BRA-6

USA USN USAF USMC

STATUS OR TYPE CLASS.:

Manufacturer: CFT (21964)

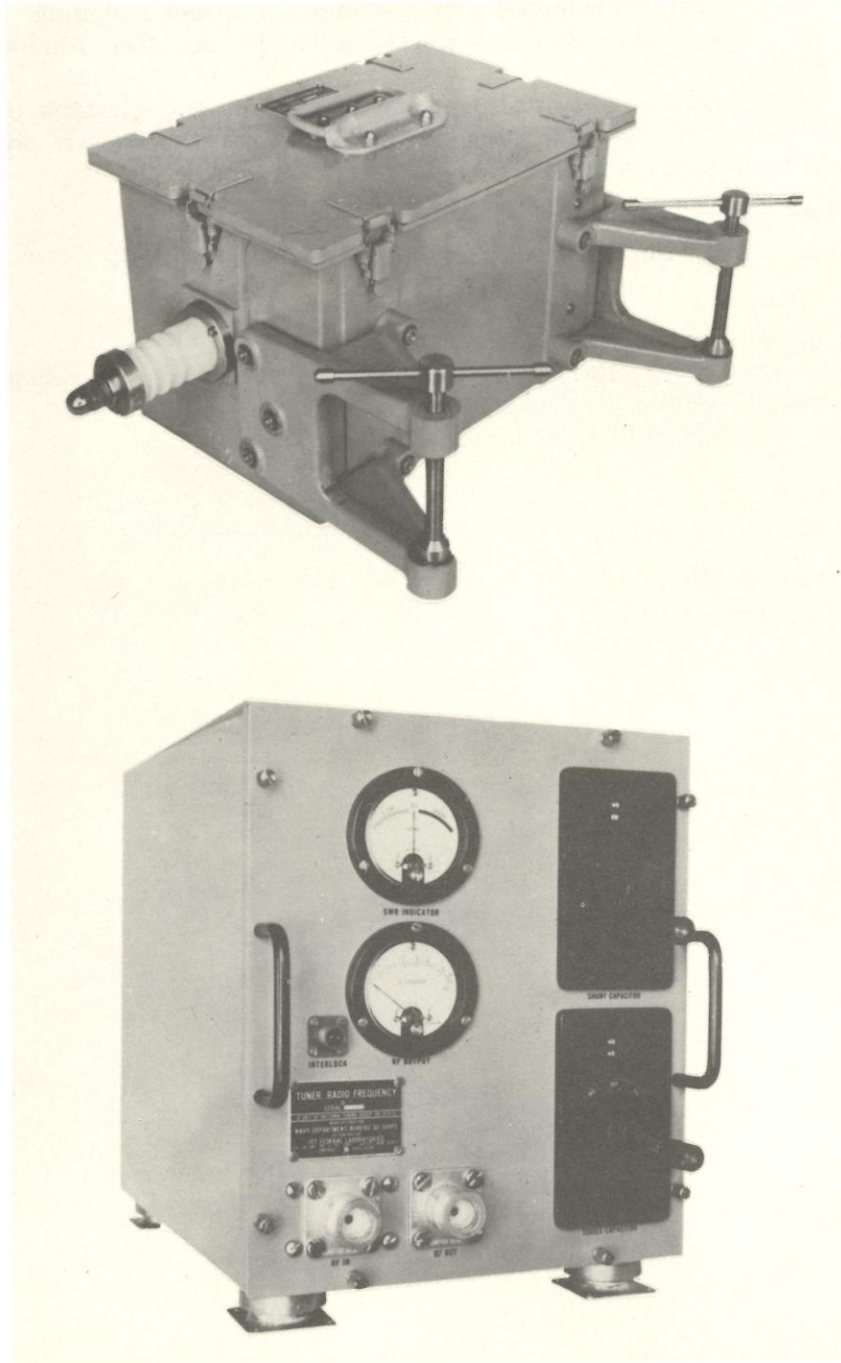

ANTENNA TUNING GROUP

AN/BRA-6**FUNCTIONAL DESCRIPTION:**

Antenna Tuning Group AN/BRA-6, when used with Antenna AT-774A/UR, provides an emergency communications antenna system for submarines. The antenna system operates over a frequency range of 2 to 30 megacycles. The AN/BRA-6 consists of an rf inductor and an rf tuning unit. The rf inductor is enclosed in a housing equipped with C-clamps for topside mounting. Shorting bars are provided to select the proper taps for frequencies between 2 and 6 mc. The rf inductor is not used for frequencies above 6 mc.

The rf tuner unit is composed of two adjustable capacitors and an adjustable inductor to provide continuous manual tuning over the 2- to 30-mc range. Front panel meters are provided to indicate rf output power and standing wave ratio.

RELATION TO SIMILAR EQUIPMENT:

The AN/BRA-6 is used with, but is not part of, Antenna AT-774A/UR.

TECHNICAL DESCRIPTION:

Frequency Range: 2 to 30 mc, continuously tunable.

Pwr Input: Average—500 w; 100 percent modulation—750 w; voice operation, peak envelope—1000 w; cw pulsed—5000 w (3 sec every 3 minutes).

Ambient Temperature Range: 0° C. to 50° C. (32° F. to 122° F.).

Major Units:

TN-341/BRT

15 $\frac{5}{8}$ " x 12 $\frac{1}{2}$ " x 16 $\frac{7}{8}$ ".

RF-91/BRT

10 $\frac{1}{4}$ " x 9 $\frac{1}{16}$ " x 14 $\frac{7}{8}$ ".

TUBES, CRYSTALS, TRANSISTORS:**REFERENCE DATA AND LITERATURE:**

NAVSHIPS 94198.

RADIO SET
AN/CRT-3A

18 November 1958
 Cog Serv: USAF FSN: 5820-571-5166
 USA LINE ITEM NO.: 638300

	USA	USN	USAF
STATUS OR TYPE CLASS:			L/Std

Manufacturer:

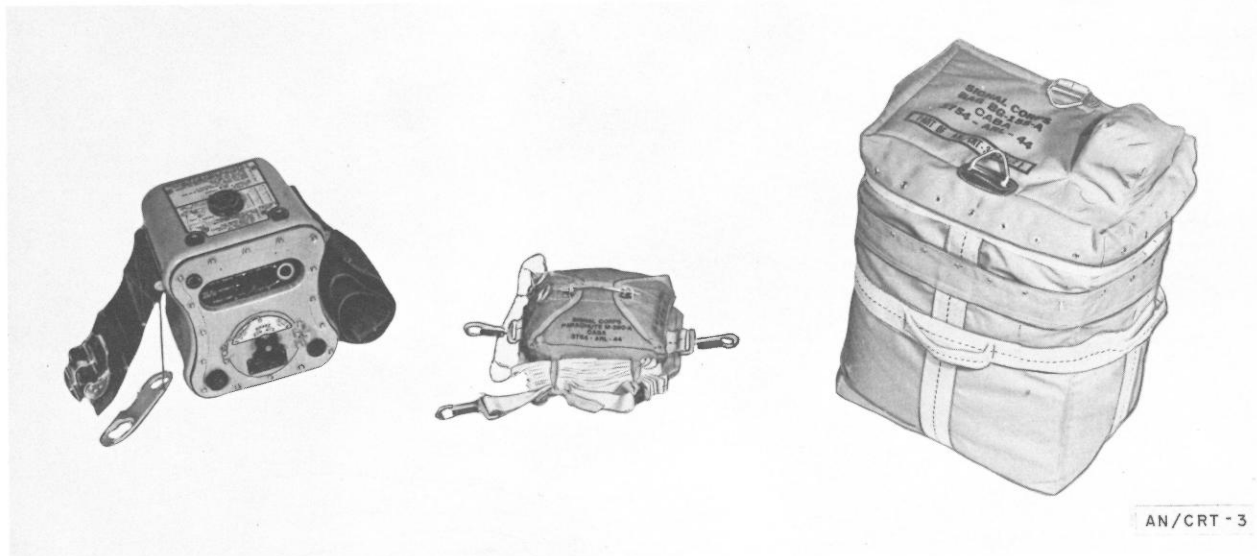

FUNCTIONAL DESCRIPTION:

Radio Set AN/CRT-3A is a hand-powered emergency transmitter designed for sea rescue work for use from raft or life boat by survivors. It is air transportable and dropped by parachute and permits ground-to-air and point-to-point communication.

This equipment is capable of three types of signaling, hand keyed signal light, automatic transmission of SOS on 0.5-megacycle tone-modulated, and SOS on 8.364-megacycles unmodulated, automatically shifting from one frequency to the other every 40 to 50 seconds, and hand keyed, tone-modulated transmissions on .05 megacycle.

One kite and two balloons are supplied to support a single long wire antenna.

All power for operation of the equipment is supplied by a hand cranked generator.

RELATION TO SIMILAR EQUIPMENT:

TECHNICAL DESCRIPTION:

Frequency Range in mc: 0.5 mc; 8.364 mc.

Type Controls: Operating controls are located in an elongated oval depression in the front panel of the transmitter. Controls consist of a three-position selector switch and a pushbutton telegraph key.

Type Modulation: am.

Type Signal: mcw on 0.5 mc with 1,000-cyc; tone; cw only on 8.364 mc.

Pwr Output: 2½ w (approx) on 0.5 mc; 2 w (approx) on 8.364 mc.

Pwr Requirements: Furnished by hand-powered generator in the transmitter cabinet.

Major Units: 10½" x 10" x 9"

16 lbs

RADIO SET

AN/CRT-3A

TUBES, CRYSTALS, TRANSISTORS:

REFERENCE DATA AND LITERATURE:

TO 12R5-2CRT3-2.

MIL-R-8153.

RADIO SET
AN/CRT-5

18 November 1958
Cog Serv: USAF FSN:
USA LINE ITEM NO: 638490

USA USN USAF

STATUS OR TYPE CLASS.:

L/Std

Manufacturer:



AN/CRT-5

RADIO SET

AN/CRT-5

FUNCTIONAL DESCRIPTION:

Radio Set AN/CRT-5 is a portable, short-range transmitter used in airfield traffic control operations or as a standby or supplementary transmitter for ground-to-air and point-to-point communication.

The low frequency operations of this equipment necessitates the application of a long antenna, such as Antenna Assembly AS-326/CRT-5 (350 to 450 feet), at least 20 feet above the ground.

RELATION TO SIMILAR EQUIPMENT:

TECHNICAL CHARACTERISTICS:

Frequency Range in mc: 0.2 to 0.4.

Type Modulation: am.

Type Emission: Voice.

Operational Range: 10 to 15 miles.

Pwr Output: 10 w.

Pwr Requirements: 350 w, 110- to 125-v, 50- to 60-cyc, 1-phase. ac or 144 w (full load), 12 amp at 12-v dc supplied by Vibrator Power Unit PP-203/CRT-5.

Major Units:

T-151/CRT-5

12 $\frac{1}{16}$ in. x 18 $\frac{3}{8}$ in. x 23 $\frac{5}{16}$ in.

140 lbs

TUBES, CRYSTALS, TRANSISTORS:

REFERENCE DATA AND LITERATURE:

TO 16-30CRT5-4

18 November 1958
Cog Serv: USN FSN: 5805-692-6775
USA Line Item No: 681706

TELEGRAPH CARRIER TERMINAL
AN/FCC-3

	USA	USN	USAF
STATUS OR TYPE CLASS:	Std-A		Std

Manufacturer: Radio Frequency Laboratories Inc.

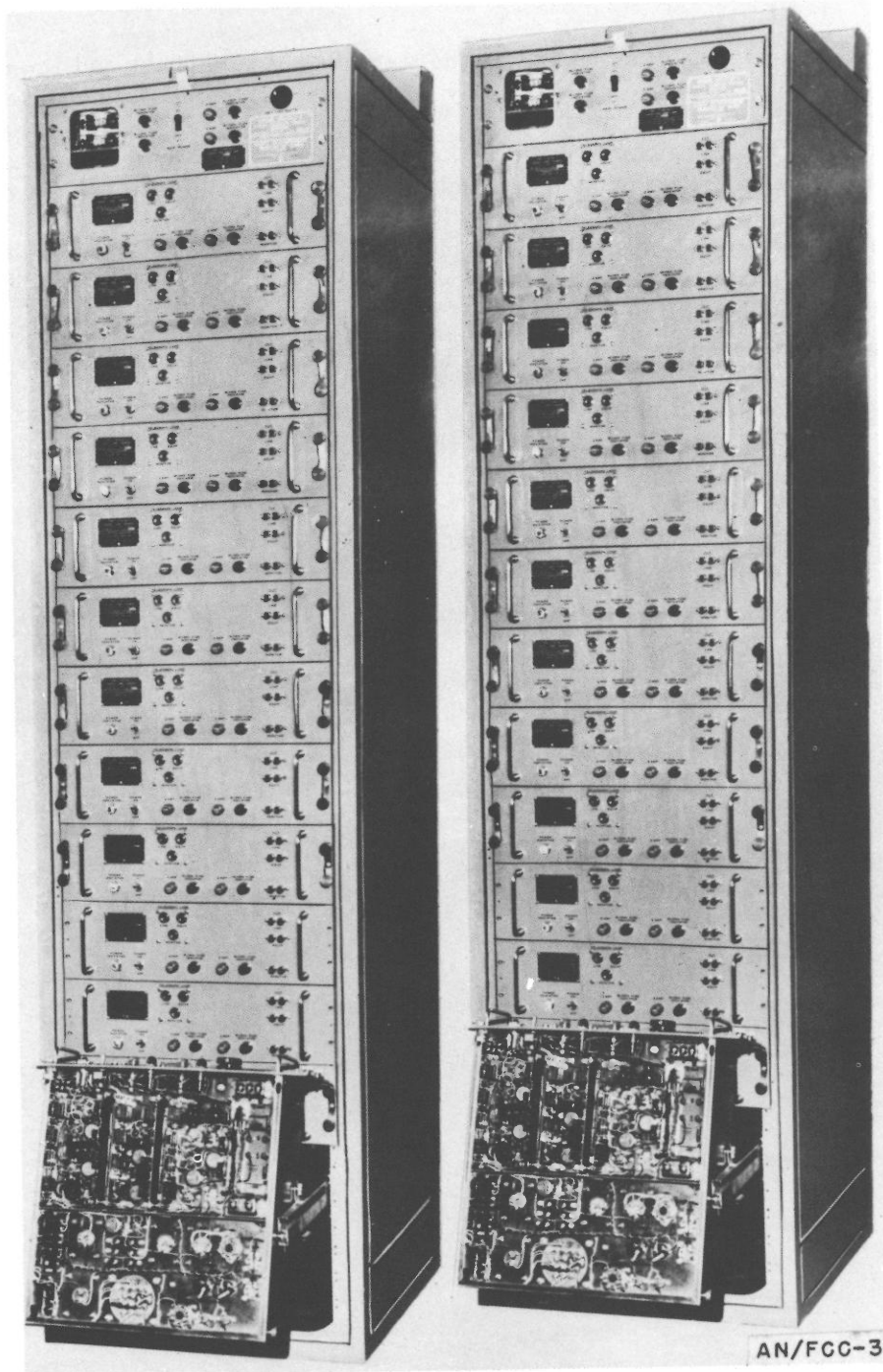

TELEGRAPH CARRIER TERMINAL

AN/FCC-3

FUNCTIONAL DESCRIPTION:

Telegraph Carrier Terminal AN/FCC-3 is a shore-based system providing one-way multichannel telegraph or teletypewriter communications over wire lines or a radio link. It combines eight low-speed channels and four high-speed channels into one voice-frequency carrier signal.

This equipment accepts neutral, polar, or tone input signals and furnishes neutral or polar signal outputs.

It consists of two cabinets, one containing the transmitting equipment and the other containing the receiving equipment. Any two receivers may be operated in frequency diversity to improve the quality of the transmission.

The system can be used for remote controlled keying of continuous wave or voice radio transmitting equipment. Line current for the polar or neutral loops can be supplied either externally or by the equipment.

This equipment is similar to Carrier Telegraph Terminals AN/FCC-7 and AN/FCC-8 except for the number of wide-band receivers and transmitters. In addition, the AN/FCC-3 uses two frequency converters, which the AN/FCC-8 does not include.

RELATION TO SIMILAR EQUIPMENT:

TELEGRAPH CARRIER TERMINAL
AN/FCC-3

TECHNICAL CHARACTERISTICS:

*System:**Frequency:*

Range: 300 to 3,400 cps.

Carrier Signal Frequencies (cps):

Channel	Midband center	Mark	Space	Modulated channels		
				Midband center	Mark	Space
85-cycle frequency shift						
1-----	425	467.5	382.5	2,975	2,932.5	3,017.5
2-----	595	637.5	552.5	2,805	2,762.5	2,847.5
3-----	765	807.5	722.5	2,635	2,592.5	2,677.5
4-----	935	977.5	892.5	2,465	2,422.5	2,507.5
5-----	1,105	1,147.5	1,063.5	2,295	2,252.5	2,337.5
6-----	1,275	1,317.5	1,232.5	2,125	2,082.5	2,167.5
7-----	1,445	1,487.5	1,402.5	1,955	1,912.5	1,997.5
8-----	1,615	1,657.5	1,572.5	1,785	1,742.5	1,827.5
170-cycle frequency shift						
9-----	1,955	2,040	1,870			
10-----	2,380	2,465	2,295			
11-----	2,800	2,890	2,720			
12-----	3,280	3,315	3,145			

Channels: 12 audio telegraph carrier.*Type Modulation:* Frequency shift.*Facilities:* Eight to 40 dot-cyc and four 100 dot-cy channels suitable for polar or neutral telegraph or teletypewriter operation.*Pwr Output (Transmitter Group):* 6 dbm (max) into 600 ohms.*Sensitivity (Receiver Group):* -40 to +6 dbm on a single channel.*Pwr Requirements:*

Receiver Group: 1,645 w, 115- or 230-v 50- to 60-cyc ac.

Transmitter Group: 1,125 w, 115- or 230-v 50- to 60- cy ac.

Telegraph Carrier Transmitter:

Input: 20- or 60-ma neutral telegraph loop with battery supplied by the loop; 30-ma polar telegraph loop with battery supplied from the loop; 20- or 60-ma neutral telegraph loop with battery supplied from the transmitter.

Output: 600-ohm line; audio level is continuously variable over range of -24 dbm to +6 dbm; transmitter operates in parallel with one or more transmitters.

Keying Rate: With narrow-band filters, the maximum keying rate is 40 dot-cyc; with wide-band filters, 100 dot-cyc.

Frequency: MARK and SPACE signals with ± 3 cps of normal values.

Pwr Consumption: 73 w.

TELEGRAPH CARRIER TERMINAL

AN/FCC-3*Telegraph Carrier Receiver:*

Input: 600-ohm line; steady or slow varying audio signal between -40 dbm and +10 dbm at frequency of the receiver filter set used; receiver operates in parallel with one or more receivers.

Output: dc pulses of 20- or 60-ma neutral telegraph loop with battery supplied from either the loop or receiver; 30-ma polar telegraph loop with battery supplied from the receiver.

Keying Rate: with narrow-band filters, the maximum keying rate is 40 dot-cyc; with wide-band filters, 100 dot-cyc.

Frequency: MARK and SPACE frequencies.

Pwr Consumption: 110 w.

Electronic Frequency Converter CV-243/FCC-3:

Input: Two 600-ohm inputs, one for signal to be frequency converted, the other for signal to be combined with the frequency converted signal; normal input level for eight channels into each input is -0.5 dbm. Maximum combined peak signal is 4.3 v at each input. For eight channels into the converted input alone, maximum peak signal input is 5.9 v. For 12 channels with normal input alone, maximum peak signal is 7.3 v.

Output: 600-ohm line ungrounded; equipment gain of 1 for signals from converted and normal input circuits to output; line ATTENUATOR provides from 0- to 40-db attenuation in 2-db steps.

Pwr Consumption: 50 w.

Electronic Frequency Converter CV-244/FCC-3:

Input: 600-ohm line, ungrounded; includes line transformer and ATTENUATOR ranging from 0- to 40-db in 2-db steps; normal input level is 0.5 dbm; maximum combined input peak signal is 8.6 v.

Output: Two 600-ohm outputs; equipment gain of 1 for signals from input to converted and normal output circuits.

Pwr Consumption: 50 w.

Major Units:

1 ea CV-243 and 243/FCC-3

5¼" x 16" x 19".

1 ea R-525 thru 536/FCC-3

5¼" x 16" x 19".

2 ea CY-1196/FCC-3

24" x 24" x 93".

1 ea T-371 thru 382/FCC-3

5¼" x 16" x 19".

TUBES, CRYSTALS, TRANSISTORS:**REFERENCE DATA AND LITERATURE:**

NAVSHIPS 91901.

MIL-T-15294A.

15 March 1962

Cog Serv: USN FSN: AN/FCC-7-5805-644-4755
 AN/FCC-7A-5805-557-5624
 AN/FCC-7B-
 AN/FCC-7C-5805-769-3600

TELEGRAPH CARRIER TERMINAL
AN/FCC-7, 7A, 7B, 7C

USA Line Item No: 681708

USA USN USAF USMC

STATUS OR TYPE CLASS.: Std-A

Manufacturers: AN/FCC-7 CAOR (49673) AN/FCC-7B CMK (39314)
 AN/FCC-7A CQD (80073) AN/FCC-7C CMK (30314)

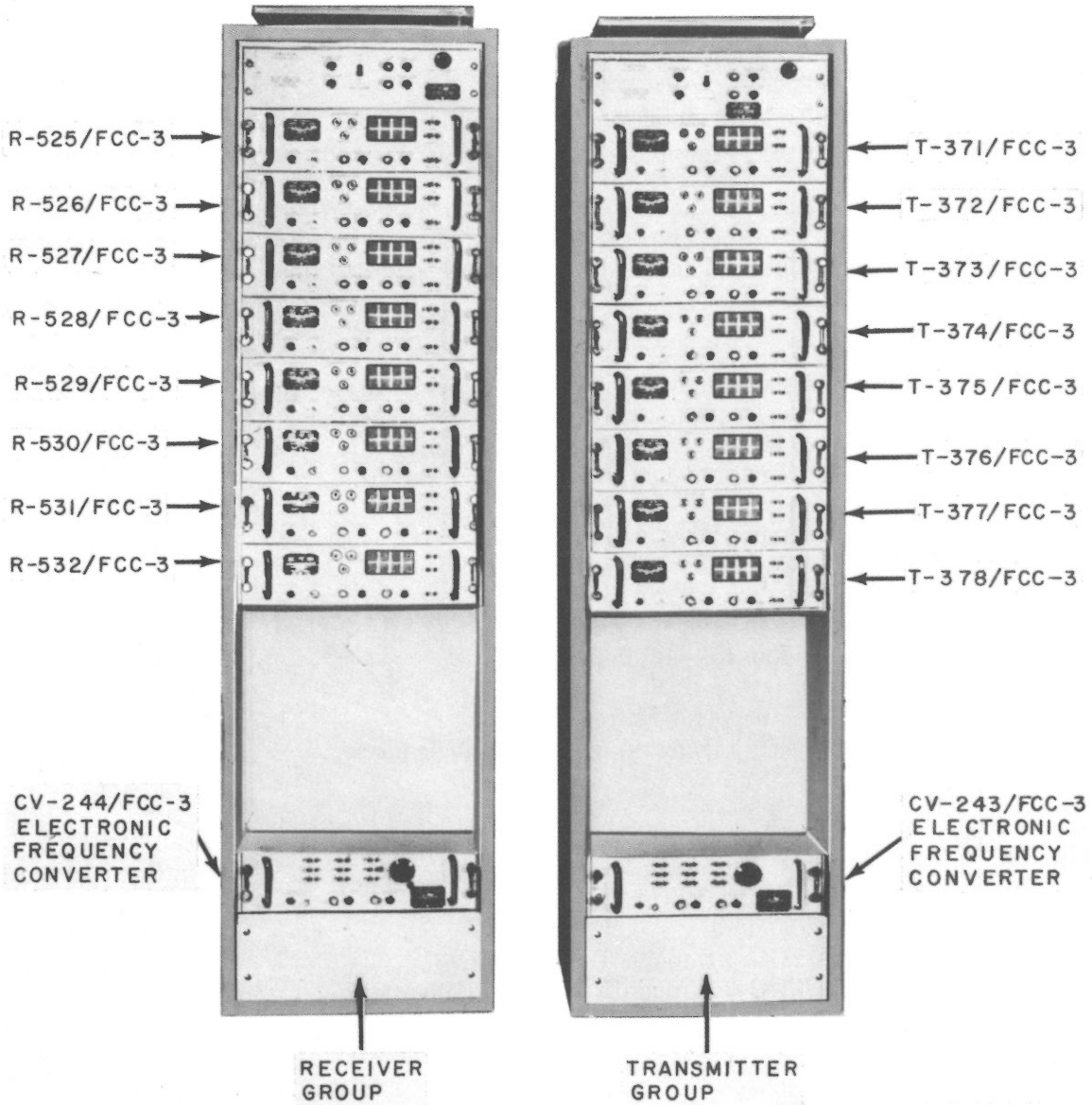

AN/FCC-7,-8

TELEGRAPH CARRIER TERMINAL

AN/FCC-7, 7A, 7B, 7C

FUNCTIONAL DESCRIPTION:

These equipments consist of both transmitting and receiving groups for a multichannel audio frequency telegraph carrier communication system capable of being used on radio circuits or wire lines. In all models except the AN/FCC-7C, the eight channel outputs may be converted to higher frequencies in the frequency converter. These higher frequencies may be transmitted simultaneously with the lower "normal" frequencies when the outputs of two telegraph carrier terminal groups are to be transmitted over one communications link.

The transmitters convert the direct current telegraph MARK and SPACE signals into frequency-shifted audio signals for transmission. The receivers reverse the process, converting the frequency-shifted signals to direct current telegraph signals, for operation of telegraph printers or other telegraph and equipment.

RELATION TO SIMILAR EQUIPMENT:

In all cases, the AN/FCC-7() model is identical to the AN/FCC-3() model except that the four wideband channels have been removed and blank panels have been installed in the cabinet to mask the vacant drawers. AN/FCC-7 and AN/FCC-7A are identical except for manufacturer's parts. AN/FCC-7B is functionally similar to the earlier models, but extensive circuit changes have been made. The AN/FCC-7C is identical to the AN/FCC-7B except that the two frequency converters have been eliminated, an attenuator has been added, and a blank panel is used to fill the unused frequency converter drawer.

TECHNICAL DESCRIPTION:

Number of Channels: These equipments have 8 channels. If two equipments can be operated together, one having the frequency converters, eight more channels are available.

Frequency Range: 382.5 to 1657.5 cps (Normal operation).

1742.5 to 3017.5 cps (frequency conversion).

Transmitter Output:

AN/FCC-7: 6 dbm (max); 600 ohm load.

AN/FCC-7A, 7B, 7C: 10 dbm; 600 ohm load.

Receiver Sensitivity:

AN/FCC-7, 7A: -40 dbm to +6 dbm.

AN/FCC-7B: -40 dbm to -10 dbm.

Keying Rate: 40 dot cps.

Emission and Reception: Frequency-shifted audio.

Operating Pwr Requirements: 115/230 v, 50-60 cps, single phase.

Major Units:

AN/FCC-7:

1 ea	T-371-FCC-3 through T-378/FCC-3	5¼" x 19" x 16".
1 ea	R-525/FCC-3 through R-532/FCC-3	5¼" x 19" x 16".
1 ea.	CV-243 and 244/FCC-3	5¼" x 19" x 16".
2 ea	CY-1195/FCC-3	87½" x 24" x 22¾".
1 ea	T-371A/FCC-3 through T-378A/FCC-3	5¼" x 19" x 16".
	R-525A/FCC-3 through R-532A/FCC-3	5¼" x 19" x 16".

TELEGRAPH CARRIER TERMINAL
AN/FCC-7, 7A, 7B, 7C

1 ea	CV-243A/ and 244A/FCC-3	5 $\frac{1}{4}$ " x 19" x 16".
2 ea	CY-1195A/FCC-3	87 $\frac{1}{2}$ " x 24" x 22 $\frac{3}{8}$ ".
	AN/FCC-7B:	
1 ea	T-371B/FCC-3 through T-378B/FCC-3	5 $\frac{1}{4}$ " x 19" x 16".
1 ea	R-525B/FCC-3 through R-532B/FCC-3	5 $\frac{1}{4}$ " x 19" x 16".
1 ea	CV-243 and 244F/FCC-3	5 $\frac{1}{4}$ " x 19" x 16".
	AN/FCC-7C:	
1 ea	T-371B/FCC-3 through T-378B/FCC-3	5 $\frac{1}{4}$ " x 19" x 16".
1 ea	R-525B/FCC-3 through R-532B/FCC-3	5 $\frac{1}{4}$ " x 19" x 16".
1 ea	CN-609/FCC	5 $\frac{1}{4}$ " x 19" x 16".
1 ea	CY-1195A/FCC-3	87 $\frac{1}{2}$ " x 24" x 22 $\frac{3}{8}$ ".

TUBES, CRYSTALS, TRANSISTORS:**REFERENCE DATA AND LITERATURE:**

NAVSHIPS 91901, NAVSHIPS 93109, NAVSHIPS 93755.

20 November 1958

Cog Serv: USN FSN: 5805-665-1966

USA Line Item No: 681709

	USA	USN	USAF
STATUS OR TYPE CLASS.:	Std-A	Used by	

Manufacturer: Radio Frequency Laboratories, Inc

For Illustration See AN/FCC-7, -8, Page 95

FUNCTIONAL DESCRIPTION:

Telegraph Carrier Terminal AN/FCC-8 consists of both transmitting and receiving groups of terminals for a voice-frequency telegraph carrier communication system. It provides eight channels and may be used on radio circuits and wire units.

This equipment is identical with Telegraph Carrier Terminals AN/FCC-3 and AN/FCC-7 except for the number of wide-band units and the exclusion of the electronic frequency converters in the AN/FCC-8.

RELATION TO SIMILAR EQUIPMENT:**TECHNICAL DESCRIPTION:**

Frequency Range: 425 to 1,615 cps; spaced 170 cps between channels.

Number of Channels: 8 per group.

Pwr Requirements: 115- or 230 v 50- to 60-cyc 1-phase ac.

Major Units:

2 CY-1195/FCC-3	24'' x 24'' x 93''.
1 T-371 thru 378/FCC-3	5¼'' x 16'' x 19''.
1 R-525/FCC-3	5¼'' x 16'' x 19''.

TUBES, CRYSTALS, TRANSISTORS:**REFERENCE DATA AND LITERATURE:**

NAVSHIPS 91901.

TELEGRAPH CARRIER TERMINAL
AN/FCC-16

15 March 1962
Cog Serv: USN FSN: 5805-665-2500
USA Line Item No:

USA USN USAF USMC

STATUS OR TYPE CLASS.:

Manufacturer: CCN (772217) Connecticut Telephone and Electric Co

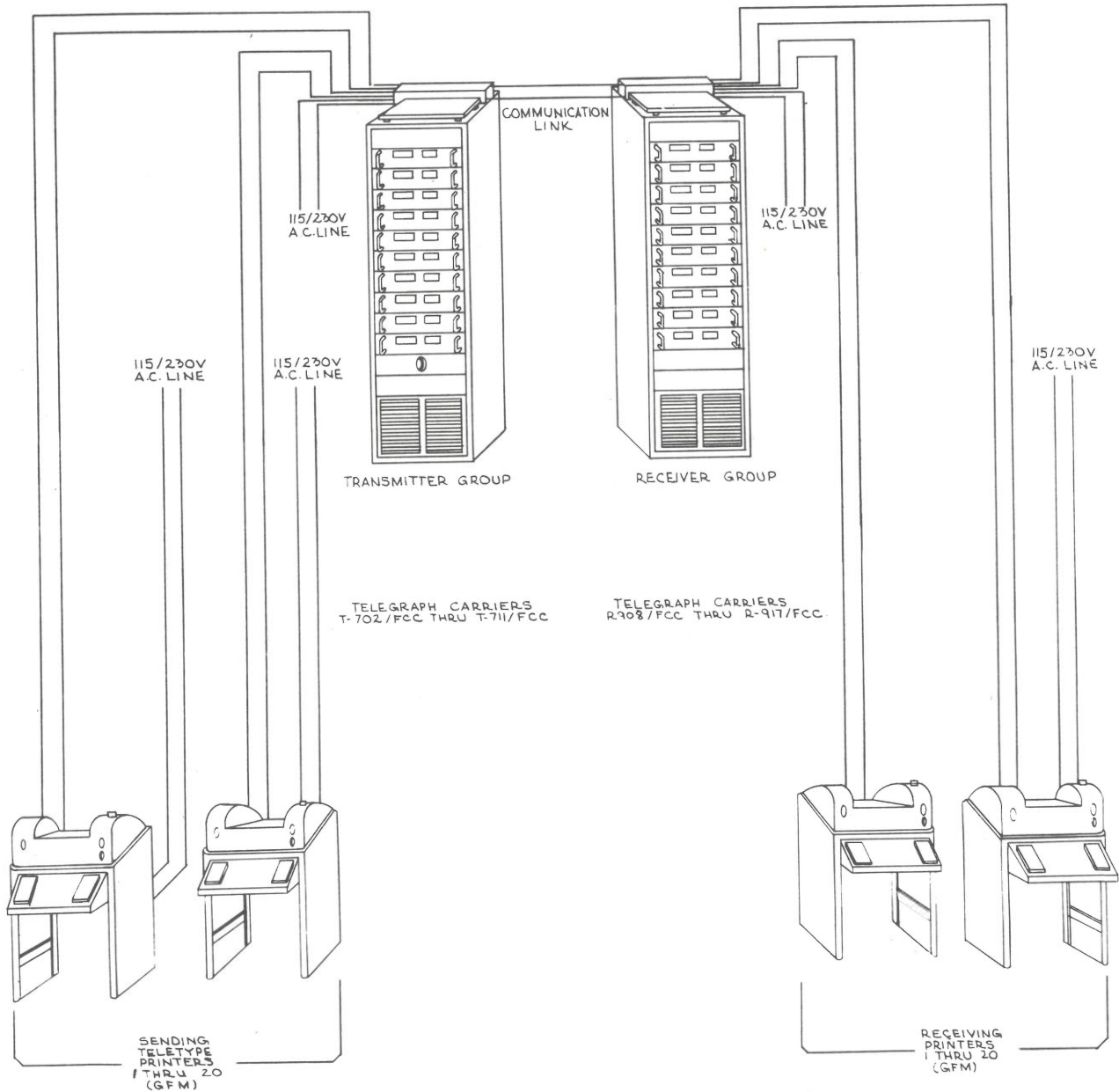

TELEGRAPH CARRIER TERMINAL

AN/FCC-16

FUNCTIONAL DESCRIPTION:

Telegraph Carrier Terminal AN/FCC-16 consists of groups of transmitting and receiving channels which are capable of transmitting and receiving, over radio circuits and wire lines, signals originating in a 12- or 16-channel audio frequency telegraph carrier communication system. Each transmit channel receives dc current pulses (mark and space) from a teletypewriter sending equipment over wire lines and connects them into a frequency shift carrier in the audio frequency range. The frequency shift carrier is then applied as modulation to transmitting equipment in the communication system for radio transmission to other stations. Receiving equipment at the other stations receives the transmitted carrier and applies it to the correct receive channel in the terminal equipment. The receiver channel reconverts the carrier into dc current pulses which are applied to a teletypewriter receiving equipment for display.

RELATION TO SIMILAR EQUIPMENT:

This equipment is functionally similar to AN/FCC-3C and AN/FCC-7C except for number of channels.

TECHNICAL DESCRIPTION:

Pwr Requirements: 115/230 v, 50/60 cps, 1 phase; 1510 w.

Input (to receivers): From 600-ohm line, a steady or slowly varying audio signal between 0 dbm and 6 dbm.

Input (to transmitters): dc pulses from teletypewriter loop; 20 or 30 ma neutral (loop supply); 30 ma polar (loop supply); 20 or 60 ma neutral (transmitter supply).

Output (from receivers): dc pulses to teletypewriter loop; 20 or 60 ma neutral (loop supply); 30 ma polar (receiver supply); 20 or 60 ma neutral (receiver supply).

Output (from transmitters): To 600-ohm line, an audio output level continuously variable between 0 dbm and 6 dbm.

Keying Rate (receiver and transmitter):

Narrow Band: 40 dot cps.

Wide Band: 100 dot cyc.

Channels (receiver and transmitter): 20 (two per transmitter/receiver) 16 narrow band, 4 wide band.

Frequency shift: 85 cps narrow band (± 42.5 cps from center freq) 170 cps wide band (± 85 cps from center freq).

Carrier Signal Frequencies: Narrow Band.

<i>Channel</i>	<i>Frequency</i> (cps)	<i>Channel</i>	<i>Frequency</i> (cps)
1	425	9	1785
2	595	10	1955
3	765	11	2125
4	935	12	2295
5	1105	13	2465
6	1275	14	2635
7	1445	15	2805
8	1615	16	2975

Carrier Signal Frequencies: Wide Band.

<i>Channel</i>	<i>Frequency</i> (cps)
17	1955
18	2380
19	2805
20	3230

Major Units:

1 CY-2526/FCC-16	87½'' x 22¾'' x 19⅞''	400 lbs
1 CY-2501/FCC-16	87½'' x 22¾'' x 19⅞''	400 lbs
1 T-702 thru 711/FCC-16	5¼'' x 19'' x 17⅜''	45 lbs
1 CN-526/FCC	5⅞'' x 19'' x 5⅞''	3 lbs
1 R-908 thru 917/FCC-16	5¼'' x 19'' x 17⅜''	45 lbs

TUBES, CRYSTALS, TRANSISTORS:

REFERENCE DATA AND LITERATURE:

NAVSHIPS 94057.

TELEGRAPH TERMINAL

AN/FCC-Type
TH-1/TCC-1

1 March 1964

Cog Serv: USA FSN: 5805-240-6225

USA Line Item No: 676630

	USA	USN	USAF
STATUS OR TYPE CLASS.:	Obs		

Manufacturer:

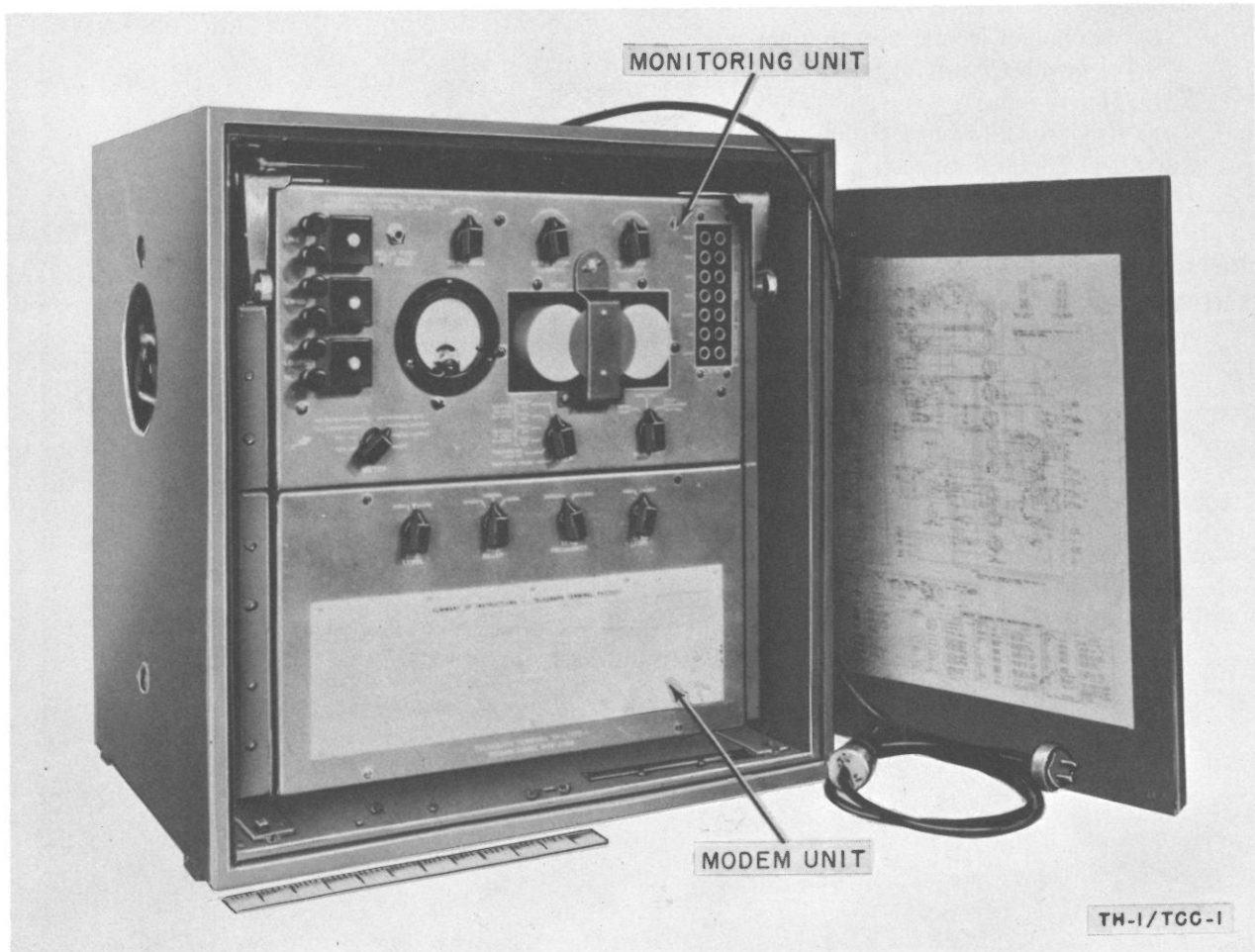
**FUNCTIONAL DESCRIPTION:**

Telegraph Terminal TH-1/TCC-1 is a carrier telegraph terminal equipment that provides two-way voice-frequency telegraph or teletypewriter communication over a portion of the frequency range of a voice-frequency circuit. It is used principally at fixed plant installations.

The telegraph terminal can be used to provide speed-plus-duplex operation in connection with open wire lines, cable, field wire or repeatered lines, or carrier facilities. Filter F-1/GG is required at intermediate points in the telephone circuit to separate telephone and telegraph circuit frequencies.

TELEGRAPH TERMINAL

**AN/FCC-Type
TH-1/TCC-1**

The terminal equipment consists essentially of three panels of operating apparatus. One is a modem unit, one a monitoring unit, and one a voice-frequency ringer panel. The monitoring unit panel is mounted above the modem unit panel in a wooden cabinet. The ringer panel is mounted at the top rear of the cabinet. Replaced by TH-3/TC (AN/TCC-14; Std-A).

RELATION TO SIMILAR EQUIPMENT:

TECHNICAL DESCRIPTION:

Frequency:

Telephone Circuit: 200 to 3,000 cps.

Telegraph Circuit: 1,500 to 2,000 cps.

Type Signal: am.

Type Ringing: 20-cyc vf (1,000- or 500-cyc signals interrupted at 19 cyc).

Facilities Afforded: Speech plus duplex.

Pwr Requirements: 160 w (max), 100-130/200-250-v, 50- to 60-cyc ac; 12.5 amp at 12-v dc.

Major Units: TH-1/TCC-1.

TUBES, CRYSTALS, TRANSISTORS:

REFERENCE DATA AND LITERATURE:

TM 11-2206.

TRANSMITTER DISTRIBUTOR

AN/FGA-Type
TT-25/FG

1 March 1964

Cog Serv: USA FSN: 5815-222-4297

USA Line Item No: 691900

USA USN USAF

STATUS OR TYPE CLASS.:

Std-C

Manufacturer:

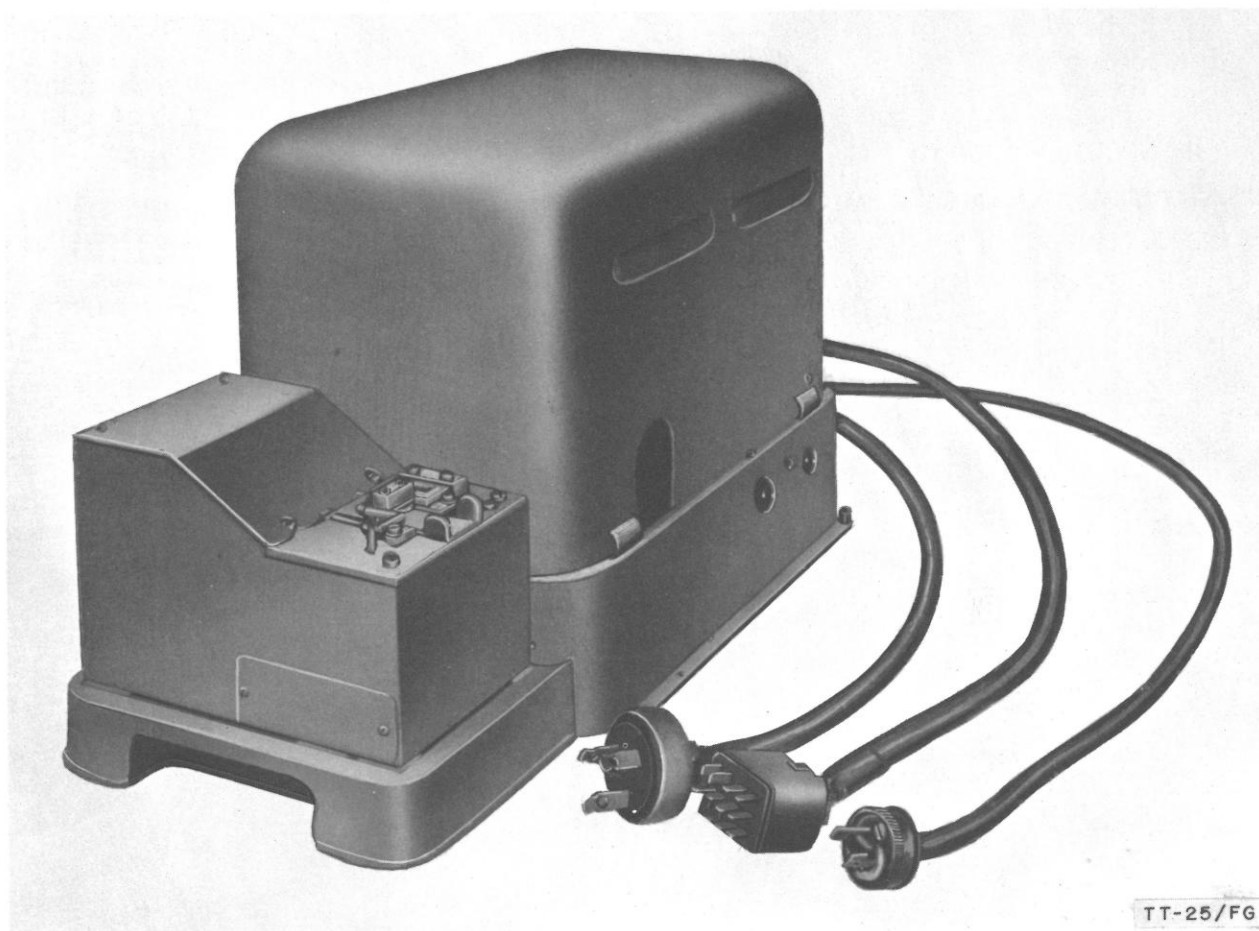
**FUNCTIONAL DESCRIPTION:**

Transmitter Distributor TT-25/FG is an automatic transmitter distributor, called a receiving transmitter distributor, designed for use as part of a code room communication system. The unit translates code combinations from fully perforated or chadless tape into electrical impulses that are set up locally and then are combined with impulses from an external source. The combined signals are used in teletypewriter transmitting and receiving circuits.

The TT-25/FG is a single-channel equipment consisting principally of tape sensing and tape feeding mechanisms, a special distributor commutator, and a motor, all of which are inclosed in a metal housing.

RELATION TO SIMILAR EQUIPMENT:

TRANSMITTER DISTRIBUTOR

**AN/FGA-Type
TT-25/FG**

TECHNICAL DESCRIPTION:

Operating Speed: 308 or 404 rpm.

Type Signaling Code: 5-unit, start-stop.

Type Signals: Neutral.

Type Motor: Synchronous or series-governed.

Motor Speed:

Synchronous: 1,800 rpm.

Series governed: 2,102 or 2,308 rpm.

Pwr Requirements:

Synchronous Motor: 105 to 125-v 50- to 60-cy ac.

Series-governed Motor: 105- to 125-v 25- to 60-cy ac.

Major Unit: TT-25/FG.

TUBES, CRYSTALS, TRANSISTORS:

REFERENCE DATA AND LITERATURE:

TM 11-2222.

RADIOTELETYPE TERMINAL EQUIPMENT

AN/FGC-1 ()

1 March 1964
Cog Serv: USA FSN:
USA Line Item No: 658220

	USA	USN	USAF
STATUS OR TYPE CLASS:			I/Std

Manufacturer: Adler Electronics, Inc

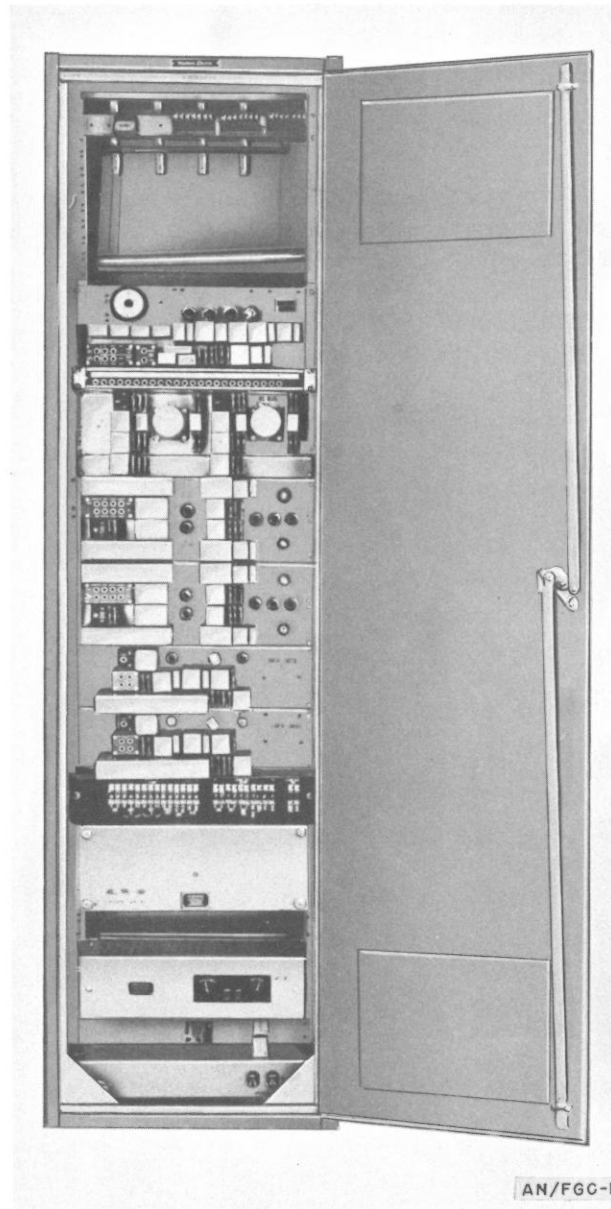

RADIOTELETYPE TERMINAL EQUIPMENT

AN/FGC-1 ()

FUNCTIONAL DESCRIPTION:

Radioteletype Terminal Equipment AN/FGC-1() is an assemblage of control and filtering apparatus designed to translate frequency-shift-keyed teletypewriter signals into dc pulses that will operate a teletypewriter.

This equipment is contained in a steel floor-type cabinet.

The equipment is designed for fixed-plant operation, and contains facilities for disabling the radio receiver during periods of transmission, thus providing either full duplex or one-way reversible operations.

This equipment can be operated in systems using Diversity Receiving Equipment AN/FRR-3 or other suitable fixed-plant receiving equipment.

RELATION TO SIMILAR EQUIPMENT:

TECHNICAL DESCRIPTION:

Input Signal:

Hf Radio: Mark, 2,125-cy tone; space, 2,975-cy tone; transmission speed, 60 wpm.

Lf Radio: Mark, 2,465-cy tone; space, 2,635-cy tone; transmission speed, 60 wpm.

Output Signal: Dc, neutral, or polar.

Pwr Requirements:

AN/FGC-1: 103-127/207-253 w 50/60-cy ac.

AN/FGC-1X: 103-127/207-253 v 25/60-cy ac.

Major Units:

CN-164/FGC-1

CY-1071/FGC-1

C-948/FGC-1

TH-11/FGC-1

AM-591/FGC-1

CV-205/FGC-1

BZ-27/FGC-1

84'' x 17'' x 19 $\frac{5}{8}$ ''.

TUBES, CRYSTALS, TRANSISTORS:

REFERENCE DATA AND LITERATURE:

TM 11-356.

SC-DL-55029.

20 November 1958
 Cog Serv: USAF FSN:
 USA Line Item No: 676565

TELEGRAPH TERMINAL SET
AN/FGC-5

	USA	USN	USAF
STATUS OR TYPE CLASS.:	Std B		A/Std
Manufacturer:	Teletype Corp		

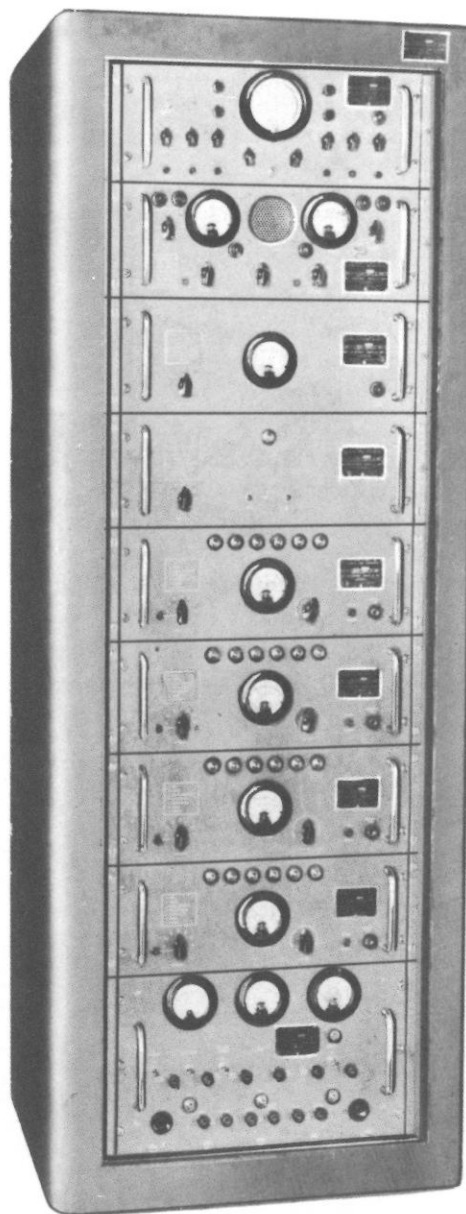
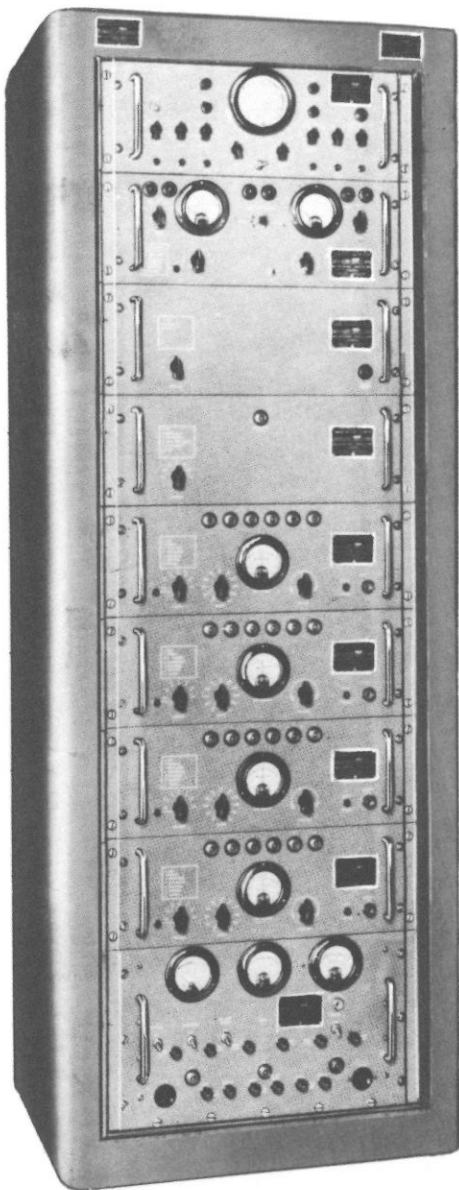

AN/FGC-5

TELEGRAPH TERMINAL SET

AN/FGC-5

FUNCTIONAL DESCRIPTION:

Telegraph Terminal Set AN/FGC-5 is a complete send-receive electronic time-division multiplex unit. It consists of Telegraph Receiving Group OA-150/FGC-5 and Telegraph Transmitting Group OA-151/FGC-5.

This equipment provides two-, three-, or four-channel multiplex teletypewriter operation on a single voice channel on the basis of a time-division system.

All components except the power supply are of a tilt-up drawer type; the power supply slides out horizontally on rails.

The set, as supplied, is for 60 word-per-minute operation but may be modified by a wiring change to 75 word-per-minute operations.

The number of channels in which the set can be operated depends upon the circuit characteristics. Narrow bands or circuits with excessive distortion may limit operation to three, or even two, multiplex channels.

RELATION TO SIMILAR EQUIPMENT:

TECHNICAL CHARACTERISTICS:

Frequency: 101.25 kc.

Frequency Control: Quartz crystal.

Channel Speed: 60 wpm.

Characters Per Line: 72.

Channels: 2, multiplex.

Code: 5 unit.

Oscillator Characteristics:

Frequency Control: Temperature regulated quartz crystal in a modified Colpitts oscillator circuit.

Operating Frequency: 101.25 kc.

Keying Frequency:

60 wpm: 150 cps; 112.5 cps.

75 wpm: 187.5 cps; 140.62 cps.

Frequency Stability: $+0.0001\%$ per degree C., with crystal heater at $-55^{\circ}\text{C.} \pm 1^{\circ}$ ($131^{\circ}\text{F.} \pm 1^{\circ}$).

Transmitting Group Signals:

Output Multiplex Signal: 120-v internal source, variable up to 0.06 amp, + polarity to station ground; 120 v or less external source, variable up to 0.03 amp, + polarity to station ground.

Input Start-stop Signals: On-off dc + or - polarity, 0.06 amp from external battery source.

Receiving Group Signals:

Input Multiplex Signal: On-off dc, 0.06 amp from external source of + or - polarity or from a 115-v internal positive battery source.

Output Start-stop Signals: On-off dc, \pm or - polarity, 0.06 amp, external battery source.

Heat Dissipation:

Transmitting Group: 690 w.

Receiving Group: 690 w.

Pwr Requirements: 690 w, 6.9 amp, 0.86 pf, 115- or 230-v $\pm 10\%$ 50- or 60-cy 1-phase ac.

TELEGRAPH TERMINAL SET

AN/FGC-5*Major Units:*

1 CY-700 and 743/FGC-5	$72\frac{7}{8}'' \times 27'' \times 24\frac{3}{16}''$	405 lbs
4 CV-81 and 94/FGC-5	$6\frac{3}{32}'' \times 17\frac{1}{8}'' \times 19''$	64 lbs
1 C-620 and 621/FGC-5	$6\frac{3}{32}'' \times 17\frac{1}{8}'' \times 19''$	14 lbs
1 O-100 and 101/FGC-5	$6\frac{3}{32}'' \times 17\frac{1}{8}'' \times 19''$	15 lbs
1 TT-58 and 64/FGC-5	$6\frac{3}{32}'' \times 17\frac{1}{8}'' \times 19''$	13 lbs

TUBES, CRYSTALS, TRANSISTORS:**REFERENCE DATA AND LITERATURE:**

NAVSHIPS 91265(a).

TELETYPEWRITER SET

AN/FGC-6

20 November 1958

Cog Serv: USN FSN: 5805-247-9307

USA Line Item No: 680702

USA

USN

USAF

STATUS OR TYPE CLASS.:

Std

Manufacturer: Teletype Corp

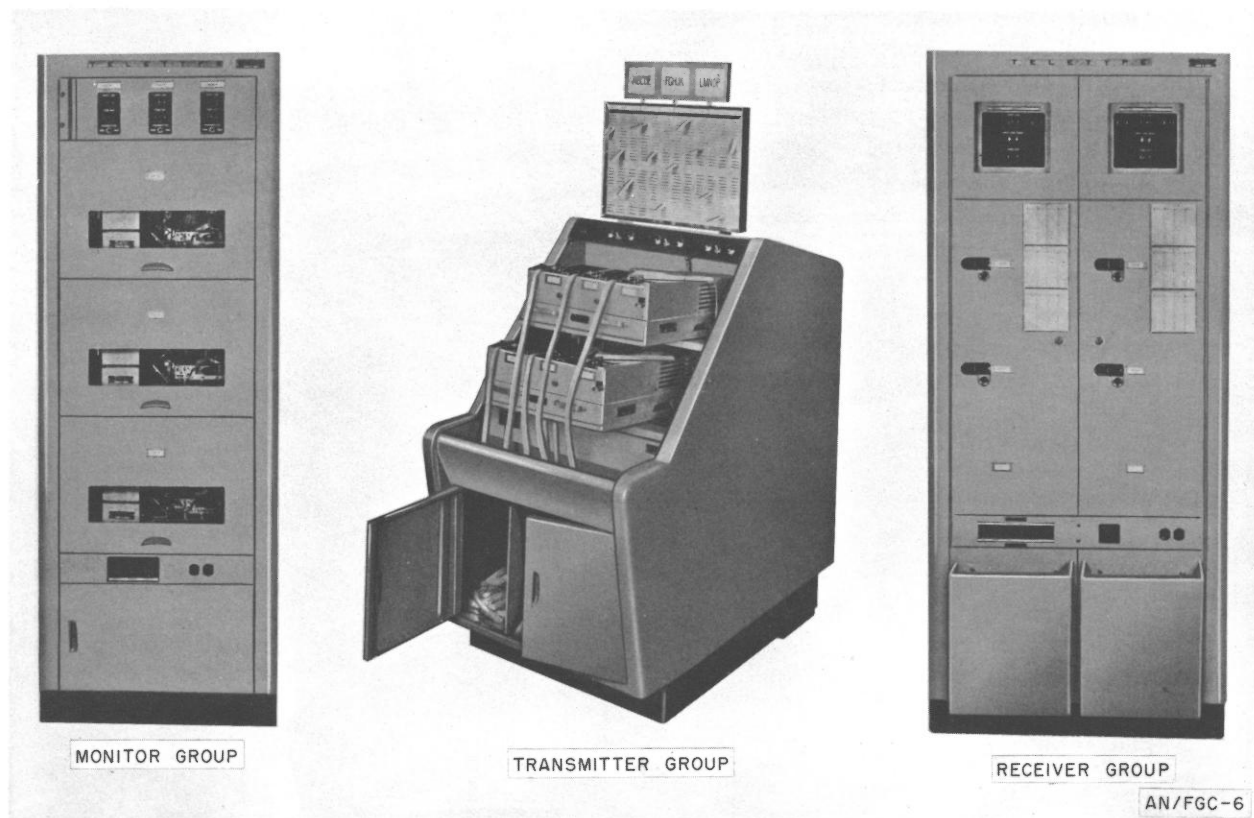
**FUNCTIONAL DESCRIPTION:**

Teletypewriter Set AN/FGC-6 is used at a relay station to receive, transmit, and monitor telegraph messages. It consists essentially of a receiver group, a transmitter group, and a monitor group. A typical station installation may consist of several sets.

The receiver group receives automatic telegraph signals at 60, 75, or 100 (experimental) words per minute from three incoming signal lines and converts the signals to perforated tape. Characters are also typed on the tape.

The transmitter group transmits from perforated tape to three outgoing signal lines at 60, 75, or 100 (experimental) words per minute. Circuits in series with the distributor-transmitters provide monitoring. Each transmitted message is numbered consecutively.

The monitor group receives messages from the transmitter group and records each transmitted message on tape in the same manner as the receiver group. Time and date are stamped every minute on the message tape, which is taken up on a reel for storage.

RELATION TO SIMILAR EQUIPMENT:

TELETYPEWRITER SET

AN/FGC-6

TECHNICAL DESCRIPTION:

Signal Frequency (Maximum Dot-Cycles):

60 wpm: 22.8 cps.

75 wpm: 28.5 cps.

100 wpm: 37.1 cps.

Frequency Control: Depends on use of synchronous motor and regulated 60-cy power supply.

Telegraph Signals (Transmitted or Received):

Neutral: 0.06 amp (nominal).

Polar: 0.03 amp (nominal).

Pwr Factors: 0.3 (approx) for each group.

Pwr Requirements: 10 amp (monitor group), 12 amp (transmitter group), 14 amp (receiver group),
115 v $\pm 10\%$ 60 cy ± 0.5 cy 1-phase ac.

Major Units:

1 OA-519/FGC-6

24'' x 27'' x 77 $\frac{3}{8}$ ''

619 lbs.

1 OA-518/FGC-6

24'' x 33'' x 77 $\frac{3}{8}$ ''

790 lbs.

1 OA-517/FGC-6

27'' x 43'' x 67''

559 lbs.

TUBES, CRYSTALS, TRANSISTORS:

REFERENCE DATA AND LITERATURE:

NAVSHIPS 91899(a)

MIL-T-16280A (Ships).

TELETYPEWRITER REPEATER SET

AN/FGC-7

20 November 1958
Cog Serv: USN FSN:
USA Line Item No: 680620

	USA	USN	USAF
STATUS OR TYPE CLASS.:	Std B	Used By	L/Std

Manufacturer: Meridian Inc.

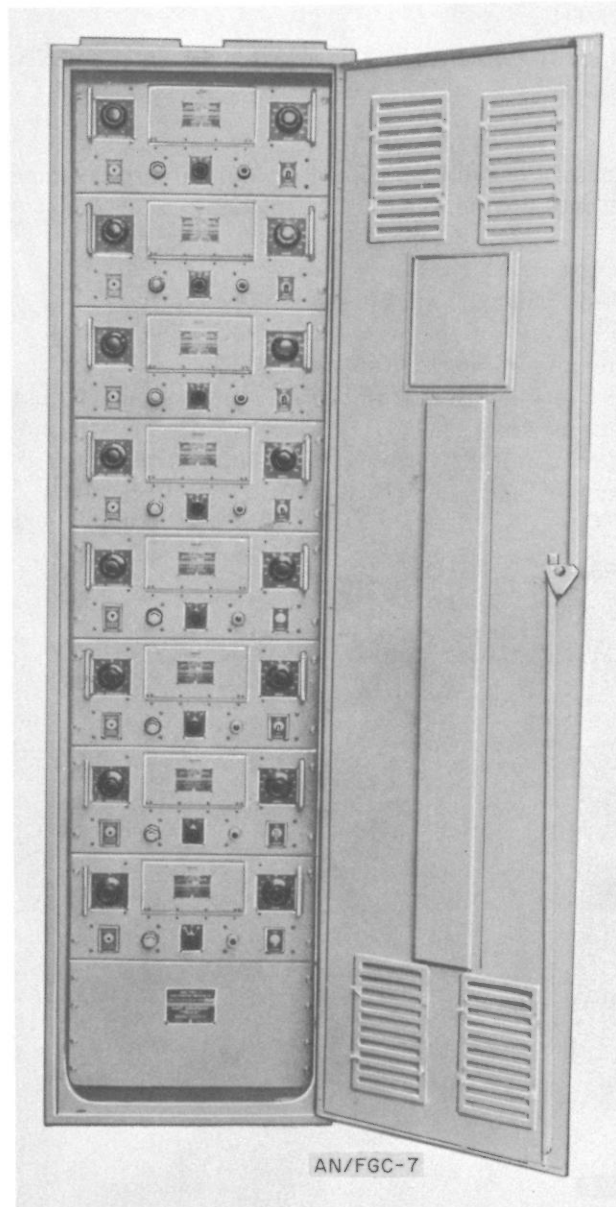

TELETYPEWRITER REPEATER SET

AN/FGC-7

FUNCTIONAL DESCRIPTION:

Teletypewriter Repeater Set AN/TGC-7 is a shore-based electronic regenerative type equipment for use on 60, 75, or 100 word-per-minute long-line teletypewriter wire circuits. It consists of eight teletypewriter repeaters housed in a single cabinet.

This equipment is capable of receiving audio or polar and neutral teletypewriter signals having a maximum bias distortion of 45% and of regenerating the signal with less than 5% bias distortion at the output.

RELATION TO SIMILAR EQUIPMENT:

This equipment is functionally similar to Teletypewriter Repeater Set AN/FGC-7A; both are similar mechanically but not electrically.

TECHNICAL DESCRIPTION:

Operating Facilities: Can handle eight simplexed or four duplexed channels simultaneously.

Operating Speed: 60, 75, or 100 wpm.

Keying Input:

Tone: 500 to 3,600 cps.

Direct Current: 30 ma polar; 60 ma neutral.

Tone Input Level: 20 to 0 db.

Input Distortion: 45% maximum mark or space bias.

Output: Relay contacts in series with a 310-ohm resistor; contacts closed on mark during operation or during any steady input state.

Output Distortion: 5% (maximum).

Pwr Requirements: 85-w (per repeater), 115-v 50- to 60-cy 1-phase ac.

Major Units: TT-63/FGC 87½" x 22¾" x 24"

TUBES, CRYSTALS, TRANSISTORS:

REFERENCE DATA AND LITERATURE:

NAVSHIPS 91247 MIL-T-16264(Ships).

TELETYPEWRITER REPEATER SET
AN/FGC-7A

20 November 1958

Cog Serv: USN FSN: 5805-382-1898

5815-392-7742 (USN)

USA Line Item No:

	USA	USN	USAF
STATUS OR TYPE CLASS.:	Std B		Std

Manufacturer: Stelma Inc

No illustration available

FUNCTIONAL DESCRIPTION:

Teletypewriter Repeater Set AN/FGC-7A is a shore-based electronic regenerative type equipment consisting of eight regenerative teletypewriter repeaters in a standard relay cabinet. These repeaters receive on-off tone or polar and neutral teletypewriter signals having a maximum bias distortion of 45 percent and regenerate the signal with less than 5 percent bias distortion at the output.

Two repeaters may be used to receive a duplex teletypewriter signal, one producing a leading duplex signal regenerated to standard simplex timing, the other producing a lagging duplex signal regenerated to standard simplex timing.

This equipment is used in long-line wire teletypewriter circuits at teletypewriter relay and receiving stations. Provision is made for connection of a monitor teletypewriter.

RELATION TO SIMILAR EQUIPMENT:

Teletypewriter Repeater Set AN/FGC-7A is functionally similar to Teletypewriter Repeater Set AN/FGC-7; both are similar mechanically but not electrically.

TECHNICAL CHARACTERISTICS:

Operating Facilities: Can handle eight simplex or four duplex channels simultaneously.

Operating Speed: 60, 75, or 100 wpm.

Keying Input:

Tone: 500 to 3,600 cps.

Direct Current: 30 ma polar, 60 ma neutral.

Tone Input Level: 20 to 0 dbm.

Input Distortion: 45 percent maximum mark or space bias.

Output: Relay contacts in series with a 310-ohm resistor; contacts closed on mark during operation or during any steady input state.

Output Distortion: 5 percent (maximum).

Pwr Requirements: 85 w, 115 v 50 to 60 cy 1-phase ac.

Major Units: 8 TT-63A/FGC 87½" x 22⅜" x 24" 575 lbs (including eight repeaters).

TUBES, CRYSTALS, TRANSISTORS:**REFERENCE DATA AND LITERATURE:**

NAVSHIPS 91689; TM 11-2247.

TELETYPEWRITER SET
AN/FGC-11

15 March 1962
Cog Serv: USN FSN: 5805-669-7923
USA Line Item No:

USA	USN	USAF	USMC
-----	-----	------	------

STATUS OR TYPE CLASS.:

Manufacturer: CTT (59433)

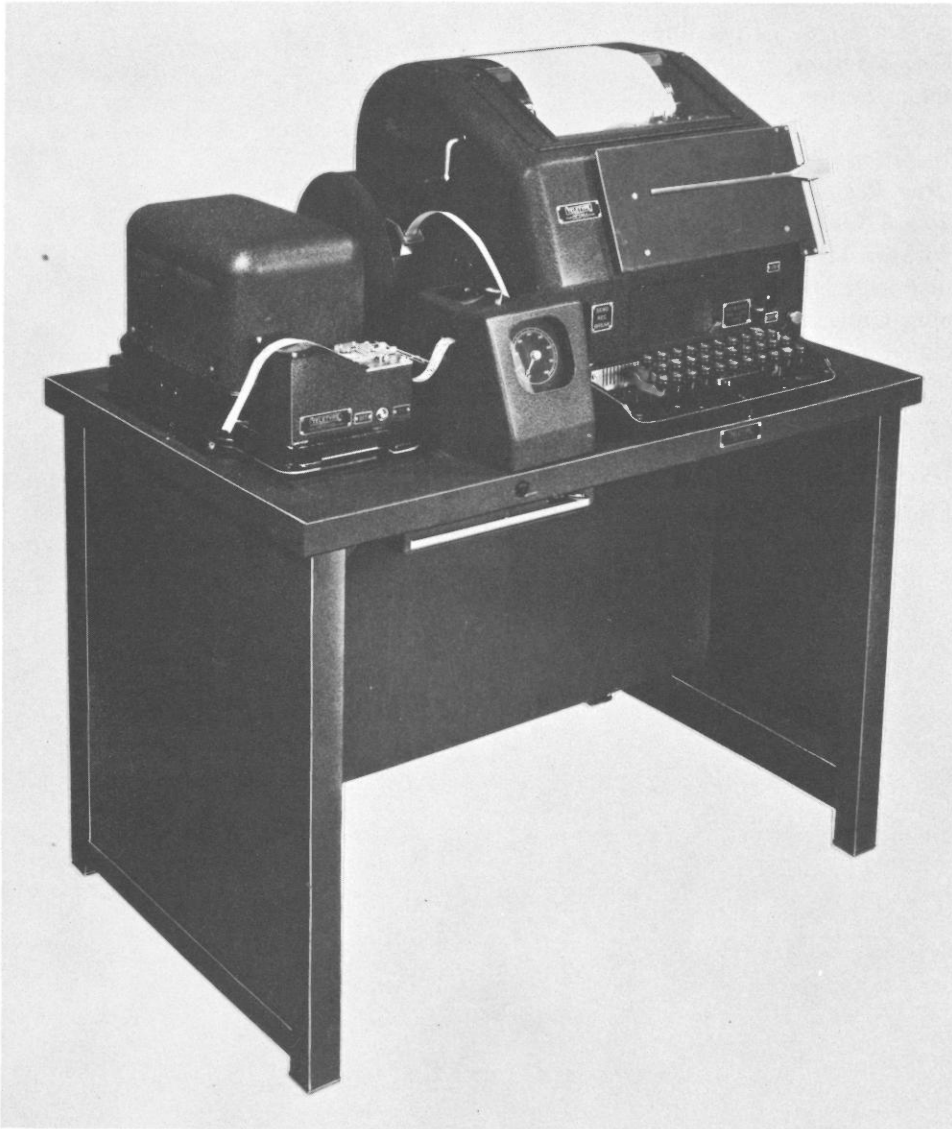

FUNCTIONAL DESCRIPTION:

Teletypewriter Set AN/FGC-11 is used for ship-to-ship and ship-to-shore radioteletype communication. It provides either direct keyboard or tape transmission.

TELETYPEWRITER SET

AN/FGC-11

RELATION TO SIMILAR EQUIPMENT:

The set can communicate with any other five-unit code teletypewriter equipment geared for 368 operations per minute

TECHNICAL DESCRIPTION:

Type of Station: Fixed.

Type of Keyboard: Standard communications.

Type of Characters: English.

Quantity of Characters: 72 per line.

Type of Feed: Friction.

Type of Motor: Series.

Unit Code: 5.

Speed of Operation: 368 operations per minute.

Operating Pwr Requirements: 115 v, 60 cy, single phase.

Major Units: AN/FGC-11 consists of: 23½" x 41½" x 36".

- 1 Perforator Transmitter.
- 1 Transmitter Distributor.
- 1 Typing Unit.
- 1 Table.
- 1 Power Supply PP-315/GGA-1.

TUBES, CRYSTALS, TRANSISTORS:

REFERENCE DATA AND LITERATURE:

NAVSHIPS 91523, Technical Manual for Teletypewriter Set AN/FGC-11.

15 March 1962

Cog Serv: USN FSN: 5815-318-4504

USA Line Item No:

USA	USN	USAF	USMC
-----	-----	------	------

STATUS OR TYPE CLASS:**Manufacturer:** CTT (59433)

No illustration available

FUNCTIONAL DESCRIPTION:

The typing reperforator provides means for automatic reception and sending of telegraph messages in the form of code perforations and corresponding printed characters on tape. It may be arranged for use on ordinary message communication circuits or on weather report circuits. Each code combination received is reperforated onto a tape and a character may be printed for each code combination, with the exception of "space." The transmitter distributor provides means for automatic transmission of printing telegraph messages under control of perforated tape. The typing reperforator transmitter distributor set is commonly used for relaying messages from one circuit to another. The printed characters simplify the tape handling procedures by eliminating the need for reading the code perforations.

RELATION TO SIMILAR EQUIPMENT:

Similar to manufacturer's commercial Model 14.

TECHNICAL DESCRIPTION:*Typing Reperforator:*Tape: $1\frac{1}{16}$ " w.

Perforation: Chadless.

Code: 5 unit.

Motor: Equipped with constant speed (synchronous)—will operate on regulated ac.

Transmitter Distributor:

Motor: Synchronous.

Rectifier:

Input Power:

REC-10 105-125 v, 50-60 cy, single phase.

REC-29 95-125/190-250 v, 25-60 cy, single phase.

Output Power:

REC-10 0.200 amp at 120 vdc.

REC-29 0.200 amp at 120 vdc.

No load dc voltage when new: REC-10 and REC-29—not over 135 v.

Pwr Arrangements: 110 v, 60 cy synchronous motors may be used on 110 v, 60 cy alternating current power supplies and 110 v, 50 cy synchronous motors may be used on 110 v, 50 cy power supplies, unless the frequency varies more than ± 0.75 percent, in which case governed series wound motor units should be used. REC-10 or REC-29 rectifiers may be used at 110 v, 50 or 60 cy, alternating current stations for supplying local dc and line battery supply. The REC-29 rectifier is equipped with multi-voltage, multi-frequency input taps that permit a typing reperforator and transmitter distributor driven by 50-60 cycle series governed motors to be operated on ac power supplies of 95-125/190-250 v, 25/40/50/60 cy.

TYPING REPERFORATOR TRANSMITTER DISTRIBUTOR SET

AN/FGC-12

Major Units:

- 1 Typing Reperforator.
- 1 Transmitter Distributor.
- 1 Metal Table.
- 1 Rectifier.

REC-10 or
REC-29

8'' x 6 $\frac{3}{4}$ '' x 11 $\frac{7}{8}$ ''
8 $\frac{3}{16}$ '' x 9 $\frac{1}{4}$ '' x 12 $\frac{9}{16}$ ''

46 lbs

TUBES, CRYSTALS, TRANSISTORS:

REFERENCE DATA AND LITERATURE:

NAVSHIPS 91241.

TELETYPEWRITER SET
AN/FGC-20()

1 March 1964

Cog Serv: USA FSN: 5815-503-2652

USA Line Item No: 680710

	USA	USN	USAF	USMC
STATUS OR TYPE CLASS.:	Std A		Std	

Manufacturer: Kleinschmidt, Inc.

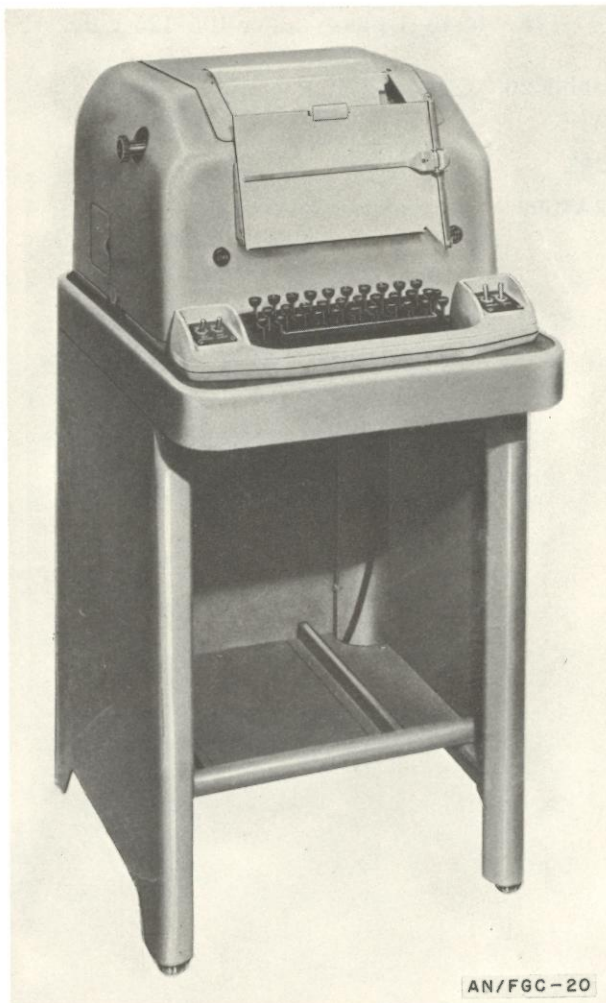
**FUNCTIONAL DESCRIPTION:**

Teletypewriter Set AN/FGC-20() is a page-printing equipment used for the transmission, monitoring, and reception of messages in fixed communication centers.

This set consists essentially of a teletypewriter, table, and power supply.

RELATION TO SIMILAR EQUIPMENT:

This set is similar to Teletypewriter Set AN/FGC-21, except for the keyboard and type pallets.

TELETYPEWRITER SET

AN/FGC-20()

TECHNICAL DESCRIPTION:

Operating Speed: 368.1, 404, or 600 opm (60, 66, or 100 wpm).

Motor Characteristics:

AN/FGC-20: Synchronous.

AN/FGC-20X: Series governed.

Pwr Requirements:

AN/FGC-20: 105-125 v 60-cy 1-phase ac.

AN/FGC-20X: 105-125 v 60-cy 1-phase ac; or 105-125 v dc.

Major Units:

1 Teletypewriter table 20'' x 21'' x 27''.

1 TT-98 or 100/FG 20 $\frac{5}{8}$ '' x 24'' x 13 $\frac{1}{2}$ ''

54 lbs

TUBES, CRYSTALS, TRANSISTORS:

REFERENCE DATA AND LITERATURE:

TM 11-2230.

MIL-T-11749.

TELETYPEWRITER SET
AN/FGC-21()

1 March 1964
 Cog Serv: USA FSN: 5815-503-2653
 USA Line Item No: 680712

	USA	USN	USAF	USMC
STATUS OR TYPE CLASS.:	Std A		Std	

Manufacturer: Kleinschmidt, Inc.

No illustration available.

FUNCTIONAL DESCRIPTION:

Teletypewriter Set AN/FGC-21() is a page-printing equipment used for the transmission, monitoring, and reception of weather information in fixed weather communication stations.

This equipment is the same as Teletypewriter Set AN/FGC-20, except that it is equipped with a weather keyboard and type pallets.

It consists essentially of a teletypewriter, table, and power supply.

RELATION TO SIMILAR EQUIPMENT:

TECHNICAL DESCRIPTION:

Operating Speed: 368.1, 404, or 600 opm (60, 66, or 100 wpm).

Motor Characteristics:

AN/FGC-21: Synchronous.

AN/FGC-21X: Series governed.

Pwr Requirements:

AN/FGC-21: 105-125-v 60-cy 1-phase ac.

AN/FGC-21X: 105-125-v 60-cy 1-phase ac; or 105-125-v dc.

Major Units:

1 Teletypewriter table

20'' x 21'' x 27''

7 lbs

1 TT-97 or 99/FG

20%'' x 24'' x 13½''

54 lbs

TUBES, CRYSTALS, TRANSISTORS:

REFERENCE DATA AND LITERATURE:

TM 11-2230.

MIL-T-11749B.

TELETYPEWRITER SET
AN/FGC-25()

1 March 1964
 Cog Serv: USA FSN: 5815-503-3316
 USA Line Item No: 680715

	USA	USN	USAF	USMC
STATUS OR TYPE CLASS.:	Std A		L/Std	

Manufacturer: Kleinschmidt, Inc.

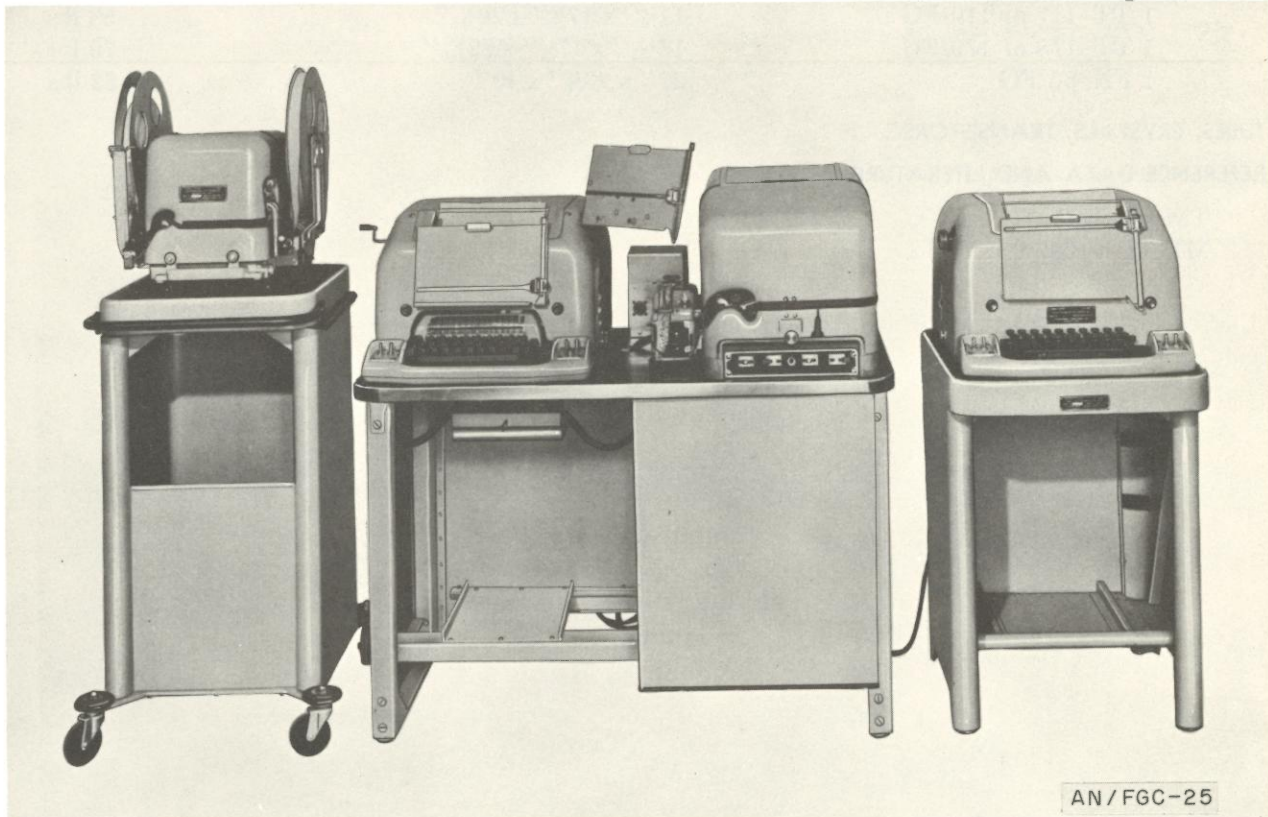

FUNCTIONAL DESCRIPTION:

Teletypewriter Set AN/FGC-25(), a typical installation of which is shown above, is a fixed-station equipment used for transmitting, receiving, or monitoring.

This equipment includes a teleprinter, a perforator having a transmitter distributor, and power and accessory components. A patch panel provides for the selection of a variety of operating circuit arrangements.

This equipment may be operated on a half- or full-duplex basis. It can produce printed page copy and/or perforated-and-printed tape of messages transmitted or received, or it can transmit from such tape.

The AN/FGC-25 has a synchronous motor; the AN/FGC-25X, a series-governed motor.

RELATION TO SIMILAR EQUIPMENT:

TECHNICAL DESCRIPTION:

Operating Speed: 368.1, 404, 460, or 600 opm (60, 66, 75, or 100 wpm).

TELETYPEWRITER SET

AN/FGC-25()

Motor Characteristics:

AN/FGC-25: Synchronous.

AN/FGC-25X: Series-governed.

Power Requirements:

AN/FGC-25: 105-125-v 50/60-cy 1-phase ac.

AN/FGC-25X: 105-125-v 50/60-cy (regulated or unregulated) 1-phase ac.

Major Units:

1 TT-117 or 119/FG

11 $\frac{1}{4}$ " x 17 $\frac{1}{8}$ " x 20 $\frac{1}{16}$ "

58 lbs

1 TT-178 or 179/FG

13 $\frac{3}{2}$ " x 17 $\frac{1}{8}$ " x 22 $\frac{1}{16}$ "

79 lbs

1 FN-65/FG

27" x 23 $\frac{1}{2}$ " x 40"

52 lbs

TUBES, CRYSTALS, TRANSISTORS:

REFERENCE DATA AND LITERATURE:

TM 11-2246.

MIL-T-11997A.

TELEGRAPH TERMINAL
AN/FGC-29

1 March 1964
 Cog Serv: USA FSN: 5805-338-4450
 USA Line Item No: 681692

	USA	USN	USAF	USMC
STATUS OR TYPE CLASS.:	Std B		A/Std	
Manufacturer: Western Union Telegraph Co.				

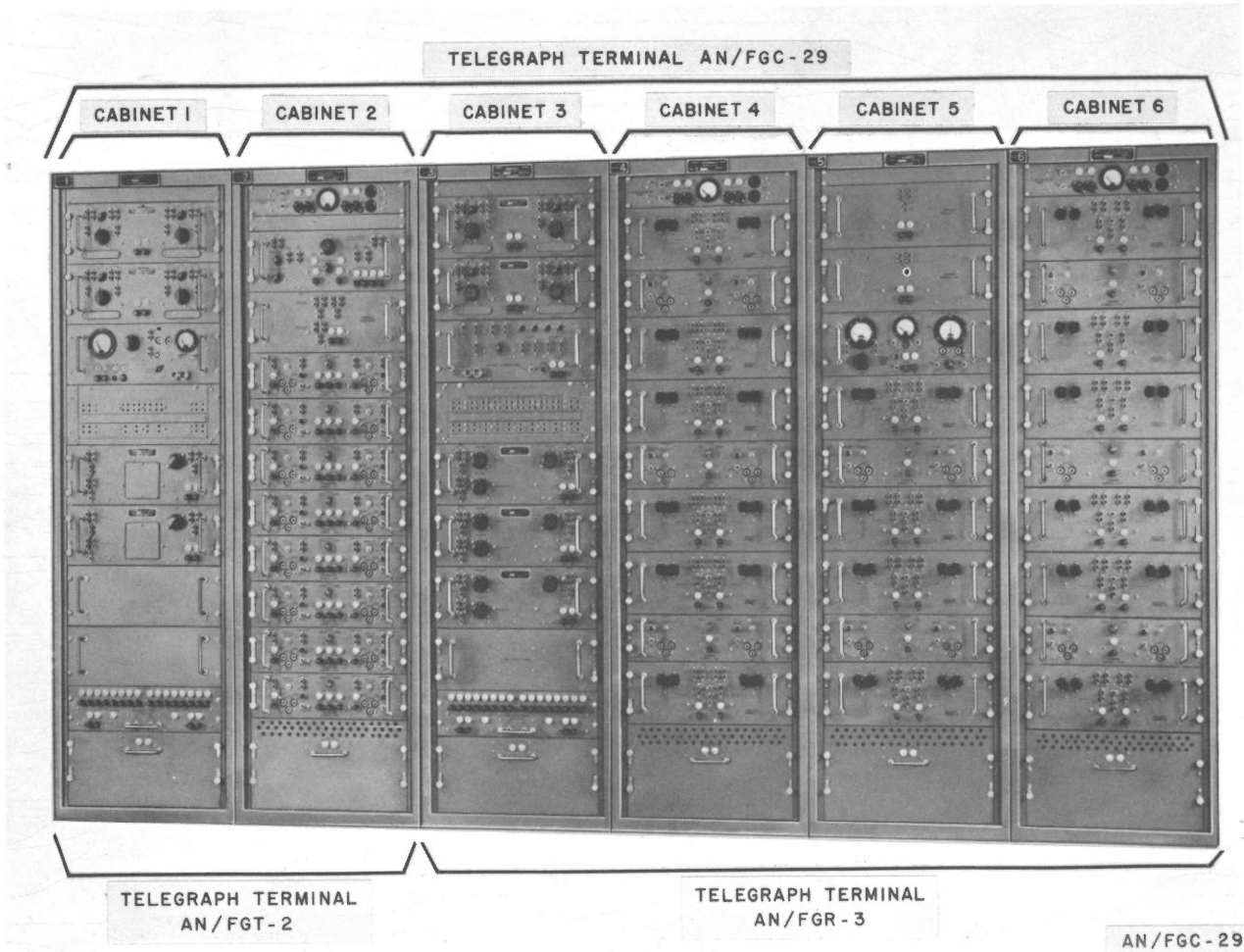

FUNCTIONAL DESCRIPTION:

Telegraph Terminal AN/FGC-29 is the fixed-plant terminal equipment for a 16-channel carrier telegraph system that provides communication over long-range, twin-channel single-sideband radio circuits operating in the hf band.

Facilities are provided for both two-channel and four-channel diversity combining to overcome the effects of radio fading.

The available radio bandwidth of 200 to 6,000 cps is divided by this equipment into two circuits, each with a nominal bandwidth of 375 to 3,025 cps. Thus, various combinations of teletypewriter, voice, and/or facsimile facilities are available through this terminal equipment.

TELEGRAPH TERMINAL

AN/FGC-29

Equalizer and amplifier equipment are also provided to permit operation of the terminal over wire line facilities to remote radio stations.

RELATION TO SIMILAR EQUIPMENT:

TECHNICAL DESCRIPTION:

Operating Speed of Teletypewriter Channels (Maximum): 100 wpm.

Pwr Requirements: 4,000 w, 107-122/210-250 v 50/60-cy ac.

Major Units:

1 AN/FGR-3

75'' x 22½'' x 72''

2518 lbs

1 AN/FGT-2

75'' x 22½'' x 72''

2355 lbs

TUBES, CRYSTALS, TRANSISTORS:

REFERENCE DATA AND LITERATURE:

TM 11-2245.

MIL-T-11958.

TELETYPEWRITER SET
AN/FGC-38(), -39

1 July 1958

Cog Serv: USN FSN: 5815-523-8639; 5815-523-8640

USA Line Item No: 680718; 680719

	USA	USN	USAF	USMC
STATUS OR TYPE CLASS.:	Std B (-38())	Std	Std, L/Std	

Manufacturer: Teletype Corp.

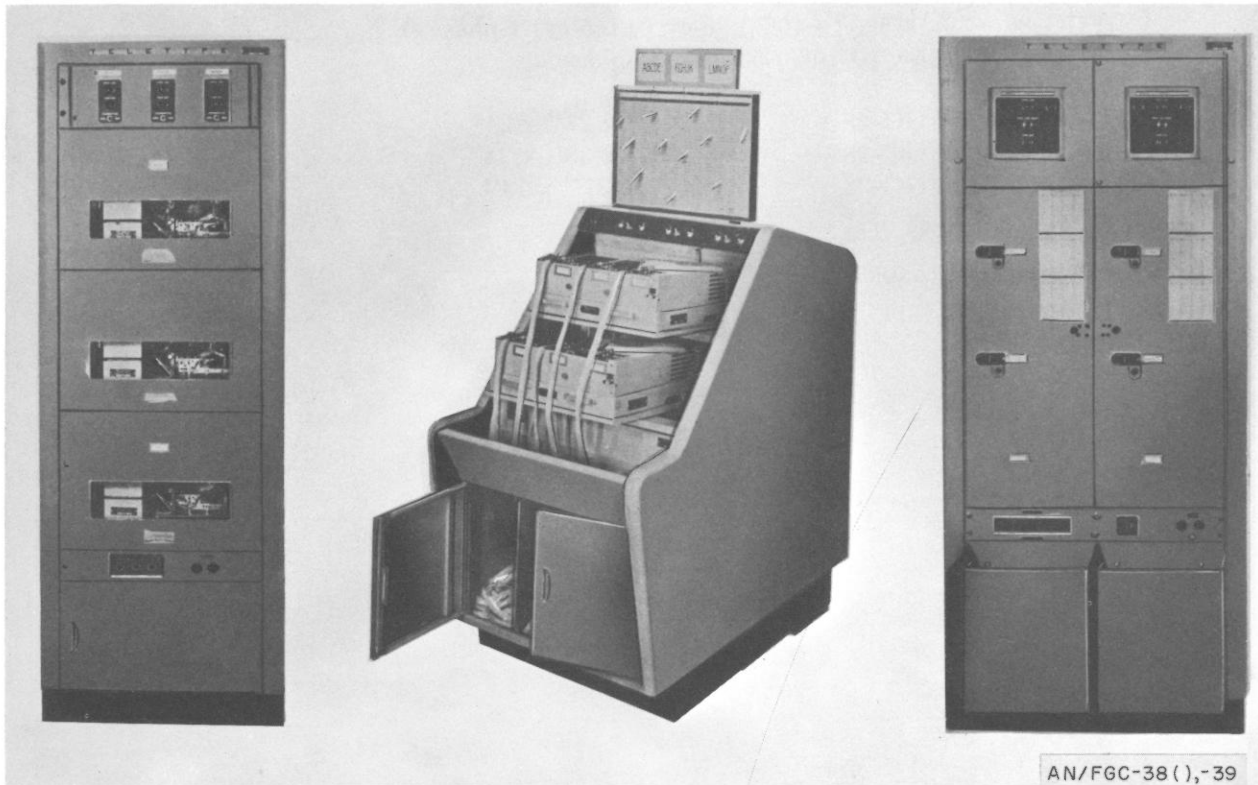
**FUNCTIONAL DESCRIPTION:**

Teletypewriter Set AN/FGC-38() or AN/FGC-39 is used at relay stations ashore to receive, transmit, and monitor telegraph messages.

This equipment consists of three groups: transmitter, receiver, and monitor.

The AN/FGC-38 uses the 7.42 unit code and synchronous motors for all units; the AN/FGC-38X, the 7.42 unit code and series-governed motors; and the AN/FGC-39, the 7.00 unit code and synchronous motors.

Operating Functions: Transmits automatic teletypewriter signals from punched tape; receives automatic teletypewriter signals, producing typed and punched tape.

RELATION TO SIMILAR EQUIPMENT:

TELETYPEWRITER SET

AN/FGC-38(), -39

TECHNICAL DESCRIPTION:

Operating Speed:

AN/FGC-38, -38X: 60, 75, or 100 wpm.

AN/FGC-39: 60 wpm.

Motor Types:

AN/FGC-38, -39: Synchronous.

AN/FGC-38X: Series-governed.

Power Requirements:

AN/FGC-38, -39: 115-v ($\pm 10\%$) 60-cy (± 0.5 cy) 1-phase ac.

AN/FGC-38X: 115-v ($\pm 10\%$) 50-70-cy 1-phase ac.

Major Units:

1 OA-617 or 620/FGC-38	77 $\frac{3}{8}$ " x 27" x 24"	420 lbs
1 OA-616 or 619/FGC-38	77 $\frac{3}{8}$ " x 33" x 24"	505 lbs
1 OA-615 or 618/FGC-38	67" x 27" x 43"	484 lbs

TUBES, CRYSTALS, TRANSISTORS:

REFERENCE DATA AND LITERATURE:

NAVSHIPS 92378, TM 11-2248.

MIL-T-16280.

15 March 1962
 Cog Serv: USN FSN:
 USA Line Item No: 681698

TERMINAL TELEGRAPH
AN/FGG-60(V)

	USA	USN	USAF	USMC
STATUS OR TYPE CLASS.:	Std A	Std		

Manufacturer: Tele-Signal Corporation

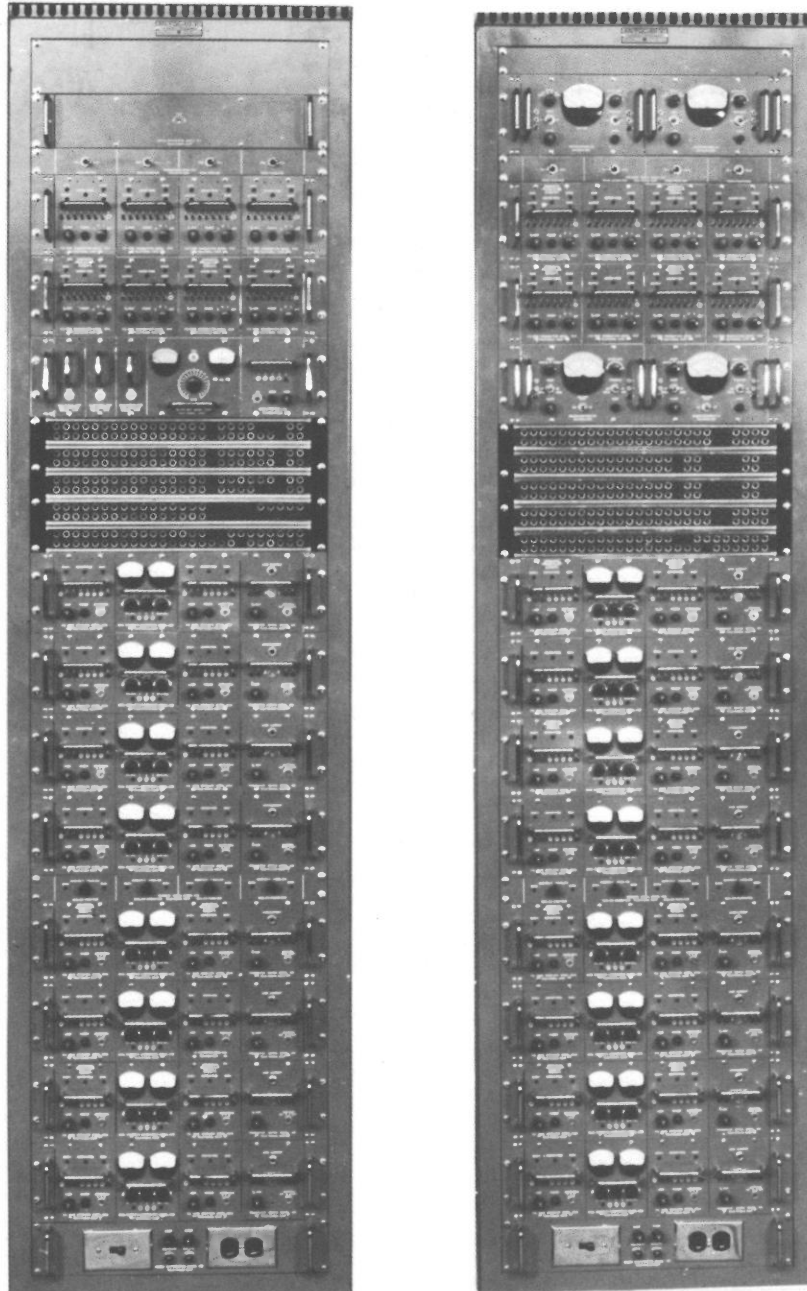

TERMINAL TELEGRAPH

AN/FGG-60(V)

FUNCTIONAL DESCRIPTION:

The Telegraph Terminal is used for long distance communication links. The system provides for the transmission and reception of 16 independent telegraph channels, which are simultaneously conveyed over one audio circuit. There are also provisions for multiplexing and demultiplexing two audio channels.

Terminals are available in up to 16 channel diversity (dual/quadruple) configuration (illustrated above). Also available in non-diversity configuration with channel capability up to 22 send/receive channels.

*16 supplied in nondiversity configuration.

**not supplied nondiversity configuration.

RELATION TO SIMILAR EQUIPMENT:

TECHNICAL DESCRIPTION:

Multiplexing data:

Type: Frequency division.

Quantity: 16 channels.

Frequency range: 425 to 2975 cps.

Spacing between channels: 170 cy.

Operational speed: 100 wpm.

Type of line termination: 4 wire line.

Loop Data: Actuated, Full duplex operation, Neutral operation, Polar operation, Switch type selection.

Operating power requirements: AC, 115/230VAC, 50/60 cps, single phase.

Overall dimensions: 2 Cabinets, each 84 in. high by 22 in. wide by 24 in. deep.

Special features: 16 Frequency Shift Keyers.

*32 Frequency Shift Converters.

16 Electronic Switches.

**16 Signal Comparators.

2 Power Distribution Panels.

3 Audio Frequency Amplifiers.

1 Meter Panel.

1 Power Supply.

2 Multiplexers.

2 Demultiplexers.

1 Signal Distribution Panel.

**2 Channel Selector Signal Distribution Panel.

2 Patch Fields 2000J (5).

1 Shelf wired and harnessed for 2 multiplexers.

1 Shelf wired and harnessed for 2 demultiplexers.

TERMINAL TELEGRAPH
AN/FGG-60(V)

Major Units:

2 AN/FGC-60(V)

34 $\frac{3}{4}$ " x 30 $\frac{3}{4}$ " x 91"

824 lbs

Diversity:

1 SB-1179/UGC

16 KY-346(P)/UGC

32 CV-972(P)/UGC

16 SA-733/UGC

16 CM-185/UGC

2 SB-1177/UGC

2 CY-2965/U

3 AM-2731/UGC

1 PP-2713/UGC

2 TD-410/UGC

2 TD-411/UGC

2 SB-1180/UGC

Nondiversity:

1 SB-1179/UGC

16 KY-346(P)/UGC

16 CV-972(P)/UGC

16 SA-733/UGC

1 SB-1177/UGC

1 CY-2965/U

3 AM-2731/UGC

1 PP-2713/UGC

2 TD-410/UGC

2 TD-411/UGC

TUBES, CRYSTALS, TRANSISTORS:**REFERENCE AND DATA LITERATURE:**

AN/FGC-60(V) Instruction Manual—NAVSHIPS 93841.

TELEGRAPH SWITCHBOARD

AN/FGC-type
SB-65()/FGC

1 March 1964

Cog Serv: USA FSN: 5805-242-5974

USA Line Item No: 671740

	USA	USN	USAF	USMC
STATUS OR TYPE CLASS.:	Std A		Std	

Manufacturer:**FUNCTIONAL DESCRIPTION:**

Telegraph Switchboard SB-65()/FGC is a cord and jack patching switchboard for interconnecting loops, extensions, and teletypewriter sets.

Provision is made in the switchboard for connection of a telephone set for control purposes, and also for connection of a telegraph key and a telegraph sounder for transmitting and receiving tests and for emergency operation. It is equipped with a milliammeter which furnishes a means of making simple tests of line facilities.

The switchboard is mounted on top of a special storage cabinet and writing desk combination. A rack is included in this storage cabinet to hold the patchcords not in use.

On the face of the switchboard, each group of five jacks (vertical grouping) provides for permanent (normal-through) connection of two teletypewriter sets to two separate lines; one miscellaneous jack is also included. There are 30 such groups in each of four identical jack panel sections.

RELATION TO SIMILAR EQUIPMENT:**TECHNICAL DESCRIPTION:**

Number of Switchboard Positions: 1.

Number and Type of Circuits: 120 full-duplex loops, plus 120 miscellaneous jacks (two of which are required for testing purposes).

Pwr Requirements: None.

Major Units: 1 Cabinet-(4 Jack panel sections) 1 Milli-ammeter w/panel: 30 Patch Cord (3 feet); 30 Patch Cord (4 feet); 26¼" x 17½" x 84" 510 lbs

TUBES, CRYSTALS, TRANSISTORS:**REFERENCE DATA AND LITERATURE:**

TM 11-2227.

TELEGRAPH SWITCHBOARD

AN/FGC-type
SB-65()/FGC

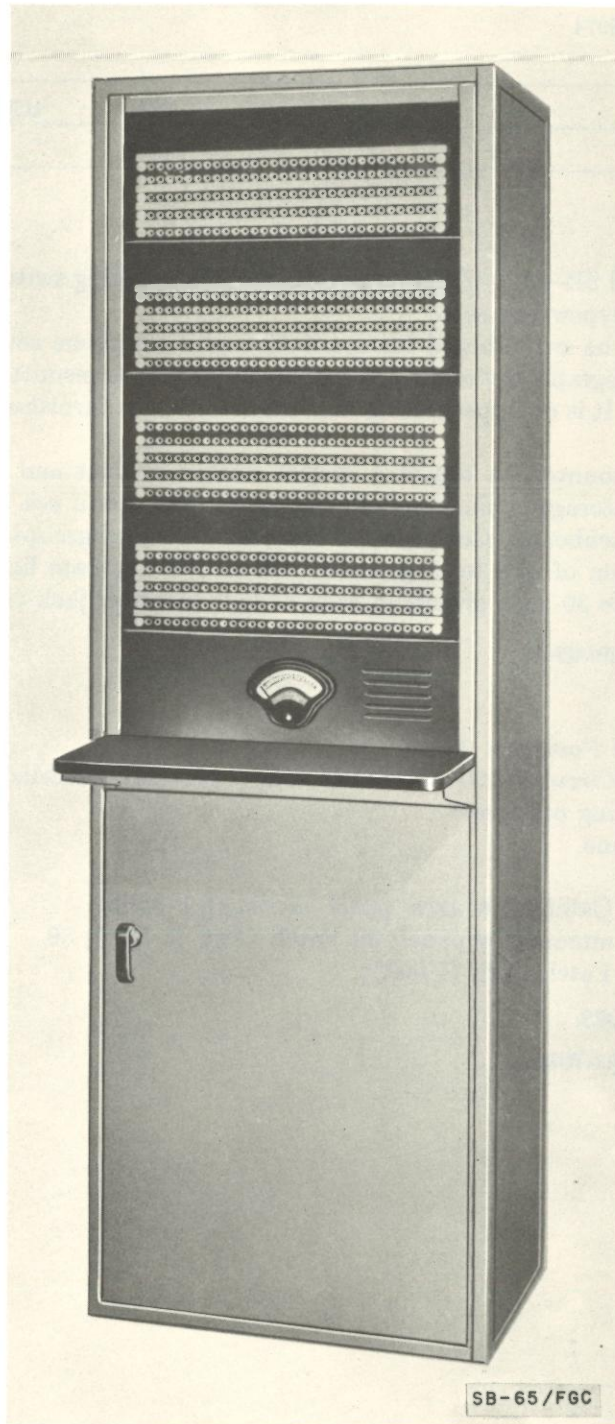

SWITCHBOARD

AN/FGC-type
SB-66()/FGC

1 March 1964

Cog Serv: USA FSN: 5305-498-7740

USA Line Item No: 671760

	USA	USN	USAF	USMC
STATUS OR TYPE CLASS.:	Std A		Std	

Manufacturer: Power Equipment Co.

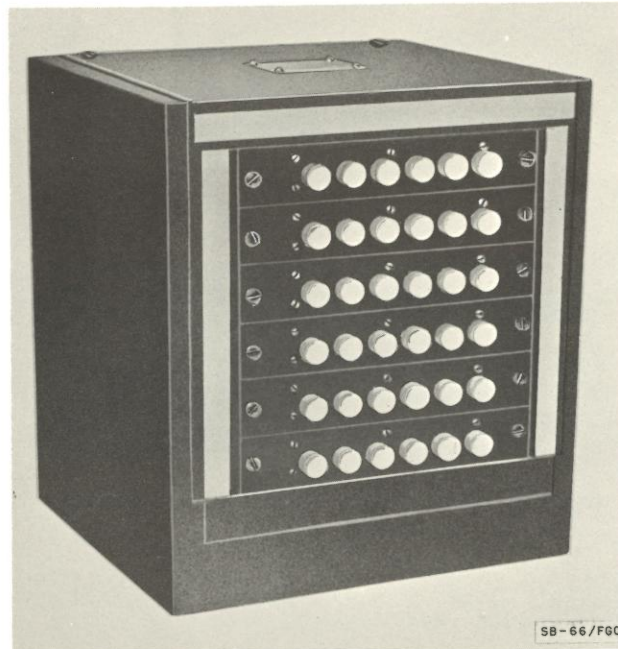
**FUNCTIONAL DESCRIPTION:**

Switchboard SB-66()/FGC is a PBX-type switchboard for interconnecting up to six teletypewriters in a small network, with provision for grouping or conference circuits. It is designed for small fixed station applications.

This equipment consists of a single, cordless, manual switchboard unit. Switching is performed by push-key operation.

Two of these switchboards may be connected together to serve 12 teletypewriters; however, only 6 lines may be used at any one time.

No provision is made on the switchboard for signaling the operator and the equipment usually is used in circuits requiring switching on a prescheduled basis.

RELATION TO SIMILAR EQUIPMENT:**TECHNICAL DESCRIPTION:**

Number of Switchboard Positions: 1.

Number and Type of Circuits: 6 line circuits; 6 teletypewriter circuits.

Power Requirements: None; all power furnished by remote equipment.

Major Units: 1 SB-66()/FGC

7 $\frac{3}{4}$ " x 9" x 7".

SWITCHBOARD

AN/FGC-type
SB-66()/FGC

TUBES, CRYSTALS, TRANSISTORS:

REFERENCE DATA AND LITERATURE:

TM 11-2083.

REPERFORATOR TRANSMITTER

AN/FGC-type
TG-26

1 March 1964

Cog Serv: USA FSN: 5815-503-2768

USA Line Item No: 660740

	USA	USN	USAF	USMC
STATUS OR TYPE CLASS.:	Obs		L/Std(-26a)	

Manufacturer:

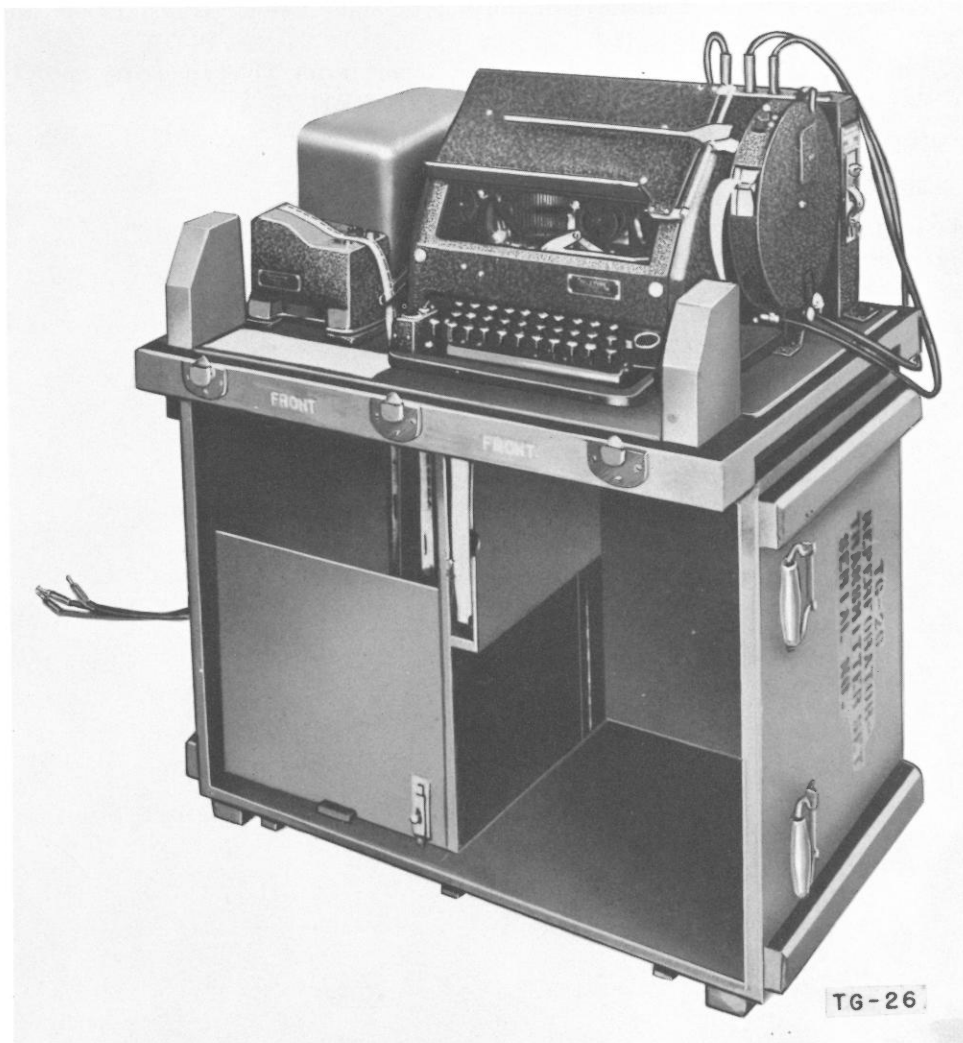
**FUNCTIONAL DESCRIPTION:**

Reperforator Transmitter TG-26 is portable field teletypewriter tape relay station equipment designed for the automatic or manual transmission and the reception of messages in the form of perforated and typed paper tape. It is used in field wire, cable, or open wire systems.

REPERFORATOR TRANSMITTER

**AN/FGC-type
TG-26**

The equipment consists of a typing reperforator having a perforator transmitter and a transmitter distributor. The perforator transmitter has a standard communications keyboard. The carrying cases may be set up to form an operating table.

Messages are received by the reperforator automatically in the form of typed and perforated tape. Sending may be performed either by operation of the keyboard, with or without simultaneous production of perforated and typed tape, or by feeding perforated tape to the transmitter distributor for automatic transmission to the line. The unit can be used for simultaneous transmission and reception, automatic monitoring, automatic transmission, automatic and manual transmission simultaneously, or for other modes of operation as required.

The TG-26 is the major operating component of Reperforator Teletypewriter Set TC-16. Other components of this set include Rectifier RA-87 and Line Unit BE-77-A.

RELATION TO SIMILAR EQUIPMENT:

TECHNICAL DESCRIPTION:

Operating Speed: 368.1 opm, 60 wpm 404 opm, 66 wpm.

Type Motor: Ac series-governed.

Pwr Requirements: 225 w, 115 v 50- to 60-cy ac 115 v dc.

Major Units: 1 TG-26 19" x 33" x 38"

225 lbs

TUBES, CRYSTALS, TRANSISTORS:

REFERENCE DATA AND LITERATURE:

TM 11-2201; TM 11-2222; TM 11-2223.

TELETYPEWRITER
AN/FGC-type
TT-5/FG

20 October 1958
 Cog Serv: USN FSN: 5815-164-7116; 5815-199-0197; 5815-698-8837
 USA Line Item No.: 680200

	USA	USN	USAF	USMC
STATUS OR TYPE CLASS.:	Std C		I/Std	

Manufacturer: Teletype Corp.



TT-5/FG

FUNCTIONAL DESCRIPTION:

Teletypewriter TT-5/FG is standard communication page-printing sending and receiving teletypewriter station equipment designed for interchanging typewritten messages between two or more

TELETYPEWRITER

**AN/FGC-type
TT-5/FG**

points connected by telegraph communication channels. It is used in permanent and semipermanent installations.

The equipment consists essentially of a commercial teletypewriter (Teletype Model 15), an operating table, and a rectifier for use at ac stations for local teletypewriter circuits and for adjusting motor voltages to the correct values.

The unit can be operated on a half-duplex or receive-only basis and adapted to receive either neutral or polar signals. It sends and receives on a single loop, but can be used with additional equipment for double-loop operation and for transmitting polar or polarential signals.

The TT-5/G has a standard keyboard for use in ordinary message communication.

RELATION TO SIMILAR EQUIPMENT:**TECHNICAL DESCRIPTION:**

Type Keyboard: Standard communications.

Characters Per Line: 72.

Operating Speed:

368 opm, 60 wpm.

404 opm, 66 wpm.

Code: 5-unit, start-stop.

Type Motor: Ac series-governed.

Motor Speed: 2,100 rpm.

Pwr Requirements: 110 v 50- to 60-cy 1-phase ac unregulated. (Alternate motors may be used for ac and dc regulated and unregulated power supplies.)

Major Units:

1 REC-29	12 $\frac{5}{16}$ " x 9 $\frac{1}{4}$ " x 8 $\frac{3}{16}$ "	46 lbs
1 XRT-115	21 $\frac{5}{16}$ " x 18" x 26 $\frac{1}{2}$ "	39 lbs
1 Model 15	18" x 21" x 15 $\frac{1}{2}$ "	112 lbs

TUBES, CRYSTALS, TRANSISTORS:**REFERENCE DATA AND LITERATURE:**

Teletype Model 15.

TELETYPEWRITER
AN/FGC-type
TT-6/FG

1 March 1964
 Cog Serv: USA FSN: 5815-164-7103
 USA Line Item No: 680220

	USA	USN	USAF	USMC
STATUS OR TYPE CLASS.:	Obs		L/Std	

Manufacturer: Teletype Corp.

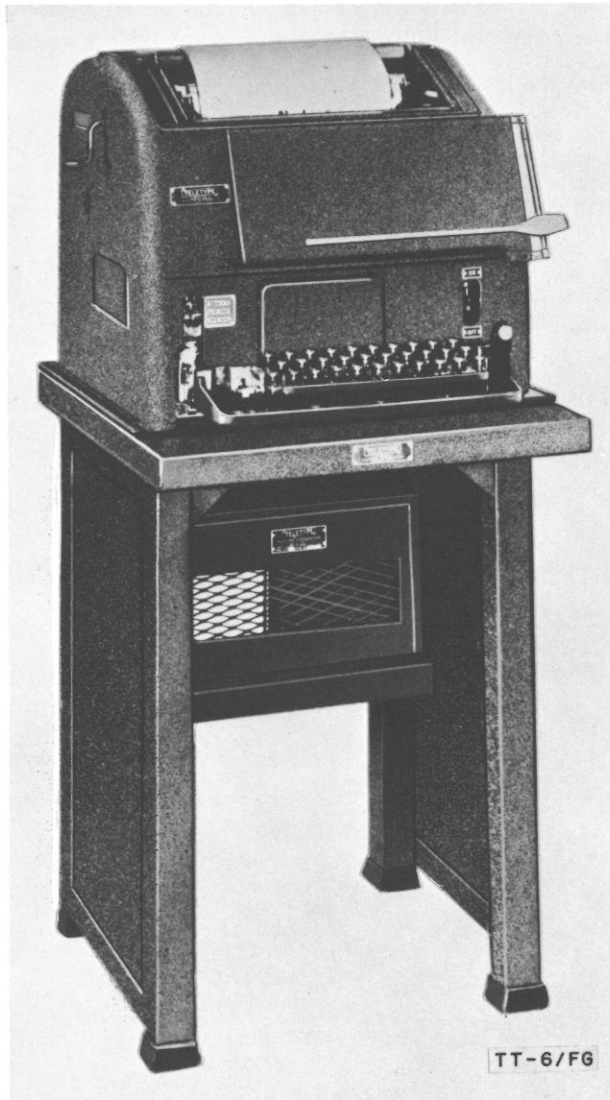

FUNCTIONAL DESCRIPTION:

Teletypewriter TT-6/FG is standard communication page-printing sending and receiving teletypewriter station equipment designed for interchanging typewritten messages between two or more

TELETYPEWRITER

**AN/FGC-type
TT-6/FG**

points connected by telegraph communication channels. It is used in permanent and semipermanent installations.

The equipment consists essentially of a commercial teletypewriter (Teletype Model 15), an operating table, and a rectifier for use at alternating current stations for local teletypewriter circuits and for adjusting motor voltages to the correct values.

The unit can be operated on a half-duplex or receive-only basis and adapted to receive either neutral or polar signals. It sends and receives on a single loop, but can be used with additional equipment for double-loop operation and for transmitting polar or polarizational signals.

The TT-6/G keyboard incorporates weather symbols for use in weather report service.

RELATION TO SIMILAR EQUIPMENT:**TECHNICAL DESCRIPTION:**

Type Keyboard: Weather communications.

Characters Per Line: 76.

Operating Speed:

368 opm, 60 wpm.

404 opm, 66 wpm.

Code: 5-unit, start-stop.

Type Motor: Ac series-governed.

Motor Speed: 2,100 rpm.

Pwr Requirements: 110 v 50- to 60-cy 1-phase ac unregulated. (Alternate motors may be used for ac and dc regulated and unregulated power supplies).

Major Units:

1 REC-29	12 $\frac{9}{16}$ " x 9 $\frac{1}{4}$ " x 8 $\frac{3}{16}$ "	46 lbs
1 XRT-115	21 $\frac{5}{16}$ " x 18" x 26 $\frac{1}{2}$ "	39 lbs
1 Teletypewriter printer Model 15	18" x 21" x 15 $\frac{1}{2}$ "	112 lbs

TUBES, CRYSTALS, TRANSISTORS:**REFERENCE DATA AND LITERATURE:**

TELETYPEWRITER
AN/FGC-type
TT-7()/FG

1 March 1964
 Cog Serv: USA FSN: 5815-164-7115
 USA Line Item No: 680240

	USA	USN	USAF	USMC
STATUS OR TYPE CLASS.:	Std-C		L/Std	

Manufacturer: Teletype Corp.

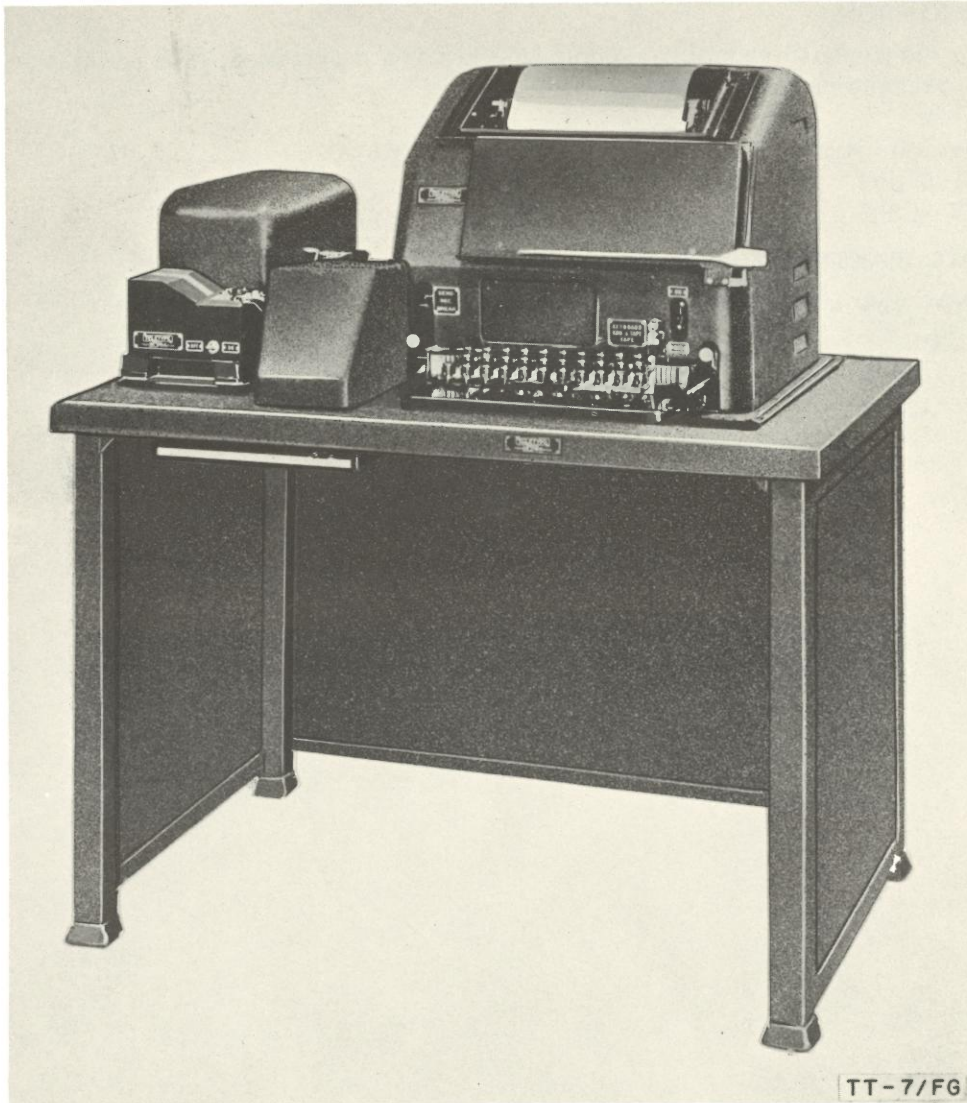

FUNCTIONAL DESCRIPTION:

Teletypewriter TT-7()/FG is a standard communication, page-printing, tape-perforating and transmitting, fixed station sending and receiving teletypewriter equipment.

TELETYPEWRITER

**AN/FGC-type
TT-7()/FG**

This equipment consists essentially of a commercial (Teletype Corp Model 19) teletypewriter and includes an operating table and base, a transmitter-distributor, rectifier, and associated components.

It can be used for neutral half-duplex or full-duplex operation with or without simultaneous production of (or automatic transmission from) perforated paper tape. It can be arranged, by the addition of supplementary components, to operate in polar or polarential facilities, and can be used in a tape-relay station.

RELATION TO SIMILAR EQUIPMENT:**TECHNICAL DESCRIPTION:**

Operating Functions: Standard communication key board operation; tape perforation; tape transmission; remote motor stop control.

Major Units:

1 Perforator-transmitter	18'' x 12'' x 6¼''	24 lbs
1 TT-52/FG		30 lbs
1 FN-89/FG	36'' x 23'' x 27''	112 lbs

TUBES, CRYSTALS, TRANSISTORS:**REFERENCE DATA AND LITERATURE:**

TM 11-2216

TELETYPEWRITER
AN/FGC-type
TT-8/FG

1 March 1964

Cog Serv: USA FSN: 5815-164-7111

USA Line Item No.: 680260

	USA	USN	USAF	USMC
STATUS OR TYPE CLASS.:	Obs		L/Std	

Manufacturer: Teletype Corp.

**FUNCTIONAL DESCRIPTION:**

Teletypewriter TT-8/FG (the weather communication version of Teletypewriter TT-7/FG) is a page-printing, tape-perforating and tape-transmitting, sending and receiving teletypewriter station equipment used for weather data communication at fixed plant installations.

TELETYPEWRITER

**AN/FGC-type
TT-8/FG**

This equipment consists essentially of a teletypewriter equipped with a perforator-transmitter and weather keyboard and type pallets, plus a transmitter-distributor, a rectifier, and operating table, and accessories.

It operates on a half-duplex or full-duplex basis. A line selector switch is provided and the equipment can function as a teletypewriter relay station. Wiring includes an integral testing circuit and connection terminals for a reperforator.

RELATION TO SIMILAR EQUIPMENT:**TECHNICAL DESCRIPTION:**

Operating Functions: Keyboard operation or tape transmission; page printing and/or tape perforation (weather keyboard).

Operating Speed: 368.1 opm (60 wpm) or 404 opm (66 wpm).

Motor Characteristics: Ac series governed motor; 110-v 50/60-cy ac.

Pwr Requirements: 92-125/190-250-v 25/50/60-cy ac.

Major Units:

1 TT-52/FG		30 lbs
1 Perforator-transmitter	18'' x 12'' x 6¼''	24 lbs
1 Table	21½'' x 18'' x 26½''	112 lbs
1 Teletypewriter	15½'' x 14'' x 12''	29 lbs

TUBES, CRYSTALS, TRANSISTORS:**REFERENCE DATA AND LITERATURE:**

TM 11-2216

TRANSMITTER-DISTRIBUTOR

AN/FGC-type

TT-21/FG

1 March 1964

Cog Serv: USA FSN: 5815-222-4294

USA Line Item No.: 691850

	USA	USN	USAF	USMC
STATUS OR TYPE CLASS.:	Std A			

Manufacturer:

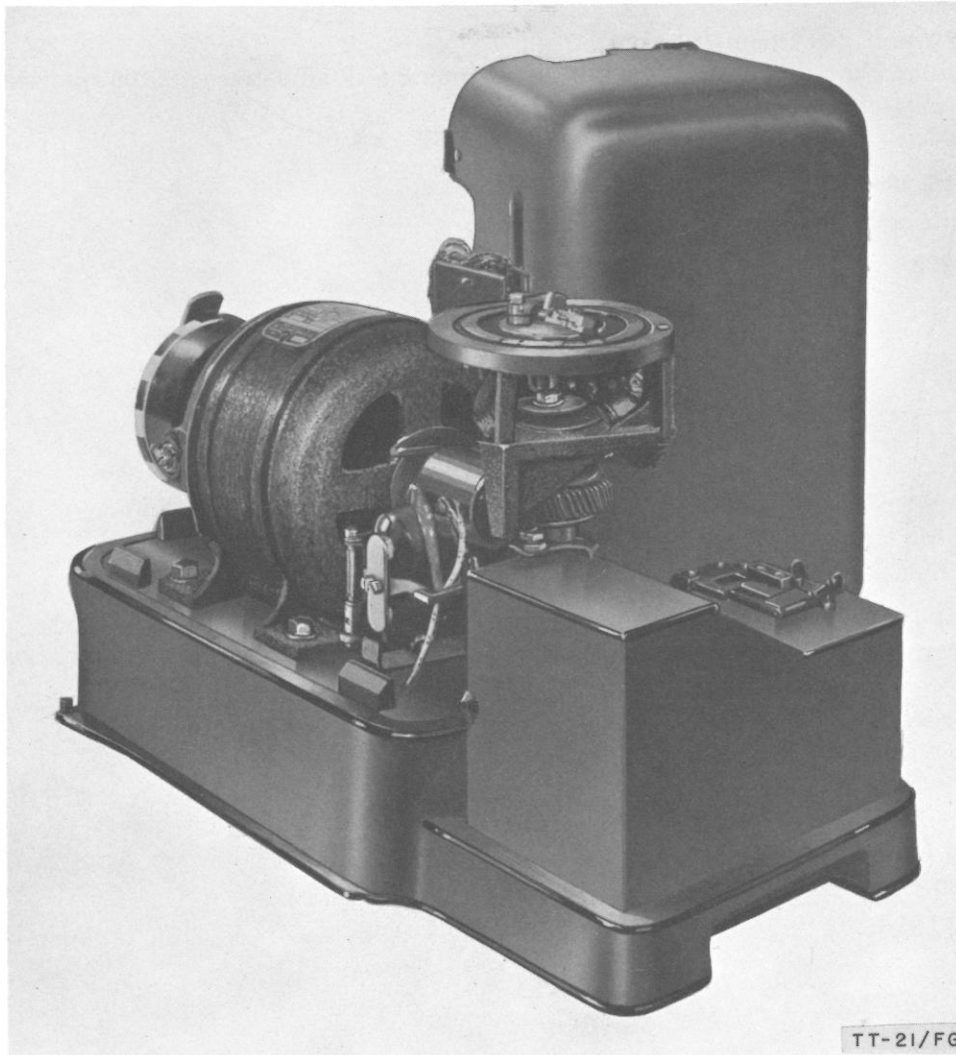
**FUNCTIONAL DESCRIPTION:**

Transmitter-Distributor TT-21/FG is an automatic teletypewriter transmitting equipment. It is used to transmit or retransmit teletypewriter messages from previously prepared or received perforated tape in large communication centers.

TRANSMITTER-DISTRIBUTOR

AN/FGC-type
TT-21/FG

This equipment is a single-channel, motor-driven unit, consisting of tape-sensing, tape-feeding, and transmitting mechanisms and a motor inclosed in a metal housing. It includes a special start magnet, power and line cords, and end-of-line stop mechanism.

RELATION TO SIMILAR EQUIPMENT:

TECHNICAL DESCRIPTION:

Operating Functions: Transmits five-unit, start-stop teletypewriter code impulses from a perforated tape.

Operating Speed: 368.1 opm (60 wpm).

Motor Characteristics: Series governed; 87.6 vps tuning fork adjustment; 2,100 rpm speed.

Pwr Requirements: 115-v 25/60-cy ac.

Major Units: 15½" x 8¾" x 9"

35 lbs

TUBES, CRYSTALS, TRANSISTORS:

REFERENCE DATA AND LITERATURE:

TM 11-2222

TYPEWRITER REPEATER-MIXER

AN/FGQ-1()

1 March 1964

Cog Serv: USN FSN: 5815-256-4067

USA Line Item No: 680600

	USA	USN	USAF	USMC
STATUS OR TYPE CLASS:	Std-A			

Manufacturer: Western Electric Co.

**FUNCTIONAL DESCRIPTION:**

Teletypewriter Repeater-Mixer AN/FGQ-1() is used with other teletypewriter equipment (shown above) to provide a secrecy system in which plain text messages may be automatically enciphered before transmission to a distant station. Incoming messages received in cipher are automatically deciphered and appear on the recording teletypewriter in plain text.

These teletypewriter station arrangements are adaptable for on-line and off-line operations.

RELATION TO SIMILAR EQUIPMENT:**TECHNICAL DESCRIPTION:**

Operating Speed: 368.1 opm (60 wpm).

TYPEWRITER REPEATER-MIXER

AN/FGQ-1()

Motor Characteristics:

Ac Series or Universal: 95/105/115/125/190/210/230/250 v, 25/40/50/60 cy.

Ac Synchronous: 95-125 v, 60 cy.

Dc Universal: 105-125 v.

Major Units:

1 AN/FGQ-1 30½" x 26" x 22"

160 lbs

TUBES, CRYSTALS, TRANSISTORS:

REFERENCE DATA AND LITERATURE:

TM 11-2209

TELETYPEWRITER PRINTER-PROJECTOR

AN/FGQ-type
TT-71/UG

1 March 1964

Cog Serv: USA FSN: 5815-356-3163

USA Line Item No: 632833

	USA	USN	USAF	USMC
STATUS OR TYPE CLASS.:	Std B		Std	

Manufacturer:

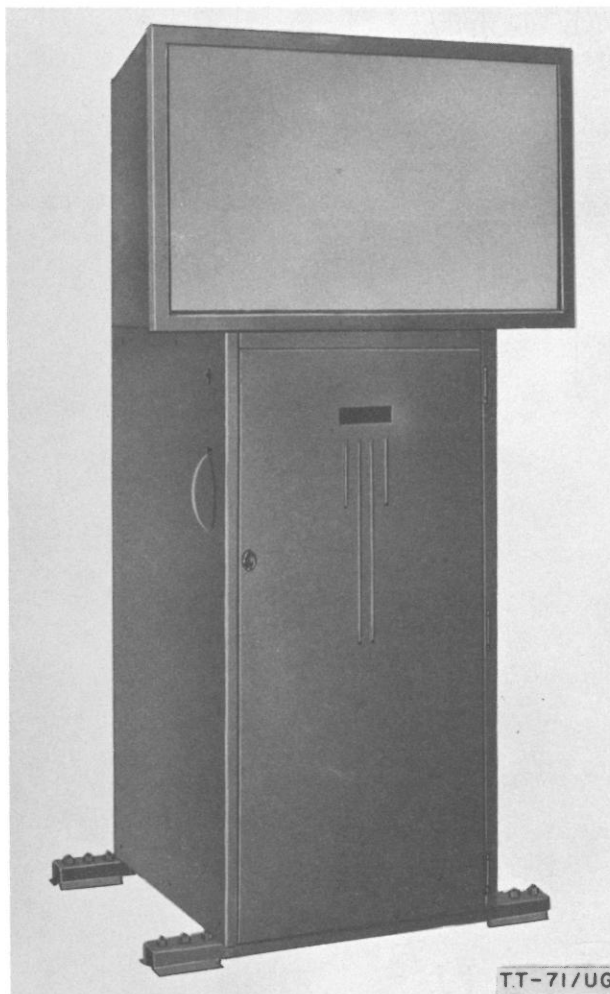
**FUNCTIONAL DESCRIPTION:**

Teletypewriter Printer-Projector TT-71/UG is fixed station receiving-only equipment. It projects its received messages on a translucent screen and is used for teletypewriter conference communications, group orientation and instruction, and similar applications.⁴

This equipment consists of a single cabinet containing two receiving units and the projection and illumination systems. One of the receiving units (essentially a commercial Teletype Corp. Model 14) is a page-printing teletypewriter. This unit prints the message in page form on a transparent web from which the message is projected on the 3- by 2-foot screen. The other receiving unit (commercial

TELETYPEWRITER PRINTER-PROJECTOR

AN/FGQ-type
TT-71/UG

Teletype Corp. Model 14, modified, or equivalent) is a type-bar tape printer. This unit prints the message on a continuous strip of paper tape, which may be used for reference purposes.

RELATION TO SIMILAR EQUIPMENT:

TECHNICAL DESCRIPTION:

Operating Functions: Standard communications type pallet arrangements; five-unit start-stop code.

Lighting System: 500-w lamp.

Operating Speed: 368.1 opm (60 wpm).

Motor Characteristics: Synchronous; 10-amp start, 2-amp running load.

Pwr Requirements: 1 kw, 110 v 60-cy ac.

Major Units:

TT-71/UG 81" x 33" x 37".

TUBES, CRYSTALS, TRANSISTORS:

REFERENCE DATA AND LITERATURE:

TM 11-2228

REPERFORATOR

AN/FGR-type TT-45/FG, TT-46/FG

22 October 1958
 Cog Serv: USN FSN: 5815-370-0055
 USA Line Item No:

	USA	USN	USAF	USMC
STATUS OR TYPE CLASS.:			Std (TT-46/FG)	

Manufacturer: Teletype Corp

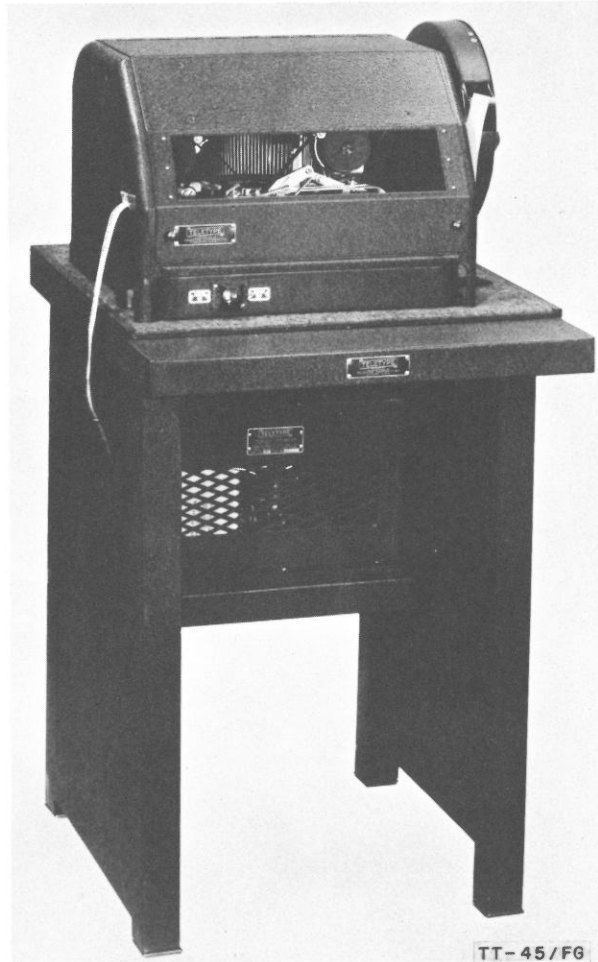

FUNCTIONAL DESCRIPTION:

Reperforators TT-45/FG and TT-46/FG are receiving only typing reperforator units used to receive messages transmitted over wire or radio circuits and to record the messages in both code perforations and typed characters on the same tape. They are used in teletypewriter receiving and distributing stations, messages received by a typing reperforator may be transmitted to one or more stations by a transmitter distributor.

REPERFORATOR

**AN/FGR-type
TT-45/FG, TT-46/FG**

The reperforators consist essentially of a commercial typing reperforator (Teletype Model 14), an operating table, and a rectifier power supply. They may be used with five-unit code teletypewriter transmitting equipment geared for 368 operations per minute such as Teletypewriters TT-47/UG, TT-48/UG, TT-69/UG, TT-70/UG, TT-52/FG, and AN/FGC-11. The equipment also may be used with Teletype Panel TT-23/SG or TT-23B/SG and associated radio converters.

The TT-45/FG and TT-46/FG are identical with the exception of the motor units. The TT-45/FG has a synchronous motor; the TT-46/FG has a series-governed motor.

RELATION TO SIMILAR EQUIPMENT:**TECHNICAL DESCRIPTION:**

Type Signaling Code: 5-unit, start-stop.

Transmission Speed: 368 opm, 60 wpm.

Type Motor:

TT-45/FG: Synchronous.

TT-46/FG: Series-governed.

Pwr Requirements: 115 v 60-cycle 1-phase ac.

Major Units:

1 Table XRT200AA

26 $\frac{1}{8}$ " x 18" x 21 $\frac{5}{16}$ "

1 Typing Reperforator

11 $\frac{1}{2}$ " x 15 $\frac{3}{4}$ " x 13"

FPR23H246

TUBES, CRYSTALS, TRANSISTORS:**REFERENCE DATA AND LITERATURE:**

NAVSHIPS 91241.

Spec No. S-5514.

TELETYPEWRITER REPERFORATOR

AN/FGR-type
TT-107/FG

1 March 1964

Cog Serv: USA FSN: 5815-503-1168

USA Line Item No: 660709

	USA	USN	USAF	USMC
STATUS OR TYPE CLASS.:	Std A		Std	

Manufacturer:

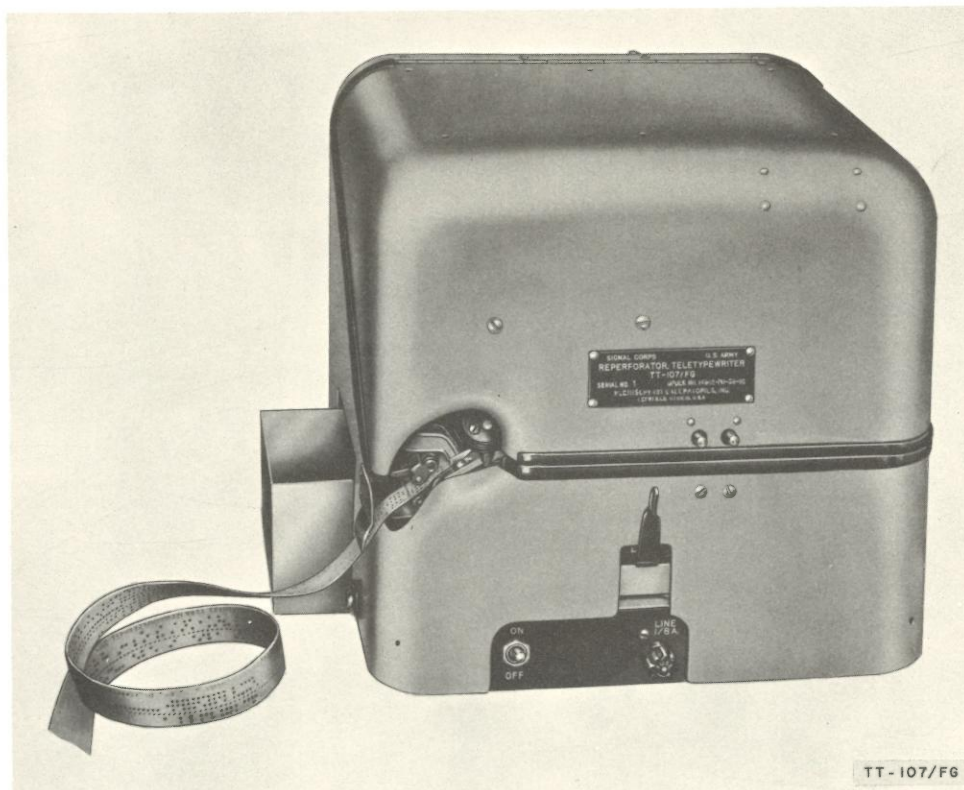
**FUNCTIONAL DESCRIPTION:**

Teletypewriter Reperforator TT-107/FG is a fixed station, receiving only, lightweight typing reperforator used to receive messages directly from the line, or to monitor copy produced by other teletypewriters. It may be operated by either polar or neutral signals.

It prints English characters and perforates standard start-stop five-unit code characters. Accessory drive gears are available to convert the normal 60-wpm speed to 100-wpm operation.

RELATION TO SIMILAR EQUIPMENT:**TECHNICAL DESCRIPTION:**

Operating Functions: Prints standard communication symbols and characters; perforates start-stop five-unit code groups.

Operating Speed: 386.1 or 600 opm (60 or 100 wpm).

Motor Characteristics: Synchronous; 3,600 rpm.

TELETYPEWRITER REPERFORATOR

AN/FGR-type
TT-107/FG

Pwr Requirements: 120 w, 115-v 60-cycle 1-phase ac.

Major units: TT 107/FG

12⁵/₁₆" x 12⁵/₁₆" x 12¹/₄"

37 lbs

TUBES, CRYSTALS, TRANSISTORS:

REFERENCE DATA AND LITERATURE:

TM 11-2226

MIL-T-11985

INTERCOMMUNICATING STATION

AN/FIC-type
LS-124()/FI

1 March 1964

Cog Serv: USA FSN: 5830-170-9934

USA Line Item No: 621280

	USA	USN	USAF	USMC
STATUS OR TYPE CLASS.:	Std A		Std	

Manufacturer:

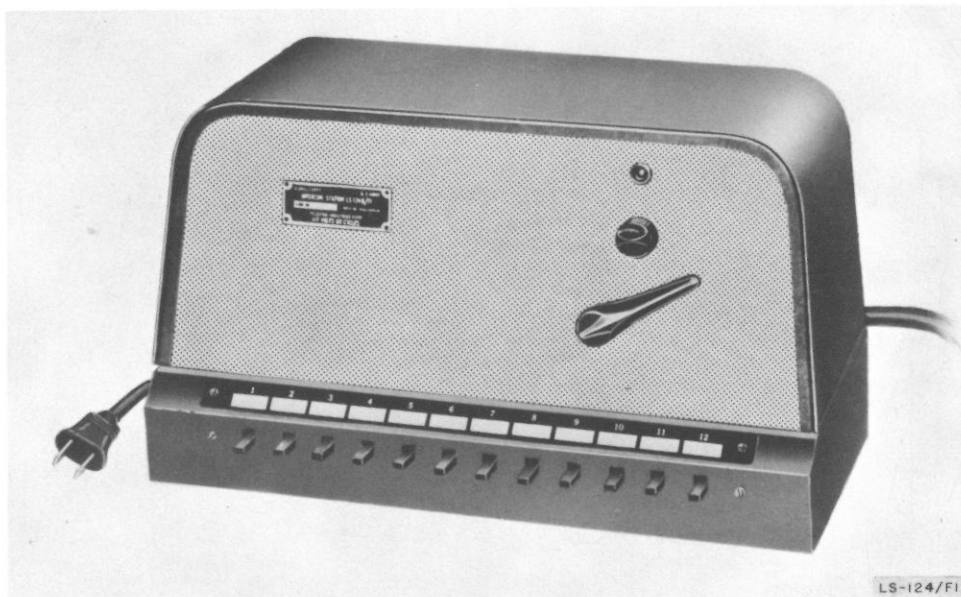
**FUNCTIONAL DESCRIPTION:**

Intercommunicating Station LS-124()/FI is a master control station unit of an intercommunication system serving large headquarters buildings, depots, and communications centers at air stations or similar locations.

This equipment consists of a speaker microphone and an audio amplifier assembled as a single unit and is used in conjunction with as many as 12 other local station units on a one-way, talk-back, selected station, or all-talk basis.

The LS-124()/FI usually is operated in conjunction with remote speaker microphone station units that cannot signal this master station.

The LS-124()/FI can operate over a trunk line to another master station; the resulting combination can provide intercommunication and paging facilities.

RELATION TO SIMILAR EQUIPMENT:**TECHNICAL DESCRIPTION:**

Input and Output Impedances: 50 or 500 ohms.

Speaker Voice Coil Impedance: 45 ohms.

Pwr Output: 2 w to line; 1 w to speaker.

Pwr Requirements: 25 w (in use), 12 w (idle), 110-125-v 50/60-cy ac.

Major Units: LS-124()/FI 7 $\frac{3}{8}$ '' x 6 $\frac{7}{8}$ '' x 13 $\frac{3}{8}$ ''

20.5 lbs

INTERCOMMUNICATING STATION

AN/FIC-type
LS-124()/FI

TUBES, CRYSTALS, TRANSISTORS:

REFERENCE DATA AND LITERATURE:

TM 11-2572 and TM 11-2572A

INTERCOMMUNICATING STATION

AN/FIC-type
LS-125()/FI

1 March 1964

Cog Serv: USA FSN: 5830-162-8168

USA Line Item No: 621290

	USA	USN	USAF	USMC
STATUS OR TYPE CLASS.:	Std A			

Manufacturer:

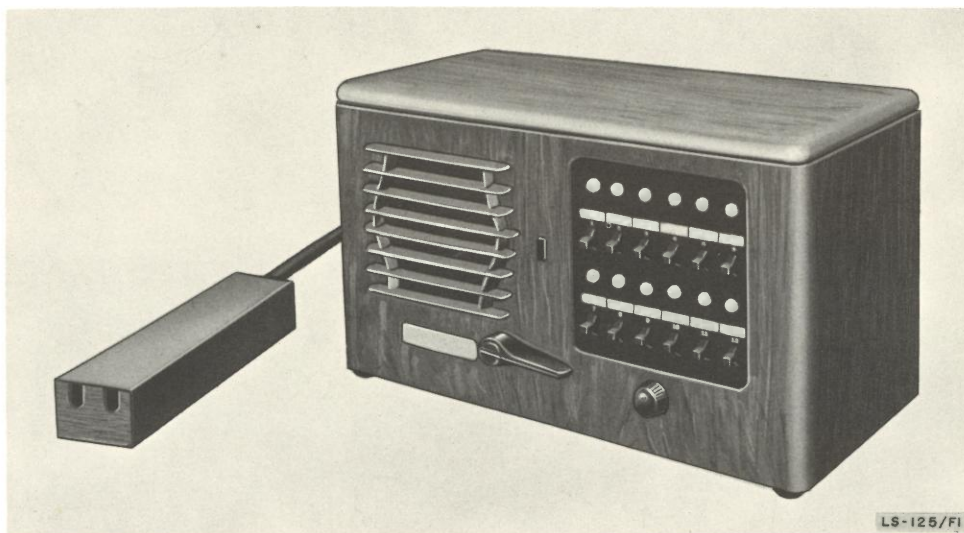
**FUNCTIONAL DESCRIPTION:**

Intercommunicating Station LS-125()/FI is a master or control station unit used in an intercommunication system. It is used in headquarters buildings, depots, communications centers, or similar installations.

This equipment consists of a speaker microphone and an audio amplifier assembled as a single unit and is used in conjunction with as many as 12 other station units on a one-way, talk-back, selected station, or all-talk basis.

The LS-125()/FI is designed specifically for use with Intercommunicating Station LS-129/FI or LS-130()/FI.

RELATION TO SIMILAR EQUIPMENT:**TECHNICAL DESCRIPTION:**

Input and Output Impedances: 50 or 500 ohms.

Speaker Voice Coil Impedance: 45 ohms.

Pwr Output: 2½ w.

Pwr Requirements: 30 w (in use), 15 w (idle), 110-125-v 50/60-cy ac.

Major Units: LS-125()/FI 7⅞'' x 6⅞'' x 13⅜''

20½ lbs.

TUBES, CRYSTALS, TRANSISTORS:**REFERENCE DATA AND LITERATURE:**

TM 11-2572 and TM 11-2572A

INTERCOMMUNICATING STATION

AN/FIC-type
LS-126()/FI

1 March 1964

Cog Serv: USA FSN: 5830-164-8056

USA Line Item No.: 621295

	USA	USN	USAF	USMC
STATUS OR TYPE CLASS.:	Std A			

Manufacturer:



LS-126/FI

FUNCTIONAL DESCRIPTION:

Intercommunicating Station LS-126()/FI is a master or control station unit used in an intercommunication system. It is used in headquarters buildings, depots, communications centers, or similar locations.

This equipment consists of a speaker microphone and an audio amplifier assembled as a single unit and is used in conjunction with as many as six other local station units on a one-way, talk-back, selected station basis, or all-talk basis.

This unit is designed specifically for use with Intercommunicating Station LS-129/FI or LS-130()/FI.

RELATION TO SIMILAR EQUIPMENT:**TECHNICAL DESCRIPTION:**

Input and Output Impedances: 50 or 500 ohms.

Speaker Voice Coil Impedance: 45 ohms.

Pwr Output: 2½ w.

Pwr Requirements: 30 w (in use), 15 w (idle), 115-v 50/60-cy ac.

Major Units: 1 LS-126()/FI

7¾" x 6⅞" x 13¾"

20½ lbs.

TUBES, CRYSTALS, TRANSISTORS:**REFERENCE DATA AND LITERATURE:**

TM 11-2572 and TM 11-2572A.

INTERCOMMUNICATING STATION

AN/FIC-type
LS-127()/FI

1 March 1964

Cog Serv: USA FSN: 5830-162-8169

USA Line Item No.: 621300

	USA	USN	USAF	USMC
STATUS OR TYPE CLASS.:	Std A			

Manufacturer:

**FUNCTIONAL DESCRIPTION:**

Intercommunicating Station LS-127()/FI is the master or control station unit of an intercommunication system and is used in systems serving large headquarters buildings, depots, communications centers, or similar fixed plant installations.

This equipment consists of a self-contained speaker microphone and amplifier and can be used with as many as 24 other station units on a one-way, talk-back, selected station, or all-talk basis.

The LS-127()/FI is designed specifically for use with Intercommunicating Station LS-129/FI or LS-130()/FI.

RELATION TO SIMILAR EQUIPMENT:**TECHNICAL DESCRIPTION:**

Input and Output Impedances: 50 or 500 ohms.

Speaker Voice Coil Impedance: 45 ohms.

Pwr Output: 2½ w.

Pwr Requirements: 30 w (in use), 15 w (idle), 115-v 50/60-cy ac.

Major Units: 1 LS-127()/FI 7¾" x 6¾" x 19¾"

30 lbs.

TUBES, CRYSTALS, TRANSISTORS:**REFERENCE DATA AND LITERATURE:**

TM 11-2572 and TM 11-2572A.

INTERCOMMUNICATING STATION

AN/FIC-type LS-128()/FI

1 March 1964

Cog Serv: USA FSN: 5830-162-8170

USA Line Item No: 621305

	USA	USN	USAF	USMC
STATUS OR TYPE CLASS.:	Std A			

Manufacturer:

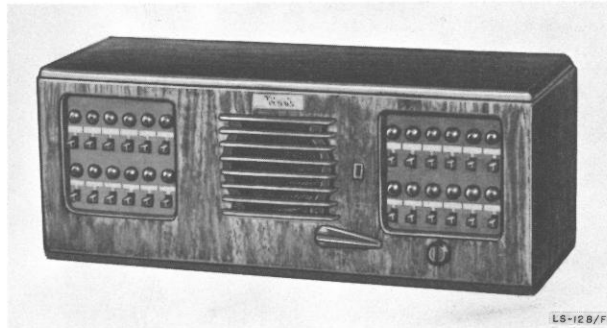

LS-128/FI

FUNCTIONAL DESCRIPTION:

Intercommunicating Station LS-128()/FI is the master or control station unit of an intercommunication system and is used in systems serving large headquarters buildings, depots, communications centers, or similar fixed-plant installations.

This equipment consists essentially of a speaker microphone and amplifier and can be used in conjunction with as many as 24 other station units on a one-way, talk-back, selected station, or all-talk basis.

The LS-128()/FI is designed specifically for use with Intercommunicating Station LS-129/FI or LS-130()/FI.

RELATION TO SIMILAR EQUIPMENT:**TECHNICAL DESCRIPTION:**

Input and Output Impedances: 50 or 500 ohms.

Speaker Voice Coil Impedance: 45 ohms.

Pwr Output: 2½ w.

Pwr Requirements: 30 w (in use), 15 w (idle), 115-v 50/60 cy ac.

Major Units: 1 LS-128()/FI 7¾" x 6¾" x 19¼"

30 lbs

TUBES, CRYSTALS, TRANSISTORS:**REFERENCE DATA AND LITERATURE:**

TM 11-2572 and TM 11-2572A.

INTERCOMMUNICATING STATION

AN/FIC-type LS-130()/FI

1 March 1964

Cog Serv: USA FSN: 5830-222-1663

USA Line Item No: 621320

	USA	USN	USAF	USMC
STATUS OR TYPE CLASS.:	Std-A		L/Std	

**FUNCTIONAL DESCRIPTION:**

Intercommunication Station LS-130()/FI is a speaker microphone equipment designed for use as a local station unit in an intercommunication system. It is used in systems serving large headquarters buildings, depots, communications centers, or similar installations.

This equipment consists of a 5-inch speaker microphone contained in a wooden cabinet and is equipped with a push-button for signaling annunciator-equipped master station units.

The LS-130()/FI cannot initiate calls to the other speaker microphone units or to master station units not equipped with annunciators.

The LS-130()/FI receives power from the master control station unit of the system in which it is used.

RELATION TO SIMILAR EQUIPMENT:**TECHNICAL DESCRIPTION:**

Output Impedance: 50 ohms.

Major Units: 1 LS-130()/FI

7 $\frac{3}{8}$ " x 3 $\frac{3}{4}$ " x 7 $\frac{1}{8}$ "

4.25 lbs

TUBES, CRYSTALS, TRANSISTORS:**REFERENCE DATA AND LITERATURE:**

TM 11-2572.

INTERCOMMUNICATING STATION

**AN/FIC-type
LS-138/FI**

1 March 1964

Cog Serv: USA FSN: 5830-170-9935

USA Line Item No: 621322

	USA	USN	USAF	USMC
STATUS OR TYPE CLASS.:	Std-A			

Manufacturer:

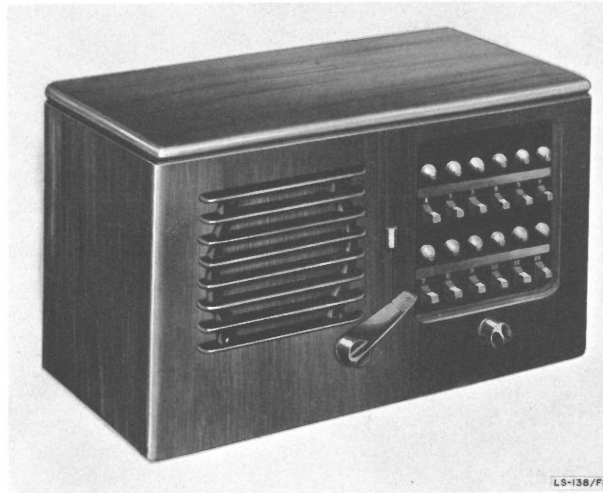
**FUNCTIONAL DESCRIPTION:**

Intercommunicating Station LS-138/FI is a master or control station unit of an intercommunication unit. It is used in systems serving large headquarters buildings, depots, communications centers, or similar installations.

This equipment consists of a self-contained speaker microphone and amplifier unit and is used in conjunction with 12 other local station units on a one-way, talk-back, selected station, or all-talk basis.

The LS-138/FI can communicate with other master stations and through them with their remote stations.

RELATION TO SIMILAR EQUIPMENT:**TECHNICAL DESCRIPTION:**

Input and Output Impedances: 50 or 500 ohms.

Speaker Voice Coil Impedance: 45 ohms.

Pwr Output: 2½ w.

Pwr Requirements: 30 w (in use), 15 w (idle), 110/220-v 50/60-cy ac.

Major Units: 1 LS-138/FI

7⅞" x 6⅞" x 13⅞"

20.5 lbs

TUBES, CRYSTALS, TRANSISTORS:**REFERENCE DATA AND LITERATURE:**

INTERCOMMUNICATION STATION

AN/FIC-type
LS-200/FI

1 March 1964

Cog Serv: USA FSN: 5830-503-2691

USA Line Item No: 621326

	USA	USN	USAF	USMC
STATUS OR TYPE CLASS.:	Std-A		Std	

Manufacturer:

No illustration available

FUNCTIONAL DESCRIPTION:

Intercommunication Station LS-200/FI is used for voice communication over wire lines between offices of a large headquarters. The equipment is arranged to provide privacy of communication (by means of speaker-microphone or handset) between stations when all master stations in the system are equipped with this feature. Annunciators are used as a means of signaling between points in the system.

The LS-200/FI is used with as many as six other local station units.

RELATION TO SIMILAR EQUIPMENT:**TECHNICAL DESCRIPTION:**

Input and Output Impedances: 50 or 500 ohms.

Speaker Voice Coil Impedance: 45 ohms.

Pwr Output: 2 w.

Pwr Requirements: 30 w (in use), 15 w (idle), 105- to 125-v 60 cy ac.

Major Units: 1 LS-200/FI 13 $\frac{3}{4}$ " x 7 $\frac{1}{8}$ " x 7 $\frac{1}{2}$ "

TUBES, CRYSTALS, TRANSISTORS:

REFERENCE DATA AND LITERATURE: TM 11-5089.

INTERCOMMUNICATION STATION

**AN/FIC-type
LS-201/FI**

1 March 1964

Cog Serv: USA FSN: 5830-521-0542

USA Line Item No: 621327

	USA	USN	USAF	USMC
STATUS OR TYPE CLASS.:	Std-A		Std	

Manufacturer:

No illustration available.

FUNCTIONAL DESCRIPTION:

Intercommunication Station LS-201/FI is used for voice communication over wire lines between offices of a large headquarters. The equipment is arranged to provide privacy of communication (by means of speaker-microphone or handset) between stations when all master stations in the system are equipped with this feature. Annunciators are used as a means of signaling between points in the system.

The LS-201/FI is used with as many as 12 other local station units.

RELATION TO SIMILAR EQUIPMENT:**TECHNICAL DESCRIPTION:**

Input and Output Impedances: 50 or 500 ohms.

Speaker Voice Coil Impedance: 45 ohms.

Pwr Output: 2 w.

Pwr Requirements: 30 w (in use), 15 w (idle), 105- to 125-v 60 cy ac.

Major Units: 1 LS-201/FI 13³/₄" x 7¹/₈" x 7¹/₂"

TUBES, CRYSTALS, TRANSISTORS:**REFERENCE DATA AND LITERATURE:**

TM 11-5089.

INTERCOMMUNICATION STATION

AN/FIC-type
LS-202/FI

1 March 1964

Cog Serv: USA FSN: 5830-503-2692

USA Line Item No: 621276

	USA	USN	USAF	USMC
STATUS OR TYPE CLASS.:	Std-A		Std	

Manufacturer:

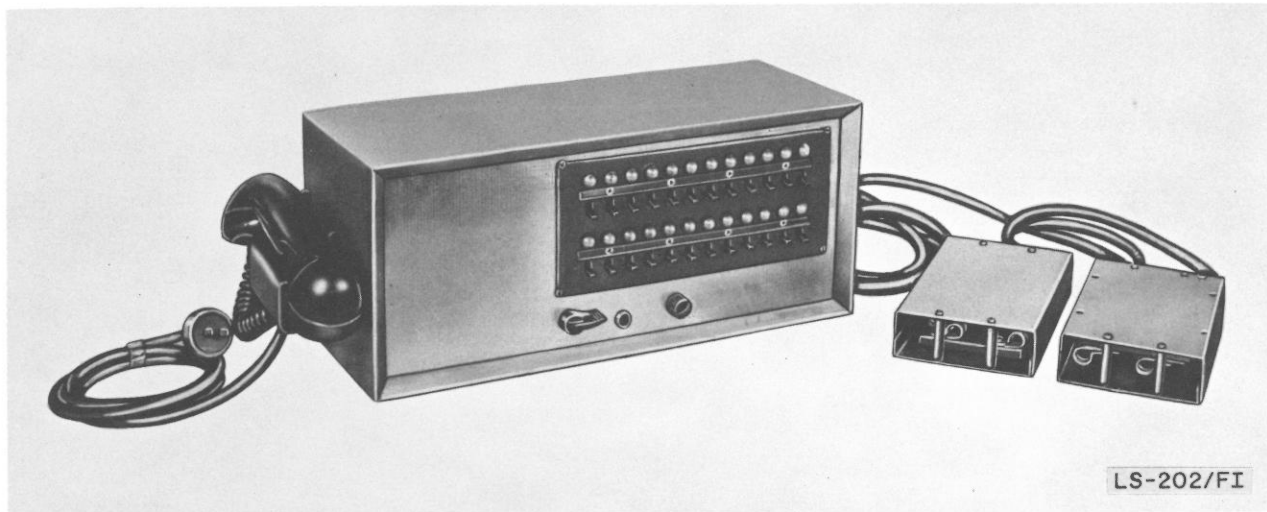
**FUNCTIONAL DESCRIPTION:**

Intercommunication Station LS-202/FI is used for voice communication over wire lines between offices of a large headquarters. The equipment is arranged to provide privacy of communication (by means of speaker-microphone or handset) between stations when all master stations in the system are equipped with this feature. Annunciators are used as a means of signaling between points in the system.

The LS-202/FI is used with as many as 24 other local station units.

RELATION TO SIMILAR EQUIPMENT:**TECHNICAL DESCRIPTION:**

Input and Output Impedances: 50 or 500 ohms.

Speaker Voice Coil Impedance: 45 ohms.

Pwr Output: 2 w.

Pwr Requirements: 30 w (in use), 15 w (idle), 105- to 125-v 60 cy ac.

Major Units: 1 LS-202/FI 21 $\frac{3}{4}$ " x 7 $\frac{1}{2}$ " x 8 $\frac{1}{2}$ ".

TUBES, CRYSTALS, TRANSISTORS:**REFERENCE DATA AND LITERATURE:**

TM 11-5089.

AN/FRA-6

21 November 1958
Cog Serv: USN FSN: 5820-503-1110
USA Line Item No: 611294

USA	USN	USAF	USMC
-----	-----	------	------

STATUS OR TYPE CLASS.:

Std

Manufacturer:



CONTROL-MONITOR GROUP

AN/FRA-6

FUNCTIONAL DESCRIPTION:

Control-Monitor Group AN/FRA-6 is an airport remote-control console used for the operation of one to ten transmitters remotely located from the airport control tower. It is also used for selecting and controlling the output of one to ten remotely located receivers.

When required, two of these groups can be connected in multiple to share any or all the remote equipment available.

RELATION TO SIMILAR EQUIPMENT:

TECHNICAL DESCRIPTION:

Number of Controlled Channels: 10 receivers (max); 10 transmitters (max).

Pwr Requirements: 25 w, 105- to 125-v 50- to 60-cy 1-phase ac.

Major Units:

1 AM-744/FRA-6	8'' x 5 ³ / ₄ '' x 17 ⁷ / ₁₆ ''.
1 AM-728/FRA-6	8'' x 2 ⁷ / ₈ '' x 17 ⁷ / ₁₆ ''.
1 OA-408/FRA-6	40'' x 19 ¹ / ₂ '' x 36''.
1 PP-851/FRA-6	7 ¹ / ₄ '' x 8 ⁵ / ₈ '' x 10 ⁷ / ₈ ''.

TUBES, CRYSTALS, TRANSISTORS:

REFERENCE DATA AND LITERATURE:

NAVSHIPS 91816(a).

CONTROL MONITOR GROUP

AN/FRA-11

15 March 1962
 Cog Serv: USN FSN:
 USA Line Item No:

USA	USN	USAF	USMC
-----	-----	------	------

STATUS OR TYPE CLASS.:

Manufacturer: RH (80090)

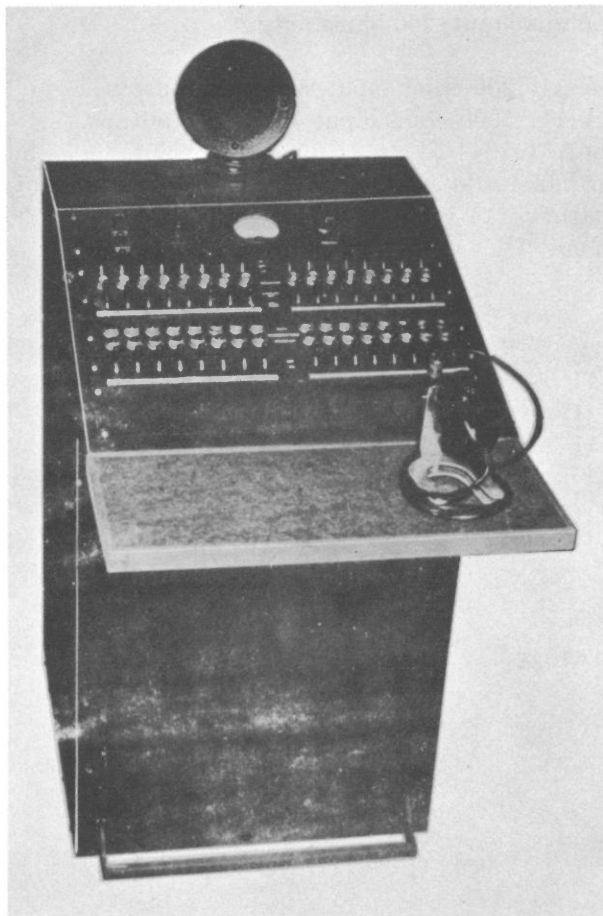
**FUNCTIONAL DESCRIPTION:**

Control Monitor Group AN/FRA-11 enables control tower operating personnel to maintain complete two-way voice communication with aircraft while in flight or on the field. Each of the three operating positions (designated A, B, and C) has a microphone and a transmitter control for the operation and control of any one of the 16 radio transmitters. Indicating meters are provided for reading the level of the audio signal supplied to the transmitter. The transmitter in use can be determined from the indicating lamps adjacent to the transmitter selector switches.

Radiotelephone messages from aircraft, received by any one of the 16 radio receivers, can be heard through the overhead speakers, pull-down speakers, or headsets. Each radio receiving channel has an identification lamp that lights when the channel is in use. The output level for the overhead speaker outputs is set by 16 lever-type switches (HI-LO or OFF). A second row of lever-type switches permits

CONTROL-MONITOR GROUP

AN/FRA-11

the operator to select and feed any radio signal to the pull-down speaker. Any received signal can be recorded. A limited number of voice recorders may be employed for specific channels. Any desired shift in channel recording may be made on the jack panel of cabinet number one.

RELATION TO SIMILAR EQUIPMENT:

TECHNICAL DESCRIPTION:

Input and Output Impedance:

Pre-amplifier: 200 ohms input, 200 ohms output.

Output Amplifiers:

AM-1043/FRA-11: 200 ohms input, 600 ohms output.

AM-1042/FRA-11: 5000 ohms input, 600 ohms output.

Amplifier Assembly AM-1044/FRA-11: 600 ohms input, 1200 ohms output.

Signal Distribution Panel SB-390/FRA-11: 1,000,000 ohms input, 600 ohms output.

Operating Pwr Requirements: 115 v, 60 cps, 2-Wire, single phase; 1600 w. DC power is supplied as part of the equipment.

Major Units:

3 C-1443/FRA-11	34 $\frac{3}{8}$ " x 20 $\frac{1}{16}$ " x 35"
16 RE-166/FRA-11	3 $\frac{1}{2}$ " x 9 $\frac{3}{4}$ " x 19"
3 AM-1043/FRA-11	5 $\frac{1}{4}$ " x 19" x 10 $\frac{1}{2}$ "
4 AM-1042/FRA-11	8 $\frac{3}{4}$ " x 19" x 14"
2 AM-1044/FRA-11	8 $\frac{3}{4}$ " x 19" x 13 $\frac{1}{2}$ "
3 PP-1143/FRA-11	7 $\frac{7}{8}$ " x 19" x 8 $\frac{3}{4}$ "
1 SB-390/FRA-11	7" x 19" x 13 $\frac{1}{2}$ "
2 PP-1142/FRA-11	8 $\frac{3}{4}$ " x 19" x 11 $\frac{1}{2}$ "
1 SB-389/FRA-11	5 $\frac{1}{4}$ " x 19" x 5 $\frac{1}{2}$ "

TUBES, CRYSTALS, TRANSISTORS:

REFERENCE DATA AND LITERATURE:

NAVSHIPS 92273.

RECEIVER CONTROL GROUP

AN/FRA-501, AN/FRA-501A

15 March 1962

Cog Serv: USN FSN: 5820-665-2574; 5820-543-1767

USA Line Item No:

USA USN USAF USMC

STATUS OR TYPE CLASS:

Manufacturer: CCLX (82679)

FUNCTIONAL DESCRIPTION:

These equipments provide a control facility for a communications receiver or other device that is remotely located, but controlled from a central point. The equipment provides up to 15 vernier and 10 ON-OFF control functions within the standard voice frequency band. Vernier control is accomplished by audio tone carriers generated at the control site and adjusted ± 42 cps (± 42.5 cps for AN/FRA-501A) around an assigned center frequency. These carriers are standard 170 cycle tone frequencies. The ON-OFF control functions are accomplished by turning the respective tones on or off. The variation of each tone around its assigned center frequency produces a proportionate DC potential variation at the remote site equipments. The use of this frequency dependent principle causes the system to be virtually unaffected by transmission line fluctuations and noise interference.

The AN/FRA-501 is mechanically and electrically interchangeable with the AN/FRA-501 except that input voltage of the power transformers has been raised from 220 volts to 230 volts.

RELATION TO SIMILAR EQUIPMENT:

TECHNICAL DESCRIPTION:

Frequency Range: 40-3000 cps.*Temperature Range:* 0° to 65° C.*Humidity:* Up to 100 percent.*Lines Required Between Sites:* 6 (one for each control, one for each audio return).*Rack Space:* Two 72-inch racks per site.*HFO Tuning:* Will vary receiver high frequency oscillator not less than ± 12 kc from center.*RF Gain:* Will vary RF gain from zero to full sensitivity.*BFO:* Will switch receiver BFO on or off.*Audio Filter:* Will effectively pass 500, 750, 1000, and 1250 cps notes to assist monitoring remote receiver.*Muting:* Rear panel control provides sidetone attenuation.*Operating Pwr Requirement:*

AN/FRA-501: 220 v, 60 cps, single phase.

AN/FRA-501A: 230 v, 60 cps, single phase.

Major Units:

5 C-5027 thru C-5031/FRA-501	7'' x 19'' x 7''	15 lbs
5 C-5027A thru C-5031A/FRA-501	7'' x 19'' x 7''	15 lbs
5 F-5006 thru F-5010/FRA-501	3½'' x 19'' x 7''	8 lbs
5 F-5006A thru F-5010A/FRA-501	3½'' x 19'' x 7''	8 lbs
11 PP-5030/FR()	3½'' x 19'' x 8½''	16 lbs
11 PP-5030A/FR()	3½'' x 19'' x 8½''	16 lbs
1 AM-5027/FRA-501	7'' x 19'' x 8¾''	16 lbs
1 AM-5027A/FRA-501	7'' x 19'' x 8¾''	16 lbs
5 CV-5013 thru	7'' x 19'' x 14¾''	33 lbs

RECEIVER CONTROL GROUP

AN/FRA-501, AN/FRA-501A

CV-5017/FRA-501
5 CV-5013A thru
CV-5017A/FRA-501

7" x 19" x 14 $\frac{3}{4}$ "

33 lbs

TUBES, CRYSTALS, TRANSISTORS:

REFERENCE DATA AND LITERATURE:

NAVSHIPS 92600(A),
NAVSHIPS 93238.

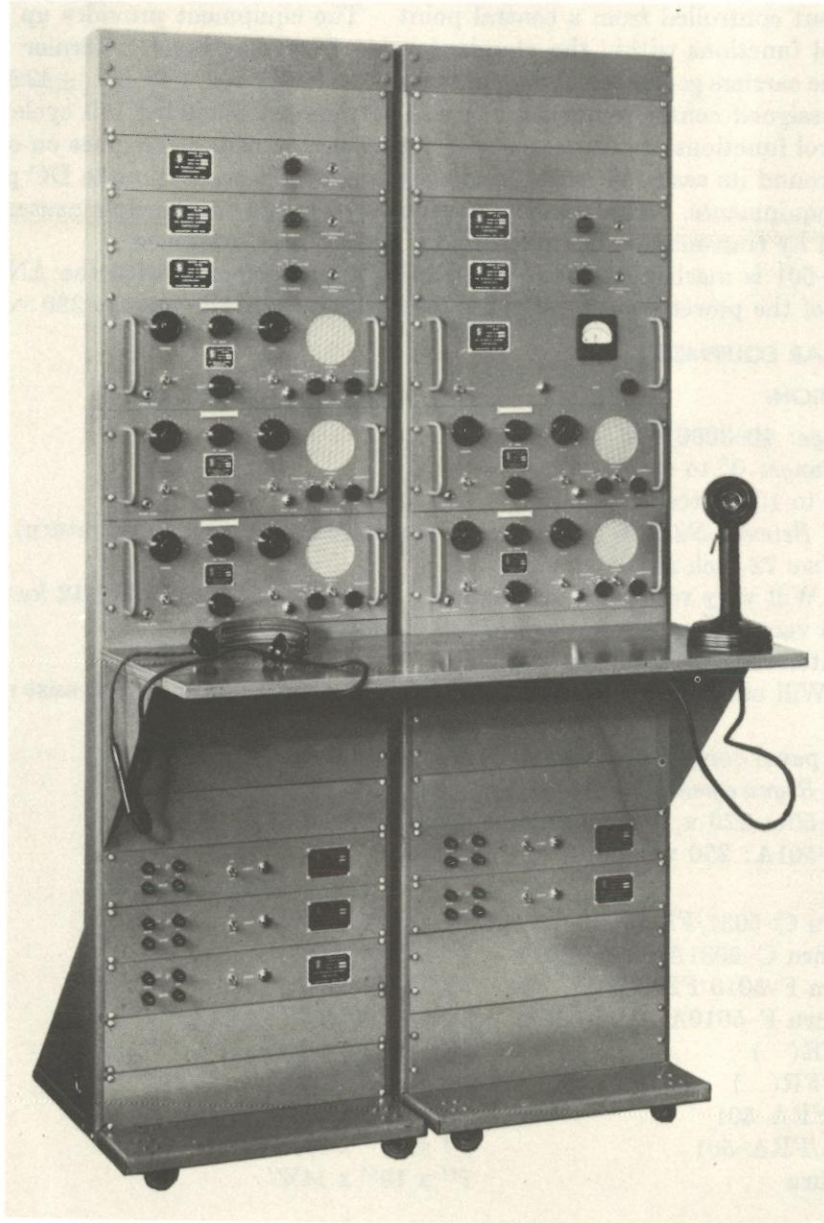

ANTENNA COUPLER
AN/FRA-type
CU-168/FRR

15 March 1962

Cog Serv: USN FSN: 5985-510-0006; 5985-644-3341

USA Line Item No: 601395 615150

	USA	USN	USAF	USMC
STATUS OR TYPE CLASS.:	Std-A		A/Std	
Manufacturer: COL (13499)				

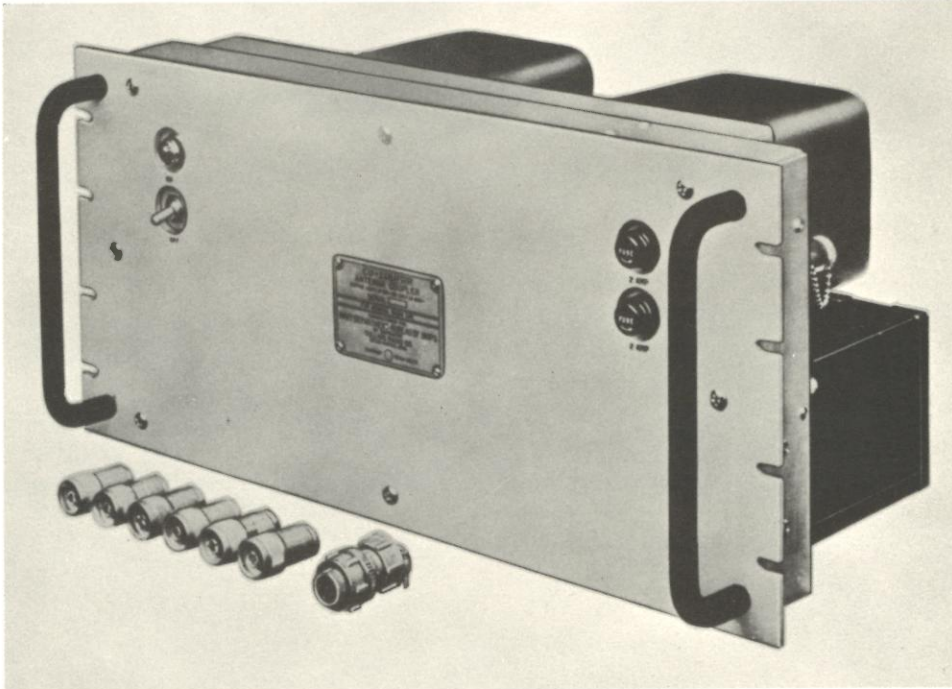
**FUNCTIONAL DESCRIPTION:**

The CU-168/FRR is a shore station equipment which provides means for operating up to five communication receivers from a single antenna. It is complete with power supply and contains all necessary parts to provide the specified performance. It is designed to be mounted in standard 19-inch electronic cabinets.

RELATION TO SIMILAR EQUIPMENT:**TECHNICAL DESCRIPTION:**

Frequency Range: 2 to 32 mc.

Input Impedance: 70 ohms.

Output Impedance: 70 ohms.

Number of Outputs: 5.

Operating Pwr Requirements: 105, 115, or 125 vac, 50 to 60 cps, single phase, 125 w.

Major Units: 1 CU-168/FRR 8 $\frac{3}{4}$ " x 19" x 12"

41 lbs

TUBES, CRYSTALS, TRANSISTORS:

REFERENCE DATA AND LITERATURE: NAVSHIPS 91697(A).

EXCITER UNIT
AN/FRA-type
0-5()/FR

1 March 1964

Cog Serv: USA FSN: 5820-194-9657; 5820-240-3899

USA Line Item No: 61550

	USA	USN	USAF	USMC
STATUS OR TYPE CLASS.:	Std-A		L/Std	

Manufacturer: Press Wireless, Inc.

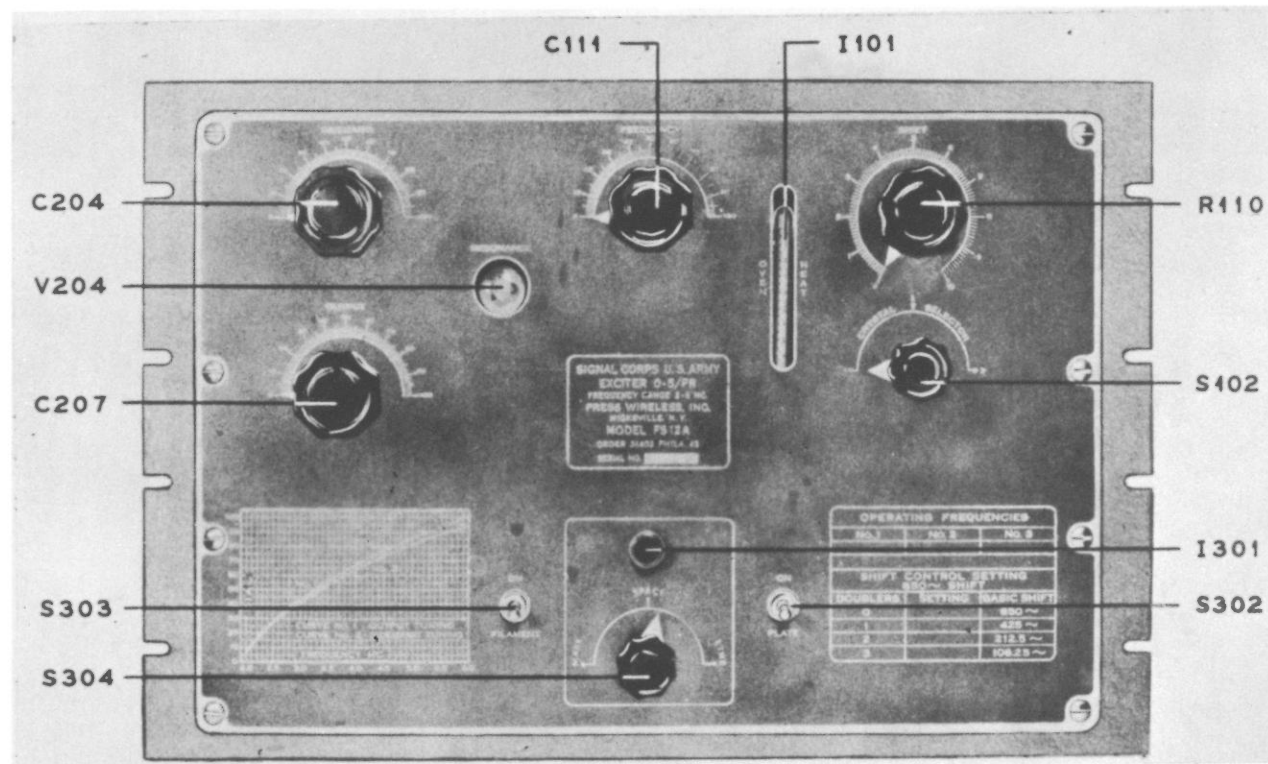
**FUNCTIONAL DESCRIPTION:**

Exciter Unit 0-5()/FR is a frequency-shift keying device. It generates a mark signal 425 cps above an assigned frequency upon closing a standard telegraph key and a space signal 425 cps below the assigned frequency upon opening the key.

Although designed primarily for radioteletype, the basic system of frequency-shift keying can be used on any radiotelegraph system having similarly keyed signal requirements.

The equipment is designed for mounting on a table or in a standard 19-inch relay rack.

RELATION TO SIMILAR EQUIPMENT:**TECHNICAL DESCRIPTION:**

Frequency Range: in Mc: 2 to 6.

Frequency Shift: 0 to 1000 cps positive.

Rf Output: 2 w (variable).

Rf Termination: Coaxial fitting.

EXCITER UNIT

AN/FRA-type
0-5()/FR

Pwr Requirements: 125 w, 110/220 v 50-60-cy 1-phase ac.

Major Units: 1 0-5()/FR $12\frac{1}{4}'' \times 12\frac{1}{2}'' \times 10''$

81 lbs

TUBES, CRYSTALS, TRANSISTORS:

REFERENCE DATA AND LITERATURE:

TM 11-2205.

RADIO SET
AN/FRC-6

1 March 1964
Cog Serv: USA FSN: 5820-192-7142
USA Line Item No: 638500

USA USN USAF USMC

STATUS OR TYPE CLASS.: Std-C

Manufacturer: International Telegraph & Telephone Corp.

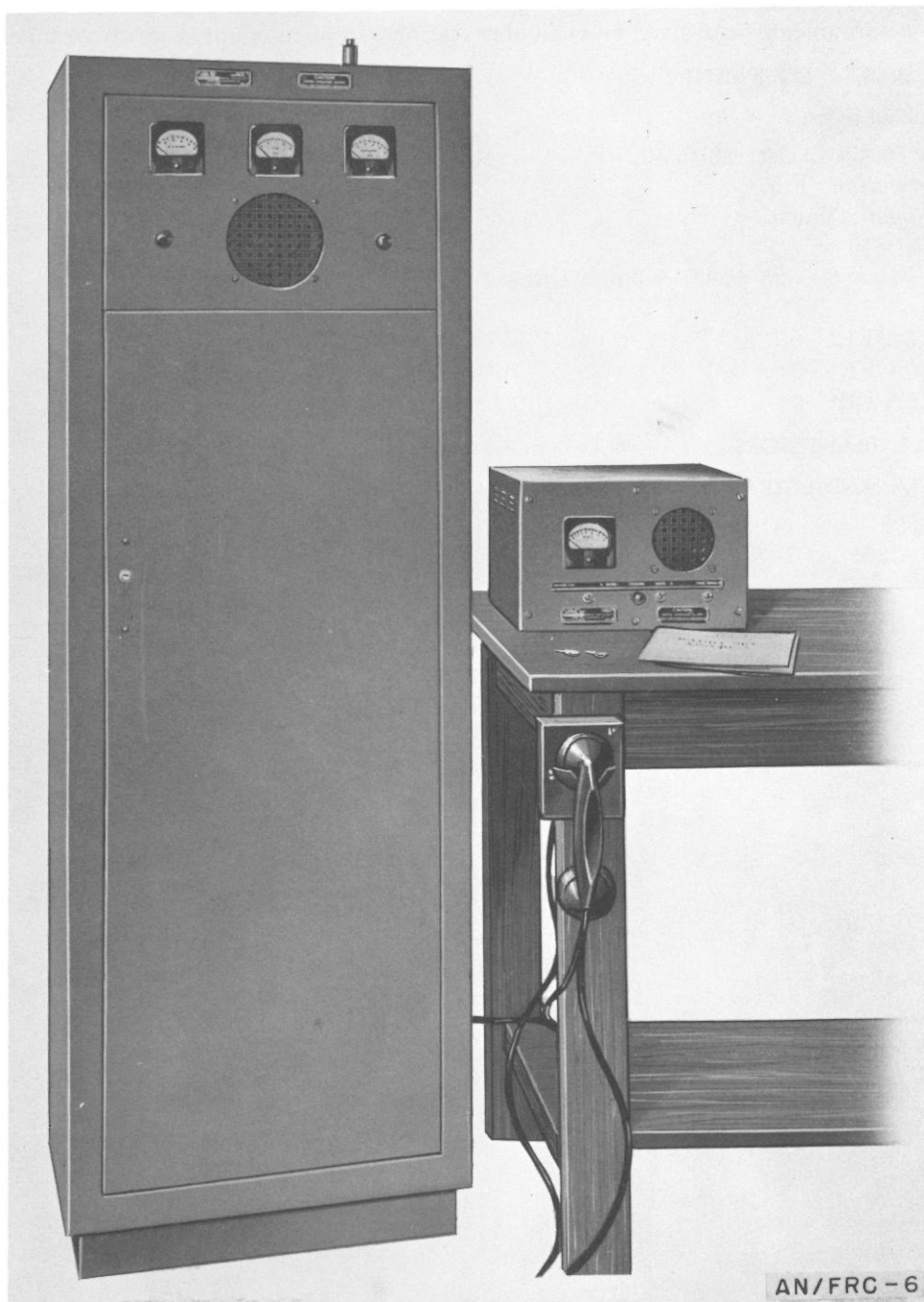

RADIO SET

AN/FRC-6**FUNCTIONAL DESCRIPTION:**

Radio Set AN/FRC-6 is a two-way, crystal-controlled, FM (voice) transmitting and receiving equipment used for communication in the vhf band by military police, security troops, and similar units.

The equipment consists of cabinet-inclosed, rack and panel-mounted equipment and includes a control console, handset, and associated accessories.

This set can be operated by remote control over a field telephone pair from a distance up to 10 miles and can communicate with fixed or vehicular stations, in open country up to 20 miles away.

RELATION TO SIMILAR EQUIPMENT:**TECHNICAL DESCRIPTION:**

Frequency Range in Mc: 30 to 40.

Type Modulation: Fm.

Type of Signal: Voice.

Pwr Output: 50 w.

Pwr Requirements: 325 w, 115 v 60-cy 1-phase ac.

Major Units:

R-276A/FRC-6	9' x 9' x 18½''	21 lbs
C-560A/FRC-6	5¼' x 6' x 18½''	9 lbs
T-215A/FRC-6	9' x 9' x 18½''	38 lbs

TUBES, CRYSTALS, TRANSISTORS:**REFERENCE DATA AND LITERATURE:**

TM 11-5506.

(USA) 71-3291.

1 March 1964

Cog Serv: USA FSN: 5820-188-6177
 USA Line Item No: 638800

RADIO SET

AN/FRC-10

	USA	USN	USAF	USMC
STATUS OR TYPE CLASS.:	Std-B	Std	Std	
Manufacturer: Western Electric Co.				

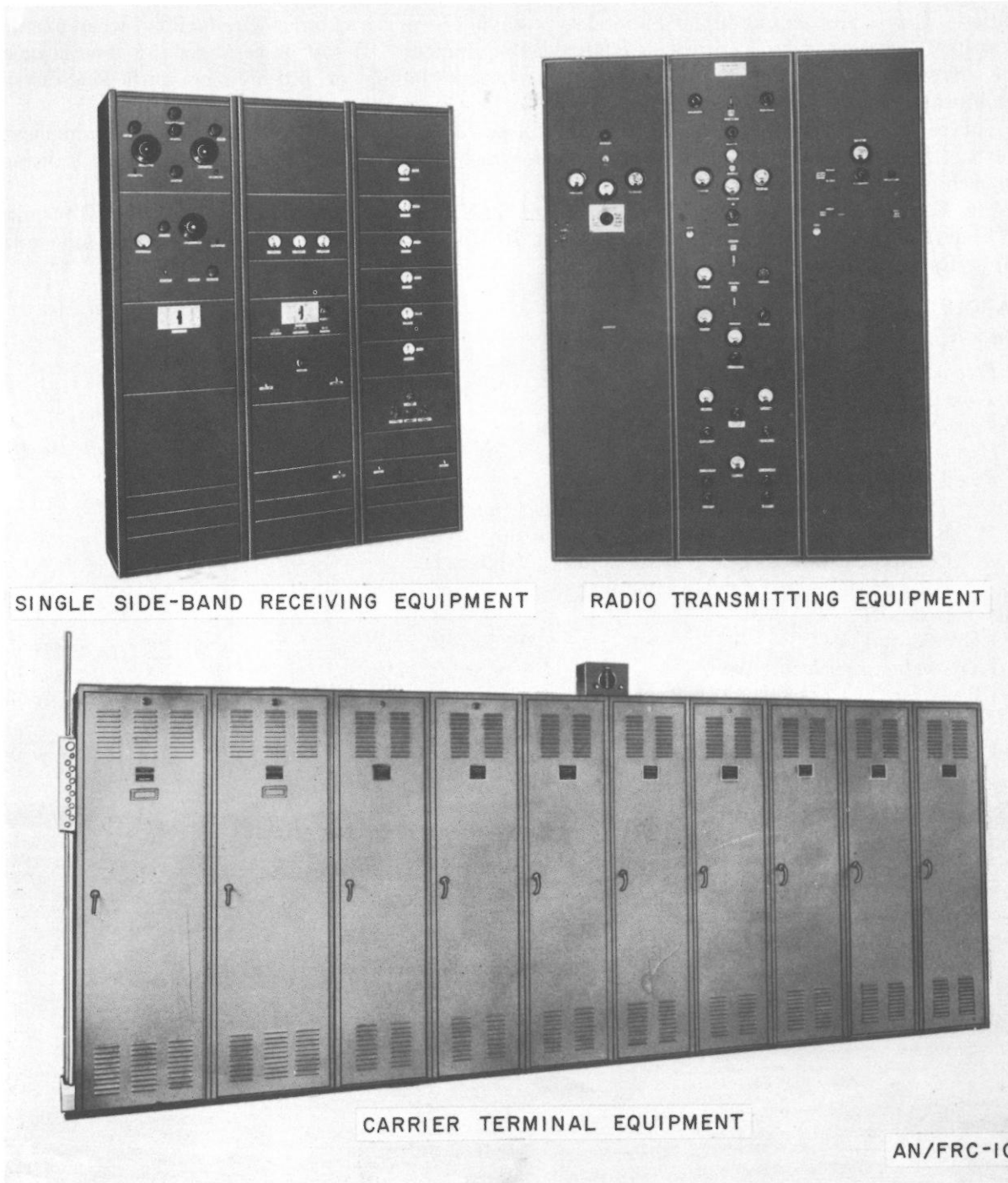

SINGLE SIDE-BAND RECEIVING EQUIPMENT

RADIO TRANSMITTING EQUIPMENT

CARRIER TERMINAL EQUIPMENT

AN/FRC-10

RADIO SET

AN/FRC-10**FUNCTIONAL DESCRIPTION:**

Radio Set AN/FRC-10 is a high-power, hf, long range, AM (voice, and tone) radioteletype communication equipment used in long distance, fixed-plant applications.

This equipment consists of a single-sideband radio transmitter, radio receiver, and carrier terminal facilities. It provides six full duplex radioteletype channels (plus a vf order-wire facility) when operated in a system terminated by identical or equivalent equipment. It can be arranged for double modulation diversity operation when required to overcome fading or interference with long-distance communication.

This set requires elaborate antenna arrays, and power is provided by 5-kw field power units located at each of the sites of the operating components, which usually are displaced a considerable distance from each other.

The U.S. Navy radio transmitting equipment TEF is essentially the same as Radio Transmitter WECO D156000, which is part of this set; Radio Receiver REA (USN) is essentially the same equipment as Radio Receiver WECO D-99945.

RELATION TO SIMILAR EQUIPMENT:**TECHNICAL DESCRIPTION:**

Frequency Range in Mc: 4.5 to 22.

Type Modulation: Am (single-sideband).

Type of Signal: Voice and tone.

Pwr Output: 2 kw (peak envelope).

Pwr Requirements:

Transmitter: 5 kw, 220-v 50/60-cy 3-phase ac.

Receiver: 500 w, 115-v 50/60-cy 1-phase ac.

Carrier Terminals: 3 kw, 115-v 50/60-cy 1-phase ac.

Distortion Measuring Bay: 250 w, 115-v 50/60 cy 1-phase ac.

Major Units:

1 OA-63 and -64/FRC-10	220 $\frac{1}{4}$ " x 84" x 17"	5,260 lbs
1 Distortion measuring bay	22" x 84" x 17"	350 lbs
1 Receiver WECO D-99945 or R-369() /FRC-10	65 $\frac{1}{2}$ " x 84" x 18 $\frac{1}{4}$ "	1,440 lbs
1 Transmitter WECO D-156000	60 $\frac{1}{4}$ " x 88" x 30"	2,400 lbs

TUBES, CRYSTALS, TRANSISTORS:**REFERENCE DATA AND LITERATURE:**

TM 11-2132, TM 11-832, TM 11-884.
(USA) 89067-89080.

1 March 1964

Cog Serv: USA FSN: 5820-193-7099

USA Line Item No.:

RADIO SET

AN/FRC-10A

	USA	USN	USAF	USMC
STATUS OR TYPE CLASS.:	Std-B	Std		

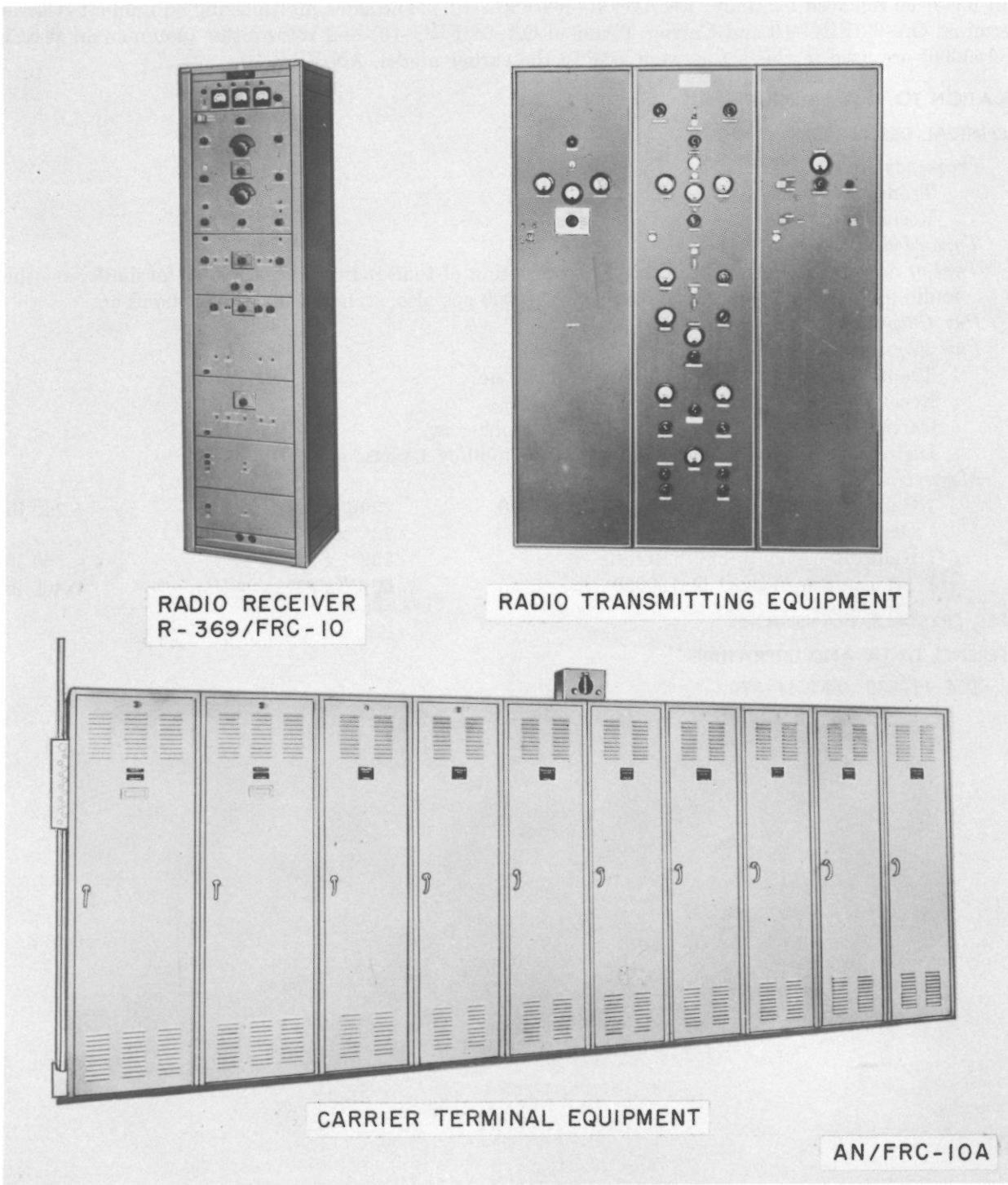

RADIO RECEIVER
R-369/FRC-10

RADIO TRANSMITTING EQUIPMENT

CARRIER TERMINAL EQUIPMENT

AN/FRC-10A

RADIO SET

AN/FRC-10A

FUNCTIONAL DESCRIPTION:

Radio Set AN/FRC-10A is an improved version of Radio Set AN/FRC-10; the commercial receiver unit has been replaced by Radio Receiver R-369/FRC-10. The same multiplexing equipment (Carrier Terminal OA-63/FRC-10 and Carrier Terminal OA-64/FRC-10) and transmitter (commercial WECO D-156000) are used in this set as were used in the earlier model, AN/FRC-10.

RELATION TO SIMILAR EQUIPMENT:

TECHNICAL DESCRIPTION:

Frequency Range in Mc:

Transmitter: 4.5 to 22.

Receiver: 4 to 28.

Type Modulation: am.

Type of Signal: Composite transmissions consisting of tone-radioteletype, voice, facsimile, or other audio frequencies in the range from 100 to 6,000 cps also, standard double-sideband am.

Pwr Output: 2 kw (peak envelope).

Pwr Requirements:

Transmitter: 5 kw, 220-v 50/60 cy 3-phase ac.

Receiver: 500 w, 115-v 50-60-cy 1-phase ac.

Carrier terminals: 3 kw, 115-v 50/60-cy 1-phase ac.

Distortion Measuring Bay: 250 w, 115-v 50/60-cy 1-phase ac.

Major Units:

1 Carrier Terminal OA-63 and -64/FRC-10

220¹/₄" x 84" x 17"

5,260 lbs

1 Distortion measuring equipment

22" x 84" x 17"

550 lbs

1 Radio Receiver R-369/FRC-10

22¹/₂" x 84" x 17"

2,400 lbs

1 Transmitter WECO D-156000

60³/₄" x 88" x 30"

TUBES, CRYSTALS, TRANSISTORS:

REFERENCE DATA AND LITERATURE:

TM 11-832, TM 11-870.

1 March 1964
 Cog Serv: USA FSN: 5820-186-9264
 USA Line Item No:

RADIO SET
AN/FRC-10B

STATUS OR TYPE CLASS.:	USA	USN	USAF	USMC
	Std-B	Std		

Manufacturer:

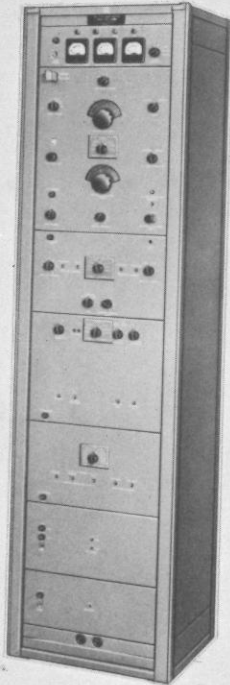

RADIO RECEIVER R-369/FRC-10

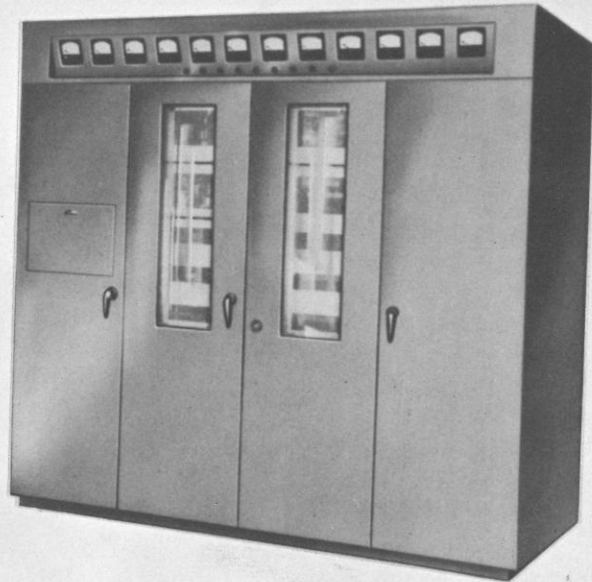

RADIO TRANSMITTER T-265/FRC-10



CARRIER TERMINAL EQUIPMENT

AN/FRC-10B

RADIO SET

AN/FRC-10B

FUNCTIONAL DESCRIPTION:

Radio Set AN/FRC-10B is an improved version Radio Set AN/FRC-10; the commercial transmitter and receiver units have been replaced by Radio Transmitter T-265/FRC-10 and Radio Receiver R-369/FRC-10. The same multiplexing equipment (Carrier Terminal OA-63/FRC-10 and Carrier Terminal OA-64/FRC-10) is used in all models of the AN/FRC-10().

RELATION TO SIMILAR EQUIPMENT:

TECHNICAL DESCRIPTION:

Frequency Range in Mc:

Transmitter: 4 to 23.

Receiver: 4 to 28.

Type Modulation: Am.

Type of Signals: Composite transmission consisting of tone-radioteletype, voice, facsimile, or other audio frequencies in the range from 100 to 6,000 cps; also, standard double-sideband am.

Pwr Output: 4 kw (ssb peak envelope power), 1 kw (dsb carrier).

Pwr Requirements:

Transmitter: 10 kw, 230-v 50/60-cy 3-phase ac.

Receiver: 500 w, 50-60-cy 1-phase ac.

Carrier terminals: 3 kw, 115-v 50/60-cy 1-phase ac.

Distortion measuring bay: 250 w, 115-v 50/60-cy 1-phase ac.

Major Units:

1 OA-63 and 64/FRC-10 and	220 $\frac{1}{4}$ " x 84" x 17"	5,260 lbs
1 OA-64/FRC-10	22" x 84" x 17"	
1 Distortion Measuring Equipment	22 $\frac{1}{2}$ " x 84" x 17"	550 lbs
1 R-369/FRC-10	84" x 84" x 42 $\frac{1}{2}$ "	5,800 lbs
1 T-265/FRC-10		

TUBES, CRYSTALS, TRANSISTORS:

REFERENCE DATA AND LITERATURE:

TM 11-814, TM 11-870.

1 March 1964

Cog Serv: USA FSN: 5820-537-3997

USA Line Item No: 638890

RADIO SET
AN/FRC-15

USA USN USAF USMC

STATUS OR TYPE CLASS.:

Std-A

Manufacturer: Motorola, Inc.

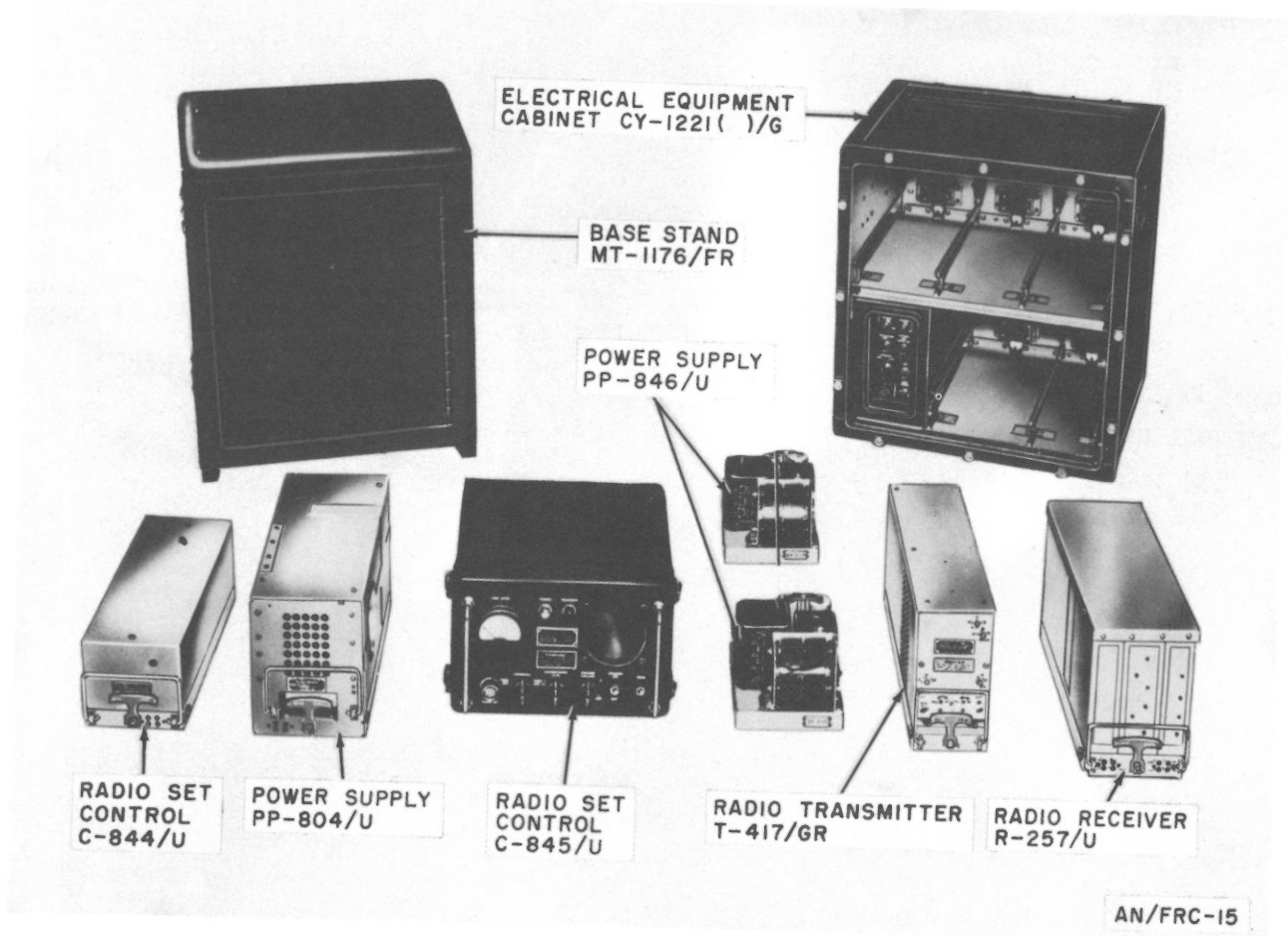
**FUNCTIONAL DESCRIPTION:**

Radio Set AN/FRC-15 is a vhf, FM, low-powered radio receiving and transmitting equipment used in tactical and nontactical communication applications.

This equipment consists of receiver and transmitter components, local and remote-control units, equipment cabinet and base, related power supplies, and accessories.

It can be operated in simplex, duplex, and retransmission applications. Push-to-talk operation over either of two preset frequencies is provided either locally or at a maximum distance of 10 miles from the transmitter site. Duplex operation requires an additional antenna and can be conducted from the local operating site only. The remote-control unit can be used to transmit tone signals for transmitter adjustment and signaling, to monitor reception, and to intercommunicate between the set and the remote point.

RADIO SET

AN/FRC-15

RELATION TO SIMILAR EQUIPMENT:

TECHNICAL DESCRIPTION:

Frequency Range in Mc: 25 to 50.

Type Modulation: Fm.

Type of Signal: Voice.

Pwr Output: 0.5 w (rcvr); 45 w (xmtr).

Pwr Requirements:

PP-804/U: 230 va, 115/230-v 50-65-cy ac.

PP-846/U: 46 va, 115/230-v 50-65-cy ac.

Major Units:

1 PP-804/U	8 $\frac{5}{8}$ " x 7" x 14 $\frac{1}{2}$ "	40 lbs
2 PP-846/U	5 $\frac{1}{8}$ " x 6 $\frac{1}{4}$ " x 7 $\frac{1}{16}$ "	10.5 lbs
1 R-257/U	8 $\frac{1}{2}$ " x 14 $\frac{1}{2}$ " x 5 $\frac{3}{4}$ "	19 lbs
1 C-844/U	8 $\frac{3}{4}$ " x 14 $\frac{3}{4}$ " x 5 $\frac{7}{8}$ "	6.5 lbs
1 C-845/U	8 $\frac{7}{16}$ " x 13 $\frac{3}{4}$ " x 13 $\frac{1}{2}$ "	17.5 lbs
1 T-417/GR	8 $\frac{1}{2}$ " x 14 $\frac{1}{2}$ " x 4 $\frac{1}{2}$ "	9 lbs

TUBES, CRYSTALS, TRANSISTORS:

REFERENCE DATA AND LITERATURE:

TM 11-282.

MIL-R-11539A.

RADIO-TELEPHONE TERMINAL SET

AN/FRC-23()

RADIO REPEATER SET

AN/FRC-26()

1 March 1964

Cog Serv: USA FSN: 5820-399-7166 5820-399-7168

USA Line Item No.: 657220 636340

	USA	USN	USAF	USMC
STATUS OR TYPE CLASS:	Std-C			

Manufacturer: General Electric Co.

No illustration available.

FUNCTIONAL DESCRIPTION:

Radio-Telephone Terminal Set AN/FRC-23 and Radio Repeater Set AN/FRC-26 are fixed plant' pm microwave radio transmitting and receiving sets that are the system terminal and repeater elements' respectively, of a 24-channel, simultaneous two-way, point-to-point communications system.

Radio-Telephone Terminal Set AN/FRC-23 consists essentially of the normal transmitter and receiver components plus a standby or spare transmitter and a diversity receiver that can be used as a spare, and antenna, multiplexing, testing, and associated items.

Radio Repeater Set AN/FRC-26 is composed essentially of the same primary operating components arranged for operation at intermediate points of a system to extend its effective range. Additional components are provided to insure 24-hour-per-day operation.

These sets can be adjusted to operate in conjunction with Radio Repeater Set AN/FRC-34 and Radio Set AN/FRC-35, after rearrangement of components and interconnections.

RELATION TO SIMILAR EQUIPMENT:**TECHNICAL DESCRIPTION:**

Frequency Range in Mc: 1,700 to 1,850.

Type Modulation: Pulse.

Type Signal: 24-channel voice.

Pwr Output: 10 w.

Pwr Requirements: 2,400 w, 117-v ($\pm 5\%$) 50/60-cy ac.

Major Units: This set is normally procured as a complete unit for specific application; components may vary in accordance with system requirements.

TUBES, CRYSTALS, TRANSISTORS:**REFERENCE DATA AND LITERATURE:**

TM 11-222, TM 11-222A.

1 March 1964
 Cog Serv: USA FSN: 5820-503-1127
 USA Line Item No: 639090

RADIO SET
AN/FRC-27()

	USA	USN	USAF	USMC
STATUS OR TYPE CLASS.:	Std-A		Std	

Manufacturer: Motorola, Inc.

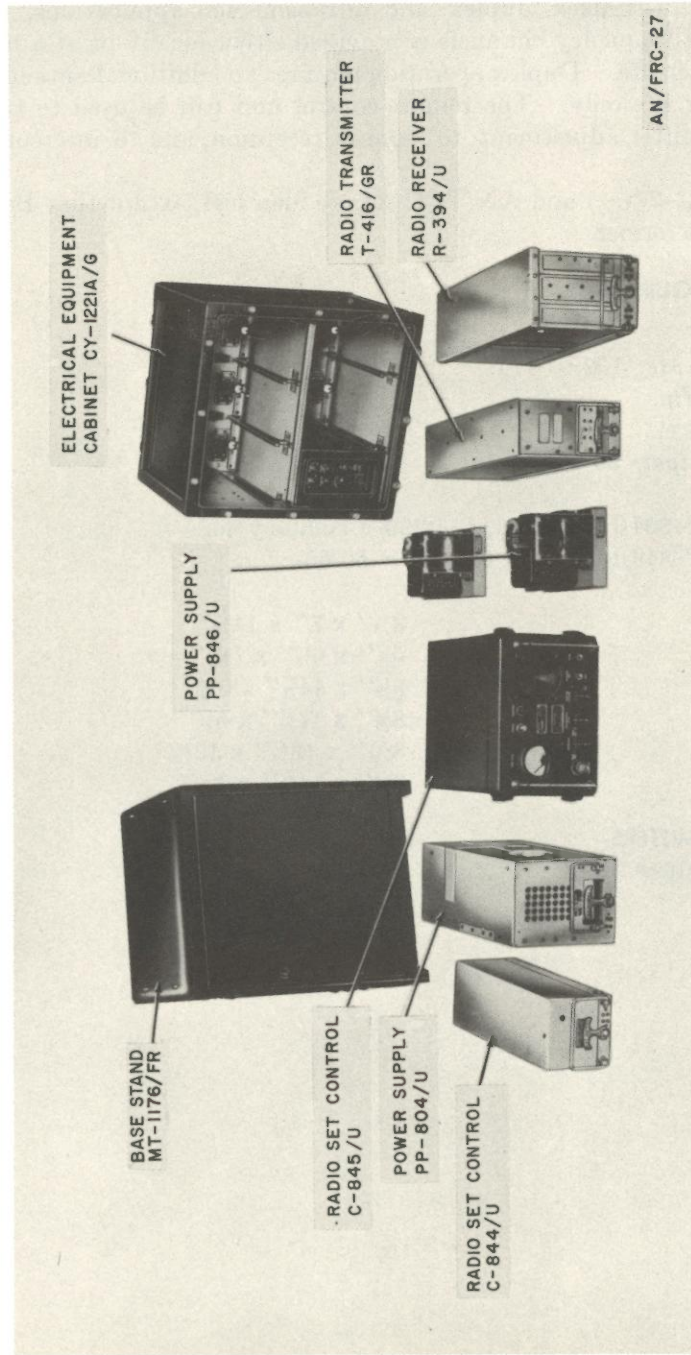

RADIO SET

AN/FRC-27()

FUNCTIONAL DESCRIPTION:

Radio Set AN/FRC-27() is a vhf, FM, low-powered radio receiving and transmitting equipment used in fixed communication applications.

This equipment consists of receiver and transmitter components, local and remote-control units, equipment cabinet and base, related power supplies, and accessories.

It can be operated in simplex, duplex, and retransmission applications. Push-to-talk operation over either of two preset frequency channels is provided either locally or at a maximum distance of 10 miles from the transmitter site. Duplex operation requires an additional antenna and can be conducted from the local operating site only. The remote-control unit can be used to transmit tone signals for signaling and for transmitter adjustment, to monitor reception, and to intercommunicate between the remote point and the set.

Radio Sets AN/FRC-27() and AN/TRC-34 are identical, except that Base Stand MT-1176/FR is supplied only with the former.

RELATION TO SIMILAR EQUIPMENT:

TECHNICAL DESCRIPTION:

Frequency Range in Mc: 152 to 174.

Type Modulation: Fm.

Type of Signal: Voice.

Transmitter Pwr Output: 50 w.

Pwr Requirements:

Pwr Supply PP-804/U; 230 va, 115/230-v 50/60-cy ac.

Pwr Supply PP-846/U; 46 va, 115/230-v 50/60-cy ac.

Major Units:

1 PP-804/U	8 $\frac{5}{8}$ " x 7" x 14 $\frac{1}{2}$ "	40 lbs
2 PP-846/U	5 $\frac{1}{8}$ " x 6 $\frac{1}{4}$ " x 7 $\frac{1}{16}$ "	10 lbs
1 R-394/U	8 $\frac{1}{2}$ " x 14 $\frac{1}{2}$ " x 5 $\frac{3}{4}$ "	19 lbs
1 C-844/U	8 $\frac{3}{4}$ " x 17 $\frac{3}{4}$ " x 5 $\frac{7}{8}$ "	10 lbs
1 C-845/U	8 $\frac{7}{16}$ " x 13 $\frac{3}{4}$ " x 13 $\frac{1}{2}$ "	17.5 lbs
1 T-416/GR	8 $\frac{1}{2}$ " x 14 $\frac{1}{2}$ " x 4 $\frac{1}{2}$ "	9 lbs

TUBES, CRYSTALS, TRANSMITTERS:

REFERENCE DATA AND LITERATURE:

TM 11-226.

MIL-N-11539A.

RADIO SET

AN/FRC-31()

1 March 1964

Cog Serv: USA FSN: 5820-567-2362

USA Line Item No.: 639290

	USA	USN	USAF	USMC
STATUS OR TYPE CLASS.:	Std-C			

Manufacturer: Motorola, Inc.

No illustration available.

FUNCTIONAL DESCRIPTION:

Radio Set AN/FRC-31() is a general-purpose, vhf, fm (voice or tone) radio receiving and transmitting equipment used for nontactical, fixed-plant communication applications in the field by military police, Transportation Corps, and similar operations. It is operated from a console, which can be set up at a maximum distance of 10 miles from the rest of the equipment.

This equipment consists essentially of an antenna used for both transmission and reception, the operating console, and an equipment cabinet that houses the transmitter, receiver, power supply, control unit, and ac panel. The equipment cabinet is weatherproof, and may be installed outdoors.

This set has facilities for transmitting and receiving on either of two pairs of crystal-controlled frequencies to enable communication with groups of vehicles, in a typical application, over one pair of frequencies while communication is maintained over the other pair of frequencies with other fixed stations.

RELATION TO SIMILAR EQUIPMENT:

TECHNICAL DESCRIPTION:

Frequency Range:

Transmitter: 2 channels within 240 kc of each other, 152 to 174 mc.

Receiver: 2 channels within 180 kc of each other, 152 to 174 mc.

Antenna: 162 to 174 mc.

Type Modulation: FM.*Type of Signal:* Voice or tone.*Pwr Output:* 50 w (167 to 174 mc); 60w (152 to 167 mc).*Pwr Requirements:* 50 w (console), 115 w standby or 480 w transmitting (power supply); 117-v 60-cy 1-phase ac.*Major Units:*

1 PP-966/FRC-31	7¼'' x 6¼'' x 19''	42 lbs
1 R-565/FRC-31	5¼'' x 4⅞'' x 16½''	9 lbs
1 T-413/FRC-31	5¼'' x 4⅞'' x 16½''	6.5 lbs

TUBES, CRYSTALS, TRANSISTORS:

REFERENCE DATA AND LITERATURE:

TM 11-234.

RADIO REPEATER SET
AN/FRC-34

1 March 1964
 Cog Serv: USA FSN: 5820-503-1229
 USA Line Item No: 636345

	USA	USN	USAF	USMC
STATUS OR TYPE CLASS.:	Std-B			

Manufacturer: General Electric Corp.

No illustration available.

FUNCTIONAL DESCRIPTION:

Radio Repeater Set AN/FRC-34 is the relay station equipment in an unattended fixed plant type of microwave radio-relay system operating in the 1,700- to 1,850-mc range. The system provides two-way communication for up to 24 voice channels. This equipment, along with Radio Telephone Terminal Sets AN/FRC-35, is specially procured in complete system groups.

This equipment receives the signals transmitted by Radio Set AN/FRC-35, amplifies them, reshapes the pulses, and retransmits the composite signal. It consists primarily of three transmitters and three receivers (two in operation, one standby spare) and associated equipments. In addition to standard voice communication circuits, the system provides for the transmission of teletypewriter, telemetering, supervisory control, and similar functions.

RELATION TO SIMILAR EQUIPMENT:

TECHNICAL DESCRIPTION:

Frequency Range in Mc: 1,700 to 1,850.

Type Modulation: Ppm.

Type of Signal: Voice, teletypewriter, telemeter, video, etc.

Number of Channels: 24 voice (max).

Pwr Output: 10 w (peak).

Pwr Requirements: 1,700 w, 117-v ($\pm 5\%$) 50/60-cy ac.

Major Units: (Quantities and items of specific components vary in accordance with channeling requirements of system.)

TUBES, CRYSTALS, TRANSISTORS:

REFERENCE DATA AND LITERATURE:

TM 11-222B.

GE: MIL-766-8503G1.

RADIO TELEPHONE TERMINAL SET

AN/FRC-35

1 March 1964

Cog Serv: USA FSN: 5820-503-1134

USA Line Item No: 639390

	USA	USN	USAF	USMC
STATUS OR TYPE CLASS.:	Std-B			

Manufacturer: General Electric Corp.

No illustration available.

FUNCTIONAL DESCRIPTION:

Radio Telephone Terminal Set AN/FRC-35 is the terminal radio and multiplexing equipment used in a fixed-plant microwave multichannel radiotelephone system. The system provides two-way communication over a maximum of 24 voice channels. This equipment, along with Radio Repeater Set AN/FRC-34, is procured in complete system groupings for specific applications.

This equipment consists primarily of two microwave radio transmitters and two receivers (one of each in use and the others as standby spares) and 24-channel telephone pulse-position multiplexing equipment.

In addition to the 24 voice channels, this equipment provides for the transmission of teletypewriter, telemetering, supervisory control, and other similar functions. Special fault-indicating devices at the unattended repeater stations are received by, translated in, and displayed or recorded at this terminal equipment, thus providing constant operational control over the distant repeater stations.

RELATION TO SIMILAR EQUIPMENT:**TECHNICAL DESCRIPTION:***Frequency Range in Mc:* 1,700 to 1,850.*Type Modulation:* Ppm.*Type of Signal:* Voice, teletypewriter, telemeter, video, etc.*Number of Channels:* 24 voice (max).*Pwr Output:* 10 w.*Pwr Requirements:* 3,000 w, 117-v ($\pm 5\%$) 50/60-cy ac.*Major Units:* (Quantities and items of specific components vary in accordance with channeling requirements of system.)**TUBES, CRYSTALS, TRANSISTORS:****REFERENCE DATA AND LITERATURE:**

TM 11-222B.

GE: NO. MIL-766-8503G1.

21 November 1958
 Cog Serv: USAF FSN:
 USA Line Item No:

RADIO SET
AN/FRC-39(V)

USA USN USAF USMC

STATUS OR TYPE CLASS.:

L/Std

Manufacturer: Radio Corporation of America

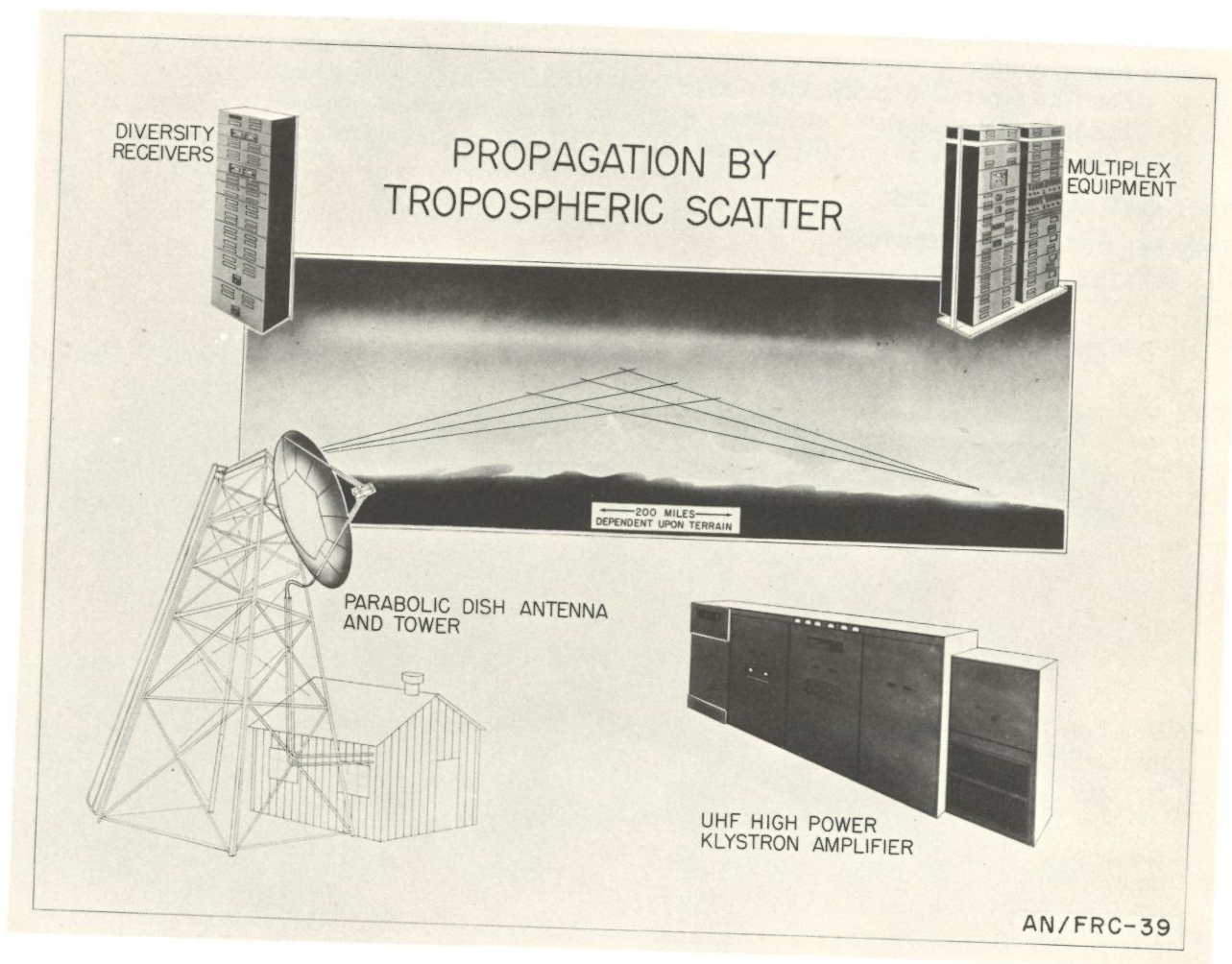

FUNCTIONAL DESCRIPTION:

Radio Set AN/FRC-39(V) is designed to function as a terminal station and provides transmission and reception of multichannel voice as well as data signals. It consists of variable components both as to type and quantity, the selection of which depends upon the installation.

Application in pairs provides facilities for a repeater station. When additional sets are added to a repeater station, these provide branching facilities.

This equipment will operate with multiplex equipment to provide up to 72 simultaneous transmission channels.

It is used mainly for transmission of Air Defense Command tactical and administrative communications traffic.

RADIO SET

AN/FRC-39(V)

RELATION TO SIMILAR EQUIPMENT:

TECHNICAL DESCRIPTION:

Frequency Range in Mc: 400 to 2,400.

Operational Range: Over-the-horizon transmission.

Type Emission: F9 (fm); response ± 2 db from 0.25 to 340 kc.

Pwr Output: 1 kw or 10 kw.

Pwr Requirements:

For 1-kw Operation: 4 kw, 208-v $\pm 10\%$ 50- to 63-cy 4-wire 3-phase ac.

For 10-kw Operation: 34 kw, 208-v $\pm 10\%$ 50- to 63-cy 4-wire 3-phase ac.

Major Units: (Type and quantity depend upon installation requirements.)

TUBES, CRYSTALS, TRANSISTORS:

REFERENCE DATA AND LITERATURE:

TO 31R5-2FRC39-(series).

24 November 1958
 Cog Serv: USAF FSN:
 USA Line Item No:

RADIO SET
AN/FRC-45(V)

USA USN USAF USMC

STATUS OR TYPE CLASS.:

L/Std

Manufacturer: Western Electric Co., Inc.

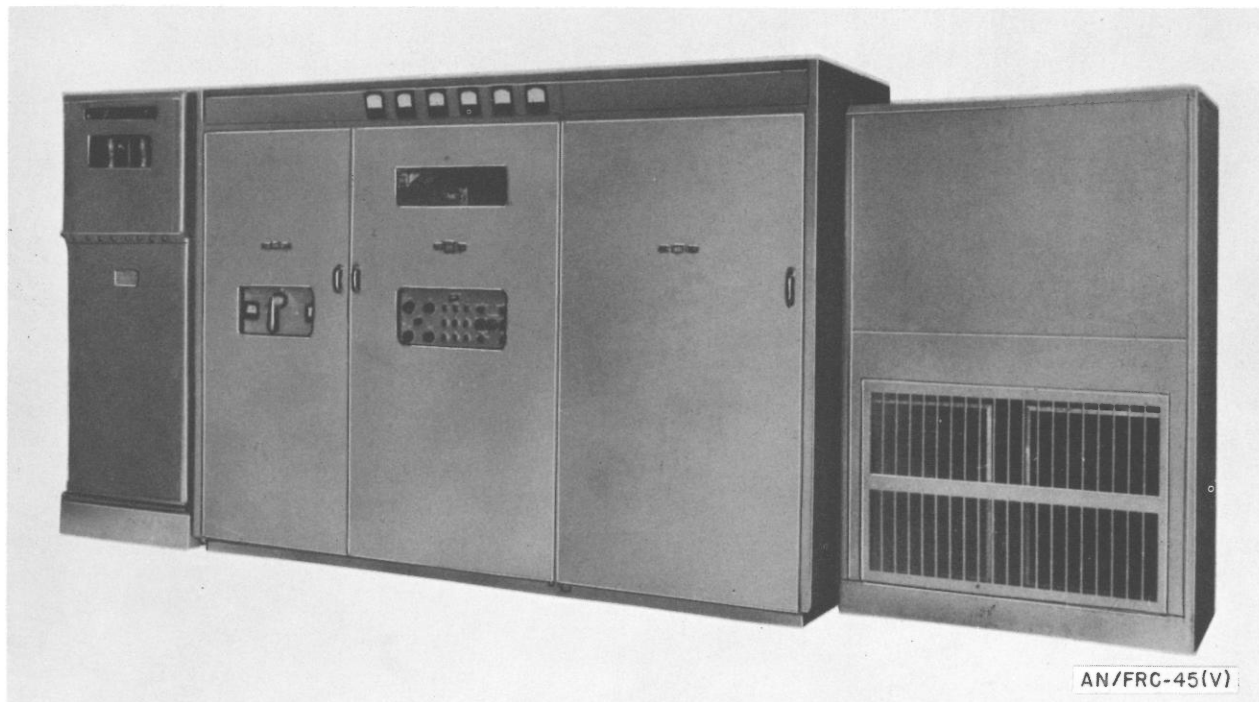

AN/FRC-45(V)

FUNCTIONAL DESCRIPTION:

Radio Set AN/FRC-45(V) is designed to function as a terminal station providing transmission and reception of multichannel voice and data signals. In pairs, these sets provide facilities for a repeater station. By adding sets to a repeater station, branching facilities are provided.

This equipment consists of variable components both as to type and quantity; selection of specific items depends upon the installation desired.

Application is in a tropospheric forward scatter system and a fixed ground installation.

RELATION TO SIMILAR EQUIPMENT:

TECHNICAL DESCRIPTION:

Frequency Range in Mc: 755 mc to 985; 1 band.

Type Emission: Fm, F9.

Pwr Output: 1 kw or 10 kw (nominal).

Number of Channels: 24-teletypewriter.

Pwr Requirements: For more than 2 kw, 208-v 60-cy 3-phase ac; for less than 2 kw, 120-v 60-cy 1-phase ac.

Major Units: (Type and number depend on installation requirements.)

TUBES, CRYSTALS, TRANSISTORS:

REFERENCE DATA AND LITERATURE:

GS-18074.

RADIO SET
AN/FRC-47

24 November 1958
 Cog Serv: USN FSN:
 USA Line Item No:

	USA	USN	USAF	USMC
STATUS OR TYPE CLASS.:				Tent-Std

Manufacturer:

No illustration available.

FUNCTIONAL DESCRIPTION:

Radio Set AN/FRC-47 is a communication equipment employing the tropospheric forward scatter technique. It provides 12 multiplexed voice channels.

Used in pairs, this radio set provides facilities for a repeater station.

RELATION TO SIMILAR EQUIPMENT:**TECHNICAL DESCRIPTION:**

Frequency Range in Mc: 300 to 400; 1 band; 12 channels.

Type Emission: A3a.

Transmitter Pwr Output: 50 kw.

Pwr Requirements: 280-v 60-cy 3-phase ac.

Major Units:

TUBES, CRYSTALS, TRANSISTORS:**REFERENCE DATA AND LITERATURE:**

RADIO SET
AN/FR-56(V)

24 November 1958
 Cog Serv: USAF FSN: 5820-607-9492
 USA Line Item No.:

USA	USN	USAF	USMC
-----	-----	------	------

STATUS OR TYPE CLASS.:

Std

Manufacturer: Radio Corporation of America

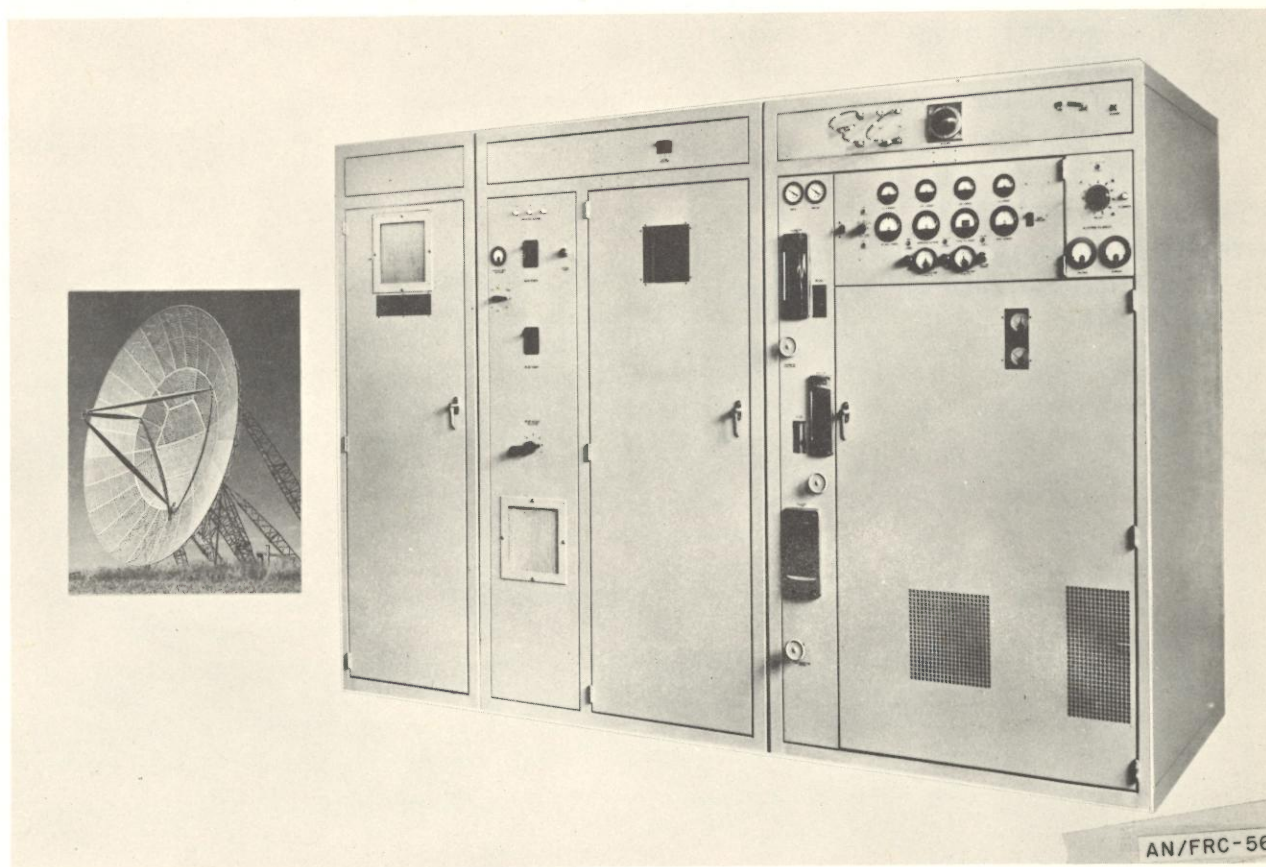
**FUNCTIONAL DESCRIPTION:**

Radio Set AN/FRC-56(V) is designed to function as a terminal station that provides transmission and reception of multichannel voice and data signals. It is used mainly for transmission of Air Defense Command tactical and administrative communications traffic.

This equipment consists of variable components both as to type and quantity. The selection of specific number and type of items depends on the installation requirements.

Employed in pairs, these sets provide facilities for a repeater station. When additional sets are added to a repeater station they provide branching facilities.

RADIO SET

AN/FR-56(V)

RELATION TO SIMILAR EQUIPMENT:

TECHNICAL DESCRIPTION:

Frequency Range in Mc: 1,700 to 2,400; single band.

Type Emission: Fm (F9).

Frequency-division Multiplexer: Up to 72 voice channels.

Pwr Output: k kw or 10 kw (max).

Pwr Requirements: For more than 2 kw, 208-v 60-cy 3-phase ac or for less than 2 kw, 115-v 60-cy 1-phase ac.

Major Units:

1 ea AN/TCC-32 or

AN/TCC-3.

AN/TCC-20 or

AN/TCC-7.

AN/TCC-20.

TUBES, CRYSTALS, TRANSISTORS:

REFERENCE DATA AND LITERATURE:

TO 31R5-2FRC39 and 56() (pending).

RADC-2425A.

15 March 1962
Cog Serv: USN FSN: 5820-673-0955
USA Line Item No:

RADIO SET
AN/FRC-70A

USA USN USAF USMC

STATUS OR TYPE CLASS.:

Manufacturer: CCI

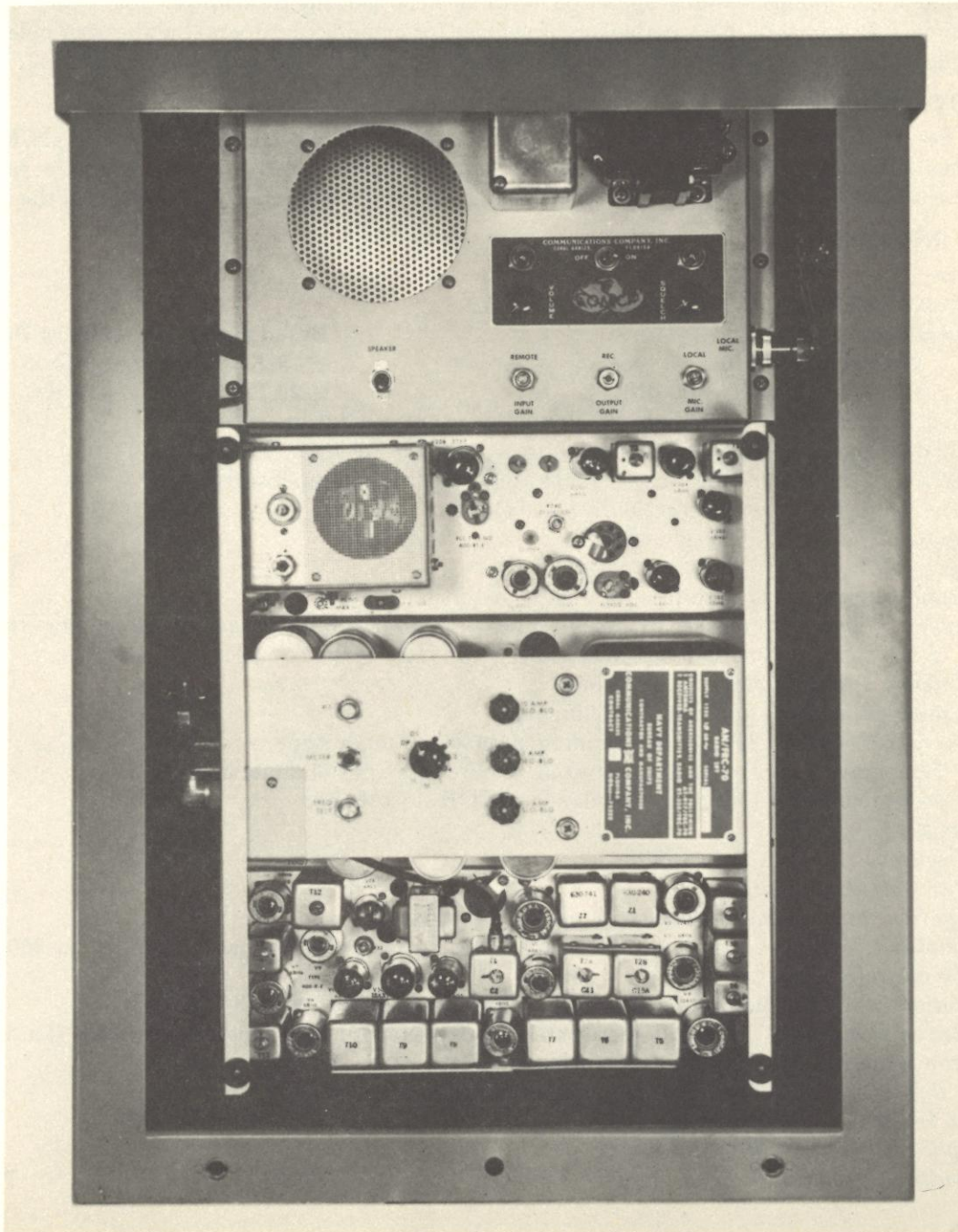

RADIO SET

AN/FRC-70A

FUNCTIONAL DESCRIPTION:

Radio Set AN/FRC-70A is a fixed tuned, single channel, crystal controlled transceiver designed for the reception and transmission of F3 (FM) emission. It is designed for communication with the AN/VRC-42 and AN/VRC-51 mobile equipments, but will work with other equipments that are of equal frequency, deviation, and stability. It is designed for both local and limited remote operations and is capable of continuous standby operation, with 20 to 30 percent transmitter duty cycle, over long periods of time. It is housed in a weather-proof cabinet for exterior (outdoors) bulkhead or pole mount. It is normally remotely operated by Radio Set Control C-2099/FRC-52 or C-2099A/FRC-52.

RELATION TO SIMILAR EQUIPMENT:

Radio Set AN/FRC-70A is similar in performance and physical/electrical design to the AN/FRC-70, the difference being the addition of channel determining crystal heater ovens, the change in value of a few component parts values (resistors and capacitors), and the addition of an AGC circuit in the receiver.

TECHNICAL DESCRIPTION:

Receiver:

Frequency Range: 132 to 152 mc.

Selectivity:

2 x down (-6 db)

100,000 x down (-100 db)

Broad Band

±15 Kc

±26 Kc

Narrow Band.

±6 Kc.

±14 Kc.

Frequency Stability: 0.002 percent Nontemperature controlled.

0.0005 percent with temperature control (required for split channel).

Ambient Temperature Range: 30° C. to +60° C. (room temperature).

Sensitivity: 0.6 μ v or less for 20 db noise quieting.

Squelch Sensitivity: 0.25 μ v or less.

Squelch Responses: 100 db or better.

Audio Output: 1.5 w with less than 10% distortion.

Audio Frequency Response: within +1 db to -3 db of a 6 db per octave slope over the range of 300 to 3000 cy (1,000 cps reference).

Antenna Input Impedance: 52 ohms.

Audio Output Impedance: 4 and 500 ohms.

Receiver Crystals: Channel determining crystal—3d mode type.

Temperature controlled type crystals required for split channel operation.

Second conversion crystal—similar to the CR-18/U type.

Transmitter:

Frequency Range: 132 to 152 mc.

Pwr Output: 50 w min.

Spurious and Harmonic Radiation: 60 db or better.

Pre-Emphasis: within +1 and -3 db of a 6 db per octave pre-emphasis from 300 to 3000 cycles (1000 cps reference).

Modulation: FM with direct crystal control (phase modulation) type F3 emission.

Modulation Deviation: Wide band operation, ±15 Kc; Narrow band operation ±5 Kc (for use with narrow band receivers for split channel operation).

Input Impedance: 125 ohms for microphone or handset.

Output Impedance (Antenna): 52 ohms.

Multiplication Order: $2 \times 2 \times 2 \times 2 = 16$.

Transmitter Crystal: Low drift, similar to the CR-18/U or CR-36/U types.

Crystal Trimmer: A variable capacitor is provided in the crystal circuit to permit zero beat with a standard frequency.

Frequency Stability: $\pm 0.002\%$ (nontemperature controlled). ± 0.0005 percent (temperature controlled crystal).

Ambient temperature range: -30° C. to $+60^{\circ}$ C. (exterior of case).

Pwr Supply:

Operating Pwr Requirements: 110 to 120 v, 50 to 60 cy, single phase.

Output Voltages:

- a. B+ Voltages: +700 VDC, +260 VDC, and +250 VDC.
- b. Relay Voltage: +10 VDC.
- c. Filament Voltage: 6.3 VAC.

Major Units:

1 AN/FRC-70A

25½" x 18¼" x 10½"

75 lbs

1 AT-917/FRC-70

120" x 4" x 4½"

75 lbs

TUBES, CRYSTALS, TRANSISTORS:

REFERENCE DATA AND LITERATURE:

NAVSHIPS 93559(A).

15 March 1962
 Cog Serv: USN FSN: 5820-765-8890
 USA Line Item No.:

RADIO SET CONTROL
AN/FRC-type
C-2099A/FRC-52

USA USN USAF USMC

STATUS OR TYPE CLASS.:

Manufacturer: CCI

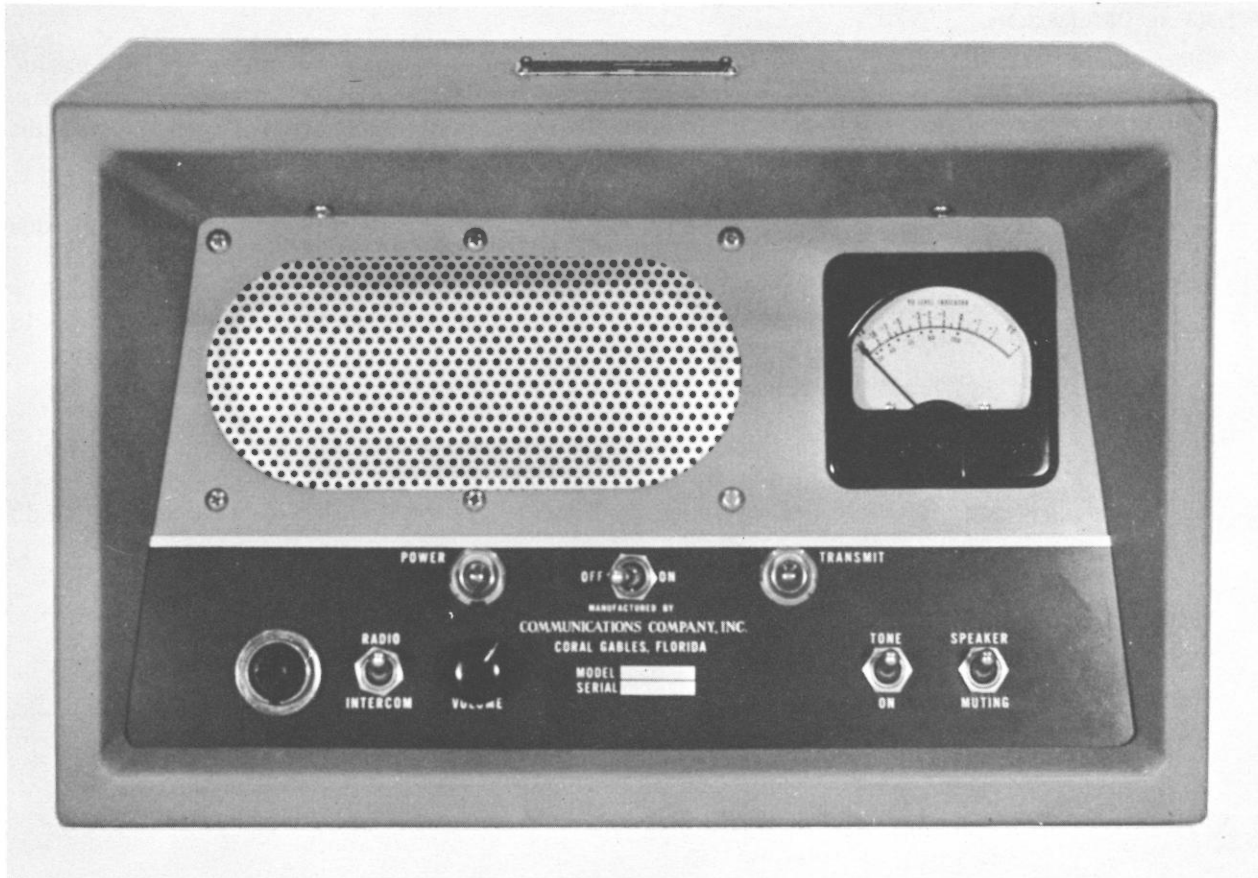

FUNCTIONAL DESCRIPTION:

The C-2099A/FRC-52 is a desk mounted control unit designed for the remote control of a radio telephone receiver and transmitter. Remote control is accomplished over a standard two-wire 600-ohm telephone line having a total loop resistance of not over 1500 ohms, nor more than 20 db loss.

While designed primarily for the remote control of Navy Models AN/FRC-52() and AN/FRC-70() equipments, the radio set control is equally applicable for controlling similar two-way radio telephone stations using amplitude frequency or phase modulated emission having a single receiver and transmitter operating simplex located at a remote location.

The radio set control is designed primarily for voice communication, and furnishes voltage for push-to-talk operation of the remote transmitter.

RADIO SET CONTROL

AN/FRC-type

C-2099A/FRC-52

RELATION TO SIMILAR EQUIPMENT:

C-2099A/FRC-52 is mechanically, electrically, and functionally similar to C-2099/FRC-52, the only differences being the addition of compression amplifier circuits, one each for transmit and receive. The C-2099A/FRC-52 and C-2099/FRC-52 are functionally interchangeable (except for compression amplifiers) and may be used in parallel with or as replacements for, each other.

TECHNICAL DESCRIPTION:

Compression Amplifier: This remote radio set control incorporates compression amplifiers having the capability of limiting the audio output level to less than 3 db variation with respect to a variation of 25 db (or more) in the audio input level. This capability is effective in both the transmit and receive conditions.

Transmit Conditions:

- Input: Controlled Reluctance, Transistorized Pre-Amplifier, microphone; or an audio tone oscillator within a frequency range of 800 to 1000 cycles.
- Output: 500-600-ohm audio line (balanced to ground).
- Output level: Into a 600-ohm telephone line, up to 50 milliwatts, normal maximum level 18 milliwatts with less than 5% distortion.
- Audio Response: ± 3 db from 300 to 3000 cy (controlled by the compression amplifier).
- Hum and Noise Level: At least 40 db or more below the rated output level.

Receive Conditions:

- Input Impedance: 500/600 ohms audio (balanced to ground).
- Minimum Input: Required over a 600-ohm telephone line for 1 watt of speaker level, -10 db (or lower).
- Output Impedance: 3.5 and 500 ohms (unbalanced).
- Speaker Output: At least 2.0 watts with less than 5 percent distortion.
- Audio Response: ± 3 db from 300 to 3,000 cy (controlled by the compression amplifier.)
- Hum and Noise Level: At least 45 db or more below the rated output level of 2.0 watts.

Pwr Supply:

- AC Input: 110 to 120 v, 50 to 60 cy; single phase.
- Output Voltages:
 - B+ Voltages: 250 vdc.
 - Filament Voltage: 6.3 vac.
 - Relay Voltages:
 - Tone Relay: 6.3 vac.
 - P/T': 48 vdc (key down) to -55 vdc (key up).
 - P/T'': +24 vdc to +60 vdc.

Major Units:

1 C-2099A/FRC-52

9' x 14½' x 10'

17½ lbs

TUBES, CRYSTALS, TRANSISTORS:

REFERENCE DATA AND LITERATURE:

NAVSHIPS 93630.

5 December 1958
Cog Serv: USAF FSN:
USA Line Item No.:

MICROWAVE RADIO RELAY SET
AN/FRC-type
CLR-7, Philco

USA USN USAF USMC

STATUS OR TYPE CLASS.:

A/Std

Manufacturer: Philco Corp.

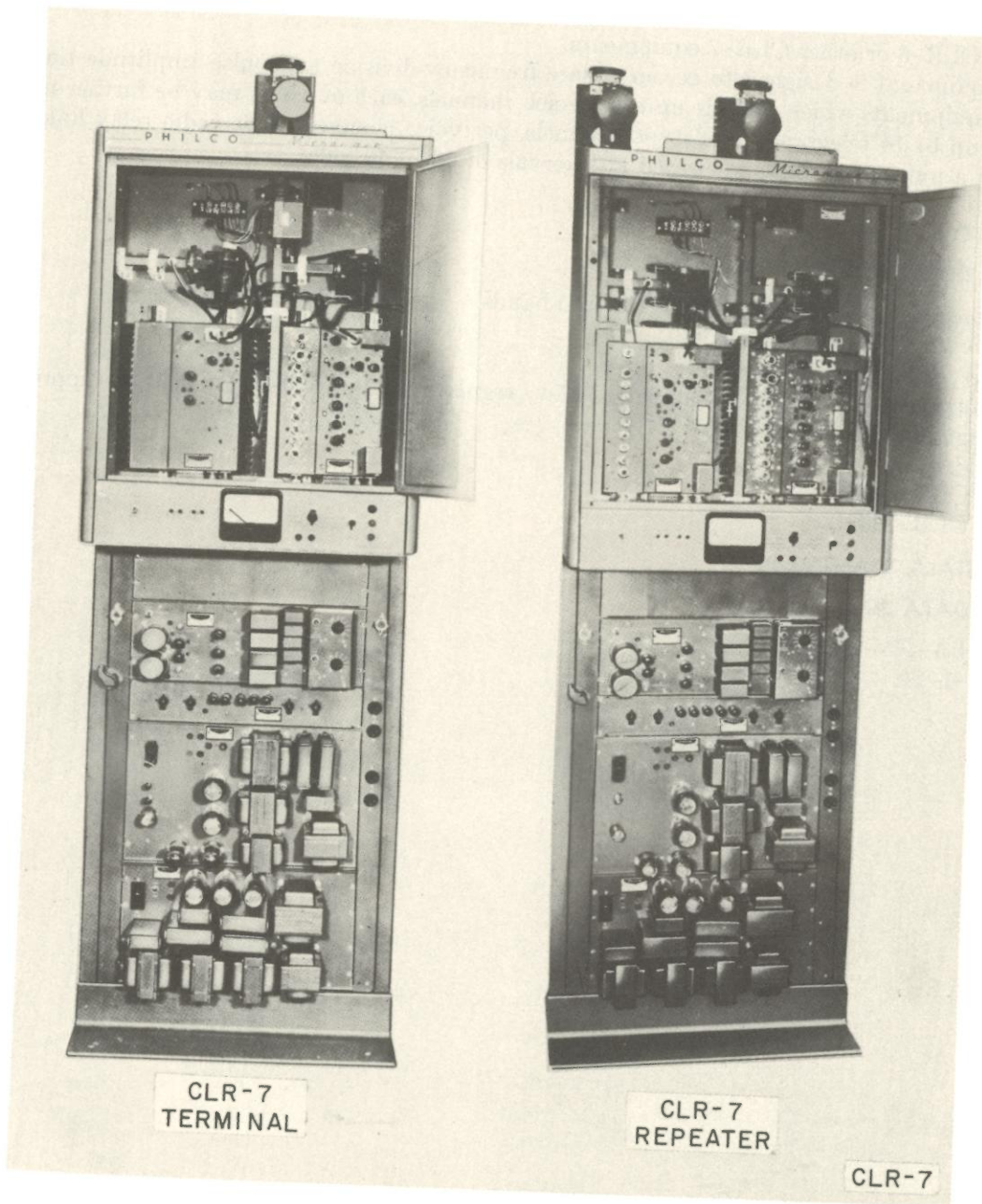

MICROWAVE RADIO RELAY SET

AN/FRC-type
CLR-7, Philco

FUNCTIONAL DESCRIPTION:

Microwave Radio Relay Set CLR-7, Philco, is the transmitting and receiving portion of a microwave communication station. Two or more such stations make up a radio relay link to provide two-way (duplex) communication between two points, when the CLR-7 is used in conjunction with suitable multiplexing equipment such as Philco Time Division Multiplexing Equipment GMT-4.

Microwave Radio Relay Set CLR-7, Philco, is used in ground, fixed stations, as radio relay links wherever use of land communication lines is not feasible. It can communicate with Microwave Radio Relay Sets CLR-6 or other CLR-7 equipments.

This equipment is designed to accommodate frequency-division and pulse-amplitude time division multiplex equipments which provide up to 60 voice channels, each of which may be further multiplexed to provide up to 16 telegraph or teletype channels, per voice channel. The radio relay link is usually made up of a number of stations located at intervals of 20 to 40 miles.

RELATION TO SIMILAR EQUIPMENT:

TECHNICAL DESCRIPTION:

Frequency Range in Mc: 6,125 to 8,100 in 5 bands.

Transmitter Pwr Output: 1 w.

Receiver Bandwidth: 10 mc.

Pwr Requirements: 600 w (nominal), 117-v, regulated, 50- to 60-cy ac; 150 w (approx), 117-v, unregulated 50- to 60-cy ac.

Major Units:

1 CLR-7RGL.

1 CLR-7TGL.

TUBES, CRYSTALS, TRANSISTORS:

REFERENCE DATA AND LITERATURE:

TO 31R5-4-5-11.

TO 31-1-11.

APPENDIX A

GLOSSARY OF ABBREVIATIONS

This appendix is a listing of abbreviations used in this publication, arranged alphabetically. The exact word or phrase for which the abbreviation is used, is given in each case.

A/C	Augmented Carrier	Cog.	Cognizant (Cognizance)
A/Std	Alternate Standard	COMM	Communication(s)
abs	absolute	cont'd	continued
ac	alternating current	Corp	Corporation
ADF	Automatic Direction Finder	cpm	cycles per minute
af	audio frequency	cps	cycle(s) per second
afc	audio frequency control	ctr	center
alt	altitude	cu	cubic
am	amplitude modulated (modulation)	cu ft	cubic foot (feet)
ame	amplitude modulated (modulation) equivalent	cw	continuous wave
amp	ampere(s)	cy	cycle(s)
ampl	amplifier	db	decibel(s)
ant.	antenna	dbm	decibels (referred to 1 milliwatt)
approx	approximate (approximately)	dc	direct current
ARL	Aircraft Radio Laboratory	deg	degree
ASO	Aviation Supply Office	Dept	Department
assy	assembly	dev	develop (development)
auto	automatic	dia	diameter
avc	automatic volume control	div	division
avg	average	dsb	double sideband
az	azimuth	Dwg	Drawing(s)
bat.	battery	dy	dynes
bfo	beat frequency oscillator	ea	each
blk	black	Ed	Edition
BuAer	Bureau of Aeronautics	el	elevation
BuOrd	Bureau of Ordnance	elect.	electrolytic
BuShips	Bureau of Ships	equiv	equivalent
bw	bandwidth	ext	external
C	Centigrade	F	Fahrenheit
cal	calibrate	fax	facsimile
cgs	centimeter gram second	fil	filament
chan	channel	fm	frequency modulated (modulation)
CIC	Combat Information Center	fpm	feet per minute
ckt	circuit	freq	frequency
Class.	Classification	fsk	frequency-shift keyed (keying)
cm	centimeter	FSN	Federal Stock Number
Co	Company	ft	foot (feet)
coax.	coaxial	gen	generator
		GFE	Government Furnished Equipment

h	henry(s)	peak/in.	peak per inch
HDBK	Handbook	pf	power factor
hf	high frequency	Pkg(s)	Package(s)
HI	High	pm	pulse modulated (modulation)
hor	horizontal	pos	positive
hr	hour(s)	pps	pulses per second
icw	interrupted continuous wave	prf	pulse repetition rate
IF	Intermediate Frequency	pt	point
IFF	Identification Friend or Foe	pwr	power
in.(s)	inch (inches)	Qty	Quantity
Inc	Incorporated	RADC	Rome Air Development Center
INPH	Interphone	REC	Receiver
int	internal	ref	reference
JAN	Joint Army-Navy	rf	radio frequency
kc	kilocycle(s) (or kilocycles per second)	rms	root mean square
kv	kilovolt(s)	rpm	revolutions per minute
kva	kilovolt-ampere(s)	RT	Receive-Transmit
kw	kilowatt(s)	rtt	radioteletype (frequency-shift keyed)
L/Std	Limited Standard	S/Std	Substitute Standard
lb(s)	pound(s)	sec	second
lf	low frequency	shf	super high frequency
lg	long	Sig C	Signal Corps
lsb	lower sideband	SOS	International distress signal (radio- telegraph)
ma	milliampere(s)	Spec	Specification
man.	manual	sq	square
max	maximum	ssb	single sideband
mb	millibars	Std	Standard
mc	megacycle(s) (megacycles per second)	swr	standing wave ratio
mcw	modulated continuous wave	sync	synchronizing
meg	megohm	T/Std	Tentative Standard
mf	medium frequency	temp	temperature
mh	millihenry	term.	terminal
mi	mile	TM	Technical Manual
MIC	Microphone	TO	Technical Order
MIL	Military	TR	Transmit-receive
min	minimum or minute(s)	TTY	Teletypewriter
mph	miles per hour	TV	Television
ms	millisec(s)	ua	microampere
mv	millivolt(s)	udynes	microdynes
mw	milliwatt(s)	uf	microfarad
naut	nautical	uh	microhenry
NAV	Navigation	uhf	ultra-high frequency
neg	negative	umhos	micromhos
neut	neutral	USA	United States Army
No.(s)	Number(s)	USAF	United States Air Force
nom	nominal	usb	upper sideband
Obs	Obsolete	USCG	United States Coast Guard
OD	Outside Diameter	usec	microsecond(s)
opm	operations per minute	USMC	United States Marine Corps
osc	oscillator	USN	United States Navy
P/Std	Planned Standard		

u/w used with
 uuuf micromicrofarad(s)
 uf microvolt
 uw microwatt(s)
 v volt(s)
 v/in. volt per inch
 v/meter volts per meter
 v/usec volt per microsecond
 va voltampere
 vert vertical
 vf voice frequency
 vhf very high frequency
 vlf very low frequency
 vol volume
 vps vibrations per second

VSWR Voltage Standing Wave Ratio
 VTVM Vacuum Tube Voltmeter
 vu volume unit(s)
 w watt(s)
 w/ with
 w/amp watts per ampere
 w/mc watts per megacycle
 w/o without
 WADC Wright Air Development Center
 wk week
 wpm words per minute
 xmtr transmitter
 xtal crystal
 yd yard
 yd/rev yard per revolution

APPENDIX B

INDEX OF ITEMS BY TYPE NUMBERS

<i>Item</i>	<i>Page</i>	<i>Item</i>	<i>Page</i>
AN/AIC-2	1	AN/TRT-Type:	
AN/AIC-3	3	GP, GP-2	81
AN/AIC-8	5	TA-18-BB	83
AN/AIC-10	7	AN/BRA-6	85
AN/AIC-13	9	AN/CRT-3A	87
AN/AIC-18	11	AN/CRT-5	89
AN/AIC-20	13	AN/FCC-3	91
AN/ARA-15	15	AN/FCC-7	95
AN/ARA-19	17	AN/FCC-8	99
AN/ARC-3()	19	AN/FCC-16	101
AN/ARC-5	21	AN/FCC-Type:	
AN/ARC-8	23	TH-1/TCC	105
AN/ARC-21()	25	AN/FGA-Type:	
AN/ARC-27	27	TT-25/FG	107
AN/ARC-33	29	AN/FGC-1()	109
AN/ARC-34	31	AN/FGC-5	111
AN/ARC-36()	33	AN/FGC-6	115
AN/ARC-44	35	AN/FGC-7	117
AN/ARC-49	37	AN/FGC-7A	119
AN/ARC-55	39	AN/FGC-11	121
AN/ARC-57	41	AN/FGC-12	123
AN/ARC-58	43	AN/FGC-20()	125
AN/ARC-60	45	AN/FGC-21()	127
AN/ARC-63	47	AN/FGC-25()	129
AN/ARC-65	49	AN/FGC-29	131
AN/ARC-66	51	AN/FGC-38(), -39	133
AN/ARC-70()	53	AN/FGC-60(V)	135
AN/ARC-74	55	AN/FGC-Type:	
AN/ARC-85	57	SB-65()/FGC	139
AN/ARC-Type:		SB-66()/FGC	141
ARC Type 210	59	TG-26	143
HACON	61	TT-6/FG	147
HF-101, -102, -103	63	TT-7/FG	149
VHF-101	65	TT-8/FG	151
AN/ARN-30	67	TT-21/FG	153
AN/ARR-15	69	AN/FGQ-1()	155
AN/ARR-15A	71	AN/FGQ-Type:	
AN/ARR-36	73	TT-71/UG	157
AN/ARR-41	75	AN/FGR-Type:	
AN/ART-13A	79	TT-45/FG, TT-46/FG	159
		TT-107/FG	161

<i>Item</i>	<i>Page</i>	<i>Item</i>	<i>Page</i>
AN/FIC-Type:		AN/FRC-6.....	193
LS-124()/FI.....	163	AN/FRC-10.....	195
LS-125()/FI.....	165	AN/FRC-10A.....	197
LS-126()/FI.....	167	AN/FRC-10B.....	199
LS-126()/FI.....	169	AN/FRC-15.....	201
LS-128()/FI.....	171	AN/FRC-23(), AN/FRC-26().....	203
LS-130()/FI.....	173	AN/FRC-27().....	205
LS-138()/FI.....	175	AN/FRC-31().....	207
LS-200/FI.....	177	AN/FRC-34.....	209
LS-201/FI.....	179	AN/FRC-35.....	211
LS-202/FI.....	181	AN/FRC-39(V).....	213
AN/FRA-6.....	183	AN/FRC-45(V).....	215
AN/FRA-11.....	185	AN/FRC-47.....	217
AN/FRA-501.....	187	AN/FRC-56(V).....	219
AN/FRA-Type:		AN/FRC-70A.....	221
CU-168/FRR.....	189	AN/FRC-Type:	
0-5()/FR.....	191	C-2099A/FRC-52.....	225
		CLR-7 PHILCO.....	227

Custodians:

Army—EL
Navy—BuShips
Air Force—AF-85

Preparing activity:

Army—EL
Project No. MISC-0138

User activities:

Army—MO, MU

DEPARTMENT OF DEFENSE

MIL-HDBK-161A

Electronic Communication Equipment

1. This Military Standardization Handbook was developed by the Department of Defense in coordinated cooperation with the Departments of the Army, Navy, and Air Force in accordance with established procedure.

2. This document was approved 12 March 1964 for printing and inclusion in the Military Standardization Handbook Series.

3. This handbook constitutes a directory of electronic communication equipment used in the Department of Defense in the standardization, design, development, procurement and maintenance of military electronic and electrical communication and related equipment.

4. Every effort has been made to include the latest data and information pertaining to the communication equipment concerned. The present edition is the initial increment of Revision A of this handbook and is planned for maintenance by Change Notices issued quarterly to constitute a complete revision annually. Users of this handbook are encouraged to comment and report inaccuracies, omissions, etc., to Commanding General, U.S. Army Electronics Command, Fort Monmouth, N.J., 07703.

