

NAVSHIPS 93152

★

TECHNICAL MANUAL

for

RADIO SET
CONTROL
C-1138A/UR

TABET MANUFACTURING CO. INC.
NORFOLK, VIRGINIA

MODEL ENGINEERING AND MANUFACTURING, INC.
HUNTINGTON, INDIANA, U.S.A.

DEPARTMENT OF THE NAVY
BUREAU OF SHIPS

Contract: N126s-83888
N126s-85774

★
Approved by BuShips: 19 MAY 1958

LIST OF EFFECTIVE PAGES

PAGE NUMBERS	CHANGE IN EFFECT	PAGE NUMBERS	CHANGE IN EFFECT
Title page	Original	4-0 to 4-2	Original
ii to vi	Original	5-1 to 5-4	Original
1-0 to 1-1	Original	6-1	Original
2-0 to 2-1	Original	7-0 to 7-3	Original
3-0 to 3-1	Original	i-1 to i-2	Original

DEPARTMENT OF THE NAVY
BUREAU OF SHIPS
WASHINGTON 25, D. C.IN REPLY REFER TO
Code 993-100

From: Chief, Bureau of Ships
To: All Activities concerned with the Installation,
Operation, and Maintenance of the Subject Equipment

Subj: Technical Manual for Radio Set Control, C-1138A/UR,
NAVSHIPS 93152

1. This non-registered publication is the technical manual for the subject equipment and is in effect upon receipt.
2. When superseded by a later edition, this publication shall be destroyed.
3. Extracts from this publication may be made to facilitate the preparation of other Department of Defense publications.
4. Errors found in this publication (other than obvious typographical errors), which have not been corrected by means of Temporary Corrections or Permanent Changes, should be reported. Such report should include the complete title of the publication and the publication number (short title); identify the page and line or figure and location of the error; describe the error or indicate what change should be made; and be forwarded to the Electronics Publications Section of the Bureau of Ships.
5. All Navy requests for NAVSHIPS electronics publications should be directed to the nearest Bureau of Supplies and Accounts Forms and Publications Supply Point. When changes or revised books are distributed, notice will be included in the Electronics Information Bulletin, NAVSHIPS 900,022, and in the Index of Bureau of Ships General and Electronics Publications, NAVSHIPS 250-020.

A. G. MUMMA
Chief of Bureau



TABLE OF CONTENTS

	Page		Page
SECTION 1 - GENERAL INFORMATION		Test Procedures	4 - 2
Introduction	1 - 1	SECTION 5 - TROUBLE-SHOOTING	
Technical Manual Coverage	1 - 1	General	5 - 1
Functional Description	1 - 1	Theory of Localization	5 - 1
Quick Reference Data	1 - 1	Unit Trouble Shooting	5 - 1
SECTION 2 - INSTALLATION		SECTION 6 - REPAIR	
Unpacking	2 - 1	Failure Report	6 - 1
Installation	2 - 1	Test Equipment and Special Tools	6 - 1
Initial Adjustments	2 - 1	Location of Parts	6 - 1
SECTION 3 - OPERATOR'S SECTION		Adjustments	6 - 1
Introduction	3 - 0	Lubrication	6 - 1
Capabilities and Limitations	3 - 0	SECTION 7 - PARTS LIST	
Operation	3 - 0	Introduction	7 - 0
Routine Checks	3 - 1	Maintenance Parts List	7 - 0
SECTION 4 - PRINCIPALS OF OPERATION		Stock Number Identification	7 - 0
General Description of Circuits	4 - 1	List of Manufacturers	7 - 0
Circuit Analysis	4 - 1	Index	i - 1

LIST OF ILLUSTRATIONS

Figure	Page
1 - 1 Radio Set Control, C-1138A/UR	1 - 0
2 - 1 Radio Set Control, Installation Drawing	2 - 0
2 - 2 Cable Stuffing Plates and Terminal Boards	2 - 1
3 - 1 Radio Set Control, C-1138A/UR, Front Panel	3 - 0
4 - 1 Radio Set Control, C-1138A/UR, Schematic Diagram	4 - 0
5 - 1 Main Chassis, Showing Location of Components	5 - 1
5 - 2 Trouble Shooting Chart	5 - 2
5 - 3 View of Terminal Boards TB-101 and TB-102	5 - 3

LIST OF TABLES

SECTION 1 - GENERAL INFORMATION

Table	Page
1 - 1 Equipment Supplied	1 - 1

SECTION 3 - OPERATOR'S SECTION

3 - 1 Routine Check Chart	3 - 1
---------------------------------	-------

SECTION 5 - TROUBLE SHOOTING

5 - 1 Voltage Measurements	5 - 4
----------------------------------	-------

SECTION 7 - PARTS LIST

7 - 1 Maintenance Parts List	7 - 1
7 - 2 List of Manufacturers	7 - 3

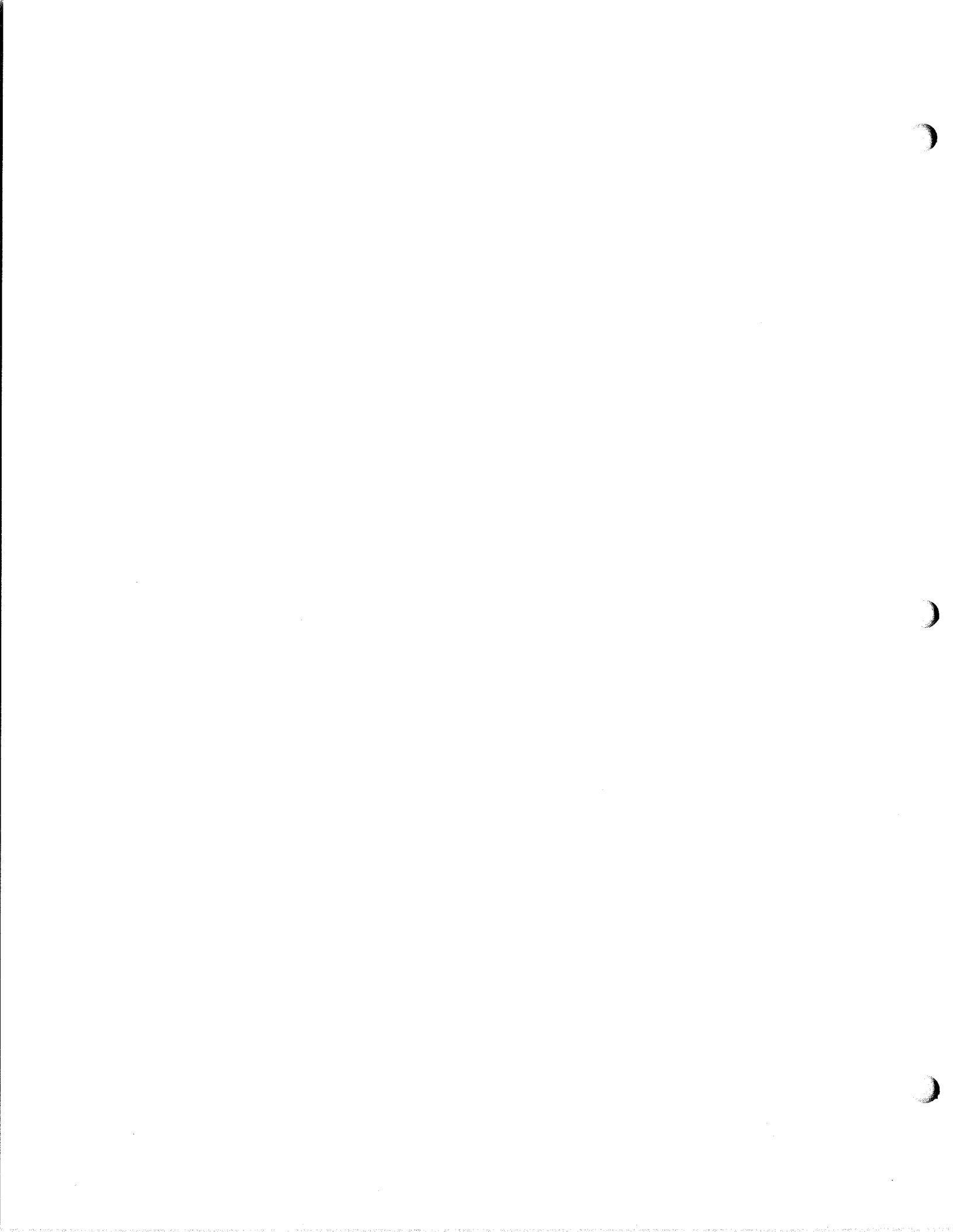



FIGURE 1-1. RADIO SET CONTROL, C-1138A/UR

SECTION 1

GENERAL INFORMATION

1-1 INTRODUCTION

This technical manual describes the theory of operation, installation, and maintenance of the Radio Set Control, Model C-1138A/UR. It is intended to provide operating and maintenance personnel with the necessary information to utilize the equipment for remote operation of radio phone and telegraph transmitting equipment and to maintain the unit in first class operating condition.

1-2 TECHNICAL MANUAL COVERAGE

This technical manual contains data pertaining only to the Radio Set Control, Model C-1138A/UR.

1-3 FUNCTIONAL DESCRIPTION

a. The purpose of the equipment is to provide necessary facilities to remotely control certain radio-phone transmitter functions and the output of a radio receiver. Incorporated into the circuitry is the means for turning on or off any standard Navy shipboard transmitter, the means to voice modulate (or key when C-W operation is desired) any standard Navy shipboard transmitter and the means to monitor and control the output of any standard Navy radio receiver. The unit incorporates POWER and CARRIER ON indicators to provide the remote control operator with this information. Under standard operation conditions, as

many as four Model C-1138A/UR Radio Set Controls or similar units may be parallel connected to a single equipment group (transmitter and receiver) to provide various remote operating positions.

b. The front panel is utilized for the mounting of the normally used controls and the input and output jacks. The front panel is hinged at the bottom and secured at the top by two captive thumb screws. Access to the chassis components is obtained by opening the hinged front panel which swings the chassis out of the unit. An earphone muting control is located on the chassis and is adjusted from the underside of the chassis. Two terminal boards are mounted inside the cabinet on the back wall to provide connection points for the external cabling. The equipment is illustrated in Figure 1-1.

1-4 QUICK REFERENCE DATA

- a. Control, Radio Set, Model No. C-1138A/UR.
- b. Contract: N126s-83888, N126s-85774.
- c. Contractor: Tabet Mfg. Co., Inc., Norfolk, Va.
Model Engineering and Mfg., Inc.,
Huntington, Ind.
- d. Inspector: Inspector of Naval Material, Baltimore, Md, Fort Wayne, Ind.
- e. Number of packages in shipment: One complete unit per package.
- f. Cubical contents: 228 cubic inches.
- g. Total weight: 13 lbs.

TABLE 1-1. EQUIPMENT SUPPLIED

QUAN. PER EQMT.	NAME OF UNIT	NAVY TYPE DESG.	OVERALL DIMENSIONS (in.)			VOL. CU. IN.	WGHT.
			HEIGHT	WIDTH	DEPTH		
1	Control Radio Set	C-1138A/UR	5-1/2	8	7-15/16	228	13 lbs.
2	Technical Manual	NAVSHIPS 93152					

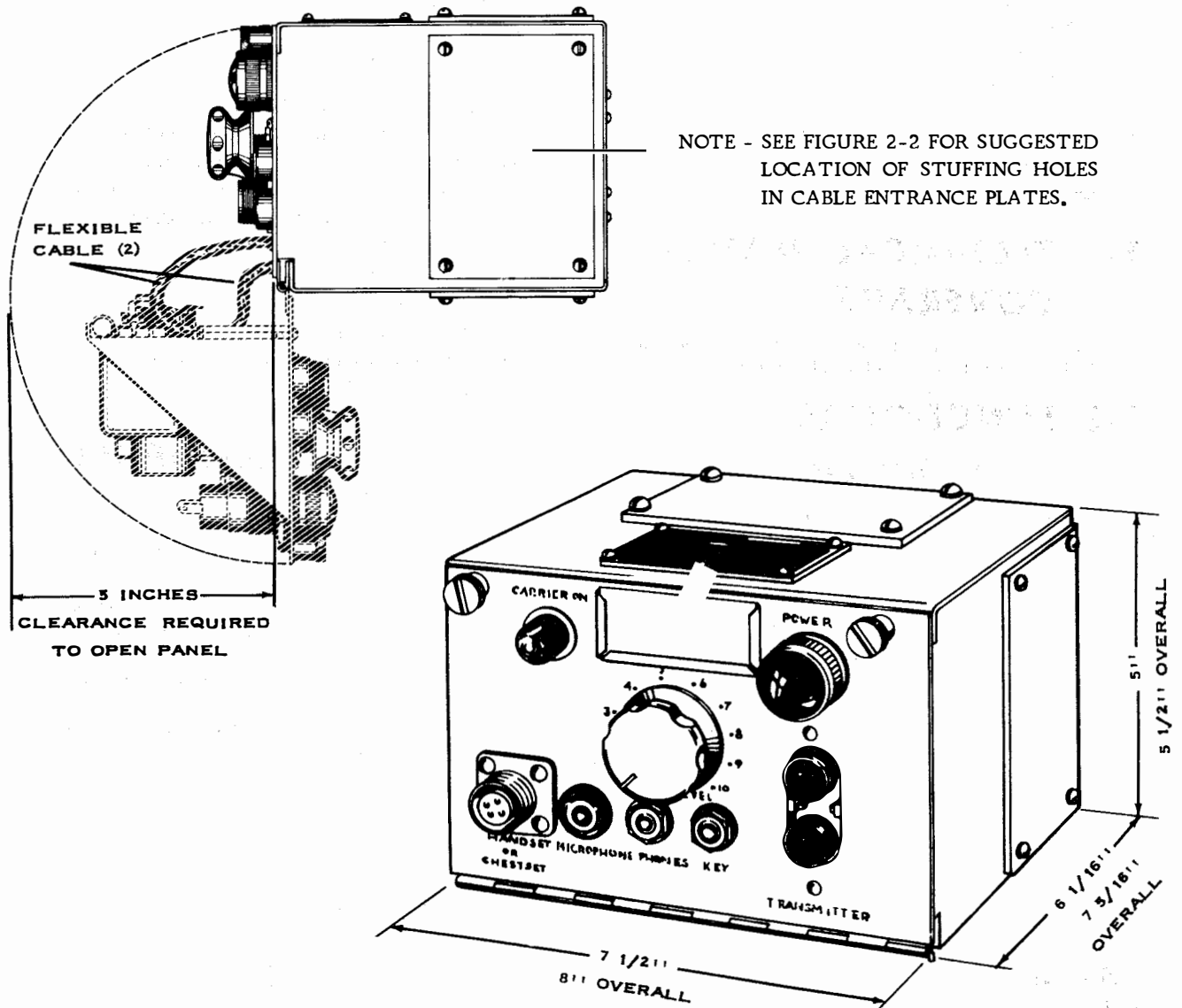

FIGURE 2-1. RADIO SET CONTROL, INSTALLATION DRAWING

SECTION 2 INSTALLATION

2-1 UNPACKING

One Radio Set Control Unit, Model C-1138A/UR, is shipped in one packing box.

Use caution in unpacking the unit to prevent damage to the unit.

2-2 INSTALLATION

a. LOCATION. No specific location is prescribed. The control unit may be located wherever necessary. The location is determined by operating and space requirements.

b. MOUNTING. The control unit is housed in a steel case which is suitable for mounting on either a vertical or horizontal surface. There are no mounting holes or studs provided on the unit. The individual installation determines the number and location of mounting holes and the installing personnel drill them as necessary. Maintain clearance for the hinged front panel. The clearance will be sufficient to allow the panel to swing about a 180° arc to provide accessibility to the terminal boards on the back of the cabinet. See figure 2-1.

c. CABLING. The unit is provided with cover plates on each side of the box except the front and back. These holes are covered by steel plates which are removable to permit them to be drilled for cable stuffing tubes as required. The plates will accommodate two size A, one size B and one size D stuffing tubes if necessary. Suggested procedure is shown in figure 2-2. After mounting the cable stuffing tubes the access plates are replaced on the case and the entrance cables connected to the terminal boards as required. The terminals are marked as shown in figure 2-2. Entrance to the case may be made through one or more access plates as required.

2-3 INITIAL ADJUSTMENTS

The speaker amplifier is adjusted for the correct level with the normal output of the receiver being fed into it. This condition exists when the push-to-talk switch has not been actuated and relay K101 is not energized. Earphone muting control, R104, is located on the chassis and is pre-set and locked at 10,000 ohms.

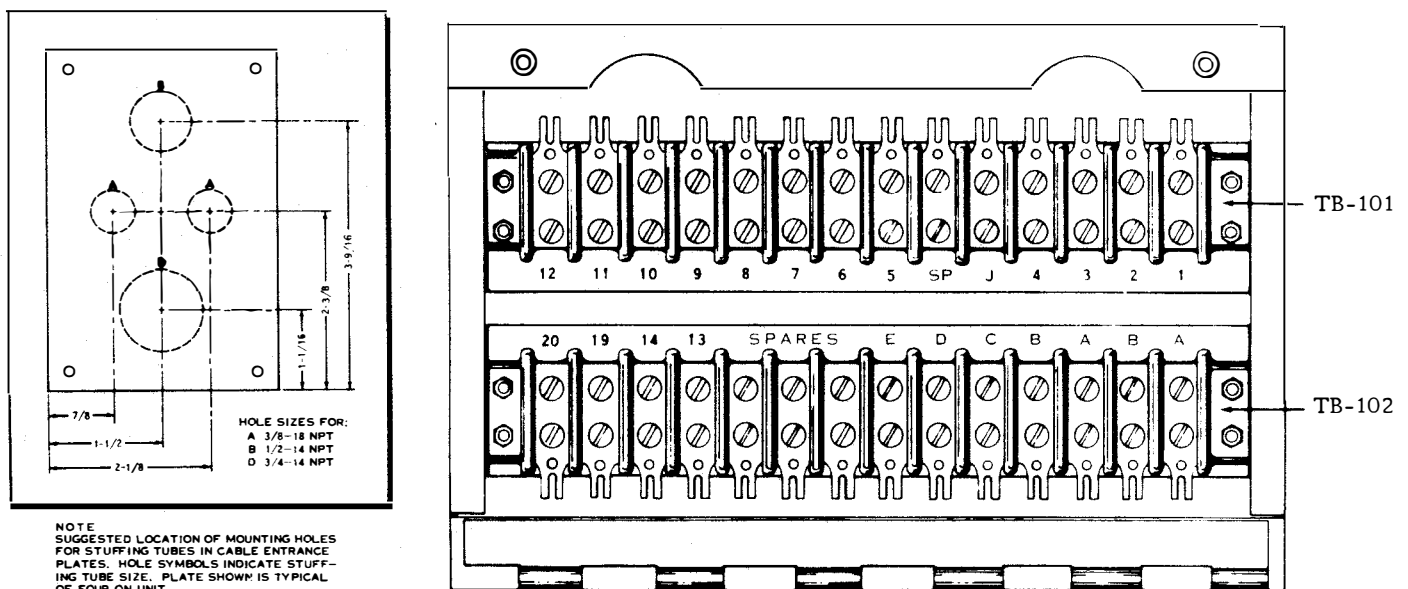

FIGURE 2-2. CABLE STUFFING PLATES AND TERMINAL BOARDS

SECTION 3 OPERATOR'S SECTION

3-1 INTRODUCTION

The RADIO SET CONTROL, Model C-1138A/UR is the medium for remote operation of a standard shipboard radio transmitter and receiver. It provides the means to: (1) turn the transmitter ON and OFF; (2) voice modulate or key the output of the controlled transmitter; (3) regulate the level of the audio output of the receiver to the earphones.

3-2 CAPABILITIES AND LIMITATIONS

The C-1138A/UR control set is capable of being connected in parallel with up to three more units to provide remote operation of a single equipment group from as many as four different locations. It is designed to operate only with standard Navy shipboard transmitting equipment.

3-3 OPERATION (See Figure 3-1)

a. TRANSMITTER OFF-ON SWITCH

(1) To energize the controlled transmitter press the

START button momentarily. This energizes the starting relay in the transmitter and the POWER indicator is illuminated.

(2) To de-energize the transmitter press the STOP button. This shorts the starting relay coil in the transmitter, de-energizing the starting relay and the POWER indicator.

b. TRANSMITTER INPUT CIRCUITS.

Depending upon what type of emission is being utilized, the operator may use a key, handset, chestset or microphone (none of which is supplied with this equipment). When voice modulation is used the operator must actuate the push-to-talk switch on the microphone, handset or chestset he is using to connect the microphone in series with the microphone input transformer and actuate the relay which: (1) cuts off the speaker; (2) actuates the push-to-talk relay in the controlled transmitter and; (3) energizes the CARRIER ON indicator at his own and the paralleled control units, indicating that transmitter is in use.

c. EARPHONE LEVEL CONTROL

THE EARPHONE LEVEL potentiometer is adjusted

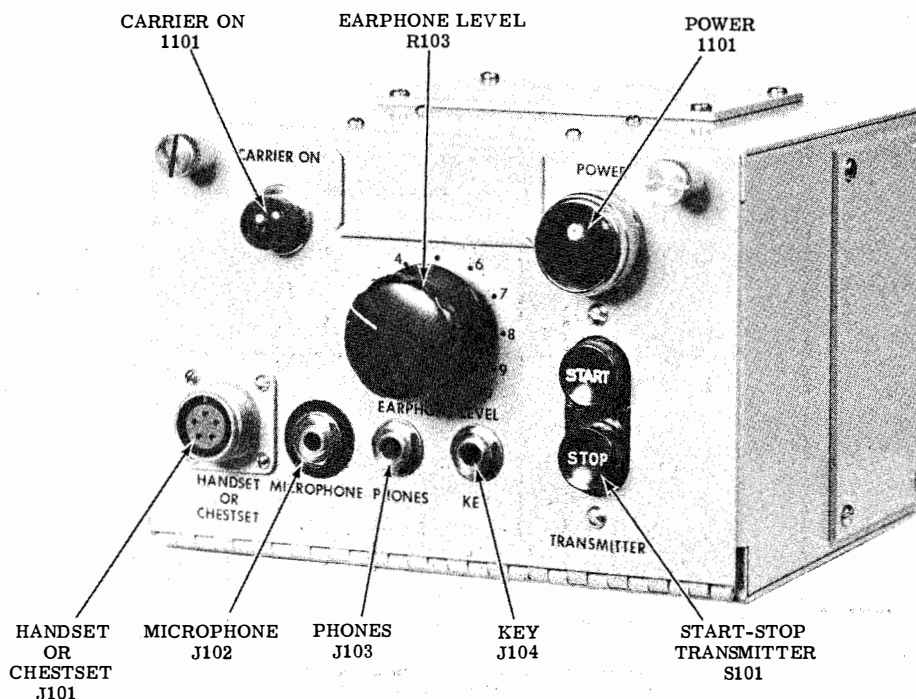

FIGURE 3-1. RADIO SET CONTROL, C-1138A/UR, FRONT PANEL

by each operator to suit his own listening habits.

d. A white acetate card is provided in a holder on the front panel on which pertinent station or channel information may be noted.

3-4 ROUTINE CHECKS

The Checks which are to be performed by operating personnel are indicated in Table 3-1. If other malfunctions occur a maintenance technician should be called.

TABLE 3-1. ROUTINE CHECK CHART
(TO BE MADE EACH WATCH)

CHECK	PROCEDURE	RESULT
TRANSMITTER START-STOP	PRESS START BUTTON ON FRONT PANEL	THE POWER INDICATOR SHOULD BE ENERGIZED
CARRIER ON AND EARPHONE MUTING FUNCTIONS	ACTUATE THE PUSH-TO-TALK SWITCH ON THE MICROPHONE, HANDSET OR CHESTSET	THE CARRIER ON INDICATOR SHOULD BE ILLUMINATED AND THE EARPHONE OUTPUT SHOULD BE AUDIBLE
EARPHONE LEVEL POTENTIOMETER	LISTEN ON EARPHONES AND ROTATE THE CONTROL KNOB BOTH WAYS.	CW ROTATION SHOULD INCREASE THE LEVEL IN THE EARPHONES AND CCW ROTATION SHOULD DECREASE THE LEVEL

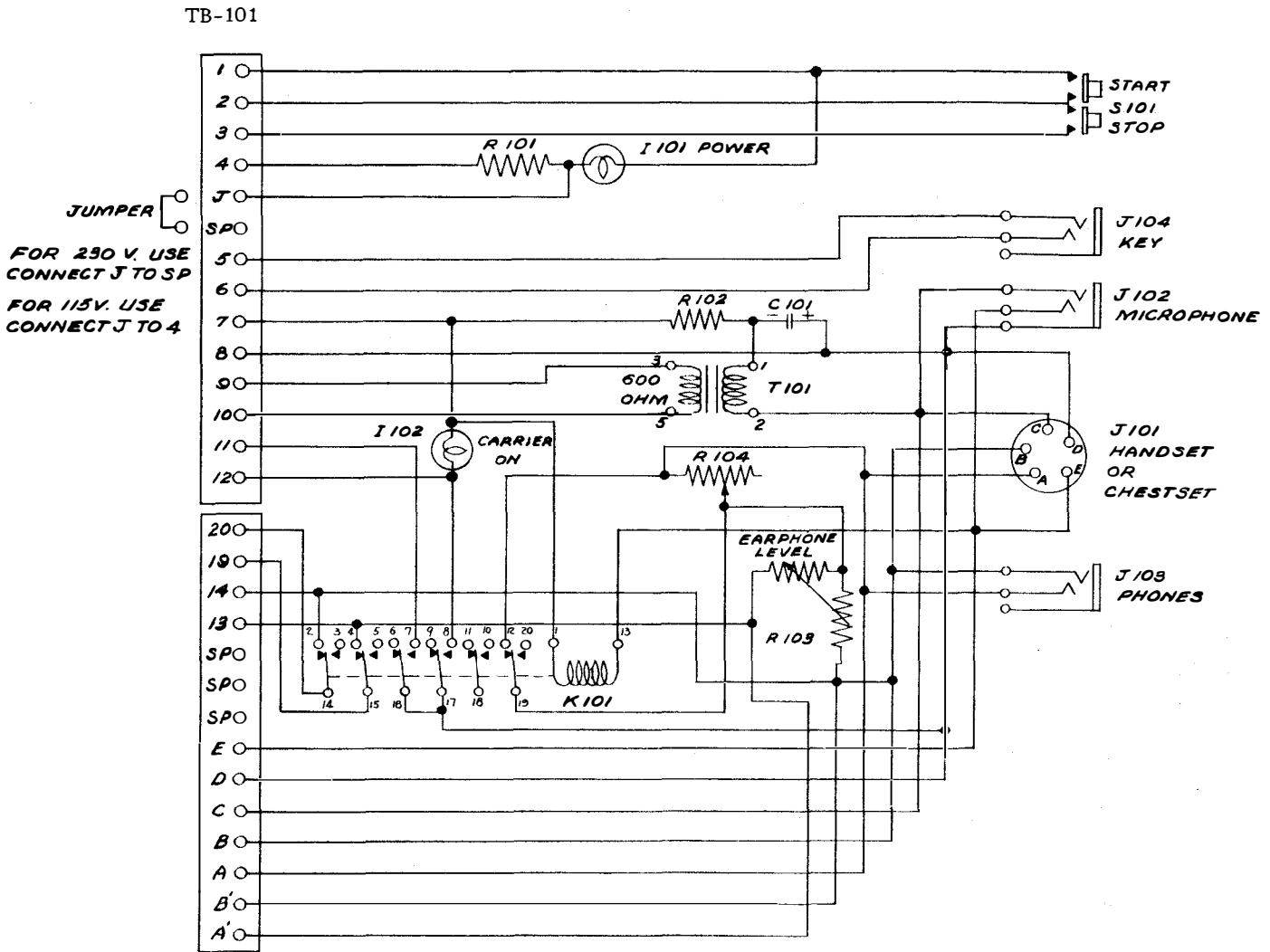

TB-102

TERMINAL	FUNCTION
1	POWER BUS 115/230 V AC OR DC
2	POWER ON CONTROL BUS
3	POWER OFF CONTROL BUS
4	POWER BUS 115/230 V AC OR DC ONE CONNECTION POINT FOR JUMPER PLATE FOR 115 V OPERATION
J	COMMON CONNECTION POINT FOR JUMPER PLATE FOR 115 VOLT OR 230 VOLT OPERATION
SP	SPARE CONTACT USED EXCLUSIVELY FOR JUMPER STOWAGE ON 230 V OPERATION
5	KEY OUTPUT-RING
6	KEY OUTPUT-TIP
7	NEGATIVE 12 V INPUT
8	POSITIVE 12 V INPUT
9	600 OHM LINE-MICROPHONE OUTPUT TO TRANSMITTER
10	
11	POSITIVE 12 V CARRIER ON SIGNAL OUTPUT
12	POSITIVE 12 V CARRIER ON SIGNAL INPUT
13	POWER IS APPLIED TO TERMINAL NO. 4 VIA A SET OF CONTACTS ON THE "STARTING" RELAY OF THE CONTROLLED TRANSMITTER. THE "POWER ON" INDICATOR WILL NOT LIGHT UNTIL THE STARTING RELAY HAS ACTUATED.
14	
19	
20	
A'	600 OHM LINE-RECEIVER AUDIO INPUT TO CONTROL UNIT, SAME AS 13 AND 14
A	600 OHM HEADSET OUTPUT
B	
C	MICROPHONE INPUT, CARBON SINGLE BUTTON
D	POSITIVE 12 V SUPPLY
E	CARRIER ON RELAY CONTROL LEAD
SPARES	THREE SETS OF SPARE TERMINALS

FIGURE 4-1. RADIO SET CONTROL, C-1138A/UR, SCHEMATIC DIAGRAM

SECTION 4

PRINCIPLES OF OPERATION

4-1 GENERAL DESCRIPTION OF CIRCUITS

The Radio Set Control, Model C-1138A/UR, implements control of three basic circuits. These are namely, transmitter control circuits, the transmitter input circuits, and the receiver output circuits.

a. The transmitter control circuits consist of the START-STOP TRANSMITTER switch, S101, the associated POWER indicating lamp, I101, the CARRIER ON indicator lamp, I102, and relay K101 which actuates the push-to-talk relay in the transmitter.

b. The transmitter input circuits consists of the HAND-SET OR CHESTSET connector, J101, and the MICROPHONE jack, J102, which connects the microphone (not part of unit) in series with the necessary voltage and the primary of the microphone input transformer (T101). Actuating the push-to-talk switch on the microphone, handset or chestset completes the circuit through the microphone input transformer and also completes the circuit which energizes relay K101. Relay K101, when closed, applies the 12 volts necessary to close the push-to-talk relay in the controlled transmitter. The control unit also provides a KEY input jack, J104, which is utilized when C-W operation is desired.

c. The receiver output circuits provide facilities to regulate the audio output level delivered from the remote receiver. THE EARPHONE LEVEL POTENTIOMETER, R103, is adjusted to provide the desired audio level at the PHONE jack, J103, and pins A and B of the HANDSET OR CHEST-SET connector, J101. The muting control R104 provides for adjustment of the input level to the earphone, and pins A & B of the handset or chestset connector, when the microphone input is being used.

4-2 CIRCUIT ANALYSIS (See Figure 4-1)

a. START-STOP CONTROL. The transmitter START-STOP switch, S101, consists of two normally open, push-to-make contact switch circuits. Pressing the START button connects terminals 1 and 2 of terminal board TB-101 through the switch contacts and pressing the STOP button connects terminals 2 and 3 of terminal board TB-101 together. When the unit is connected to a transmitter incorporating the standard Navy shipboard control circuitry, pressing the START button energizes the starting relay in the

transmitter. The starting relay when energized closes a pair of contacts that short the same wires the START switch does and the transmitter remains energized. Pressing the STOP button shorts the transmitter's starting relay coil through a current limiting resistor, causes the relay to open, and de-energizes the transmitter. Since the START-STOP switches are normally open the transmitter may be energized or de-energized from any parallel connected remote control unit.

b. POWER ON INDICATION. Power on indication is provided by the POWER ON indicator lamp I101 located on the front panel. For operation from a 230-volt line, resistor R101 is connected in series with the lamp. The lamp is rated at 230 volts; however, the resistor is connected in series when a 230-volt supply is being utilized to lower the applied voltage to approximately 115 volts. Operating the lamp at half its rated voltage greatly increases its service life. When a 115 volt supply is used the resistor is shorted out of the circuit by the jumper.

Terminal 1 of terminal board TB-101 is connected to one leg of the supply and terminal 4 is connected to the other through a set of contacts of the controlled transmitter's starting relay.

All remote stations are parallel connected and the POWER indicators of all control units in a group are illuminated when power is applied to the controlled equipment group (transmitter and receiver).

c. AUDIO CIRCUITRY. The audio circuitry consists of the connectors J101 and J102 which, along with the terminal board, TB-102, provides connection facilities for a carbon microphone, handset or chestset, a microphone to 600-ohm input transformer, T101, a microphone current limiting resistor, R102, a filter capacitor, C101, an L-type constant impedance earphone level attenuator, R103, and an earphone muting control, R104. The secondary of the audio input transformer, T101, connects to terminals 9 and 10 of terminal board TB-101. The voltage necessary to provide microphone current and operate relay K101 is obtained from the transmitter through terminals 7 and 8 of terminal board TB-101. The output of the radio receiver connects through terminals 13 and 14 of terminal board TB-102. The external speaker amplifier (not part of unit) is connected to terminals 19 and 20 of terminal board TB-102.

d. PUSH-TO-TALK CIRCUIT. Any microphone, handset or chestset normally used with the control unit provides a manually operated switch which serves to connect and disconnect the microphone without disturbing the connec-

tion to the headphone. When this switch is actuated the microphone is connected in series with the positive leg of the 12 volt d-c supply and the primary of the audio input transformer. Actuating this switch also connects a third contact to the 12-volt d-c supply and thereby actuates relay K101.

e. **EARPHONE MUTING AND CARRIER-ON INDICATION.** The earphone muting and carrier-on indication functions are accomplished by actuation of the six pole double throw relay, K101. This relay, as explained in paragraph 4d, is energized when the push-to-talk circuit is completed. When the relay is energized, two poles are connected directly to the positive leg of the 12 volt d-c supply to actuate the push-to-talk relay in the controlled transmitter through the connection at terminal 11 on terminal board TB-101, and energizes the CARRIER-ON indicators of all

parallel connected control sets, through the connection provided by terminal 12 of terminal board TB-101. Two poles of the relay are connected to each leg of the audio output line which connects to the external speaker amplifier. Energizing the relay opens the direct connection to the speaker amplifier and electrically connects the earphone muting control, R104, between the receiver output and earphone input, allowing the audio level to be attenuated to the desired degree.

4-3 TEST PROCEDURES

The Radio Set Control, Model C-1138A/UR is similar to other models of remote radio set controls currently used by the Navy. No new test procedures are involved in testing the unit.

SECTION 5 TROUBLE-SHOOTING

5-1 GENERAL

The Radio Set Control, Model C-1138A/UR, incorporates 3 types of circuits, the transmitter control circuits, transmitter input circuits and receiver output circuits. Malfunctioning in one circuit does not affect the functioning of others.

5-2 THEORY OF LOCALIZATION

Assuming a properly operating transmitter and receiver, inability to energize the transmitter or the push-to-talk relay in the transmitter indicates the trouble is in the transmitter control circuits. Inability to modulate the transmitter indicates the trouble is in the transmitter input circuits. Inability to monitor the receiver output indicates the trouble is in the receiver output circuits.

5-3 UNIT TROUBLE SHOOTING

a. EQUIPMENT. Trouble-shooting requires use of an a-c, d-c voltmeter (multimeter) having an internal resistance not less than 1000 ohms per volt.

b. VOLTAGE CHECKS. With the unit connected to a properly functioning transmitter and receiver the voltages should be as tabulated in Table 5-1. Microphone voltage should approximate 2 volts a-c with a loud speaking voice.

c. After checking the unit for broken wires and/or defective solder connections, use the procedure outlined in Table 5-2 to locate defective components.

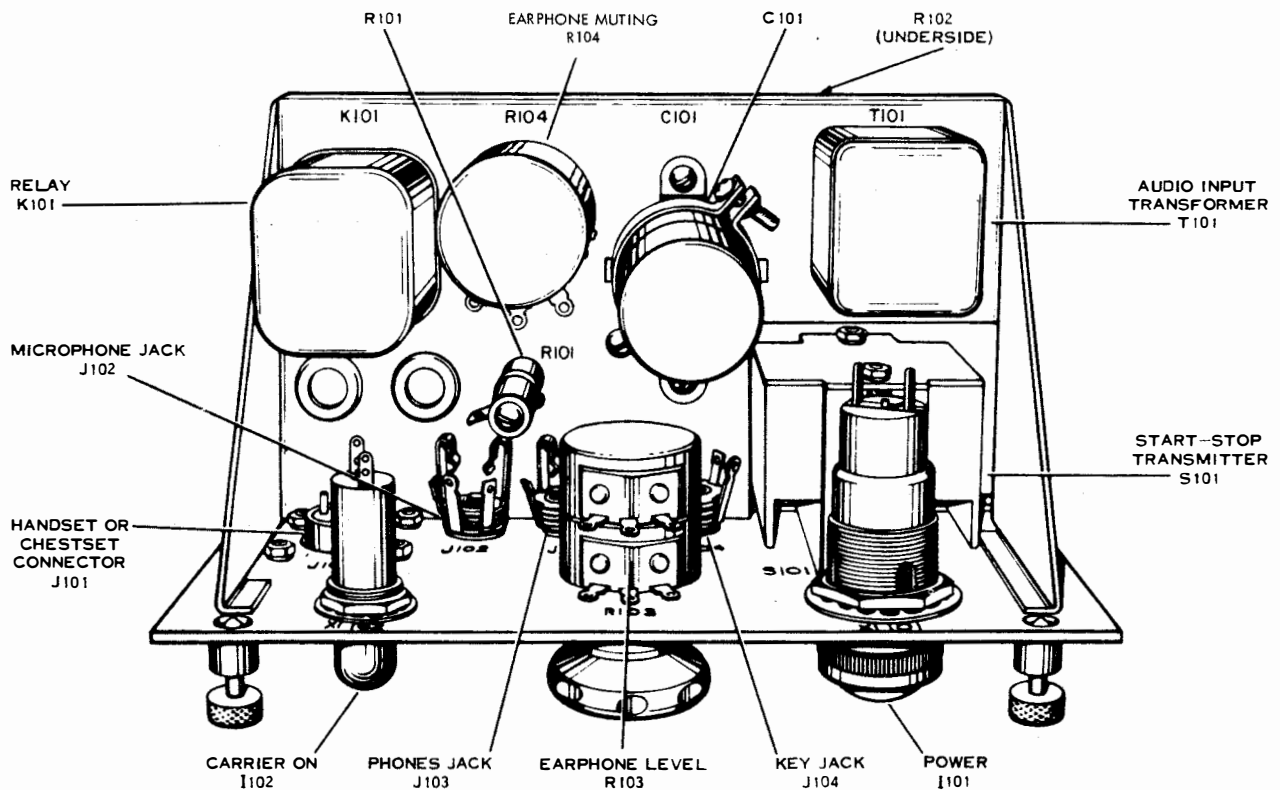

FIGURE 5-1. MAIN CHASSIS, SHOWING LOCATION OF COMPONENTS

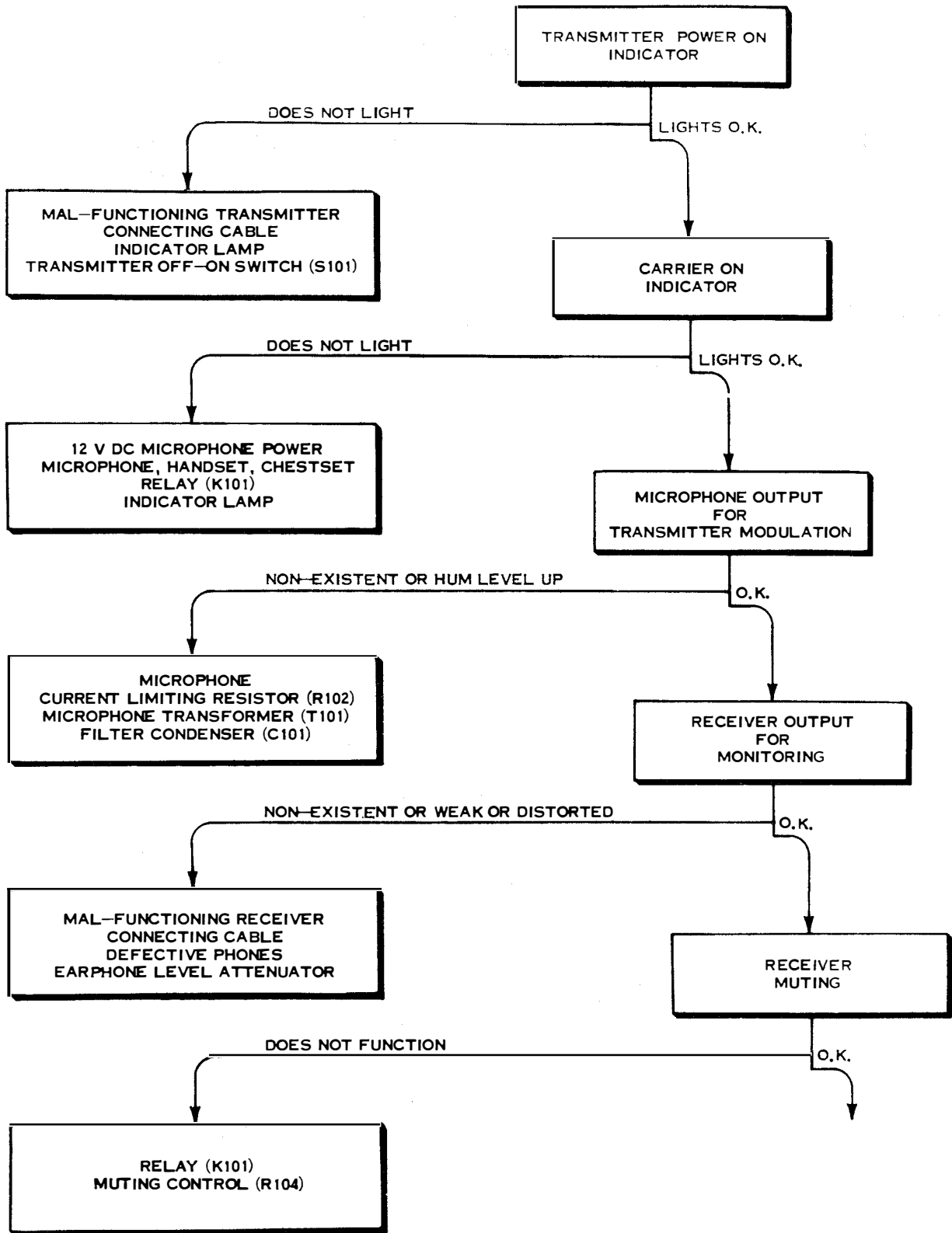
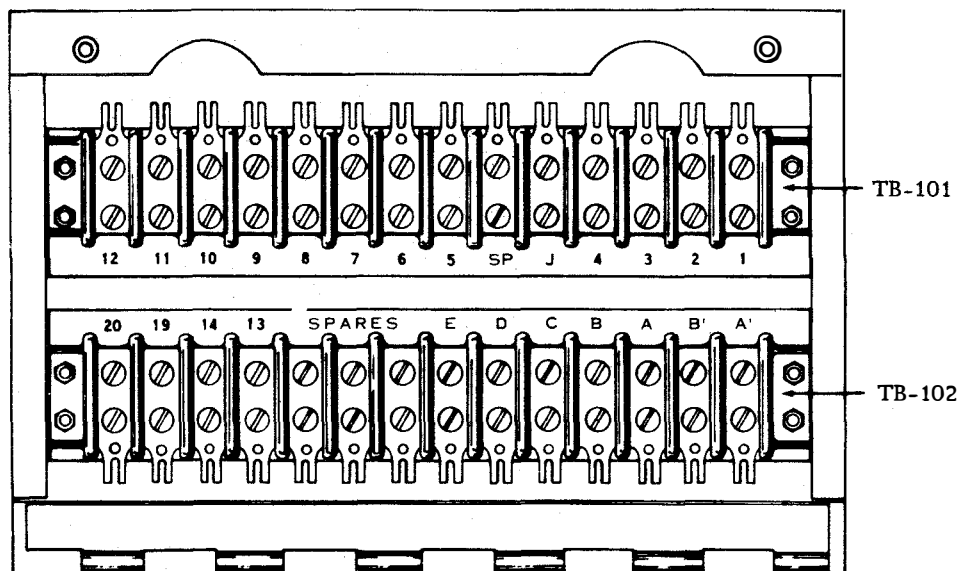

FIGURE 5-2. TROUBLE SHOOTING CHART



TERMINAL	FUNCTION	
Terminal Board TB-101	1	POWER BUS 115/230 V AC OR DC
	2	POWER ON CONTROL BUS
	3	POWER OFF CONTROL BUS
	Ø 4	POWER BUS 115/230 V AC OR DC ONE CONNECTION POINT FOR JUMPER PLATE FOR 115 V OPERATION
	J	COMMON CONNECTION POINT FOR JUMPER PLATE FOR 115 VOLT OR 230 VOLT OPERATION
	SP	SPARE CONTACT USED EXCLUSIVELY FOR JUMPER STOWAGE ON 230 V OPERATION
	5	KEY OUTPUT-RING
	6	KEY OUTPUT-TIP
	7	NEGATIVE 12 V INPUT
	8	POSITIVE 12 V INPUT
	9 } 10 } 11 } 12 }	600 OHM LINE-MICROPHONE OUTPUT TO TRANSMITTER
	Terminal Board TB-102	13 } 14 } 19 } 20 }
A' } B' } A } B }		RECEIVER AUDIO OUTPUT FOR SPEAKER AMPLIFIER
C } D }		600 OHM LINE-RECEIVER AUDIO INPUT TO CONTROL UNIT, SAME AS 13 AND 14
E		600 OHM HEADSET OUTPUT
SPARES		MICROPHONE INPUT, CARBON SINGLE BUTTON
		POSITIVE 12 V SUPPLY
		CARRIER ON RELAY CONTROL LEAD
		THREE SETS OF SPARE TERMINALS

FIGURE 5-3. VIEW OF TERMINAL BOARDS TB-101 AND TB-102

TABLE 5-1. VOLTAGE MEASUREMENTS.

TERMINAL BOARD	POTENTIAL BETWEEN CONTACTS	VOLTAGES	TYPE	OPERATING CONDITION
TB-101	1 and 2	Slightly less than 115V or 230V (Depending on ship's system)	AC or DC (Depending on ship's system)	"START" not energized
TB-101	1 and 2	Zero		"START" energized
TB-101	2 and 4	115V or 230V (Depending on ship's system)	AC or DC (Depending on ship's system)	All conditions
TB-101	2 and 3	Slightly less than 115V or 230V (Depending on ship's system)	AC or DC (Depending on ship's system)	"START" not energized
TB-101	1 and J	115V	AC or DC	Either 115V or 230V operation. Jumper should be in proper position for voltage used.
TB-101	5 and 6	Not in excess of 175V	DC	When CW operation is used
TB-101	7 and 8	Nominal 12V (11 minimum to 14 maximum)	DC	All conditions
TB-101	9 and 10	Approx 4V RMS	Audio AC 200-3000 CPS	When speaking in microphone
TB-101	7 and 11 7 and 12	Nominal 12V	DC	Only when push-to-talk switch is operated
TB-102	19 and 20	Approx 15V RMS (Maximum)	Audio AC 200-3000 CPS	Only when receiver audio output is at maximum level and push-to-talk not depressed
TB-102	13 and 14	Approx 15V RMS (Maximum)	Audio AC 200-3000 CPS	When receiver is delivering maximum audio output
TB-102	A' and B'	Same as terminals 13 to 14		
TB-102	A and B	Approx 15V RMS Maximum variable with earphone level control	Audio AC 200-3000 CPS	"Earphone level" at maximum CW rotation and receiver delivering maximum audio output
TB-102 TB-101	C and 8	Nominal 12V	DC	With all microphones disconnected
TB-102 TB-101	D and 7	Nominal 12V	DC	All conditions
TB-102 TB-101	E and 8	Slightly less than 12V	DC	Push-to-talk not depressed
TB-102 TB-101	E and 8	Zero		Push-to-talk switch depressed

SECTION 6

REPAIR

6-1 FAILURE REPORT

"Report each failure of the equipment, whether caused by a defective part, wear, improper operation, or an external cause. Use ELECTRONICS FAILURE REPORT form DD737. Each pad of the forms includes full instructions for filling out the forms and forwarding them to the Bureau of Ships. However, the importance of providing complete information cannot be emphasized too much. Be sure that you include the model designation and serial number of the equipment (from the major unit identification plate) and the type number and reference designation of the particular defective part (from the technical manual). Describe the cause of the failure completely, continuing on the back of the form if necessary. Do not substitute brevity for clarity. And remember — there are two sides to the failure report.

"YOUR SIDE"

Every FAILURE REPORT is a boost for you:

1. It shows that you are doing your job.
2. It helps make your job easier.
3. It insures available replacements.
4. It gives you a chance to pass your knowledge to every man on the team.

Always keep a supply of failure report forms on board. You can get them from the nearest forms and Publications Supply Point.

6-2 TEST EQUIPMENT AND SPECIAL TOOLS

No special tools are required for the repair of this equipment. A Voltohmmeter and soldering iron are the basic tools required.

6-3 LOCATION OF PARTS

See figure 3-1 and 5-1 for the location of parts.

6-4 ADJUSTMENTS

The earphone muting control R-104 is preset and locked at 10,000 ohms.

"BUREAU SIDE"

"The Bureau of Ships uses the information to:

1. Evaluate present equipment
2. Improve future equipments.
3. Order replacements for stock.
4. Prepare field changes.
5. Publish maintenance data.

If during the operation, audio feedback occurs, open the Radio Set Control Unit and advance R-104 until the audio squeal ceases. During transmission relay K-101 is energized and the audio line to the speaker amplifier is opened. R-104 permits partial muting of the handset audio, thus allowing monitoring of transmission at a greatly reduced level.

6-5 LUBRICATION

Radio Set Control C-1138A/UR requires no lubrication.

SECTION 7

PARTS LIST

7-1 INTRODUCTION

Reference designations (previously referred to as circuit symbol, reference symbol, etc.) have been assigned to identify all maintenance parts of the equipment. They are used for marking the equipment (adjacent to the part they identify) and are included on drawings, diagrams, and the parts list. The letters of a reference designation indicate the kind of part (generic group) such as resistor, amplifier, electron tube, etc. The number differentiates between 101 to 199. Two consecutive series of numbers have been assigned to major units in which there are more than one hundred parts of the same generic group. Sockets associated with a plug-in-device, such as an electron tube or a fuse, are identified by a reference designation which includes the reference designation of the plug-in-device. For example, the socket for fuse F101 is designated XF101.

7-2 MAINTENANCE PARTS LIST

Table 7-1 lists the major unit and its maintenance parts.

Column 1 lists the reference designation of the various parts in alphabetical and numerical sequence.

Column 2 includes the name and description of the various items. Complete information is provided for all

key parts (a part that differs from any part previously listed in the table) and sub-key parts (a part that is identical to a key-part, but appears for the first time for a given major unit). The name and description is omitted for other parts. However, reference is made to the key part or sub-key part for the data.

Column 3 indicates how the part is used and provides its functional location in the equipment.

7-3 STOCK NUMBER IDENTIFICATION

New Stock Number Identification Tables (SNITS) issued by the Electronics Supply Office include Federal Stock Numbers and Source Maintenance and Recoverability Codes. Therefore, reference shall be made to the SNIT for this information.

7-4 LIST OF MANUFACTURERS

Table 7-2 lists manufacturers of parts used in the equipment. The first column includes the abbreviations used to identify manufacturers.

TABLE 7-1. MAINTENANCE PARTS LIST

REFERENCE DESIGNATION	NAME AND DESCRIPTION	LOCATING FUNCTION
C101	CAPACITOR: Fixed electrolytic; 100 microfarads; 25 WVDC; hermetically sealed in metal can; mounts in standard medium octal socket. MIL type CE51C101F MIL-C-62	Audio bypass
E101	KNOB: Round; with pointer; molded black phenolic; 1-1/2 in. dia.; with brass insert; 2 set crews. Navy drawing RE10F479IT.4	EARPHONE LEVEL control knob
H101	CAPTIVE THUMB SCREW: 10-32 thd; stainless steel; 1/2 in. dia. knurled head; over-all length, 1-1/16 in.	Secures hinged front panel to case when shut.
H102	CLAMP: Capacitor holding; 1-1/4 in. dia.; mounting centers, 1-3/4 in. CD 18573.	Locks capacitor C101 in socket.
I101	LAMP: Candelabra screw base, S-6 bulb; 230 to 250 volts; 10 watts. CG10S6/10-250.	POWER ON indicator light.
I102	LAMP: Miniature bayonet base; T-3-1/4 bulb; 12 to 16 volts; 0.100 amperes. CAYZ 1813	CARRIER ON indicator light.
J101	CONNECTOR: Receptacle; AN type; 5 contact. MIL type MS3102-14S-5S Spec MIL-C-5015C	Input connector for HANDSET OR CHESTSET.
J102	JACK: Telephone; for 0.205 in. dia. 1.093 in. lg., 3 circuit plug; over-all dimensions, 1-1/4 lg. by 15/16 in. dia. CBIM XA1570	Input jack for MICROPHONE
J103	JACK: Telephone; for 0.250 dia. 1.218 in. lg., 3 circuit plug; over-all dimensions, 1-1/4 in. by 15/16 in. dia. CBIM XA1571	Output jack for PHONES.
J104	Same as J103	Input jack for key.
K101	RELAY: Six pole, double throw; 12 volt dc coil; hermetically sealed metal case; over-all dimensions, including terminals, 1-3/8 wide by 1-1/2 lg by 2-1/2 in. high. CCHD TQ6C12VD-S3A.	Operates CARRIER ON indicator light and places earphone muting control in circuit when microphone or handset switch is operated and turns speaker off.
R101	RESISTOR: Fixed, wirewound; 3500 ohms, $\pm 10\%$; 10 watts; tubular; tab terminal. MIL type RW31G352 Spec. MIL-R-26.	Voltage dropping resistor for POWER indicator lamp I101 to give 1/2 rated voltage.
R102	RESISTOR: Fixed, wirewound; 160 ohms, $\pm 5\%$; 2 watts; axial leads, CIR BW-2.	Microphone current limiting Resistor
R103	ATTENUATOR: Variable, wirewound; two sections; panel, 850 ohms, $\pm 10\%$; rear, 600 ohms, $\pm 10\%$, 2 watts per section, split taper each section CTC 2-252	L pad attenuator; 600 ohm impedance; for EARPHONE LEVEL adjustment.

TABLE 7-1. MAINTENANCE PARTS LIST

REFERENCE DESIGNATION	NAME AND DESCRIPTION	LOCATING FUNCTION
R104	RESISTOR: Variable, composition, 25,000 ohms, $\pm 10\%$; 2 watts; screw driver slot with lock. MIL type RV4LAYS253A Specification MIL-R-94A	Earphone muting control
S101	SWITCH ASSEMBLY: Two circuits normally open; two push buttons, one red engraved STOP, one black engraved START; 1 ampere per section at 220 volts. CAE E20412A.	START-STOP TRANSMITTER for remote radio control
T101	TRANSFORMER: Audio frequency line-type; primary impedance 25 ohms at 50 ma. dc; secondary, 600 ohms center tapped; response flat, 250 to 4000 cps ± 1 db; metal case hermetically sealed; over-all dimensions, 1-1/2 by 1-5/16 by 1-13/16 in. Oscar Shott SO542	
TB101	TERMINAL BOARD: Barrier style; 14 terminals with lugs and 6-32 binder head screws; MAI-60 phenolic, overall dimensions, 6-7/8 CBZG 601-3/4 STI4 MAI60	Connection point external wiring to control box.
TB-102	Same as TB-101	Same as above.
XC101	SOCKET: Medium octal; mica filled; phenolic body; silver plated contacts; stainless steel saddle; mounting hole, 1-1/8 in. mounting centers, 1-1/2 in. CPH 74-8TM.	Socket for C101
XI101	LAMPHOLDER ASSEMBLY: Red Jewel; 1 in. dia. for S-6 candelabra screw base bulb. CAYZ 51101-111.	Holder for POWER indicator lamp I101
XI102	LAMPHOLDER ASSEMBLY: Green jewel; 19/32 dia; for T-3-1/4 miniature bayonet CAYZ52410-992.	Holder for CARRIER ON indicator lamp I102
XI101A	LENS: Lampholder; red; frosted inside; 1-1/8 in. dia.; 1 in. dia. thd., 27 per in. CAYZ 80-111.	Provides red indication for POWER indicator lamp I101
XI102A	LENS: Lampholder; green; 19/32 dia.; 3/16 in. lg. thd; 9/16 in. dia. thd, 27 per in. CAYZ 52-992.	Provides green indication for CARRIER ON indicator lamp I102

TABLE 7-2. LIST OF MANUFACTURERS

ABBREVIATIONS	NAME	ADDRESS
CAE	Cutler Hammer, Inc.	Milwaukee, Wis.
CAYZ	Dialight Corp.	Brooklyn, N. Y.
CBIM	Switchcraft, Inc.	1310 N. Halstead St. Chicago 22, Illinois
CCHD	Advance Electric and Relay Co.	Burbank, California
CD	Cornell-Dubilier	South Plainfield, N. J.
CG	General Electric	Newark, N. J.
CIR	International Resistance Corp.	401 N. Broad St. Philadelphia, Pa.
CPH	Amphenol Electronics Corporation	1830 South 54th Ave. Chicago, Illinois
CTC	Chicago Telephone Supply Co.	Elkhart, Indiana
CBZG	Kulka Electric Mfg. Co.	Mount Vernon, N. Y.
Oscar Schott	Oscar Schott Co.	Minneapolis, Minn



INDEX

SUBJECT	FIGURE OR TABLE	SECTION & PAGE	PARAGRAPH
A			
Audio Circuitry.	4-1	4-2c
C			
Cabling.	2-1	2-2c
Capabilities and Limitations	3-0	3-2
Circuit Analysis	4-1	4-2
E			
Earphone Level Control.	3-0	3-3c
Earphone Muting and Carrier-on Indication	4-2	4-2e
Equipment Supplied	1-1	1-1	...
F			
Failure Reports	6-1	6-1
Functional Description	1-1	1-3
G			
General Description of Circuits.	4-1	4-1
I			
Initial Adjustments	2-1	2-3
Installation	2-1	2-2
Introduction (General Information)	1-1	1-1
Introduction (Operator's Section)	3-0	3-1
Introduction (Parts List).	6-1	6-1
L			
List of Effective Pages	ii	...
List of Illustrations.	vi	...
List of Manufacturers	7-2	7-3	...
List of Tables.	vi	...
Locations, Installation	2-1	2-2a
Location of Controls.	3-1	3-0	...
Lubrication	6-1	6-5
M			
Maintenance Parts List	7-1	7-1	...
Mounting, Installation	2-1	2-2b

INDEX (Continued)

SUBJECT	FIGURE OR TABLE	SECTION & PAGE	PARAGRAPH
O			
Operation	3-0	3-3
P			
Power On Indication	4-1	4-2b
Promulgating Letter	iii	...
Push-to-Talk Circuit	4-1	4-2d
R			
Radio Set Control C-1138A/UR			
Cable Stuffing Plates and Terminal Boards	2-2	2-1	...
Front Panel	3-1	3-0	...
Installation Drawing	2-1	2-0	...
Main Chassis, Showing Locations of Components	5-1	5-1	...
Overall View	1-1	1-0	...
Schematic Diagram	4-1	4-0	...
View of Terminal Boards TB-101 and TB-102	5-3	5-3	...
Receiver Output Circuits	4-1	4-1c
Record of Corrections Made	iv	...
Reference Data, Quick	1-1	1-4
Routine Check Chart	3-1	3-1	...
Routine Check, (Operator's Maintenance)	3-1	3-4
S			
Start-Stop Control	4-1	4-2a
Stock Number Identification	7-0	7-3
T			
Table of Contents	v	...
Technical Manual Coverage	1-1	1-2
Test Procedures	4-2	4-3
Theory of Localization, (Trouble Shooting)	5-1	5-2
Transmitter Control Circuits	4-1	4-1a
Transmitter Input Circuits	4-1	4-1b
Transmitter Input Circuits	3-0	3-3b
Transmitter Off-On Switch	3-0	3-3a
Trouble Shooting Chart	5-2	5-2	...
Trouble Shooting Equipment	5-1	5-3a
U			
Unit Trouble Shooting	5-1	5-3
Unpacking	2-1	2-1
V			
Voltage Checks	5-1	5-3b
Voltage Measurements	5-1	5-4	...