

TOPIC 4

TECHNICAL CONTROL EQUIPMENTS

INTRODUCTION

The Technical Control Facility (TCF) provides the means to interconnect various baseband and audio signal-processing equipments to form a number of communications systems used by a Naval Security Group (NAVSECGRU) or Special Intelligence Communications (SPINTCOMM) facility. The TCF can monitor signal quality, isolate a system's malfunctioning equipment, and patch in spare equipment to restore service to a communications link on a terminal position. A baseband signal, in the context of this topic, refers to the data signal before it modulates a carrier or subcarrier to form the transmitted line or radio signal.

RELATIONSHIP TO OTHER SYSTEMS

The technical control equipments interface with a variety of communications systems. These systems process both computer data and low-level teletype signals. Computer data, with its associated timing and control signals, appears on the multicircuit patch panels in the TCF. Teletype signals appear on either multicircuit patch panels or on low-level, teletype patch panels. These single-line, signal flow systems used by NAVSECGRU and SPINTCOMM personnel are described briefly in the following paragraphs.

STREAMLINER SYSTEM

STREAMLINER is a store-and-forward system that interfaces with the Automatic Digital Network (AUTODIN). Operator positions within the NAVSECGRU and other communications systems are terminated into the STREAMLINER system. See figure 4-1.

TACTICAL INTELLIGENCE (TACINTEL) SYSTEM

TACINTEL is a ship-to-shore communications system that operates over a satellite link. It interfaces with STREAMLINER and local operator positions through the TCF equipment. See figure 4-2.

OPERATIONAL INTELLIGENCE (OPINTEL) SYSTEM

OPINTEL uses the broadcast channels dedicated to broadcasting OPINTEL information to NAVSECGRU units afloat. It interfaces with STREAMLINER via the multicircuit patch panel. It also interfaces with the selected transmission system via the low-level BLACK patch panels. See figure 4-3.

OPERATIONAL COMMUNICATIONS (OPSCOMM) AND ALTERNATE SHIP-TO-SHORE COMMUNICATIONS SYSTEM

OPSCOMM supports TACINTEL by providing an alternate ship-to-shore circuit over a High-Frequency (HF) communications link. OPSCOMM interfaces with STREAMLINER, local operating positions, and the selected transmission systems through the TCF equipment. See figure 4-4.

MULTIPLE-USER SPECIAL INTELLIGENCE COMMUNICATIONS (MUSIC) SYSTEM

MUSIC is a completely automated communications system that interfaces and performs

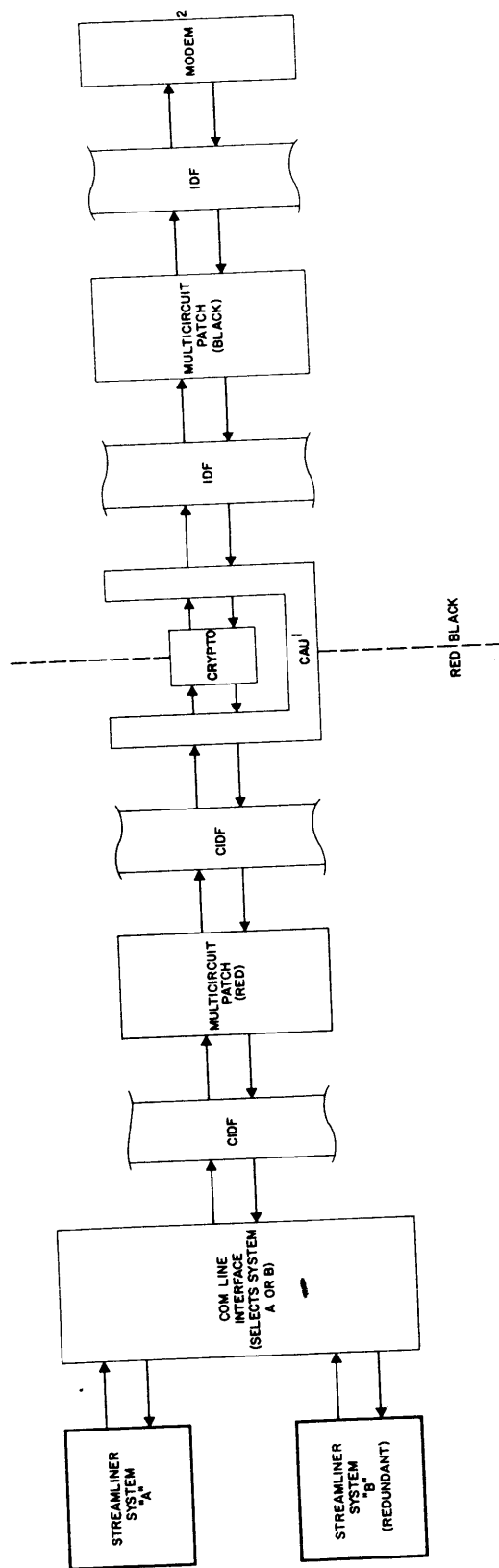

1.23

Figure 4-1.—STREAMLINER/TCF signal flow diagram.

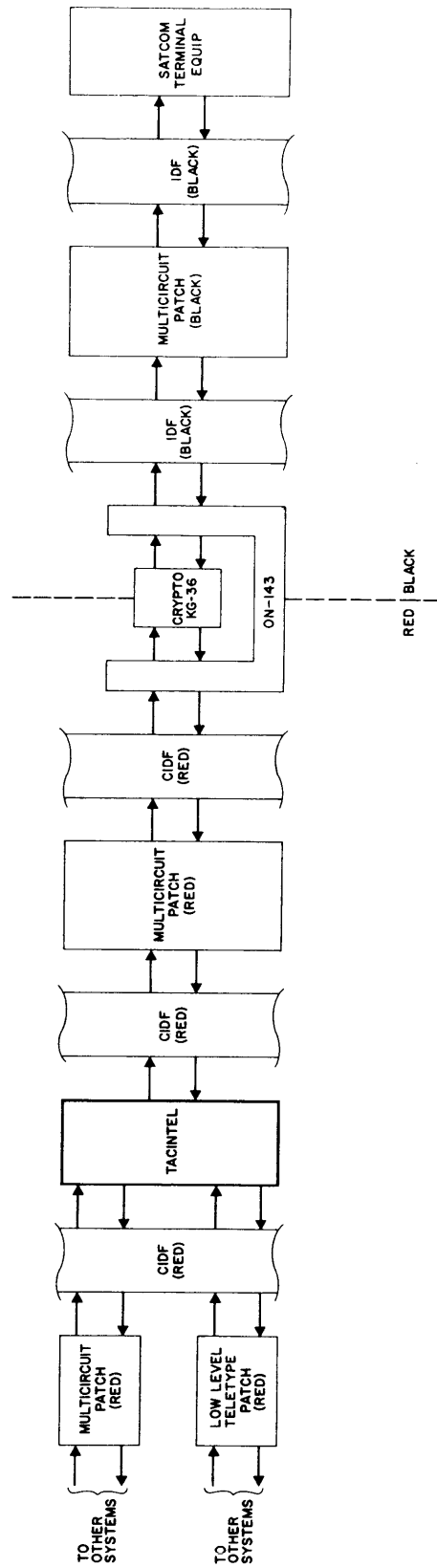

1.23

Figure 4-2.—TACINTEL/ICF signal flow diagram.

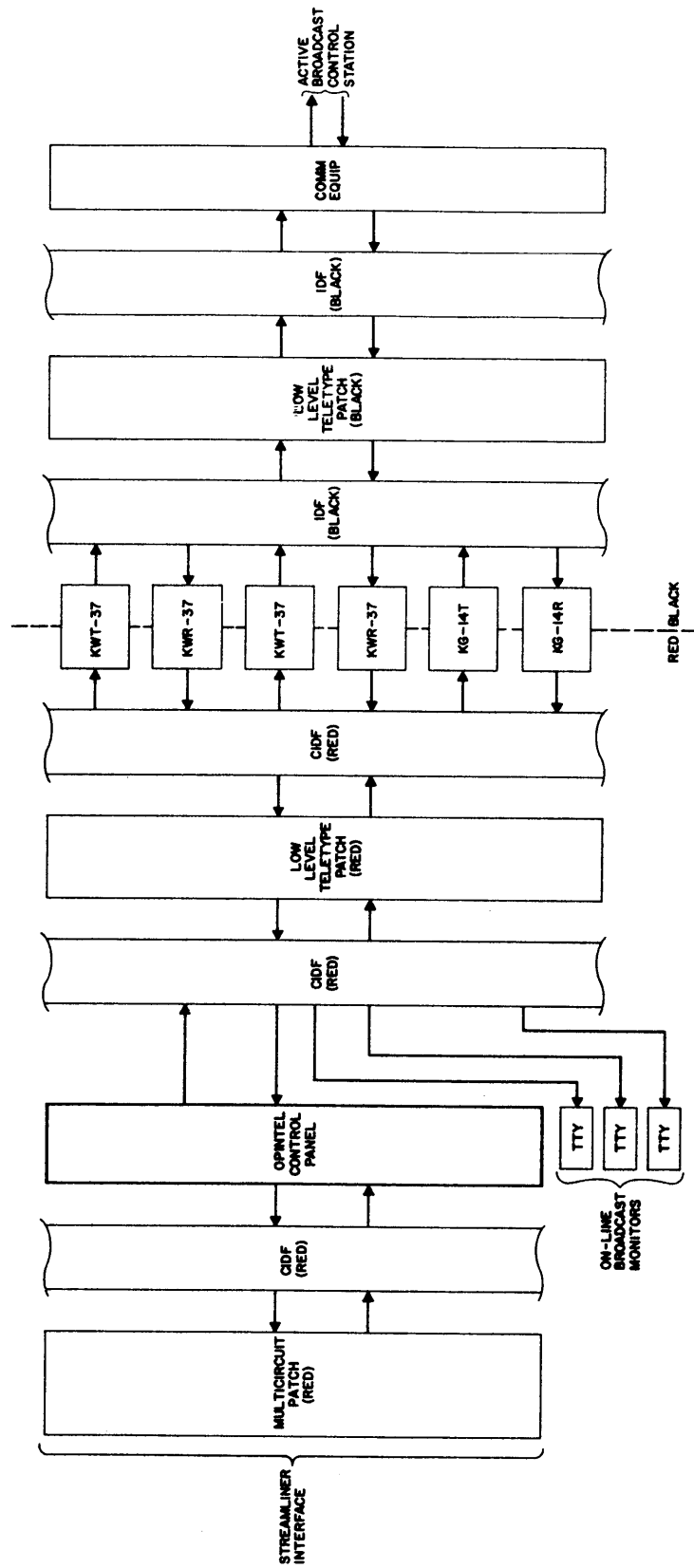

1.23

Figure 4-3.—OPINTEL broadcast/TCF signal flow diagram.

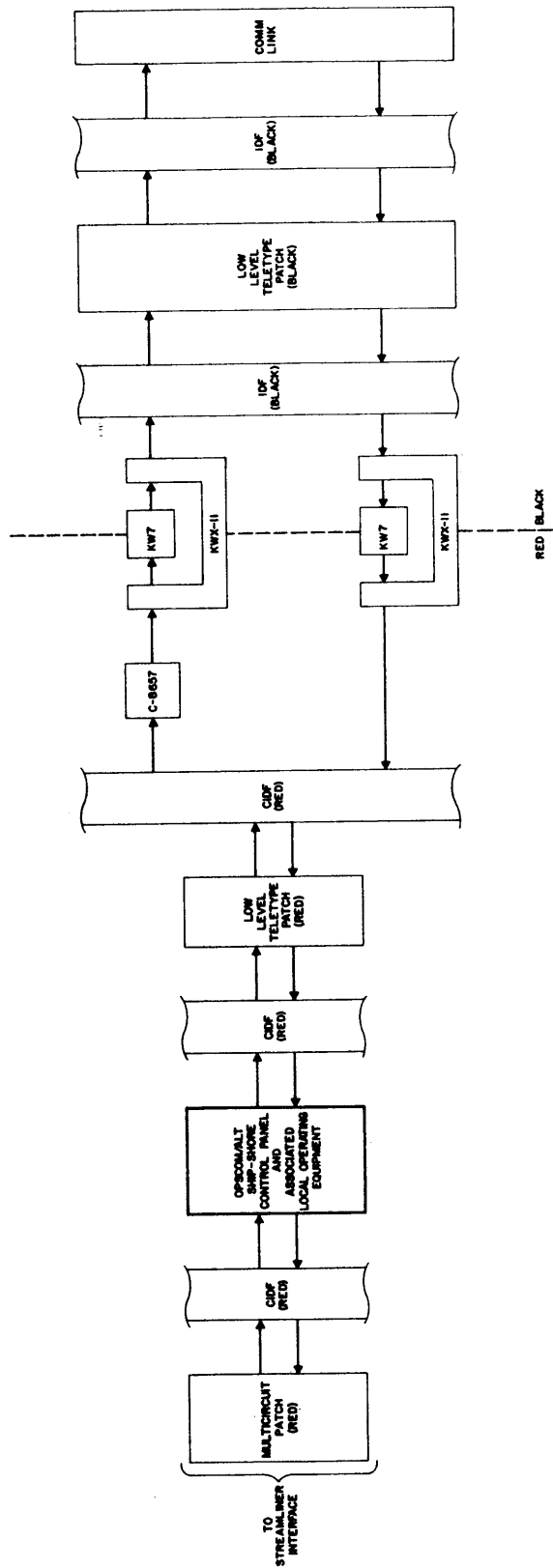

1.23

Figure 4-4.—OPSCOMM (alternate ship-to-shore)/TCF signal flow diagram.

message reformatting between STREAMLINER, TACINTEL, and OPSCOMM. See figure 4-5.

MAJOR SYSTEM ELEMENTS

Figure 4-6 shows a simple, technical control, single-line, full-duplex, patching system. Each area represents components used to provide patching, power protection, and control of the communications circuits.

The function of each component is distinct, but reliant on the others for smooth operation in the overall process of technical control. The following paragraphs will briefly describe the purpose of each of the technical control equipments.

TERMINAL BOX, J-2885/UG

The terminal box is housed in a ferrous enclosure and is designed for floor mounting.

It can be used for main distribution frame, intermediate distribution frame, or classified intermediate distribution frame installation. Sixteen 10×26-row terminal blocks are mounted vertically in the front half of the distribution frame and sixteen 10×26-row terminal blocks are mounted horizontally in the rear half. The terminal box has a capacity of 4,000 pairs of electrical connections. The terminal box is used to cross-connect the various equipments and signal lines within a functional area. No operator attention is required for the terminal box. However, the station maintenance force should keep a complete record of all cross-connections.

TERMINAL BOARDS

Most terminal boards used on the distribution frames are similar in that each terminal board consists of terminals mounted in a wood or plastic

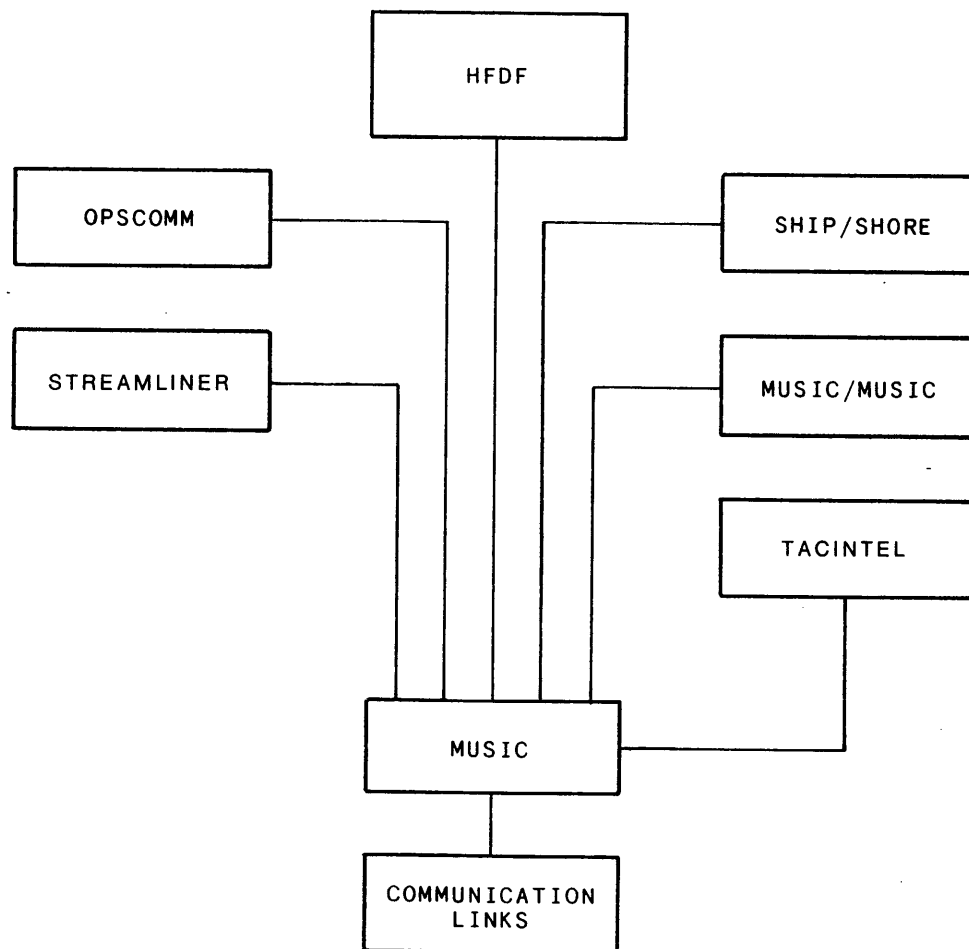
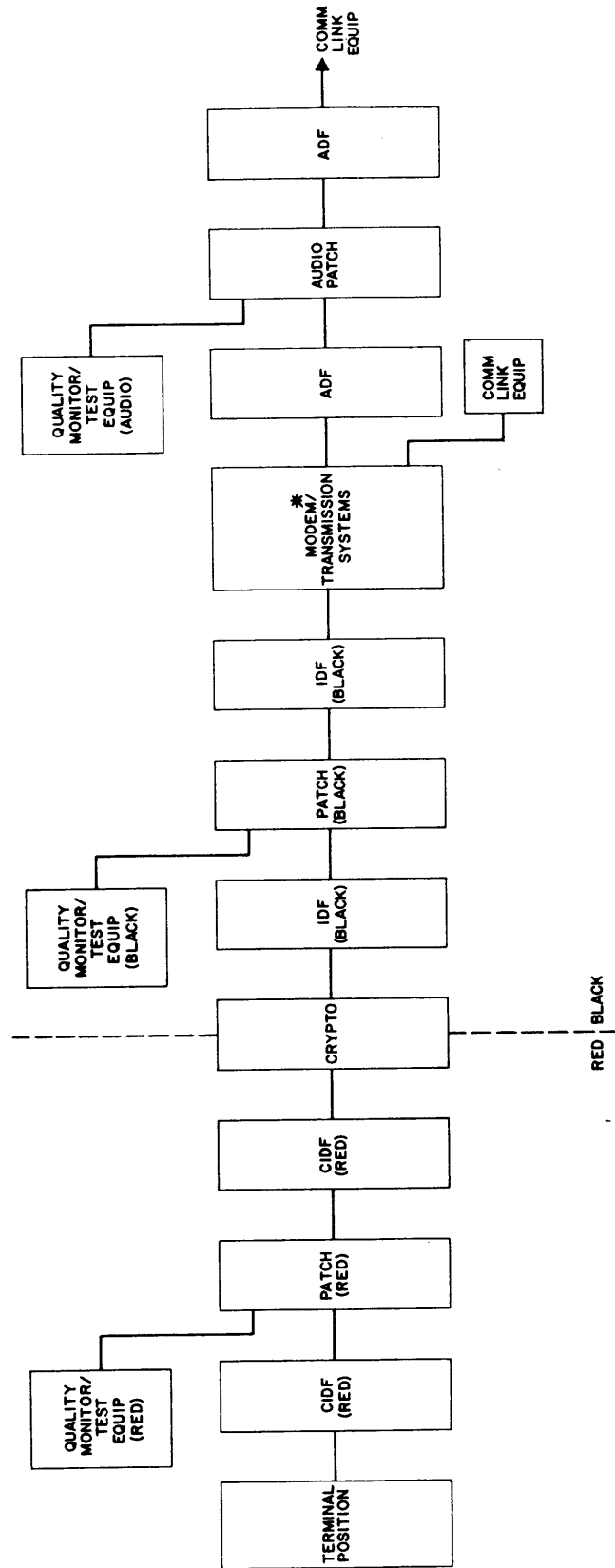

Figure 4-5.—MUSIC/TCF signal flow diagram.



1.23

Figure 4-6.—Technical control single-line, signal flow diagram.

block as shown in figure 4-7. The terminals appear in different lengths or tiers, arranged in a *Christmas tree* fashion. The purpose of using different lengths of terminals is to minimize soldering errors. Since the terminals are unmarked, pair numbers are stenciled on the block.

DISTRIBUTION FRAMES

Distribution frames are open metal frameworks that provide neat and accessible terminating

facilities for outside cable pairs and in-house wiring to patching bays and equipment items. On all types of distribution frames, cross-connections between terminal blocks are made by means of relatively short lengths of paired wires, called *jumpers*. Distribution frames enable the greater part of the wiring in a technical control center to remain permanent. If, for example, a cable pair connection must be changed from one patchbay to another, it is only necessary to move a jumper. Distribution frames used in typical TCFs include main distribution



Figure 4-7.—Mainframe terminal boards.

frames, intermediate distribution frames, and classified intermediate distribution frames.

Main Distribution Frame (MDF)

The MDF is the division point between a communications component and the outside. It is configured of horizontal and vertical terminal blocks. The horizontal blocks terminate circuit cables entering the building. Vertical blocks terminate cables supporting circuit distribution within the building.

Intermediate Distribution Frame (IDF)

The IDF provides a means for interconnecting cables that distribute encrypted or unclassified baseband signals among equipment of the BLACK side of the TCF and the modem or transmission system.

Classified Intermediate Distribution Frame (CIDF)

The CIDF provides a means for interconnecting the cables that distribute classified signals between terminal, TCF, and classified signal-processing equipment.

AUDIO PATCH PANEL

The audio patch panel allows the TCF operator to distribute audio signals to and from the modem or transmission systems and communications link equipment. As with the other patch panels, the audio patch panel allows the operator to monitor signal quality, isolate malfunctioning equipment from a communications system, and substitute spare equipment.

UNCLASSIFIED (BLACK) PATCH PANEL

The BLACK patch panel allows the TCF operator to distribute encrypted or unclassified baseband signals to the appropriate modem or transmission system, monitor signal quality, isolate malfunctioning equipment from a communications system, and substitute spare equipment, when necessary.

CRYPTO-EQUIPMENT

The crypto-equipment transforms classified baseband signals into a form suitable for processing over normal communications links without sacrificing the security of the information being transferred over the link. Cryptographic devices are designed for two types of service: end-to-end encryption and bulk encryption. In end-to-end encryption, which is used on dedicated lines, one cryptographic device is assigned to a single circuit at the transmitting end of the line, and another cryptographic device, with a matching key, is assigned to the circuit at the receiving end of the line. Bulk encryption operates on the multiplexed data stream of a number of channels, encrypting all channels simultaneously.

CLASSIFIED (RED) PATCH PANEL

The RED patch panel allows the TCF operator to distribute classified signals to the appropriate terminal positions and to classified, signal-processing equipment. It also permits the operator to monitor signal quality, isolate malfunctioning equipment, and substitute spare equipment, when necessary.

TERMINAL POSITION

The terminal position block represents the operator position or equipment, including any of the major communications systems serviced by the TCF. Another name for the terminal position is the *user*. The Model 40 and the Model 28 teletype (TTY) terminal positions are briefly described.

Model 40 Teletype Equipment

The Model 40 teletype equipment is a family of high-speed, telecommunications terminals, modular in design, and consisting of a CRT display, printer, keyboard, and magnetic tape cassettes. Terminals can be configured to satisfy different transmission and operational requirements.

Model 28 Teletype Equipment

The Model 28 teletype equipment is a low-speed (100 wpm), electro-mechanical communications terminal that consists of a mechanical printer, keyboard, paper-tape reader, and paper-tape punch.

STANDARD TELECOMMUNICATIONS TERMINAL DEVICE, ST2D

Project HAMSTRUNG is a program used to standardize the communications terminals in the cryptologic community. Currently, there is a combination of equipment that extends from maintenance-intensive Model 28s, with non-existent replacement parts, to expensive Model-40s. Upon implementation of HAMSTRUNG, the ST2D will be the standard communications terminal.

Each unit comes with the MIL-STD 188-114 and RS-232 interfaces and is preloaded with the UNIX-based operating system. The ST2D provides compatibility with industry standard, commercial software, standard interfaces to TEMPEST-accredited devices, multiple display options, key lock on/off switch, standard IBM and other commercial vendor hardware components, and a multifunctional reprogrammable keyboard. These features have been achieved by using commercially available parts that provide enhanced logistics and cost advantages.

The ST2D will use the 5310 printer, providing multicopy, full-duplex, data communications at speeds of 110 to 9600 bits per second, depending on the choice of letter quality. The printer can be converted to a keyboard printer by simply adding the detachable TEMPEST keyboard.

MODEMS

The word *modem* is derived from the initial syllables in MODulator and DEModulator. A modem is required if digital data are to be transmitted by modulation of a carrier. A modem is not required if baseband (dc pulse) transmission can be used. The modulator portion of a modem accepts source data and transforms them to a suitable form (analog or quasi-analog) for carrier modulation at the transmitting end of a circuit. At the receiving end, the demodulator portion of the modem restores the received modulation to the original digital data form. Modems are considered transparent converters,

since they provide a signal at the receiving terminal that is a replica of the transmitted signal. It is as though they were not in the circuit at all, as far as the source and sink are concerned. Figure 4-8 illustrates the typical data link using modems.

Connectivity

A modem can be either directly connected (hard-wired) into the circuit or indirectly connected (acoustically coupled). A hard-wired modem is, more or less, a permanent installation and, therefore, represents an inconvenience if a terminal is to be moved from place to place. However, because of its more solid connectivity, a hard-wired modem is less prone to noise and distortion errors. Hard-wired modems are normally used for high-speed teletype circuitry.

Timing

Certain modems obtain synchronization timing from external master clocks; others derive timing from the received pulse stream or from a stable "slave" clock. Still, others can operate with either an external clock or with internally derived timing. Although internal timing is extremely accurate, it is not as reliable as external timing with a master clock.

Automatic Synchronization

Automatic synchronization is achieved in some modems through the use of block framing of data. This technique requires that a fixed pattern of 0s and 1s (the frame pattern) be added to a frame of information bits. The frame pattern may be placed at the beginning or end of the data frame, or, in some cases, it may be distributed throughout the frame by interleaving. The size of the frame is set by the design of the modulation technique selected.

Automatic synchronization consists of searching through the frame of bits, advancing the search one bit per sweep through the frame, until the true frame pattern is recognized. Because bit

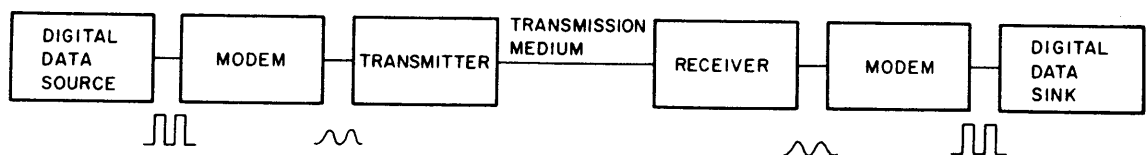

Figure 4-8.—Block diagram of a typical data link using modems.

errors are caused by impulse noise and distortion of pulse shapes, the frame pattern may not be recognized in a single search through the frame.

Most modems function automatically and require little or no adjustments by the technical control operator. See appendix VI for a detailed discussion of the controls and indicators of the CODEX LSI-9600 Modem.

DIGITAL LINE DRIVERS

A line driver is an integrated circuit for transmitting logic information through long lines. The transmission of signals at their original frequencies is called *baseband signaling* to distinguish it from carrier frequency transmission. Since there is no modulation of a carrier, there is no need for a modem. The data equipment can be connected directly to a wire line and the pulses sent out over the line. The line inductance and capacitance, however, distort the pulses in a very short distance, so this direct coupling is useful only for the lowest data rates. Some improvement in distance and data-rate performance can be provided by using a *line driver* to interface the data equipment with the line. Line drivers can also be used as repeaters to gain additional distance.

REGENERATIVE REPEATERS

These devices are used to re-time and re-shape digital signals for onward transmission. They are usually designed for a specific range of data rates and for specific signaling codes. They are intended for use before signals reach a maximum distortion limit of 49%.

REPEAT COIL

A repeat coil is a transformer used for Variable-Frequency (VF) energy transfer from one circuit to another. The coil is used to match circuit impedances for maximum transfer of energy or to connect unbalanced equipment to a balanced line.

LINE AMPLIFIER

The line amplifier is used in applications requiring VF amplification of up to 35 dB. In the

TCF, line amplifiers are inserted between the equal level board and the BLACK patch panel. Provision should be made for monitoring the VF signal levels at the input and the output of the line amplifier.

LINE EQUALIZER

As VF signals are transmitted through equipment and transmission channels, various frequency components are delayed in time and are distorted in amplitude with respect to each other. This may cause unsatisfactory transmission. The line equalizer produces an output envelope delay spread of less than 250 milliseconds (ms) when the input envelope is distorted by as much as 3 ms. In addition, the line equalizer provides for a 6-dB range of amplitude equalization of the affected frequencies.

DIGITAL MODULATION RATE CONVERTER

The modulation rate converter provides interface capability between start-stop and synchronous signals. The converter operates either in a send or receive mode, with one unit required at each end of a simple circuit.

In the *send* mode, the converter accepts, as an input, a start-stop/asynchronous 5- or 8-unit code at specific rates up to 300 baud. It also produces a synchronous output signal at any specified modulation rate up to 300 baud.

In the *receive* mode, the converter accepts a synchronous input signal at specified rates not exceeding 300 baud and produces an output start-stop/asynchronous 5- or 8-unit code. The output of both modes is a regenerated signal.

VOICE DIGITIZER

The voice digitizer converts the human voice to a digital bit stream suitable for full-duplex transmission. It is the ideal solution for creating a secure voice system that may operate over standard data networks. These systems are implemented by using the voice digitizer, a digital encryption device, and a modem. The voice digitizer permits a more effective utilization of data networks, since both speech and data may be transmitted simultaneously by using multiplexers.

TIME-DIVISION MULTIPLEXING TERMINAL, SMC-200

The SMC-200, figure 4-9, is a general-purpose, synchronous, time-division multiplexing system. The unit provides for the transmission of 32 synchronous data channels over a single, high-speed, transmission facility. Used in pairs, the system may be used with either internal or external clocking. The unit interfaces with modems or synchronous terminal equipment.

All synchronous circuits or channels to be multiplexed into a composite signal are

supplied clock from a single (master) clock frequency installed within the SMC-200. This is accomplished by dividing the master clock into submultiple rates corresponding to the desired channel rates. Each submultiple has a distinct and individual phase relationship to the master clock. This means only one channel of the SMC-200 will be sampled at a given time interval to transmit data. Efficient operation is achieved by the SMC-200, since the higher speed channels are sampled more frequently than those operating at a lower rate of speed.

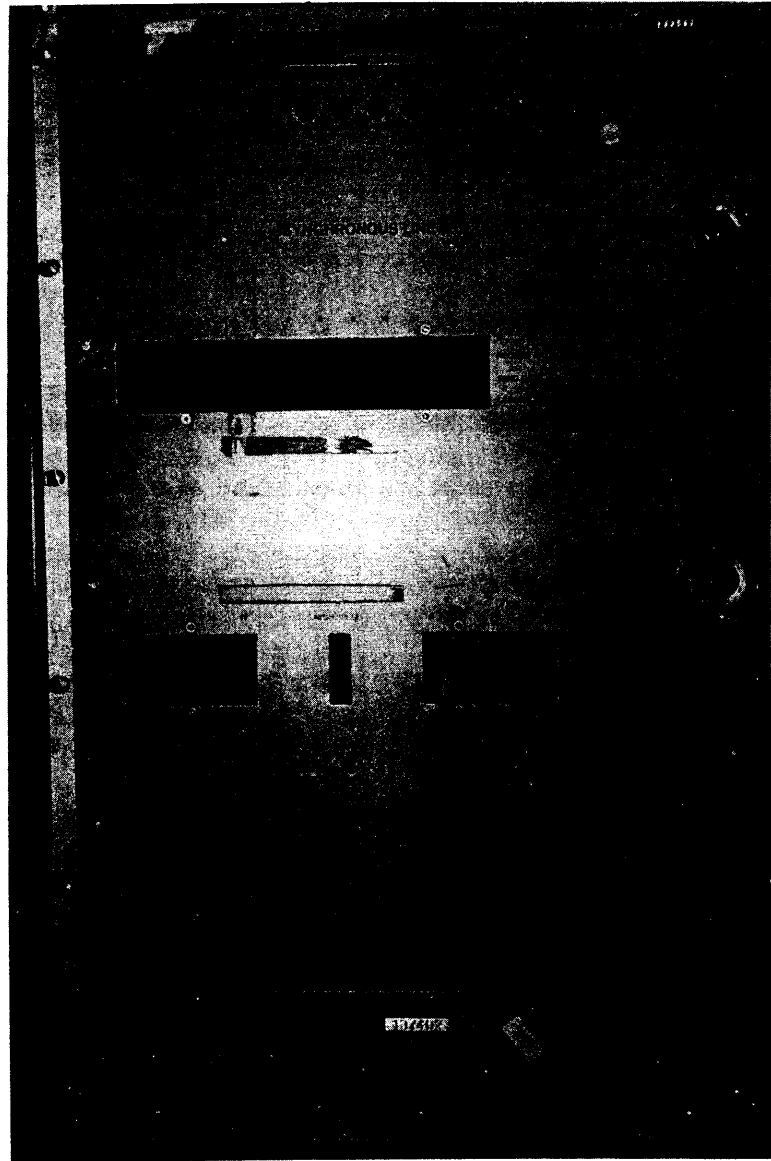

Figure 4-9.—Time-Division Multiplexing Terminal, SMC-200.

It is important to realize the following principles to avoid confusion of low-speed and high-speed terminology.

The SMC-200 has 32 channels for use by the terminal user. Regardless of the rate of any of the terminal user channels, they are all referred to as *low-speed channels* for testing or troubleshooting purposes. These channels can be looped either on the terminal side of the channel (low-speed loop of a low-speed channel) or on the aggregate or composite line side of the channel (high-speed loop of a low-speed channel).

The SMC-200 has one channel connected directly to the line for transmitting and receiving the high-speed composite signal. This channel is known as the *high-speed channel* and can be looped on the aggregate line side of the channel only (high-speed loop of a high-speed channel). The high-speed channel is common to all of the low-speed user channels. See appendix IV for an in-depth discussion on operating procedures for the SMC-200.

TIMEPLEX TIME-DIVISION MULTIPLEXING TERMINAL, T16/20/96

Timeplexers are general-purpose, time-division multiplexing systems, enabling transmission of large numbers of low-speed, asynchronous,

synchronous, and isochronous channel data over a single, dedicated, full-duplex voice or high-speed circuit. Model designations T-16, T-20, and T-96 are assigned to the timeplexers and reflect the maximum low-speed channel capacity of a particular unit. These units are normally used in pairs, with one timeplexer at each end of a transmission system. However, installations involving direct output into a computer at one end with a single timeplexer at the other, or more complex installations involving several timeplexers, are possible. Timeplexers interface with data sets, computers, and terminal equipment. They may be used in both analog and digital communications systems.

The timeplexer is housed in a metal cabinet with a see-through front panel that gives access to the operating controls and indicators. Test features are incorporated to facilitate performance checks and system fault isolation by an operator. Downtime is reduced through the use of plug-in card modules and a replaceable power supply. See appendix IV for a detailed description of the controls and indicators.

TIME-DIVISION MULTIPLEXING TERMINAL, AN/FCC-100

The AN/FCC-100 is a Low-Speed, Time-Division Multiplexer (LSTDM), capable of full-duplex, transmit-and-receive capabilities operating at speeds up to 256K bps. See figure 4-10. It

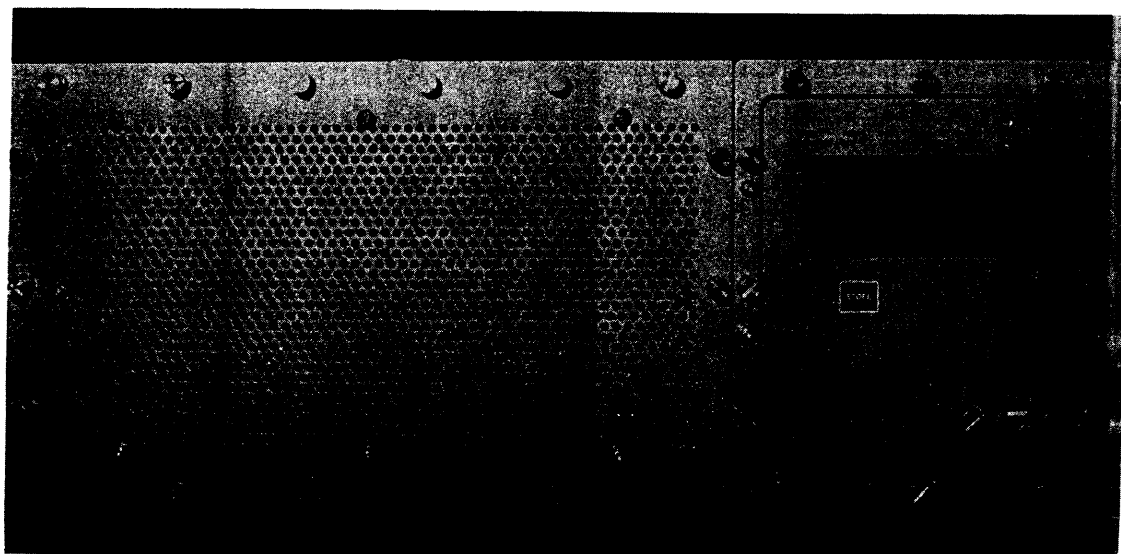

Figure 4-10.—Time-Division Multiplexing Terminal, AN/FCC-100.

317 15

provides 16 ports capable of handling any mixture of modulation analog data transmissions including:

- **Synchronous:** Data is composed of equal duration pulses that are accompanied by a separate clock signal.
- **Asynchronous:** Data is composed of start and stop pulses combined with data.
- **Isochronous:** Data is composed of equal pulses not associated with a clock signal.
- **Diphase Data Transmission (DIPHASE):** A single bit stream that carries both user data and associated timing.
- **Pulse Code Modulation (PCM):** Encoding in which a VFCT signal is encoded by using PCM.
- **Continuous Variable Slope Delta (CVSD):** Encoding in which a VF is encoded by using CVSD.

The various configurations are established to meet the specific user's communications requirements. Down-line loading capability of the equipment permits configuration of remote AN/FCC-100s from a centrally situated unit.

The AN/FCC-100 is capable of sending and receiving data and voice transmissions. Signaling information is in the form of signal Mission Bit Streams (MBS). MBS, or aggregate, is capable of processing up to 16 separate channels. Use of time-division principles places all channels into a single synchronous aggregate or composite signal.

The allowable rate for ports and aggregate depends upon port rate mix and port aggregate mix. The aggregate must not exceed the sum of the port rates. Additional bandwidth is required for overhead information and port inefficiencies. Isochronous ports use at least four times the rate that their normal rate indicates.

Testing Capabilities

Built-in testing capabilities within the AN/FCC-100 are available. These are:

- Diagnostics that continuously monitor and verify operation, and isolate faults to individual modules and software level.

Indicators with internal Light-Emitting Diodes (LEDs) to indicate faults, loss of frame, power status, loopback, and aggregate loopback.

- Loopback capabilities with local port and remote end, remote end port, aggregate local, and aggregate remote end.

Modes of Operation

The AN/FCC-100 has eight different modes of operation. They are as follows:

1. **Operate:** Set to send and receive data. Operations may be either normal or alarm.
2. **Alarm Status:** Although traffic continues to flow, the technical controller can request the AN/FCC-100 to show which alarm conditions are present.
3. **Loopbacks:** Several types of loopbacks are available—local aggregate, local port, and remote port. Caution must be maintained during loopbacks, because traffic will be interrupted.
4. **Configure:** Changes the parameters stored in the AN/FCC-100 memory.
5. **Examine Active:** Allows the existing parameters to be examined.
6. **Examine Off-Line:** Allows the parameters that are stored in the memory to be examined.
7. **Activate:** Places parameters that are stored in off-line memory into the active configuration.
8. **Test:** Causes a continuous self-test within the equipment. Again, caution must be used, because the test will stop all traffic flow to the user.

Front Panel Controls and Indicators

The front panel controls and indicators of the AN/FCC-100 are:

1. **LOC AGGR LOOP:** When lit, local aggregate is in loopback.
2. **REM AGGR LOOP:** When lit, remote end of AN/FCC-100 is in loopback.
3. **PORT LOOP:** When lit, at least one port is in loopback.
4. **LOSS OF FRAME:** When lit, local FCC-100 has lost frame synchronization.
5. **FAULT:** When lit, internal fault has been detected.
6. **POWER ON:** Indicates power status.
7. **DISPLAY WINDOW:** Presents FCC-100 operational data to the operator.

8. STORE: Places currently displayed parameters into off-line memory or directs the AN/FCC-100 to perform a command.
9. RECALL: Returns displayed configuration to previous state.
10. MODE SELECT: Causes the mode currently displayed to be entered.
11. RESTART: Returns the front panel to operation mode.
12. UP ARROW: Brings the cursor to the previous line or page.
13. DOWN ARROW: Brings the cursor to the next line or page.
14. PREV ENTRY: Moves the display to the previous choice within a field.
15. NEXT ENTRY: Advances the display to the next choice within a field.
16. POWER: Controls the input power.

MULTICHANNEL CRYPTOGRAPHIC CONTROLLER, MC3

The MC3 is a microprocessor-based device containing sophisticated system software that is easily field programmable. See figure 4-11. It permits interactive response between itself and the operator. Although designed for use in a multiple-terminal communications network, it can be used as follows:

A multiplexer input to a crypto device.

A cryptographic controller. Detects out-of-sync conditions and provides automatic

resynchronization when necessary. Permits unattended operation of crypto-equipment.

A multiplexer in a non-encryption communications network. It can be used as a multiplexer directly connected to a modem or to other data communications equipment.

- A monitor of a communications systems performance.

- A diagnostic tool for isolating network malfunctions.

The MC3 can accept inputs from up to 16 terminals and send a single data stream to an encryption device. Data accepted by the MC3 may be in the form of synchronous data, asynchronous data, or standard isochronous data. All data is transmitted from the MC3 as a synchronous stream at speeds up to 64K bps.

MISCELLANEOUS EQUIPMENT DESCRIPTIONS

The basic equipments found in NAVSECGRU and SPINTCOMM TCFs are briefly described in the following paragraphs. It should be noted that, due to variations in the size and mission of the various activities, the equipment described is representative of equipments in current use. Also, specific TCF installations are not limited to, nor

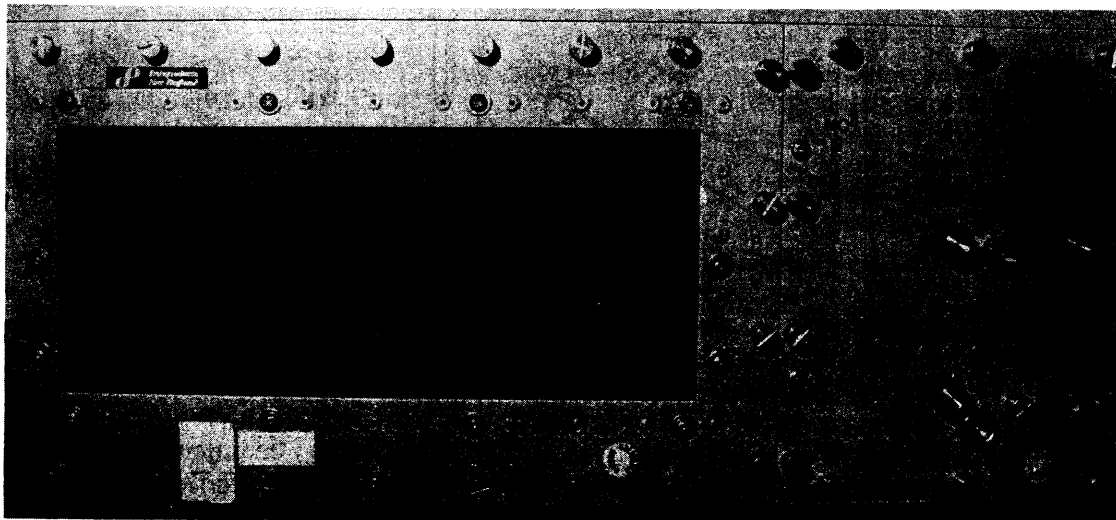

Figure 4-11.—Multichannel Cryptographic Controller, MC3.

317.16

do they necessarily contain all of, the equipment discussed in this topic.

TCF EQUIPMENT ARRANGEMENT

The size and physical arrangement of a TCF will differ from one installation to another. The determining factor is the number and type of circuits required to support the mission of a specific NAVSECGRU or SPINTCOMM activity.

Without a wiring frame and patch panel, the smallest technical control would be a complicated mass of wires and physical connections, incapable of operator intervention or flexibility. A faulted circuit would remain out of service until the required maintenance could be performed. Using frames and patch panels means that spare and normal equipment and lines can be interchanged and interconnected. Under normal circumstances, frames and patch panels are wired so that

each circuit and its associated equipment is "normalled-through." Therefore, for normal operations, the use of patch cords or physical wiring is not necessary.

POWER SUPPLY ASSEMBLY, PP-6521/FG

The power supply contains two separate $+/-$ 6-volt power supply modules and an alarm control panel. Each power module provides $+/-$ 6 volts for low-level signal and control circuits. Both modules are within a single enclosure assembly and are mounted in a standard 19-inch-wide equipment cabinet. One power module is the primary power supply, and the other is an alternate, to be used in case of power failure. The controls and indicators for the power supply module illustrated in figure 4-12 are identified by index numbers. Table 4-1 describes the functions of each.

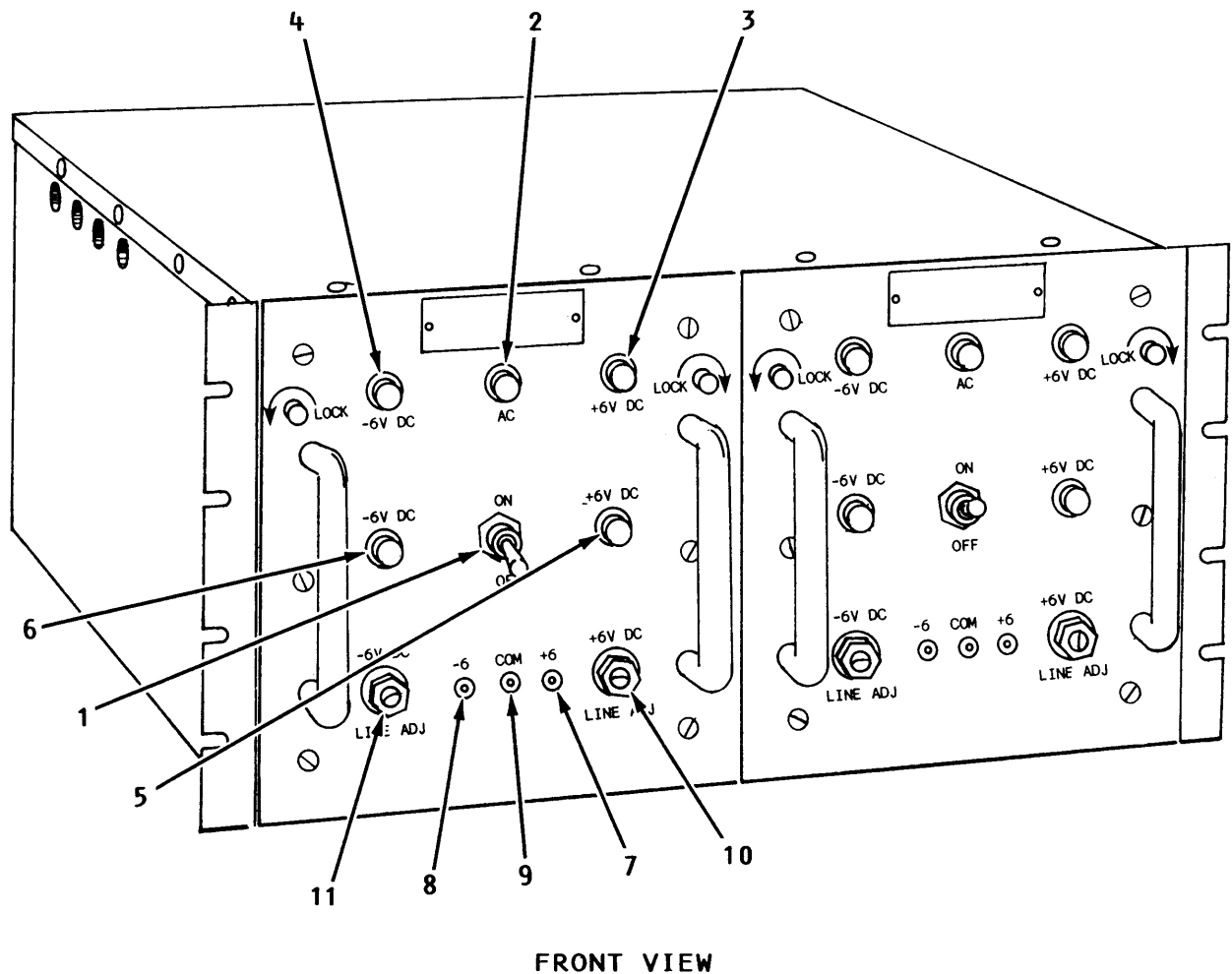

Figure 4-12.—Unit A1, Power Supply Assembly, PP-6521/FG.

Table 4-1.—Unit A1, Power Supply Assembly, PP-6521/FG, Controls and Indicators

CONTROL INDICATOR INDEX NO. FIG 4-12	NAME (Nomenclature)	POSITION/ CONDITION	FUNCTION/PURPOSE/ INSTRUCTIONS
1	Power Switch	Up Down	Applies 115V ac power to power module. Removes 115V ac power from power module.
2	Line Fuse (ac)		Provides overload protection for 115V ac circuits in the power supply. If the indicator cap is lit, the fuse has blown.
3	+6V dc Circuit Breaker (+6V dc)	In Out	+6V dc is present at A1TB1 at the rear of the power module enclosure. +6V dc has been removed from A1TB1-4 due to a circuit overload condition. To reset, depress the control.
4	-6V dc Circuit Breaker (-6V dc)	In Out	-6V dc is present at A1TB1 at the rear of the power module enclosure. -6V dc has been removed from A1TB1 due to a circuit overload condition. To reset, depress the control.
5	+6V dc Indicator (+6V dc)	On	Indicates that the power module +6V dc supply is functioning and that +6V dc is available.
6	-6V dc Indicator (-6V dc)	On	Indicates that the power module -6V dc supply is functioning and that -6V dc is available.
7	+6V dc Test Point (+6)	-	Provided for measurement of the +6V dc output voltage.
8	-6V dc Test Point (-6)	-	Provided for measurement of the -6V dc output voltage.
9	Common Test Point (COM)	-	Provides a common reference point for the measurement of +6V dc and -6V dc using the respective test points.
10	+6V dc Line Adjustment (+6V dc LINE ADJ)	-	Provides a means for adjusting the +6V dc output from approximately +5.5V dc to +6.3V dc.
11	-6V dc Line Adjustment (-6V dc LINE ADJ)	-	Provides a means for adjusting the -6V dc output from approximately -5.5V dc to -6.5V dc.

The alarm and control panel is rack-mounted near the power supply modules. The alarm system has a visual alarm lamp and an audible bell. These are common to the voltage sensors of both the primary and standby power supply

modules. The alarm and control panel provides meters for monitoring each module. See figure 4-13. The controls and indicators are indexed and referenced to functional descriptions listed in table 4-2.

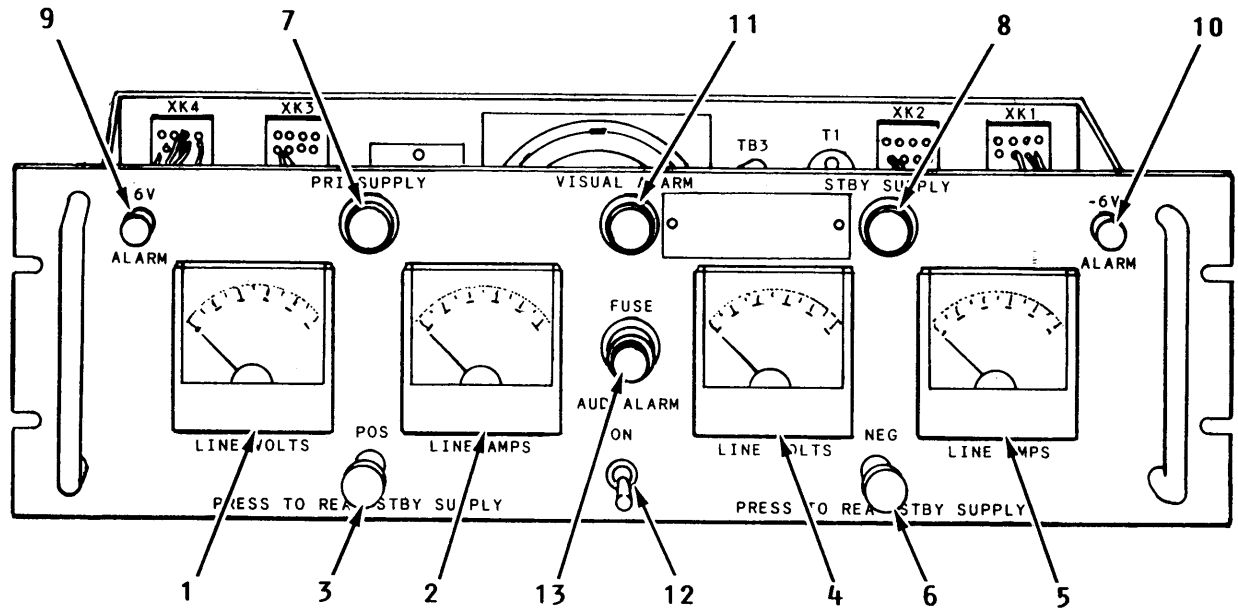

FRONT VIEW

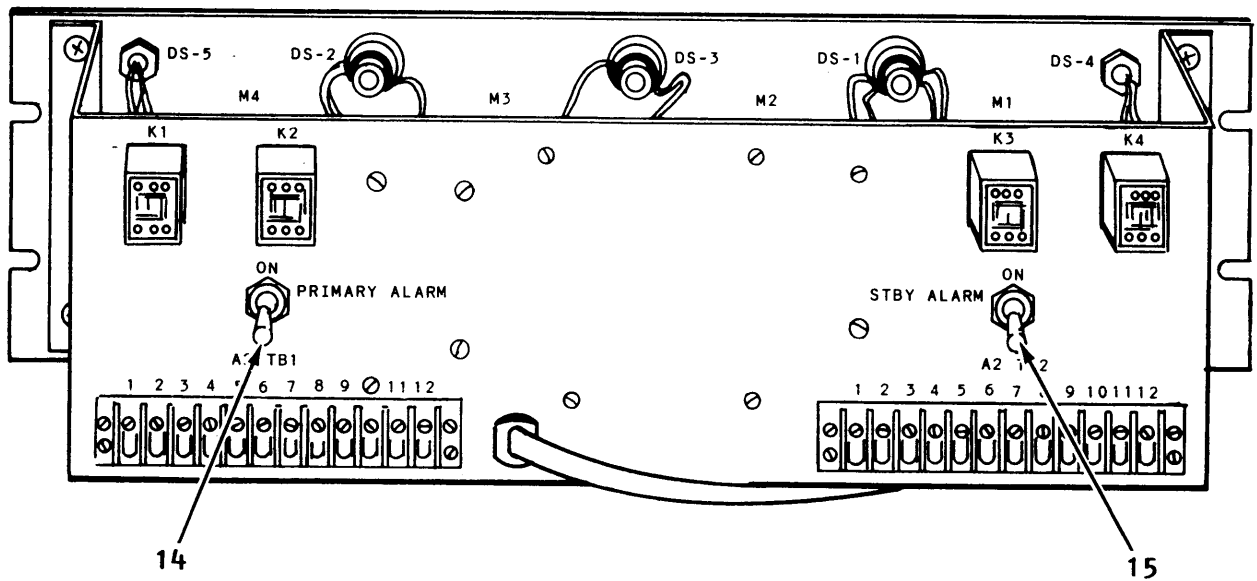

REAR VIEW

Figure 4-13.—Unit 2A, Power Supply Assembly, PP-6521/FG.

317.18

Table 4-2.—Unit A2, Power Supply Assembly, PP-6521/FG, Controls and Indicators

CONTROL INDICATOR INDEX NO. FIG 4-13	NAME (Nomenclature)	POSITION/ CONDITION	FUNCTION/ PURPOSE/ INSTRUCTIONS
1	Positive Line Volt Meter (POS LINE VOLTS)	—	Indicates the output voltage of the primary supply providing +6V to the load.
2	Positive Line Amp Meter (POS LINE AMPS)	—	Indicates the amount of current, in amperes, being drawn from the +6V supply.
3	Standby Supply Read Button (PRESS TO READ STBY SUPPLY)	Depressed	When pressed, the POS LINE VOLTS and POS LINE AMPS meters indicate voltage and current being drawn from the standby power module.
4	Negative Line Volt Meter (NEG LINE VOLTS)	—	Indicates the output voltage of the primary supply providing -6V to the load.
5	Negative Line Amp Meter (NEG LINE AMPS)	—	Indicates the amount of current, in amperes, being drawn from the -6V supply.
6	Standby Supply Read Button (PRESS TO READ STBY SUPPLY)	Depressed	When pressed, the NEG LINE VOLTS and NEG LINE AMPS meters indicate voltage and current being drawn from the standby power module.
7	Primary Supply Indicator (PRI SUPPLY)	On	Indicates that the primary power module is on line.
8	Standby Supply Indicator (STBY SUPPLY)	On	Indicates that the standby power module is on line.

Table 4-2.—Unit A2, Power Supply Assembly, PP-6521/FG, Controls and Indicators (continued)

CONTROL INDICATOR INDEX NO. FIG 4-13	NAME (Nomenclature)	POSITION/ CONDITION	FUNCTION/ PURPOSE/ INSTRUCTIONS
9	+6V Fuse Alarm (+6V FUSE ALARM)	On	Indicates that a +6V line fuse has opened.
10	-6V Fuse Alarm (-6V FUSE ALARM)	On	Indicates that a -6V line fuse has opened.
11	Visual Alarm Lamp (VISUAL ALARM)	On	Indicates that a blown fuse condition exists.
12	Audible Alarm Switch (AUD ALARM)	On	Allows the audible blown fuse alarm to sound when a blown fuse exists.
		Off	Silences the audible alarm.
13	Line Fuse (FUSE)	-	Provides overload protection for 115V ac circuits in the Alarm and Control Panel. If the indicator cap is lit, the fuse has blown.
14	Primary Alarm (PRIMARY ALARM)	On	Allows the alarm circuitry to sense a failure in the primary power module.
15	Standby Alarm (STBY ALARM)	On	Allows the alarm circuitry to sense a failure in the standby power module.

Table 4-3 lists the most common troubles likely to occur in the power supply assembly and remedies to correct those troubles. **DANGEROUS VOLTAGES EXIST IN THE POWER SUPPLY ASSEMBLY.** If troubleshooting techniques isolate any unit as faulty, notify qualified maintenance personnel.

FUSE PANEL, SB-3503/FG

The fuse panel has two rows of 26 fuses each. The top row of fuses, labeled 1A through 26A, is normally reserved for the positive 6-volt dc side of a circuit. The bottom row, labeled 1B through 26B, is reserved for the negative 6-volt dc side of a

Table 4-3.—Power Supply Assembly, PP-6521/FG, Troubleshooting Procedures

TROUBLE	PROBABLE CAUSE	REMEDY
5-AMP POWER SUPPLY, PP-6521/FG, UNIT A1		
No +6V and no -6V output	a. No ac power b. Fuse F1 blown	a. Restore ac power b. Replace fuse F1
Low +6V or -6V output	a. Series regulator control card defective b. Series regulator control transistor Q5 or Q8 defective	a. Replace card b. Replace transistor
High +6V or -6V output	a. Series regulator control card defective b. Series regulator control transistors (Q3, Q4, Q5 for -6V; Q6, Q7, Q8 for +6V) defective	b. Replace card b. Replace transistors
ALARM AND CONTROL PANEL, PP-6521/FG, UNIT A2		
No system alarm, visual or audible	a. No ac power b. Fuse F1 blown	a. Restore ac power b. Replace fuse F1
No audible alarm, visual alarm normal	a. AUD ALARM switch OFF b. Bell defective	a. Reset switch to ON b. Replace bell
No visual alarm, audible alarm normal	Lamp DS3 burned out	Replace lamp
+6V FUSE ALARM or -6V FUSE ALARM lamps not illuminated	Lamps DS4 or DS5 burned out	Replace lamp(s)
Standby power will not transfer to line when primary power fails	a. Standby power module not on b. Transfer relay K4 defective c. Standby transfer relay control board defective	a. Activate standby module b. Replace relay c. Replace CR2 and/or Q2
Primary power will not transfer to line when standby power fails	a. Primary power module not on b. Transfer relay K1 defective c. Primary transfer relay control board defective	a. Activate primary module b. Replace relay c. Replace CR1 and/or Q1

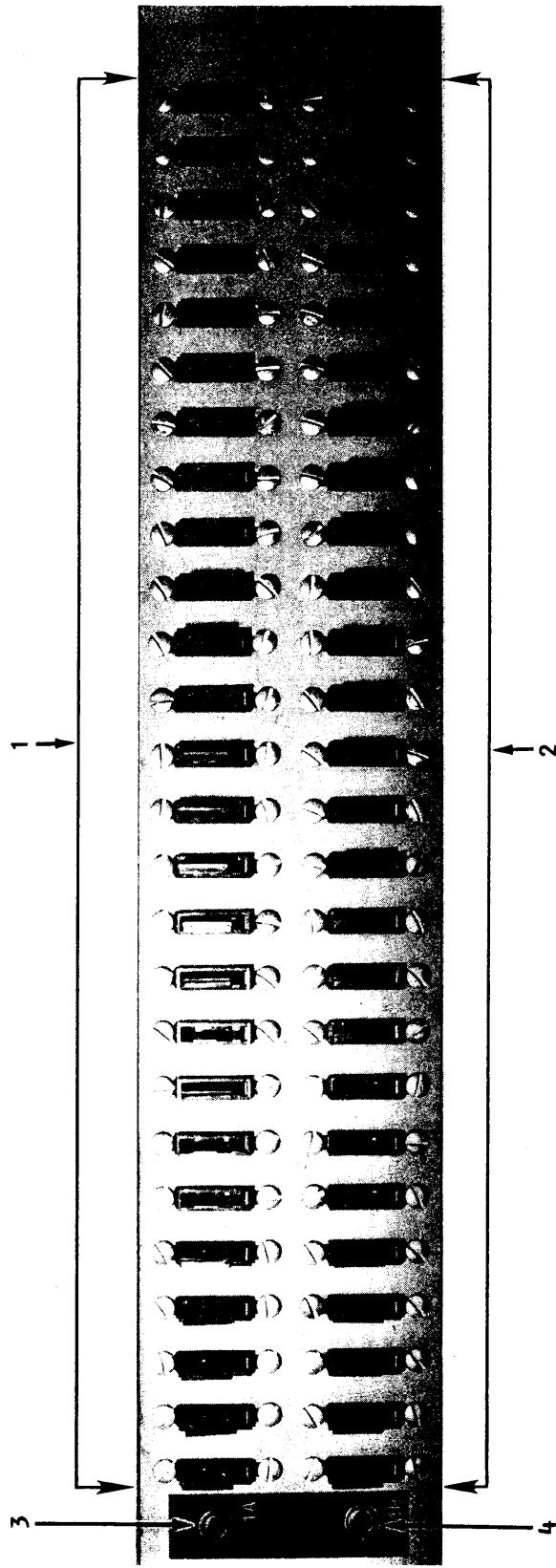

FRONT VIEW

317.19

Figure 4-14.—Fuse Panel, SB-3503/FG.

Table 4-4.—Fuse Panel, SB-3503/FG, Controls and Indicators

CONTROL INDICATOR INDEX NO. FIG 4-14	NAME (Nomenclature)	POSITION/CONDITION	FUNCTION/PURPOSE/INSTRUCTIONS
1	Fuse; Bus A	—	Provides overload protection for loads 1A through 26A.
2	Fuse; Bus B	—	Provides overload protection for loads 1B through 26B.
3	Indicator, lamp 1A	On	Provides visual indication of a blown fuse for loads 1A through 26A.
4	Indicator, lamp 2A	On	Provides visual indication of a blown fuse for loads 1B through 26B.

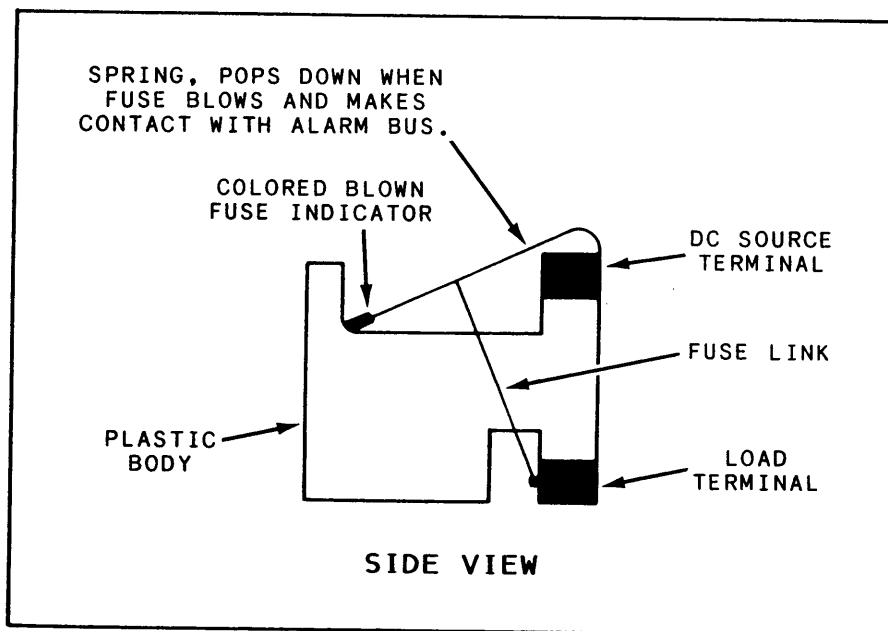

Figure 4-15.—Fuse Panel, SB-3503/FG, Indicating Fuse, GMT 18/100.

circuit. The fuses and indicators shown in figure 4-14 are indexed to the functional descriptions listed in table 4-4. If a fuse on the SB-3503/FG opens, one of the two indicator lamps will light, providing a visual indication to the operator that the blown fuse is either in row A or in row B. Since the fuses are of the indicating type, the operator need only scan the indicated row to

locate and replace the appropriate fuse. Figure 4-15 illustrates the fuse construction.

ALARM PANEL, SB-3268/UG

The alarm panel provides a visual and audible indication of a blown fuse. It is of open-frame construction, measuring 19-inches

Table 4-5.—Alarm Panel, SB-3268/UG, Controls and Indicators

CONTROL INDICATOR INDEX NO. FIG 4-16	NAME (Nomenclature)	POSITION/CONDITION	FUNCTION/PURPOSE/INSTRUCTIONS
1	115V ac Fuse (115V ac)	On	Indicates 115V ac power fuse for the alarm panel has blown.
2	6V POS BATT ALM	On	Indicates a +6V fuse has blown in a teletype circuit serviced by the alarm panel.
3	BELL CUTOFF Switch, Positive	Down	Enables the audible alarm to sound when a +6V fuse opens.
		Up	Silences the audible alarm during a +6V blown fuse condition.
		NOTE	
		The 6V POS BATT ALM indicator lamp will remain lit until the blown fuse is located and replaced.	
4	6V NEG BATT ALM	On	Indicates a –6V fuse has blown in a teletype circuit serviced by the alarm panel.
5	BELL CUTOFF Switch, Negative	Down	Enables the audible alarm to sound when a –6V fuse opens.
		Up	Silences the audible alarm during a –6V blown fuse condition.
		NOTE	
		The 6V NEG BATT ALM indicator lamp will remain lit until the blown fuse is located and replaced.	
6	Bell	–	Provides an audible indication when a blown fuse occurs in a teletype circuit serviced by the alarm panel. The bell may be silenced by either BELL CUTOFF switch, as appropriate.

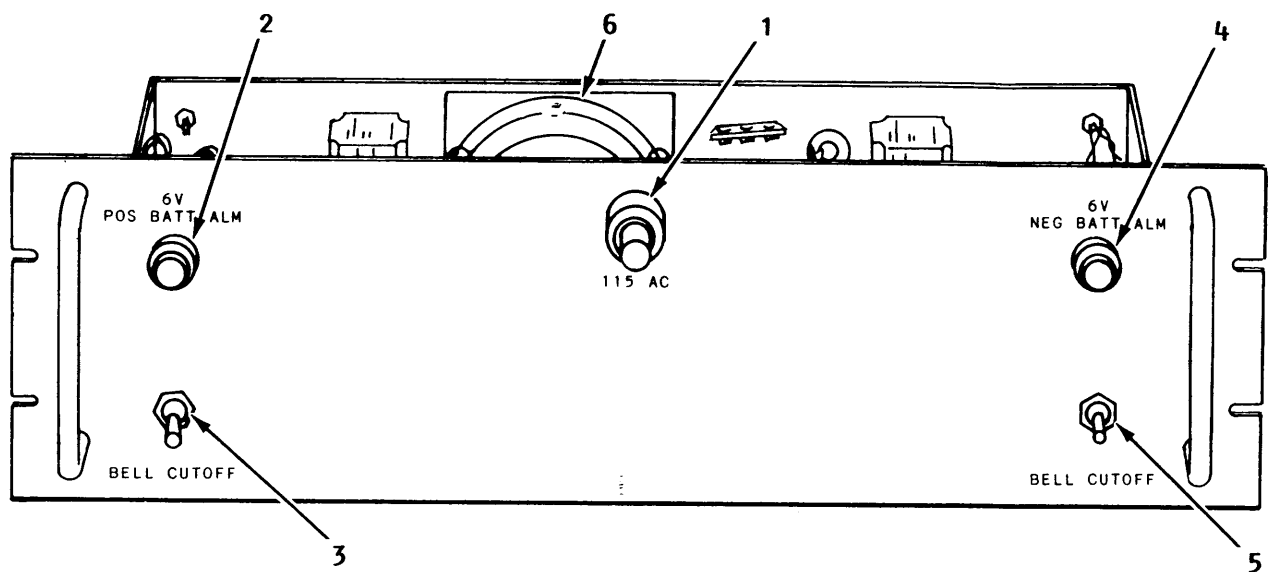

FRONT VIEW

Figure 4-16.—Alarm Panel, SB-3268/UG.

317.20

wide. The front panel contains an ac power lamp, positive and negative 6-volt dc alarm indicator lamps, and two bell cut-off switches. Figure 4-16 is indexed to function descriptions listed in table 4-5. When a blown fuse condition occurs, an extremely loud bell will sound. With the bell, either the positive or the negative battery alarm lamp will light. The bell may be silenced with the appropriate BELL CUT-OFF switch. However, the indicator lamp will remain on until the blown fuse is replaced.

BALLAST LAMP AND FUSE PANEL, SB-3149/UG

The ballast lamp and fuse panel provide overload protection for low-level, teletype-signaling circuits. The panel contains 80 lamps and 20 fuses, housed in a ferrous (iron) enclosure with a screened front. There are no specific operating procedures for the ballast lamp and fuse panel. However, TCF operators should be familiar with lamp and fuse assignments for their particular facility. Figure 4-17 illustrates the front and rear views of the SB-3149/UG. Table 4-6 indexes the lamps and fuses to functional descriptions. As a general rule, ballast lamps are wired in series with the positive

and negative 6-volt power supplies for the protection of individual teletypes in the event of a circuit overload or a mismatch.

TELEGRAPH HUBBING REPEATER, TH-83A/FGC

The telegraph hubbing repeater performs two primary functions:

1. It combines, on a time-sharing basis, from 2 to 20 low-level teletype inputs on as many as 20 channels.
2. It distributes one or more low-level teletype inputs to as many as 20 simultaneous outputs.

The unit is completely self-contained. Signal inputs, outputs, and hubbing points are brought out to a terminal block mounted within the unit. The internal positive and negative 6-volt power supply provides all the dc power required for the internal circuits and their respective loads. Figure 4-18 illustrates the front panel of the TH-83A/FGC. Controls and indicators are indexed to descriptions listed in table 4-7.

The hubbing repeater allows the interfacing of a single digital polar mark, plus signal source,

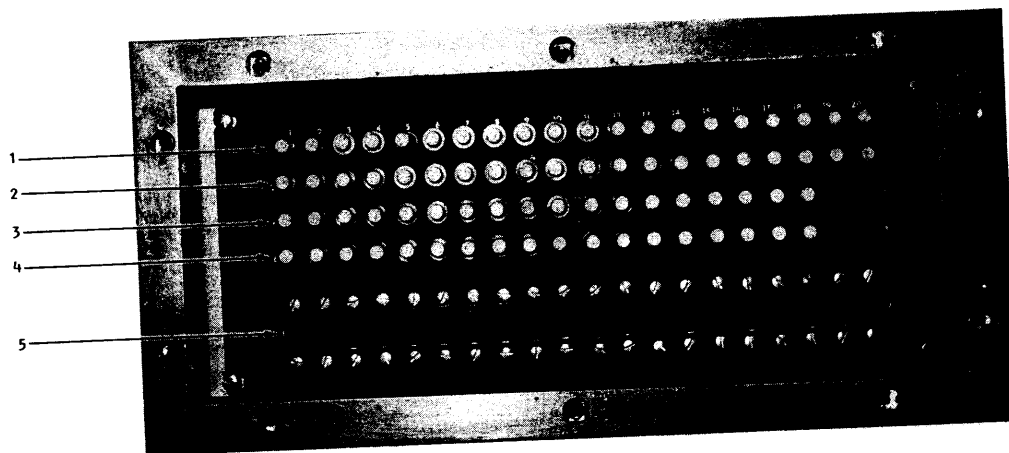

FRONT VIEW

317.21

Figure 4-17.—Ballast Lamp and Fuse Panel, SB-3149/UG.

Table 4-6.—Ballast Lamp and Fuse Panel, SB-3149/UG, Controls and Indicators

CONTROL INDICATOR INDEX NO. FIG 4-17	NAME (Nomenclature)	POSITION/CONDITION	FUNCTION/PURPOSE/INSTRUCTIONS
1	Ballast Lamps 1 through 20	On	Indicates an overload, short, or mismatch on the associated circuit.
2	Ballast Lamps 21 through 40	On	Indicates an overload, short, or mismatch on the associated circuit.
3	Ballast Lamps 41 through 60	On	Indicates an overload, short, or mismatch on the associated circuit.
4	Ballast Lamps 61 through 80	On	Indicates an overload, short, or mismatch on the associated circuit.
5	Fuses 1 through 20	—	Provides overload protection for the associated circuits. The fuses are equipped with alarm contacts and indicator beads. When a fuse opens, an external alarm is activated and the operator may locate the blown fuse by observing the indicator bead.

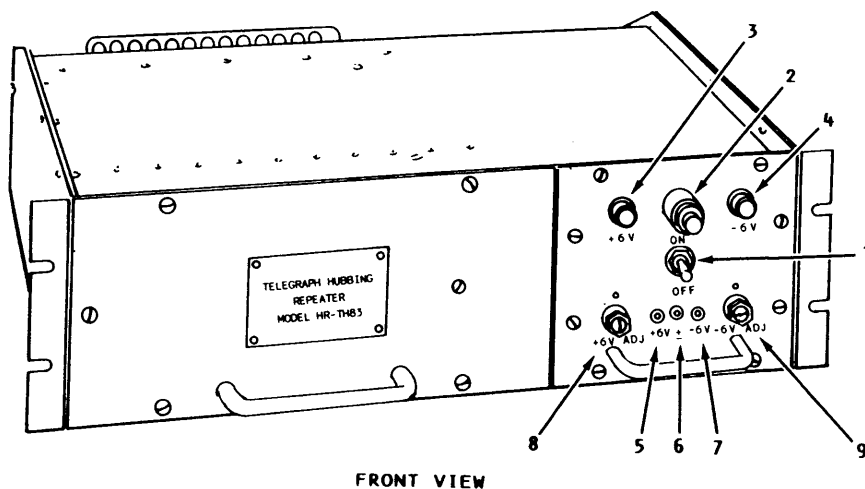

Figure 4-18.—Telegraph Hubbing Repeater, TH-83A/FGC.

317.22

Table 4-7.—Telegraph Hubbing Repeater, TH-83A/FGC, Controls and Indicators

CONTROL INDICATOR INDEX NO. FIG 4-18	NAME (Nomenclature)	POSITION/CONDITION	FUNCTION/PURPOSE/INSTRUCTIONS
1	AC On-Off Switch (ON-OFF)	Off On	Removes 115V ac power from unit. Applies 115V ac power to unit.
2	Fuse Indicator, 1A 3AG Cartridge (F1)	On	Indicates F1 has opened.
3	+6V Lamp (+6V)	On	Indicates +6V power available.
4	-6V Lamp (-6V)	On	Indicates -6V power available.
5	+6V Test Point (+6V)	-	Provides external meter connection to measure +6V supply voltage.
6	-6V Test Point (-6V)	-	Provides external meter connection to measure -6V supply voltage.
7	± Test Point (±)	-	Provides common external meter connection to measure polar line voltages. (Used in conjunction with +6V and -6V test points.)
8	+6V Adjustment Switch (+6V ADJ)	-	Adjusts +6V dc supply voltage between +5V and +7V.
9	-6V Adjustment Switch (-6V ADJ)	-	Adjusts -6V dc supply voltage between -5V and -7V.

to various separate outputs. The enclosure assembly contains 10 printed circuit plug-in boards mounted behind a removable front panel. The plug-in printed circuit boards are not pre-wired for any set input or output hubbing configuration, but are brought out to the rear terminal block. Specific configuration is left to the option of the installing activity.

The TH-83A/FGC is a solid-state design and, under normal conditions, it should provide satisfactory operation with a minimum of trouble. If a problem develops, only a technician thoroughly familiar with the theory of operation should be allowed to try to isolate the problem. Table 4-8 lists several troubles likely to occur and provides probable causes and remedies.

RELAY ASSEMBLY, RE-1107/UG

This relay assembly provides line isolation and equipment isolation for six teletype

circuits. The relay assembly consists of six relays and six printed circuit-board assemblies, mounted on a metal frame suitable for installation in a 19-inch rack. A normal polar-send-to-polar-receive operation may be changed to a polar-send or a neutral-receive operation by wire straps on the printed circuit boards. Two terminal blocks, marked *coil* and *contact*, are part of the panel.

Figure 4-19 shows the front and rear views of the relay assembly. There are no controls or indicators on the relay assembly. The operator has access to the six isolation relays via a miscellaneous patch panel located in the TCF. Each relay circuit will have both an input jack and an output jack associated with it.

If high signal distortion has been observed and is traceable to the relay assembly, the relay for that circuit should be replaced by qualified maintenance personnel. Corrective maintenance consists of replacing or repairing defective relays. When replacing relays, it must be emphasized

Table 4-8.—Telegraph Hubbing Repeater, TH-83A/FCG, Troubleshooting Procedures

TROUBLE	PROBABLE CAUSE	REMEDY
+6V dc and -6V dc lamps not illuminated	a. Power cord not plugged in	a. Plug in cord
	b. Fuse F1 blown	b. Replace fuse
+6V dc lamp not illuminated	Lamp DS1 burned out	Replace lamp
-6V dc lamp not illuminated	Lamp DS2 burned out	Replace lamp
No $\pm 6V$ signal output at TP4 or TP8 of a hubbing repeater card	No $\pm 6V$ signal input	Check for signal input at TP1 or TP5 on appropriate card
Ballast lamps RT1 through RT4 illuminated	a. Short in PC board	a. Substitute another board
	b. Short in $\pm 6V$ output wiring	b. Correct short on output signal line

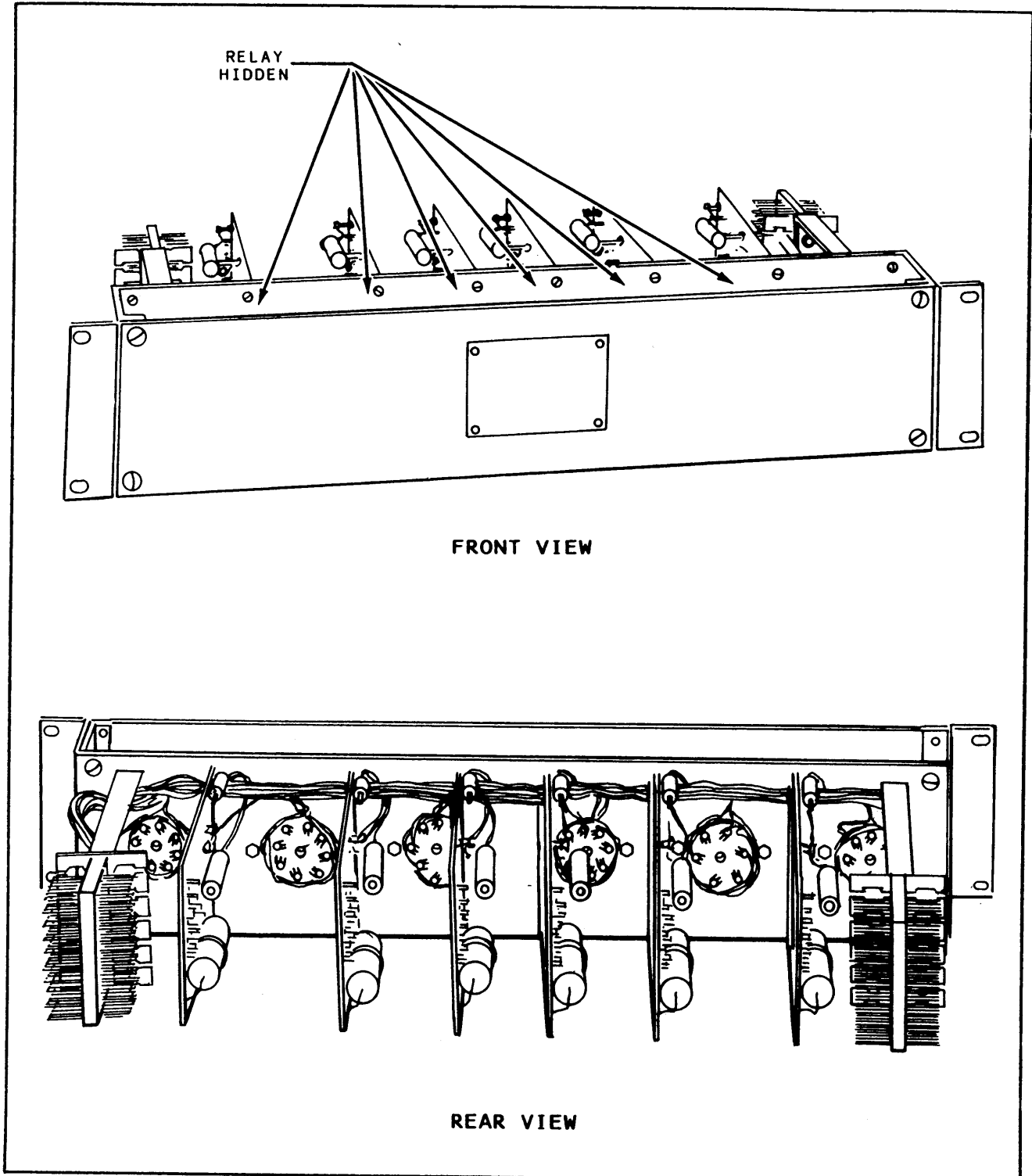

Figure 4-19.—Relay Assembly, RE-1107/UG.

317.23

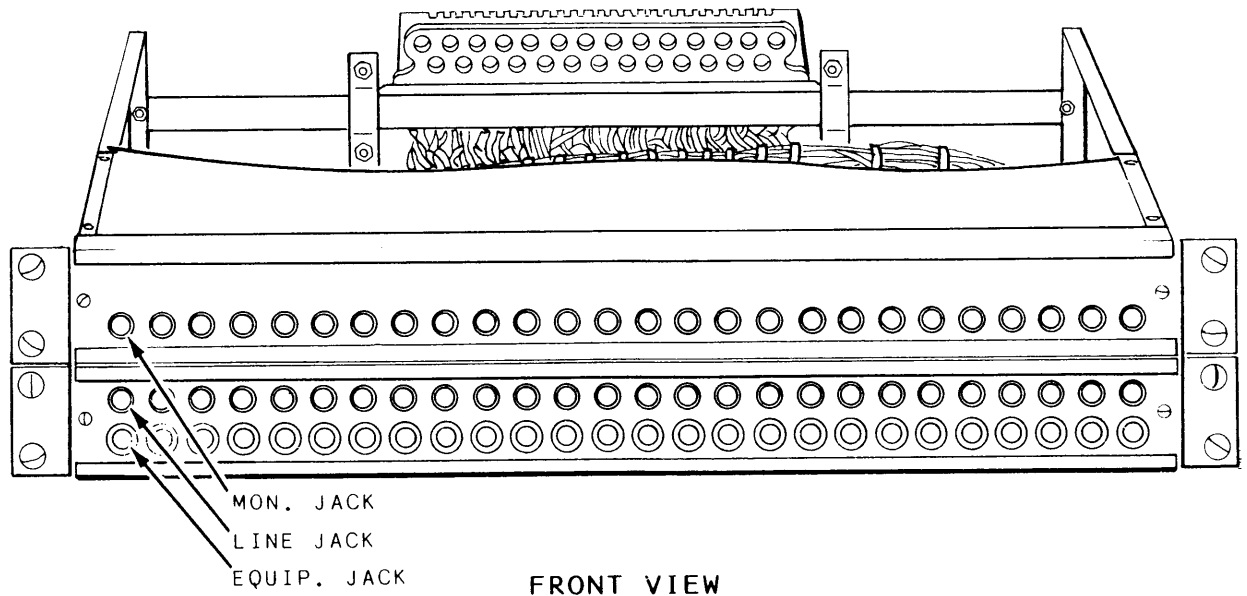

Figure 4-20.—Communications Patch Panel, SB-3092A/U.

317.24

that mercury-wetted relays are position-sensitive and may be damaged if they are hastily plugged into an energized circuit.

COMMUNICATIONS PATCH PANEL, SB-3092A/U

This is an audio circuit communications patch panel. It has three rows of 26 jacks, each mounted on an open frame suitable for installation on a 19-inch rack. Connections to the panel are facilitated by a terminal block mounted at the rear of the frame.

The three rows of jacks are labeled monitor (MON), LINE, and equipment (EQUIP). See figure 4-20. The MON jacks are wired parallel to the LINE jacks. The LINE jacks are wired directly to the audio source, and the EQUIP jacks are wired to the load or equipment using the audio signal. Under normal conditions, with no patch cords inserted into a jack field, the audio source is wired directly through the audio load. When a patch cord is inserted into a LINE jack, the audio source is removed from the load connected to the EQUIP jack located directly below the LINE jack, and the source now appears at the other end of the patch cord. When this end of the cord is inserted into an EQUIP jack, the audio source appearing on the LINE jack directly above the EQUIP jack is removed from the load,

and an alternate circuit has been completed between the two ends of the patch cord. The MON jacks allow the operator to test an audio circuit without disturbing signal flow by inserting a patch cord between the appropriate MON jack and another jack connected to the input of the desired piece of test equipment. The patch panel can accommodate up to 26 audio circuits. If the transmit-and-receive side of a communications circuit is wired to adjacent jack fields, a dual patch-cord assembly may be used to patch both sides of the circuit simultaneously.

COMMUNICATIONS PATCH PANEL, SB-3145/UG

This communications patch panel is a low-level, send-and-receive teletype, special-purpose patch panel. It is capable of handling 20 half-duplex or 10 full-duplex circuits. Figure 4-21 illustrates the front panel. Jacks and controls are indexed and referenced to descriptions listed in table 4-9. The panel is normally configured for full-duplex, send-and-receive operation. The circuits are numbered 1 through 10, with circuit 1 located on the left side of the panel and circuit 10 on the right side of the panel. Each circuit requires two columns of jacks—one column for send and the other for receive.

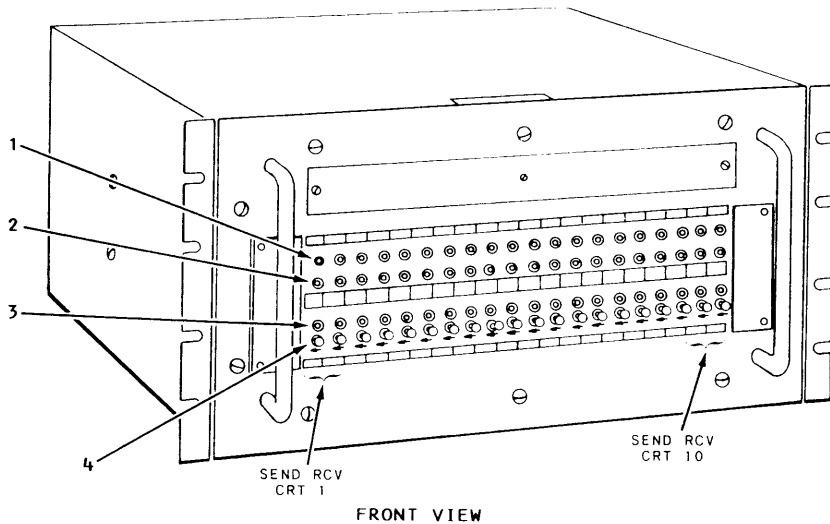

Figure 4-21.—Communications Patch Panel, SB-3145/UG.

317.25

Table 4-9.—Communications Patch Panel, SB-3145/UG, Controls and Indicators

CONTROL INDICATOR INDEX NO. FIG 4-21	NAME (Nomenclature)	POSITION/CONDITION	FUNCTION/PURPOSE/INSTRUCTIONS
1	Monitor Jack (MON)	—	Allows the operator to monitor circuit operation without disturbing signal flow. Monitoring is accomplished by the insertion of one end of a patch cord into the selected MON jack and inserting the other end into a jack connected to the input of the desired test equipment.
2	Line Jack (LINE)	—	Allows the operator to patch a communications signal line into an alternate piece of equipment.
3	Equipment Jack (EQUIP)	—	Allows the operator to patch the equipment appearing on the jack to an alternate signal line.
4	Lockout Switch (LOSW)	Horizontal	Permits normal operation of the communications circuit handled by the LINE and EQUIP jacks located directly above the switch.
		Vertical	Inhibits communications over the associated circuit by the application of a MARK HOLD voltage to the signal line and a STEP INHIBIT voltage to the step line.

Table 4-10.—Miscellaneous Patch Panel, SB-3146/UG, Controls and Indicators

CONTROL INDICATOR INDEX NO. FIG 4-22	NAME (Nomenclature)	POSITION/CONDITION	FUNCTION/PURPOSE/INSTRUCTIONS
1	Miscellaneous Jack (MISC)	—	Allows access to interbay trunks, test and monitoring equipment, test signals and specialized equipment by insertion of patch cords in the appropriate jacks.
2	Lockout Switch	Horizontal	Allows normal operation of the associated MISC jack located directly below the lockout switch.
3	Indicator Lamp	Vertical	Disables the associated MISC jack by interrupting the signal lines to and from the jack.
		—	Indicator lamps are strapped into the patch field for interbay trunking circuits and for steady MARK and SPACE outputs.
		On	For patch fields providing a steady MARK or SPACE output voltage, an illuminated lamp indicates a patch cord has been inserted into the associated jack. For patch fields used for interbay trunking, the illuminated lamp indicates a patch cord has been inserted into a jack on one end of the trunk. The lamps go out when the remote plug is inserted.

MISCELLANEOUS PATCH PANEL, SB-3146/UG

The miscellaneous patch panel consists of 20 miscellaneous jacks, 20 lockout switches, and 20 indicator lamps. Typically, miscellaneous patch panels are used for interbay trunking, to provide test signal outputs, as input points for monitoring equipment, and as input and output points for isolation relays and specialized

equipment. Figure 4-22 illustrates the front of this panel. Controls and indicators are indexed to descriptions in table 4-10.

DISTRIBUTION PATCH PANEL, SB-3166/UG

The distribution patch panel is designed to accept specific combinations of communications

patch panels, such as the SB-3145/3146. Sometimes called the *table top panel*, the distribution patch panel contains 32 cords and provides 10 through-circuit patches. The 32 patch cords are used as follows:

- 20 cords for through-circuit patches,
- 5 cords for patching local send equipment,
- 5 cords for patching local receive equipment,
- 1 meter cord for testing purposes, and
- 1 scope cord for testing purposes.

The components are housed in a standard cabinet. Approximately 40 inches of panel-mounting space is available for 19-inch-wide patch panels. A voltmeter and a meter cord monitor the signal level.

COMMUNICATIONS PATCH PANEL, SB-3732/UG

This communications patch panel is equipped for a 10-circuit send-and-receive operation. Each circuit consists of a monitor, line, and equipment jack for send; a monitor, line, and equipment jack for receive; send-and-receive circuit activity lamps; send-and-receive lockout switches; and send-and-receive lockout indicators. The circuit activity lamps are driven from lamp driver cards mounted in the left rear of the

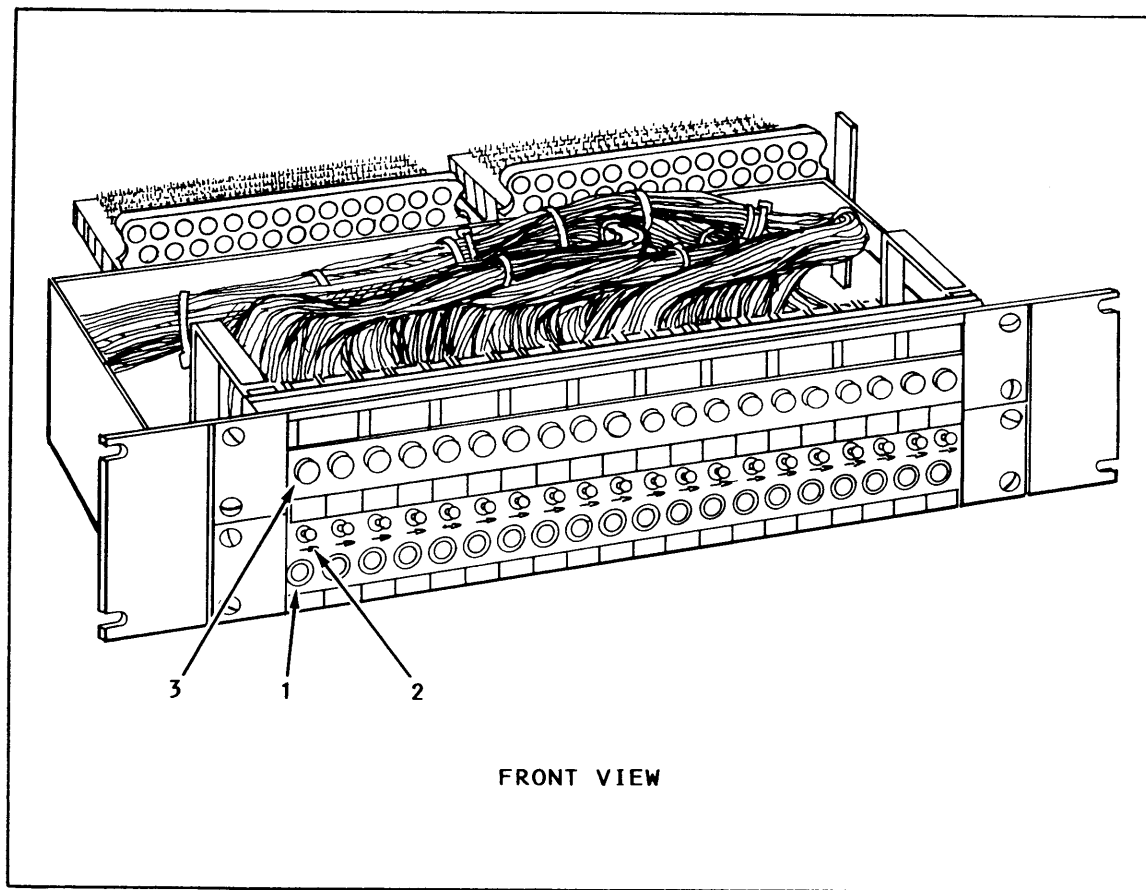

Figure 4-22.—Miscellaneous Patch Panel, SB-3146/UG.

Table 4-11.—Communications Patch Panel, SB-3732/UG, Controls and Indicators

CONTROL INDICATOR INDEX NO. FIG 4-23	NAME (Nomenclature)	POSITION/ CONDITION	FUNCTION/PURPOSE/ INSTRUCTIONS
1	Send Activity Lamp (ACT)	On	Send traffic is being passed over the circuit.
2	Receive Activity Lamp (ACT)	On	Receive traffic is being passed over the circuit.
3	Send Lockout Switch	Horizontal	Allows normal send traffic to be passed over the circuit.
		Vertical	Inhibits send traffic from passing over the circuit. Applies MARK HOLD voltage to signal line and STEP INHIBIT voltage to SEND CLUTCH.
4	Receive Lockout Switch	Horizontal	Allows normal receive traffic to be passed over the circuit.
		Vertical	Inhibits receive traffic from passing over the circuit. Applies MARK HOLD voltage to signal line and STEP INHIBIT voltage to REC CLUTCH.
5	Send Lockout Lamp (L/O)	On	Indicates send circuit is in lockout condition.
6	Receive Lockout Lamp (L/O)	On	Indicates receive circuit is in lockout condition.
7	Send Line Jack (LINE)	—	Allows operator to patch alternate SEND EQUIP into the normal SEND LINE.
8	Receive Line Jack (LINE)	—	Allows operator to patch the RECEIVE LINE into alternate REC EQUIP. Applies MARK HOLD to normal REC EQUIP.
9	Send Equipment Jack (EQUIP)	—	Allows operator to patch the SEND EQUIP into an alternate SEND LINE. A MARK HOLD voltage is applied to the normal SEND LINE.

Table 4-11.—Communications Patch Panel, SB-3732/UG, Controls and Indicators (continued)

CONTROL INDICATOR INDEX NO. FIG 4-23	NAME (Nomenclature)	POSITION/CONDITION	FUNCTION/PURPOSE/INSTRUCTIONS
10	Receive Equipment Jack (EQUIP)	—	Allows the operator to patch an alternate RECEIVE LINE into the normal REC EQUIP.
11	Send Monitor Jack (MON)	—	Allows the operator to monitor send traffic without disturbing signal flow.
12	Receive Monitor Jack (MON)	—	Allows the operator to monitor receive traffic without disturbing signal flow.

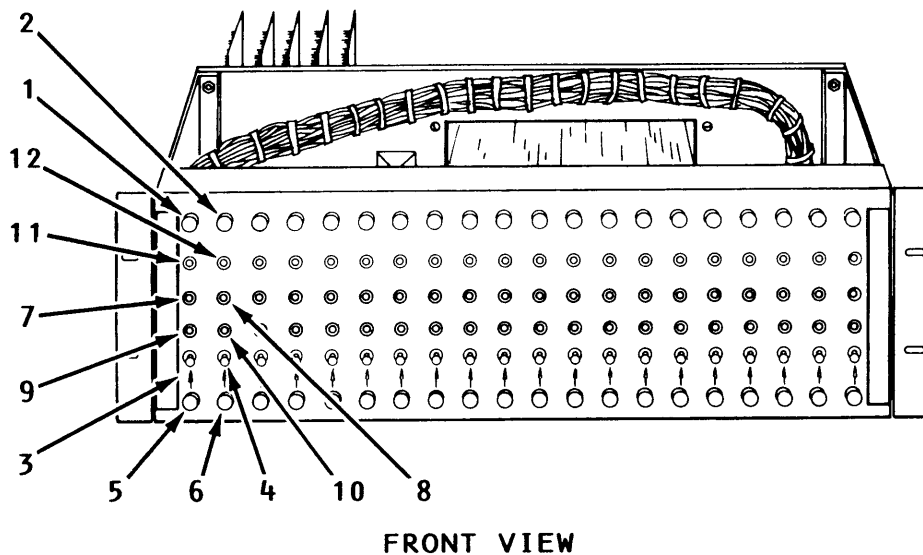

Figure 4-23.—Communications Patch Panel, SB-3732/UG.

317.27

panel. Figure 4-23 shows the front and rear views of the panel. The jack controls and indicators are indexed to functional descriptions listed in table 4-11.

COMMUNICATIONS PATCH PANEL, SB-4012/US

This patch panel provides the capability for patching and testing 12-wire, digital data

circuits. These patch panels provide the ability to quickly or easily remove or replace a faulty modem, terminal, or computer part via front panel patching. The management of information flow is accomplished using the same technique. Each digital circuit has a MON, SOURCE, and SINK jack associated with it. Multicircuit patch panels have labels with various commercial uses in mind. As such, the term *source* is synonymous with *line* and *modem*, and the term

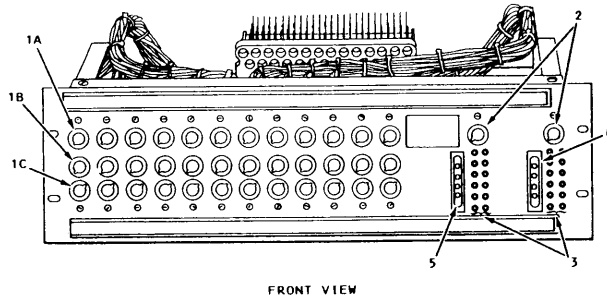

FRONT VIEW

317.28

Figure 4-24.—Communications Patch Panel, SB-4012/US.

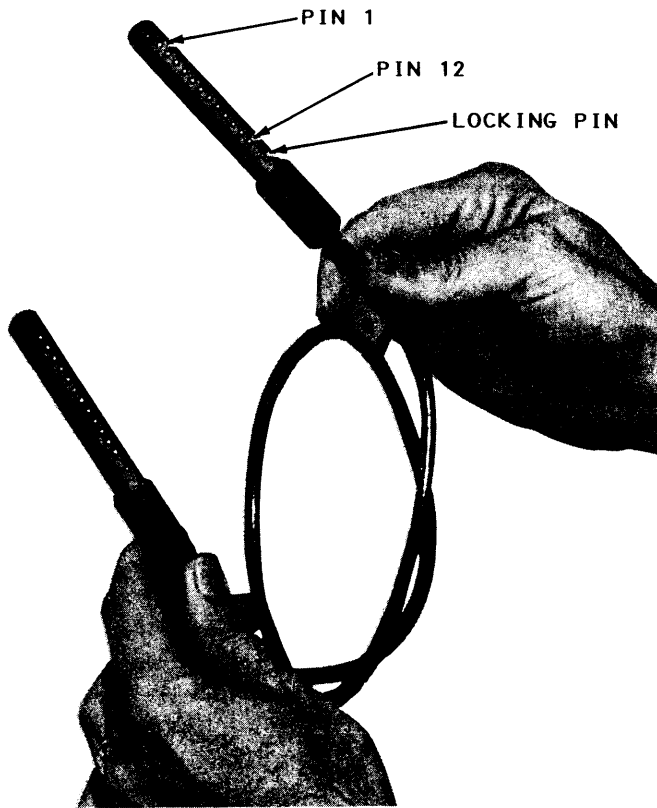

317.29

Figure 4-25.—Typical multicircuit patch cord.

sink is synonymous with *equip* and *computer*. Figure 4-24 illustrates the front and rear views of this patch panel. The jacks associated with circuit 1 are indexed to functional descriptions contained in table 4-12. The functions of the other 11 circuits are identical to those for circuit 1. Patching is by multicircuit patch cords, illustrated in figure 4-25. A locking pin ensures that the plug is securely retained in the jack until removed by the operator. To insert the multicircuit patch cord,

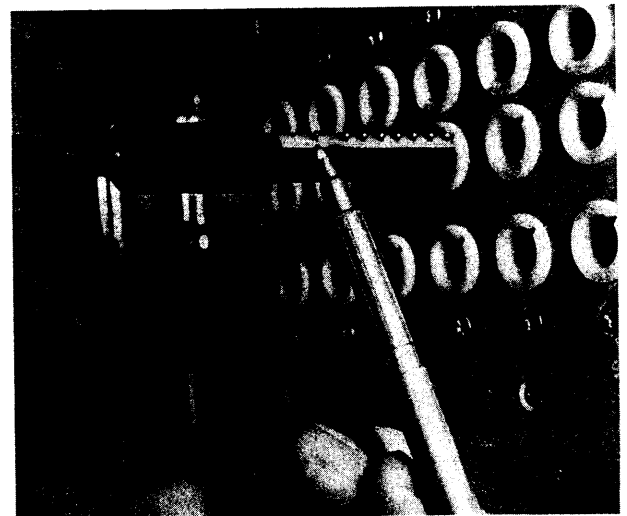

317.30

Figure 4-26.—Patch cord locking device.

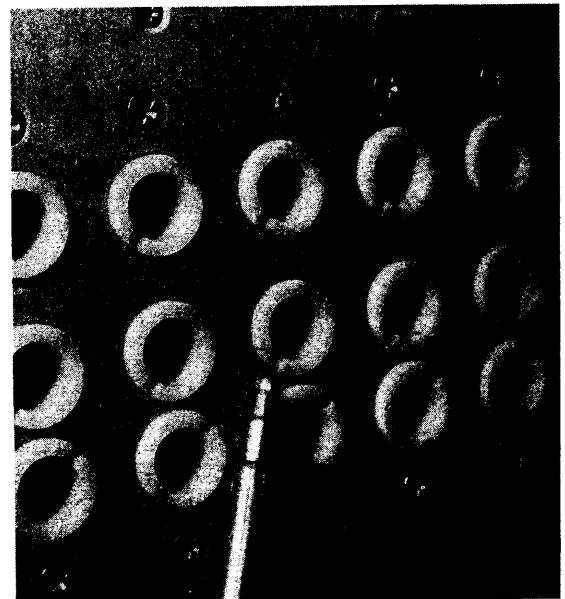

317.31

Figure 4-27.—Patch panel locking device.

line up the contacts on the plug, figure 4-26, with the key on the jack, figure 4-27. Push all the way in against the resistance of the locking spring and turn about 20 degrees clockwise against the stop to lock. To remove the patch cord, push in and turn counterclockwise about 20 degrees to unlock; then remove it from the jack. The normal patch procedure is from the SOURCE jack of one

Table 4-12.—Communications Patch Panel, SB-4012/US, Controls and Indicators

CONTROL INDICATOR INDEX NO. FIG 4-24	NAME (Nomenclature)	POSITION/ CONDITION	FUNCTION/PURPOSE/ INSTRUCTIONS
1A	Monitor Jack (MON)	—	Permits on-line monitoring of a digital data circuit without disturbing signal flow.
1B	Source Jack (SOURCE)	—	Connected to the data source side of a digital data circuit. This jack is normalled through to the equipment connected to the SINK jack of the same circuit. When a patch cord is inserted into a SOURCE jack, the SINK equipment is isolated from the circuit and an alternate set of signals is applied, via the patch cord, to the source lines.
1C	Sink Jack (SINK)	—	Connected to the equipment or signal lines utilizing the data source. This jack is normalled through to the SOURCE jack of the same circuit. When a patch cord is inserted into a SINK jack, the source lines are isolated from the circuit and an alternate set of signals is applied to the sink lines.
2	Monitor In Jacks (MON IN)	—	Provide a means for monitoring or maintenance testing of a digital data circuit. When a patch cord is inserted into one of these jacks, the signals associated with the circuit under test are available at the 12 TIP test points and the 25-pin EIA connector located directly below the MON IN jack.
3	TIP Test Points (1 through 12)	—	Provide a means for monitoring or testing any of the 12 lines associated with a digital data circuit.
4	25-Pin Female EIA Connector	—	Provides a means for patching a digital data circuit into a transmission test set or other digital test device. Used in conjunction with MON IN jack 1.
5	25-Pin Male EIA Connector	—	Provides a means for patching a digital data circuit into a transmission test set or other digital test device. Used in conjunction with MON IN jack 2.

Table 4-13.—Standard Wiring, 12-Circuit, DYNA-PATCH Modules (1 Channel)

<u>Modem Conn. (male)</u>	<u>DP. Jack Pin</u>	<u>Wire Color</u>	<u>CCITT V24</u>	<u>Circuit</u>	<u>DP. Jack Pin</u>	<u>Computer Connector (female)</u>
1	—	—	101	Protective ground (strapped to chassis)	—	1
2	1	Black	103	Transmit data	1	2
3	2	Brown	104	Receive data	2	3
4	3	Red	105	Request to send	3	4
5	4	Orange	106	Clear to send	4	5
6	5	Yellow	107	Data set ready	5	6
7	6	Green	102	Signal ground (common return)	6	7
8	7	Blue	109	Receive line signal detector	7	8
15	8	Violet	114	Transmit signal element timing (DCE)	8	15
17	9	Grey	115	Receive signal element timing (DCE)	9	17
20	10	White	108	Data terminal ready	10	20
22	11	White/Black	125	Ring indicator	11	22
24	12	White/Red	113	Transmit signal element timing (DTE)	12	24



Figure 4-28.—Breakout Test Panel, BTB-12.

317.32

circuit to the SINK jack of the second circuit. Table 4-13 details the standard wiring of the 12-circuit patch panel. The standards developed in the commercial world by Electronic Industries Association (EIA) to define interface parameters

are used in the SB-4012/US. Note that specific mission and installation requirements at various NAVSECGRU and SPINTCOMM technical control facilities may require special wiring requirements.

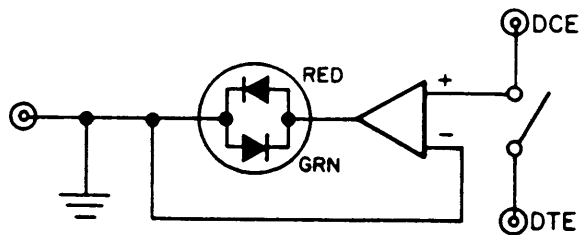

Figure 4-29.—Wiring diagram pulse trap.

BREAKOUT TEST PANELS

Breakout test panels are completely self-contained test panels designed to aid in the troubleshooting of the multicircuit patch panel. There are three models:

- a 12-circuit (BTB-12) panel (shown in figure 4-28),
- a 16-circuit (BTB-16) panel, and
- a 24-circuit (BTB-24) panel.

To use the panel, the operator must first ensure that all switches are in the up or closed position. For on-line testing, monitoring multicircuit patch cords connect the Data Circuit-Terminating Equipment (DCE) and Data Terminal Equipment (DTE) jacks to the LINE and EQUIP jacks on the Patch Panel, SB-4012/US. This places the breakout test panel in series with the circuit. For monitoring only, the DCE jack may be connected to the MON jack on the SB-4012/US. Each EIA lead shown on

the panel has a tri-state (red-off-green) LED associated with it. The LEDs will turn on as follows:

- More positive than +3 volts = RED
- More negative than -3 volts = GREEN

The area between -3 and +3 is considered undefined, and the LED will be off for voltages in this range. The LED is wired to the DCE side of the switch. If the switch is closed, the LED will indicate the polarity present on the lead. If the switch is open and the lead originates from the DCE, the LED will remain on, even though the circuit is broken. If the lead is forced on the DTE side, the LED will not indicate the true polarity, only what is present on the DCE side of the switch. If the lead originates from the DTE side and the switch is open, the LED will indicate the actual voltage present on the DCE side.

A pulse trap with LED is incorporated in the panel. See figure 4-29. This circuit consists of a resettable latch and an input test point. The circuit aids the user in determining line problems, such as short carrier drop-outs and improper responses to polls. To use, select the lead to be examined; patch by using a test lead from the pin in question to the input of the trap and press the reset button. If a transition occurs afterward, the LED will latch and hold. It may be reset again and will operate as before. This circuit indicates that a pulse occurred if it is longer than 3 microseconds. See figure 4-30.

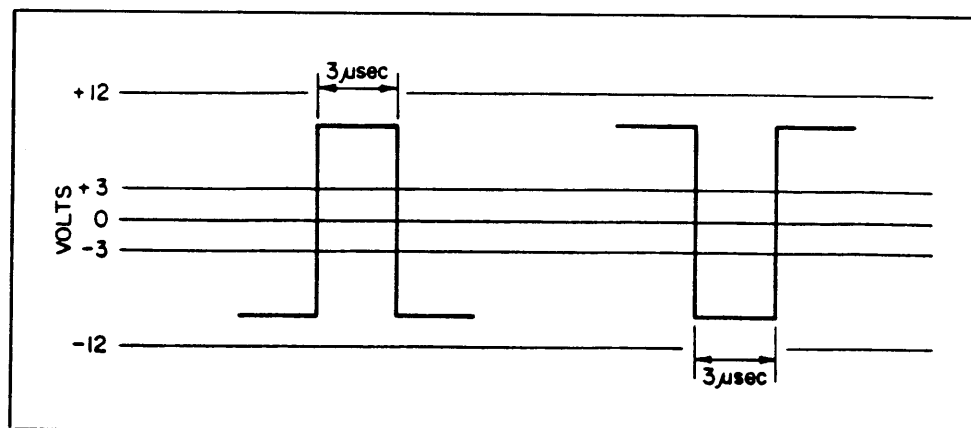

Figure 4-30.—Pulse trap time duration.

CLOCK DISTRIBUTION SYSTEM (COVERLET), CDS-10

The COVERLET system generates over 155 different clock frequencies and has the ability to distribute up to 84 different frequencies at one time. The CDS-10 may be used with external reference oscillators to provide frequency accuracy. Figure 4-31 is an overall view of the CDS-10.

Figure 4-32 illustrates a typical application for the CDS-10, using external reference oscillators. The three separate oscillators provide a triplicated reference input to the CDS-10 of 1.0 or 1.544 MHz. The reference inputs are applied to three separate master divider cards. See figure 4-33. Each of these cards generates the 21 base frequencies that are distributed on a bus to the line driver cards. The master divider cards also contain the voting circuits that will automatically remove a card from the base frequency bus if an error is detected on the card.

The CDS-10 may be operated as a slave unit. As shown in the diagram, the master unit provides three separate sync signals from the triplicated master divider cards. These signals are brought through an interface module (the RED/BLACK Isolator [RBI]), using fiber-optic cables to the slave unit. See figure 4-34.

Since the CDS-10 is designed for continuous and uninterrupted operation, there are no operating requirements. Once the CDS-10 is turned on, it should remain in service as long as required.

There are three different types of status indicators or audible alarms associated with the CDS-10. These include the status lamps on the master cards, status lamps on the line driver cards, and status lamps on the power supply input and output modules. Each of the lamps is wired to provide a "positive" indication. That is, when the lamp is on, it indicates that the associated circuitry is operating within the established parameters. Audible alarms are activated when a status lamp goes out. Figure 4-35 is a functional diagram of the alarm circuitry.

TRANSMISSION IMPAIRMENTS

A technical controller facing a combined patching bay in a large facility looks into a bewildering array of jacks for all circuits leading into and out of the station. The number of jacks may run into the hundreds. Not only must the controller know the type of test equipment to use in measuring the signal parameters, but he must be aware of the various transmission impairments or faults that may occur within any given circuit or data link. All communications channels are

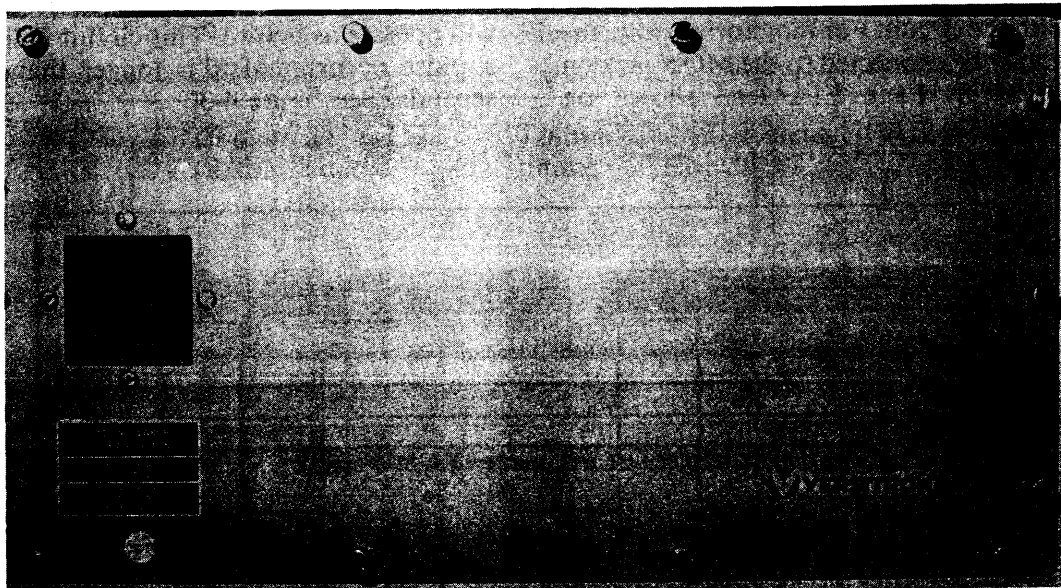

Figure 4-31.—Overall view, Clock Distribution System, CDS-10.

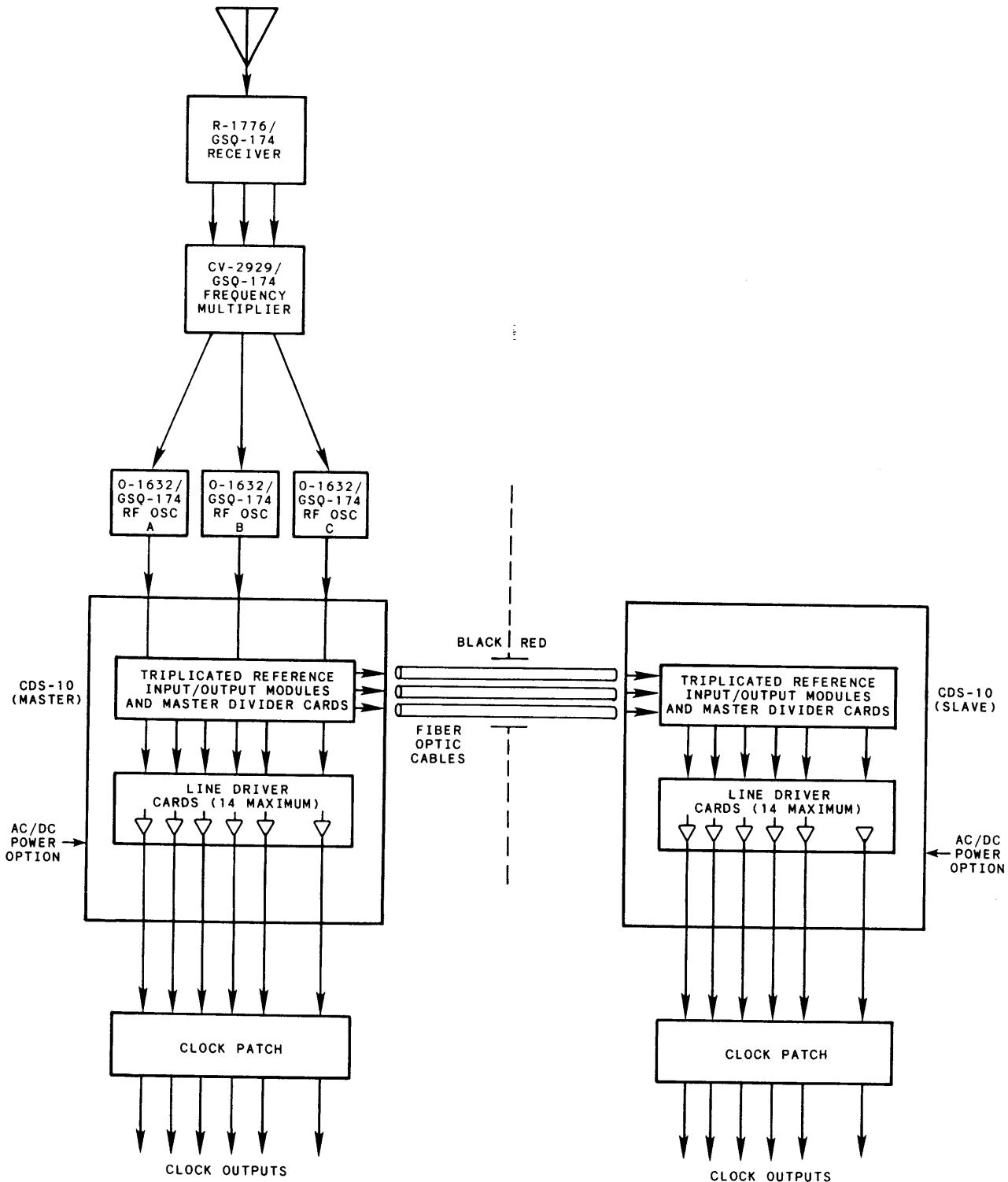

Figure 4-32.—Typical application diagram for Clock Distribution System, CDS-10.

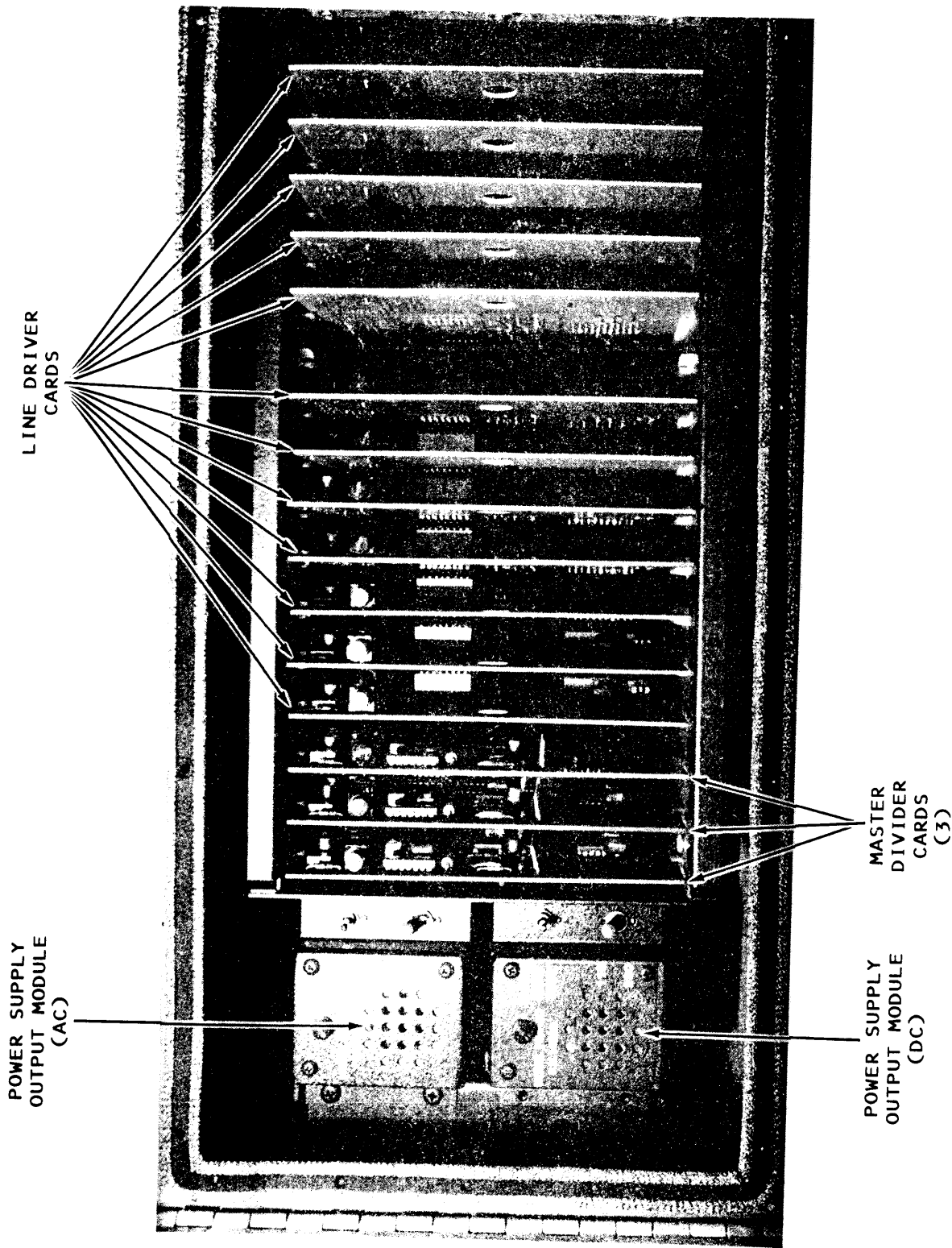

Figure 4-33.—Front view of Clock Distribution System, CDS-10.

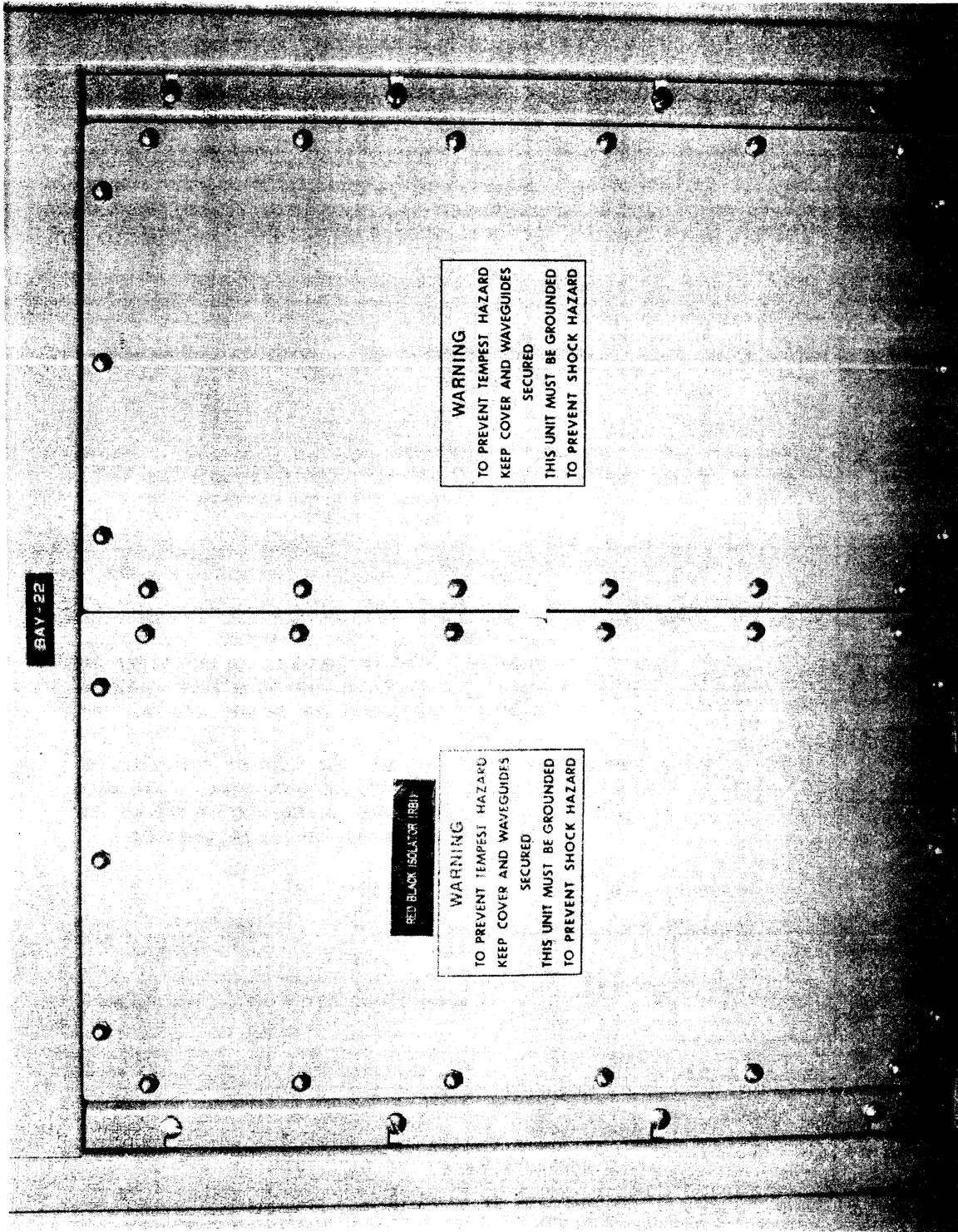

Figure 4-34.—RED/BLACK isolator.

317.35

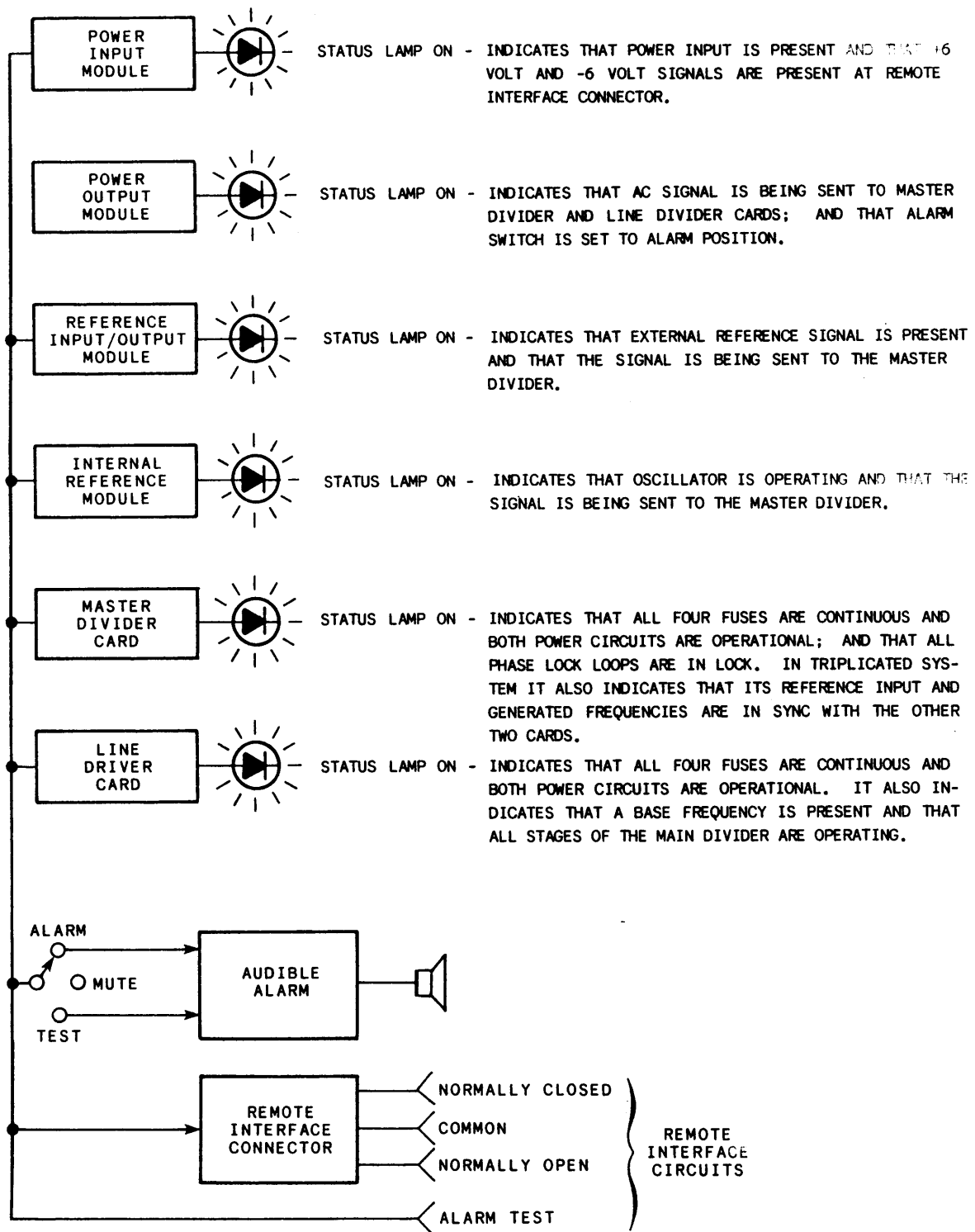

Figure 4-35.—Functional diagram of alarm circuitry.

subject to transmission limitations and effects that evidence themselves as signal impairments. Some of the impairments are random, occurring in a manner that is either unpredictable or predictable only by statistical methods. Other impairments are systematic; that is, they are constantly present in the system and unchanging. Random and systematic transmission impairments are listed in tables 4-14 and 4-15, respectively.

The primary random impairment is noise, which has many causes and sources. Another random impairment of particular significance to digital communication is phase jitter.

Transmission impairments affect digital communications in two ways:

1. They cause errors in the transmitted data.
2. They limit the speed with which data can be transmitted.

With regard to noise as an impairment, the effects are related and can be traded off one against the other. The other impairments produce one or the other effects, as well as increase the susceptibility of communications channels to noise.

Table 4-14.—Random Transmission Impairments

Impairment	Source	Cause
White noise	Electronic circuitry	Random motion of electrons
Impulse noise	External to transmission system: switches, relays, atmospheric static, lightning, power lines, radar transmitters, electrical machinery. Internal to system: faulty contacts	Sharp voltage changes
Crosstalk	Physically adjacent channel transmission media	Capacitive and inductive coupling, radiation
Intermodulation noise	Transmission equipment and media	Nonlinearities
Echoes	Transmission circuits	Impedance mismatches
Radio propagation fading	Radio link	Propagation anomalies
Circuit interruption	Transmission system switching system	Switchover to standby equipment, maintenance activities
Phase changes, phase jitter	Transmission system	Unwanted incidental FM or PM by impulse noise

Table 4-15.—Systematic Transmission Impairments

Impairment	Source	Cause
Path loss variations	Transmission system	Slow temperature changes, amplifier drift, equipment aging
Nonlinear attenuation-frequency characteristic	Transmission system, primarily analog telephone channels	Some frequencies in signal spectrum attenuated more than others
Delay distortion	Transmission system, primarily analog telephone channels	Some simultaneously transmitted frequencies received before the others
Harmonic distortion	Transmission system	Some voltage levels attenuated more than others; adds harmonics
Frequency offset	Analog Telephone channels using FDM	Frequency difference between transmitting and receiving FDM carrier supply oscillators
Bias distortion	Pulse regenerators	Improper adjustment of regenerators
Characteristic distortion	Transmission system	Nonlinear transmission characteristics
Timing jitter	Regenerative repeaters	Instability of clock frequency in repeaters

WHITE NOISE

White noise occurs in all electronic circuitry. It is caused by the random motion of electrons and increases in energy with temperature. Its amplitude varies randomly with time. It can be described by the familiar, bell-shaped, or Gaussian curve. For this reason, it is often referred to as *Gaussian noise*. The term *white noise* stems from the fact that it occurs over the entire spectrum of electromagnetic frequencies, just as white light extends over the entire spectrum of optical frequencies.

White noise causes errors in data transmission by mimicking or masking pulses. This is illustrated in figure 4-36. Binary input signals (in the figure, an NRZ signal) are rounded off by the characteristics of the transmission equipment and medium. Because white noise is introduced wherever there is electronic circuitry, it is amplified along with the signal and, in effect, amplitude-modulates the signal. Thus, the received signal is a combination of the desired waveform and the noise waveform.

When sampling takes place in the demodulation process, the amplitude of the combined waveform can cause a mistake in the interpretation of the sample. As shown in figure 4-36, if

the combined amplitude is above the slicing level when a binary 0 is intended, the sample will be interpreted as a binary 1. If the amplitude is below the slicing level when a 1 is intended, the result will be a 0.

The extent by which the signal power exceeds the noise power (that is, S/N) determines the statistical frequency with which bit errors will be caused by white noise. Moreover, the bit error rate increases incrementally with the values of M in M-ary transmission, since each pulse mimicked or masked by a noise peak conveys multiple bits of information. M-ary is explained in more detail in appendix I. Figure 4-37 shows the relationship of Bit Error Rate (BER) to S/N for M = 2, 4, and 8. The probability of error is in terms of negative exponents of 10. It is read as the number of erroneous bits received, divided by the total number of bits. Thus, an ordinate value of 10^{-6} , which is equivalent to $1/10^6$, means one erroneous bit in 10^6 (one million) bits.

White noise is of major concern in radio transmission. Propagation fading can cause rapid and extensive fluctuations in the power level of the received signal. Most of the noise power implied in S/N is generated in the early stages of the receiving equipment and maintains a constant

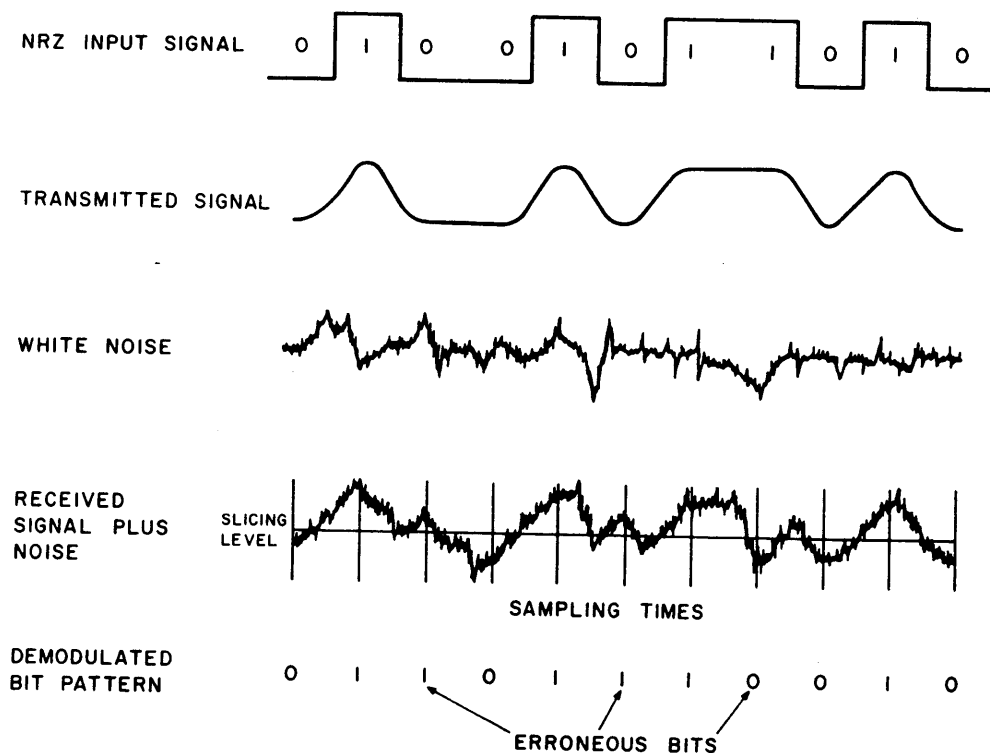

Figure 4-36.—Effect of white noise on binary data transmission.

level. It is amplified along with the incoming signal and by the same amount. Consequently, when the received signal power is at a low level, the S/N at the amplifier output will be small. When the received signal power is at a high level, the S/N will be large.

IMPULSE NOISE

Impulse noise is the main source of errors in digital communications. It is largely unpredictable, except through identification of potential sources and knowledge of its behavior in the electromagnetic spectrum. Impulse noise varies widely in amplitude and duration. Amplitude may exceed that of the received signal, and duration may range from nanoseconds to hundredths of seconds. It is more disruptive to digital communications than to voice communications, because it can cause bursts of bit errors, while a

listener would hear only a click or a crackling sound.

The sources of impulse noise are found both within and outside the communications channel. External impulse noise is picked up by inductive or capacitive coupling to the channel. Its major source in communications applications is the switching system. The relays and switches cause abrupt voltage changes that register as impulse noise and are largely unavoidable. Impulse noise arises internally from poorly soldered connections and dirty relay contacts, slight movements of unsoldered twisted wires, and, generally, any changes in contact resistance.

All transmission media are vulnerable to impulse noise, although the sources may vary with the medium. Impulse noise has the greatest effect on Amplitude Modulation (AM), less on Frequency Modulation (FM), and least on Pulse Modulation (PM).

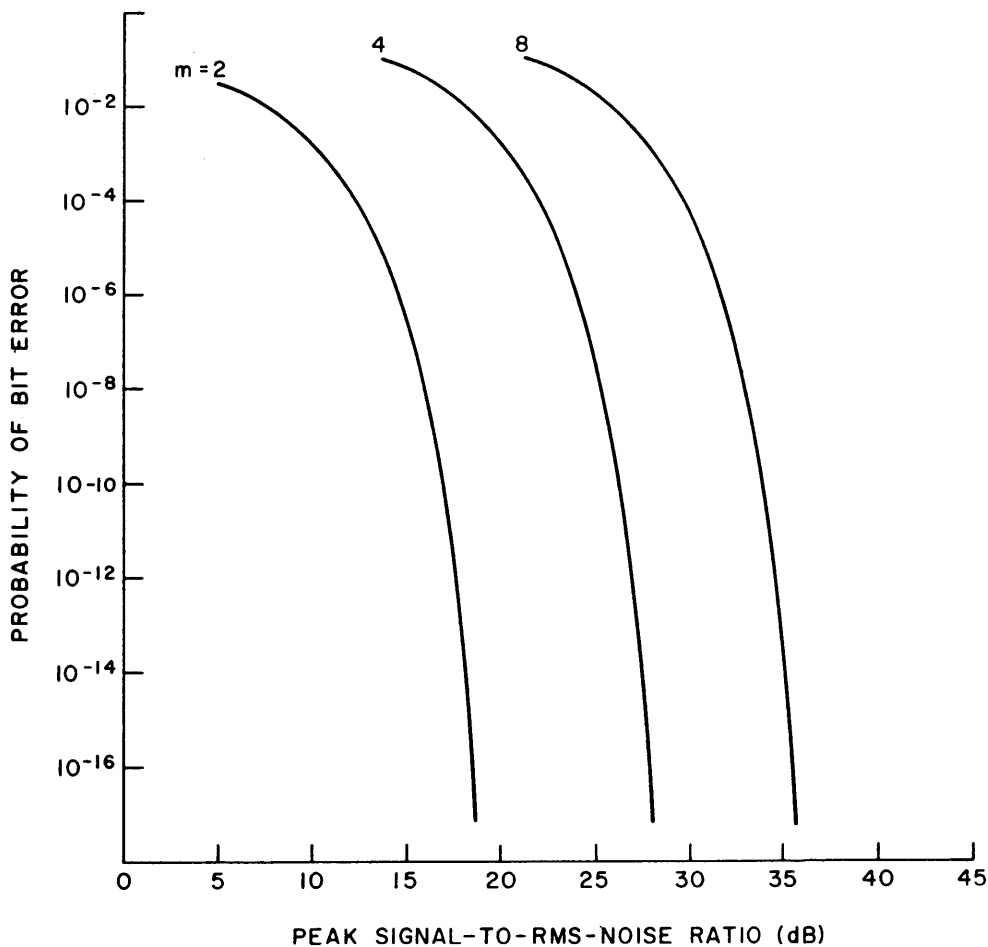

Figure 4-37.—Probability of bit error as a function of S/N for M-ary code transmission.

CROSTALK

Crosstalk is the noise produced when signals transmitted in one channel are picked up in an adjacent channel. Electrical coupling between wire pairs in cable, inadequate filtering, lack of shielding, and non-linear responses in transmission equipment can cause the unwanted transfer of signals from one channel to another. Multiplexers and switches are common points for the introduction of crosstalk, since many channels are brought physically close at these points.

It is relatively easy to maintain crosstalk levels that are low enough so as not to interfere with signals using two discrete amplitude levels. The problem is more severe, however, when dealing with multilevel signals such as those encountered in Pulse Amplitude Modulation (PAM).

INTERMODULATION NOISE

Intermodulation noise is found most often in analog communications systems using Frequency-Division Multiplexing (FDM). It becomes particularly troublesome when digital signals are sent over the FDM channels. The noise is produced

in amplifiers that handle many different signals together. Non-linearities in the amplifiers cause signals from independent channels to modulate each other. When the product of this intermodulation falls into the frequency band of the channel, it appears as noise.

When large numbers of frequencies intermodulate each other, the product appears as background noise, which is similar to white noise. If only a single frequency modulates the other channel frequencies, the product may be an intelligible signal in another channel. This is why digital transmission is particularly troublesome with regard to intermodulation noise. First, a continuous sequence of alternate 0s and 1s (a square wave) could appear as a single frequency after passing through some of the filtering states involved in analog transmission. Second, many digital data machines maintain end-to-end synchronization during idle periods by keeping a tone (single frequency) on the line. One solution is to restrict the level of the tone or data signal.

ECHOES

Echoes in long transmission circuits interfere with data transmission by causing bit errors. They

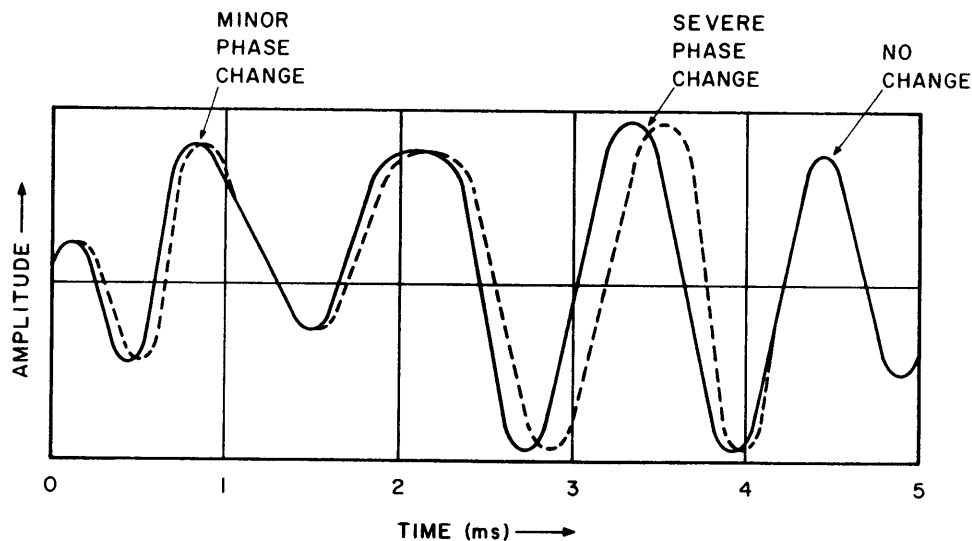

LEGEND:

- TRANSMITTED SIGNAL
(ADJUSTED FOR ABSOLUTE DELAY)
- - - RECEIVED SIGNAL

Figure 4-38.—Phase change during transmission.

originate at points where there is a change in impedance. One of the most common points is the junction of a two-wire and a four-wire circuit. Echo suppressors are used in voice communications to limit the levels of the reflected signals that constitute echoes and that originate at the two-wire/four-wire junctions. They cannot be used in data transmission, however, because they operate with a built-in delay on the order of milliseconds. Even a fraction of a millisecond delay is disruptive in data transmission.

Again, one method of combating disruptive echoes in data transmission is to limit the signal level so that the echo level (the reflected signal level), which is naturally attenuated by the round trip, is masked by the background noise. Another method is to use four-wire lines exclusively and avoid the impedance change to the two-wire lines. This is not a complete cure, however, because other impedance changes are present in transmission systems.

AMPLITUDE AND PHASE VARIATIONS

The character of a transmitted signal varies as it traverses the propagation medium. The extent and nature of the variations depend on the particular medium. Microwave radio transmissions are subject to atmospheric conditions that are, themselves, subject to diurnal and seasonal variations. Rain, fog, mist, and haze cause microwave signals to be attenuated more than the normal free-space attenuation. Both oxygen and water vapor absorb energy from frequency bands in the spectrum between 10 and 160 GHz. Rainfall produces even more attenuation than oxygen and water vapor alone. Mist is intermediate in its attenuation effect. Since all of these natural occurrences produce independently varying amounts of attenuation, it is clear that the amplitude of microwave transmissions will be quite variable.

Multipath propagation—the transit of radio waves over more than one path between terminals—causes some portions of the transmitted signal to arrive later than others. Variation in atmospheric refractivity and the presence of reflecting surfaces along the radio route cause multipath propagation. The result is a variation in the phase of the received signal. Phase change is illustrated in figure 4-38.

High-Frequency (HF) radio transmissions are reflected from the ionosphere and the earth

as they undergo the multiple hops required for long-distance transmission. They are, therefore, subject to fluctuations in the ionospheric electron density caused by ionizing radiation from the sun. HF signals also undergo amplitude and phase variations because of multipath propagation.

Cables comprise another type of transmission medium. Although the amplitude and phase of signals carried by well-designed cables do not suffer variations as abrupt or irregular as those produced by atmospheric phenomena, they are subject to variations in temperature.

Amplitude and phase variations can be minimized by automatic equalization techniques that tend to compensate for the changes, much as feedback amplifier circuits tend to hold amplifier gain constant and relatively independent of ordinary power supply variations or other circuit anomalies.

CIRCUIT INTERRUPTION

Brief intervals of open or short circuits may be caused by storms, propagation anomalies, faulty equipment, and maintenance activities. Signal losses on the order of 1 millisecond cause bit errors. Losses of a longer duration result in circuit outages.

PHASE AND TIMING JITTER

Phase jitter is an unwanted change in the phase or frequency of a signal due to modulation by another signal during transmission. It is measured in degrees of variation (p-p) per Hz of transmitted frequency. Since phase jitter shows up in signal reception as unwanted variations in \emptyset -level crossings, and since these crossings are used by detection circuits to distinguish between \emptyset s and 1s, the higher the data rate, the more the jitter can affect the received BER.

Regenerative repeaters, designed to reconstruct pulses at points along the channel to maintain an adequate S/N, are subject to timing jitter—a systematic impairment due to instability in the retiming function. Such instability can be produced by improper threshold settings of the time regenerator, mistuning of the repeater receiving circuitry, and intersymbol interference. Timing jitter can also cause phase jitter, which is cumulative over a number of repeaters.

LONG-TERM PATH LOSS VARIATIONS

Some variations in path loss over the various transmission media occur slowly and last for long periods of time. Such variations come under the heading of systematic impairments, since they produce long-term effects on transmission. The effects are amplitude and phase changes. Since they are long-term, they can be compensated for by equipment adjustments. The causes of such changes are slow temperature changes (with seasons), amplifier drift, and equipment aging.

NON-LINEAR ATTENUATION-FREQUENCY CHARACTERISTIC

This systematic transmission impairment is found primarily in analog transmission channels. When such channels are used for data transmission, the impairment limits the channel's capacity in terms of transmission rate.

Attenuation of the amplitude of signals transmitted over analog channels is frequency dependent. Ideally, it should remain constant over a wide band of frequencies. In reality, it does not. Figure 4-39 shows the attenuation-frequency characteristic of a typical 2400-bps data channel that meets the criteria for links between AUTODIN Switching Centers (ASCs) in the Defense Communications System (DCS). The DCS nomenclature for such a channel is Technical Schedule D1.

Perfectly rectangular pulses contain sine-wave components of all frequencies. Even relatively rectangular pulses contain components covering a wide band of frequencies. The pulses undergo severe distortion in transmission if the attenuation-frequency curve is not reasonably flat over the frequency band of interest. Different portions of the pulse will be attenuated by different amounts.

The flat top of a pulse is composed of the lower frequencies. In principle, a perfectly flat top requires a dc component. The leading and trailing edges of the pulse represent the higher

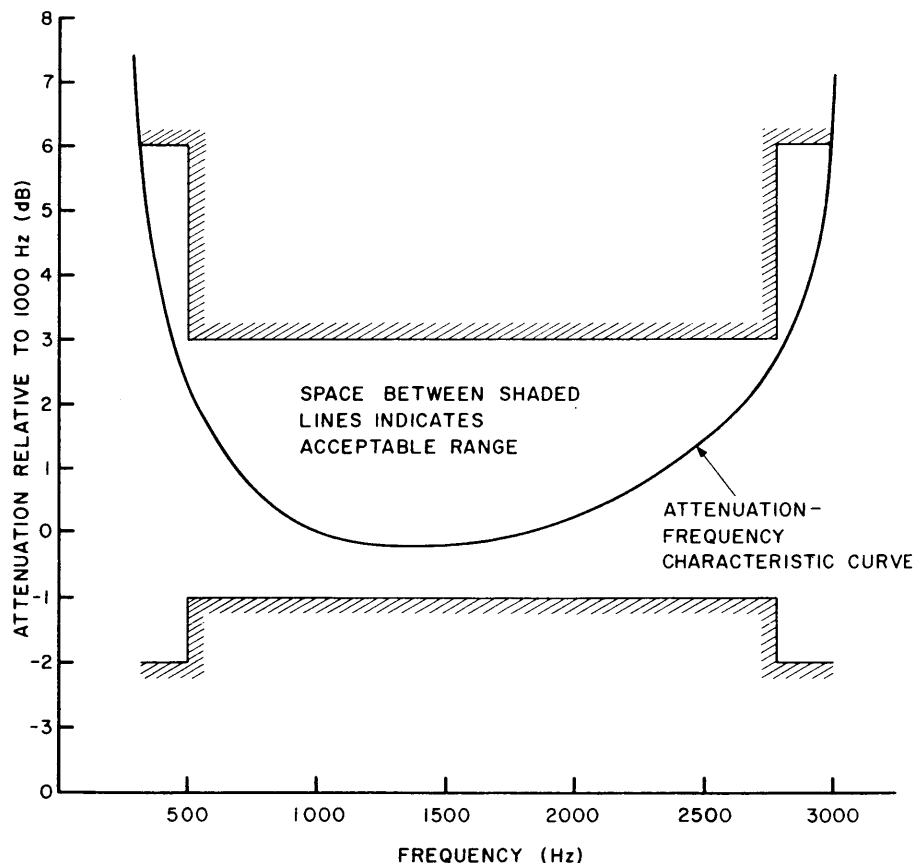

Figure 4-39.—Typical attenuation-frequency characteristic for DCS Technical Schedule D1 channel.

frequency components. The steeper the slope of the leading edge, the higher the frequency required to convey it.

The attenuation distortion resulting from an attenuator-frequency characteristic can be corrected by amplitude equalization. This is accomplished by inserting a compensating filter, known as an *equalizer*, in the circuit. The filter characteristic is chosen to compensate the attenuation variation with frequency of the transmission channel. Amplitude equalization is one aspect of a process used to make analog channels suitable for data transmission. The process is called *conditioning*.

ENVELOPE DELAY DISTORTION

This systematic transmission impairment is also found primarily in analog transmission channels. As in the case of the attenuation-frequency characteristic, the end result is a limitation on the channel capacity.

Envelope delay distortion is a result of different frequencies in the channel bandpass being delayed by different amounts during transmission. This affects the relative phase of the various frequency components comprising the

transmitted signal in such a way that the signal is distorted. Such distortion is not serious in voice communications. Speech remains intelligible, even with delay distortion amounting to 0.05 second.

Delay distortion in most channels is much less. It severely impairs the recovery of data signals, since it distorts pulses to the point where they overlap destructively (intersymbol interference). In general, delay distortion interferes with their recognition. Typical delay distortion in a DCS Technical Schedule D1 channel is shown in figure 4-40.

A higher S/N provides one means of overcoming intersymbol interference resulting from delay distortion. The primary means of combating this distortion, however, is delay equalization. Delay equalizers are essentially phase-correcting networks. They may consist of many network sections, leading to some residual attenuation and phase ripple across the band. When the envelope delay characteristic of a channel remains unchanged, fixed equalizers can be applied successfully. Automatic and adaptive equalizers are also available for situations where the delay characteristic cannot be reliably predicted. Automatic equalizers use a special train of pulses before information to determine the delay

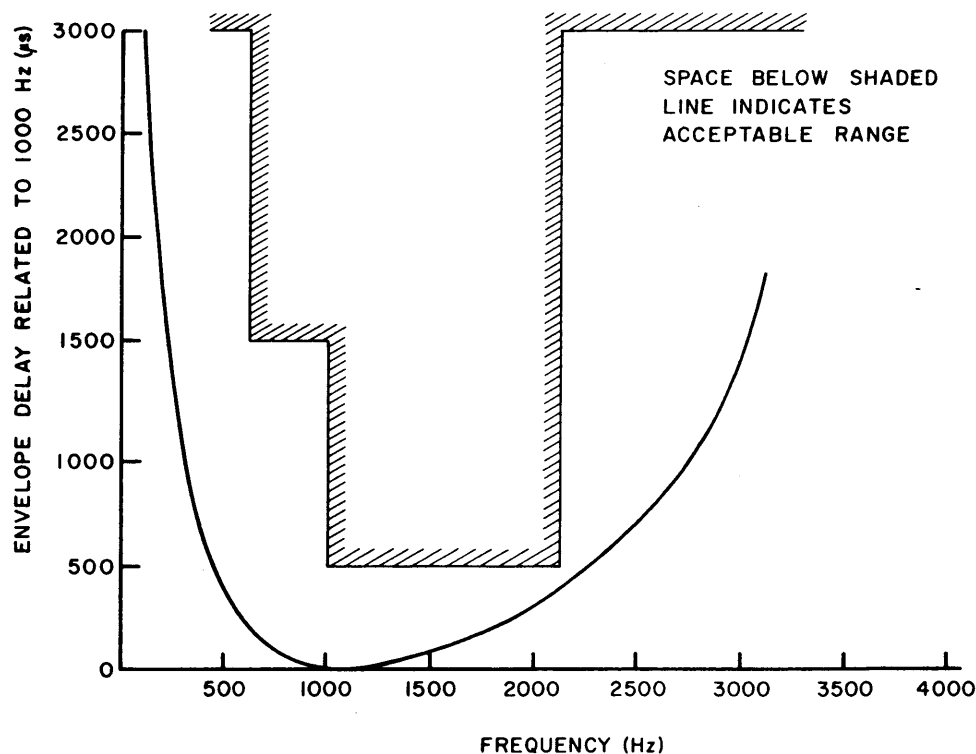

Figure 4-40.—Typical envelope delay in DCS Technical Schedule D1 channel.

characteristics of the channel. The equalizers adjust themselves to these characteristics. Adaptive equalization operates in a similar manner, but it is a continuous function during transmission and compensates for variations in phase delay.

HARMONIC DISTORTION

Harmonic distortion is another systematic impairment found in analog transmission channels. It refers to the condition in which the signal is attenuated more at some amplitudes than at others. For example, a 2-volt signal may be attenuated to 1 volt, while a 5-volt signal may be attenuated to 2 volts. The respective attenuations are 1/2 and 3/5.

Such unequal attenuation tends to flatten out sine waves and distort pulse shapes. It is called *harmonic distortion* because of the effect it produces on a sine-wave signal.

Harmonic distortion results from circuit non-linearities and must be controlled in equipment design to keep the signal-to-distortion ratio high, particularly where data transmission at high rates is involved.

FREQUENCY OFFSET

Frequency offset is the effect produced by the oscillators that generate the carrier frequencies (or their submultiples) for modulation and demodulation not operating at precisely the same frequency. The frequency difference results in the demodulated signal being offset in frequency from the input signal. The problem occurs mostly in suppressed carrier transmissions and is corrected by transmitting the carrier itself or information concerning its frequency and phase.

BIAS DISTORTION

Bias distortion is a form of systematic distortion that results in pulses being lengthened or shortened. It is usually produced in the pulse-regeneration process at repeaters and is due to the improper setting of the decision threshold for binary 0 or 1. Consequently, it can be corrected by adjusting the setting.

CHARACTERISTIC DISTORTION

Characteristic distortion is similar to bias distortion, except that it is produced by non-linearities in the transmission medium or equipment. Such non-linearities as bandwidth restriction and intersymbol interference produce characteristic distortion.

TESTING EQUIPMENTS

This category of equipment consists of general- and special-purpose electronic test equipment located in the TCF. These testing equipments are used to test and monitor signal quality. The TCF operator has access to this equipment via the various patch panels. The equipment includes voltmeters, current meters, oscilloscopes, spectrum analyzers, distortion analyzers, signal generators, and transmission test sets. Many of these are used for routine operations, others are reserved for circuit conditioning and quality control. Some basic test equipments used in TCF are described in the following paragraphs.

METER PANEL, ME-400/G

The meter panel, illustrated in figure 4-41, contains a 10-volt, dc, 0-centered meter, an

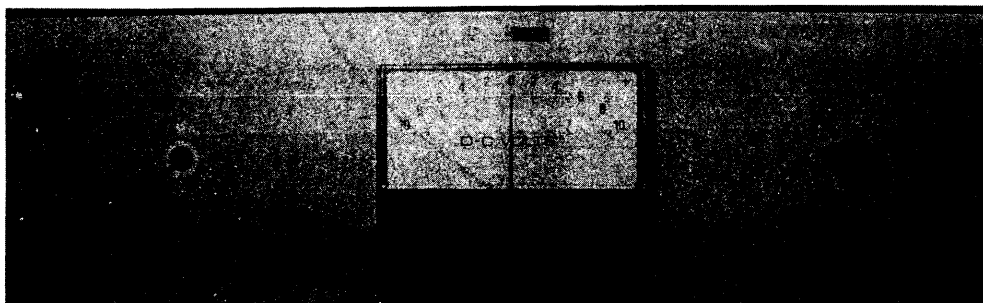

Figure 4-41.—Meter Panel, ME-400/G.

optional test jack, and a 12-position switch for monitoring the +/- 6-volt, low-level signal circuits. The panel is designed to be mounted in a standard 19-inch wide rack.

MILLIAMMETER

The 0-centered milliammeter is similar to the Meter Panel, ME-400/G. See figure 4-41. However, where the ME-400/G is used to measure voltages, the milliammeter is used to measure milliamperes of a dc circuit. The operator can use it for other purposes by interpreting the readings. It signals whether neutral signals or polar signals are being passed, and whether the current is normal for the condition at hand.

For example, a neutral circuit can be identified by current for a mark, and absence of current for a space. Neutral signals can be identified by the pulsing of the meter needle to one side of 0. If a repeated letter is transmitted, the meter pulsing will have a repetitious pattern. When test signals or traffic is transmitted, the meter pulsing will be erratic. Reversals (continuous streams of equal-length mark and space pulses, such as R/Ys) are read as near one-half of the current value.

A polar circuit can be identified by current flow in one direction for mark, and in the opposite direction for space. If a repeated signal is transmitted, the swing of the needle around 0 will exhibit a repeating pattern. Again, test signals or traffic will cause the meter pulsing to be erratic. If reversals are transmitted, the meter will register 0, provided no distortion is present. If distortion is present, the needle will tend to favor the mark or spacing side of the meter, showing the effect of either marking or spacing bias distortion.

VOLUME UNIT (VU) INDICATOR

The VU indicator primarily shows the amplitude levels in speech, rather than measures the level of constant tone. It can be used to indicate a constant tone level with 0 setting of the attenuator (a constant tone of 1 milliwatt (0 dbm) at 1,000 Hz) indicating 0 on the meter scale. Although the indicator can be used for this purpose, the recommended procedure is to use a decibel meter for constant tone, and reserve the VU indicator for speech signals.

The function of the attenuator is to keep the meter reading on scale. That is, if a signal exceeds the meter scale, the operator adjusts the attenuator to bring it on scale. When the

attenuator is used, its setting must be taken into account in determining the true value of signal level.

AUTOMATED BIT ERROR RATE TESTING, BERTS-25/HP-85

The automated Bit Error Rate Test (BERT) program allows the user to automatically test and evaluate telecommunications systems, using the HP-85 desk-top computer and BERTS-25 Error Measurement System. The BERT program allows the user to set test duration, percent of availability, bit error rate, and data-rate parameters that the system will be tested for. At the completion of the test, the user is provided a detailed report containing characteristics of the system.

Figure 4-42 illustrates a typical application for the BERT program. The program uses BERTS-25

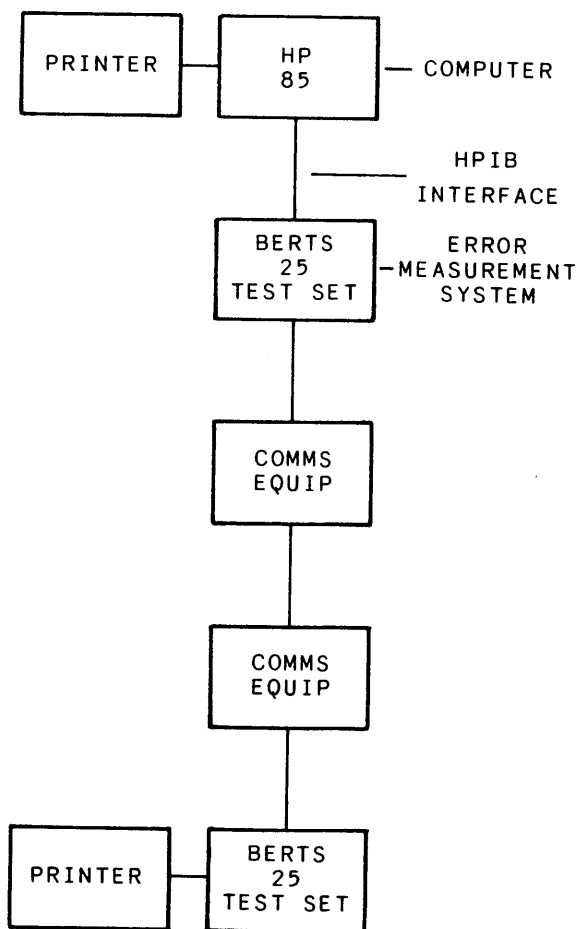

Figure 4-42.— Basic configuration for automated bit Error Rate Testing, BERTS-25/HP-85.

0 HR 6 MIN TEST REPORT

DATE: JAN 10 84

TEST PARAMETERS NOT MET

REASON: PER CENT OF AVAIL NOT MET

PROJECT: HP-85 BERT
TEST TYPE: LOOP-BACK

PARAMETERS

BIT ERROR RATE = 1.000E-007
AVAILABILITY = 100%
MIN AVG LOSS OF BCI = 1 PER 24 HRS
DATA RATE IN MB/S = 1.5440

SUMMARY

LAPSED TIME = 0 HRS 6 MINS
AVERAGE BER = 9.813E-009
AVAILABILITY = 91.66%
LOSS OF BCI EVENTS = 1

BLOCK ANALYSIS

TIME BLOCK SIZE = 30 SECS
BITS PER BLOCK = 4.632E + 007
TOTAL ATTEMPT BLOCKS = 12
VALID BLOCKS = 10
FAILED BER BLOCKS = 1
SYNC LOSS BLOCKS = 1
DATA LOSS BLOCKS = 0
CLOCK LOSS BLOCKS = 0

BER ANALYSIS

TOTAL BITS = 5.095E + 008
TOTAL ERRORS = 5.000E + 000

EVENT ANALYSIS

OF SYNC LOSSES = 1
OF CLOCK LOSSES = 0
OF DATA LOSSES = 0
OF BER FAILURES = 1

Figure 4-43.—Test parameters report.

to detect errors, sync losses, data losses, and clock losses over a sampling period. The data is transferred to the HP-85, where it is stored and compiled into a detailed report. The report, figure 4-43, is printed on the HP-85's printer and the BERTS-25 printer.

DATA COMMUNICATIONS ANALYZER, DATA SENTRY-10

The Data Sentry-10 is a multifunction test set that performs a variety of test functions including error analysis, message generation, data trapping, and Voice-Frequency (VF) measurements. The Data Sentry-10 allows manual and automated testing of modems, multiplexers, terminals, printers, and a variety of other communications devices.

The unit operates in full- or half-duplex configurations and with synchronous or asynchronous timing. Transmit timing may be supplied externally or from the internal frequency synthesizer. The unit will operate at any rate from 10 bps to 500 kbps for synchronous and 10 bps to 20 kbps for asynchronous operation.

The functions of the Data Sentry-10 are as follows:

BERT Functions: Bit error rates, errors, blocks, block errors, error-free seconds, seconds of test, character errors, clock slips, messages received, messages received with errors, preambles missed, parity errors, and framing errors.

Distortion Measurement: Peak early and late telegraph distortion, telegraph distortion due to jitter, and bias distortion.

Frequency Measurements: Audio, transmit clock, and receive clock.

Delay Measurements: Delay between selected signaling lead or external input signal transitions, delay between transmit and receive data, or delay between start or end of transmission and receipt of a trap sequence.

- **Message Generation:** A "FOX" message is available in Baudot, BCDIC, ASCII, or EBCDIC. The controller may also program up to four messages, in any code up to 85 characters each. A detailed description of TTY codes is in appendix I.

- **Data Trapping:** The unit is capable of capturing data conditioned upon the receipt of a one- to four-character trap sequence. Up to 128 characters preceding and following the trap sequence may be displayed or printed. Alternatively, the unit may be instructed to store and display the first 255 characters received.

- **Control Settings:** Up to 10 sets of front panel control settings may be stored internally and recalled at any time.

- **Clock:** A real-time clock is provided as a standard feature. The time is maintained with the power off.

TDM-MODEM TEST SETS, MODELS 1300, 1310, AND 1320

The Model 1300 (series) TDM-modem test set is available throughout NAVSECGRU and SPINTCOMM TCFs. See figure 4-44. A

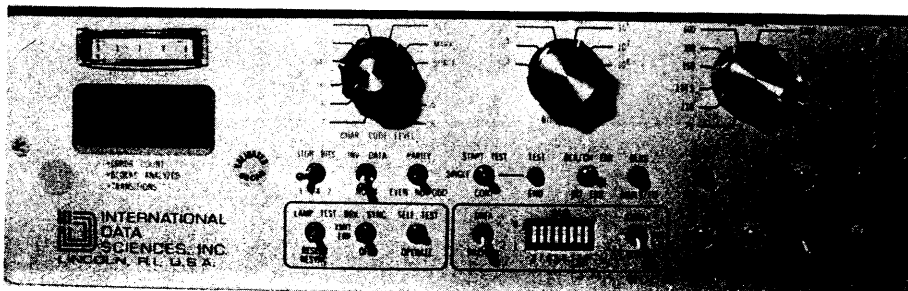
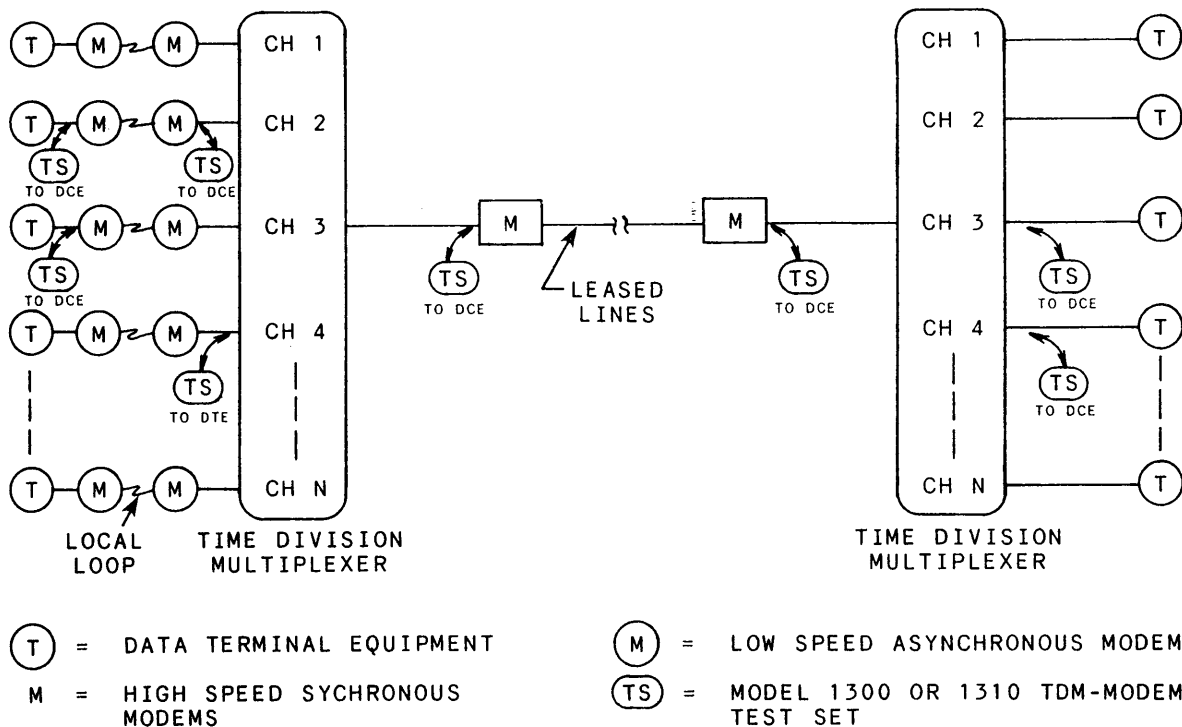

Figure 4-44.—Modem Tester, Model 1320.

comprehensive breakdown of equipment capability follows:

1. Generates start-stop characters containing pseudorandom, alternate, mark, or spacing data.
2. Generates 5-, 6-, 7-, or 8-level characters with odd, even, or no parity and 1, 1.4, or 2 stop bits.
3. Tests synchronous and asynchronous modems, and TDM and FDM systems.



317.38

Figure 4-45.—Typical data communications system.

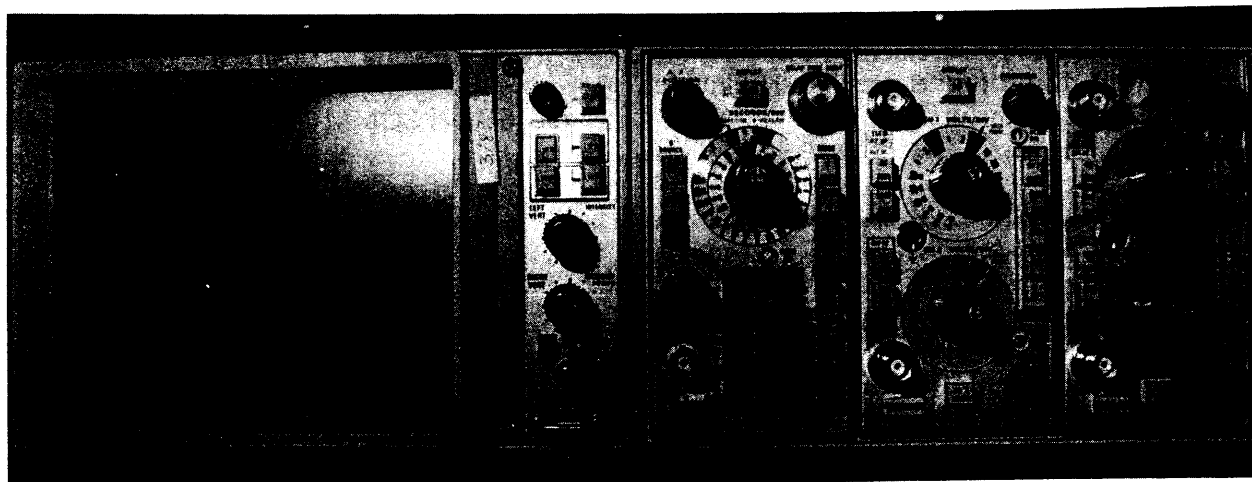

Figure 4-46.—Typical oscilloscope #1.

317.38

4. Calculates and directly displays bit, character, or block error rates.
5. Analyzes single or repeated blocks of bits or characters for error rate.
6. Detects and tallies mark-to-space transitions.
7. Eight LEDs monitor key signals at DTE or DCE interfaces.
8. Operates in a full-duplex mode.
9. Contains both a generator and an analyzer.
10. Selects bit rate testing of asynchronous systems from 75 to 9600 bps; synchronous systems up to 200,000 bps.
11. Bias distortion meter accurate to 1%.
12. Complete self-test capability.
13. Printer output capability.

Figure 4-45 shows a typical data communications system containing both asynchronous and synchronous modems and time-division multiplexers. Various tests may be performed, using Models 1300, 1310, or 1320. TDM-modem test sets are indicated on channels 2, 3, and

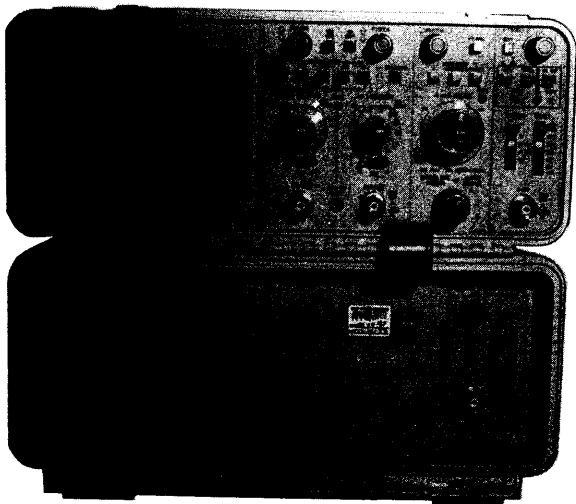

Figure 4-47.—Typical oscilloscope #2.

317.39

4, and on the high-speed portion of the link. Since test sets have full-duplex capability, tests may be performed by using only a single test set, simply by looping the remote modem or multiplexer.

OSCILLOSCOPES

There are many different types of oscilloscopes. See figures 4-46 and 4-47. They vary from relatively simple test instruments to highly accurate laboratory models. Although oscilloscopes have different types of circuitry, most can be divided into five basic sections:

1. Cathode Ray Tube (CRT)
2. Control circuits that control the waveform fed to the CRT
3. Power supply
4. Sweep circuitry
5. Deflection circuitry

The oscilloscope (sometimes called an *O-SCOPE*) is the most versatile piece of test equipment that a technical controller has. Most test equipment is designed to measure amplitude or quantity. The oscilloscope permits many characteristics of a circuit to be observed and measured. Some of these are:

- Frequency
- Duration (or time) of one or more Hertz
- Phase relationships between waveforms
- Shape of waveforms
- Amplitude of waveforms

Naturally, the usefulness of an oscilloscope in any preventive or corrective technique depends upon the operator's knowledge of front-panel controls and operation, and the ability to correctly interpret the resultant pictorial display on the screen. For reference purposes and an in-depth discussion on the controls and indicators, appendix VI includes data for an oscilloscope that may be used in a technical control facility. Although each facility may not have an identical model, the basic operating data should be similar.

UNIVERSAL TEST SYSTEM, HALCYON HC-520B

This system, shown in figure 4-48, is a multifunction instrument designed to measure the significant circuit parameters that affect voice-band data transmission. Its measurement capabilities include the data impairments previously mentioned. It is used extensively for quality control testing and for new circuit acceptance. See appendix V for a detailed description of the universal test system controls and indicators.

SPECTRUM ANALYSIS AND MEASUREMENTS

An analysis of a complex waveform, prepared in terms of a graphic plot of the amplitude versus frequency, is known as *spectrum analysis*. An example of a typical spectrum analyzer used for quality control and circuit acceptance in most technical control facilities is shown in figure 4-49. Spectrum analysis recognizes the fact that waveforms are composed of the sum of a group of waves, each of an exact frequency, and all existing together simultaneously.

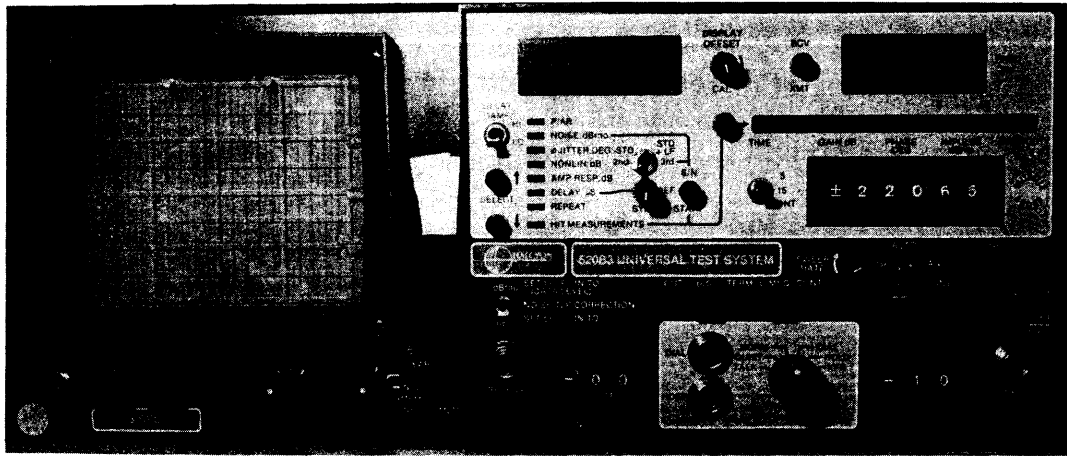

Figure 4-48.—Universal Test Set, HALCYON HC-520B.

317.40

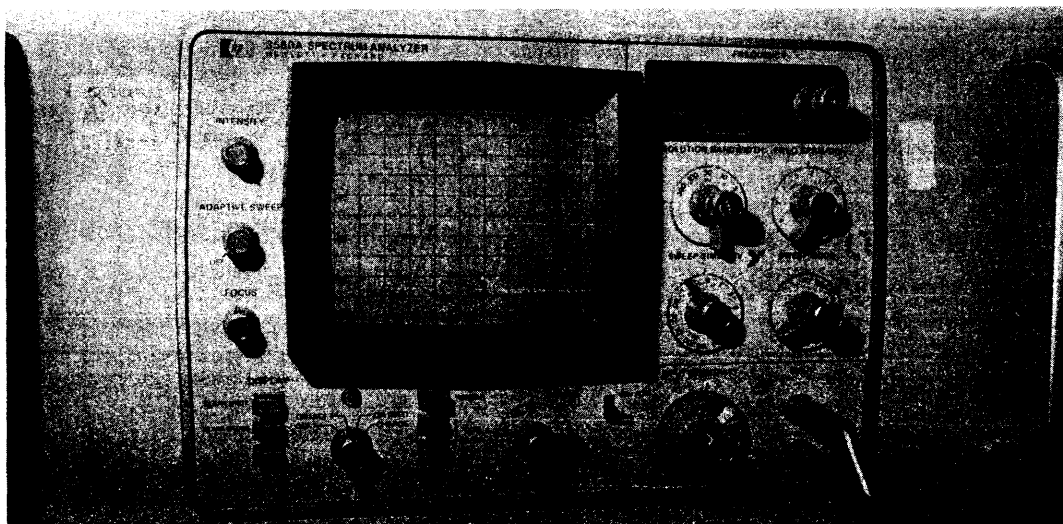

Figure 4-49.—Typical spectrum analyzer.

317.41

Three axes of degree (amplitude, time, and frequency) are important when considering varying frequency. The time-domain (amplitude-versus-time) plot is used to consider phase relationships and basic timing of the signal and is normally observed with an oscilloscope. The frequency-domain (amplitude-versus-frequency) plot is used to observe frequency response. The spectrum analyzer is used for this purpose.

The frequency domain contains information not found in the time domain. The spectrum analyzer can display signals composed of more than one frequency (complex signals). It can also discriminate between components of the

signal and measure the power level at each one. It is more sensitive to low-level distortion than an oscilloscope. Its sensitivity and wide, dynamic range are also useful for measuring low-level modulation, as illustrated in views A and B of figure 4-50.

DIGITAL DATA DISTORTION TEST SET

These test sets usually consist of a digital data signal generator and a digital data analyzing system. There are various types of test sets used within the NAVSECGRU or SPINTCOMM TCFs. Each unit (Test Set,

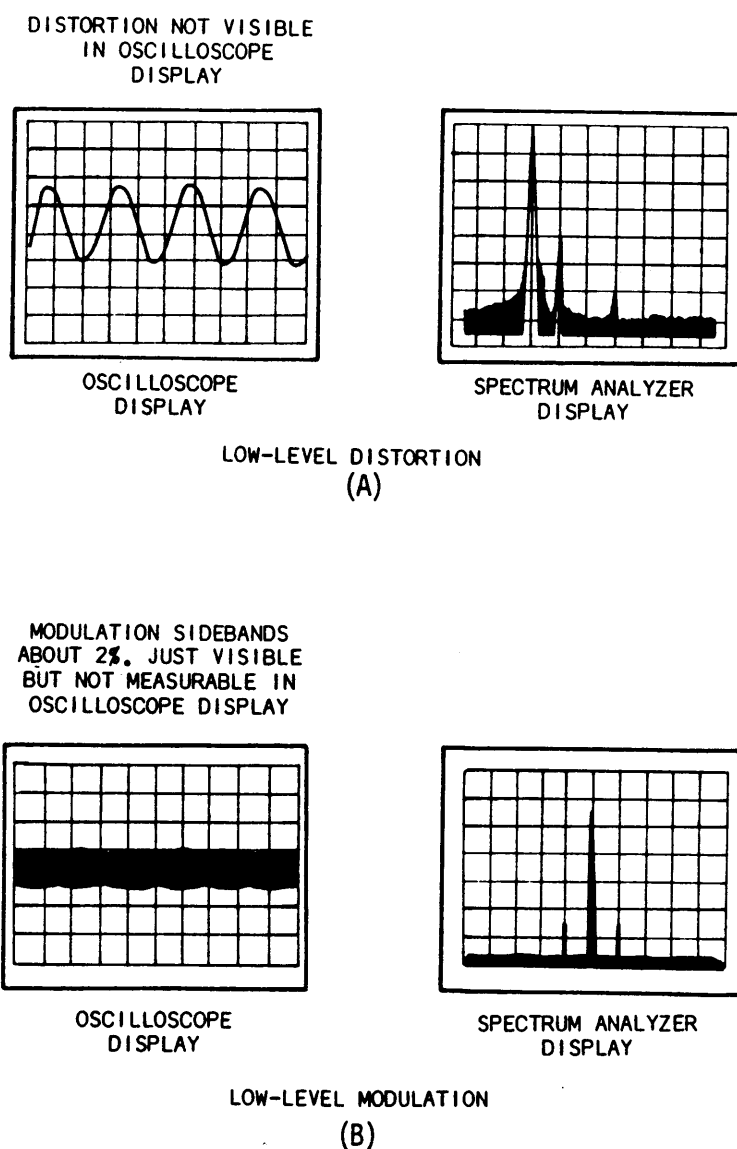

Figure 4-50.—Examples of time-domain (left) and frequency-domain (right) low-level signals.

USM-329, shown in figure 4-51; Test Set, DTS-531, shown in figure 4-52; or Test Set, DIGITECH 2002-02, shown in figure 4-53) is self-contained and is independently operable for use in troubleshooting digital circuits.

For reference, a description of all controls and indicators normally used during operation of the DIGITECH 2002-02 are contained in appendix III.

REFERENCES

Telecommunications Engineering Digital Communications, NAVELEX 0967-LP-625-4010,

Department of the Navy, Washington, DC, January 1980.

Instruction Manual for Analyzer/Generator 2002-02, NAVSEA ST400-AA-MMA-010/MOD 2088/07, Department of the Navy, Washington, DC, March 1979.

Technical Control Facilities and Equipment for Long-Haul Communications, MIL-HDBK-414, Department of Defense, Washington, DC, March 1981.

System Design and Engineering Standards for Technical Control, MIL-STD-188-310A, Department of Defense, Washington, DC, January 1980.

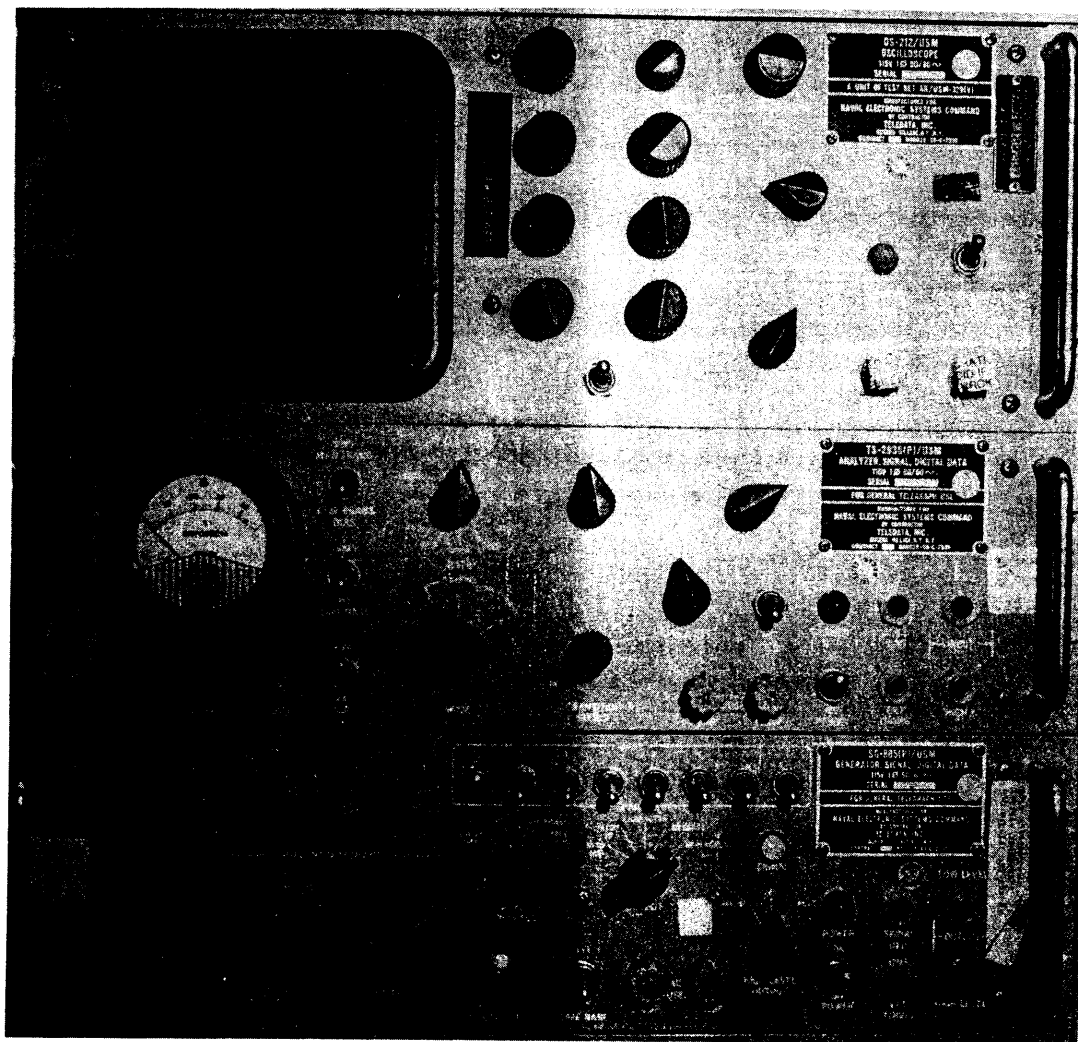

Figure 4-51.—Test Set, USM-329.

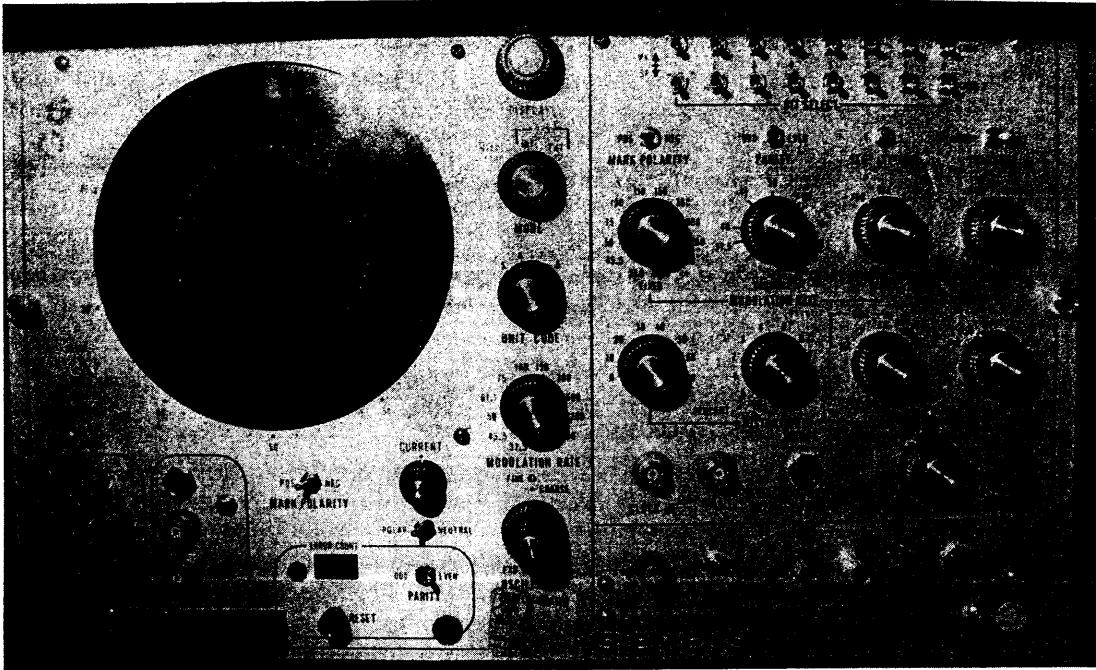

Figure 4-52.—Test Set, DTS-531.

317.43

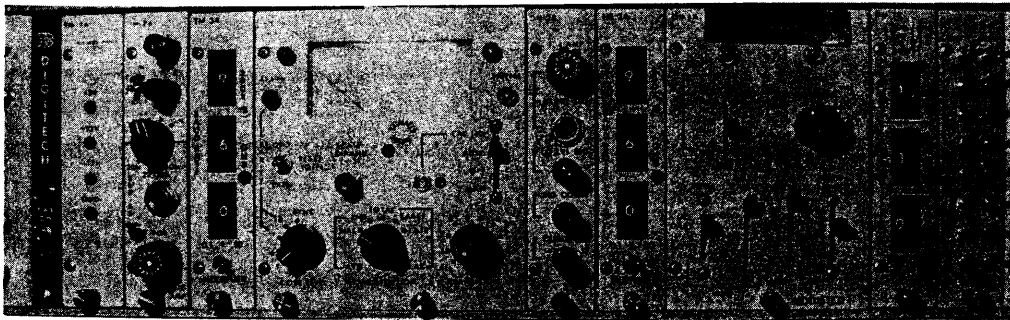

Figure 4-53.—Test Set, DIGITECH 2002-02.

317.44

Technical Control Equipment and Miscellaneous Units, NAVELEX 0967-LP-385-9010, Department of the Navy, Washington, DC, September 1970.

Low-level Technical Control Equipment, NAVELEX 0967-LP-391-6010, Department of the Navy, Washington, DC, March 1971.

Security Group Technical Control Equipment, EE180-CA-OMI-010/G201 SGTCE, Department of the Navy, Washington, DC, October 1983.

Test Methods and Practices, NAVEDTRA B72-21-00-87, Naval Education and Training Program Management Support Activity, Pensacola, FL, February 1987.

The Technician's Handbook, NAVEDTRA 172-19-00-85, Naval Education and Training Program Management Support Activity, Pensacola, FL, 1985.

Introduction to Test Equipment, NAVEDTRA 172-16-00-84, Naval Education and Training Program Development Center, Pensacola, FL, 1984.