

APPENDIX I

ENCODING OF DIGITAL DATA

INTRODUCTION

This appendix discusses the basic definitions of computer codes, data transmission formats, control characters, and encryption of digital data.

characters and binary computer numbers are classified as *digital data*, which is defined as "a nominally discontinuous electrical signal that changes from one state to another in discrete steps."

BASIC DEFINITIONS

The Institute of Electrical and Electronics Engineers (IEEE) defines coding as "a plan for representing each of a finite number of values or symbols as a particular arrangement or sequence of discrete conditions or events." The letters, numbers, punctuation marks, and other symbols (commonly referred to as *characters*) of a Teletypewriter (TTY) keyboard comprise a finite set of symbols. See figure AI-1. Each can be represented by a particular arrangement or sequence of discrete conditions or events. The same is true of the binary numbers that form the basis for the operation of most computers. Consequently, both TTY

BINARY CODING

A single bit, or binary digit, can assume one of two possible conditions. Since each possibility can be made to represent a different character, a single bit has a coding capacity of two characters. (For simplicity, the figure uses the notation of 0s and 1s to indicate the two possible conditions of a bit.) Two bits afford four possibilities. Each of the two possibilities of 1 bit can be combined with each of the two possibilities of the other bit. Thus, 2 bits have a coding capacity of four characters; similarly, 3 bits have a capacity of eight characters.

The number of possibilities—and, therefore, the coding capacity—afforded by a bit sequence

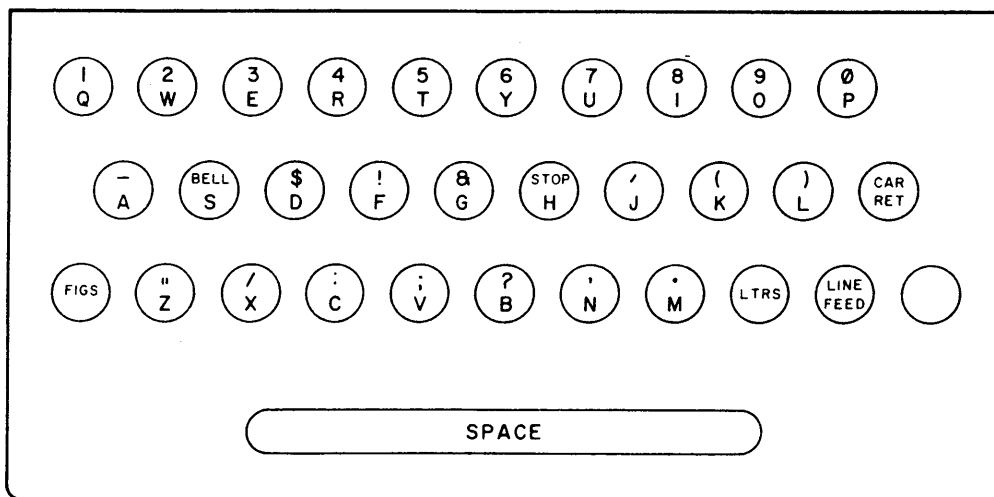

Figure AI-1.—Typical teletypewriter keyboard arrangement.

increases exponentially with the number of bits in the sequence. See figure AI-2.

M-ARY CODING

A single digit can convey more than two possibilities if it is made to assume any one of more than two states. A sequence of three 4-state digits would have a 64-character capacity, compared to the 8-character capacity of 3 digits. Coding with *M* number of states is referred to as *M-ary coding*. Noise present in all communications channels sets a practical limit on the number of states that can be applied in coding.

TELETYPEWRITER (TTY) CODES

Codes for TTY message communications are usually 5-bit codes. The two states of a bit are *space* and *mark*. Many TTY machines operate on a "start-stop" basis; that is, each character is preceded by a start bit (a space), and followed by a stop bit (a mark). The start and stop bits synchronize the TTY machines on both ends of

the circuit. Thus, each TTY character in this mode uses seven bits.

To accommodate the 26 letters of the English alphabet, the numbers 0 through 9, punctuation marks, various symbols, and escape characters are used. Two of the possible code sequences are assigned to these characters. The escape characters provide the equivalent of the shift key on a typewriter, which shifts from lower case to upper case, or vice versa. In TTY usage, all code sequences following the letters case escape character represent letters, and those following the figures case escape character represent numerals or symbols. The figures case has enabled the formulation of specialized alphabets for military, Teletypewriter Exchange (TWX), Telex, weather, and other communications services. Figure AI-3 illustrates the 5-bit TTY code as applied to certain specialized services. The letters case is the same in all the alphabets. When combined with the figures case for International Telegraph Alphabet (ITA) No. 2, it becomes the complete ITA No. 2 code recommended for international use by the International Telephone and Telegraph Consultative Committee (CCITT).

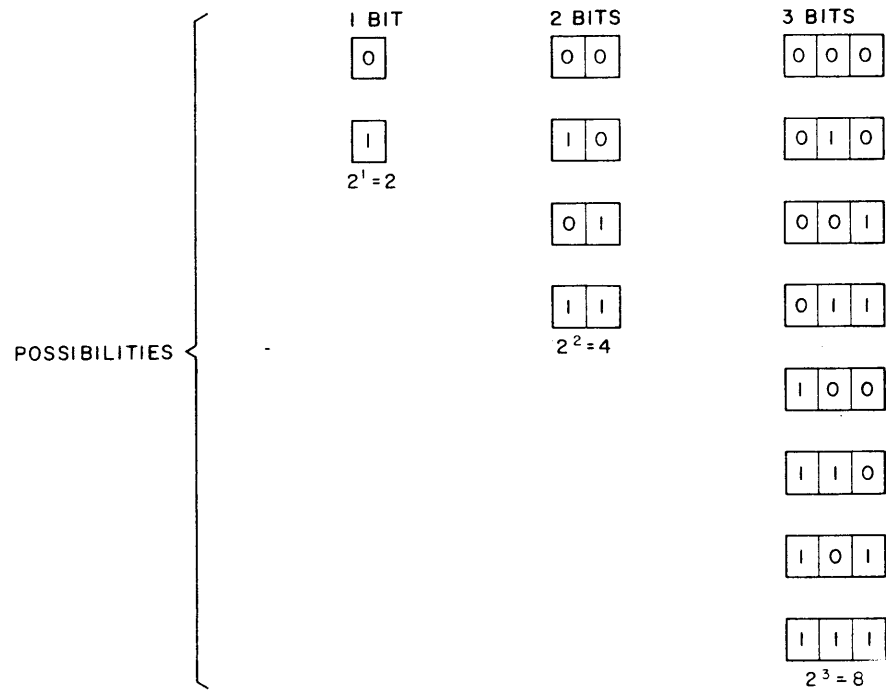

GENERAL RULE: NUMBER OF POSSIBILITIES = 2^n
 WHERE *n* IS THE NUMBER OF BITS

Figure AI-2.—Coding capacity of bit series.

COMPUTER COMMUNICATIONS CODES

Most computer input and output devices operate on continuous alphanumeric series. They

are not equipped to handle the escape characters for shifting letters and figures that augment the capacity of the 5-bit TTY codes. Consequently, a separate code sequence is required for each different computer data character. For binary

WRU - WHO ARE YOU ?

NAI - NOT ALLOCATED INTERNATIONALLY

MARK
SPACE

LETTERS CASE	CHARACTERS				START	CODE SEQUENCES					STOP
	FIGURES		CASE			BIT POSITION					
	ITA NO. 2 TELEEX	TWX	AT&T	WEATHER		1	2	3	4	5	
A	-	-	-	↑							
B	?	?	5/8	⊙							
C	:	:	1/8	○							
D	WRU	S	S	↗							
E	3	3	3	3							
F	NAI		1/4	→							
G	NAI	&	&	↘							
H	NAI	#		↓							
I	8	8	8	8							
J	BELL	BELL	,	↙							
K	((1/2	←							
L))	3/4	↖							
M							
N	,	,	7/8	⊕							
O	9	9	9	9							
P	0	0	0	∅							
Q	1	1	1	1							
R	4	4	4	4							
S	,	,	BELL	BELL							
T	5	5	5	5							
U	7	7	7	7							
V	=	;	3/8	0							
W	2	2	2	2							
X	1	1	1	1							
Y	6	6	6	6							
Z	+	"	"	+							
BLANK				-							
LETTERS SHIFT											
FIGURES SHIFT											
SPACE											
CARRIAGE RETURN											
LINE FEED											

Figure AI-3.—Five-bit TTY codes used in the United States.

DECIMAL DIGIT	BCD
0	0000
1	0001
2	0010
3	0011
4	0100
5	0101
6	0110
7	0111
8	1000
9	1001

Figure AI-4.—BCD notation.

DECIMAL DIGIT	EXCESS-3 BCD
0	0011
1	0100
2	0101
3	0110
4	0111
5	1000
6	1001
7	1010
8	1011
9	1100

Figure AI-5.—Excess-3 BCD code.

coding (the type most commonly used in computer applications), this means that a code sequence must have more than 5 bits simply to represent the letters of the alphabet and the numbers 0 through 9. Add to this the characters for punctuation, symbols, and control functions, and the need for higher capacity codes becomes evident.

Binary Coded Decimal (BCD) Notation

The basis for certain higher capacity codes is BCD notation. In this notation, each decimal number is represented by a group of four bits. See figure AI-4.

Excess-3 BCD Code

In a transmission based on straight BCD notation, there would be no distinction between the code for zero (0000) and the absence of signal. See figure AI-4. To avoid confusion

of the two, excess-3 BCD code uses the binary notation for three to represent zero. Each of the other nine numbers is represented by the binary equivalent of the number plus three, shown in figure AI-5.

Six-Bit Code

The BCD and excess-3 codes have a coding capacity of 16 characters. Therefore, they are adequate to handle numerical data. But, they cannot handle 10 numbers plus the 26 letters of the alphabet (or 36 characters in all); neither can a 5-bit code, since it provides only 32 characters. A 6-bit code is needed, even though it provides 64 characters—more than are actually needed. A 6-bit code can be formulated by using the BCD notation and applying a technique known as *zone-bit coding*. In this technique, the basic 16-character BCD set is repeated four times. Each time, it is combined with a different set of two bits, known as *zone bits*, that precede each 4-bit BCD sequence to form 6-bit sequences. See figure AI-6.

Extended Binary Coded Decimal Interchange Code (EBCDIC)

Although the 64 characters provided by the 6-bit code are adequate to represent all letters and numbers (plus punctuation,

symbols, and control characters) they can represent the letters in only the upper case. To provide for both upper and lower cases, EBCDIC applies 4 zone bits to the basic BCD set. This results in 8-bit sequences, giving a coding capacity of 256 characters. EBCDIC is illustrated

ZONE	CHARACTER	CODE	ZONE	CHARACTER	CODE
00	A	000001	10	5	100000
	B	000010		6	100001
	C	000011		7	100010
	D	000100		8	100011
	E	000101		9	100100
	F	000110		+	100101
	G	000111		-	100110
	H	001000		*	100111
	I	001001		/	101000
	J	001010		(101001
	K	001011)	101010
	L	001100		\$	101011
	M	001101		=	101100
	N	001110		BLANK	101101
	O	001111		,	101110
				.	101111
01	P	010000	11	#	110000
	Q	010001		[110001
	R	010010]	110010
	S	010011		%	110011
	T	010100		=	110100
	U	010101		—	110101
	V	010110		!	110110
	W	010111		&	110111
	X	011000		-	111000
	Y	011001		?	111001
	Z	011010		<	111010
	0	011011		>	111011
	1	011100		@ or ≤	111100
	2	011101		\ or ≥	111101
	3	011110		^	111110
	4	011111		;	111111

Figure AI-6.—Typical 6-bit BCD code.

in figure AI-7. Note that it includes a number of control characters.

American Standard Code for Information Interchange (ASCII)

ASCII is the latest effort of the common carriers and computer communications industry

in the United States to produce a universal common language code. It has been adopted by the American National Standards Institute (ANSI) and is currently the standard code for computer communications. Although individual computers use different internal codes for word storage and character displays, ASCII is the most widely used.

BIT LEVELS 4567	0 → 0 1 → 0 2 → 0 3 → 0	0 0 0 1	0 0 1 0	0 0 1 1	0 1 0 0	0 1 0 1	0 1 1 0	0 1 1 1
0000	NUL		DS		SP	&	-	
0001			SOS				/	
0010		TM	FS					
0011								
0100	PF	RES	BYP	PN				
0101	HT	NL	LF	RS				
0110	LC	BS	EOB	UC				
0111	DEL	IDL	PRE	EOT				
1000	EOM							
1001								
1010		CC	SM		¢	!		:
1011					.	\$,	#
1100					<	*	%	@
1101					()	>	'
1110					+	;	~	=
1111						(NOT)	?	"
BIT LEVELS 4567	0 → 1 1 → 0 2 → 0 3 → 0	1 0 0 1	1 0 1 0	1 0 1 1	1 1 0 0	1 1 0 1	1 1 1 0	1 1 1 1
0000		a	j		A	J		0
0001		b	k	s	B	K	S	1
0010		c	l	t	C	L	T	2
0011								3
0100		d	m	u	D	M	U	4
0101		e	n	v	E	N	V	5
0110		f	o	w	F	O	W	6
0111		g	p	x	G	P	X	7
1000		h	q	y	H	Q	Y	8
1001		i	r	z	I	R	Z	9
1010								
1011								
1100								
1101								
1110								
1111								

Figure AI-7.—EBCDIC code.

It uses 7 bits, providing 128 possibilities. See figure AI-8.

CCITT No. 5 Code

This is a 7-bit code similar to ASCII. See figure AI-9.

Pseudorandom Coding

Pseudorandom coding generates a long string of code bits that appear to be in random sequence when, in reality, the bit sequence

represents a definite code. It is formed by first assigning a number to each character in accordance with its position in the alphabet or list of characters (for example, a = 1, b = 2, z = 26). Then, a different number, drawn from a series of random numbers, is added to each character number in the message. The resulting series of numbers is transmitted. On reception, the same random numbers that were added before transmission are subtracted from the received series to yield the message numbers. These numbers are then converted back into alphabet characters.

BIT NUMBERS							0	0	0	0	1	1	1	1	
b7	b6	b5	b4	b3	b2	b1	COL	0	1	2	3	4	5	6	7
							ROW	0	1	2	3	4	5	6	7
			0	0	0	0	0	NUL	DLE	SP	0	@	P	\	p
			0	0	0	1	1	SCH	DC1	!	1	A	Q	a	q
			0	0	1	0	2	STX	DC2	"	2	B	R	b	r
			0	0	1	1	3	ETX	DC3	#	3	C	S	c	s
			0	1	0	0	4	EOT	DC4	\$	4	D	T	d	t
			0	1	0	1	5	ENQ	NAK	%	5	E	U	e	u
			0	1	1	0	6	ACK	SYN	&	6	F	V	f	v
			0	1	1	1	7	BEL	ETB	'	7	G	W	g	w
			1	0	0	0	8	BS	CAN	(8	H	X	h	x
			1	0	0	1	9	HT	EM)	9	I	Y	i	y
			1	0	1	0	10	LF	SUB	*	:	J	Z	j	z
			1	0	1	1	11	VT	ESC	+	;	K	[k	{
			1	1	0	0	12	FF	FS	,	<	L	\	l	
			1	1	0	1	13	CR	GS	-	=	M]	m	}
			1	1	1	0	14	SO	RS	.	>	N	^	n	~
			1	1	1	1	15	SI	US	/	?	O	_	o	DEL

Figure AI-8.—ASCII code.

BIT NUMBERS								0	0	0	0	1	1	1	1
b7	b6	b5	b4	b3	b2	b1	COL	0	1	2	3	4	5	6	7
							ROW	0	1	2	3	4	5	6	7
			0	0	0	0	0	NUL	TC7	SP	0	@	P	`	p
			0	0	0	1	1	TC1	DC1	!	1	A	Q	a	q
			0	0	1	0	2	TC2	DC2	"	2	B	R	b	r
			0	0	1	1	3	TC3	DC3	#	3	C	S	c	s
			0	1	0	0	4	TC4	DC4	⌘	4	D	T	d	t
			0	1	0	1	5	TC5	TC8	%	5	E	U	e	u
			0	1	1	0	6	TC6	TC9	&	6	F	V	f	v
			0	1	1	1	7	BEL	TC10	'	7	G	W	g	w
			1	0	0	0	8	FE0	CAN	(8	H	X	h	x
			1	0	0	1	9	FE1	EM)	9	I	Y	i	y
			1	0	1	0	10	FE2	SUB	*	:	J	Z	j	z
			1	0	1	1	11	FE3	ESC	+	;	K	[k	{
			1	1	0	0	12	FE4	IS4	,	<	L	\	l	
			1	1	0	1	13	FE5	IS3	-	=	M]	m	}
			1	1	1	0	14	SO	IS2	.	>	N	^	n	~
			1	1	1	1	15	SI	IS1	/	?	0	_	o	DEL

Figure AI-9.—CCITT No. 5 code.

From the point of view of secure communications, the code has a drawback in that the series of random numbers must be somehow conveyed to the receiving end for decoding. This poses the possibility of interception. To prevent interception, the terminals of a secure system use a formula; however, they are not truly random numbers and are referred to as *pseudorandom*.

A pseudorandom code can be broken. Therefore, it is normally used with other means, such as changing formulas at prearranged times,

replacing message words with other words, replacing characters with other characters, and scrambling the characters.

Hamming Codes

Hamming codes are error detection and correction codes. They operate by adding bits, known as *parity check bits*, to the digital message. These bits form odd or even patterns of 0s or 1s before transmission. Odd or even patterns, whichever have been assigned on transmission,

must then be recognized on reception to indicate error-free transmission.

DATA TRANSMISSION FORMATS

Computers, computer terminals, teletype-writers, and certain switching systems operate on information in bit form. For the equipment to perform the required operations at the right times, however, control information must be sent along with the message. This information cannot simply be interspersed at random with the message bits. It must be transmitted at prescribed intervals. For this reason, transmissions are divided into units that are then framed by the control information. These units may be characters, blocks, or messages, depending on the type of transmission and control information being transmitted.

Characters

Many TTY machines are designed for start-stop operation, in which each character is preceded by a start bit (space) and followed by a stop bit (mark). This synchronizes the TTY machines at both ends of the circuit, enabling them to correctly interpret the sequences of marks and spaces that represent characters.

Blocks

Digital data can also be divided into blocks of characters. Block sizes generally follow the format of punched cards, in particular, the IBM 80-column cards. This is the case in AUTODIN. A block has 80 message characters, plus control characters. There are usually 4 control characters, giving a block length of 84 characters. The control characters frame the message characters, two before and two after. Blocks may also be of variable length, provided they remain framed by control characters.

Messages

For routing and accounting purposes, digital data transmissions are divided into messages. For

correct routing, each message contains the name and location of the addressee. For accounting and inquiry purposes, it also contains record information, such as the message number and time logged.

Words

Another division of a digital data message has no bearing on formatting. It is used to describe the operating speed of TTY equipment. In TTY service, words are somewhat arbitrarily defined as being six characters long (five characters and a space). TTY speeds are rated in words per minute (wpm).

CONTROL CHARACTERS

Many of the codes shown in this appendix include control characters. The TTY codes, for example, include figures-shift and letters-shift escape characters, carriage return, and line feed characters for carriage control. In addition to these equipment control characters, there is a need for the control of message routing and error detection and correction.

ENCRYPTION OF DIGITAL DATA

When digital messages are encrypted for secure communications, the encryption is done after the messages have been digitally encoded. The process is performed by key generators that operate on the digitally encoded data to convert them to an encrypted form.

Encryption can be either of two types: bulk or end-to-end. In *bulk encryption*, transmissions from a number of communications channels at one terminal are encrypted by a single key generator. In *end-to-end encryption*, each channel is encrypted by its own key generator. A matching key generator at the other end of the channel performs the decryption function. Bulk encryption requires fewer key generators; however, it is less secure, since decryption must take place at network nodes and switching points. In end-to-end encryption, the message remains in encrypted form for its entire transmission route.

APPENDIX II

OSCILLOSCOPE CONTROL COMPONENTS

INTRODUCTION

This appendix discusses the various oscilloscope control components and their functions. It also gives detailed figures representing the components.

OSCILLOSCOPES

Although the Cathode Ray Tube (CRT) is a highly versatile device, it cannot operate without control circuits. The type of control circuits required depends on the purpose of the CRT equipment.

Oscilloscopes vary from relatively simple test instruments to highly accurate laboratory models. Although they have different types of circuits, most of them can be divided into the basic sections shown in figure AII-1:

- a CRT,
- a power supply,

- a sweep circuitry, and
- a deflection circuitry.

Figure AII-2 is a drawing of the front panel of a dual-trace, general-purpose oscilloscope. Oscilloscopes vary greatly in the number of controls and connectors. Usually, the more controls and connectors, the more versatile the instrument. Regardless of the number, all oscilloscopes have similar controls and connectors. Once you learn the fundamental operation of these common controls, you can move with relative ease from one model of oscilloscope to another. Occasionally, controls that serve similar functions will be differently labeled from one model to another. However, you will find that most controls are logically grouped and that their names usually indicate their function.

DUAL-TRACE OSCILLOSCOPE

The dual-trace oscilloscope, shown in figure AII-2, accepts and displays two vertical signal inputs at the same time—usually for comparison of the two signals or of one signal and a

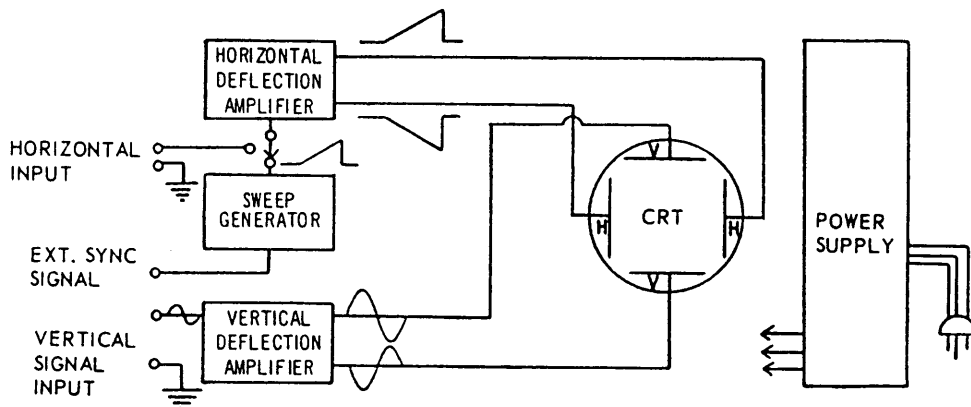
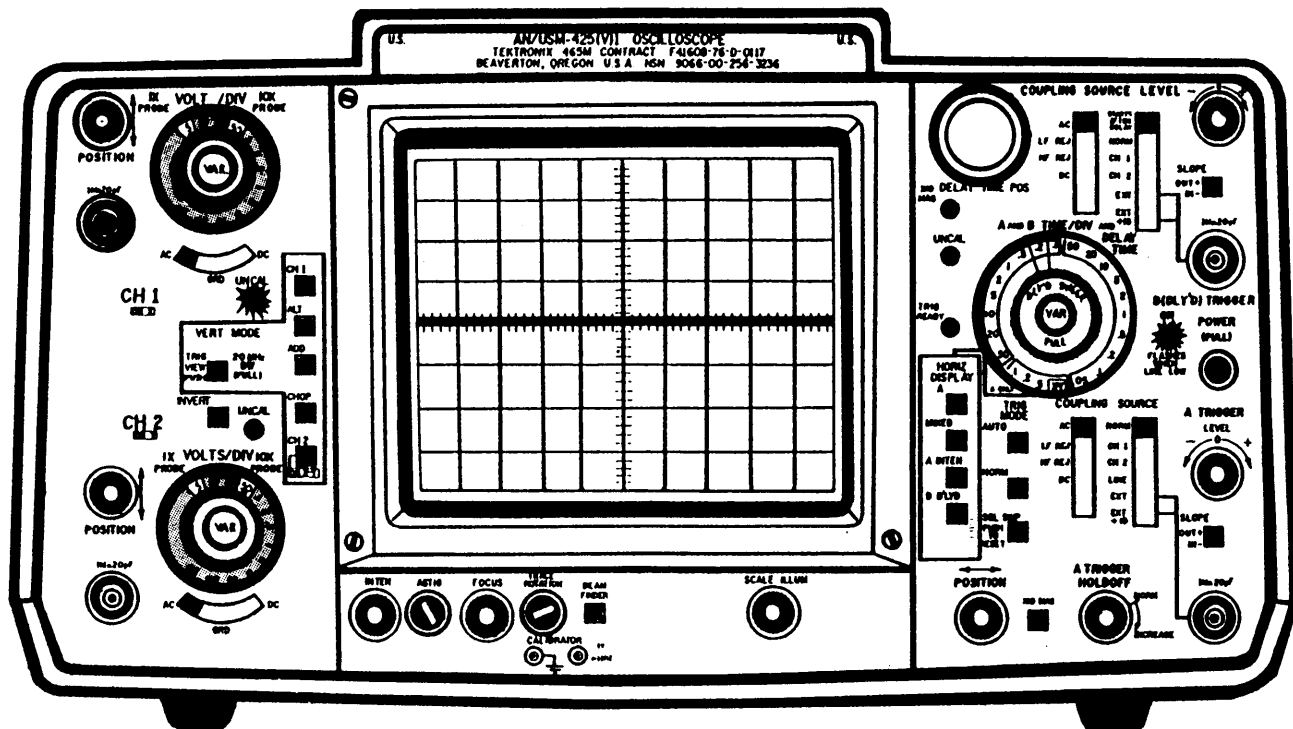
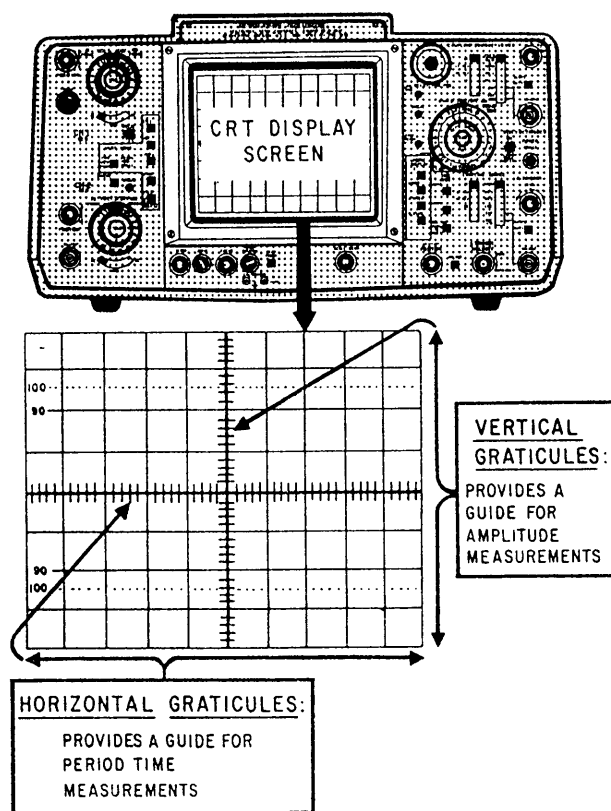

Figure AII-1.—Block diagram of an oscilloscope.



289.36

Figure AII-2.—Dual-trace oscilloscope.



289.37

Figure AII-3.—CRT display and graticule.

reference signal. In this case it is used as a *single-trace oscilloscope*. The oscilloscope in the figure is the Model AN/USM-425. You may use this model or one very similar to it. Let's look at the front panel controls first.

Components Used to Display the Waveform

The CRT display screen displays the signal. See figure AII-3. It allows you to make accurate measurements by using the vertical and horizontal graticules.

Components Used to Adjust the CRT Display Quality

The controls shown in figure AII-4 allow you to adjust for a clear signal display. They also allow you to adjust the display position and magnify the horizontal trace by a factor of 10 (X10). Each of these controls is explained in the following sections. Don't forget that you will see them called by different names, depending on the manufacturer.

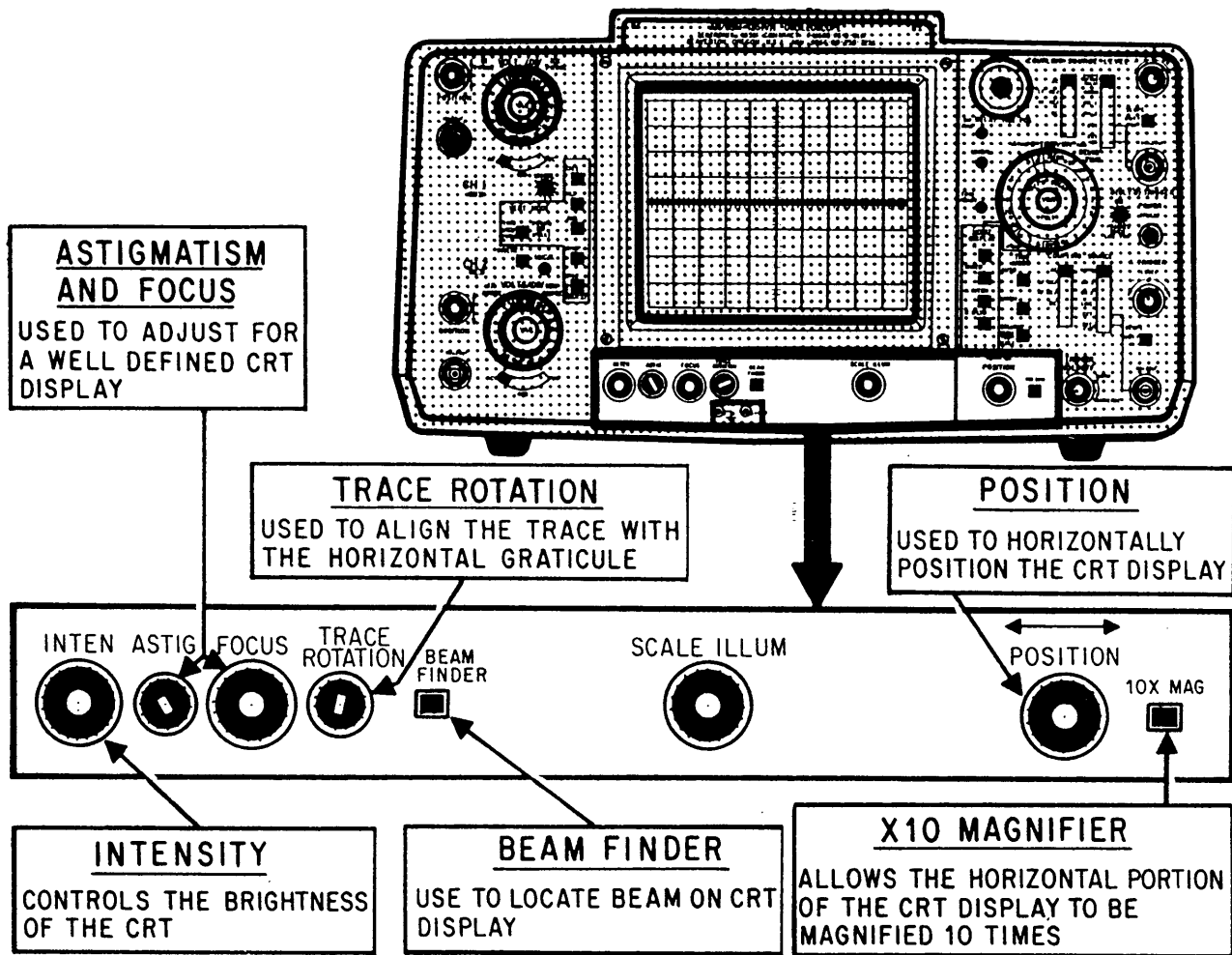

289.38

Figure AII-4.—Quality adjustment for CRT display.

INTENSITY CONTROL.—The INTENSITY control (sometimes called BRIGHTNESS) adjusts the brightness of the beam on the CRT. It is rotated in a clockwise direction to increase the intensity of the beam. You can adjust it to a minimum brightness level that is comfortable for viewing.

FOCUS CONTROL AND ASTIGMATISM CONTROL.—The FOCUS control adjusts the beam size. The ASTIGMATISM control adjusts the beam shape. These two controls are adjusted together to produce a small, clearly defined circular dot. When you display a line trace, these same controls produce a well-defined line. View A of figure AII-5 shows an out-of-focus beam dot. View B shows the beam in focus. Views C and D show out-of-focus and in-focus traces, respectively.

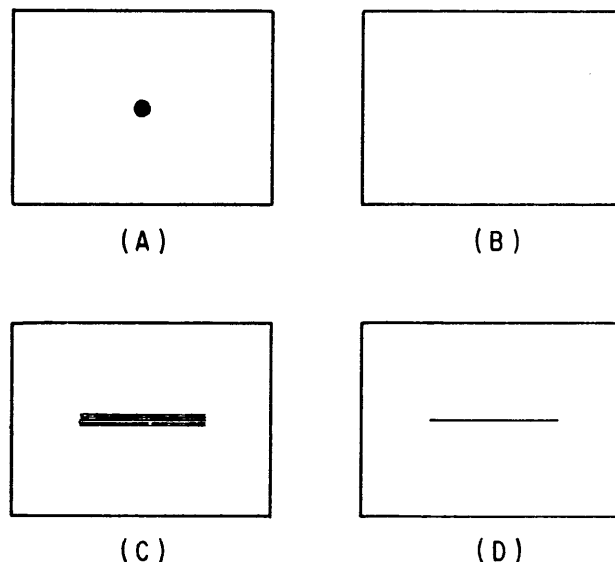

Figure AII-5.—Effects of focus and astigmatism controls.

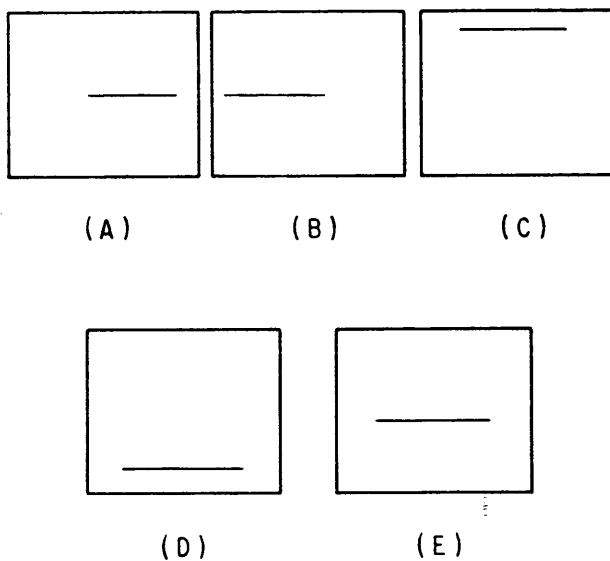

Figure AII-6.—Effects of horizontal and vertical positioning controls.

TRACE ROTATION CONTROL.—The TRACE ROTATION control, shown in figure AII-4, allows for minor adjustments of the horizontal portion of the trace. You can align it with the horizontal lines on the graticule.

BEAM FINDER.—Occasionally, the trace will actually be located off the CRT (up or down, to the left, or to the right) because of the orientation of the deflection plates. When pushed, the BEAM FINDER pulls the beam onto the screen so that you can use the horizontal and vertical positioning controls to center the spot. See figure AII-4.

HORIZONTAL AND VERTICAL POSITION CONTROLS.—The horizontal and vertical POSITION controls, shown in figure AII-4, are used to position the trace. Because the graticule is often drawn to represent a graph, some oscilloscopes have the positioning controls labeled to correspond to the X and Y axes of the graph. The X axis represents horizontal movement; the Y axis represents vertical movement.

Figure AII-6 shows the effects of positioning controls on the trace. In view A, the horizontal control has been adjusted to move the trace too far to the right. In view B, the trace has been moved too far to the left. In view C, the vertical positioning control has been adjusted to move the trace too close to the top. In view D, the trace has been moved too close to the bottom. View E shows the trace properly positioned.

X10 MAGNIFIER.—The X10 MAGNIFIER switch magnifies the displayed signal by a factor of ten in the horizontal direction. See figure AII-4. This ability is important when you need to expand the signal to evaluate it carefully.

Components Used to Determine the Amplitude of a Signal

The components in this section of the scope are used to determine the signal amplitude. Notice in figure AII-7 that the section at the upper left of the scope looks just the same as the section at the lower left of the scope. This reveals the dual-trace capability section of the scope. The upper left section is the CHANNEL 1 input. It is the same as the CHANNEL 2 input at the lower left. An input to both inputs at the same time will produce two independent traces on the CRT and will use the dual-trace capability of the scope.

For the purpose of this introductory discussion, we will present only CHANNEL 1. You should realize that the information presented also applies to CHANNEL 2.

POSITION CONTROL.—The vertical POSITION control allows you to move the beam position up or down, as discussed earlier.

INPUT CONNECTOR.—The vertical INPUT (or SIGNAL INPUT) jack connects the signal to be examined to the vertical deflection amplifiers. Some oscilloscopes may have two input jacks, one labeled AC and the other labeled DC. Other models may have a single input jack with an associated switch, such as the AC-GND-DC switch shown in figure AII-7. This switch is used to select the AC or DC connection. In the DC position, the signal is connected directly to the vertical deflection amplifier; in the AC position, the signal is first fed through a capacitor. Figure AII-8 shows the schematic of one arrangement.

VERTICAL DEFLECTION AMPLIFIER.—The vertical DEFLECTION AMPLIFIER increases the amplitude of the input signal level required for the deflection of the CRT beam. The deflection amplifier must not have any other effect on the signal, such as changing the shape (called *distortion*). Figure AII-9 shows the results of distortion occurring in a deflection amplifier.

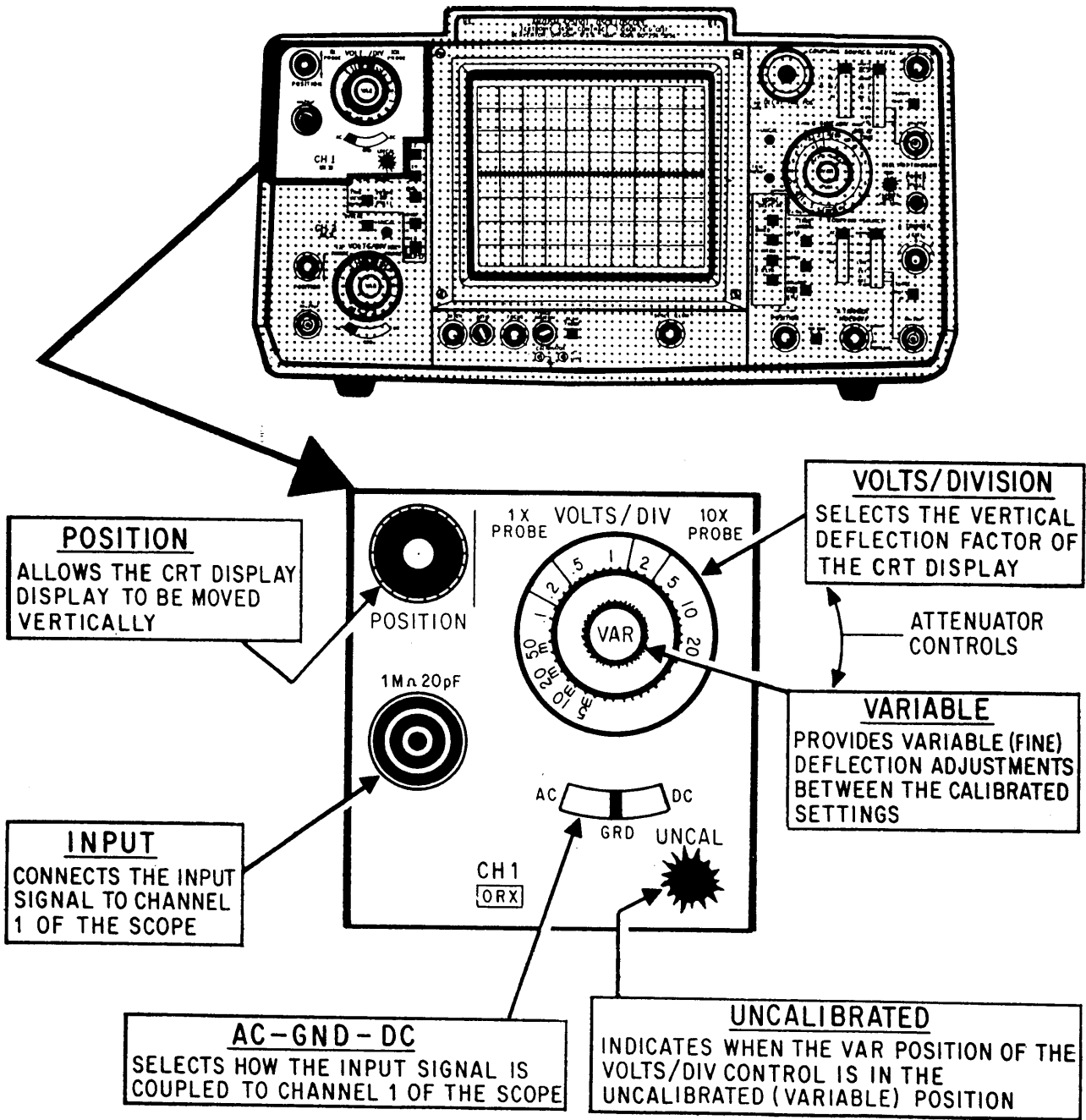

Figure AII-7.—Components that determine amplitude.

289.39

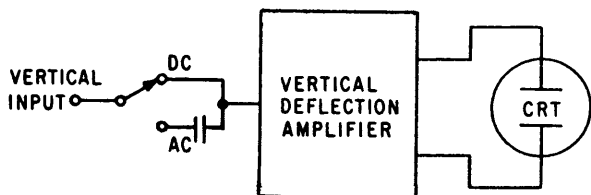

Figure AII-8.—Vertical input arrangement.

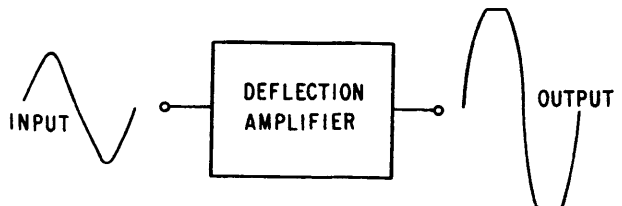

Figure AII-9.—Deflection amplifier distortion.

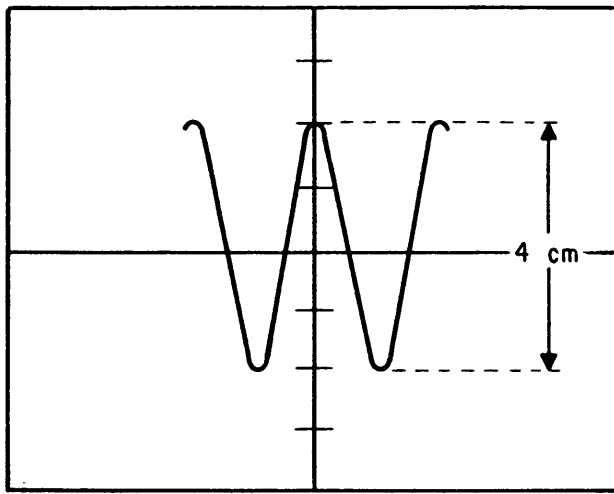

Figure AII-10.—Sine wave attenuation.

ATTENUATOR CONTROL.—An amplifier can handle only a limited range of input amplitudes before it begins to distort the signal. Signal distortion is prevented in oscilloscopes by the incorporation of circuitry that permits adjustment of the input signal amplitude to a level that prevents distortion from occurring. This adjustment is called the ATTENUATOR control in some scopes (VOLTS/DIV and VAR in figure AII-7). These controls extend the usefulness of the oscilloscope by enabling it to handle a wide range of signal amplitudes.

The attenuator usually has two controls: a multiposition (VOLT/DIV) switch, and a variable potentiometer (VAR). Each switch position may be marked either as to the amount of voltage required to deflect the beam a unit distance, such as VOLT/DIV, or as to the amount of attenuation

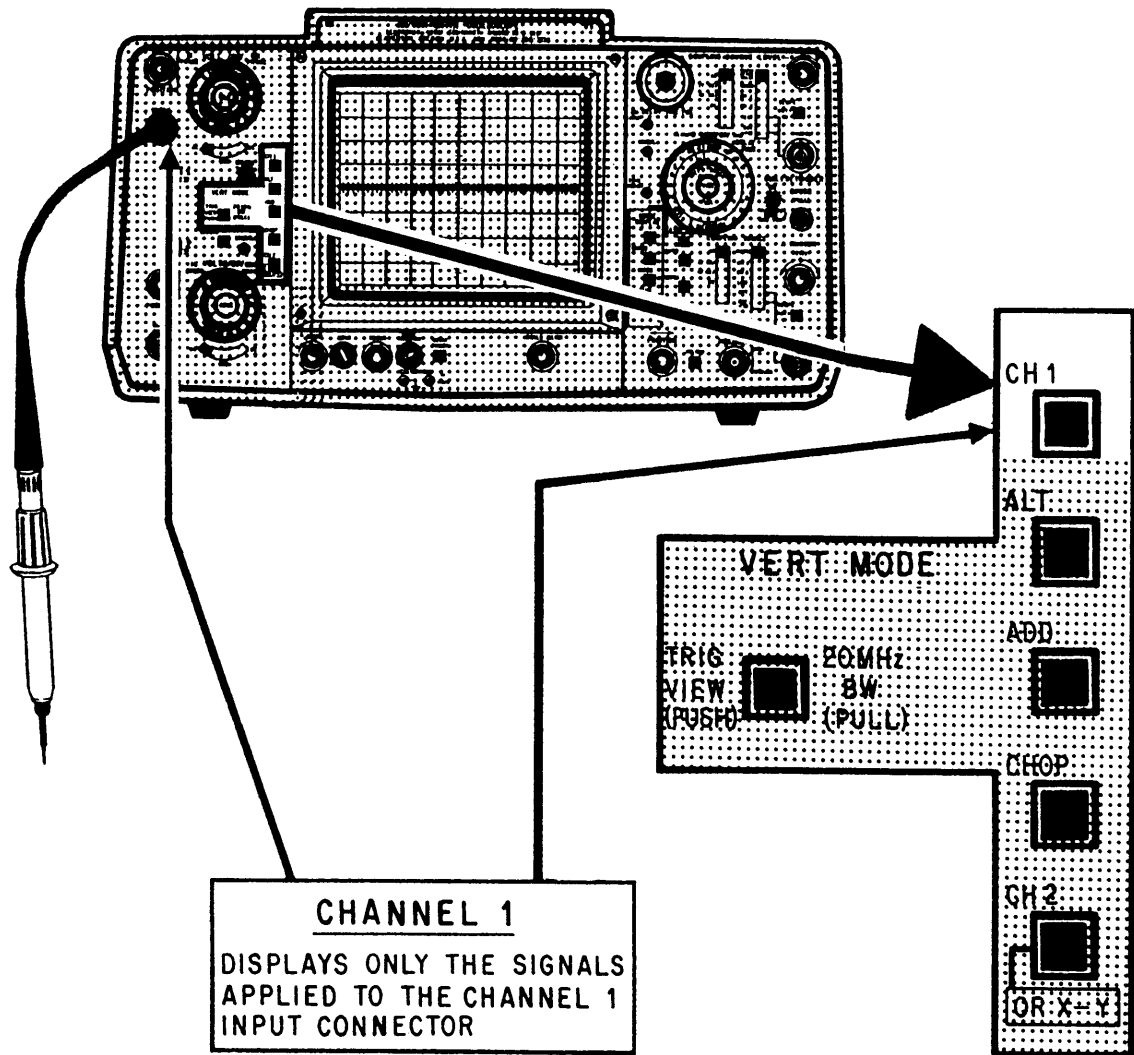

Figure AII-11.—Vertical deflection controls.

(called the *deflection factor*) given to the signal. If a sine wave occupied 4 divisions peak-to-peak, its amplitude would be 2 volts peak-to-peak (4×0.5), as shown in figure AII-10.

The vertical attenuator switch (VOLTS/DIV in figure AII-7) provides a means of adjusting the input signal level to the amplifiers by steps. These steps are sequenced from low to high deflection factors. The potentiometer control (VAR in figure AII-7) provides a means of fine, or variable, control between steps. This control may be mounted separately, or it may be mounted on the attenuator switch. When the control is mounted separately, it is often marked as FINE GAIN or simply GAIN. When mounted on the attenuator switch, it is usually marked VARIABLE or VAR.

The VARIABLE control adds attenuation to the switch step that is selected. Since accurately calibrating a potentiometer is difficult, the VARIABLE control is either left unmarked, or the front panel is marked off by some convenient units, such as 1-10 and 1-100. The attenuator switch, however, can be accurately calibrated. To do this, you turn off the VARIABLE control to remove it from the attenuator circuit. This

position is usually marked CAL (calibrate) on the panel, or an associated light indicates if the VAR control is on or off. In figure AII-7, the light UNCAL indicates the VAR control is in the uncalibrated position.

Components Used to Select the Vertical Operating Mode

As we discussed earlier, CHANNEL 1 is being used to discuss the basic operating procedures for the oscilloscope. Figure AII-11 shows how the vertical mode of operation is selected. The VERT MODE section contains switches that enable you to select CHANNEL 1 or CHANNEL 2, and several other vertical modes of operation. For the present discussion, note only that CHANNEL 1 is selected by these switches.

Components Used to Determine the Period Time of the Display

The TIME/DIV controls on the scope determine the period time of the displayed waveform. See figure AII-12. The sweep generator develops

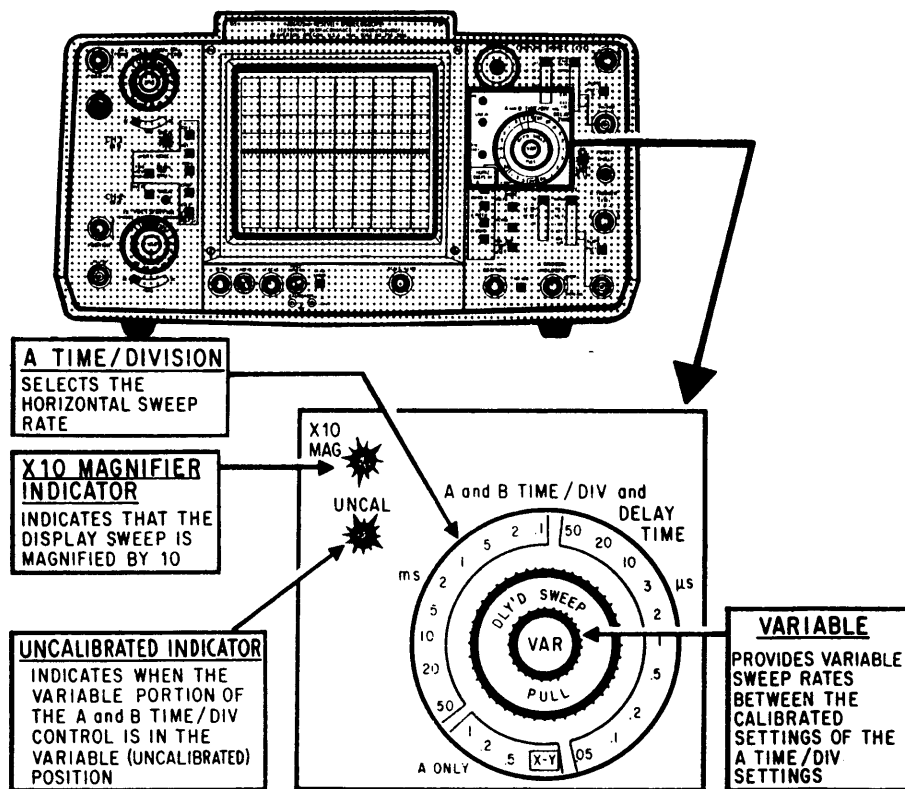

Figure AII-12.—Period time of the waveform.

the sawtooth waveform that is applied to the horizontal deflection plates of the CRT. This sawtooth voltage causes the beam to move across the screen. This trace (sometimes called SWEEP) sets the frequency of the TIME BASE of the oscilloscope. The time base frequency is variable, and enables the oscilloscope to accept a wide range of input frequencies. Again, two controls are used: a multiposition switch (TIME/DIV) that changes the frequency of the sweep generator in steps, and a potentiometer (VAR) that varies the frequency between steps. Each step on the TIME/DIV switch is calibrated. The front panel has markings that group the numbers into microseconds and milliseconds.

The potentiometer is labeled VAR, and the panel has an UNCAL indicator that lights when the VAR control is in the VARIABLE position. When you want to accurately measure the time of one cycle of an input signal, turn the VARIABLE control to the CAL position and turn the TIME/CM switch to select an appropriate time base. Suppose you choose the 0-microsecond position to display two cycles of an input signal, as shown in figure AII-13. One cycle occupies 3 centimeters along the horizontal axis. Each centimeter has a value of 10 microseconds. Therefore, the time for one cycle equals 30 microseconds (3×10). Recall that the frequency for a signal may be found by using the following procedure.

$$f = \frac{1}{\text{time (t)}} = \frac{1}{30 \times 10^{-6}} = 33.33 \text{ kHz}$$

In selecting a time base, select one that is lower in frequency than the input signal. If the input signal requires 5 milliseconds to complete one cycle, and the sawtooth is set for 0.5 milliseconds per centimeter with a 10-centimeter-wide graticule, then approximately one cycle will be displayed. If the time base is set for 1 millisecond per centimeter, approximately two cycles will be displayed. If the time base is set a frequency higher than the input frequency, only a portion of the input signal will be displayed.

In the basic oscilloscope, the sweep generator runs continuously (free-running); in more elaborate oscilloscopes, it is normally turned off. In the oscilloscope we're using as an example, the sweep generator can be triggered by the input

signal or by a signal from some other source. This type of oscilloscope is called a *triggered oscilloscope*. It permits more accurate time measurements to be made and provides a more stable presentation.

On some oscilloscopes, you will find an X10 MAGNIFIER control. As previously mentioned, that is to allow the displayed sweep to be magnified by a factor of 10.

Components Used to Provide a Stable Display

The TRIGGER and LEVEL controls synchronize the sweep generator with the input signal. This provides a stationary waveform display. If the input signal and horizontal sweep generator are unsynchronized, the pattern tends to jitter and observations are difficult.

The A TRIGGER controls at the lower right of the scope control the stability of the oscilloscope CRT display. See figure AII-14. They permit you to select the source, polarity, and amplitude of the trigger signal. These controls are the TRIGGER SOURCE, LEVEL, and SLOPE.

TRIGGER SOURCE.—The TRIGGER SOURCE control allows you to select the

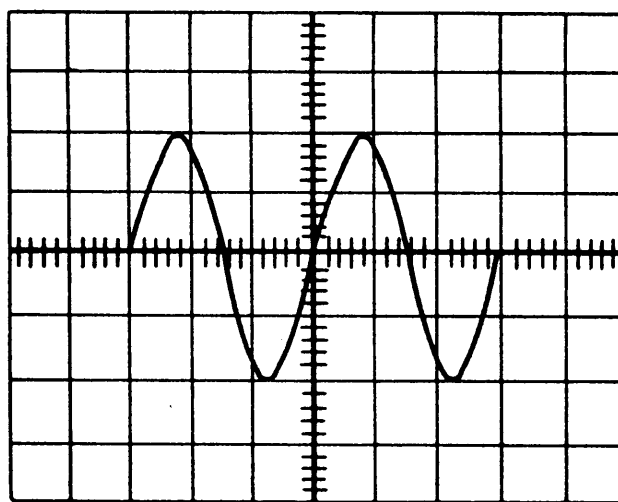

289.42
Figure AII-13.—Time measurement of a waveform (TIME/DIV).

appropriate source of triggering. You can select input signals from channels 1 or 2, the line (60 hertz), or an external input.

TRIGGER LEVEL AND SLOPE CONTROLS.—The TRIGGER LEVEL control allows you to select the amplitude point of the trigger signal at which sweep is triggered. The

TRIGGER SLOPE control lets you select the negative or positive slope of the trigger signal at which the sweep is triggered.

The TRIGGER LEVEL (mounted with the TRIGGER SLOPE on some scopes) determines the voltage level required to trigger the sweep. For example, in the TRIGGER modes, the trigger is obtained from the signal to be displayed. The

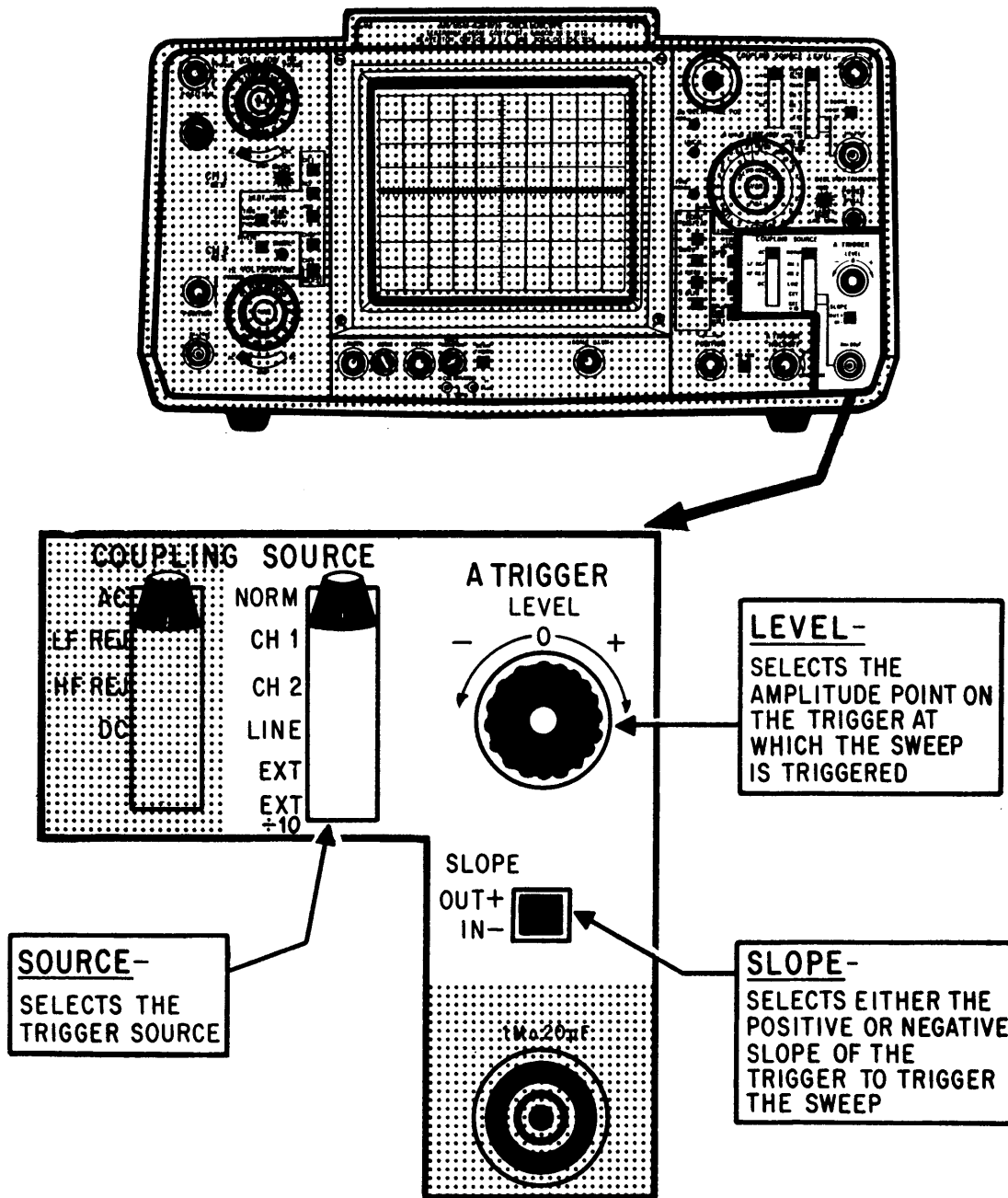

Figure AII-14.—Components that control stability.

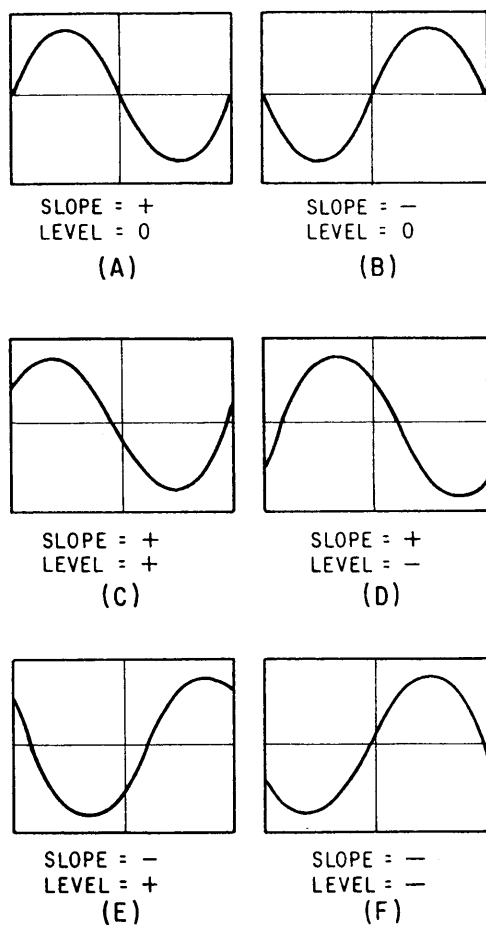

Figure AII-15.—Effects of slope and level trigger controls.

setting of the LEVEL control determines the amplitude point of the input waveform that will be displayed at the start of the sweep.

Figure AII-15 shows some of the displays for a channel that can be obtained for different TRIGGER LEVEL and TRIGGER SLOPE settings. The level is zero and the slope is positive in view A. View B also shows a zero level, but a negative slope selection. View C shows the effects of a positive trigger level setting with a positive trigger slope setting. View D displays a negative trigger level setting with a positive trigger slope setting. Views E and F have negative slope settings. The difference is that E has a positive trigger level setting, while F has a negative trigger level setting.

In most scopes, an automatic function of the trigger circuitry allows a free-running trace without a trigger signal. However, when a trigger signal is applied, the circuit reverts to the triggered mode of operation and the sweep

is no longer free-running. This action provides a trace when no signal is applied.

Synchronization is also used to cause a free-running condition without a trigger signal. Synchronization is not the same as triggering. *Triggering* refers to a specific action or event that initiates an operation. Without this event, the operation would not occur. In the case of the triggered sweep, the sweep will not be started until a trigger is applied. Each succeeding sweep must have a trigger before a sweep commences. *Synchronization*, however, means that an operation or event is brought into step with a second operation. A sweep circuit that uses synchronization instead of triggering will cause a previously free-running sweep to be locked in step with the synchronizing signal. The trigger level control setting can be increased until synchronization occurs. But, until that time, an unstable pattern will appear on the CRT face.

COMPONENTS USED TO SELECT SCOPE TRIGGERING

The TRIG MODE section in figure AII-16 allows for automatic triggering or normal triggering. In automatic (AUTO), the triggering will be free-running in the absence of a proper trigger input, or it will trigger on the input signal at frequencies above 20 hertz. In normal (NORM), the vertical channel input will trigger the sweep.

SIMILARITIES AMONG OSCILLOSCOPES

The oscilloscope you use may differ in some respects from the one just covered. Controls and circuits may be identified by different titles. Many of the circuits will be designed differently. However, all of the functions will be fundamentally the same. Before using an oscilloscope, you should carefully study the operator's manual that comes with it.

GETTING A PATTERN ON THE SCREEN

When adjusting a pattern onto the screen, adjust the INTENSITY and FOCUS controls for a bright, sharp line. If other control settings are such that a dot instead of a line appears, turn down the intensity to prevent burning a

hole in the screen coating. Because of the different speeds at which the beam travels across the screen, brightness and sharpness will vary at various frequency settings. For this reason, you may have to adjust the INTENSITY and FOCUS controls occasionally while taking readings.

NUMBER OF CYCLES ON THE SCREEN

Because distortion may exist at the beginning and the end of a sweep, it is better to place two or three cycles of the waveform on the

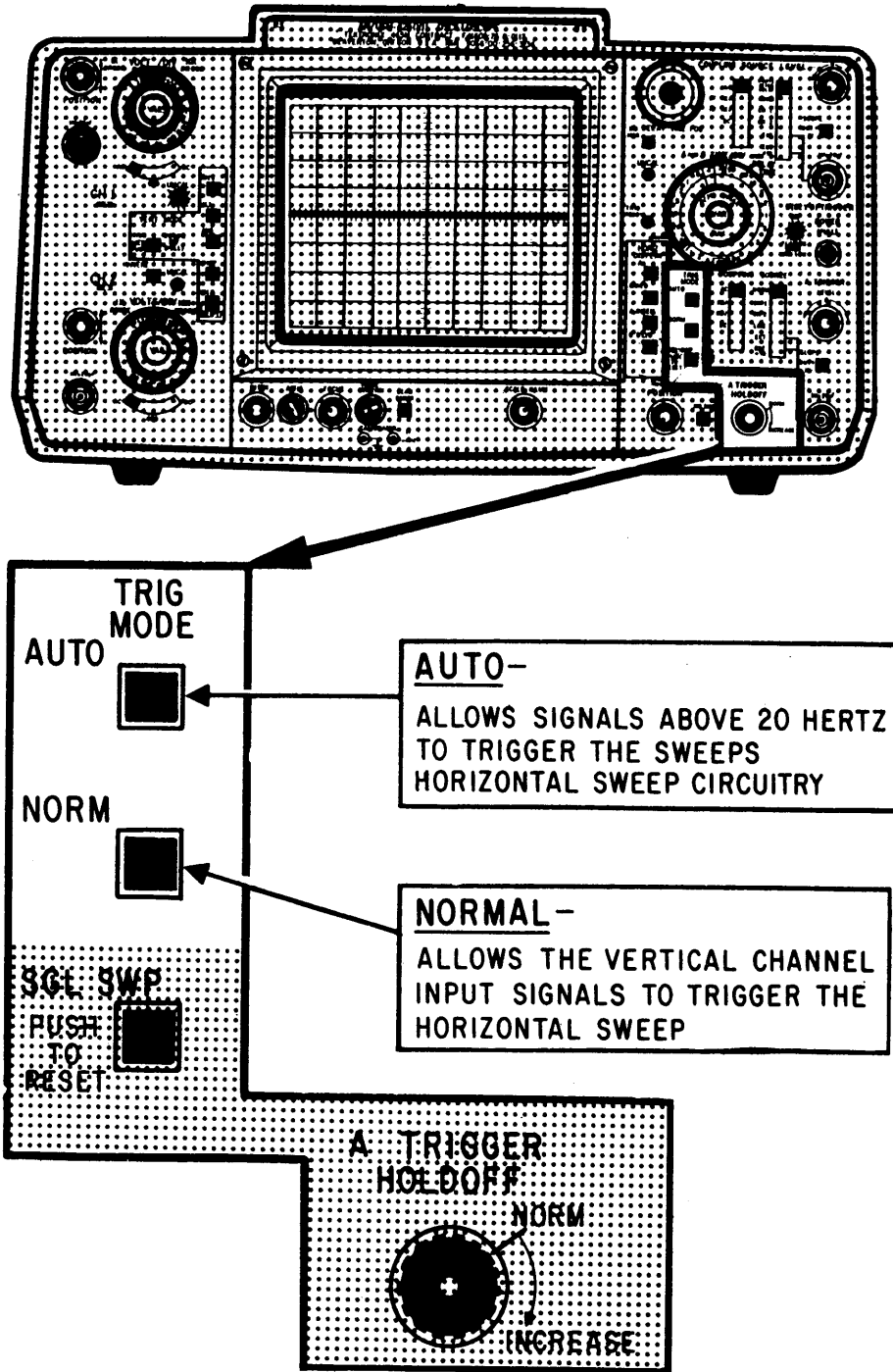
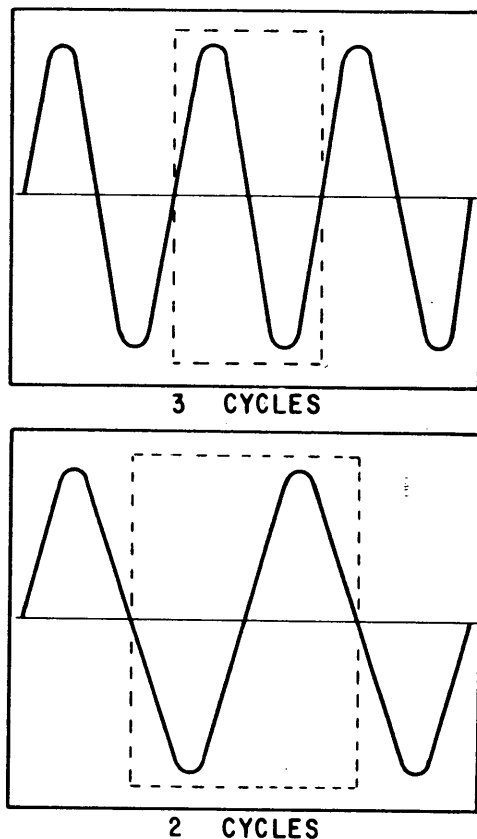

Figure AII-16.—Components to select triggering.



289.48
Figure AII-17.—Proper signal presentation.

screen instead of just one, as shown in figure AII-17.

The center cycle of three cycles provides you with an undistorted waveform in its correct phase. The center of a two-cycle presentation will appear inverted, but it will be undistorted. For you to be able to place waveforms on the CRT in this manner, you must understand the relationship between horizontal and vertical frequencies. The relation between the frequencies of the waveform on the vertical plates and the sawtooth on the horizontal plates determines the number of cycles on the screen, as shown in figure AII-18.

The horizontal sweep frequency of the scope should always be kept lower than, or equal to, the waveform frequency; it should never be higher. If the sweep frequency were higher, only a portion of the waveform would be presented on the screen.

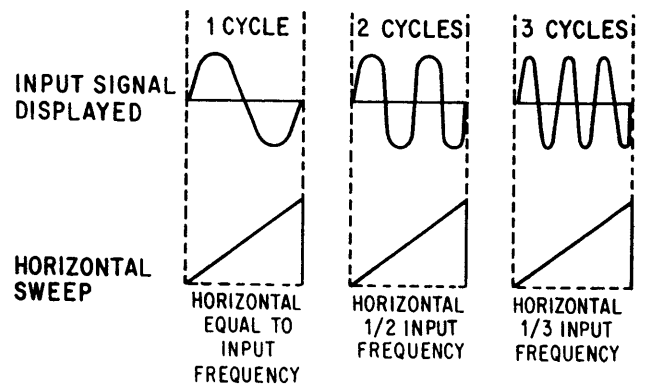

289.49
Figure AII-18.—Vertical versus horizontal frequency relationship.

If, for example, three cycles of the waveform were to be displayed on the screen, the sweep frequency would be set to $1/3$ the frequency of the input signal. If the input frequency were 12,000 Hz, the sweep frequency would be set at 4,000 Hz for a three-cycle scope presentation. For two cycles, the sweep frequency would be set at 6,000 Hz. If a single cycle were desired, the setting would be the same as the input frequency, 12,000 Hz.

DUAL-TRACE CAPABILITY

The information presented in the previous sections are a general overview of the basic, single-trace oscilloscope operation. However, you may be using *dual-trace* operation. Dual-trace operation allows you to view two independent signal sources as a dual display on a single CRT. This allows an accurate means of making amplitude-, phase-, or time-displacement comparisons and measurements between two signals.

A dual-trace oscilloscope should not be confused with a dual-beam oscilloscope. *Dual-beam* oscilloscopes produce two separate electron beams on a single scope that can be individually or jointly controlled. *Dual-trace* refers to a single beam in a CRT that is shared by two channels.

APPENDIX III

DIGITAL DATA TEST SET, DIGITECH-2002 AND DIGITAL DATA DISTORTION TEST SET, AN/USM-329(V)

INTRODUCTION

This appendix discusses both the Digital Data Test Set, DIGITECH-2002, and the Digital Data Distortion Test Set, AN/USM-329(V). The tables following the figures explain the operations of each module.

DIGITAL DATA TEST SET, DIGITECH-2002

The Digital Data Test Set, DIGITECH-2002, uses a modular concept to provide equipment that will meet the individual needs of the user. Every module in this line makes full use of the latest integrated circuit design techniques to produce a highly accurate precision test instrument. This analyzer/generator is used in the field of data communications to determine signal line quality and to assure performance standards of related communications equipment. See figure AIII-1.

TYPICAL OPERATING PROCEDURES

With the generator POWER switch set to the OFF position, verify that the rear panel 115/230-VAC switch is set to the position that corresponds with the available power source. Once the correct power source is established, proceed with the following steps:

1. Set the generator PWR switch to the OFF position.
2. Connect the AC power cord to a convenient 115- or 230-volt AC power source and set the AC PWR switch to the ON position.
3. Make the external battery connections, if a high-level output is required.
4. Set the POLARITY and TIMING switches as follows for low-level outputs, via the front panel "D" connector or rear panel terminal block:
 - a. Set the POLARITY switch for the desired output, EIA or MIL.
 - b. Set the TIMING switch for the desired timing source, INT or EXT.

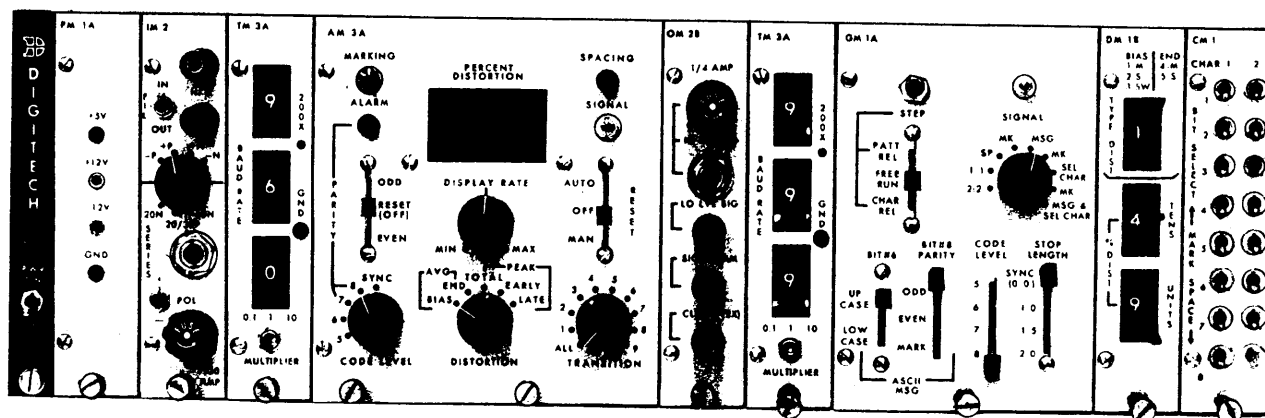

Figure AIII-1.—Analyzer/Generator, Digital Data Test Set, DIGITECH-2002.

5. Connect a patch cord from the appropriate output jack (EIA or HI LVL) to the equipment under test.

6. Set the BAUD RATE thumbwheel and the MULTIPLIER switches for the desired operating speed.

7. Set the CHARACTER RELEASE switch to FREE RUN.

8. Set the FUNCTION select switch to any position labeled MK.

9. Set the CODE LEVEL switch to the 5-, 6-, 7-, or 8-level code positions as required by the equipment under test.

10. Set the STOP LENGTH switch to either the 1.0, 1.5, or 2.0 position to generate a start/stop signal. Set the STOP LENGTH switch to the 0.0 position to generate synchronous characters (no start/stop pulse).

11. Set the ASCII MSG switches as follows when generating the 8-level "FOX" message:

a. Set the BIT #6 switch to the UP CASE position to generate upper case characters or to the LOW CASE position for lower case characters. (NOTE: When transmitting the "FOX" message in 7-level EBCD or 6-level teletype code, the BIT #6 switch must be set to the UP CASE position.)

b. Set the BIT #8 PARITY switch to the ODD position for generating off parity, to the EVEN position for even parity, or to MARK position, which sets the eighth bit of each character to mark.

12. Set the TYPE DIST switch to the position that indicates the type of distortion desired: 1 (marking bias), 2 (spacing bias), 3 (switching bias), 4 (marking end), and 5 (spacing end).

13. Set the UNITS and TENS % DIST switches to the desired amount of distortion from 0 to 40% in 1% increments.

14. Program the selected characters BIT SELECT switches on the CM front panel for the desired two-character sequence. (NOTE: The selected characters are generated only in the SEL CHAR and MSG & SEL CHAR positions of the FUNCTION select switch. In any other position of the FUNCTION select switch, the selected character BIT select switches need not be programmed.)

15. Set the generator AC PWR switch to the ON position and apply power to the equipment under test.

16. Adjust the loop current for the correct value, if the high-level output is used.

17. Set the FUNCTION select switch for the desired output, and note that the SIGNAL lamp flashes to indicate activity at the data output.

(NOTE: The positions of the generator controls may be changed during operations, as required, for complete testing of the external equipment, but, under no circumstances, are modules to be removed while the AC PWR switch is in the ON position.)

ANALYZER OPERATING CHARACTERISTICS

The analyzer portion of the DIGITECH-2002 measures all types of telegraph or data signal distortion. Distortion measurements are made on synchronous or asynchronous signals in 5-, 6-, 7-, or 8-level codes. Average and peak distortion measurements are displayed on a digital readout, permitting an untrained operator to make accurate measurements. All peak readings remain displayed until manually or automatically reset. Parity checks are made on 8-level characters, with the errors indicated by the AM (Analyzer Module) ALARM lamp.

The DIGITECH-2002 accepts data inputs in a series or in a bridging mode. Series current thresholds are set for operation on 20- to 60-mA neutral circuits and for 20- to 30-mA polar circuits. Input signal marking sense is determined by means of a front panel switch and a SIGNAL lamp (illuminates for mark). The bridging input responds to data signals of 0.5 to 150 volts. Additional filtering is provided for data inputs at speeds of 75 bauds or less.

GENERATOR OPERATING CHARACTERISTICS

The generator can produce a "FOX" test message in Baudot, EBCD, ASCII, and EBCDIC codes (depending on the generator module furnished). BIAS distortion (marking or spacing) is switch selectable in 1% increments from 0 to 49%.

When operating in the MSG & SEL CHAR mode, the "FOX" test message may be followed by a group of programmable characters. The same programmable characters are generated separately

in the SEL CHAR mode. The character release rate is controlled three ways:

1. FREE RUN mode: The character release is automatically controlled by the generator module.

2. Manual (MAN) mode: The release is controlled by the operator.

3. External mode (EXT CHAR): The release is accomplished by means of an externally applied stepping source.

In the manual step mode, the operator selects the release of either a single character (CHAR REL) or a complete message pattern (PATT REL) for any one of the output message forms (MSG, SEL CHAR, or MSG & SEL CHAR). The release of a complete message pattern (SEL CHAR) is useful in communications systems where each terminal is polled with a sequence of characters for addressing the terminal. Other output signal forms include 1:1 and 2:2 reversals, Steady Space (SP) and Steady Mark (MK). A low-level 2X CLOCK output is generated for clocking synchronous data circuits.

When transmitting the ASCII "FOX" message, front panel controls establish the state (mark or space) of bits 6 and 8. The BIT #6 switch is set to mark (LOW CASE) for lower case characters or space (UP CASE) for upper case characters. Similarly, the BIT #8 switch is set to ODD or EVEN for selection of odd or even parity on a character basis. In the MARK position, the eighth bit of every character is marking, regardless of parity. (NOTE: When supplied, the EBCD "FOX" message includes a fixed format ODD parity bit.)

The generator is normally furnished with a high-level, solid-state keyer capable of keying external polar or neutral circuits up to 270 volts, and 70 mA at speeds up to 600 bauds. Low-level, solid-state keyers provide EIA-RS-232C and MIL-STD-188C outputs for both data and 2X timing at speeds up to 9600 bauds.

INSTRUMENT SPECIFICATIONS

The underlying equipment specifications are listed in table AIII-1. These specifications include power requirements, physical characteristics, and operating parameters.

Table AIII-1.—Equipment Specifications for Digital Data Test Set, DIGITECH-2002

Item	Characteristics
<u>GENERAL</u>	
<u>Primary Power Source</u>	
Voltage	115/230 volts ac \pm 10%
Frequency	50 to 60 Hz \pm 5%
Power	100 watts
<u>Dimensions</u>	
<u>Rack-Mount Configuration</u>	
Height	5.25 inches (133.35 mm)
Width	19.00 inches (482.60 mm)
Depth	15.00 inches (381.00 mm)
<u>Portable</u>	
Height	5.90 inches (149.90 mm)
Width	20.10 inches (510.10 mm)
Depth	18.00 inches (457.20 mm)

Table AIII-1.—Equipment Specifications for Digital Data Test Set, DIGITECH-2002 (continued)

Item	Characteristics
<u>Weight</u>	Approximately 30 pounds (13.680 kgs)
<u>Operating Temperature</u>	0 to 50 degrees Centigrade 32 to 122 degrees Fahrenheit (operating temperature for rack-mount configuration only)
<u>Speeds</u>	A synthesizer provides any speed up to 9600 bauds. All speeds are crystal-controlled for maximum stability.
<u>ANALYZER</u>	
<u>Inputs</u>	
<u>Series</u>	20 mA neutral 20/30 mA polar 60 mA neutral
<u>Bridging (66K ohms)</u>	+/- 0.5V to 150V polar +/- 1.0V to 150V neutral
<u>Filter</u>	A switch-selectable filter removes spikes, holes, or any transients which are less than 1/2 ms in duration. (Not for use at speeds above 75 bauds.)
<u>Polarity</u>	Positive or negative mark sense.
<u>Distortion Measurements</u>	
<u>Average</u>	Marking and spacing bias. Marking and spacing end.
<u>Peak</u>	Total, early, and late. (NOTE: Transition selection, when provided, permits distortion measurement on all or individually selected transitions within a character.)
<u>Accuracy</u>	2% distortion under all conditions.
<u>Reset</u>	Peak readings are maintained at full level until reset manually or automatically at 3- to 5-second intervals.
<u>Parity</u>	A parity detects odd or even parity on 8-level ASCII messages. Parity errors are displayed by the error module.

Table AIII-1.—Equipment Specifications for Digital Data Test Set, DIGITECH-2002 (continued)

Item	Characteristics
<u>Modes</u>	
<u>Start/Stop</u>	5- through 8-level codes one unit start; 1.0, 1.5, and 2.0 unit stop intervals.
<u>Synchronous</u>	The synchronizer phase locks internal timing to that of the incoming signal.
<u>Digital Readout</u>	
<u>Percent Distortion</u>	The digital readout displays percent distortion in 1% increments from 0 to 49.
<u>Lamp Display</u>	
<u>Distortion</u>	The MARKING and SPACING lamps indicate the type of distortion measured.
<u>Parity Error</u>	The ALARM lamp illuminates to indicate parity errors in 7- and 8-level codes.
<u>Input Signal</u>	The SIGNAL lamp indicates the input signal.
<u>GENERATOR</u>	
<u>Distortion</u>	
<u>Type</u>	Bias: marking, spacing, or switching. End: marking or spacing.
<u>Amount</u>	0 to 49% in 1% increments.
<u>Character Release</u>	
<u>FREE RUN</u>	The automatic release of characters in sequence.
<u>STEP (internal/external) CHAR</u>	The character release initiated by the operator via the front panel push-button switch or by external contact closure via the rear panel terminal strip. The release of single characters in a programmed sequence.
<u>PATT REL</u>	The release of a complete test message, two-character sequence, or a test message followed by a two-character sequence.

Table AIII-1.—Equipment Specifications for Digital Data Test Set, DIGITECH-2002 (continued)

Item	Characteristics
<u>Character Format</u>	
<u>Start/Stop</u>	A character length of 5, 6, 7, or 8 intelligence bits with a 1.0 unit start and a 1.0, 1.5, or 2.0 unit stop.
<u>Synchronous</u>	A character length of 5, 6, 7, or 8 intelligence bits with no start or stop interval.
<u>Output Message Forms</u>	The data output may be selected as follows:
	2:2 } continuous reversals 1:1 }
	SP — steady space MK — steady mark MSG — “FOX” test message as follows:
	Baudot: <u>CR</u> <u>CR</u> <u>LF</u> <u>LTRS</u> <u>THE</u> <u>SP</u> <u>QUICK</u> <u>SP</u> <u>BROWN</u> <u>SP</u> <u>FOX</u> <u>SP</u> <u>JUMPS</u> <u>SP</u> <u>OVER</u> <u>SP</u> <u>A</u> <u>SP</u> <u>LAZY</u> <u>SP</u> <u>DOG</u> <u>SP</u> <u>FIGS</u> <u>1234567890</u> <u>SP</u> <u>LTRS</u> <u>TEST</u> <u>SP</u> .
	ASCII: <u>DEL</u> <u>CR</u> <u>CR</u> <u>LF</u> <u>THE</u> <u>SP</u> <u>QUICK</u> <u>SP</u> <u>BROWN</u> <u>SP</u> <u>FOX</u> <u>SP</u> <u>JUMPS</u> <u>SP</u> <u>OVER</u> <u>SP</u> <u>A</u> <u>SP</u> <u>LAZY</u> <u>SP</u> <u>DOG</u> <u>SP</u> <u>1234567890</u> <u>SP</u> <u>SP</u> <u>DE</u> .
	EBCD (optional): <u>NL</u> <u>UC</u> <u>THE</u> <u>SP</u> <u>QUICK</u> <u>SP</u> <u>BROWN</u> <u>SP</u> <u>FOX</u> <u>SP</u> <u>JUMPS</u> <u>SP</u> <u>OVER</u> <u>SP</u> <u>A</u> <u>SP</u> <u>LAZY</u> <u>SP</u> <u>DOG</u> <u>SP</u> <u>LC</u> <u>1234567890</u> <u>SP</u> <u>UC</u> <u>TEST</u> .
	EBCDIC (optional): <u>NULL</u> <u>CR</u> <u>CR</u> <u>LF</u> <u>THE</u> <u>SP</u> <u>QUICK</u> <u>SP</u> <u>BROWN</u> <u>SP</u> <u>FOX</u> <u>SP</u> <u>JUMPS</u> <u>SP</u> <u>OVER</u> <u>SP</u> <u>A</u> <u>SP</u> <u>LAZY</u> <u>SP</u> <u>DOG</u> <u>SP</u> <u>1234567890</u> <u>SP</u> <u>DE</u> <u>DP</u> <u>DEL</u> <u>DEL</u> .
	NOTES:
	1. The underlined characters are non-printing. 2. Refer to the CM section for programming charts and legend.

Table AIII-1.—Equipment Specifications for Digital Data Test Set, DIGITECH-2002 (continued)

Item	Characteristics
<u>Output Keying Circuits</u>	<p>SEL CHAR—A two-character sequence as programmed by the operator.</p> <p>MSG SEL CHAR—A complete “FOX” message, followed by an operator-programmed, two-character sequence.</p>
<u>High-Level Data</u>	<p>A fully isolated polar/neutral keyer rated for 150/270V at 40/70 mA. External battery connections are made via the rear panel terminal strip. The series output is provided by a front panel jack.</p>
<u>Low-Level Data</u>	<p>The switch-selectable EIA or MIL outputs are via the front five-way binding post and the rear panel terminal strip.</p> <p>EIA-RS-232C: Current limited to 10 mA, with an open circuit output of ± 12 volts for speeds up to 9600 bauds.</p> <p>MIL-STD-188C: Open circuit voltage of ± 6 volts (± 1 volt), with a source impedance of 100 ohms at 10 mA.</p>
<u>Low-Level Clock</u>	<p>One cycle per bit output uses the same type of electrical circuits as the low-level data outputs (switch-selectable EIA or MIL levels). Mid-bit transition polarity may be changed by means of an output module strap option.</p>

SYNCHRONOUS OPERATION

Synchronous signals are continuous streams of data in which only information bits are transmitted. In the transmission of a perfect synchronous signal, the interval between transitions is an integral number of bits and the transmission frequency is accurate and stable (usually to 1 part in 106 or better). Analysis of synchronous signals is accomplished on a continuous basis. The internal timing of the analyzer is phase-locked with the incoming signal. However, corrections to the internal

timing are sufficiently damped so that fortuitous or random distortion will not change the relative phasing between the input signal and the timing. In making distortion measurements of synchronous signals, only bias measurements are possible, since there is no end distortion on synchronous data. To make the measurement, set the CODE LEVEL switch on the analyzer to SYNC; the TRANSITION switch should be in the ALL position. The digital PERCENT DISTORTION readout reflects the average or peak bias distortion contained in the synchronous signal.

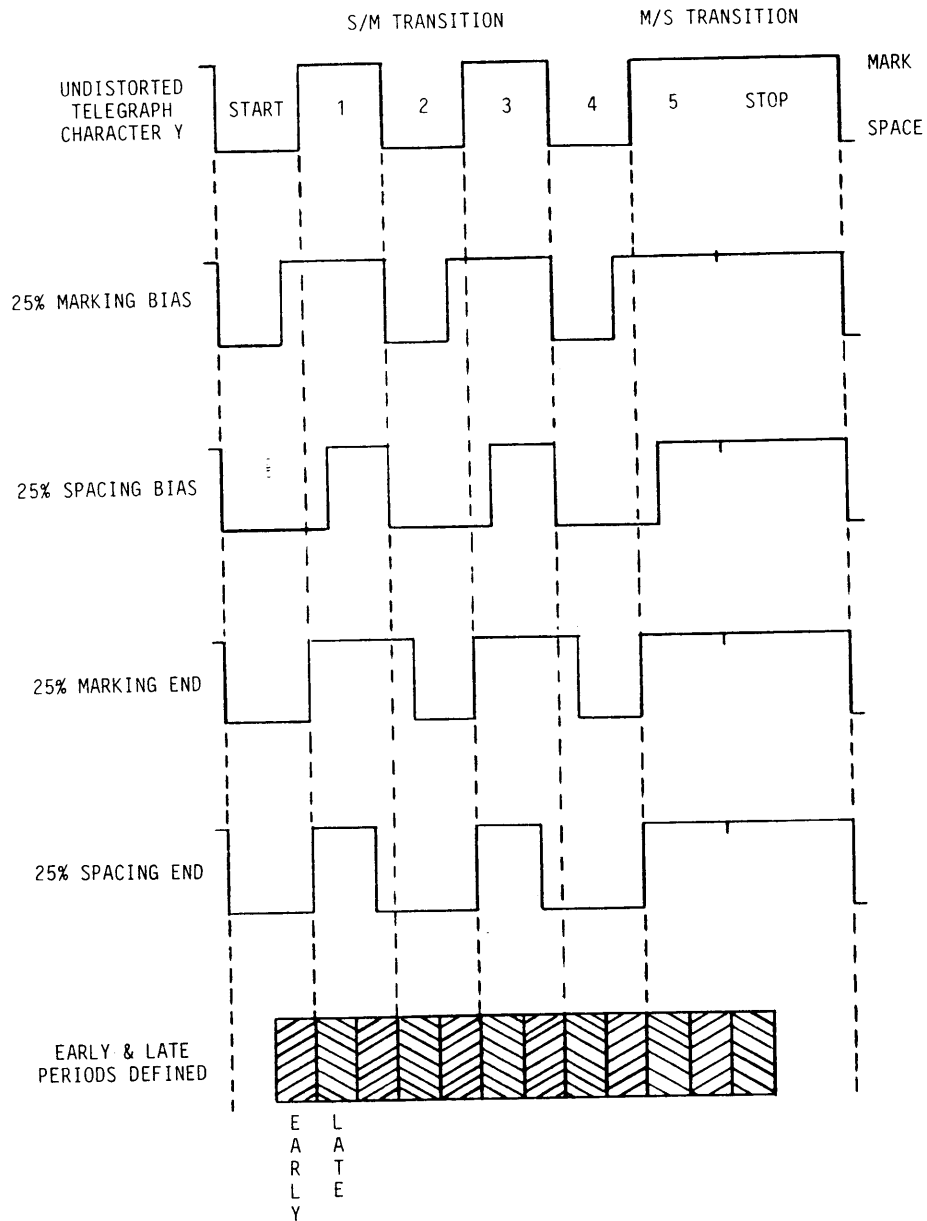

Figure AIII-2.—Types of distortion.

DISTORTION MEASUREMENT AND ANALYSIS TECHNIQUES

Distortion analysis includes types of distortion, transition selection, code levels, and measurement. This section will also discuss operating procedures.

Types of Distortion

Figure AIII-2 refers to a representation of telegraph characters and the various types

of bias and end distortion. Each character is made up of a start space (current-off condition in the telegraph loop), followed by five intelligence bits to form a specific character, and a stop mark (current-on). The stop element may be selected at 1.0, 1.5, or 2.0 times the length of the other bits. In figure AIII-2 the character Y is shown undistorted in line 1 with a 1.5 stop element. The succeeding lines show the same character with a 1 to 50% (shaded area) distortion range of each type.

Bias distortion is the average displacement of all Space-to-Mark (S/M) transitions with respect to the perfect position. When the transition occurs early, it lengthens the following mark interval and is called *marking bias*. When the transition occurs late, it lengthens the preceding space interval signal and is called *spacing bias*. Switched bias occurs on the start/stop telegraph signals and appears as marking and spacing bias on alternate characters. These types of bias distortion apply to both start/stop telegraph signals and to synchronous data signals.

End distortion is the average displacement of the Mark-to-Space (M/S) transitions in a start/stop telegraph character relative to the first M/S transition (start pulse). It is called *marking end* if the preceding marking interval is lengthened (transition occurs late), and *spacing end* if the resulting space interval is lengthened (transition occurs early).

Transition Selection

The analyzer measures distortion, determined by the setting of the TRANSITION switch, for all transition times in a character. With the TRANSITION switch in the ALL position and the DISTORTION switch in the END position, the distortion is measured on all transitions within the character, both S/M and M/S. When the DISTORTION switch is in the EARLY or LATE position, distortion is measured on all transitions occurring early or late, respectively. Total, early, or late peak measurements are retained on the front panel meter or digital display until signal distortion increases, or until the reading is automatically or manually reset. The TRANSITION switch is used to select any particular transition interval within the character for measurement, in keeping with the setting of the DISTORTION switch. The number of transitions in a character is always one more than the code level of the character. Thus, the setting of the TRANSITION switch must coordinate with the setting of the CODE LEVEL switch. The display must be reset each time the TRANSITION switch is advanced. This feature (having the capability of selecting a particular transition) is useful in locating defective segments on commutators and locating distortion sources that are evident only in certain bits of a character. It is also useful in detecting distortion due to small speed errors in the signal.

Code Levels

The analyzer is designed to measure all start/stop signals in 5-, 6-, 7-, or 8-level codes. The 5-level Baudot code (ITA-2) is commonly used in telegraph communications, while IBM typewriters use a 6-level code. Telex and computer-oriented data transmission signals generally use the 8-level ASCII. It is essential that the signal language and code level be determined before operating the analyzer.

Distortion Analysis Operating Procedures

With the POWER switch set to the OFF position, verify that the rear panel 115/230-VAC switch is set to the position that corresponds with the available power source. Once the correct power source is established, proceed with the following steps:

1. Set the AC PWR switch to the OFF position.
2. Connect the AC power cord to a convenient 115- or 230-volt AC power source, and set the AC PWR switch to the ON position.
3. Set the INPUT connections as follows:
 - a. Connect a patch cord from the circuit under test to the HI Z input terminal (IM) for bridging inputs. Then, set the INPUT select switch to the proper mark sense for a polar or neutral input.
 - b. Connect a patch cord from the circuit under test to the SERIES input jack (IM) for high-level series inputs. Then, set the IM INPUT select switch for 20N, 20/30P, or 60N to correspond with circuit parameters. Also, set the POL switch (IM) for the proper mark sense.
 - c. Connect an interface cable between the equipment under test and the front panel "D" connector (I/O) to analyze the low-level EIA or MIL, terminal, or modem input. (Refer to the ES Section (IM) for the proper mark sense [-P for EIA inputs and +P for MIL inputs].)
4. Set the BAUD RATE thumbwheel and the MULTIPLIER switches (TM) for the desired operating speed.

5. Set the TIMING switch (I/O) to INT for all positions of the BAUD RATE switches. To select the modem-supplied clock, set the TIMING switch to EXT.

6. Set the TRANSITION switch (AM) to ALL.

7. Set the CODE LEVEL switch (AM) to the position that corresponds with the input signal code level. For synchronous inputs set the CODE LEVEL switch to SYNC.

8. Set the RESET switch (AM) to OFF.

9. Set the PARITY switch (AM) to RESET (OFF).

10. Set the DISTORTION switch (AM) to BIAS and measure bias distortion. Note the type of bias as indicated by the front panel MARKING or SPACING lamps.

11. Measure the amount and type of distortion for each of the remaining DISTORTION switch positions (END, TOTAL, EARLY, and LATE).

12. Set the the PARITY switch (AM) for the parity mode of the input signal (ODD or EVEN). The occurrence of a parity error is indicated by the ALARM lamp (AM). The error module will display any parity error count.

Measuring Speed Error

Differences between the operating speed of the analyzer (as selected by the analyzer BAUD RATE switches) and the incoming signal will introduce bias distortion. A faster incoming signal introduces spacing bias distortion. On a random signal pattern, the distortion measurement on each successive transition within a character will increase when there is a difference in speeds. By using the TRANSITION switch, a measurement can be made on each transition of the incoming signal to determine the distortion increase from the first transition to the last. With Baudot signals, the amount of speed error in percent is one-fifth the increase in distortion reading from transition one to transition six. For example, a five percent increase in marking bias distortion

from the first to the ninth transition represents a one percent speed error.

Measuring Total Peak Distortion

Total distortion, as measured by the analyzer, is the highest amount of distortion of any type occurring on the signal. Once obtained, the reading is maintained on the meter until the distortion changes to a higher reading, or the meter is reset to 0. For total distortion measurements, proceed as follows:

1. Perform all steps outlined in the preliminary instructions.

2. Set the DISTORTION switch to the TOTAL position and measure total peak distortion, as displayed by the AM digital readout.

3. Set the RESET switch (AM) to AUTO, and note that the distortion reading is reset at 3- to 5-second intervals, providing a series of true peak readings.

4. If the distortion reading is high in successive measurements, further measurements must be made to isolate the amount and type of distortion. If the reading is high only intermittently, the distortion is fortuitous.

Measuring Early and Late Peak Distortion

If the readings obtained in the TOTAL PEAK position of the DISTORTION switch are consistently high, early and late peak measurements are made to further define the amount and type of distortion.

Set the DISTORTION switch to the EARLY position. The AM digital readout will display the amount of peak distortion, that is a result of early transitions, occurring on both M/S and S/M transitions.

Set the DISTORTION switch to the LATE position. The readout will display the amount of peak distortion, that is a result of late transitions, occurring on the M/S and S/M transitions.

By repeating the measurements over a period of time, the operator can determine the consistency or the intermittent nature of the distortion.

If the readings are fairly consistent, bias and end distortion measurement will identify the amount and type of distortion.

Measuring Bias and End Distortion

Early peak distortion is indicative of early transition occurrence. Early occurrence of transitions may be the result of marking bias or spacing end distortion, depending upon whether it is the M/S transition or the S/M transition that is affected. Late occurrence of the transitions is the result of spacing bias or marking end distortion. Assume a late peak of 10%.

Set the DISTORTION switch to the BIAS position. If the distortion is bias, the analyzer module will display the average amount of distortion, and the SPACING lamp will illuminate. If there is no bias distortion, the digital readout will display 00. If there is 1% distortion, the MARKING and SPACING lamps may alternately blink, or one of the lamps will light steadily.

Set the DISTORTION switch to the END position. If the distortion is end, the readout will display the amount of distortion, and the MARKING lamp will indicate that the distortion is marking. If there is no end distortion, the readout will display 00. If there is 1% distortion, the MARKING and SPACING lamps may alternately blink, or one of the lamps will light steadily.

The late peak distortion reading may be the result of both spacing bias and marking end distortion, in which case a reading will be obtained for both measurements.

Assume an early peak reading of 10%. Set the DISTORTION switch to BIAS. If the distortion is bias, the digital readout will display the amount of distortion and the MARKING lamp will indicate that the bias is marking. If there is no bias distortion, the readout will display 00. If there is 1% distortion, the MARKING and SPACING lamps may alternately blink, or one of the lamps will light steadily.

Set the DISTORTION switch to the END position. If end distortion is present, the readout will display the amount and the SPACING lamp

will light, identifying it as spacing end distortion. With no end distortion, the readout will display 00. If there is 1% distortion, the lamps may alternately blink, or one of the lamps will light steadily.

(NOTE: The various analyzer measurements should be repeated to ensure the proper interpretation of the results. Through experience, the operator will be able to quickly interpret the various readings.)

Analyzing Unknown Signals

When analyzing an unknown signal, the following characteristics must be determined:

- Type of signal (neutral or polar, high or low level).
- Polarity of signal.
- Current level (20 or 60 mA) of a neutral signal.
- Speed of signal.
- Total peak distortion.
- Amount of bias and end distortion.
- Amount of fortuitous distortion.
- Presence of shaping signals.

A milliammeter may be used to check current levels of SERIES input signals. A 20-mA signal will not produce measurements on the analyzer when the switch is in the 60N position. A 60-mA signal will produce readings on all positions of the switch.

Use the POL switch to determine correct polarity of SERIES input signals. On neutral signals, only the correct position of this switch will cause the SIGNAL lamp to flash.

INPUT/TIMING MODULE (I/T-1)

This section contains the information required for operation and maintenance of the

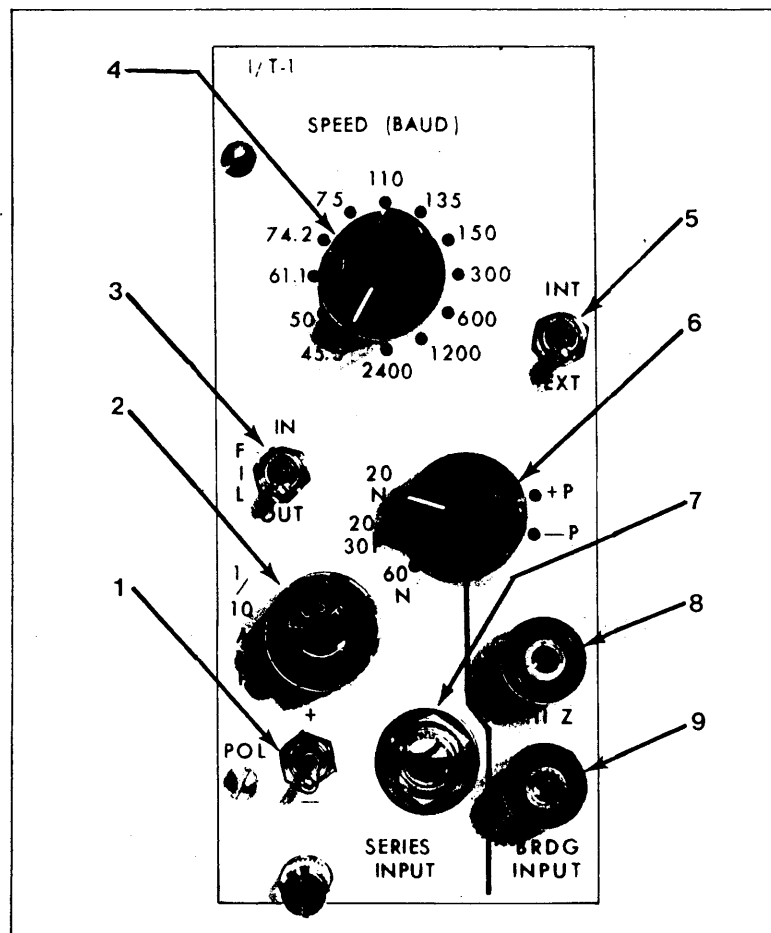

Figure AIII-3.—Input/Timing Module, I/T-1, DIGITECH-2002.

DIGITECH-2002 Input/Timing Module, I/T-1. See figure AIII-3.

Description and Purpose

The input/timing module provides the input circuit logic and the internal timing for the unit. Timing is generated for 12 speeds, from 45.5 to 2400 bauds, with a separate toggle switch to select either the internal oscillator or an external timing source (200 times the desired baud rate, 0 to +5 volts).

The module can monitor data in two modes: series or bridging. In the series mode, neutral or polar signals are placed in series with the isolated input to the module through the front panel jack. Current thresholds are established by the position of the INPUT select switch. The switch is set for neutral operation on 20- or 60-mA circuits or for polar operation on 20- to 30-mA loops. A polarity switch is used to determine marking sense (positive

or negative). The SERIES INPUT to the I/T-1 is fused at 100 mA.

The bridging input operates on data signals from 0.5 to 150 volts. When in the bridging mode, the marking sense for polar or neutral inputs is determined by the position of the INPUT select switch. A FILTER switch, functional in series or bridging operation, adds filtering to the data input to eliminate transients of 1.5 milliseconds or less. The filter should not be used at speeds above 75 baud. The unit measures approximately 5-1/4 inches high by 2-3/8 inches wide by 11-1/8 inches deep. The maximum rated power consumption is approximately 3.5 watts.

Controls, Indicators, and Connectors

The name and function of each module control, indicator, and connector are listed in table AIII-2. They are indexed to figure AIII-3.

Table AIII-2.—Controls, Indicators, and Connectors for Input/Timing Module, I/T-1, DIGITECH-2002 (Shown in Figure AIII-3)

INDEX NUMBER	NAME	FUNCTION
1	POL switch	Determines the marking sense of the series input signal.
2	1/10 FUSE	Protects the series input circuits from current overload.
3	FIL switch	Switches low pass filters in or out of input circuit for speeds up to 75 bauds.
4	SPEED (BAUD) switch	Selects any one of 12 operating speeds from 45.5 to 2400 bauds:
		45.5 135
		50.0 150
		61.1 300
		74.2 600
		75.0 1200
		110.0 2400
5	INT/EXT select switch	Selects either an internal oscillator as a timing source or an externally applied time base at 200 times the desired baud rate (0 to +5 volts).
6	INPUT select switch	Determines the marking sense of neutral or polar bridging inputs in HI Z, and selects the current thresholds for 20N, 20/30P, or 60N series loops.
7	SERIES input jack	Provides access to the low impedance series input circuits.
8	HI Z jack	Provides logic reference for the HI Z data input.
9	BRDG INPUT jack	Is the bridging input for use with polar signals with amplitudes from +/- 0.5 volts to 150 volts, and neutral signals with amplitudes from +/- 1 volt to 150 volts.

ANALYZER MODULE, AM-3A

This section contains information required for operation and maintenance of the DIGITECH-2002 Analyzer Module, AM-3A. See figure AIII-4.

Description and Purpose

The analyzer module is a solid-state, plug-in assembly that provides accurate distortion measurements on telegraph and data signals at speeds ranging from 10 to 9990 bauds. It measures all types of telegraph distortion on all or individually selected transitions within a start/stop character. BIAS and END distortion (as well as TOTAL, EARLY, and LATE PEAK measurements) appear on an easy-to-read digital display, permitting an untrained operator to make accurate measurements. All peak readings remain displayed until

the digital readout circuits are manually or automatically reset.

Distortion is measured on start/stop telegraph and data signals using 5- through 8-level codes. The length of the stop interval has no effect on the measurement. Phase lock of the internal timing with that of the incoming data signal permits accurate measurement of synchronous signals. ODD or EVEN parity is detected during 7- and 8-level operations. These capabilities permit use of the analyzer module for the qualitative analysis of data and telegraph signals. The unit will detect parity errors and determine the amount and type of distortion on the line. The use of EARLY and LATE PEAK measurements enables the operator to determine the amount of fortuitous or cyclic distortion. The TOTAL PEAK measurement indicates the highest distortion during any given period. The ability to measure distortion on all or individually selected bits aids in isolating the

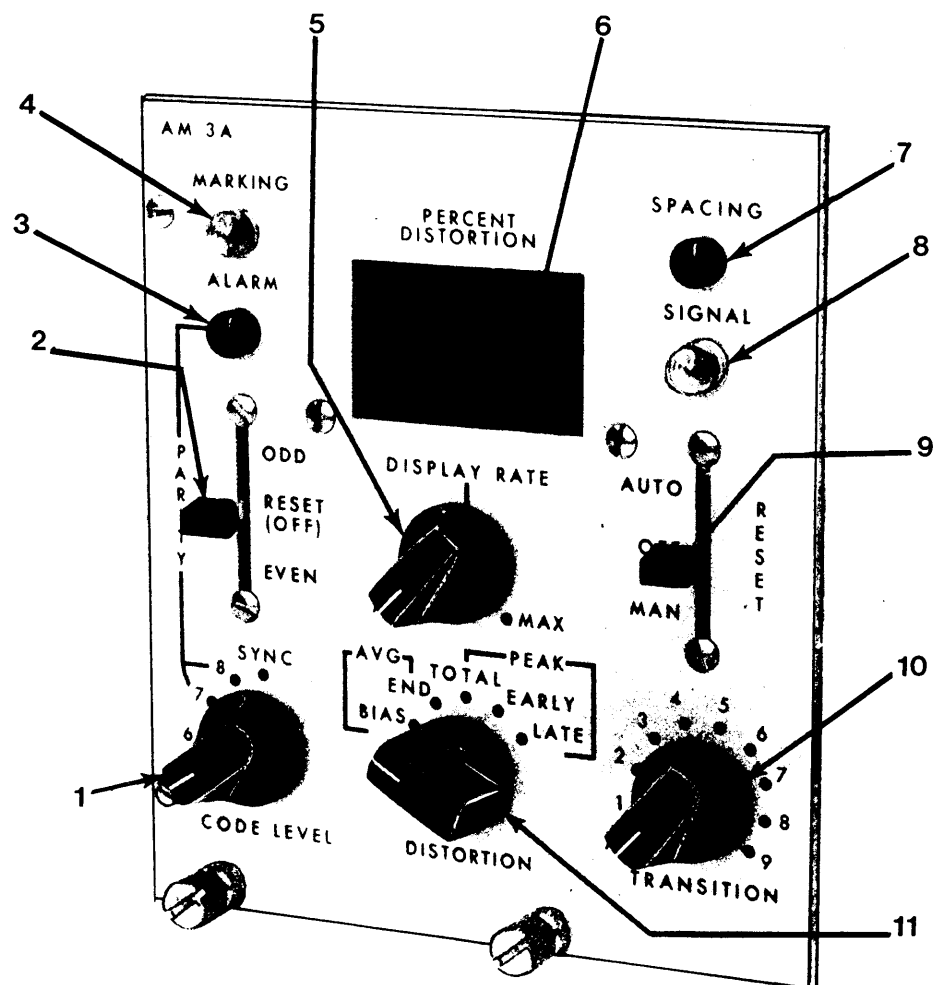

Figure AIII-4.—Analyzer Module, AM-3A, DIGITECH-2002.

cause of distortion and can be used to measure speed error. The unit measures approximately 5 inches wide by 5-1/4 inches high by 11-1/8 inches deep. The maximum rated power consumption of the module is approximately 7 watts.

Controls, Indicators, and Connectors

The name and function of each module control, indicator, and connector are listed in table AIII-3. They are indexed to figure AIII-4.

Table AIII-3.—Controls, Indicators, and Connectors for Analyzer Module, AM-3A, DIGITECH-2002 (Shown in Figure AIII-4)

INDEX NUMBER	NAME	FUNCTION
1	CODE LEVEL switch	Selects the code level from 1 through 8 to correspond with the number of intelligence bits in a start/stop character.
2	PARITY switch	Selects the ODD and EVEN parity measurement and resets the PARITY ALARM circuits.
3	ALARM lamp	Illuminates when a parity error is detected.
4	MARKING lamp	Illuminates when distortion on the input signal is marking bias or marking end.
5	DISPLAY RATE potentiometer	Controls the rate at which the digital display is updated (from 0.5 to 5.0 seconds approximately).
6	PERCENT DISTORTION display	Provides a digital readout of the signal distortion in percent.
7	SPACING lamp	Illuminates when distortion on the input signal is spacing bias or spacing end.
8	SIGNAL lamp	Illuminates when the input signal is marking.
9	RESET switch	Resets, manually or automatically, the PERCENT DISTORTION display.
10	TRANSITION select switch	Selects, for measurement, all or individual transitions within a character.
11	DISTORTION select switch	Selects, for measurement, any of the following types of distortion: <div style="margin-left: 100px;"> AVG — BIAS — END PEAK — TOTAL — EARLY — LATE </div>

GENERATOR MODULE, GM-1A

This section contains information required for operation and maintenance of the DIGITECH-2002 Generator Module, GM-1A. See figure AIII-5.

Description and Purpose

The generator module is a solid-state, plug-in assembly used in DIGITECH's modular series test instruments. The complete module is 3-1/2 inches wide by 5-1/4 inches high by 11-1/8 inches long. The operating voltage and time-base frequencies to the GM-1A are furnished by the power and

timing modules. Other logic inputs are supplied by the distortion and character modules. The generator module provides the logic required for synchronous or asynchronous "FOX" message transmission in a variety of code levels and character release modes. The maximum rated power consumption of the module is approximately 2.4 watts.

Controls, Indicators, and Connectors

The name and function of each module control, indicator, and connector are listed in table AIII-4. They are indexed to figure AIII-5.

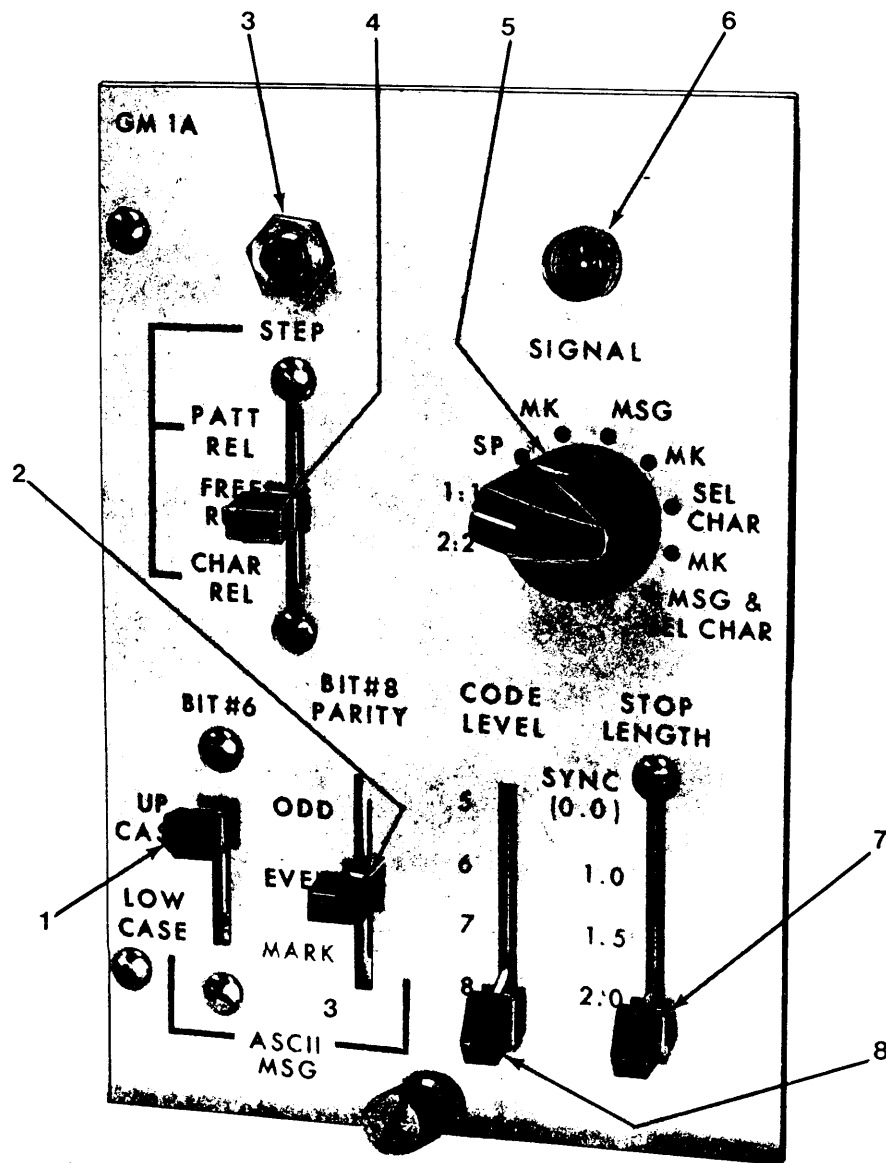

Figure AIII-5.—Generator Module, GM-1A, DIGITECH-2002.

Table AIII-4.—Controls, Indicators, and Connectors for General Module, GM-1A, DIGITECH-2002 (Shown in Figure AIII-5)

INDEX NUMBER	NAME	FUNCTION
1	ASCII MSG BIT #6	Sets BIT #6 to mark or space for selection of lower or upper case characters, respectively.
2	ASCII MSG BIT #8 PARITY	Sets BIT #8 to mark for all characters of the ASCII ROM, or selects EVEN or ODD parity.
3	STEP switch	Releases one character at a time when S2 is in CHAR REL position. Also releases an entire test message or a sequence of characters when S2 is in the PATT REL position.
4	CHAR REL switch	Selects FREE RUN or STEP character release. In the STEP mode, characters are released manually or by external contact closure. In the FREE RUN mode, characters are released automatically by the generator. Characters are released one at a time in the CHAR REL position. In the PATT REL position, release is by character sequence or by complete pattern.
5	FUNCTION select switch	Selects output message form: 2:2, 1:1 reversals. SP — steady space MK — steady mark MSG — test message MK, SEL CHAR — selected character from 1 to 8 MK, MSG, and SEL CHAR — test message, followed by a selected character sequence
6	SIGNAL lamp	Illuminates for a marking output.
7	STOP LENGTH	Selects STOP LENGTH of 1.0, 1.5, or 2.0 units for start/stop characters. In the SYNC (0.0) position, the stop pulse is not generated.
8	CODE LEVEL	Selects 5-, 6-, 7-, or 8-level code operation.

DISTORTION MODULE, DM-1B

This section contains information required for operation and maintenance of the DIGITECH-2002 Distortion Module, DM-1B. See figure AIII-6.

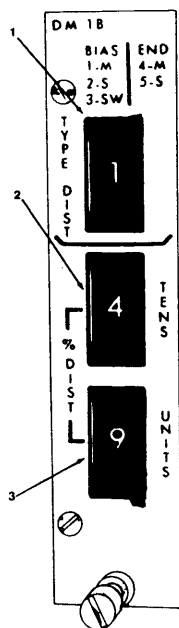

Figure AIII-6.—Distortion Module, DM-1B, DIGITECH-2002.

Description and Purpose

The distortion module is a solid-state, plug-in assembly used with DIGITECH's modular series test instruments. It can introduce delays in the mark-to-space or space-to-mark transitions of the undistorted GM-1A data output. The distortion is introduced in 1% increments up to 49%. Five types of distortion are generated: marking bias, spacing bias, switching bias, marking end, and spacing end. The unit measures 1-1/4 inches wide by 5-1/4 inches high by 11-1/8 inches deep. The maximum rated power consumption is approximately 1 watt.

Controls, Indicators, and Connectors

The name and function of each module control, indicator, and connector are listed in table AIII-5. They are indexed to figure AIII-6.

CHARACTER MODULE, CM-2

This section contains information required for the operation and maintenance of the DIGITECH-2002 Character Module, CM-2. See figure AIII-7.

Table AIII-5.—Controls, Indicators, and Connectors for Distortion Module, DM-1B, DIGITECH-2002 (Shown in Figure AIII-6)

INDEX NUMBER	NAME	FUNCTION
1	TYPE DIST switch	Selects any one of the five switch types of distortion generated: 1 — M (marking bias) 2 — S (spacing bias) 3 — SW (switching bias) 4 — M (marking end) 5 — S (spacing end)
2	% DIST TENS switch	Selects the amount of distortion in 10% increments from 10 to 40%.
3	% DIST UNITS switch	Selects the amount of distortion in 1% increments from 0 to 9%.

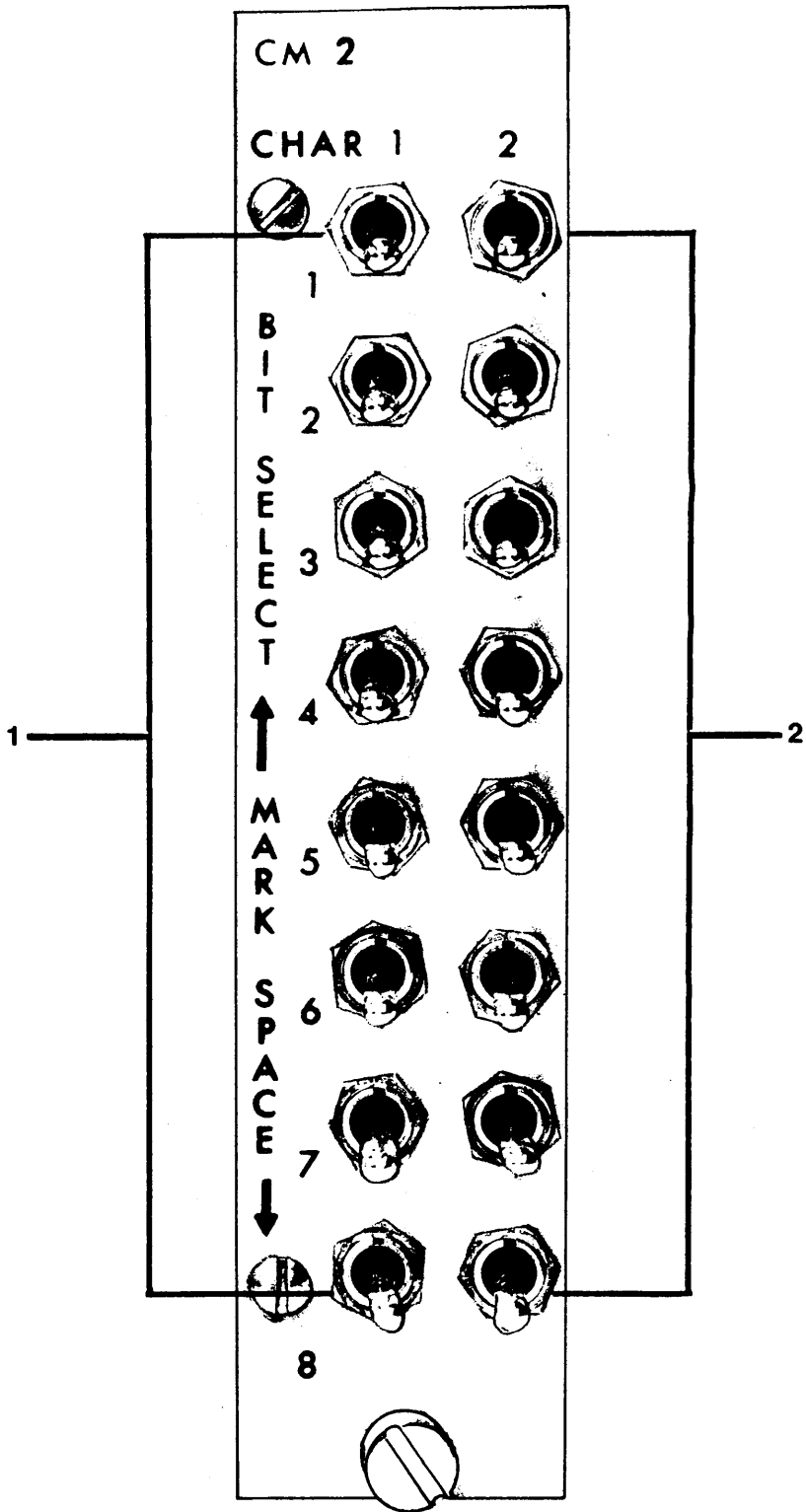
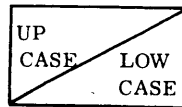

Figure AIII-7.—Character Module, CM-2, DIGITECH-2002.

Table AIII-6.—Extended Binary Coded Decimal (EBCD 1050)

b7-c →			X	X	X	X	X	X	X	X	X	X	X	X	X	X				
b6-1 →			0	1	0	1	0	1	0	1	0	1	0	1	0	1				
b5-2 →			0	0	1	1	0	0	1	1	0	0	1	1	0	0				
b4-4 →			0	0	0	0	1	1	1	1	0	0	0	0	1	1				
b3-8 →			0	0	0	0	0	0	0	0	1	1	1	1	1	1				
BITS B I T S	b2 A	b1 B	COLUMN ROW ↓	1	2	3	4	5	6	7	8	9	10	11	12	13	14	15	16	
	0	0	1	SP	=	<	;	:	%	,	"	*	()	+ /	#	PN	RS	UC	EOT
	0	1	2	-	J	K	L	M	N	O	P	Q	R		!	\$	RES	NL	BS	IL
	1	0	3	ç	?	S	T	U	V	W	X	Y	Z		/	,	BY	LF	EOB	PRE
	1	1	4	+	&	A	B	C	D	E	F	G	H	I		.	PF	HT	LC	DEL



LEGEND

1 = MARK
0 = SPACE

b7 - PARITY CHECK BIT
(x may be "1" or "0"
depending on parity)

- | | | | |
|-----|--|-----|---------------------|
| PN | PUNCH ON | UC | UPPER CASE |
| BY | BYPASS | EOB | END OF BLOCK |
| RES | RESTORE | BS | BACK SPACE |
| PF | PUNCH OFF | LC | LOWER CASE |
| LF | LINE FEED | EOT | END OF TRANSMISSION |
| NL | NEW LINE (Carrier Return
and Line Feed) | PRE | PREFIX |
| | | IL | IDLE |
| HT | HORIZONTAL TAB | DEL | DELETE |

Description and Purpose

The character module is a solid-state, plug-in assembly that produces two switch-programmable characters in 5-, 6-, 7-, or 8-level codes. The characters are programmed from the 16 front panel bit switches, while the code level is selected on the accompanying generator module. The generator module also

supplies the necessary timing inputs to the character module and converts the CM-2 parallel data output into serial form. The unit measures 1-1/4 inches wide, by 5-1/4 inches high, by 11-1/8 inches deep. The maximum rated power consumption of the module is approximately 0.25 watts. (NOTE: To program selected characters, refer to tables AIII-6 through AIII-10.)

Table AIII-7.—ASCII Code

B I T S	b7 b6 b5				COLUMN →	0	0	0	0	1	1	1	1
	b4	b3	b2	b1	ROW ↓	0	1	2	3	4	5	6	7
0	0	0	0	0	0	NUL	DLE	SP	0	@	P	,	p
0	0	0	1	1	1	SOH	DC1	!	1	A	Q	a	q
0	0	1	0	0	2	STX	DC2	"	2	B	R	b	r
0	0	1	1	1	3	ETX	DC3	#	3	C	S	c	s
0	1	0	0	0	4	EOT	DC4	\$	4	D	T	d	t
0	1	0	1	1	5	ENQ	NAK	%	5	E	U	e	u
0	1	1	0	0	6	ACK	SYN	&	6	F	V	f	v
0	1	1	1	1	7	BEL	ETB	'	7	G	W	g	w
1	0	0	0	0	8	BS	CAN	(8	H	X	h	x
1	0	0	1	1	9	HT	EM)	9	I	Y	i	y
1	0	1	0	0	10	LF	SUB	*	:	J	Z	j	z
1	0	1	1	1	11	VT	ESC	+	;	K	[k	{
1	1	0	0	0	12	FF	FS	,	<	L	\	l	:
1	1	0	1	1	13	CR	GS	-	=	M]	m	}
1	1	1	0	0	14	SO	RS	.	>	N	^	n	~
1	1	1	1	1	15	SI	US	/	?	O	_	o	DEL

Legend

- | | | |
|-------------------------|-------------------------------|---------------------|
| ENQ-Enquiry | ETB-End of transmission block | FS-File separator |
| ACK-Acknowledge | CAN-Cancel | GS-Group separator |
| BEL-Bell | EM-End of media | RS-Record separator |
| BS-Back space | SUB-Substitute | US-Unit separator |
| HT-Horizontal tab | ESC-Escape | LF-Line feed |
| NUL-Null | SI-Shift in | VT-Vertical tab |
| SOH-Start of heading | DLE-Data link escape | FF-Form feed |
| STX-Start of text | DC1-DC-4 - Device controls | CR-Carriage return |
| ETX-End of text | NAK- Negative acknowledge | SO-Shift out |
| EOT-End of transmission | SYN-Synchronize | |

Front Panel Controls

The CM-2 has two rows of 8 bit switches each. See figure AIII-7. S1 through S8 of row 1 are used to program character 1, while S1 through S8 of row 2 program character 2. Each switch selects the mark or space output state of its associated bit.

DIGITAL DATA DISTORTION TEST SET, USM-329(V)

This section describes the purpose and functions of the Digital Data Distortion Test Set, AN/USM-329(V). This equipment, in most locations, has been replaced by the DIGITECH-2002 Digital Data Test Set.

Table AIII-8.—EBCDIC Code

B I T S	b1 → b2 → b3 → b4 →				0	0	0	0	0	0	0	0	1	1	1	1	1	1	1	1	
	b5	b6	b7	b8	0	1	0	1	0	1	0	1	0	1	0	1	0	1	0		
	COLUMN →				0	1	2	3	4	5	6	7	8	9	10	11	12	13	14	15	
	ROW ↓				0	1	2	3	4	5	6	7	8	9	10	11	12	13	14	15	
	0	0	0	0	0	NUL	DEL	DS		SP	&	-									0
	0	0	0	1	1	SOH	DC1	SOS			/		a	j			A	J			1
	0	0	1	0	2	STX	DC2	FS	SYN				b	k	s		B	K	S		2
	0	0	1	1	3	ITX	DC3						c	l	t		C	L	T		3
	0	1	0	0	4	PF	RES	BYP	PN				d	m	u		D	M	U		4
	0	1	0	1	5	HT	NL	LF	RS				e	n	v		E	N	V		5
	0	1	1	0	6	LC	BS	ETB	UC				f	o	w		F	O	W		6
	0	1	1	1	7	DEL	IL	ESC	EOT				g	p	x		G	P	X		7
	1	0	0	0	8		CAN						h	q	y		H	Q	Y		8
	1	0	0	1	9		EM						i	r	z		I	R	Z		9
	1	0	1	0	10	SMM	CC	SM	ç	!											
	1	0	1	1	11	VT			.	\$	#										
	1	1	0	0	12	FF	IFS		DC4	<	*	%	@								
	1	1	0	1	13	CR	IGS	ENQ	NAK	()	-									
	1	1	1	0	14	SO	IRS	ACK		+	;	=									
	1	1	1	1	15	SI	IUS	BEL	SUB		?	"									

LEGEND

1 = MARK

0 = SPACE

SI SHIFT IN
 SMM START OF MANUAL MESSAGE
 DLE DATA LINK ESCAPE
 DC1 DEVICE CONTROL
 DC2 DEVICE CONTROL
 DC3 DEVICE CONTROL
 DC4 DEVICE CONTROL
 NAK NEGATIVE ACKNOWLEDGE
 SYN SYNCHRONOUS
 CAN CANCEL
 EM END OF MEDIUM
 SUB SUBSTITUTE
 IGS INFORMATION GROUP SEPARATOR

IRS INFORMATION RECORD SEPARATOR
 IUS INFORMATION UNIT SEPARATOR
 IFS INFORMATION FIELD SEPARATOR
 NUL NULL
 PF PUNCH OFF
 HT HORIZONTAL TABULATION
 LC LOWER CASE
 DEL DELETE
 RES RESTORE
 NL NEW LINE
 BS BACKSPACE
 IL IDLE
 CC CURSOR CONTROL

DS Dt
 DS DIGIT SELECT
 SOS START OF SIGNIFICANCE
 FS FIELD SEPARATOR
 BYP BY PASS
 LF LINE FEED
 EOB/ END OF BLOCK/or
 ETB END OF TRANSMISSION BLOCK
 PRE PREFIX
 SM SET MODE
 PN PUNCH OUT
 RS READER STOP
 UC UPPER CASE

EOT END OF TRANSMISSION
 SP SPACE
 SOH START OF HEADING
 STX START OF TEXT
 ETX END OF TEXT
 ACK ACKNOWLEDGE
 BEL BELL
 VT VERTICAL TABULATION
 FF FORM FEED
 CR CARRIAGE RETURN
 SO SHIFT OUT
 ENQ ENQUIRY
 NA NOT ASSIGNED

Table AIII-9.—International Telegraph Alphabet No. 2, American Version (Baudot)

CHARACTERS			S T A R T	1	2	3	4	5	S T O P	CCITT NO. 2 UPPER CASE *
LOWER CASE	UPPER CASE COMM	WEATHER								
A	-	↑		█	█				█	
B	?	⊕		█					█	
C	:	○			█				█	
D	\$	/		█					█	WRU
E	3	3							█	
F	!	→		█					█	UNASSIGNED
G	8	↘			█				█	UNASSIGNED
H	STOP	↓							█	UNASSIGNED
I	8	8			█				█	
J	'	/		█					█	AUDIBLE SIGNAL
K	(←			█				█	
L)	↖							█	
M	.	.							█	
N	.	⊖							█	
O	9	9							█	
P	0	0			█				█	
Q	l	l		█					█	
R	4	4							█	
S	BELL	BELL		█					█	' (APOSTROPHE)
T	5	5							█	
U	7	7		█					█	
V	;	⊙							█	=
W	2	2							█	
X	/	/		█					█	
Y	6	6							█	
Z	"	+		█					█	+
BLANK		-							█	
SPACE									█	
CAR. RET.									█	
LINE FEED									█	
FIGURES				█					█	
LETTERS				█					█	

NOTE: UPPER CASE H (COMM) MAY BE STOP OR #

This Column Shows
Only Those Characters
Which Differ From
The U.S.A. Variation

 MARKING PULSE

 SPACING PULSE

Table AIII-10.—Extended Binary Coded Decimal (EBCD Correspondence)

b7-c	X	X	X	X	X	X	X	X	X	X	X	X	X	X	X	X	X	X	
b6-1	0	1	0	1	0	1	0	1	0	1	0	1	0	1	0	1	0	1	
b5-2	0	0	1	1	0	0	1	1	0	0	1	1	0	0	1	1	0	0	
b4-4	0	0	0	0	1	1	1	1	1	0	0	0	0	1	1	1	1	1	
b3-8	0	0	0	0	0	0	0	0	0	1	1	1	1	1	1	1	1	1	
BITS	b2 A	b1 B	COLUMN ROW	1	2	3	4	5	6	7	8	9	10	11	12	13	14	15	16
	0	0	1	SP	+/(@	#	%	&	¢	*	\$)	Z	(PN	RS	UC	EOT
	0	1	2	o	!	M	.	v	"	R	I	A	O	S	W	RES	NL	BS	IL
	1	0	3	T	X	N	U	E	D	K	C	L	H	B	BY	LF	EOB	PRE	
	1	1	4	J	G	+ =	F	P	;	Q	(?	Y	-	PF	HT	LC	DEL	

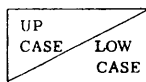

LEGEND
 1 = MARK
 0 = SPACE

b7 = PARITY CHECK BIT
 (x may be "1" or "0"
 depending on parity)

- PN PUNCH ON
- BY BYPASS
- RES RESTORE
- PF PUNCH OFF
- RS READER STOP
- LF LINE FEED
- NL NEW LINE (Carrier Return and line feed)
- HT HORIZONTAL TAB
- UC UPPER CASE
- EOB END OF BLOCK
- BS BACK SPACE
- LC LOWER CASE
- EOT END OF TRANSMISSION
- PRE PREFIX
- IL IDLE
- DEL DELETE

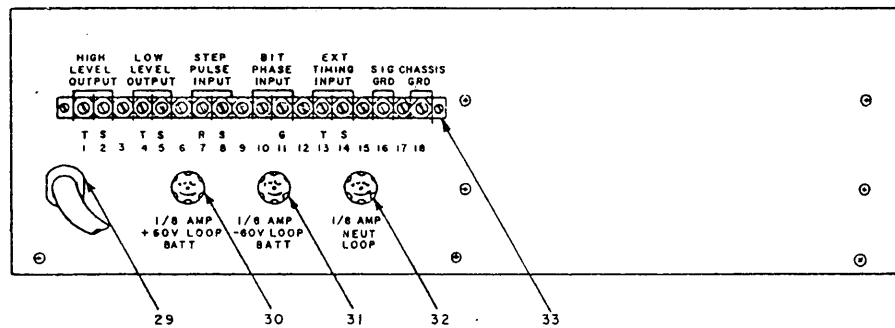
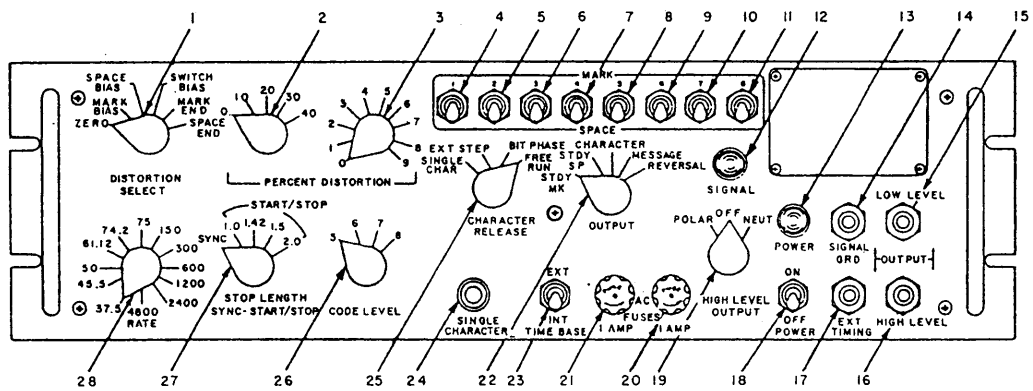

Figure AIII-8.—Signal Generator, Digital Data Distortion Set, AN/USM-329(V).

SIGNAL GENERATOR CHARACTERISTICS

The controls and indicators of the signal generator are shown in figure AIII-8. They are indexed in table AIII-11.

Power is applied to the generator by the POWER switch. Be sure that the POWER lamp goes on when the switch is set to its ON position.

The operation of the signal generator is largely dependent on the type of signal desired. The signal, in turn, is determined by the settings of the generator front panel controls. The front panel

controls, and their functional relationship to the output signal, are shown in figure AIII-9. The diagram is divided into four parts as follows:

1. Select signal pattern
2. Select signal characteristics
3. Select distortion
4. Select output

(NOTE: The implied sequence and left-to-right flow shown in figure AIII-9 is for illustrative purposes only. It does not represent signal flow. The controls may be set in any sequence desired by the operator.)

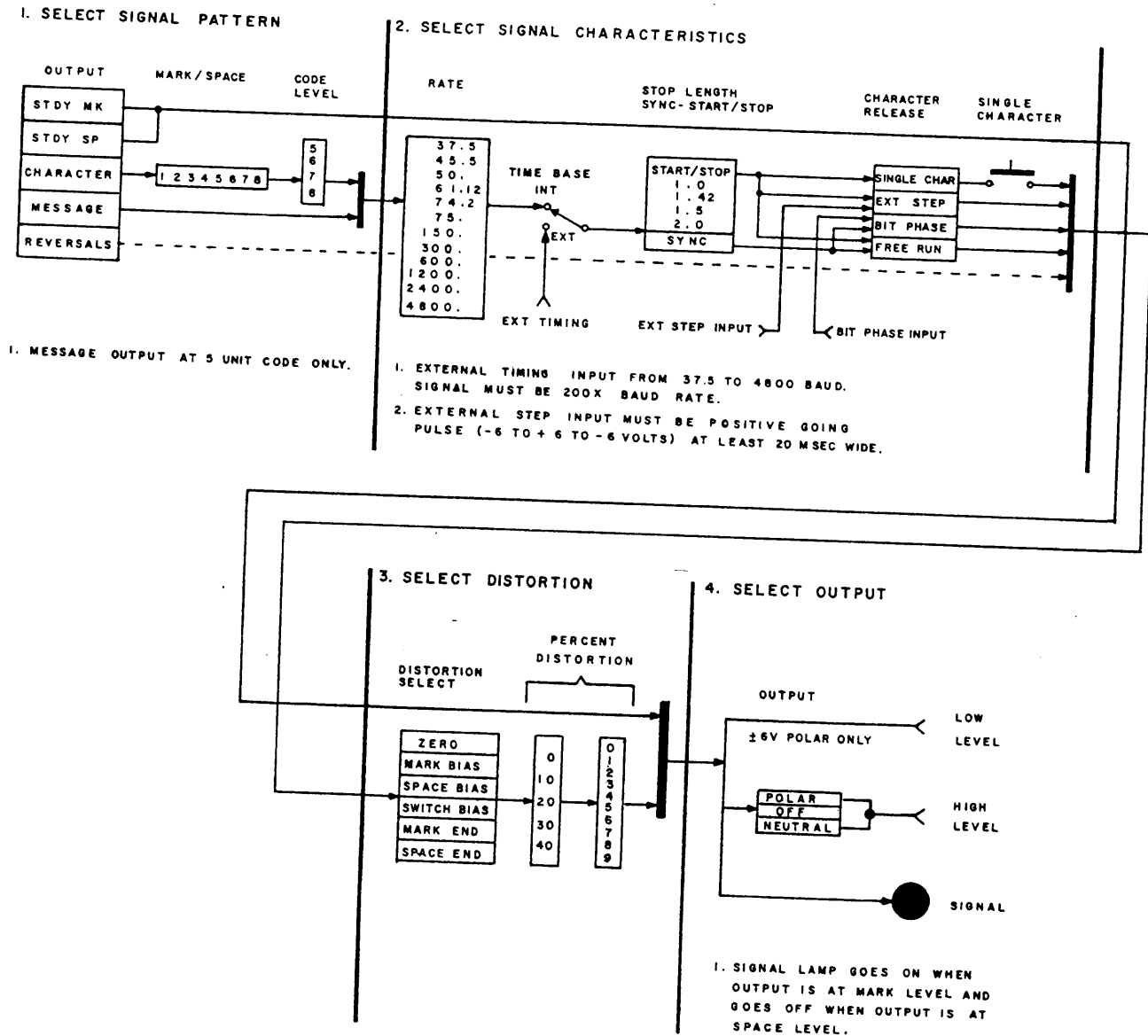

Figure AIII-9.—Functional operation of the AN/USM-329(V) Signal Generator.

Table AIII-11.—Controls and Indicators for the AN/USM-329(V) Signal Generator (Shown in Figure AIII-8)

FIGURE A3-7 INDEX NO.	CONTROL OR INDICATOR	FUNCTION
1	DISTORTION SELECT Switch	Selects type of distortion of output test signal
2	PERCENT DISTORTION Switch (TENS)	Selects percent distortion in output test signal in units of 0, 10, 20, 30, and 40
3	PERCENT DISTORTION Switch (UNITS)	Selects percent distortion in output test signal in units from 0 to 9
4	MARK/SPACE 1 Switch	One of a set of 8 switches. Sets first digit to mark (up) or space (down)
5	MARK/SPACE 2 Switch	Sets second digit to mark or space
6	MARK/SPACE 3 Switch	Sets third digit to mark or space
7	MARK/SPACE 4 Switch	Sets fourth digit to mark or space
8	MARK/SPACE 5 Switch	Sets fifth digit to mark or space
9	MARK/SPACE 6 Switch	Sets sixth digit to mark or space
10	MARK/SPACE 7 Switch	Sets seventh digit to mark or space
11	MARK/SPACE 8 Switch	Sets eighth digit to mark or space
12	SIGNAL Indicator Lamp	Illuminates to show presence and type of signal: glows steadily for steady mark, remains off for steady space and blinks for keying signal.
13	POWER Indicator Lamp	Illuminates when ac power is applied to the signal generator
14	SIGNAL GRD Jack	Connector signal ground
15	OUTPUT - LOW LEVEL Jack	Connector for low level output signals
16	OUTPUT - HIGH LEVEL Jack	Connector for high level output signal
17	EXT TIMING Jack	Input connector for external timing signal
18	POWER Switch	Ac power switch for signal generator

Table AIII-11.—Controls and Indicators for the AN/USM-329(V) Signal Generator (Shown in Figure AIII-8)
(continued)

FIGURE A3-7 INDEX NO.	CONTROL OR INDICATOR	FUNCTION
19	HIGH LEVEL OUTPUT Switch	3-position selector switch that selects either polar or neutral signal circuits
20	AC FUSES - 1 AMP Fuse	1-ampere 250-volt fuse connected to one side of input power line
21	AC FUSES - 1 AMP Fuse	1-ampere 250-volt fuse connected to one side of input power line
22	OUTPUT Selector Switch	Selects type of output signal. In STDY MK, the output consists of a continuous mark signal. In STDY SP, the output consists of a continuous space signal. In CHARACTER, the output consists of the 5- to 8-unit character selected on the MARK/SPACE switches. In MESSAGE, the output consists of the Fox message. In REVERSALS 1:1, the output consists of alternate marks and spaces
23	TIME BASE Switch	Selects either the internal or external timing signal
24	SINGLE CHARACTER Pushbutton Switch	Operates in conjunction with CHARACTER RELEASE switch set to SINGLE CHAR position
25	CHARACTER RELEASE Switch	Selects character release operating mode. In SINGLE CHAR, the output is released as single characters each time the SINGLE CHARACTER switch is pressed. In EXT STEP, the output is released when a step signal is applied to the external step input connector. In BIT PHASE, the internal timing reference is synchronized with an external timing reference. In FREE RUN, the output signal is continuous
26	CODE LEVEL Switch	Selects 5-, 6-, 7-, or 8-unit code levels in conjunction with the MARK/SPACE toggle switches

Table AIII-11.—Controls and Indicators for the AN/USM-329(V) Signal Generator (Shown in Figure AIII-8)
(continued)

FIGURE A3-7 INDEX NO.	CONTROL OR INDICATOR	FUNCTION
27	SYNC-START/STOP Switch (STOP LENGTH)	Selects synchronous or start/stop mode. Also selects stop length in start/stop mode
28	RATE Switch	Selects baud rate from 37.5 to 4800 of internal time base
29	Power line cord	Applies 115 volts 60 Hz power to the unit.
30	+60V LOOP BATT fuse	Fuses +60V loop battery line.
31	-60V LOOP BATT fuse	Fuses -60V loop battery line
32	NEUT LOOP fuse	Fuses neutral loop
33	Terminal Block TB1	Provides input and output terminations.

Select Signal Pattern

The OUTPUT switch selects the type of signal pattern. As shown in figure AIII-9, selection of the Steady Mark (STDY MK) or Steady Space (STDY SP) signal routes these signals directly to the output circuit. Selection of CHARACTER involves the MARK/SPACE switches, which must be set to the desired character, and the CODE LEVEL switch, which must be set to the desired unit level. The MESSAGE position selects the "FOX" message signal pattern, which is available in the 5-unit code. The REVERSALS position selects the mark-to-space-to-mark reversal pattern.

Select Signal Characteristics

Five switches are involved in setting the general characteristics of the output signal: RATE, TIME BASE, STOP LENGTH SYNC-START/STOP, CHARACTER RELEASE, and SINGLE CHARACTER.

The RATE switch sets the baud rate of the signal. The TIME BASE switch selects either the internal timing generator or an external timing signal connected to the EXT TIMING connector.

The STOP LENGTH SYNC-START/STOP switch selects either synchronous or start/stop operation, with the following four CHARACTER RELEASE options on the method of signal transmission:

1. In the SINGLE CHAR position, a start/stop signal is released one character at a time each time the SINGLE CHAR switch is pressed.

2. In the EXT STEP position, a start/stop signal is released one character at a time each time an external step input is applied to the external stop input terminals located on the rear panel of the signal generator.

3. In the BIT PHASE position, a synchronous signal is phase-locked with an external bit-phase timing signal to ensure that the signal generator output is synchronized with the timing generator in the receiving unit.

4. In the FREE RUN position, the signal (synchronous and start/stop) is released continuously without interruption.

The SINGLE CHARACTER switch releases only one character at a time.

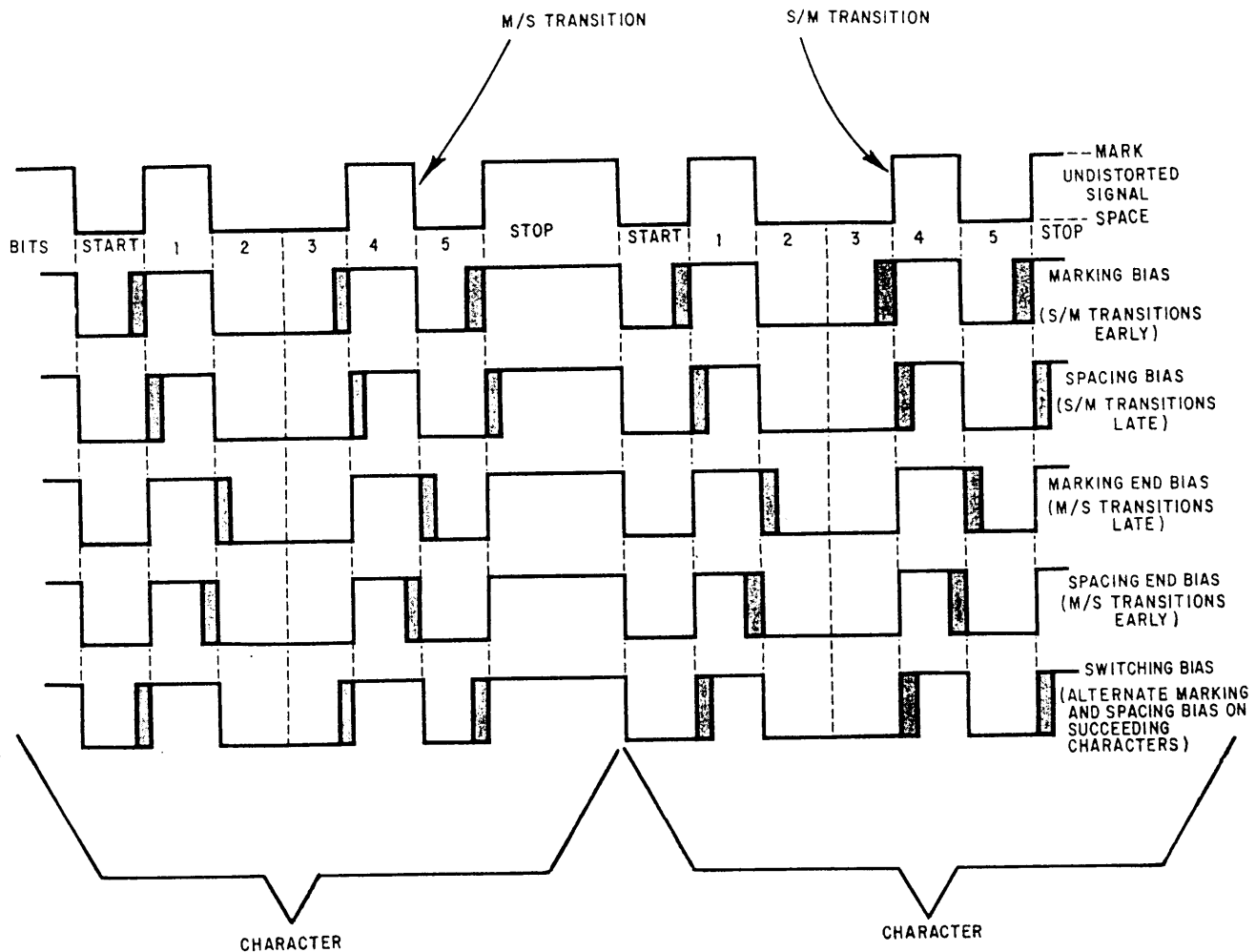

NOTE: SHADED AREAS SHOW DISTORTION (APPROXIMATELY 25%)

31.177

Figure AIII-10.—Examples of telegraph distortion.

Select Distortion

The amount and type of distortion are selected on three switches. The DISTORTION SELECT switch selects one of five types of distortion: MARK BIAS, SPACE BIAS, SWITCH BIAS, MARK END, and SPACE END. Refer to figure AIII-10 for examples of these distortions. The amount of distortion is selected on the two PERCENT DISTORTION switches, which set the amount in tens and units.

Select Output

The signal generator provides both high- and low-level outputs. The LOW-LEVEL jack provides a low-level polar output at 6 volts established

by an internal power supply. Use this jack and the corresponding terminals at the rear of the signal generator for low-level polar output connections. For high-level polar and neutral signals, use the HIGH-LEVEL jack. With the HIGH-LEVEL OUTPUT switch in the POLAR position, the output signal available at the HIGH-LEVEL jack is a 60-volt polar signal (negative mark). The same signal is also available at the corresponding high-level terminals at the rear of the signal generator. With the HIGH-LEVEL OUTPUT switch in the NEUTRAL position, the output signal drives an electronic switch (closed for mark) connected to the HIGH-LEVEL jack. This jack and the corresponding terminals at the rear of the signal generator should be used

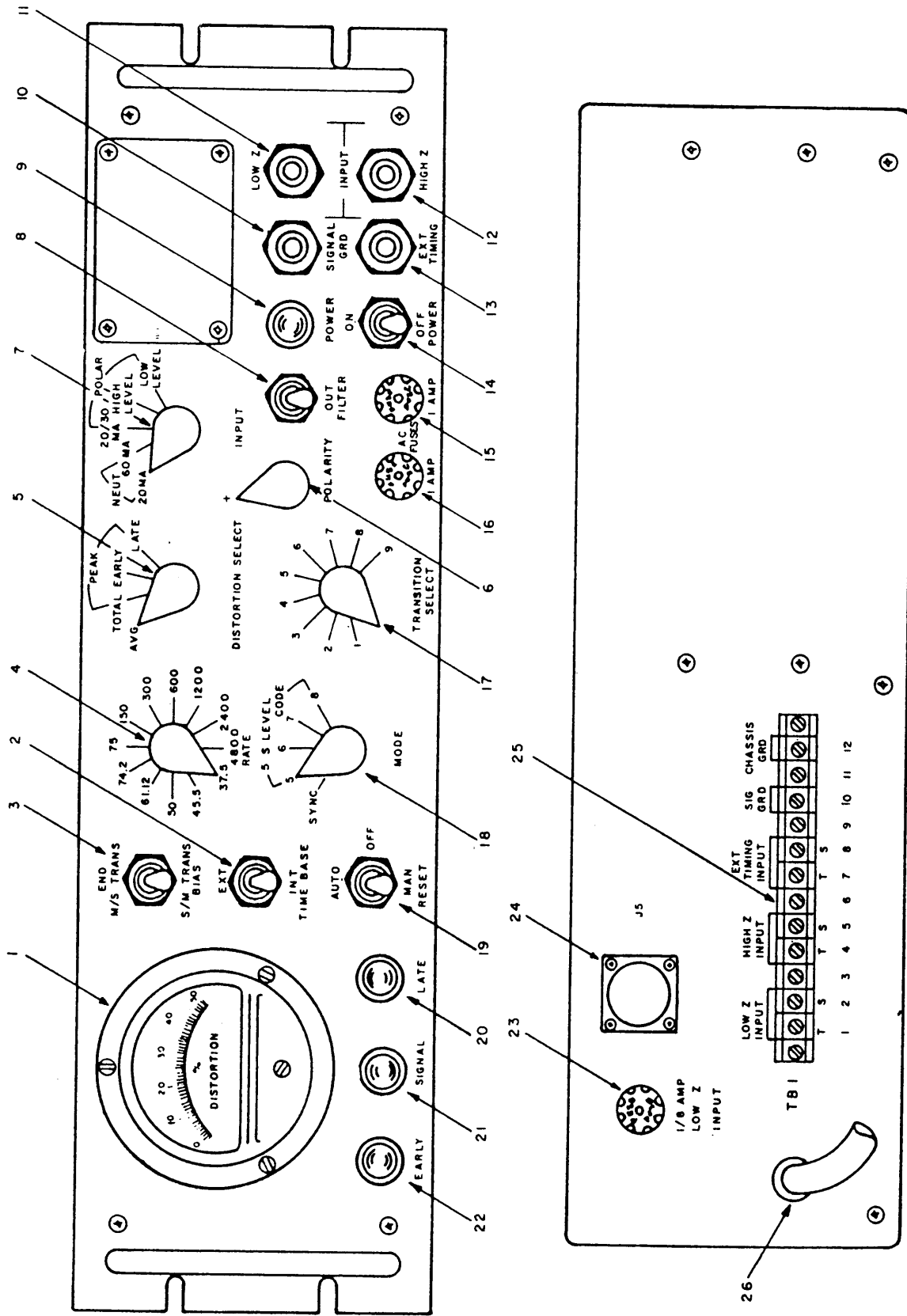

Figure AIII-11.—Analyzer for the AN/US (000(V)).

for all neutral outputs and high-level polar outputs.

The SIGNAL lamp goes on whenever the output of the signal generator is at the mark level, and goes off whenever the signal is at the space level. Therefore, for a steady mark signal, the lamp glows steadily; for a steady space signal, the lamp remains off; for keying signals, the lamp blinks on and off.

Operating Precautions

The following summary of operating precautions and general information is provided for use by the operator.

The EXT TIMING input signal must be 200 times the desired baud rate. The external timing input must be a square wave having an amplitude of 6 volts.

The EXT STEP input signal must be a 12-volt, positive-going pulse (-6 to +6 to -6 volts) at least 20 milliseconds wide.

The EXT BIT-PHASE input signal must be a square wave having an amplitude of 6 volts.

WARNING:

Observe the following precaution when connecting the signal generator to the

signal loop to prevent voltage from appearing on the test cable tip and presenting a shock hazard.

Polar outputs: Connect the test cable to the signal loop before connecting the test cable to the signal generator (the generator provides loop voltage).

Neutral outputs: Connect the test cable to the signal generator before connecting the test cable to the signal loop (the station provides loop voltage).

Operator Maintenance

There is very little maintenance required by the operator. It is limited to replacement of the lamps and fuses in the signal generator.

ANALYZER AND OSCILLOSCOPE PROCEDURES IN DISTORTION ANALYSIS AND MEASUREMENT

The following procedures and instructions apply to both the analyzer and the oscilloscope. If the analyzer is used without the oscilloscope, the instructions that apply to the oscilloscope may be disregarded. Separate operation of the oscilloscope is not recommended. The controls and indicators for the analyzer and oscilloscope are shown in figures AIII-11 and AIII-12. They are indexed in tables AIII-12 and AIII-13.

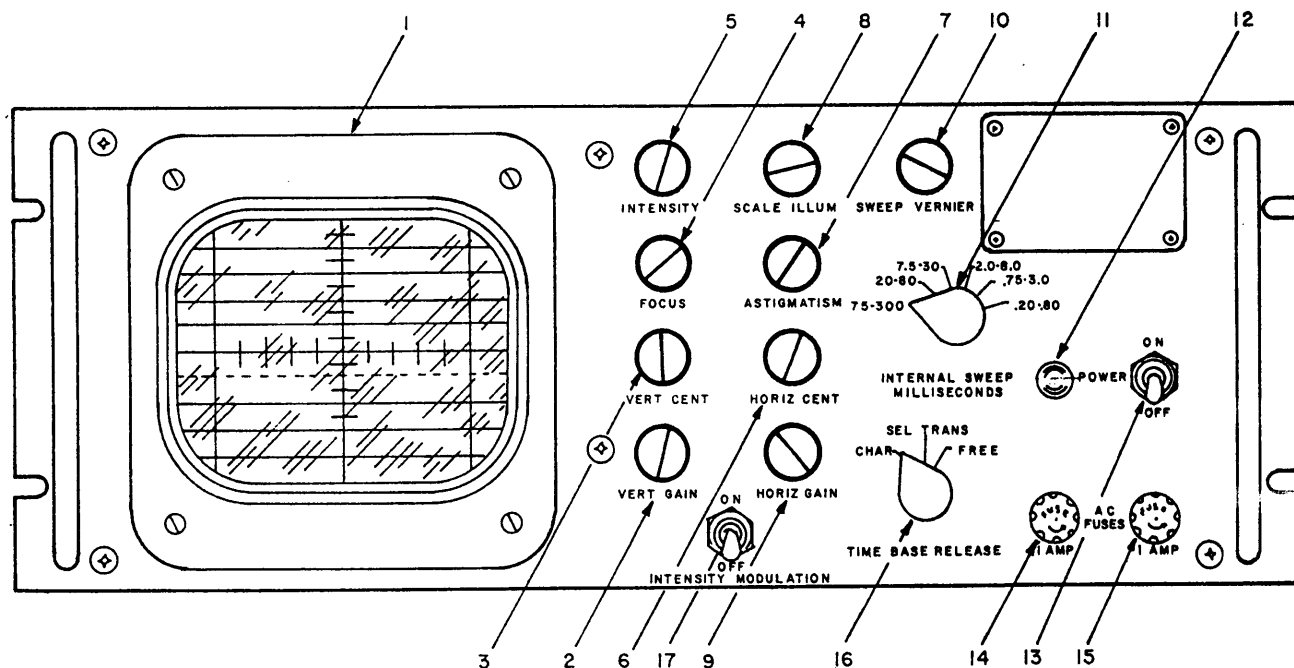

Figure AIII-12.—Oscilloscope for the AN/USM-329(V).

Table AIII-12.—Controls and Indicators for the AN/USM-329(V) Analyzer (Shown in Figure AIII-11)

FIGURE A 3-11 INDEX NO.	CONTROL OR INDICATOR	FUNCTION
1	% DISTORTION Meter	Measures percentage distortion from 0 to 50 in 1% increments
2	TIME BASE Switch	Selects either external or internal time base. The external timing signal is connected through EXT TIMING jack
3	END M/S TRANS-S/M TRANS BIAS Switch (M/S- S/M Switch)	Selects either mark-to-space or space-to-mark transitions for analysis of end distortion and bias distortion, respectively
4	RATE Switch	Selects baud rate from 37.5 to 4800 of internal time base
5	DISTORTION SELECT Switch	Selects type of distortion (average or peak) for analysis. Also selects total, early, and late for peak distortion measurements
6	POLARITY Switch	Reverses polarity of input signal
7	INPUT Switch	Selects either polar or neutral input circuits. The two neutral positions are current inputs at 20 and 60 ma, respectively. The 20-30 ma position is the polar current input and the high and low level polar positions are the high and low voltage inputs, respectively
8	FILTER Switch	Connects filter used to remove spikes and holes in input waveform. Usable up to 150 baud
9	POWER Indicator Lamp	Illuminates when ac power is applied to the analyzer
10	SIGNAL GRD Jack	Connector for signal ground ,
11	INPUT - LOW Z Jack	Input connector for current signals
12	INPUT - HIGH Z Jack	Input connector for all voltage signals
13	EXT TIMING Jack	Input connector for all external timing signals.

Table AIII-12.—Controls and Indicators for the AN/USM-329(V) Analyzer (Shown in Figure AIII-11) (continued)

FIGURE A3-11 INDEX NO.	CONTROL OR INDICATOR	FUNCTION
14	POWER Switch	Ac power switch for analyzer
15	AC FUSES - 1 AMP Fuse	1-ampere 250-volt fuse connected to one side of input power line
16	AC FUSES - 1 AMP Fuse	1-ampere 250-volt fuse connected to one side of input power line
17	TRANSITION SELECT Switch	Selects either all or 1 of 9 specific transitions for analysis and display
18	MODE Switch	Selects synchronous or start/stop mode. Also selects 5-, 6-, 7-, or 8- unit codes.
19	RESET Switch	Selects automatic or manual reset of output meter. Center position is off
20	LATE Indicator Lamp	Illuminates during average distortion measurements to indicate marking end and spacing bias distortion
21	SIGNAL Indicator Lamp	Illuminates to show presence and type of signal. Glows steadily for steady mark, remains off for steady space, and blinks for keying signal
22	EARLY Indicator Lamp	Illuminates when making average distortion measurement to indicate marking bias or spacing end distortion
23	LOW Z INPUT fuse	Fuses low impedance input line
24	J5 connector	Connector for Analyzer to Oscilloscope cable.
25	TB1 terminal board	Provides connection for input signals
26	Input power cable	Provides for connection of input power

Table AIII-13.—Controls and Indicators for the AN/USM-329(V) Oscilloscope (Shown in Figure AIII-12)

FIGURE A3-12 INDEX NO.	CONTROL OR INDICATOR	FUNCTION
1	Cathode Ray Tube (CRT)	Displays digital waveforms
2	VERT GAIN Control	Controls height of trace on CRT
3	VERT CENT Control	Controls vertical position of trace on CRT
4	FOCUS Control	Adjusts focus (spot size) of electron beam
5	INTENSITY Control	Adjusts intensity of trace on CRT
6	HORIZ CENT Control	Controls horizontal position of trace on CRT
7	ASTIGMATISM Control	Adjusts astigmatism (spot shape) of electron beam
8	SCALE ILLUMINATION Control	Controls illumination of engraved scale (graticule)
9	HORIZ GAIN Control	Controls width of trace on CRT
10	SWEEP VERNIER Control	Fine adjustment control of internal sweep oscillator
11	INTERNAL SWEEP MILLI-SECONDS Switch	Selects one of six sweep ranges
12	POWER Indicator Lamp	Illuminates when ac power is applied to the oscilloscope
13	POWER Switch	Ac power switch for oscilloscope
14	AC FUSES - 1 AMP Fuse	1-ampere 250 volt fuse connected on one side of input line
15	AC FUSES - 1 AMP Fuse	1-ampere 250 volt fuse connected on one side of input line
16	TIME BASE RELEASE Switch	Selects synchronizing signal for oscilloscope sweep. In CHAR, the oscilloscope sweep is triggered for each character. In SEL TRANS, the sweep is triggered for separate transitions as measured on the analyzer. In FREE, no trigger is applied. The CHAR and SEL TRANS signals are applied to the oscilloscope from the analyzer.
17	INTENSITY MODULATION Switch	Connects intensity modulating signal from analyzer to Z-axis input of oscilloscope

Operating Procedures

To turn on the analyzer and oscilloscope units, perform the following procedures:

1. Set the POWER switch on the analyzer to ON. Be sure that the POWER lamp is on.
2. Set the analyzer controls as follows:
 - a. MODE switch to the type of signal to be measured.
 - b. RATE switch to the rate of signal to be measured.
 - c. POLARITY switch to the polarity sense of signal to be measured.
 - d. RESET switch to OFF.
 - e. FILTER switch to OUT.
 - f. TIME BASE switch to INT.

(NOTE: If external timing is to be used in lieu of the internal time base generator within the analyzer, connect the external signal to EXT TIMING jack, and set TIME BASE switch to EXT.)

3. Set the POWER switch on the oscilloscope to ON. Be sure that the POWER lamp is on.
4. Adjust the following oscilloscope controls, as required, to obtain a clean, centrally positioned trace on the oscilloscope CRT:
 - a. INTENSITY
 - b. SCALE ILLUM
 - c. FOCUS
 - d. ASTIGMATISM
 - e. VERT CENT
 - f. HORIZ CENT
 - g. HORIZ GAIN
5. Set the oscilloscope controls to the initial settings:
 - a. VERT GAIN to midposition.
 - b. INTENSITY MODULATION to OFF.
 - c. INTERNAL SWEEP MILLISECONDS to the approximate rate of signal to be measured.
 - d. SWEEP VERNIER to midposition.
 - e. TIME BASE RELEASE to CHAR.
6. Set the analyzer INPUT switch to the required position.

(CAUTION: Always connect the test cable to the analyzer before connecting the test cable to the signal loop.)

7. Connect the analyzer to the signal loop as follows:
 - a. For current signals, connect the analyzer in series, using the LOW Z INPUT jack.
 - b. For voltage signals, connect the analyzer across the loop, using the HIGH Z INPUT jack.
8. Check the SIGNAL lamp on the analyzer and verify that:
 - a. For steady mark signal, the lamp glows steadily.
 - b. For steady space signal, the lamp remains off.
 - c. For keying signal, the lamp blinks on (for marks) and off (for spaces).
9. Verify the presence of the signal on the oscilloscope's CRT. Adjust the oscilloscope controls for the best presentation of the waveform.

Bias Distortion Measurement

Bias distortion is the average displacement of the space-to-mark transition from its normal position, referred to as the *start mark-to-space transition*. The distortion is called *marking bias* if the transition occurs early; it is called *spacing bias* if the transition occurs late. The analyzer measures the average bias distortion for the overall signal and also for signal transitions (in start/stop signals). Measure bias distortion as follows:

1. Perform the turn-on procedures.
2. Set the analyzer controls as follows:
 - a. TRANSITION SELECT to ALL (or to selected transitions).
 - b. DISTORTION SELECT to AVG.
 - c. M/S TRANS—S/M TRANS to S/M.
3. Observe % DISTORTION meter and EARLY, LATE, and SIGNAL lamps for the following:
 - a. % DISTORTION meter: indicates amount of average distortion.
 - b. EARLY lamp: if on, indicates mark bias distortion.
 - c. LATE lamp: if on, indicates space bias distortion.
 - d. SIGNAL lamp: if blinking, indicates that signal is keying.

End Distortion Measurement

End distortion is the average displacement of the mark-to-space transition from its normal position, referred to as the *start mark-to-space transition*. The distortion is called *spacing end distortion* if the mark-to-space transition is early. It is called *marking end* if the transition is late. The analyzer measures the average end distortion for the overall signal and also for single transitions (in start/stop signals). Measure end distortion as follows:

1. Perform the turn-on procedures.
2. Set the analyzer controls as follows:
 - a. TRANSITION SELECT to ALL (or selected transition).
 - b. DISTORTION SELECT to AVG.
 - c. M/S TRANS—S/M TRANS to M/S.
3. Observe % DISTORTION meter and EARLY, LATE, and SIGNAL lamps for the following:
 - a. % DISTORTION meter: indicates amount of average distortion.
 - b. EARLY lamp: if on, indicates spacing end distortion.
 - c. LATE lamp: if on, indicates marking end distortion.
 - d. SIGNAL lamp: if blinking, indicates that signal is keying.

Peak Distortion Measurement

Total peak distortion is the highest amount of distortion that occurs on a signal during a given period of time. The distortion may occur on mark-to-space transitions or on space-to-mark transitions, and it may occur either early or late. The analyzer measures the total peak distortion, early peak distortion (both M/S and S/M), and late peak distortion (M/S and S/M).

(NOTE: The percent distortion shown on the % DISTORTION meter represents the peak value obtained during the measuring period. The meter displays the peak reading indefinitely until the distortion changes to a higher value, or until the meter is reset to 0 by the RESET switch. The RESET switch offers two options: manual reset mode, in which the momentary switch must be manually pressed down to reset the meter; and the automatic reset mode, in which the analyzer continuously resets the meter at 5-second intervals.)

Total Peak Measurement

Measure the total peak distortion as follows:

1. Perform the turn-on procedures.
2. Set the analyzer controls as follows:
 - a. TRANSITION SELECT to ALL (or to selected transition).
 - b. DISTORTION SELECT to TOTAL.
 - c. RESET to AUTO, if automatic reset feature is desired; otherwise, set switch to OFF.
 - d. M/S TRANS—S/M TRANS to either M/S or S/M, depending upon the type of transition to be measured. Set to S/M to measure marking bias; set to M/S to measure spacing end.
3. Observe % DISTORTION meter and SIGNAL lamp for the following:
 - a. % DISTORTION meter: indicates peak value of marking bias and spacing end distortion for S/M or M/S transitions.
 - b. SIGNAL lamp: blinks to indicate that signal is keying.

Late Peak Distortion

Measure the late peak distortion (peak marking end and peak spacing bias) as follows:

1. Perform the turn-on procedures.
2. Set the analyzer controls as follows:
 - a. TRANSITION SELECT to ALL (or to selected transition).
 - b. DISTORTION SELECT to LATE.
 - c. RESET to AUTO, if automatic reset feature is desired; otherwise, set switch to OFF.
 - d. Set M/S TRANS—S/M TRANS to either M/S or S/M, depending upon the type of transition to be measured. Set to M/S for marking end and to S/M for spacing bias.
3. Observe % DISTORTION meter and SIGNAL lamp for the following:
 - a. % DISTORTION meter: indicates peak value end and spacing bias distortion for M/S or S/M transitions.
 - b. SIGNAL lamp: blinks to indicate that signal is keying.

Operating Precautions

The following summary of operating precautions and general information is provided for use by the operator:

The input filter of the analyzer is usable only up to modulation rates of 150 baud. Set the FILTER switch to the OUT position when operating the analyzer above 150 baud.

The external timing input signal to the analyzer must be 200 times the desired baud rate. The external timing signal must be a square wave with an amplitude of 6 volts.

The LOW Z connector is used when measuring current signals.

The HIGH Z connector is used when measuring voltage signals.

- The test cable is always connected to the analyzer before connecting the cable to the signal loop.

Operator Maintenance

There is very little maintenance required by the operator. It is limited to replacement of the lamps and fuses in the signal generator.



APPENDIX IV

OPERATING PROCEDURES OF THE TIME-DIVISION MULTIPLEXER TERMINAL, SMC-200 AND THE TIMEPLEX TIME-DIVISION MULTIPLEXING TERMINALS, T16/20

TIME-DIVISION MULTIPLEX TERMINAL, SMC-200

The SMC-200 is a general-purpose multiplexer that operates in the synchronous mode, using the time-division multiplexing principle. This appendix describes the general operating procedures of the SMC-200. Individual station procedures may differ somewhat from those presented in this text; however, this appendix may be used for information purposes.

INDICATORS AND CONTROLS

To aid controllers in troubleshooting any problems, the SMC-200 has various controls and visual indicators. All are accessible by opening the front panel. The following paragraphs give explanations of these controls and indicators.

Front Panel Indicators and Controls

The below-listed controls are on the front panel of the SMC-200:

POWER LAMP: Indicates that primary power has been applied to the unit.

TEST LAMP: Indicates that the unit is in the test condition. It lights when the

TEST OVERRIDE switch on the HS card is in the ON position.

● **SYNC LAMP (LOCAL & REMOTE):** Indicates that the unit is out of sync and no data is being sent or received on the high-speed line, when the lamp is on, and that only sync bits are being transferred. When the LOCAL lamp is on, it indicates that the local SMC-200 receive is out of sync. When the REMOTE lamp is on, it indicates that the remote SMC-200 receive is out of sync.

● **CARRIER FAILURE (HS):** Indicates that the no-carrier signal is being received from the modem associated with the high-speed line, when the lamp is on. The no-carrier signals do not inhibit the operation of the SMC-200. (Normally, these lamps are biased to a +12-volt supply to prevent their lighting.)

● **CARRIER FAILURE (LS):** Indicates that the no carrier detects that a signal is being received from any modem associated with any of the low-speed channels, when the lamp is on. (Normally, these lamps are biased to a +12-volt supply to prevent their lighting.)

● **RESET PUSHBUTTON:** Resets all error circuits, counters, and indicators. In addition,

it resets the error data on the card labeled CL and the phasor error lamps on cards labeled HS, IM, and IS.

Logic Card Indicators and Controls

The following describes the indicators and controls mounted on the individual logic card. Undesignated switch positions are:

<u>SWITCH HANDLE POSITION</u>	<u>DESIGNATION</u>
Right	Off or 0
Left	On or 1
Center	On (momentary switches)
Right or Left	On (momentary switches)

HIGH-SPEED LOGIC CONTROL (HIGH-SPEED CARD)

These switches are used with the controls mounted on the per-channel input/output cards. The indicator lamps monitor the condition of the high-speed line. The individual controls are described in the following sections.

DATA RECEIVE Lamp

The DATA RECEIVE lamp monitors the high-speed data being received by the SMC-200 from the high-speed modem as follows:

- OFF: MARK line condition.
- ON: SPACE line condition.

DATA SEND Lamp

The DATA SEND lamp monitors the high-speed data being sent from the SMC-200 to the high-speed modem for line transmission as follows:

- OFF: MARK line condition.
- ON: SPACE line condition.

ERROR PHASOR Lamp

When the ERROR PHASOR lamp is on, it indicates that an error has been detected in the relationship of the data and the clock. The lamp is turned OFF by depressing the RESET pushbutton on the front panel.

OVERRIDE Switch

When the OVERRIDE switch is on, it places the SMC-200 in a test mode. This switch lights the TEST lamp on the control panel and enables test controls on all cards to activate. This includes the TEST CHARACTER/BUS-BACK switch and the SEND-RECEIVE/LOW-SPEED—HIGH-SPEED switch on the HS card.

TEST CHARACTER/BUS-BACK (TC/BB) Switch

The TEST CHARACTER position allows the SMC-200 to generate a test character to be injected into any channel or line selected for testing. The SMC-200 will automatically monitor this test character for correct logic operation. Since only a single test character detector exists, only a single per-channel card should be placed in the test character mode at any one time. (The switch is used with the SEND-RECEIVE/LOW-SPEED—HIGH-SPEED switch, which selects whether the test character is injected into the SEND or RECEIVE logic.)

SEND-RECEIVE/LOW-SPEED—HIGH-SPEED Switch (SEND (S) Position)

In the SEND position, this switch injects a test character into the SEND logic of a selected per-channel card. Simultaneously, the TEST CHARACTER detector (of the CL card) is connected to monitor the output of the per-channel SEND logic. During the test, the line from the common HIGH-SPEED RECEIVE logic to the LOW-SPEED SEND is “opened” to prevent data mixing. Detected errors will light the common ERROR DATA lamp on the CL card. The lamp can be reset by the RESET pushbutton on the front control panel. (Error simulation is performed by turning on the DATA ERROR switch on the II card, which alters the test pattern of the test character generators.)

SEND-RECEIVE/LOW-SPEED—HIGH-SPEED Switch (RECEIVE (R) Position)

In the RECEIVE position, this switch injects a test character into the RECEIVE logic of selected per-channel card. Simultaneously, the TEST CHARACTER detector (CL card) is connected

to monitor the output of the per-channel SEND logic. The channel tested must be looped at the HIGH-SPEED common logic, the HIGH-SPEED modem, or at the remote end on a per-channel basis by use of the BUS-BACK switch. The LOW-SPEED RECEIVE channel is "opened" to prevent data mixing during the test. Detected errors will light the common ERROR DATA lamp on the CL card. The lamp can be reset by the RESET pushbutton on the front control panel. (Error simulation is performed by turning on the DATA ERROR switch located on the II card, which alters the test patterns of the test character generators.)

BUS-BACK Position

The BUS-BACK position allows loop-back capabilities of SMC-200 channels. It is used with the SEND-RECEIVE/LOW-SPEED—HIGH-SPEED switch.

SEND-RECEIVE/LOW-SPEED— HIGH-SPEED Switch (HIGH-SPEED (H) Position)

In the HIGH-SPEED position, this switch busses or loops back the line to the remote SMC-200 at the high-speed side of the selected low-speed channel card. Simultaneously, the low-speed line of the selected channel card is bussed back by connecting the output of the RECEIVE logic to the input of the SEND logic on the per-channel input/output cards. The LOW-SPEED SEND and RECEIVE logic is included in the low-speed looped line, as shown during the test. (The test character at the remote SMC-200 can be injected into this channel for a system test.) Some or all channels within a system can be bussed back simultaneously without interference.

SEND-RECEIVE/LOW-SPEED Switch (LOW-SPEED (L) Position)

This position busses back the SEND and RECEIVE logic at the low-speed side of the selected low-speed channel card. Simultaneously, the low-speed line of the selected channel card is bussed back to the local terminal. All per-channel logic is within the loop. (The test character at the remote unit can be injected into this channel during a total channel test.) Some or all channels can be bussed back simultaneously without interference.

PHASOR RESET Switch

The PHASOR RESET switch is a momentary toggle switch that allows manual resetting of the HIGH-SPEED PHASOR. Resetting the phasor places it at its optimum operating position.

- OFF: Normal operation.
- ON: Reset phasor.

HIGH-SPEED CLOCK GENERATOR (CL Card)

The controls on the CL card are used with the controls on the HS card, the II card, and the per-channel input/output cards.

- TEST SWITCH:

- OFF: Normal operation.
- ON: High-speed bussed back at HIGH-SPEED channel.

During the bus-back condition, the HIGH-SPEED SEND output is looped back to the HIGH-SPEED RECEIVE input at the logic level side of the line drivers and line detectors. No looping is required on the high-speed line. The TEST OVERRIDE switch on the HS card must be in the ON position to respond to the TEST switch on the CL card. The CL card TEST switch is used during per-channel test character tests.

- ERROR DATA LAMP:

- OFF: Turn this lamp off by depressing the RESET pushbutton on the control panel.
- ON: The test character detector has detected an error. The lamp is used with the switches on the HS card and the per-line channel cards.

INPUT/OUTPUT SYNC Monitor (II Card)

This is the first of the 32 data channels. Though it is normally only used to process SMC-200 synchronization bits, it can also be used for terminal data processing.

- TEST SWITCH:

- OFF: Normal operation
- ON: Test mode operation

The TEST switch is used when the II card is functioning as an INPUT/OUTPUT card (terminal data processor, in addition to its sync-monitoring function). To respond to this TEST switch, the TEST OVERRIDE switch of the HS card must be turned to the ON position. When these conditions are met, the channel can be tested by injecting TEST CHARACTER to LOW-SPEED RECEIVE and by testing the user and remote terminals. The test to be performed is selected on the HS card.

- **DATA RECEIVE (R) LAMP:** This lamp monitors the output data from this channel card to the low-speed terminal.

OFF: MARK line condition.
ON: SPACE line condition.

- **DATA SEND (S) LAMP:** This lamp monitors the input data to the II card.

OFF: MARK line condition.
ON: SPACE line condition.

- **ERROR GENERATOR DATA (D) SWITCH (Momentary):** This switch in the ON condition causes all internal test character generators (located on per-channel input/output cards) to generate an error test character. Any channel selected for test will have the error test character injected into its LOW-SPEED SEND or RECEIVE logic. Injected errors light the ERROR DATA lamp on the CL card.

OFF: Normal operation.
ON: Generate error test character.

- **ERROR COUNT LAMPS 20, 21, AND 22:** These lamps count the synchronizing errors in binary form on the HIGH-SPEED RECEIVE channel. The lamp ON condition corresponds to a "1" count. All lamps are cleared by depressing the RESET pushbutton on the front panel. Once set, the 22 lamp remains ON until it is cleared. Setting the BIT/SYNC switch determines the type of synchronizing errors counted.

- **ERROR COUNT SWITCH SYNC (S) POSITION:** The error counter is advanced each time the SMC-200 goes out of sync.

- **ERROR COUNT SWITCH BIT (B) POSITION:** The error counter is advanced each time an incorrect sync bit is received. Five sync

bits must be missed before an out-of-sync condition occurs.

- **ERROR GENERATOR SYNC (S) SWITCH (Momentary):** The sync characters are output on the HIGH-SPEED SEND line and cause the remote unit to go out of sync during normal operations. It can also cause the local unit to go out of sync when in high-speed, loop-back operation.

OFF: Normal operation.
ON: Generates error sync character.

- **RESYNCHRONIZATION SWITCH (SYNC) (Momentary):** This switch is used on systems not designed for automatic resynchronization.

OFF: Normal operation.
ON: Initiates RESYNC cycle. If an Automatic Delay Compensator (ADC) is associated with the SMC-200, the automatic sync feature may or may not be enabled. If disabled, the operator must do the following to regain sync:

1. Switch the ADC to manual mode, when applicable.
2. Zeroize/clear the buffer on the ADC.
3. Manually sync the SMC-200 by momentarily depressing the SYNC switch until sync is reestablished.
4. Switch the ADC to automatic mode, when applicable, and reset buffers and alarms.

INPUT/OUTPUT Modem (IM Card)

This card has the following controls and indicators:

- **TEST SWITCH:**

OFF: Normal operation.
ON: Test mode operation.

To respond to the TEST switch, the TEST OVERRIDE switch must be turned to the ON position. When these conditions are met, the channel can be tested by:

1. Injecting TEST CHARACTER to LOW-SPEED SEND.
2. Injecting TEST CHARACTER to LOW-SPEED RECEIVE.

3. LOW-SPEED BUS-BACK.
4. HIGH-SPEED BUS-BACK.

The test to be performed is selected on the HS card.

DATA RECEIVE (R) LAMP: This lamp monitors the data output by this card to the low-speed channel. (It is the data received from the high-speed line.)

OFF: MARK line condition.
ON: SPACE line condition.

DATA SEND (S) LAMP: This lamp monitors the data input to this card from the low-speed channel. (This data is sent by the high-speed line.)

OFF: MARK line condition.
ON: SPACE line condition.

CARRIER LAMP:

OFF: The carrier is being detected by the modem associated with this channel.

ON: The carrier is not being detected by the modem associated with this channel. (This lamp is normally biased in an OFF condition.)

PHASOR ERROR (R) LAMP:

OFF: No phasor-detected error.

ON: A RECEIVE phasor error has been detected.

The lamp is turned OFF by depressing the RESET pushbutton on the control panel. The RECEIVE PHASOR (R) lamp monitors errors associated with the DATA SEND (S) lamp.

**INPUT/OUTPUT SMOOTHING
Card (IS Card)**

This card has the following controls and indicators:

TEST SWITCH: To respond to this TEST switch, the TEST OVERRIDE switch must be turned to the ON position.

OFF: Normal operation.
ON: Test mode operation.

When these conditions are met, the channel can be tested by:

1. Injecting test characters to LOW-SPEED SEND.
2. Injecting test characters to LOW-SPEED RECEIVE.
3. LOW-SPEED BUS-BACK.
4. HIGH-SPEED BUS-BACK.

The test to be performed is selected on the HS card.

● **DATA RECEIVED (R) LAMP:** This lamp monitors the data output by this card to the low-speed channel. (Data is received from the high-speed line.)

OFF: MARK line condition.
ON: SPACE line condition.

● **DATA SEND (S) LAMP:** This lamp monitors the data input to this card from the low-speed channel. (This data is sent by the high-speed line.)

● **CARRIER LAMP:**

OFF: The carrier is being detected by the modem associated with this channel.

ON: The carrier is not being detected by the modem associated with this channel. (Normally, this lamp has been biased permanently to an OFF condition.)

● **PHASOR ERROR LAMP, RECEIVE (R):** This lamp is turned off by depressing the RESET pushbutton on the control panel.

OFF: No phasor-detected error.
ON: A RECEIVE phasor error has been detected.

● **PHASOR ERROR LAMP, SEND (S):** This lamp is turned off by depressing the RESET pushbutton on the control panel.

OFF: No phasor-detected error.
ON: A SEND phasor error has been detected.

INPUT/OUTPUT TERMINAL Card

This card has the following controls and indicators:

- **TEST SWITCH:** To gain response from this switch, the TEST OVERRIDE switch must be in the ON position.

OFF: Normal operation.

ON: Test mode operation. The channel can be tested by:

1. Injecting TEST CHARACTER to LOW-SPEED RECEIVE.
2. Injecting TEST CHARACTER to LOW-SPEED SEND.
3. LOW-SPEED BUS-BACK.
4. HIGH-SPEED BUS-BACK.

The test to be performed is selected on the HS card.

- **DATA RECEIVE (R) LAMP:** This lamp monitors the data output from this card to the low-speed channel. (This data is received from the high-speed line.)

OFF: MARK line condition.

ON: SPACE line condition.

- **DATA SEND (S) LAMP:** This lamp monitors the data input to this card from the low-speed channel. (This data is sent by the high-speed line.)

SMC-200 COMMON CONTROL CARDS

An operational SMC-200 has four common control cards and one or more per-channel input/output cards. Cards are mounted in three card nests within the SMC-200, with the common control cards centrally located. Channel cards 2 through 13 occupy nest A; common control cards and channel cards 14 through 20 occupy nest B (card II, type 4, the SYNC MONITOR card, is also the channel 1 card); and channel cards 21 through 32 occupy nest C.

SYSTEM CLOCKING

Low-speed synchronous channels to be multiplexed into the aggregate, high-speed, synchronous-channel data stream use low-speed channel clocks, derived by dividing a single clock

frequency within a system. These low-speed clocks are submultiples of the system clock and, as such, assure that the total data on the high-speed channel is the sum of the low-speed rates. Mixing of rates is performed efficiently by servicing high rates more frequently than slower ones within a system. After the division, all of the clocks generated will differ in phase; no two clocks within a system will sample or transmit data simultaneously.

Low-speed channels in systems using the SMC-200 operate in bit synchronism; that is, all low-speed clocks are generated from a single clock frequency within a system. This system clock can be the internal clock from a master modem or from an ultra-stable station clock.

Master Modem Clock

A master modem clock is a modem using an internally supplied send clock in the form of a stable station clock. (A slave modem is a modem using the derived receive clock as the modem's external send clock.) The send clocks for all low-speed channel modems are generated by dividing the high-speed clock down to the required frequency. The low-speed receive clocks are the derived modem receive clocks that have the same frequencies as the initial send clock. When using the clock of the master modem as the system clock, this modem clock must have sufficient accuracy and stability for operating the low-speed modems interfaced to the SMC-200.

Terminal Clocking

The terminal receive clock and send clock are both supplied by the SMC-200 which, in effect, makes the terminal receive and send data rates dependent on the SMC-200. It is this dependency that makes it possible for the SMC-200 to steal synchronizing bits from a terminal channel, while simultaneously handling data. (This feature cannot be used with modems.)

SYNCHRONIZATION

Synchronization is achieved by using part of one of the slowest speed data channels within a system. During out-of-sync conditions, fast resynchronization is assured by placing only the synchronizing pattern onto the high-speed line. Synchronizing is based on the bit formats of the high-speed scan cycle and the sync frame. The *high-speed scan cycle* is the number of bits

between the synchronizing channel bits within a frame. The *sync frame* is the number of bits between the sync characters. The out-of-sync condition is determined by a missed sync character counter, which increments by one for each incorrectly received sync bit. If the counter attains a count of five, an out-of-sync condition is assumed and resynchronizing is initiated. Upon detecting the correct sync format, the missed sync counter is reset.

PHASOR OPERATION

Low- and high-speed channels that interface modems have phasors to compensate for phase shift, transmission delays, and doppler shifts in the receive data streams. These phasors buffer several bits of data for each receive channel and allow data to be clocked in and out of the buffer by the receive clock and the internal SMC-200 clock, respectively. In this manner, slight timing changes caused by the transmission media will not cause loss of data. Should radical timing changes occur, causing a buffer to overflow or to become empty, the phasor is automatically reset to its optimum operating position.

MULTIPLEXING DATA ONTO A HIGH-SPEED CHANNEL

Received data from low-speed channels (modems or terminals) is clocked into the phasor buffers, where it is temporarily stored until it is clocked onto the high-speed send line by the proper phase of the divided-down system clock. Since the division is such that no two low-speed clocks are ever in phase, each low-speed bit will occupy unique positions within the aggregate high-speed bit stream. These bits correspond to channels that are identified by their position in relation to the synchronizing bits.

DEMULTIPLEXING A HIGH-SPEED CHANNEL

Data arriving on the high-speed receive channel is distributed to the proper low-speed send channel by the divided-down system clock. Channel identification is performed on the basis of the bit position in relation to the synchronizing bits of the data frame. A high-speed receive phasor is used to compensate for phase shift,

transmission delays, and doppler shifts in the high-speed receive data.

HALF-DUPLEX OPERATION

Half-duplex operation is a mode of operation in which received data enters an SMC-200 under control of an independent modem-derived receive clock. The modem-derived receive clock runs at the speed of the remote modem-generated clock and is not derived from the SMC-200 system clock. In this mode of operation, it is assumed that the derived receive clock does not drift too far (in relation to the SMC-200 system clock) so as to cause errors during the period of data transmission. If a card is programmed for half-duplex operation, it will be alternately switched between an idle or OFF state and a data transfer or ON state. When the unit is in the OFF state, its phasor is constantly being set to its optimum position. The unit will switch from the OFF to the ON state when the carrier detector lead from the modem goes ON, and a voltage transition is detected on the received data lead from the modem. This unit will switch from an ON to an OFF state when the carrier detector lead from the modem goes OFF.

Data transmission operates in both directions. For sending data, a modem external send clock is supplied by the SMC-200. The half-duplex mode of operation is used in application where the remote modem cannot use its derived receive clock as the external send clock and, therefore, uses its own internal clock for sending.

TIMEPLEXERS, T16/20

Timeplexers are general-purpose, time-division multiplexing systems enabling transmission of large numbers of low-speed, asynchronous, synchronous, and isochronous channel data over a single, dedicated, full-duplex voice or high-speed circuit. They interface with data sets, computers, and terminal equipment. They may be used in both analog and digital communications systems.

INDICATORS AND CONTROLS

Timeplexers are made up of both high- and low-speed control cards. These cards have specific indicators and controls, which will be defined in the following paragraphs.

High-Speed Control Cards

The following indicators and controls are on the high-speed control cards:

- **OUT-OF-SYNC LAMP:** Lights if the local timeplexer is out of synchronization (out of sync).

- **REMOTE OUT-OF-SYNC LAMP:** Lights if the remote timeplexer is out of sync and the local unit is in sync. The lamp may be lit or unlit if both units are out of sync.

- **CARRIER OFF LAMP:** Lights if there is no carrier signal present on the transmission facility. (The lamp is normally biased with +12 volts and should always be off.)

- **HS LOOPBACK SWITCH:** (1) Loops the output data for test purposes, when in the ON position. (2) Transmits the data from the local timeplexer to the remote timeplexer, when in the OFF position.

- **OUT-OF-SYNC TEST PUSHBUTTON SWITCH:** (1) Alters the high-speed send sync pattern to test the synchronizing logic in the local or remote timeplexer, when in the ON position. (NOTE: Data interruption occurs during this test.) (2) Transmits the normal sync pattern, when in the OFF position.

- **HS SEND DATA LAMP:** Indicates the high-speed send line activity; the ON state indicates line spacing.

- **HS RECEIVE DATA LAMP:** Indicates the high-speed receive line activity; the ON state indicates line spacing.

Low-Speed Control Cards

The following indicators and controls are on the low-speed cards.

- **HARDWARE ALARM LAMP:** Lights with the TEST CHAR ERROR lamp when enabled through the common alarm logic.

TEST CHAR ERROR LAMP: Lights if low-speed logic malfunctions are detected by a continuously circulating test character, which is

generated when a channel card LOOPBACK switch is set to TEST.

- **CHAR GEN TEST PUSHBUTTON SWITCH:** Forces a test character error to test the error indicating logic.

Modem Card (Type MN, Revs. A and B)

When set to the ON position, this loopback switch loops the high-speed send line to the high-speed receive line for test purposes.

Modem Card (Type MN, Revs. C and D)

This card has the following indications and controls:

- **LOOP TEST LAMP:** Lights when the card is in the local loopback state.

- **REMOTE LOOP LAMP:** Lights when the card is in the remote loopback state.

- **REMOTE LOOP/LOCAL LOOP SWITCH:** (1) Causes the remote modem to loop its digital send data to its receive data (on the timeplexer side), so that both the modems and the line can be tested by an operator at either end, when in the REMOTE LOOP position. (NOTE: The remote loopback feature is inoperative on MN cards, Revs. C and D.) (2) Loops the high-speed analog send line to the high-speed analog receive line for test purposes, when in the LOCAL LOOP position.

Modem Card (Type MP, Revs. C and D)

This card has the following indicators and controls:

- **256 LAMP:** Lights and remains lit after the 256 parity errors have been detected in receive data characters.

- **LAMPS 16, 8, 4, 2, AND 1:** Indicate, in binary code, the number of parity errors detected in the receive data characters.

- **LOOP TEST LAMP:** Lights when the card is in the local loopback state.

REMOTE LOOP LAMP: Lights when the card is in the remote loopback state.

PARITY SWITCH: Selects either the high- or low-speed parity mode. The RST position resets the parity counter and extinguishes all error lamps.

REMOTE LOOP/LOCAL LOOP SWITCH: (1) Causes the remote modem to loop its digital send data to its receive data (on the timeplexer side), so that both the modems and the line between can be tested by an operator at either end, when in the REMOTE LOOP position. (NOTE: The remote loopback feature is inoperative on MP Cards, Revs. C and D.) (2) Loops the high-speed analog send line to the high-speed analog receive line for test purposes, when in the LOCAL LOOP position.

Modem Interface Card (Type EP)

This card has the following indicators and controls:

256 LAMP: Lights and remains lit after 256 parity errors have been detected in the receive data characters.

LAMPS 8, 4, 2, AND 1: Indicate, in binary code, the number of parity errors detected in the receive data characters.

PARITY SWITCH: Selects either the high- or low-speed parity mode. The RST position resets the parity counter and extinguishes all error lamps.

Synchronous Channel Cards (Types AD and M-AD)

These cards have the following indicators:

SEND DATA LAMP: Indicates the line status; when the lamp is on, indicates spacing.

RCV DATA LAMP: Indicates the line status; when the lamp is on, indicates spacing.

Asynchronous Channel Card (Type AL)

This card has the following indicators and controls:

SEND DATA LAMP: Indicates the line status; when the lamp is on, indicates spacing.

● **RCV DATA LAMP:** Indicates the line status; when the lamp is on, indicates spacing.

LOOP LAMP: Lights when the loopback is accomplished.

● **LOOPBACK SWITCH:** Initiates the following:

1. **TEST POSITION:** Circulates a low-speed test character through the timeplexer. This test character is checked for errors. If an error exists, the TEST CHAR ERROR lamp on the low-speed control card will light. It also causes the send function 3 (busy out) to come on, and may be used to busy out a local modem. Digital data from a terminal will be looped back to that terminal.

2. **REMOTE POSITION:** Loops the corresponding channel card at the remote digital interface toward the originator. Outputs the send function 3 (busy out) at the remote location and causes the incoming data from a terminal or modem attached to this remote interface to be looped back onto itself.

3. **OFF POSITION:** Permits normal card operations.

Asynchronous Channel Cards (Types AC, CP, ACC, AS, and ACS)

These cards have the following indicators and controls:

● **SEND DATA LAMP:** Indicates the line status; when the lamp is on, indicates spacing.

● **RCV DATA LAMP:** Indicates the line status; when the lamp is on, indicates spacing.

● **SEND/RCV F1, F2, AND F3 LAMPS:** Indicates the status of the control signals; when the lamp is on, indicates function on (positive).

● **REMOTE LOOP LAMP:** Indicates the remote terminal is in the loopback state.

● **LOOPBACK SWITCH:** Initiates the following:

1. **TEST POSITION:** Circulates a low-speed test character through the timeplexer. This test is checked for errors. If an error exists, the TEST CHAR ERROR lamp on the low-speed control card will light. It also causes the send

function 3 to come on, and may be used to busy out a local modem. Digital data from a terminal will be looped back to that terminal.

2. **REMOTE POSITION:** Loops the corresponding channel card at the remote digital interface toward the originator. Outputs the send function 3 (busy out) at the remote location and causes incoming data from a terminal or modem attached to this remote interface to be looped back onto itself.

3. **OFF POSITION:** Permits normal card operation.

Asynchronous Channel Card (Type ACM)

This card has the following indicators and controls:

- **SEND DATA LAMP:** Indicates the line status; when the lamp is on, indicates the transmitting space frequency (analog).

- **RCV DATA LAMP:** Indicates the line status; when the lamp is on, indicates the receiving space frequency (analog).

- **DTR LAMP:** Indicates the data terminal ready to answer a call.

- **DSR LAMP:** Indicates the data set ready to begin transmission.

- **RTS LAMP:** Indicates the data terminal desired to transmit (request to send).

- **CTS LAMP:** Indicates the modem ready for transmission (clear to send).

- **OH LAMP:** Indicates that the terminal has answered a call and is off the hook.

- **RI/CD LAMP:** (1) Indicates the ring indicator, when the DSR lamp is in the OFF position. (2) Indicates the receive carrier, when the DSR lamp is in the ON position.

- **REMOTE LOOP LAMP:** Indicates that the remote multiplexed channel has been successfully looped back.

- **LOOPBACK SWITCH:** Initiates the following:

1. **TEST POSITION:** Circulates a low-speed test character through the timeplexer. This

test character is checked for errors. If an error exists, the TEST CHAR ERROR lamp on the low-speed control card will light. It also causes send function 3 to come on, and may be used to busy out a local modem. Digital data from a terminal will be looped back to the terminal. (NOTE: When the ACM card is looped by a remote channel card, the ACM card goes off the hook and loops its analog transmitters to its receiver. In the ACM 1 card, the transmitter frequency is shifted, and the send filter is not included in the loopback path.)

2. **REMOTE POSITION:** Loops the corresponding channel card at the remote digital interface toward the originator. Outputs the send function 3 (busy out) at the remote location and causes incoming data from a terminal or modem attached to this remote interface to be looped back onto itself.

3. **OFF POSITION:** Permits normal card operation.

Current Loop Channel Card (Type CL)

This card has the following indicators and controls:

- **FUSE:** Protects the external power supply and each circuit. When blown, the yellow indicator appears at the bottom of the fuse.

- **SEND DATA LAMP:** Indicates the line status; when the lamp is on, indicates marking (up to revision level A cards); when the lamp is off, indicates spacing (starting with revision level B cards).

- **RCV DATA LAMP:** Indicates the line status.

- **REMOTE LOOP LAMP:** Lights when the LOOPBACK switch is set to the REMOTE position.

- **LOOPBACK SWITCH:** Initiates the following:

1. **TEST POSITION:** Circulates a low-speed test character through the timeplexer. This test character is checked for errors. If an error exists, the TEST CHAR ERROR lamp on the low-speed control card will light. The TEST position also causes the current loop line to be looped onto itself, so that a local terminal receives its own send data.

2. **REMOTE POSITION:** Loops the corresponding channel card in the remote timeplexer, both toward the remote terminal and toward the timeplexer.

3. **OFF POSITION:** Permits normal card operation.

Synchronous Channel Card (Type SE)

This card has the following indicators and controls:

SEND DATA LAMP: Indicates the line status; when the lamp is on, indicates spacing.

REC DATA LAMP: Indicates the line status; when the lamp is on, indicates spacing.

OFF-LINE LAMP: Lights when the LOOPBACK switch is set to the REMOTE position.

RCV F LAMP: Lights when the carrier is not received by the associated modem.

LOOPBACK SWITCH: Loops the demultiplexed send data back to the receive data line, and loops so that a remote synchronous terminal attached to a remote timeplexer can make loopback tests. Permits normal card operation in the OFF position.

Synchronous Channel Card (Type SC)

This card has the following indicators and controls:

SEND DATA LAMP: Indicates the line status; when the lamp is on, indicates spacing.

RCV DATA LAMP: Indicates the line status; when the lamp is on, indicates spacing.

SEND/RCV F1, F1, AND F3 LAMPS: Indicates the status of the control signals; when the lamp is on, indicates function on (positive).

● **CAR DET LAMP:** Lights when the carrier signal is present.

● **REMOTE LOOP LAMP:** Indicates that the remote channel card has been looped back successfully.

● **LOOPBACK SWITCH:** Loops the corresponding channel card in the remote timeplexer toward the originator, so that data and control signals can be sent through both multiplexers and the high-speed facility. If the card being looped at the remote end is attached to a modem, control function 3 is raised. Permits normal card operation when set to OFF.

Isochronous Channel Card (Type IS)

This card has the following indicators:

● **SEND DATA LAMP:** Indicates the line status; when the lamp is on, indicates spacing.

● **RCV DATA LAMP:** Indicates the line status; when the lamp is on, indicates spacing.

● **FAST-SEND CLOCK LAMP:** Indicates when the send clock is outputting data faster than normal.

● **SLOW-SEND CLOCK LAMP:** Indicates when the send clock is outputting data slower than normal.

● **CARRIER OFF LAMP:** Indicates when the carrier signal is not present.

APPENDIX V

OPERATING PROCEDURES OF THE HALCYON HC-520B2 UNIVERSAL TEST SYSTEM

INTRODUCTION

The HALCYON HC-520B2 Universal Test System is a multifunction instrument designed to measure the significant circuit parameters that affect voice band data transmission. This appendix will provide detailed information regarding the HC-520B2 equipment.

CONTROLS, INDICATORS, AND CONNECTORS

Controls, indicators, and connectors, and their functions, are discussed in the following paragraphs.

FRONT PANEL CONTROLS

The front panel controls are grouped into four categories: mode selection, receiver controls, transmitter controls, and display controls.

Mode Selection

The SELECT pushbuttons select the measure mode, automatically configure both the receiver and the transmitter, and position the LED cursor located adjacent to the following switches to which parameter is being measured:

1. **P/AR Mode (Peak-to-Average Ratio):** The transmitter generates a pulse train of known peak-to-average ratios through the system. The P/AR receiver measures the absolute peak and full-wave rectified average values of the pulse train and displays their ratios on a zero-suppressed scale.

2. **NOISE Mode:** A 1004-Hz tone is transmitted, and the receive signal is passed through a notched weighting network and is measured by

a quasi-rms-type detector. The noise power is displayed in dBm or dBm0. By depressing the S/N button, the 1010-Hz notch filter is disabled. This is used to evaluate the signal-to-noise ratio.

a. Either a C-MESSAGE or a 3-kHz FLAT weighting network may be selected by the third pushbutton switch.

b. The noise measurement may be referred directly to 0 TLP, rather than to test tone level, by means of the NOISE-TLP CORRECTION switch. The difference, usually 13 dB, is selected by a set of PC-mounted thumbwheels. In effect, this switch inserts 13 dB of loss in the receiver.

c. Idle line noise measurements may be made with the TRANSMIT FUNCTION switch in the QUIET position.

3. **PHASE JITTER Mode:** A 1004-Hz tone is transmitted, and peak-to-peak phase changes of the received holding tone distortion products are measured and displayed directly in degrees.

4. **NONLINEAR DISTORTION Mode:** Two tone pairs, centered at 860 Hz and 1380 Hz, are transmitted. The 2nd and 3rd order distortion products are measured and displayed as a ratio of the tone level.

a. Eight 2nd order products are measured in narrow bands centered at 520 Hz (B-A) and 2240 (B+A). Six 3rd order products are measured in a narrow band centered at 1000 Hz (2B-A).

b. The S/N switch removes the upper frequency tone pair and increases the level of the remaining pair by 3 dB. This feature is used to check the noise content in the measurement slots.

5. **DELAY Mode:** A modulated, variable frequency oscillator drives the transmitter, and the phase of the receive signal is compared to that of the transmitted signal. The relative phase (phase variation) between the reference

frequency and the measuring frequency is displayed in microseconds.

a. The REF pushbutton is used to zero-set the display reading at the reference frequency.

b. The normal damping state is LO; however, for noisy circuits, the DELAY DAMP switch may be set to HI for a steadier reading.

c. The SYNC control may be used to set the frequency of the local modulating signal to exactly coincide with that of the received signal to measure envelope delay on a two-wire line.

6. **REPEAT Mode:** The receiver demodulates the receive signal. It then uses this modulation envelope to remodulate the transmitted carrier. Level changes at the input will also be repeated back on the transmit level.

7. **HIT MEASUREMENTS Mode:** A 1004-Hz holding tone is transmitted and the receiver monitors the input signal for transient variations in gain, phase, impulse noise, and signal dropouts.

a. The START switch clears the hit counters and starts the timing cycle.

b. The counting period is controlled by a three-position toggle switch that is used to select 5 minutes, 15 minutes, or CONTINUOUS.

c. The transient thresholds are controlled by three sets of thumbwheels: GAIN hits may be set from $+/- 1$ dB to $+/- 6$ dB. PHASE hits may be set from 5 degrees to 45 degrees. IMPULSE noise may be set from 40 dBrn0 to 99 dBrn0.

Receiver Controls

The following paragraphs discuss the functions of the receiver controls:

1. **LEVEL IN Thumbwheel Switches:** Control the signal level presented to the receiver by means of a step attenuator. The value of this attenuation is indicated directly in dB. The level detector autoranges from +9.9 to -50 dB relative to this setting. The displayed value is also in terms relative to this setting.

2. **600 or 900 ohms Pushbutton:** Selects the impedance of the instrument. It controls both the transmitter source impedance and the calibration impedance of the receiver.

3. **TERM-BRDG Pushbutton:** Bridges or terminates the receiver.

4. **C-MSG/3-kHz Pushbutton:** Conditions the noise-measuring circuits and selects the noise-weighting network, which may be either a

C-MESSAGE or a 3-kHz FLAT. Both filters have a 1010-Hz notch (995 to 1025 Hz).

5. **NOISE-TLP CORRECTION Switch:** (Marked TLP REFERENCE on early models.) Conditions the noise reading, either corrected (dBrn0) or uncorrected (dBrn). To measure impulse noise correctly, this switch must be in the corrected (dBrn0) position.

Transmitter Controls

The following paragraphs discuss the uses of the transmitter controls:

1. **OSCILLATOR, 1004-Hz, and 4-TONE P/AR TRANSMIT—STATUS LEDs:** Controlled by the mode SELECT switch.

2. **LEVEL OUT Thumbwheel Switches:** Set the transmit signal. The maximum undistorted output of the transmitter is +9 dBm.

3. **MAN, AUTO, and SGL Switches:** Control the tuning method and allow manual tuning, automatic sweep, or single sweep. Tuning controls are effective in the AMPLITUDE RESPONSE, DELAY, and REPEAT modes.

4. **TUNE Control:** Manually adjusts the oscillator frequency to any value from 200 to 4000.

5. **CONT/SF Pushbutton:** Causes the transmitter to skip the frequency band 2450 to 2750 Hz.

6. **CONT/LOCK Switch:** Causes the tuning to lock to the nearest 1004-Hz increment.

7. **SWEEP RATE Control:** Adjusts the rate at which the VCO sweeps the transmitter across the band. This may be varied from approximately one sweep per 1.5 seconds to infinitely slow.

8. **83 1/3-25 Pushbutton:** Selects either of these for modulation frequency (DELAY and REPEAT modes).

9. **TRANSMIT FUNCTION Switch:** Modifies the normal function of the instrument to provide some special-purpose features:

a. **QUIET:** Disables the normal transmitter functions and provides a termination to the TRANSMIT line. The termination value is either 600 or 900 ohms, as selected by the impedance switch.

b. **TALK:** Allows the instrument to be used as a four-wire telephone. The HEADSET jack will be connected to the receive and transmit lines when this function is selected.

c. **DIAL/HOLD/XFR:** Permits use on two-wire, dial-up lines. In the DIAL position, the DIAL jack (310-wired T-R-S) is connected to the

transmit line. The transition from DIAL to HOLD is made by a make-before-break contact, and the dial jack is disconnected in this position. In the XFR position, the transmitter and receiver are interchanged behind the front panel jacks.

Display Controls

The following paragraphs discuss the display control functions:

1. **Measure Frequency:** Is displayed in the right (green) window, in Hz, and the value of the parameter being measured is displayed in the left (red) window.

2. **RCV/XMT Switch:** Selects the side to which the frequency counter is connected. An LED in the display window indicates which is selected. Two "Non-Valid Measurement" indicators are provided:

a. **OUT OF RANGE:** Illuminates when the signal being measured is of amplitude greater than can be measured accurately by the level detector. The input attenuator may be adjusted to reduce the level presented to the detector.

b. **1004-Hz LOST:** Flashes whenever a 1004-Hz mode has been selected and such a tone is not detected at the input.

3. **HIT MEASUREMENTS:** There are seven registers associated with these measurements. The contents of any one register may be displayed by positioning the illuminated cursor to the appropriate counter, using the pushbutton switch. The TIME LED will flash when counting is in progress.

REAR PANEL CONTROLS

The following paragraphs discuss the rear panel control and their uses.

1. **Monitor Speaker with Volume Control:** Located on the rear panel.

2. **RECEIVE IN/TRANSMIT OUT Jacks:** Banana-plug jacks that parallel the front panel jacks.

3. **NORM-EXPD Switch:** Increases the vertical deflection sensitivity from 5 dB per division to 2 dB per division.

4. **24-Pin Connector:** Remotes various functions to external display or counting devices. Connections provided are:

<u>FUNCTION</u>	<u>PIN</u>
Gain Hit	1
Phase Hit	2
Impulse	3
Impulse + 4	4
Impulse + 8	5
Dropout	6
Phase Jitter	10
Ground	12
Y-Axis	13
X-Axis	14
Ground	24

HALCYON 500B MAINFRAME CONTROLS

The 500B dual-memory, digital storage oscilloscope has, in addition to the normal oscilloscope controls, two controls to select memory function and the type of signal to be displayed. (VERTICAL and HORIZONTAL output jacks are provided on the rear panel to supply "X" and "Y" drives for remote displays.) The mainframe controls are:

1. **POWER Switch:** Controls the primary power supply.

2. **ILLUM Control:** Varies the graticule scale lighting.

3. **FOCUS and INTENSITY Controls:** Adjusts the CRT beam to the desired brightness and sharpness.

4. **MEMORY Switch:** Determines which memory is placed in operation.

5. **MODE Switch:** Combination function and display select switch used to determine how the incoming signal is processed and which signal is being displayed. The positions are:

a. **CLEAR:** This position establishes a baseline in the selected memory at the bottom line of the screen.

b. **LOAD:** The selected memory is loaded with the response signal from the instrument module.

c. **INPUT:** The input to the scope (response measurement) is presented directly on the screen.

d. **MEMORY:** The display is derived from the selected memory.

e. **INPUT and MEMORY:** The stored response curve in memory and the active input are displayed simultaneously.

f. **DYNAMIC:** Both A and B memories are displayed. The B memory is also updated continuously by the scope input signal.

SET-UP PROCEDURES

The following paragraphs give the steps in the set-up procedures:

1. Select correct operating voltage, 117 or 230 VAC, using switch located near power receptacle on rear panel of mainframe.

2. Connect power cord to receptacle and to ac line.

3. Turn power on, using switch on front panel of mainframe.

4. Connect the four-wire circuit to TRANSMIT and RECEIVE jacks, using 310-type plugs (front panel) or banana connectors (rear panel). A two-wire circuit should be connected to the TRANSMIT jack only. Similar test sets are required at either end of a circuit for most testing. The general operating procedure is as follows:

a. Select correct impedance (600 or 900 ohms).

b. Terminate receive line. Measurements may be made on a bridging basis if the line is terminated by another test set or device.

c. Set TRANSMIT FUNCTION switch to NORMAL, unless otherwise specified.

d. Select test to be made. The single set of controls configures both the transmitter and the receiver.

e. Adjust secondary controls, including filter selection, sweep rate, modulation, and so forth. If the circuit uses SF signaling, select SF.

f. Read parameter value. (NOTE: All measurements are made by using a signal level equal to data level: -13 dBm0.)

5. The correct levels are:

Data set, transmit port	0 dB
Test board, MOD IN	-29 dB
DEMOD OUT	-6 dB
Data set (subscriber receiver)	-16 dB

SELF-CHECK PROCEDURES

The following self-check procedures are intended to quickly determine the basic operating

condition of all measurement parameters of the 520B test set:

1. Connection:

a. Connect TRANSMIT to RECEIVE on the front panel, using a 310 patchcord, or

b. Connect TRANSMIT OUT to RECEIVE IN on the rear panel with banana connectors.

2. Initial control settings:

<u>TRANSMIT FUNCTION</u>	<u>NORM</u>
LEVEL OUT	00
LEVEL IN	00
600-900	600
TERM-BRDG	TERM
C-MSG-3-kHz	C-MSG
CONT-SF	CONT
83 1/3-25	83 1/3
CONT-LOCK	LOCK
AUTO-SGL-MAN	MAN
NORM-EXPD	NORM (BACK PANEL)
DISPLAY OFFSET	CAL (FULLY CLOCKWISE)
GAIN dB	1
PHASE DEG	05
IMPULSE dBm0	40
RCV-XMT	SELECT XMT
NOISE-TLP	dBm
CORRECTION	
5-15-CONT	15
SWEEP RATE	FULLY CLOCKWISE
DELAY DAMP	LO

3. Procedures

a. **Select AMP RESP dB:** Adjust TUNE to 1004 Hz on FREQ display. Level display should read 00.0 +/- .1 dB. Adjust LEVEL OUT to -10. Display should read -10 +/- .1 dB. Adjust LEVEL OUT to -20. Display should read 20.0 +/- .1 dB. Return LEVEL OUT to 00.

b. **CRT Display:** For units equipped with the 500B display system, set MODE switch on the 500B unit to CLEAR position momentarily to clear display and then to load position. Memories A, B, or A + B, may be selected. Adjust illumination, focus, and intensity, as required. The dot on the CRT should coincide with 0-dB line on graticule +/- .2 dB, with LEVEL OUT set to 00. Set LEVEL OUT to -10 dB. The dot on the CRT should be at -10 dB +/- .2 dB. Reset LEVEL OUT to 00.

c. **P/AR Mode:** Set LEVEL IN and LEVEL OUT to 00 and select P/AR mode. The P/AR LED should light and display should read $100 + / - 1$.

d. **NOISE Mode:** Select NOISE mode (TLP switch set to dB_{rn}), TRANSMIT function switch set on quiet, and LEVEL IN and LEVEL OUT switch set on 00. Digital display must read 10 dB_{rn} or less. Reset TRANSMIT function to NORMAL. Noise reading must be 39 dB_{rn} or less. Depress S/N switch. Reading must be 90 dB_{rn} or less.

e. **PHASE JITTER:** Select 0 JITTER and read less than .2 degrees.

f. **NONLINEAR DISTORTION:** Select NONLINEAR mode and select second with toggle switch. Reading must be -70 dB or lower. With toggle switch in third position, reading must be -75 dB or lower.

g. **ENVELOPE DELAY-SELECT DELAY:** Tune oscillator to 1800 Hz and depress S/N switch. Digital display should read 0000 microseconds $+ / - 5\%$.

TEST PROCEDURES

The following paragraphs explain test procedures to be used with the HALCYON HC-520B2 system.

CIRCUIT LOSS MEASUREMENT

Circuit loss is measured by transmitting a 1004-Hz tone at data level (or other specified level) and measuring the received signal with a level meter. The following procedures apply:

1. Control position check:
 - a. Circuit impedance, 600 ohms.
 - b. Receive line terminated.
 - c. TRANSMIT FUNCTION in NORM position.
 - d. DISPLAY OFFSET in CAL position.
2. Position for transmitting a 1004-Hz test signal:
 - a. Select AMP RESP; OSC LED will illuminate.
 - b. Adjust TUNE knob to obtain 1004 Hz on the (XMT) FREQ Hz display.
 - c. Set LEVEL OUT to test tone level (10 dB below TLP).
3. Procedure for measuring signal level:
 - a. Set LEVEL IN at expected receive level (10 dB below receive TLP).

- b. Read the circuit gain deviation directly in dB. The absolute receive level is equal to the LEVEL IN setting, plus the display reading.
- c. Read RECEIVE frequency and note any offset from the frequency transmitted at the distant end.
- d. On instruments equipped with the Signal Impairment Display (SID), check pattern closely and observe any distortion caused by line impairments.

P/AR MEASUREMENT (OPTION)

The P/AR measurement is designed to be sensitive to envelop delay distortion and gain bandwidth reduction. It is largely insensitive to the normal steady interferences or impairments on a channel, such as harmonic distortion, noise, and phase jitter. It is completely immune to the transient phenomena.

1. Control position check:
 - a. Circuit impedance, 600 ohms.
 - b. Receive line terminated.
 - c. TRANSMIT FUNCTION switch in NORM position.
2. Test procedure:
 - a. Select P/AR; the P/AR LED will illuminate.
 - b. Set LEVEL OUT at test tone level.
 - c. Read P/AR rating. A reading of 100 signifies no pulse degradation.

(NOTE: The validity of this measurement is subject to some controversy. Therefore, its use is to be confined to developing a confidence factor in the measurement itself.)

IDLE CHANNEL NOISE MEASUREMENT

This test determines the amount of noise present within the bandwidth of the channel under test. The noise is a combination of all the disturbances occurring within the channel bandwidth and includes noises caused by thermal effects, cross-talk, nonlinearities, and so forth.

1. Control position check:
 - a. Circuit impedance, 600 ohms.
 - b. TRANSMIT FUNCTION in QUIET position.
 - c. DISPLAY OFFSET in CAL.
 - d. C-MSG filter selected.

2. Test procedure:
 - a. Set NOISE-TLP CORRECTION to dBrn0.
 - b. Select NOISE, dBrn0.
 - c. Read ICN on display in dBrnc0.

C-NOTCHED NOISE MEASUREMENT

The C-NOTCHED noise measurement is used for compandered, T, or similar PCM carrier-derived lines. This measurement is made to determine the amount of signal uncorrelated noise present when a tone, equal in level to that present during actual operation, is transmitted. This tone is notched out in the receiver, then a normal noise measurement is made. The noise power, in dBrn, is then subtracted from the tone level to obtain the signal to noise ratio in dB.

1. Control position check:
 - a. Select 600, TERM, C-MSG, and CONT.
 - b. NOISE-TLP CORRECTION to dBrn0.
 - c. TRANSMIT FUNCTION in NORM.
 - d. Set LEVEL OUT to test tone level.
 - e. Set LEVEL IN to test tone level (i.e., so that display would read 0 dB if in the AMP RESPONSE mode).
2. Test procedure:
 - a. Select NOISE. The 1004-Hz transmit LED will be illuminated.
 - b. Read C-notched noise directly in dBrnc0.
 - c. Operate S/N pushbutton and read tone level in dBrn0.
 - d. Subtract C-notched noise from tone level to obtain S/N in dB.

NOISE-TO-GROUND MEASUREMENT

Noise-to-ground measurements are performed to determine and evaluate the level of common mode noise (longitudinal voltage) present on facilities.

1. Control position check:
 - a. Circuit impedance, 600 ohms.
 - b. DISPLAY OFFSET in CAL position.
 - c. Select C-MSG.
 - d. Select BRDG.
 - e. Select NOISE.
 - f. Set LEVEL IN to -00 dB.
2. Test procedures:
 - a. Set noise-to-ground adapter impedance to 600.

- b. Insert adapter into RECEIVE jack.
- c. Connect line to RECEIVE input jack of adapter.
- d. Add 40 dB to DISPLAY reading.
- e. Corrected reading is in dBrn.

PHASE JITTER

This test measures the degree of maximum peak-to-peak phase jitter.

1. Control position check:
 - a. LEVEL IN and LEVEL OUT to -10 dBm0.
 - b. Select 600, TERM, C-MSG, and CONT.
 - c. TRANSMIT FUNCTION to NORMAL.
2. Select 0 JITTER. Read peak-to-peak jitter in degrees. If the 1004-Hz LOST indicator is illuminated, the holding tone is not being received.

NONLINEAR DISTORTION

Two pairs of tones, centered at 860 Hz and 1380 Hz, are transmitted over the line at an aggregate power level of -10 dBm0. Second order products (sum and difference) are measured in two narrow bands, and 3rd order products (1380 + 1380 - 860) are measured in one narrow band. Noise contribution in these bands is also measured by removing one of the tone pairs. Noise reading is noted and correction is made for correct distortion reading.

1. Control position check:
 - a. Select 600, TERM, C-MSG, and CONT.
 - b. TRANSMIT FUNCTION in NORM.
 - c. DISPLAY OFFSET to CAL.
 - d. NOISE/TLP CORRECTION to dBn.
 - e. LEVEL IN and LEVEL OUT to -10 dBm0.
2. Select NONLINEAR with toggle in 2nd. Note reading and record. Switch toggle to 3rd. Note reading and record. Depress S/N pushbutton and note and record reading in 2nd and 3rd. Correct the readings obtained by noting the difference between readings taken with S/N depressed and released. Add the correction factor taken from the chart below to the first pair of readings

(i.e., difference of 5 dB has a correction factor of 2 dB).

DIFFERENCE (dB):	1	2	3	4&5	6-9
CORRECTION (dB):	7	5	3	2	1

AMPLITUDE RESPONSE (FREQUENCY RESPONSE)

This test measures the spread of insertion loss or gain across the bandwidth of the channel. Loss frequency characteristics are given in terms of comparison to the measured loss at 1004 Hertz. For example, in the S1 schedule, the loss frequency characteristic should not exceed the range of 2 dB less loss (-) to 6 dB more loss (+) between .3 to 3.0 kHz when compared to the measured loss at 1004 Hertz.

1. Control position check:
 - a. Select 600, TERM, and C-MSG.
 - b. Select CONT (SF if circuit uses in-band signaling).
 - c. TRANSMIT FUNCTION in NORM.
 - d. CONT/LOCK select LOCK.
 - e. SGL/AUTO/AUTO select MAN.
 - f. LEVEL OUT to -10 dBm0.
 - g. Select AMP RESPONSE.
 - h. Select XMT.
 - i. On the 500B (CRT display), select MEMORY A and CLEAR memory.
 - j. Switch to EXPD.
 - k. Observe FREQ display and adjust TUNE control to 1004 Hz.
 - l. Switch to REC.
 - m. Adjust LEVEL IN and DISPLAY OFFSET to exactly 00.00 on display. Note that the CRT dot is at 0 dB and 1.0 kHz.

2. For a point-by-point reading, slowly tune the transmitter across the band, starting at 301 Hz. Read the level deviation at the receiver, in +/- dB, as each new frequency comes up. Switching the MODE control on the 500B unit to MEMORY will cause a response curve to be displayed on the CRT.

ENVELOPE DELAY

This test measures the envelope delay distortion across the bandwidth of the channel under observation.

1. Control check:
 - a. Select 600, TERM, C-MSG, 83 1/3, and LOCK.

- b. Select SF only if line uses in-band signaling.
- c. LEVEL IN and LEVEL OUT to -10 dBm0.
- d. Select MEMORY B on the 500B unit and CLEAR memory.
- e. Select EXPD.
- f. Select DELAY.
- g. Depress REF.

2. With the FREQ display in REC, tune cross the band from 300 to 3000 Hz. Switch the MODE control on the 500B unit to MEMORY. From the trace on the CRT, determine the lowest point and note the frequency. Tune to that frequency and depress REF. Clear the memory on the CRT and switch to load. The display should now read 000 +/- 20 microseconds, with the dot on the CRT at 0 delay and at the frequency selected. Starting at 300 Hz, adjust the tune control across the band and record the reading or sweep the band, using SGL or AUTO sweep.

HIT MEASUREMENTS

This measurement mode measures line transients, including GAIN HITS, PHASE HITS, IMPULSE NOISE at three levels, and DROPOUTS. (The DROPOUT measurement is preset to record dropouts 12 dB and below and requires no adjustment.)

1. Control check:
 - a. Select 600, TERM, and C-MSG.
 - b. TRANSMIT FUNCTION in NORM.
 - c. EXPD/NORM to NORM.
 - d. LEVEL OUT and LEVEL IN to -10 dBm0.
 - e. Select time period of 15.
 - f. Adjust GAIN to 2, PHASE to 20, and IMPULSE to 71.
 - g. Set TLP correction to dBm0.
 - h. Select HIT MEASUREMENTS.

2. Depress START. Display will read 0000, and LED above time will be flashing. At the end of the 15-minute time period, the display will read 15, and the LED above time will stop flashing. Read the GAIN, PHASE, and IMPULSE hits by positioning the LED cursor above each of these.

(NOTE: The accumulated count in any register may be examined at any time without disturbing the counting process.)

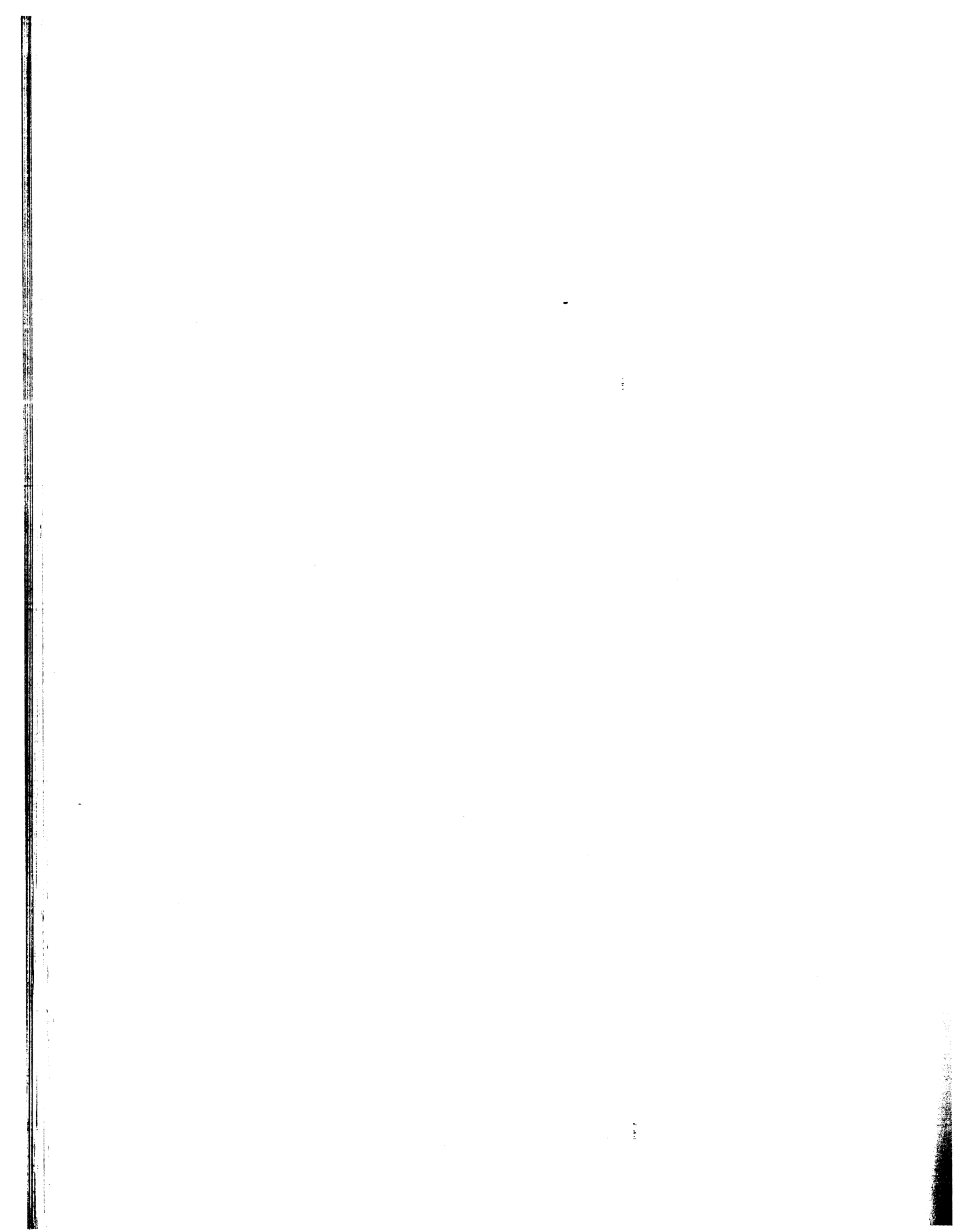

APPENDIX VI

CODEX LSI-9600 MODEM

INTRODUCTION

A typical modem used by NAVSECGRU and SPINTCOMM facilities is the CODEX LSI 9600. Figure AVI-1 illustrates a pair of CODEX LSI 9600 modems with closed front covers. Figure AVI-2 illustrates the front covers open. The control and indicator functions are described in table AVI-1.

OPERATION

To apply ac power to the modem, turn on the power switch on the rear panel of the power supply. After completion of a brief training period (synchronization), if the local and remote modems are in operation and passing data, the following LED indications should exist:

TEST:	Off
CARR LOSS:	Off
MARG CKT:	Off

GOOD DATA: Lighted (green)

RCV DATA: Flashes (yellow) for marks in data received from the remote modem. Lights steadily during idling periods when a constant mark is received.

XMT DATA: Flashes (yellow) for marks when the local data terminal is delivering transmit input data to the modem. Lights steadily during idling periods when data from the local terminal is a steady mark.

If the lamp indications given are NOT obtained following the power turn on and if the red TEST lamp is flashing, one of the test switches is activated. To correct this condition, lower the front panel and locate the test switch that is on (depressed). Press this switch to release the test function and to extinguish the TEST lamp.

Modem operation is normally completely unattended other than for occasional monitoring of lamp indications.

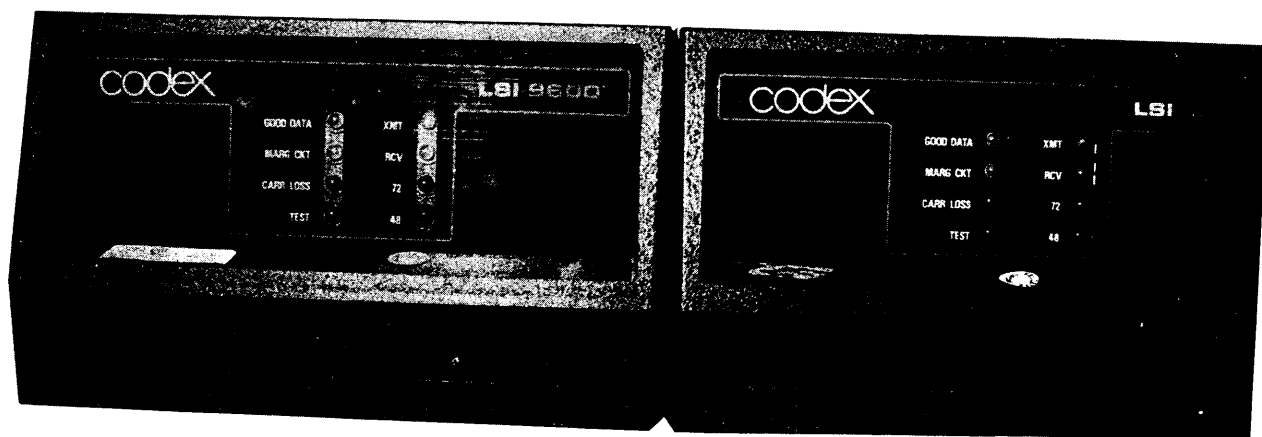
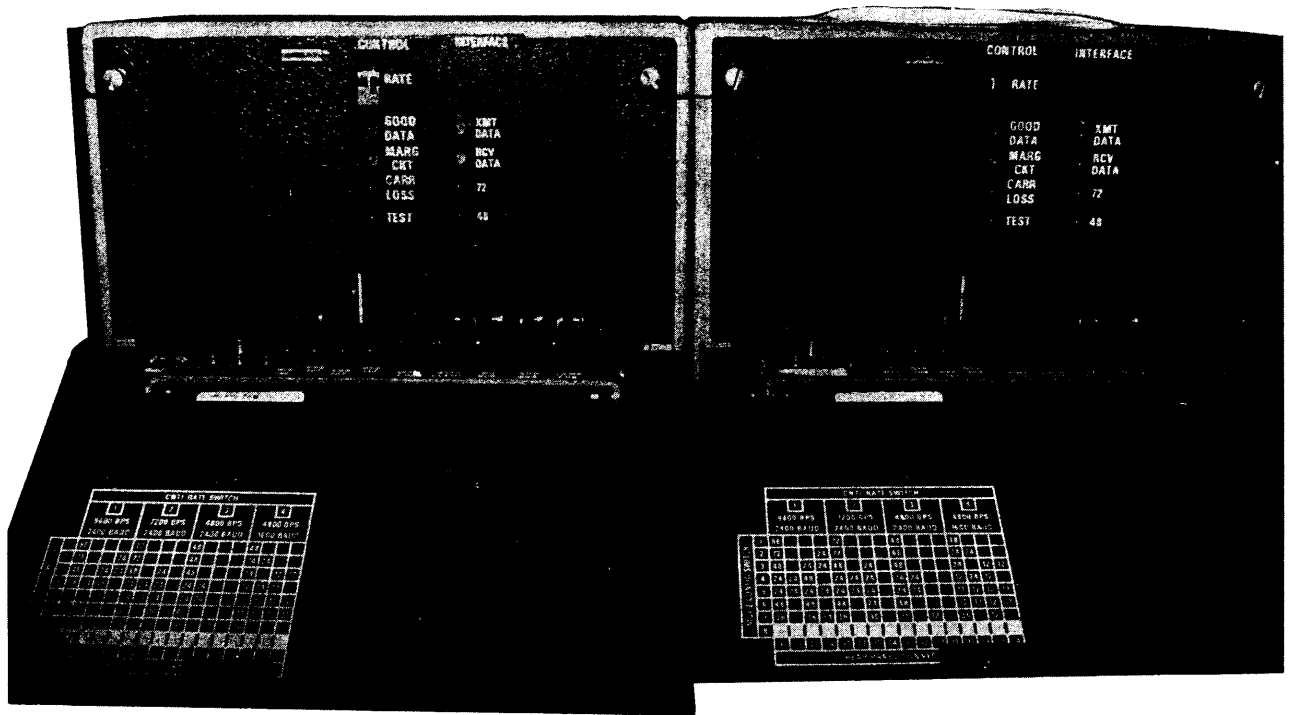

Figure AVI-1.—Closed doors on CODEX LSI modems.

317.45



317.46

Figure AVI-2.—CODEX LSI-9600 Modems with front covers open.

Table AVI-1.—CODEX LSI-9600 Modems Controls and Indicators

Control/Indicator	Function
Power ON/OFF switch (rear panel)	Controls the application of ac power to the dc power supply.
Voltage Selector switch (power supply)	Switches between 115/230-VAC input power.
MDM CHK switch (motherboard)	Causes the TEST lamp to blink, terminates the transmit and receive telephone lines in 600 ohms, and loops the modem transmitter output to the receiver input through the AGC. The local data terminal provides data to, and receives data from, the local looped-back modem.
DATA CLAMP switch (motherboard)	Causes the TEST lamp to blink, blocks transmit input data, and clamps the transmit data input to a space condition that can be traced through the communications link. The receiving modem displays any error outputs when its DATA CLAMP switch is also activated, allowing the bit error to be approximately determined without having to use a test pattern generator.

Table AVI-1.—CODEX LSI-9600 Modems Controls and Indicators (continued)

Control/Indicator	Function															
DC BUS switch (motherboard)	Causes the TEST lamp to blink, isolates the local data terminal from the modem by looping the terminal's data and clock output back to its input, and connects the local modem receiver output data to the transmitter data input. The remote modem receives its own transmitted data back through the local modem and telephone lines. The switch is also used with the four-channel multiplexer option.															
AUD BUS switch (motherboard)	Causes the TEST lamp to blink, and connects the receive telephone line through the receiver's AGC to the transmit output amplifier. The transmit audio signal, which normally feeds the transmit output amplifier, is connected to the receiver input, post-AGC. This allows the local data terminal to receive its own output data back through the local modem transmitter and receiver, and provides an audio loop-back for the remote modem through the local modem's transmit output amplifier and receiver AGC circuits.															
LAMP CHK switch (motherboard)	Lights all the modem indicator lamps. Does not affect normal data transmission and reception.															
Data RATE thumb-wheel selector (A4 Card)	<p>Selects the data rate for the following positions:</p> <table border="1"> <thead> <tr> <th>Position</th> <th>Bit Rate</th> <th>Baud Rate</th> </tr> </thead> <tbody> <tr> <td>1</td> <td>9600</td> <td>2400</td> </tr> <tr> <td>2</td> <td>7200</td> <td>2400</td> </tr> <tr> <td>3</td> <td>4800</td> <td>2400</td> </tr> <tr> <td>4</td> <td>4800</td> <td>1600</td> </tr> </tbody> </table>	Position	Bit Rate	Baud Rate	1	9600	2400	2	7200	2400	3	4800	2400	4	4800	1600
Position	Bit Rate	Baud Rate														
1	9600	2400														
2	7200	2400														
3	4800	2400														
4	4800	1600														
GOOD DATA indicator (A4 Card)	<p>When the averaged amplitude error is below a threshold corresponding to a bit error rate of 1×10^{-5}, a green GOOD DATA LED indicator is lit. For a bit error rate greater than 1×10^{-5} but less than 1×10^{-4}, the GOOD DATA lamp remains lit, and a yellow LED indicator, MARG CKT, also lights. A bit error rate worse than 1×10^{-4} extinguishes the green GOOD DATA LED, leaving only the yellow MARG CKT LED on. The GOOD DATA lamp signal is brought through the A4 card's CG strap to output interface lead CG for use by the data terminal. This indicator is visible through the front panel.</p>															
MARG CKT indicator (A4 Card)																
CARR LOSS indicator (A4 Card)	Lights when the received signal from the remote modem transmitter is lost. This red LED indicator is visible through the front panel.															
TEST dial indicator (A4 Card)	Blinks when any test switch is pressed and lights continuously if the DDD switch is in the BACKUP position. This red LED indicator is visible through the front panel.															
XMT DATA lamp (A3 Card)	Lights for a mark at the transmit logic data input, indicating transmit input data activity. This yellow LED indicator is visible through the front panel.															

Table AVI-1.—CODEX LSI-9600 Modems Controls and Indicators (continued)

Control/Indicator	Function
RCV DATA lamp (A3 Card)	Lights for a mark at the receive logic data output, indicating receive output data activity. This yellow LED indicator is visible through the front panel.
Data RATE indicators (72, 48) (A3 Card)	The upper one indicates 7200 bps data rate, and the lower one indicates 4800 bps data rate. These red LED indicators are visible through the front panel.
RTS indicator (motherboard)	Lights when the data terminal provides a Request to Send data signals to the modem transmitter. This is a red LED indicator.
CTS indicator (motherboard)	Lights when the modem transmitter is ready to accept data from the terminal. This Clear to Send indicator has a red LED.
DSR indicator (motherboard)	Lights when power is on and the modem is not in the TEST mode. This Data Set Ready indicator has a red LED.
DCD indicator (motherboard)	Lights when the received audio signal is detected. This Data Carrier Detect indicator has a red LED.

SYSTEM TEST AND FAULT ISOLATION PROCEDURE

The test switches and indicator lamps built into the LSI-9600 Data Modem allow a rapid, four-step check of the data terminals, modems, and lines. This procedure can be used both to verify normal system operation and to isolate faulty equipment in the event of failure. The results of each test step immediately verify the operational performance of each unit in the system or provide a positive indication of equipment failure.

To determine the operation of data system equipment and circuit lines, ensure that all units are energized and are normally configured. Press the LAMP CHK switch to ensure that all indicator lamps are operating. Then, perform the following test steps in the order given.

1. This step determines the performance of the local data terminal.

a. Lower the swing-down front panel on the local modem, and press the DC BUS switch. This isolates the data terminal and connects the modem receiver output to its own transmitter input in a loopback mode, as shown in figure AVI-3.

b. Normal operation of the data terminal verifies its own performance, together with that of the terminal-to-modem interface cable and line drivers and receivers.

c. When the data terminal operational status check is completed, lower the swing-down front panel, press the DC BUS switch again to restore the normal mode, and go to Step 2 of this procedure.

(NOTE: An additional diagnostic is provided with the four-channel multiplexer option to enable loopback of each individual port.)

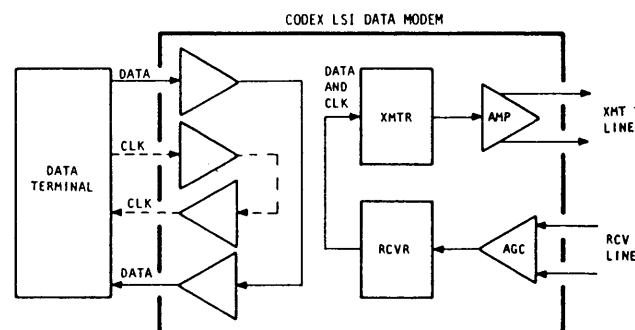

Figure AVI-3.—Modem test configuration: local modem in dc busback mode.

2. This step determines the performance of the local modem.

a. Press the MDM CHK and the DATA CLAMP switches (in that sequence). This terminates the local modem VF lines in 600 ohms and connects the local modem transmit output amplifier back to its own receiver through the AGC. Transmit input data from the terminal is inhibited, and the XMT DATA indicator is disconnected. Data Set Ready and Clear to Send signals to the terminal are held low. (The modem check configuration is shown in figure AVI-4).

b. This test verifies proper operation of the local modem modulator and demodulator circuitry. When random errors are present, the RCV DATA indicator will blink on for each erroneous bit. During proper test mode operation, all of the following modem lamp indications should be observed:

TEST:	On
XMT DATA:	Off
RCV DATA:	Off

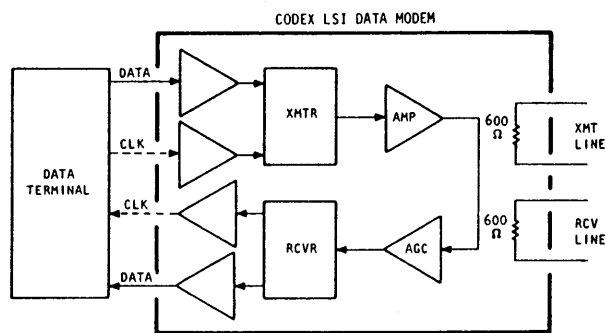

Figure AVI-4.—Modem test configuration: local modem in modem check mode.

GOOD DATA:	Off
MARG CKT:	Off
CARR LOSS:	Off

c. Release the modem DATA CLAMP switch to switch the transmitter back to its normal data input. If the transmit input is at a Space Hold condition, both the XMT DATA and RCV DATA indicators should remain off. If the transmit data input is in a Mark Hold condition, both the XMT DATA and RCV DATA indicators should come on. All other lamp indications should remain as observed previously in step 2b.

d. Release the MDM CHK switch. If correct lamp indications have been observed at both the local and remote sites, both modems are operating properly. Continue with the remainder of this procedure to determine modem operation over the circuit lines.

3. This step determines the ability of each modem to receive its own transmitted signal after it is looped back from the distant modem's receiver AGC and transmit output amplifier circuits. See figure AVI-5. The looped-back signal is merely turned around in the audio stages of the looped-back modem; it is not equalized, decoded, or regenerated. The distortion of the received loopback will, therefore, be approximately double that of a normal received signal. Thus, this step provides an indication of the receiver equalizer's ability to provide usable received output data with double the normal amount of line distortion.

a. Request the operator at the remote modem to press the AUD BUS switch. Then, the operator at the local modem presses the DATA CLAMP switch. This connects the local transmitter output through the transmit line and the receiver AGC, and the transmit output amplifier of the remote modem, back over the receiver line

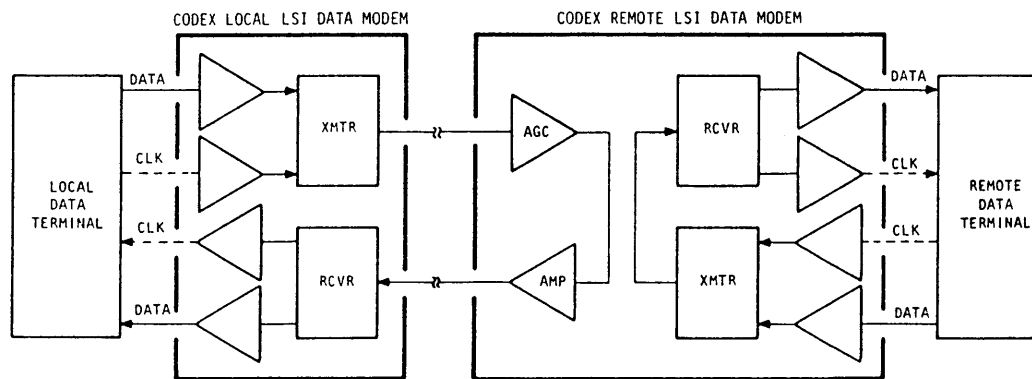

Figure AVI-5.—Modem test configuration: remote modem in audio busback mode.

to the local modem receiver in a loopback. See figure AVI-5.

b. At the local site, observe the modem front panel indicators. Ideally, the following indications may be observed:

TEST:	On
XMT DATA:	Off
RCV DATA:	Off
GOOD DATA:	On
MARG CKT:	Off
CARR LOSS:	Off

c. Depending on circuit line quality, the MARG CKT indicator may flash on occasionally or remain on. Also, random receive data errors can be expected, as evidenced by the RCV DATA indicator flashing on for every bit error. As in the previous test, the frequency at which the RCV DATA lamp flashes on during a 5-minute interval indicates the typical BER. The BER count obtained in this test indicates how well the receiver equalizer operates under conditions of high line distortion, as well as checking the ability of the receiver timing and carrier recovery circuits to remain synchronized.

d. Reverse the system loopback (i.e., at the local site, release the DATA CLAMP switch and press the AUD BUS switch. At the remote site, release the AUD BUS switch and press the DATA CLAMP switch.

e. After the modems retrain, the indications at the remote site should be similar to those previously observed at the local site. If proper indications are observed, the modems are operating properly over the facilities.

f. Release all test switches to restore the system back to the normal data mode. Go to step 4.

4. This step determines the performance of the local and remote modems and VF line circuits. This step also determines each modem's ability to receive a transmitted signal from the other site, properly equalize and decode the signal, and then loop this regenerated signal into the transmitter for transmission back to the originating modem. See figure AVI-6).

a. At the local modem, press the DATA CLAMP switch; at the remote modem, press the DC BUS switch.

b. At the local site, observe the modem front panel indicators. The following indications should be observed (the indications given are for ideal conditions and may vary slightly in the actual circuit):

TEST:	On
XMT DATA:	Off
RCV DATA:	Off
GOOD DATA:	On
MARG CKT:	Off
CARR LOSS:	Off

c. While observing the indications at the local modem, closely watch the MARG CKT indicator and RCV DATA indicator. Depending on line quality, both of these indicators may occasionally flash on. The frequency at which the RCV DATA indicator flashes determines the BIT. If the BER is satisfactory, the circuit lines may be considered as operating normally. (NOTE: It is possible for the MARG CKT indicator to flash on while the RCV DATA indicator appears off. The MARG CKT indicator responds to the average noise and distortion in the demodulator, and is a qualitative indicator of receive signal quality.)

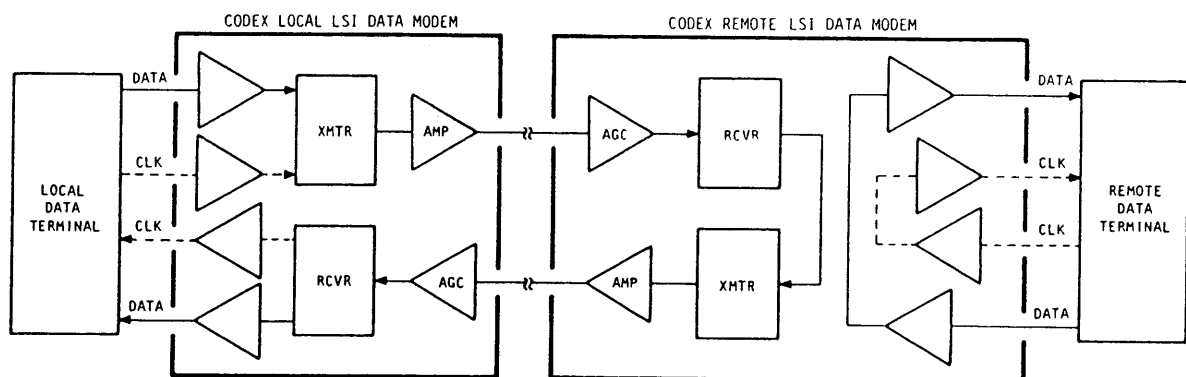

Figure AVI-6.—Modem test configuration: remote modem in dc busback mode.

d. Light green GOOD DATA lamps at the local and remote modems indicate normal operation of both modems, the VFR circuits, and the local data terminal.

e. If it is convenient for the remote operator, request a check of the operation of the remote data terminal, which is looped back to itself in this mode. Proper operation of the remote data terminal verifies its performance together with that of the terminal-to-modem interface cable.

f. Reverse the system loopback (i.e., at the local site, release the DATA CLAMP switch and press the DC BUS switch. At the remote site, release the DC BUS switch and press the DATA CLAMP switch.)

g. After the modems retrain, the indications at the remote site should be similar to those previously observed at the local site. If proper indications are observed, the modems are operating properly and circuit line quality can be considered good; reset the modem test switches to allow normal operation. This completes the system test and fault isolation procedure.

If the normal indications listed for steps 1 through 4 of the previous procedure have been obtained, the data communications system is operating properly. If incorrect indications are obtained in any step of the procedure, see table AVI-2 for assistance in determining the faulty equipment.

Table AVI-2.—System Fault Isolation

Improper Indication Obtained in Step:	Faulty Equipment	
	Local Site	Remote Site
1	Data terminal (also possible terminal-to-modem interface cable or modem line driver/receiver trouble).	
2	Modem, if step 1 is normal.	
3	Telephone circuits, if steps 1 and 2 are normal.	Possible receiver AGC and/or transmit output amplifier trouble.
4		Modem, if steps 1, 2, and 3 were normal. If the remote operator is able to check the data terminal in this step, but cannot obtain normal operation of the terminal (which is looped back to itself in this mode), the data terminal, terminal-to-modem cable, or modem line driver/receiver is faulty.

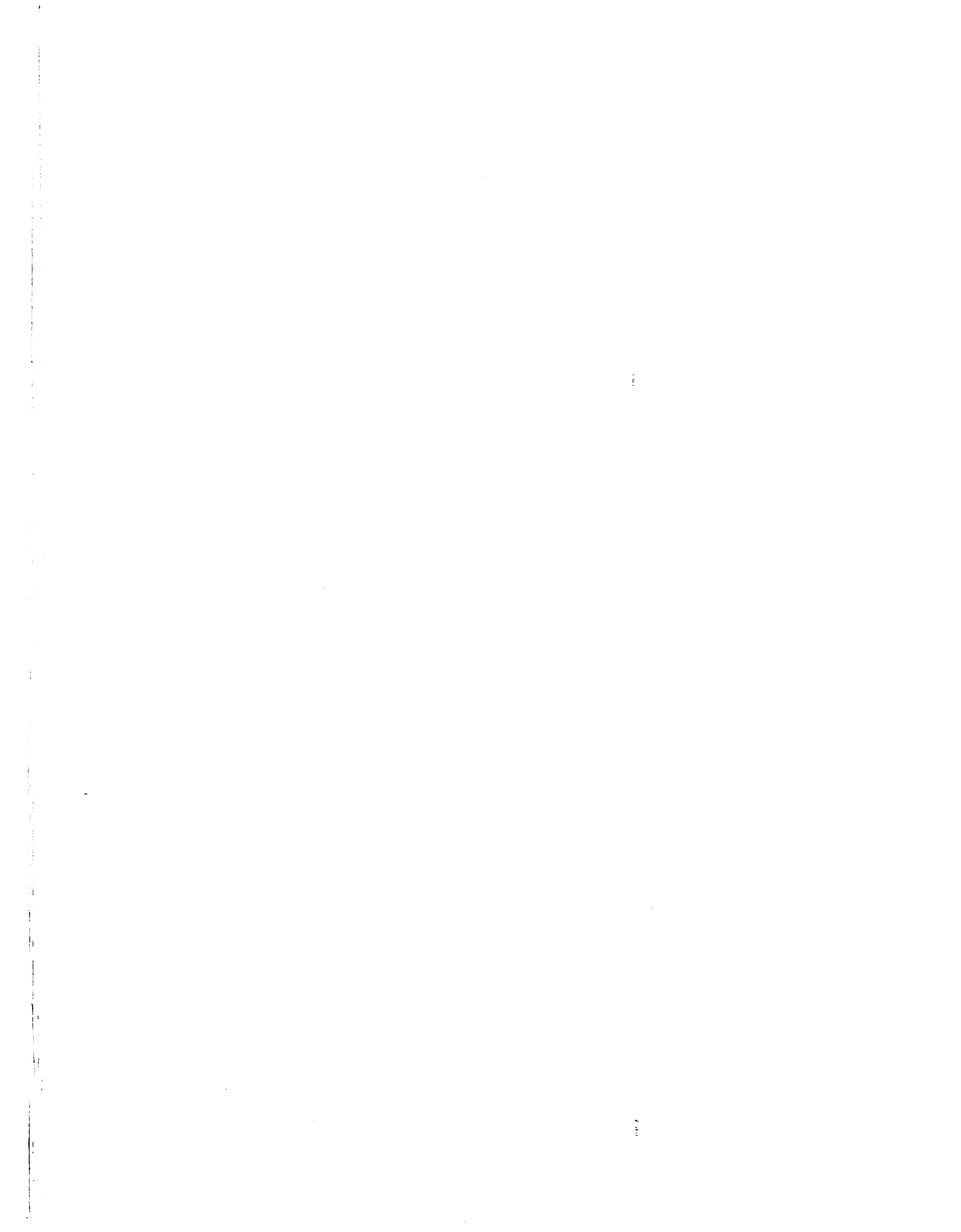

APPENDIX VII

GLOSSARY OF TERMS

A

Acceptance test.—The operating and testing of a communications system, subsystem, or component to ensure that the specified performance characteristics have been met.

ACK.—The abbreviation for *Acknowledge Character*.

Acknowledge Character (ACK).—A transmission control character transmitted by a receiver as an affirmative response to a sender. (NOTE: An acknowledge character may also be used as an accuracy control character.)

Acknowledgment.—1. A protocol data unit, or element thereof, between peer entities to indicate the status of data units that have been previously received. 2. A message from the addressee informing the originator that his communication has been received and understood.

A-condition.—The significant condition of the element in a start-stop teletypewriter system that precedes a character signal or block signal. The A-element prepares the receiving equipment for the reception of the code elements. (Synonym: *start signal*.)

Acoustic noise.—An undesired audible disturbance in the audio frequency range.

Alarm indicator.—A device that responds to a signal from an alarm sensor; e.g., a bell, lamp, horn, gong, buzzer, or a combination thereof.

Amplitude distortion.—The distortion occurring in a system, subsystem, or device when the output amplitude is not a linear function of the input amplitude under specified conditions.

Amplitude frequency response.—Synonym: *insertion-loss-vs-frequency characteristic*.

Amplitude Modulation (AM).—A form of modulation in which the amplitude of a carrier wave is varied in accordance with some characteristic of the modulating signal.

Amplitude-vs-frequency distortion.—The distortion in a transmission system caused by the non-uniform attenuation, or gain, of the system with respect to frequency under specified operating conditions. (Synonym: *frequency distortion*.)

AMPS.—The acronym for *Automatic Message Processing System*.

Analog data.—The data represented by a physical quantity that is considered to be continuously variable and whose magnitude is made directly proportional to the data or to a suitable function of the data.

Analog signal.—1. A signal that makes use of electrical or physical analogies (i.e., varying voltages, frequencies, and distances) to produce a signal of a continuous (rather than of a pulsed or discrete) nature. 2. A nominally continuous electrical signal that varies in some direct correlation to another signal impressed on a transducer. (NOTE: The electrical signal may vary its frequency, phase, or amplitude in response to changes in certain phenomena or characteristics, such as sound, light, heat, position, or pressure.)

Analog-to-Digital (A-D) conversion.—The conversion of an analog signal to a digital signal.

Analog-to-Digital (A-D) converter.—A device that converts an analog input signal to a digital output signal carrying equivalent information.

Analog transmission.—The transmission of a continuously variable signal as opposed to the transmission of a discretely varying signal.

Antenna.—Any structure or device used to collect or radiate electromagnetic waves.

Antenna gain.—The ratio of the power required at the input of a reference antenna to the power supplied at the input of the given antenna to produce, in a given direction, the same field at the same distance. (NOTE: When not specified otherwise, the figure expresses the gain in the direction of the radiation main lobe. In services using scattering modes of propagation, the full gain of an antenna may not be realizable in practice and the apparent gain may vary with time.) (Synonym: *power gain of an antenna*.)

Antenna lobe.—A three-dimensional section of the radiation pattern of a directional antenna bounded by one or more cones of nulls or regions of diminished intensity.

Asynchronous communications system.—A data communications system in which extra signal elements are added to the data to synchronize individual data characters or blocks. (NOTE: The time spacing between successive data characters or blocks may be of arbitrary duration.) (Synonym: *start-stop system*.)

Asynchronous network.—Synonym: *non-synchronous network*.

Asynchronous operation.—1. A sequence of operations in which operations are executed out of time coincidence with any event. 2. An operation that occurs without a regular or predictable time relationship to a specified event; e.g., the calling of an error diagnostic routine that may receive control at any time during the execution of a computer program. (Synonym: *asynchronous working*.)

Asynchronous Time-Division Multiplexing (ATDM).—An asynchronous transmission mode that makes use of time-division multiplexing.

Asynchronous transmission.—A transmission process such that between any two significant instants in the same group, there is always an integral number of unit intervals. (In data transmission, a *group* is a block or a character; in telegraphy, it is a character.) Between two significant instants located in different groups, there is not always an integral number of unit intervals.

ATDM.—The acronym for *Asynchronous Time-Division Multiplexing*.

Atmospheric duct.—A layer in the lower atmosphere, occasionally of great horizontal extent, in which the vertical refractivity gradients are such that radio signals are guided or focused within the duct and tend to follow the curvature of the earth with much less than normal attenuation.

Atmospheric noise.—A radio noise caused by natural atmospheric processes, primarily by lightning discharges in thunderstorms.

Attenuation.—A decrease in intensity of a signal, beam, or wave as a result of absorption of energy and of scattering out of the path of a detector, but not including the reduction due to geometric spreading (i.e., the inverse square of distance effect).

Audio Frequency (AF).—The band of frequencies that can be heard by the human ear (normally between 30 and 15,000 hertz) when transmitted as sound waves.

AUTODIN.—The acronym for *Automatic Digital Network*.

Automatic Digital Network (AUTODIN).—A worldwide data communications network of the Defense Communications System.

Automatic Gain Control (AGC).—A process or means by which gain is automatically adjusted in a specified manner as a function of input or another specified parameter.

Automatic Voice Network (AUTOVON).—The principal long-haul, unsecure voice communications network within the Defense Communications System.

AUTOSEVOCOM.—The acronym for *Automatic Secure Voice Communications Network*.

AUTOVON.—The acronym for *Automatic Voice Network*.

B

Back-to-back connection.—A connection between the output of a transmitting device and the input of an associated receiving device. (NOTE: When used for equipment measurements or testing purposes, this eliminates the effects of the transmission channel or medium.)

Balanced.—Pertaining to electrical symmetry.

Balanced code.—A code in PCM systems constructed so that the spectrum resulting from the transmission of any codeword has no dc component. (NOTE: This is a code whose digital sum variation is finite.)

Balanced line.—A transmission line consisting of two conductors in the presence of ground, capable of being operated in such a way that when the voltages of the two conductors at all transverse planes are equal in magnitude and opposite in polarity with respect to ground, the currents in the two conductors are equal in magnitude and opposite in direction. (NOTE: A balanced line may be operated in an unbalanced condition.) Synonym: *balanced signal pair*.)

Balanced signal pair.—Synonym: *balanced line*.

Bandpass filter.—A filter having a single continuous transmission band with neither the lower nor the upper cutoff frequencies being either zero or infinite.

Bandwidth.—1. The bandwidth of a device is the difference between the limiting frequencies within which performance in respect to some characteristic falls within specified limits. 2. The difference between the limiting frequencies of a continuous frequency band.

Baseband.—1. The spectral band occupied by a signal that either does not require carrier modulation or describes the signal state prior to modulation or following demodulation. (NOTE: It is usually characterized by being much lower in the frequency spectrum than the resultant signal after it is used to modulate a carrier or subcarrier. 2. In facsimile, the

frequency of a signal equal in width to that between zero frequency and maximum keying frequency.

Baud (Bd).—1. A unit of modulation rate. One baud corresponds to a rate of one unit interval per second, where the modulation rate is expressed as the reciprocal of the duration in seconds of the shortest unit interval. 2. A unit of signaling speed equal to the number of discrete signal conditions, variations, or events per second. (NOTE: If the duration of the unit interval is 20 milliseconds, the signaling speed is 50 baud. If the signal transmitted during each unit interval can take on any one of M discrete states, the bit rate is equal to the rate in baud times $\log_2 M$. The technique used to encode the allowable signal states may be any combination of amplitude, frequency, or phase modulation, but it cannot utilize a further time-division multiplexing technique to subdivide the unit intervals into multiple subintervals. In some signaling systems, non-information-carrying signals may be inserted to facilitate synchronization. For example, in certain forms of binary modulation coding, there is a forced inversion of the signal state at the center of the bit interval. In these cases, the synchronization signals are included in the calculation of the rate in baud, but not in the computation of the bit rate.)

Baudot code.—A five-unit synchronous code developed about 1880. (NOTE 1: Baudot code has been replaced by the start-stop asynchronous International Alphabet No. 2 (1A No. 2). NOTE 2: 1A No. 2 should **not** be identified as *Baudot code*.)

BCC.—The abbreviation for *Block Code Character*.

BCD.—The abbreviation for *Binary Coded Decimal*.

BCI.—The abbreviation for *Bit Count Integrity*.

Bd.—The abbreviation for *Baud*.

Bel (B).—A unit of power ratio. The decibel, equal to one-tenth bel, is a more commonly used unit.

BER.—The abbreviation for *Bit Error Ratio*.

Bias.—1. A systematic deviation of a value from a reference value. 2. The amount by which the average of a set of values departs from a reference value. 3. The electrical, mechanical, or magnetic force that is applied to a device to establish an electrical or mechanical reference level to operate the device. 4. The effect on telegraph signals produced by the electrical characteristics of the terminal equipment.

Bias distortion.—Distortion affecting a two-condition (or binary) modulation in which all the significant intervals corresponding to one of the two significant conditions have uniformly longer or shorter durations than the corresponding theoretical durations. (NOTE: The magnitude of the distortion is expressed in percent of a perfect unit pulse length.)

Bit.—The acronym for *Binary Digit*.

Bit error rate.—(See *bit error ratio*.)

Bit Error Ratio (BER).—The number of erroneous bits divided by the total number of bits over some stipulated period of time. (NOTE: Two examples of bit error ratio are: (1) transmission BER—the number of erroneous bits received divided by the total number of bits transmitted; and (2) information BER—the number of erroneous decoded (corrected) bits divided by the total number of decoded (corrected) bits. The BER is usually expressed as a number and a power of 10. For example, 2.5 erroneous bits out of 100,000 bits transmitted would be 2.5 in 10^5 or 2.5×10^{-5} .)

Bit rate.—In a bit stream, the number of bits occurring per unit time, usually expressed as bits per second. (NOTE: For M-ary operation, the bit rate is equal to $\log_2 M$ times the rate (in baud), where M is the dimensionality of the signal.)

Bits per second (bps).—The number of bits passing a designated point in a system per second. (NOTE 1: Values of modulation rate in baud and in bits per second are numerically the same if, and only if, all of the three following conditions are met: (1) all pulses (bits) are the same length; (2) all pulses (bits) are equal to the unit interval, the time element between the same two significant instants of adjacent pulses; and (3) binary operation is used. NOTE 2: In M-ary operation, bps equals $\log_2 M$ times the rate (in baud), where M is the dimensionality of the signal.)

BLACK designation.—See *RED/BLACK concept*.

BLACK signal.—A signal, in cryptographic systems, containing classified information that has already been encrypted. (See *RED/BLACK concept*.)

Byte.—A sequence of adjacent binary digits, operated on as a unit, and usually shorter than a word. The byte is the smallest addressable unit. (NOTE: The number of bits in a byte must be specified.)

C

Cable.—1. An assembly of one or more conductors or optical fibers within an enveloping sheath, constructed to permit use of the conductors singly or in groups. 2. A message sent by cable.

Carrier (cxr).—1. A wave suitable for modulation by an information-bearing signal to be transmitted over a communications system. 2. An unmodulated emission. (NOTE: The carrier is usually a sinusoidal wave or a recurring series of pulses.) (Synonym: *carrier wave*.)

Carrier dropout.—A short-duration carrier signal loss.

Carrier frequency.—1. The frequency of a carrier wave. 2. A frequency capable of being modulated or impressed with a second (information-carrying) signal. (NOTE: In frequency modulation, the carrier frequency is also referred to as the *center frequency*.)

Carrier level.—The power of a carrier signal at a particular point in a system, expressed in decibels in relation to some reference level.

Carrier multiplex.—Synonym: *frequency-division multiplexing*.

Carrier noise level.—The noise level resulting from undesired variations of a carrier in the absence of any intended modulation. (Synonym: *residual modulation*.)

Carrier shift.—1. A method of keying a radio carrier for transmitting binary data or teletypewriter signals, consisting of shifting the

carrier frequency in one direction for a marking signal and in the opposite direction for a spacing signal. **2.** In amplitude modulation, a condition resulting from imperfect modulation where the positive and negative excursions of the envelope pattern are unequal, thus effecting a change in the power associated with the carrier. There can be positive or negative carrier shift.

Carrier synchronization.—The generation, in a radio receiver, of a reference carrier with a phase closely matching that of a received signal.

Carrier system.—A multichannel telecommunications arrangement where a number of individual data and/or voice circuits are multiplexed onto a single carrier frequency for transmission between nodes of a network with demultiplexing occurring as required. (NOTE 1: Many different forms of multiplexing are possible, including time-division and frequency-division. NOTE 2: Multiple layers of multiplexing on the same carrier are also common.)

Carrier wave.—Synonym: *carrier*.

Center frequency.—**1.** The resting frequency or initial frequency of the carrier before modulation (in frequency modulation). **2.** The frequency midway between picture black and picture white frequencies (in facsimile).

Cesium clock.—A clock containing a cesium standard as a frequency-determining element.

Cesium standard.—A primary frequency standard in which a specified hyperfine transition of cesium 133 atoms is used to control the output frequency. (NOTE: Its accuracy is intrinsic and is achieved without calibration.)

Character.—**1.** A letter, digit, or other symbol that is used as part of the organization, control, or representation of data. **2.** A unit of an alphabet.

Character-count and bit-count integrity.—The preservation of the precise number of characters or bits that are originated in a message (in the case of a message communication) or per unit time (in the case of a user-to-user connection). (NOTE: Do not confuse this with bit integrity or character integrity, which require that the characters or bits delivered are, in fact, as they were originated.)

Character interval.—The total number of unit intervals (including synchronizing, information, error checking, or control bits) required to transmit any given character in any given communications system. Extra signals that are not associated with individual characters are not included. (NOTE: An example of an extra signal that is excluded in the above definition is any additional time added between the end of the stop element and the beginning of the next start element as a result of speed change, buffering, and so forth. This additional time is defined as a part of the intercharacter interval.)

Characteristic distortion.—The distortion, in telegraphy, caused by transients that, as a result of previous modulation, are present in the transmission channel. Its effects are not consistent; its influence upon a given transition is to some degree dependent upon the remnants of transients affecting previous signal elements.

Circuit.—**1.** The complete path between two terminals over which one-way or two-way communications may be provided. **2.** An electronic path among two or more points capable of providing a number of channels. **3.** A number of conductors connected together to carry an electrical current. **4.** An electronic closed-loop path among two or more points used for signal transfer.

Circuit noise level.—The ratio of the circuit noise in a transmission system at that point to some arbitrary amount of circuit noise chosen as a reference. (NOTE: The ratio is usually expressed in decibels above reference noise (abbreviated dBrn), signifying the reading of a circuit noise meter; or in dBrn adjusted (abbreviated dBa), signifying circuit noise meter reading adjusted to represent an interfering effect under specified conditions.)

Clock.—**1.** A reference source of timing information for equipment, machines, or systems. **2.** Equipment providing a time base used in a transmission system to control the timing of certain functions, such as the control of the duration of signal elements or the sampling rate.

Clock error.—The clock difference between a clock and a designated reference clock. (NOTE: The clock difference, with its sign changed, is the correction required to bring the clock into agreement with the reference clock.)

C-message weighting.—A noise weighting used in a noise-measuring set to measure noise on a line that would be terminated by a 500-type or similar instrument. The meter scale readings are in dBrn (C-message) or in dBrnC.

Coaxial cable.—A cable consisting of a center conductor surrounded by an insulating material and a concentric outer conductor. (NOTE: This is used primarily for wideband, video, or radio frequency service.)

Communications.—1. A method or means of conveying information of any kind from one person or place to another, except by direct unassisted conversation or correspondence through non-military postal agencies. 2. A method or means of conveying information of any kind from one person or process to other persons or processes by a telecommunications medium.

Communications sink.—A device that receives information, control, or other signals from communications sources.

Communications source.—A device that generates information, control, or other signals destined for communications sinks.

Communications subsystem.—A generic telecommunications term that must be understood in context. It represents a functional or operational assembly that is smaller than the larger assembly under discussion.

Communications system.—A collection of individual communication networks, transmission systems, relay stations, tributary stations, and terminal equipment capable of interconnection and interoperation to form an integral whole. (NOTE: The individual components must serve a common purpose, be technically compatible, employ common procedures, respond to some form of control, and, in general, operate in unison.)

Continuous Wave (CW).—A radio wave of constant amplitude and constant frequency.

Cross connection.—The connections between the terminal blocks on the two sides of a distribution frame, or between terminals on a terminal block. Connections between terminals on the same

block are also called *straps*, *cross connects*, and *jumpers*.)

Crosstalk.—The phenomenon in which a signal transmitted on one circuit or channel of a transmission system creates an undesired effect in another circuit or channel.

D

Data.—The representation of facts, concepts, or instructions in a formalized manner suitable for communications, interpretation, or processing by people or by automatic means. Any representations, such as characters or analog quantities to which meaning is or might be assigned.

Data circuit.—A pair of associated transmit and receive channels that provide a means of two-way data communications.

Data Circuit-Terminating Equipment (DCE).—The interfacing equipment sometimes required to couple the Data Terminal Equipment (DTE) into a transmission circuit or channel and from a transmission circuit or channel into the DTE. (Synonyms: *data communications equipment* and *data set*.)

Data communications.—The data transfer between data source and data sink by one or more data links according to a protocol.

Data sink.—A device that receives data signals from data sources.

Data source.—A device that generates data signals destined for data sinks.

Data Subscriber Terminal Equipment (DSTE).—A general-purpose AUTODIN terminal device, consisting of all necessary equipment (1) to provide AUTODIN interface functions, and (2) to perform code messages, punched paper tape, or magnetic tape to electrical signals for transmission, and the reverse of this process.

Data-Switching Exchange (DSE).—The equipment installed at a single location to switch data.

traffic. (NOTE: A data-switching exchange may provide only circuit switching, only packet switching, or both.)

Data Terminal Equipment (DTE).—1. The digital end instruments that convert the user information into data signals for transmission, or reconvert the received data signals into user information. 2. The functional unit of a data station that serves as a data source or a data sink and provides for the data communication control functions to be performed in accordance with link protocol. (NOTE: The DTE may consist of a single piece of equipment that provides all the required functions necessary to permit the user to intercommunicate, or it may be an interconnected subsystem of multiple pieces of equipment to perform all the required functions.)

dB.—The abbreviation for *decibel*. The standard unit for expressing transmission gain or loss and relative power ratios. The decibel is one-tenth the size of a bel, which is too large a unit for convenient use.

dBm.—The abbreviation for *dBmW*; dB is referred to as 1 milliwatt. Used in communications work as a measure of absolute power values. Zero dBm equals 1 milliwatt. (NOTE: In DOD practice, unweighted measurement is normally understood, applicable to a certain bandwidth which must be stated or implied.)

dBm0.—The noise power in dBm referred to or measured at a zero Transmission Level Point (0-TLP). The 0-TLP is also called a *point of zero relative transmission level* (0 dBr0).

dBr.—The power difference expressed in dB between any point and a reference point selected as the zero relative transmission level point. (NOTE: Any power expressed in dBr does not specify the absolute power. It is a relative measurement only.)

dBrn.—The decibels above reference noise. Weighted noise power in dB referred to 1.0 picowatt. Thus, 0 dBrn = -90 dBm. The use of 144-line, 144-receiver, C-message weighting, or flat weighting must be indicated in parentheses, as required. (NOTE 1: With C-message weighting, a 1-milliwatt, 1000-Hz tone will read +90 dBrn, but the same power as white noise, randomly

distributed over a 3-kHz band will read approximately +88.5 dBrn (rounded off to +88 dBrn), due to the frequency weighting. NOTE 2: With 144 weightings, a 1-milliwatt, 1000-Hz tone will also read +90 dBrn, but the same 3-kHz white noise power will only read +82 dBrn, due to the different frequency weighting.)

dBrnC.—The weighted noise power in dBrn, measured by a noise measuring set with C-message weighting.

dBrnC0.—The noise power in dBrnC referred to or measured at a zero Transmission Level Point (0-TLP).

dBW.—The decibels referred to 1 watt.

DCE.—The abbreviation for *Data Circuit-Terminating Equipment*.

DCE clear signal.—A call control signal transmitted by the DCE to indicate that it is clearing a call.

DCE waiting signal.—A call control signal at the DCE/DTE interface that indicates that the DCE is waiting for another event in the call establishment procedure.

Degradation.—The condition, in communications, in which one or more of the established performance criteria of a circuit are met, thus providing a lower quality of service.

Delay distortion.—The distortion of a wave form made up of two or more different frequencies, caused by the difference in arrival time of each frequency at the output of a transmission system.

Demultiplex (demux).—The separation of two or more signals previously combined by a compatible multiplexing equipment.

Diffraction.—The deviation of a wavefront from the path predicted by geometric optics when a wavefront is restricted by an opening or an edge.

Digital-to-Analog (D-A) converter.—A device that converts a digital input signal to an analog output signal carrying equivalent information.

Digital transmission group.—A number of voice channels or a number of data channels, or both, that are combined into a digital bit stream for transmission over various communications media. (NOTE: No specific number of channels is implied by this term. In general, however, the term implies no more channels than can be accommodated by a multiplexer whose output rate is not greater than about 24 voice channels.)

Digital transmission system.—A transmission system wherein all circuits carry information in digital form and are combined into one or more serial bit streams. A-D/D-A conversion must be accomplished external to the system.

Digital voice transmission.—The transmission of analog voice signals that have been converted into digital signals; e.g., Pulse-Code Modulation (PCM) of analog voice signals.

Directional antenna.—An antenna in which the radiation or reception is not omnidirectional; i.e., a non-isotropic antenna. (NOTE: All practical antennas are directional to some degree.)

Discrete.—A separate, individual, and distinct thing.

Distortion.—Any departure from a specified input-output signal relationship over a range of frequencies, amplitudes, or phase shifts during a time interval.

Distribution frame.—A structure with terminations for connecting the permanent wiring of a facility in such a manner that interconnection by cross connections may be made readily.

Diversity reception.—The method of radio reception whereby, to minimize the effects of fading, a resultant signal is obtained by combination or selection, or both, of two or more independent sources of received-signal energy that carry the same modulation or information, but that may vary in their fading characteristics at any given instant. (NOTE: The amount of diversity improvement is directly dependent on the independence of the fading characteristics.)

DOD master clock.—The U.S. Naval Observatory master clock has been designated as the DOD master clock to which DOD time and frequency measurements are referenced (traceable). (NOTE: This clock is one of two standard time

references for the U.S. Government in accordance with Federal Standard 1002; the other standard time reference is the National Bureau of Standards (NBS) master clock.)

Downtime.—The time during which a functional unit is inoperable.

Dropout.—1. A momentary communications loss in signal, usually due to the effect of noise, propagation anomalies, or system malfunction. 2. A failure to read a binary character from data storage. (NOTE: This failure is generally caused by defects in the storage media, or failure in the read mechanism. 3. A magnetic tape recorded signal whose amplitude is less than a predetermined percentage of a reference signal.

DTE.—The acronym for *Data Terminal Equipment*.

Ducting.—The propagation of radio waves within an atmospheric duct.

Dummy load.—A dissipative, impedance-matched network used at the end of a transmission line to absorb all incident power, usually converted to heat.

Duplex circuit.—A circuit that affords simultaneous transmission in **both** directions.

Duplex operation.—A mode of operation in which simultaneous communications in **both** directions may occur between two terminals. (NOTE: Duplex operation may only occur on a duplex circuit.) (Synonym: *two-way simultaneous operation*.)

E

EIA interface.—The standards developed in the commercial world by Electronic Industries Association (EIA) to define interface parameters. Some of these standards have been adopted by the Federal Government.

E layer.—See *E region, ionosphere*.

Electromagnetic emission control.—The control of friendly electromagnetic emissions (such as radio, radar, and sonar transmissions) to prevent or minimize their use by unintended recipients.

Electromagnetic Interference (EMI).—1. Any electromagnetic disturbance that interrupts, obstructs, or otherwise degrades or limits the effective performance of electronic/electrical equipment. It can be induced intentionally, as in some forms of electronic warfare, or unintentionally, as a result of spurious emissions and responses, intermodulation products, and the like. 2. The phenomenon resulting when electromagnetic energy causes an unacceptable or undesirable response, malfunction, degradation, or interruption of the intended operation of an electronic equipment, subsystem, or system. (Synonym: *radio frequency interference*.)

Electronic Countermeasures (ECM).—The division of electronic warfare involving actions taken to prevent or reduce an enemy's effective use of the electromagnetic spectrum.

Emission Control (EMCON).—The selective and controlled use of electromagnetic, acoustic, or other emitters to (a) optimize command and control capabilities while minimizing detection by enemy sensors (for Operations Security [OPSEC]); (b) minimize mutual interference among friendly systems; or (c) execute a military deception plan.

End distortion.—The shifting of the end of all marking pulses, except the stop pulse, from their proper positions in relation to the beginning of the next start pulse in start-stop teletypewriter operations. (NOTE 1: Shifting of the end of the stop pulse would constitute a deviation in character time and rate, rather than being an end distortion. NOTE 2: Spacing end distortion is the termination of marking pulses before the proper time. NOTE 3: Marking end distortion is the continuation of marking pulses past the proper time. NOTE 4: The magnitude of the distortion is expressed in percent of a perfect unit pulse length.)

Envelope.—The boundary of the family of curves obtained by varying a parameter of a wave.

Envelope delay distortion.—The distortion that results when the rate of change of phase shift with frequency over the necessary bandwidth of an equipment, circuit, or system is not constant. (NOTE: This is usually stated as one-half the difference between the delays of the two extremes of the necessary bandwidth.)

Equal level patch bay.—An analog patching facility at which all voice frequency circuit inputs and outputs appear at a uniform level. (NOTE: This permits patching without making transmission level adjustments.)

Equipment side.—The portion of a device that looks toward the in-station equipment.

E region.—The region of the ionosphere existing between approximately 95 and 160 km above the surface of the earth. It lies between the D and F regions. (Synonym: *Kennelly-Heaviside layer*.)

Error rate.—The ratio of the number of bits, elements, characters, or blocks incorrectly received to the total number of bits, elements, characters, or blocks sent in a specified time interval.

Extremely High Frequency (EHF).—The frequencies from 30 GHz to 300 GHz.

Extremely Low Frequency (ELF).—The frequencies from 30 Hz to 300 Hz.

Eye pattern.—An oscilloscope pattern used for examination of digital signal distortion. (NOTE: An open eye pattern corresponds to minimal signal distortion. The distortion of the signal waveform, due to intersymbol interference and noise, appears as closure of the eye pattern.)

F

Facility.—1. A fixed or transportable building or other structure, including utilities, ground networks, electrical supporting structures, wiring, cabling, and any required electrical and electronic equipments. 2. A service provided by the telecommunications network or equipment for the benefit of the users or the operating administration. A general term for the communications transmission pathways and associated equipment. 3. As used in a data protocol context, a facility represents an additional item of information or a constraint encoded with the protocol data unit to provide the requested control.

Fading.—The variation, with time, of the intensity or relative phase, or both, of any or all frequency components of a received signal, due to changes in the characteristics of the propagation path.

Fault.—1. A reproducible malfunction. A malfunction is reproducible if it occurs consistently under the same circumstances. 2. An unintentional short-circuit, or a partial short-circuit, between energized conductors or between an energized conductor and a ground in power systems.

Fiber Optic Cable (FOC).—A communications cable using one or more optical fibers as the transmission line medium.

Fiber optic link.—A communications link that transmits signals by means of modulated light propagated in an optical fiber.

Fiber Optics (FO).—The branch of optical technology concerned with the transmission of radiant power through fibers made of transparent materials such as glass, fused silica, or plastic. (NOTE 1: Telecommunications applications of fiber optics use flexible fibers. Either a single discrete fiber or a spatially non-aligned fiber bundle may be used for each information channel. Such fibers are often referred to as *optical wave guides* to differentiate them from fibers used in non-communications applications. NOTE 2: Various industrial and medical applications use (typically high-loss) flexible fiber bundles in which individual fibers are spatially aligned, permitting optical relay of an image. An example is the endoscope. NOTE 3: Some specialized industrial applications use rigid (fused) aligned fiber bundles for image transfer. An example is the fiber optics faceplate used on some high-speed oscilloscopes.)

Filter.—An electronic device that transmits only part of the incident energy and may thereby change the spectral distribution of energy: (a) high-pass filters transmit energy above a certain frequency; (b) low-pass filters transmit energy below a certain frequency; (c) bandpass filters transmit energy of a certain bandwidth; and (d) band-stop filters transmit energy outside a specific frequency band.

FM.—The abbreviation for *Frequency Modulation*.

FO.—The abbreviation for *Fiber Optics*.

FOC.—The abbreviation for *Fiber Optic Cable*.

F region.—The region of the ionosphere between approximately 175 and 400 km above the

surface of the earth. (NOTE 1: The F¹ layer, at approximately 175- to 250-km height, exists only during daylight hours. NOTE 2: The F² layer, at approximately 250- to 400-km height, is the principal reflecting layer for HF communications.)

Frequency.—The number of cycles or events per unit of time for a periodic function. When the unit of time is 1 second, the measurement unit is the hertz (Hz).

Frequency distortion.—Synonym: *amplitude-vs-frequency distortion*.

Frequency diversity.—Any method of diversity transmission and reception where the same information signal is transmitted and received simultaneously on two or more independently fading carrier frequencies.

Frequency-Division Multiplexing (FDM).—A method of deriving two or more simultaneous, continuous channels from a transmission medium connecting two points by assigning separate portions of the available frequency spectrum to each of the individual channels. (NOTE: In optical communications, there is also wavelength-division multiplexing; it involves the use of several distinct optical sources (lasers), each having a distinct center frequency. FDM may be used with any or all of those distinct sources. (Synonym: *carrier multiplex*.)

Frequency drift.—An undesired progressive change in frequency with time. (NOTE 1: Causes of frequency drift include aging and environmental changes. NOTE 2: Frequency drift may be in either direction and is not necessarily linear.)

Frequency Modulation (FM).—The form of angle modulation in which the instantaneous frequency of a sine-wave carrier departs from the carrier frequency by an amount proportional to the instantaneous value of the modulating signal.

Frequency shift.—1. A type of telegraph operation in which the mark and space signals are different frequencies. 2. Any change in the frequency of a radio transmitter or oscillator. (Also called *rf shift*.) 3. In facsimile, a frequency modulation system where one frequency represents picture black and another frequency represents picture white. Frequencies between these two limits may represent shades of gray. 4. An intentional frequency change used for modulation purposes.

Frequency-Shift Keying (FSK).—A form of frequency modulation in which the modulating signal shifts the output frequency between predetermined values. (NOTE 1: Commonly, the instantaneous frequency is shifted between two discrete values termed the *mark* and *space frequencies*. This is a non-coherent form of FSK. NOTE 2: Coherent forms of FSK exist where there is no phase discontinuity in the output signal.) (Synonyms: *frequency-shift modulation* and *frequency-shift signaling*.)

Frequency-shift modulation.—Synonym: *frequency-shift keying*.

FSK.—The abbreviation for *Frequency-Shift Keying*.

Full-duplex circuit.—(See *duplex circuit*.)

Fuse.—An overcurrent protective device with a circuit-opening fusible part that is heated and severed by the passage of overcurrent through it.

Fuse disconnecting switch.—A disconnecting switch in which a fuse unit is in series with or forms a part of the blade assembly.

G

Gain.—The ratio of output current, voltage, or power to input current, voltage, or power, respectively. (NOTE 1: Gain is usually expressed in decibels. NOTE 2: Differences in power levels between points in a system may be expressed as gains. NOTE 3: Gain may be expressed as either a positive or a negative quantity; when a negative quantity, it is usually referred to as *loss*.)

Gain hit.—See *hit*.

Garble.—An error in transmission, reception, encryption, or decryption that changes the text of a message or any portion so that it is incorrect or undecryptable.

Ghost.—A secondary image or signal resulting from echo, envelope delay distortion, or multipath reception.

Greenwich Civil Time (GCT). Synonym: *Greenwich Mean Time*.

Greenwich Mean Time (GMT).—The mean solar time at the meridian of Greenwich, England; used as a basis for standard time throughout the world. Normally expressed in four numerals 0001 through 2400. (Synonyms: *Greenwich Civil Time*, *Universal Time*, and *ZULU time*.)

Ground absorption.—The loss of energy in transmission of radio waves due to dissipation in the ground.

Ground wave.—A radio wave that is propagated over the earth and ordinarily is affected by the presence of the ground. (NOTE: Ground waves include all components of waves over the earth except ionospheric and tropospheric waves, and are affected somewhat by the change in the dielectric constant of the lower atmosphere.)

Group.—1. A number of voice channels, either within a supergroup or separately, that, in wideband systems, is normally composed of up to 12 voice channels occupying the frequency band 60 kHz to 108 kHz (in frequency-division multiplexing). (NOTE 1: This is CCITT Basic Group B. NOTE 2: CCITT Basic Group A (carrier telephone systems) is an assembly of 12 channels, occupying upper sidebands in the 12-kHz to 60-kHz band. It is no longer mentioned in CCITT recommendations.) 2. A supergroup is normally 60 voice channels, or 5 groups of 12 voice channels each, occupying the frequency band 312 kHz to 552 kHz. 3. A mastergroup has 10 supergroups of 600 voice channels. (NOTE 1: The CCITT standard mastergroup contains 5 supergroups; U.S. commercial carriers use 10 supergroups. NOTE 2: The terms *supermastergroup* or *jumbo group* are sometimes used for 6 mastergroups.) 4. A set of characters forming a unit for transmission or cryptographic treatment.

H

Half-duplex circuit.—A circuit that affords communication in **either** direction, but only in one direction at a time. (NOTE: If the transmission direction is reversed very rapidly, a half-duplex circuit can effectively simulate full-duplex operation.)

Half-duplex operation.—The mode of operation in which communications between two terminals occur in **either** direction, but in only one direction at a time. (NOTE: Half-duplex

operation may occur on half-duplex circuits or on duplex circuits, but it may not occur on simplex circuits. (Synonyms: *one-way reversible operation* and *two-way alternate operation*.)

Handshaking.—1. A hardware or software sequence of events requiring mutual consent of conditions prior to change. 2. The process used to establish communications parameters between two stations. (NOTE: Handshaking follows the establishment of a circuit between the stations and precedes information transfer. It is used to agree upon such parameters as information transfer rate, alphabet, parity, interrupt procedure, and other protocol features.)

Hardware.—The physical components of a system.

Harmonic distortion.—1. The presence of frequencies at the output of a device, caused by non-linearities within the device, which are harmonically related to a single frequency applied to the input of the device. The frequency of the first harmonic at the output (also known as the *fundamental frequency*) is the input frequency. 2. The presence of harmonic frequencies in the received signal due to the signal's passage through a non-linear circuit or device.

Hazards of Electromagnetic Radiation to Fuel (HERF).—The potential for electromagnetic radiation to cause spark ignition of volatile combustibles, such as aircraft fuels.

Hazards of Electromagnetic Radiation to Ordnance (HERO).—The potential for munitions or electro-explosive devices to be adversely affected by electromagnetic radiation.

Hazards of Electromagnetic Radiation to Personnel (HERP).—The potential for electromagnetic radiation to produce harmful biological effects in humans.

Heterodyne.—1. The means by which new frequencies are generated by mixing two or more signals in a non-linear device, such as a vacuum tube, transistor, or diode mixer. (NOTE: A superheterodyne receiver converts any selected incoming frequency by heterodyne action to a common intermediate frequency where amplification and selectivity (filtering) are provided.) 2. A frequency produced by mixing two or more signals in a non-linear device.

HF.—The abbreviation for *High Frequency*.

High Frequency (HF).—The frequencies from 3 MHz to 30 MHz.

Hit.—1. A transient disturbance to a communications medium. 2. A comparison of two items of data that occurs when specified conditions are met. 3. A match of two items of data that occurs when a comparison is made.

I

IDF.—The abbreviation for *Intermediate Distribution Frame*.

Idle-channel noise.—The noise that is present in a communications channel when no signals are applied to it. The conditions and terminations must be stated for the value to be significant.

Idle character.—A control character that is sent when there is no information to be sent.

IMP.—The acronym for *Interface Message Processor*.

Impedance matching.—The connection of an additional impedance to an existing one to improve performance or to accomplish a specific effect.

Impulse.—A surge of electrical energy, usually of short duration, of a non-repetitive nature. (Synonym: *surge*.)

Impulse noise.—A noise consisting of random occurrences of energy spikes, having random amplitude and bandwidths, whose presence in a data channel can be a prime cause of errors.

Input/Output (I/O) device.—A device that introduces data into or extracts data from a system.

Interface Message Processor (IMP).—A processor-controlled switch used in packet-switched networks to route packets to their proper destination.

Interference.—1. The extraneous energy from natural or manmade sources that interferes with reception of desired signals in a signal transmission system. (NOTE: Interference is distinguished from noise by its usually narrower spectrum and singular (or limited number of) source(s), whereas noise is incoherent and generally wideband.) 2. The disturbance caused by extraneous energy.

Intermediate Distribution Frame (IDF).—A frame, in a local central telephone or communications office, whose primary purpose is to cross-connect the user line cable to the user line circuit. In a private exchange, the IDF is for similar purposes. (NOTE: Also used as a distribution point for multipair cables from the MDF or CDF to individual cables for equipment in areas remote from the frames.)

Intermediate Frequency (IF).—A frequency to which a signal is shifted locally as an intermediate step in transmission or reception.

I/O.—The abbreviation for *Input/Output*.

Ionosphere.—1. The part of the atmosphere, extending from about 70 to 500 km, in which ions and free electrons exist in sufficient quantities to reflect electromagnetic waves. 2. The part of the atmosphere in which refraction of electromagnetic waves occurs. (NOTE: The chief identifiable regions (or layers) of the ionosphere and their approximate heights are: D region—50 to 90 km (30 to 60 mi), E region—95 to 160 km (60 to 100 mi), and F region—175 to 400 km (100 to 250 mi).)

Ionospheric disturbance.—An increase in the ionization of the D region of the ionosphere, caused by solar activity, which results in greatly increased radio-wave absorption.

Ionospheric scatter.—The propagation of radio waves by scattering due to irregularities in the ionosphere. (Synonyms: *forward propagation ionospheric scatter* and *ionospheric forward scatter*.)

Isochronous.—1. The characteristic of a periodic signal in which the time interval separating any two corresponding transitions is equal to the unit interval or to a multiple of the unit interval. 2. The data transmission in which corresponding

significant instants of two or more sequential signals have a constant phase relationship. (NOTE: Isochronous and anisochronous are characteristics of something, while synchronous and asynchronous are relationships between two things.)

Isochronous signal.—A signal in which the time interval separating any two significant instants is theoretically equal to the unit interval or to a multiple of the unit interval. (NOTE 1: In practice, variations in the time intervals are constrained within specified limits, since there is no way of generating a constant unit interval of time. NOTE 2: Isochronous describes something, while synchronous describes a relationship between two things.)

J

Jitter.—Any abrupt and spurious variations in a signal, such as in interval duration, amplitude of successive cycles, or frequency or phase of successive pulses. (NOTE 1: When used qualitatively, the term must be identified as being time-, amplitude-, frequency-, or phase-related and the form must be specified (e.g., pulse-delay-time jitter or pulse-duration jitter). When used quantitatively, a measure of the time- or amplitude-related variation must be included (e.g., average, rms, peak-to-peak). NOTE 2: The low-frequency cutoff for jitter is below 1 Hz.)

Julian date.—1. The sequential day count, reckoned consecutively from the epoch beginning January 1, 4713 B.C. The Julian date on January 1, 1980, was 2,443,239. 2. The true meaning of Julian data has been corrupted in modern times to refer also to an annual day numbering system in which days of the year are numbered in sequence (i.e., the first day of the year is 001, the second day is 002, and the last day of the year is 365 [366 in leap years]). (NOTE: To avoid ambiguity, the *day of the year*, rather than the *Julian date*, should be used for this purpose.)

K

kHz.—The abbreviation for *kilohertz*.

L

Layer.—1. A stratum, in radio-wave propagation, in the ionosphere in which the variation of free electron density with height attains a maximum value or has some other specified characteristic. 2. A unit into which a telecommunications network architecture may be partitioned.

Leased circuit.—The telephone company dedicated facilities and channel equipment used in furnishing private line service from the telephone network for the exclusive use of a particular party or parties.

LED.—The acronym for *Light-Emitting Diode*.

Level.—A term used to indicate the absolute or relative power at a particular point in a circuit or system.

Level alignment.—The adjustment of transmission levels of single links and of links in tandem to prevent overloading of transmission subsystems.

LF.—The abbreviation for *Low Frequency*.

Light-Emitting Diode (LED).—A semiconductor device that produces incoherent light under suitable operational conditions.

Limiter.—A device in which the power or some other characteristic of the output signal is automatically prevented from exceeding a specified value.

Line.—1. A device for transferring electrical energy from one point to another, such as a transmission line. 2. The scanning element in facsimile or television. 3. The path (trace) of a moving spot on a cathode ray tube. 4. A communications channel. 5. A horizontal sequence of symbols or groups thereof.

Line balance.—The degree of electrical similarity of the two conductors of a transmission line. (NOTE: Improved accuracy of balance reduces pickup of extraneous disturbances of all kinds, including crosstalk.)

Line hit.—See *hit*.

Line-of-Sight (LOS) propagation.—The radio propagation in the atmosphere, which is similar to light transmission in that intensity decreases mainly due to energy spreading according to the inverse-distance law with relatively minor effects, due to the composition and structure of the atmosphere. (NOTE: Line-of-sight propagation is considered to be unavailable when any ray from the transmitting antenna, refracted by the atmosphere, encounters the earth or any other opaque object that prevents the ray from proceeding directly to the receiving antenna.)

Link.—1. The communications facilities existing between adjacent nodes. 2. A portion of a circuit designed to be connected in tandem with other portions. 3. A radio path between two points, called a *radio link*, which may be unidirectional, half-duplex, or (full) duplex. (NOTE: It is generally accepted that the signals at each end of a link are in the same form.) 4. A general communications term used to indicate the existence of communications facilities between points.

Link orderwire.—The voice and data communications circuits between adjacent communications facilities interconnected by a transmission link, specifically used for coordination and control of link activity.

Load.—1. The power consumed by a device or circuit in performing its function. 2. A power-consuming device connected to a circuit. 3. To put programs or data into a register or storage. 4. To place a magnetic tape reel on a tape drive, or to place cards into the card hopper of a card punch or reader.

Local orderwire.—A communications circuit between a technical control facility and selected terminal or repeater locations within the communications complex. (NOTE: In multichannel radio systems, the local orderwire is usually a handset connection at the radio location.)

Log-off.—The procedure that is followed by a user in closing a period of terminal operation.

Log-on.—The procedure that is followed by a user in beginning a period of terminal operation.

Log-periodic antenna.—A broadband, multi-element, unidirectional, narrow-beam antenna whose frequency response characteristics are

repeated at frequencies equally spaced, with the period equal to the logarithm of the ratio that determines the length and spacing of the elements.

Long-haul communications.—The communications that permit users to convey information on a worldwide basis. Compared to tactical communications, long-haul communications are generally characterized by higher levels of users (including the National Command Authority), more stringent performance requirements (higher quality circuits), longer distances between users (up to global distances), higher traffic volume and density (larger sizing of switches and trunk cross-sections), and fixed or recoverable assets. Normally used in reference to the Defense Communications System.

Loop-back.—1. A method of performing transmission tests of access lines from the serving switching center; a method that does not require the assistance of personnel at the served terminal. 2. A method of testing between nodes (not necessarily adjacent), wherein two lines are used with the testing being done at one node and the two lines interconnected at the distant node.

Loop test.—A method of testing used to locate a fault in the insulation of a conductor when the conductor can be arranged to form part of a closed circuit or loop.

Loran.—The acronym for *Long Range Navigation*. A long-range radio navigation position-fixing system, using the time difference of reception of pulse-type transmissions from two or more fixed stations.

Loss.—1. The amount of electrical attenuation in a circuit, or the power consumed in a circuit component. 2. The energy dissipated without accomplishing useful work, usually expressed in decibels.

Lowest Usable Frequency (LUF).—The lowest frequency in the HF band at which the received field intensity is sufficient to provide the required signal-to-noise ratio on 90 percent of the undisturbed days of the month.

Low Frequency (LF).—The frequencies from 30 kHz to 300 kHz.

Low-level keying.—Synonym: *low-level signaling*.

Low-level signaling.—The use on signal lines of low levels of voltage that are between the limits of positive and negative 6 volts. (Synonym: *low-level keying*.)

Low-pass filter.—A filter network that passes all frequencies below a specified frequency with little or no loss, but discriminates strongly against higher frequencies.

M

Magnetic storm.—An abnormal change in the earth's magnetic field, usually lasting for a day or so, and characterized by large deviations from the usual value of at least one component of the field.

Main Distribution Frame (MDF).—A distribution frame, one part terminating the permanent outside lines entering the facility and another part terminating the subscriber line multiple cabling, trunk multiple cabling, and so forth, used for cross-connecting any outside line with any desired terminal in such a multiple or with any other outside line. (NOTE: It usually carries the central office protective devices, and functions as a test point between line and office. In a private exchange, the main distribution frame is for similar purposes. The phrase *outside line* includes radio channels or circuits, as appropriate. Generally, the vertical side of the main distribution frame carries all outside lines and their protective devices, and the horizontal side carries all connections to central equipment that may be assigned to particular outside lines. As used in communications facilities other than telephone, all station lines and equipment terminate on the vertical side, and all patch fields terminate on the horizontal side.) (Synonym: *main frame*.)

Main frame.—Synonym: *main distribution frame*.

Main lobe.—The lobe, in an antenna radiation pattern, containing the direction of maximum radiation intensity.

Maintenance.—1. The action taken to retain material in or to restore it to a specific condition, or to restore it to serviceability. This includes inspection, testing, servicing, classification as to serviceability, repair, rebuilding, and reclamation. 2. The supply and repair action taken to keep a force in condition to carry out its mission. 3. The routine recurring work required to keep a facility (plant, building, structure, ground facility, utility system, or other real property) in such condition that it may be continuously utilized at its original or designed capacity and efficiency for its intended purpose. 4. Any activity, such as tests, measurements, replacements, adjustments, and repairs, intended to eliminate faults or to keep a functional unit in a specified state.

Mark.—One of the two significant conditions of modulation in binary communications. (Synonyms: *marking pulse* and *marking signal*.)

Marking bias.—The uniform lengthening of all marking signal pulses at the expense of all space pulses.

Marking end distortion.—See *end distortion*.

Marking pulse.—Synonym: *mark*.

Marking signal.—Synonym: *mark*.

Master clock.—A clock that generates accurate timing signals for the control of other clocks and possibly of other equipment.

Master frequency generator.—The equipment, in FDM, used to provide system end-to-end carrier-frequency synchronization and frequency accuracy of tones transmitted over the system. (NOTE: The following types of oscillators are used in the DCS FDM systems: Type 1—master carrier oscillator as an integral part of the multiplexer set; Type 2—submaster oscillator equipment or slave oscillator equipment as an integral part of the multiplexer set; Type 3—external master oscillator equipment having extremely accurate and stable characteristics. (Synonym: *master frequency oscillator*.)

Master-slave timing.—A communications timing subsystem where one station or node supplies the timing reference for all other interconnected stations or nodes.

Maximum Usable Frequency (MUF).—The upper limit of the frequencies that can be used at a specified time for radio transmission between two points and involving propagation by reflection from the regular ionized layers of the ionosphere. (NOTE: MUF is a median frequency applicable to 50 percent of the days of a month, as opposed to 90 percent cited for the lowest usable frequency and the optimum traffic frequency.)

MDF.—The abbreviation for *Main Distribution Frame*.

Media.—The telecommunications paths along which the signal is propagated, such as a wire pair, coaxial cable, waveguide, optical fiber, or radio path.

Medium Frequency (MF).—The frequencies from 300 kHz to 3000 kHz.

Megahertz (MHz).—A unit of frequency denoting one million (10^6) Hz.

Message sink.—Synonym: *destination user*.

Message source.—Synonym: *source user*.

Metric system.—A decimal system of measures and weights based on the meter, the kilogram, and the second. (NOTE: The modern version of this system uses *SI Units* or the International System of Units.)

MF.—The abbreviation for *Medium Frequency*.

MHz.—The abbreviation for *megahertz*.

Minimize.—A condition where normal message and telephone traffic is drastically reduced so that messages connected with an actual or simulated emergency shall not be delayed.

Modem.—1. The acronym for *Modulator-Demodulator*. 2. A device that modulates and demodulates signals. (NOTE 1: Modems are primarily used for converting digital signals into quasi-analog signals for transmission and for reconverting the quasi-analog signals into digital signals. NOTE 2: Many additional functions may be added to a modem to provide for customer service and control features.) (Synonym: *signal conversion equipment*.)

Modem patch.—A method of electrically connecting paths of a circuit through the use of back-to-back modems.

Modular jack.—A device that conforms to the Code of Federal Regulations, title 47, part 68, that defines size and configuration of all units that are permitted for connection to the public exchange facilities.

Modulation.—The process, or result of the process, of varying any characteristic of a signal, called a *carrier*, in accordance with a message signal. (NOTE: Modulation may be broadly divided into continuous and pulsed.)

Modulation rate.—The reciprocal, for modulated digital signals, of the unit interval measured in seconds. This rate is expressed in baud.

Modulator.—A device that imposes modulation on a carrier.

Module.—1. An interchangeable plug-in item containing components. 2. A computer programming unit that is discrete and identifiable with respect to compiling, combining with other modules, and loading.

Monitor jack (or key).—A jack (or key) that provides access to communications circuits for the purpose of observing the signal conditions on the circuit without interrupting the service provided by that circuit.

MUF.—The acronym for *Maximum Usable Frequency*.

Multiple.—A system of wiring so arranged that a circuit, a line, or a group of lines are accessible at a number of points. (Synonym: *multipoint*.)

Multiplex (MUX).—See *multiplexing*.

Multiplex aggregate bit rate.—The bit rate in a time-division multiplexer that is equal to the sum of the input channel data signaling rates available to the user, plus the rate of the overhead bits required.

Multiplexer (MUX).—A device for multiplexing two or more channels.

Multiplex hierarchy.—The hierarchy for frequency-division multiplexing.

Multiplexing (MUX).—1. The division of a transmission facility into two or more channels, either by splitting the frequency band transmitted by the channel into narrower bands, each of which constitutes a distinct channel (frequency-division multiplexing), or by allotting this common channel to several different information channels, one at a time (time-division multiplexing). (NOTE: Time-division and frequency-division multiplexing may be combined over the same basic channel.) 2. A function in data transmission that permits two or more data sources (each having its own channel) to share a common transmission medium.

Multiplex link encryption.—The encryption in which a single cryptographic device is used to encrypt all of the data in a multiplexed link.

Multipoint circuit.—A circuit providing transmission among three or more separate points.

MUX.—The acronym for *multiplex*, *multiplexer*, and *multiplexing*.

N

Narrowband modem.—A modem whose modulated output signal has an essential frequency spectrum that is limited to that which can be wholly contained within, and faithfully transmitted through, a voice channel with a nominal 4-kHz bandwidth.

Narrowband signal.—Any analog signal or analog representation of a digital signal whose essential spectral content is limited to that which can be contained within a voice channel of nominal 4-kHz bandwidth.

National Communications System (NCS).—The organization established by Section 1(a) of Executive Order No. 12472 to assist the President, the National Security Council, the Director of the Office of Science and Technology Policy, and the Director of the Office of Management and Budget in the discharge of their national security emergency preparedness telecommunications functions. The NCS consists of both the telecommunications assets of the entities represented on the NCS Committee of Principals and an administrative structure consisting of the Executive Agent, the NCS Committee of Principals, and the Manager.

Neper (Np).—A standard unit for expressing transmission gain or loss and relative ratios. Like the decibel, it is a dimensionless unit, and ITU (CCITT and CCIR). Recommendations recognize both units. Nepers are usually used to express voltage or current ratios, whereas decibels are normally used to express power ratios.)

Net gain.—The overall gain of a transmission circuit. It is measured by applying a test signal of some convenient power at the beginning of a circuit and measuring the power delivered at the other end. The ratio of these powers, expressed in decibels, is the net gain of the circuit under observation. (NOTE: The test signal must be chosen so that its power (level) is within the normal operating range of the circuit being tested.)

Net loss.—The overall loss of a transmission circuit. It is measured by applying a test signal of some convenient power at the beginning of a circuit and measuring the power delivered at the other end. The ratio of these powers, expressed in decibels, is the net loss of the circuit under observation. (NOTE: The test signal must be chosen so that its power (level) is within the normal operating range of the circuit being tested.)

Net loss variation.—The maximum change in net loss occurring in a specified portion of a communications system during a specified period.

Network.—1. An organization of stations capable of intercommunication, but not necessarily on the same channel. 2. Two or more interrelated circuits. 3. A combination of switches, terminals, and circuits that serves a given purpose. 4. A combination of terminals and circuits in which transmission facilities interconnect the user stations directly (i.e., there are no switching, control, or processing centers involved). 5. A combination of circuits and terminals serviced by a single switching or processing center.

Noise.—1. An undesired disturbance within the useful frequency band. 2. The summation of unwanted or disturbing energy introduced into a communications system from manmade and natural sources.

Noise Equivalent Power (NEP).—The radiant power that produces a signal-to-noise ratio of unity at the output of a given detector, at a given

modulation frequency and wavelength, and for a given effective noise bandwidth. It is usually measured in watts.

Noise level.—The volume of noise power, measured in decibels, referred to a base.

Noise measurement units.—A noise is usually measured in terms of power, either relative or absolute. The decibel is the unit for most of these measurements, although the picowatt is also used. A suffix is usually added to denote a particular reference base or specific qualities of the measurement. Examples of noise measurement units are dBa, dBa(f1A), dBa(HA1), dBa0, dBm, dBm(psoph), dBm0, dBm0p, dBrn, dBrnC, dBrn(f₁ - f₂), dBrn(144-line), pW, pWp, and pWp0.

Noise power.—1. The power generated by a random electromagnetic process. 2. The mean power supplied to the antenna transmission line by a radio transmitter when loaded with white noise having a Gaussian amplitude distribution in the acceptance testing of radio transmitters.

Noise weighting.—A specific amplitude-frequency characteristic that permits a measuring set to give numerical readings that approximate the interfering effects to any listener using a particular class of telephone instrument. (NOTE 1: Noise-weighting measurements are made in lines terminated either by the measuring set or by the class of instrument. NOTE 2: The noise weightings generally used were established by agencies concerned with public telephone service, and are based on characteristics of specific commercial telephone instruments, representing successive stages of technological development. The coding of commercial apparatus appears in the nomenclature of certain weightings. The same weighting nomenclature and units are used in military versions of commercial noise-measuring sets.)

Non-critical technical load.—The part of the technical load not required for synchronous operation.

Non-linear distortion.—The distortion caused by a deviation from a linear relationship between specified input and output parameters of a system of components.

Non-synchronous data transmission channel.—A data channel in which no separate timing information is transferred between the DTE and the DCE.

Non-synchronous system.—See *asynchronous transmission*.

Non-technical load.—The part of the total operational load used for general lighting, air conditioning, ventilating equipment, and so forth for normal operation.

Notched noise.—The noise in which a narrow band of frequencies has been removed. Normally used for testing devices or circuits.

O

Optical fiber.—Any filament or fiber, made of dielectric material, that guides light, whether or not it is used to transmit signals.

Optimum traffic frequency (FOT).—The highest frequency that is predicted to be available for skywave transmission over a particular path at a particular hour for 90 percent of the days of the month. (NOTE: The FOT is normally just below the value of the MUF.)

Orderwire circuit.—A voice or data circuit used by technical control and maintenance personnel for coordination and control action relative to activation, deactivation, change, rerouting, reporting, and maintenance of communications systems and services.

Orderwire multiplex.—A multiplex carrier set specifically designed to carry orderwire traffic, as opposed to one designed to carry mission traffic.

Outage.—A telecommunications service condition where a user is completely deprived of service due to any cause within the communications system.

P

PABX.—The abbreviation for *Private Automatic Branch Exchange*.

Packet.—**1.** A group of data and control characters in a specified format, transferred as a whole. **2.** A group of binary digits, including data

and call control signals, that is switched as a composite whole. The data, all control signals, and possibly error control information, are arranged in a specific format.

Packet-switched data transmission service.—A service that provides the transmission of data in the form of packets. (NOTE: This service may or may not provide for the assembly and disassembly of data packets.)

Packet switching.—**1.** A system in which messages are broken down into smaller units called *packets*, that are then individually addressed and routed through the network. **2.** The process of routing and transferring data by addressed packets so that a channel is occupied during the transmission of the packet only. Upon completion of the transmission, the channel is available for the transfer of other traffic.

Packet-switching network.—A network designed to carry data in the form of packets. The packet format, internal to the network, may require conversion at a gateway.

Pad.—An arrangement of fixed resistors used to reduce the strength of any signal a desired fixed amount without introducing appreciable distortion. (NOTE: Also called *fixed attenuator*. The corresponding adjustable arrangement is called an *attenuator*.)

Parabolic antenna.—An antenna consisting of a parabolic reflector and a radiating or receiving element at or near its focus. (NOTE: If the reflector is in the shape of a paraboloid, it is called a *paraboloidal reflector*; cylindrical paraboloids and partial paraboloids are also used.)

Parallel transmission.—The simultaneous transmission of signal elements.

Patch.—To connect circuits together temporarily by means of a cord (cable), known as a *patch cord*.

Patch and Test Facility (PTF).—An organic element of a station or terminal facility that functions as a supporting activity under the technical supervision of a designated Technical Control Facility (TCF). (NOTE: It performs functions such as quality control checks and tests on equipment, links, and circuits; troubleshooting; activation, changing, and deactivation of circuits; technical coordination; and reporting.)

Patch bay.—An assembly of hardware so arranged that a number of circuits, usually of the same or similar type, appear on jacks for monitoring, interconnecting, and testing purposes. (NOTE 1: Patch bays are used at many locations, such as technical control facilities, patch and test facilities, and at telephone exchanges. NOTE 2: Patch bays are often used for special purposes, such as dc, VF, group, coaxial, equal-level, and digital data circuits.)

Patching.—The connection of circuits by means of cords with plugs inserted into appropriate jacks.

Patch panel.—A segment of a patch bay.

Path attenuation.—The losses, in a communications system, undergone by a wave in transit between a transmitter and a receiver. It is usually measured in decibels. (NOTE: It is due to many effects, such as free-space loss, refraction, reflection, aperture-medium coupling loss, and absorption.)

PAX.—The acronym for *Private Automatic Exchange*.

PBX.—1. The abbreviation for *Private Branch Exchange*. 2. A private telecommunications exchange that usually includes access to the public switched network. 3. A switch serving a selected group of users. It is subordinate to a higher level military establishment switch. 4. A private telephone switchboard that provides dial service on a subscriber's premises and serves only those stations with local and trunked communications. (NOTE: A PBX operates with only a manual switchboard; a private automatic exchange does not have a switchboard; a private automatic branch exchange may or may not have a switchboard.)

Peak-to-Average Ratio (P/AR).—The ratio of the instantaneous peak value (amplitude) of a signal to its time-averaged value. (NOTE: Peak-to-average ratio can be determined for voltage, current, power, or other parameters.)

Phase distortion.—Synonym: *delay distortion*.

Phase hit.—See *hit*.

Phase inversion.—The production of a phase difference of 180 degrees between two similar wave shapes of the same frequency.

Phase jitter.—A form of phase perturbation that results in the intermittent shortening or lengthening of signals.

Phase Modulation (PM).—A form of angle modulation in which the phase angle of a carrier departs from its reference value by an amount proportional to the instantaneous value of the modulating function.

Phase shift.—The change in phase of a periodic signal with respect to a reference.

Phase-Shift Keying (PSK).—A method of modulation used for digital transmission where the phase of the carrier is discretely varied in relation to a reference phase, or the phase of the previous signal element, in accordance with the data to be transmitted. (NOTE 1: In PSK systems designed so that the carrier can assume only two different phase angles, then each change of phase (signal element) carries one bit of information (i.e., the bit rate equals the modulation rate). NOTE 2: If the number of recognizable phase angles is increased to 4, then 2 bits of information can be encoded into each signal element. Likewise, 8 phase angles can encode 3 bits in each signal element [e.g., unit interval].)

Polar operation.—A system whereby marking signals are formed by current or voltage pulses of one polarity and spacing signals by current or voltage pulses of equal magnitude but opposite polarity (bipolar signal).

Polling.—A network control system in which a designated control station invites its tributary stations to transmit in any sequence specified by the control station.

Power.—The rate of transfer or absorption of energy per unit time in a system. Power is usually measured in watts.

Power circuit breaker.—1. The primary switch used to apply and remove power from an equipment. 2. A circuit breaker for use on ac circuits rated in excess of 1500 volts.

Power level.—The ratio, at any point in a transmission system, of the power at that point to some arbitrary amount of power chosen as a reference. This ratio is usually expressed either in decibels referred to 1 milliwatt, dBm, or in decibels referred to 1 watt, dBW.

Pre-emption.—The seizure, usually automatic, of system facilities that are being used to serve a lower precedence call to immediately serve a higher precedence call.

Primary power.—A reliable source of power normally serving the station main bus. (NOTE: The source may be a government-owned generating plant or a utility system. A Class A primary power source is one providing an assurance of essentially continuous supply.)

Propagation.—The motion of waves through or along a medium.

Propagation path obstruction.—A manmade or natural physical feature that lies near enough to a radio path to cause a sensible effect on path loss, exclusive of reflection effects. (NOTE: An obstruction may lie to the side, or even above the path, although usually it will lie below the path. Ridges, cliffs, buildings, and trees are examples of obstructions. If the clearance from the nearest anticipated path position, over the expected range of earth radius k-factor, exceeds 0.6 of the first Fresnel zone radius, the feature is not normally considered an obstruction.)

Propagation time delay.—The time required for a signal to travel from one point to another.

Pulse.—One of the elements of a signal, usually repetitive, characterized by the rise and decay in time of its magnitude from a baseline. It is usually short in relation to the time span of interest.

Pulse-Code Modulation (PCM).—The form of modulation in which the modulating signal is sampled, the sample quantized and coded, so that each element of information consists of different kinds or numbers of pulses and spaces.

Q

Quality Assurance (QA).—A planned and systematic pattern of all actions necessary to provide adequate confidence that adequate technical requirements are established, products and services conform to established technical requirements, and satisfactory performance is achieved.

Quality Control (QC).—A management function whereby control of the quality of raw material, assemblies, produced materiel, and services is exercised to prevent production of defective materiel or providing faulty services.

Quasi-analog signal.—A digital signal that has been converted to a form suitable for transmission over a specified analog channel. (NOTE: The specification of the analog channel would include frequency range, frequency bandwidth, signal-to-noise ratio, and envelope delay distortion. When this form of signaling is used to convey message traffic over dialed-up telephone systems, it is often referred to as *voice-data*. A modem may be used for the conversion process.)

Quasi-analog transmission.—A transmission method in which a modulator, used to modulate one or more voice frequency carriers, is used to make a digital signal suitable for transmission over an analog voice circuit, and a demodulator is used to recover the digital signal at the other end of the circuit.

R

Radio.—A method of communicating over a distance by modulating electromagnetic waves and radiating these waves.

Radio Frequency Interference (RFI).—Synonym: *electromagnetic interference*.

Radio Teletypewriter (RTTY).—A teletypewriter employed in a communications system using radio circuits. Such systems are spoken of as *RATT systems*.

RED/BLACK concept.—The concept that electrical and electronic circuits, components, equipments, systems, and so forth, that handle classified plain-language information in electrical signal form (RED) be separate from those that handle encrypted or unclassified information (BLACK). Under this concept, RED and BLACK terminology is used to clarify specific criteria relating to, and to differentiate between, such circuits, components, equipments, systems, and the areas in which they are contained.

RED signal.—A cryptographic system signal containing classified information that has NOT been encrypted.

Reference frequency.—1. A standard fixed frequency from which operational frequencies may be derived or with which they may be compared. (NOTE: The reference frequency may be used to specify an assigned frequency or fix a characteristic or carrier frequency.) 2. A frequency that has a fixed and specified position in the frequency spectrum with respect to the assigned frequency or another reference frequency. (NOTE: The displacement of the reference frequency from the assigned or other reference frequency has the same absolute value and sign as the displacement of the characteristic frequency from the center of the frequency band occupied by the emission.)

Reference noise.—The magnitude of circuit noise chosen to be a reference for measurement. (NOTE: Many different levels with a number of different weightings are in current use and care must be taken to ensure that the proper parameters are stated.)

Refraction.—The bending of a sound, radio, or light wave as it passes obliquely from one medium with one specific index of refraction to another medium with a different index of refraction in which its speed is different.

Regeneration.—1. The gain that results from coupling the output of an amplifier to its input. (Synonym: *positive feedback*.) 2. The action of a regenerative repeater in which digital signals are amplified, reshaped, retimed, and retransmitted. 3. The process of restoring a device, whose information storing state may deteriorate, to its latest undeteriorated state.

Regenerative repeater.—A repeater in which the pulse signals are amplified, reshaped, retimed, and retransmitted.

Relay.—An electromechanical device in which a part that is connected in one circuit enables the control of electrical currents or voltages in other circuits.

Repeater.—A device that amplifies an input signal or, in the case of pulses, amplifies, reshapes, retimes, or performs a combination of any of these functions on an input signal for retransmission. (NOTE: It may be either one-way or two-way type.)

RFI.—The abbreviation for *Radio Frequency Interference*.

RTTY.—The abbreviation for *Radio Teletypewriter*.

S

Sampling frequency.—The rate at which signals in an individual channel are sampled for subsequent modulation, coding, quantization, or any combination of these functions. The sampling frequency is usually specified as the number of samples per unit time.

Scatter.—The process whereby the direction, frequency, or polarization of waves is changed when the waves encounter one or more discontinuities in the medium, which have lengths on the order of a wavelength. (NOTE: The term frequently implies a disordered change in the incident energy.)

Selectivity.—A measure of the ability of a receiver to discriminate between a wanted signal on one frequency and unwanted signals on other frequencies.

Signal distortion.—The shifting of the transition points of the signal pulses from their proper positions relative to the beginning of the start pulse in start-stop teletypewriter signaling. The magnitude of the distortion is expressed in percent of a perfect unit pulse length.

Signal-to-Noise Ratio (SNR).—The ratio of the amplitude of the desired signal to the amplitude of noise signals at a given point in time. (NOTE: Usually expressed in decibels, and in terms of peak value for impulse noise and root-mean-square values for random noise. Both the signal and noise should be defined to avoid ambiguity [e.g., peak-signal to peak-noise ratio].)

Simplex circuit.—1. A circuit that provides transmission in **one** direction only. 2. A circuit using ground return and affording communications in either direction, but in only one direction at a time. (NOTE: The above two definitions are contradictory; however, both are in common use. The user is cautioned to verify the nature of the service specified by this term.)

Simplex operation.—1. A mode of operation in which transmission occurs in only **one** pre-assigned direction. (NOTE: This type of operation may occur over both types of simplex circuits, as well as over half-duplex and duplex circuits.) 2. A mode of operation in which communications between two terminals takes place in either direction, but only one direction at a time. (NOTE 1: This type of operation may occur only on simplex circuits (as defined in simplex circuit definition #2). NOTE 2: These two definitions are contradictory; however, both are in common use. The user is cautioned to verify the nature of the service specified by this term.)

Simplexed circuit.—A 2-wire circuit from which a simplex circuit (simplex circuit definition #2) is derived. The 2-wire circuit and the derived simplex circuit may be used simultaneously.

Single-Frequency (SF) interference.—The interference caused by a single-frequency source (e.g., interference in a data transmission line induced by a 60-Hz source).

Single-harmonic distortion.—The ratio of the power of any single harmonic frequency signal to the power of the fundamental frequency signal. This ratio is measured at the output of a device under specified conditions and is expressed in decibels.

Single-Sideband Suppressed Carrier (SSB-SC) transmission.—The method of single-sideband transmission in which the carrier is suppressed.

Single-Sideband (SSB) transmission.—The method of sideband transmission in which only one sideband is transmitted.

Sink.—The part of a communications system in which messages are considered to be received.

Skip distance.—The minimum distance between the transmitting station and the point of return to the earth of the transmitted wave reflected from the ionosphere.

Skip zone.—A ring-shaped region within the transmission range where signals from a transmitter are not received. It is the area between the farthest points reached by the ground wave and nearest points at which the reflected sky waves come back to earth.

Sky wave.—A radio wave that travels upward in space from the antenna. It may or may not be returned to earth from the ionosphere.

Slave clock.—A clock that is coordinated with a master clock. (NOTE: Such coordination is usually achieved by phase-locking the slave clock to a signal received from the master clock. Optionally, the propagation time delay of the signal from the master clock to the slave clock may be removed (double-endedness) to put the clocks in synchronism [i.e., cause their time markers to occur simultaneously].)

Source.—The part of a communications system from which messages are considered to originate.

Source user.—The user providing the information to be transferred to a destination user during a particular information transfer transaction. (Synonyms: *information source* and *message source*.)

Space diversity.—A method of transmission or reception, or both, used to minimize the effects of fading by the simultaneous use of two or more antennas spaced a number of wavelengths apart.

Spacing bias.—The uniform lengthening of all spacing signal pulses at the expense of all marking signal pulses.

Spacing end distortion.—See *end distortion*.

Spectrum designation of frequency.—A method of referring to a range or band of communications frequencies. In American practice, the designator is a two- or three-letter abbreviation for the name. In ITU practice, the designator is numeric.

Sporadic E.—Synonym: *sporadic E propagation*.

Sporadic E propagation.—The radio-wave propagation by means of returns from irregular ionization appearing at heights of about 90 km to 120 km. (NOTE: The maximum frequency returned from this layer can be much greater than that from the normal E layer. Close to the equator, it is essentially a daytime phenomenon, but, in the auroral zone, it is most prevalent at night.) (Synonym: *sporadic E*.)

Standard test signal.—A single-frequency signal with standardized level generally used for testing the peak power transmission capability and for measuring the total harmonic distortion of circuits or parts of a circuit. (NOTE: For standardized test signal levels and frequencies, see MIL-STD-188-100 for DOD use, and the Code of Federal Regulations, title 47, part 68, for other government agencies.)

Standard test tone.—A single-frequency signal with a standardized level generally used for level alignment of single links and of links in tandem. (NOTE: For standardized test signal levels and frequencies, see MIL-STD-188-100 for DOD use, and the Code of Federal Regulations, title 47, part 68 for other government agencies.)

Start pulse.—See *A-condition* and *start signal*.

Start signal.—One or more bits that precede each character transmitted in start-stop transmissions. (Synonym: *A-condition*.)

Station battery.—A separate battery power source, within a facility, that provides for all significant requirements for dc input power associated with the facility. (NOTE: Such a capability is often centrally located. The batteries may power radio and telephone equipment, as well as provide emergency lighting and controls for equipment.)

Station clock.—The principal clock or alternate clock located at a particular station providing the time reference for all major functions at that station. (NOTE: A station clock may also provide timing or frequency signals to other equipment.)

Station load.—The total power requirements of the integrated station facilities.

Statistical multiplexing.—The multiplexing in which channels are established on a statistical basis (e.g., connections are made according to probability of need).

Statistical time-division multiplexing.—The time-division multiplexing in which connections to communications circuits are made on a statistical basis.

Superhigh Frequency (SHF).—The frequencies from 3 GHz to 30 GHz.

Synchronous system.—A system in which the transmitter and receiver are operating in a fixed time relationship.

Synchronous TDM.—A generic term for a multiplexer in which timing is obtained from a clock that, in turn, controls both the multiplexer and the channel source.

Synchronous transmission.—A transmission process such that between any two significant instants in the overall bit stream, there is always an integral number of unit intervals. (NOTE: Isochronous and anisochronous are characteristics of something, while synchronous and asynchronous are relationships between two things.)

T

Tactical load.—The part of the operational load required by the host service consisting of weapons, detection, command control systems, and related functions.

Tail circuit.—The leased or privately owned communications line from the end of a major transmission link, such as a microwave or satellite link or LAN, to the end user location. (NOTE: Under the primary definition of circuit, a tail circuit is only a part of the circuit.)

TDM.—The abbreviation for *Time-Division Multiplexing*.

Technical area.—A room or area that contains communications or communications-support equipment and requires specific temperature limits.

Technical Control Facility (TCF).—A physical plant, or a designated and specially configured part thereof, containing the necessary distribution frames and associated panels, jacks, and switches; monitoring, test, and conditioning equipment; and orderwire communications to enable telecommunications systems control personnel to exercise the essential operational control over communications paths and facilities, make quality analyses of communications and communications channels, monitor operations and maintenance functions, recognize and correct deteriorating conditions, restore disrupted communications, provide requested on-call circuitry, and otherwise take or direct such actions as may

be required and practicable to ensure the fast, reliable, and secure exchange of information.

Technical load.—The portion of the operational load required for communications, tactical operations, and ancillary equipment, including necessary lighting, air conditioning, or ventilation required for full continuity of communications.

Telecommunications.—A transmission, emission, or reception of signs, signals, writings, images, and sounds, or information of any nature by wire, radio, visual, or other electromagnetic systems.

Telecommunications facilities.—The equipment used for modes of transmission such as telephone, telegraph, teletypewriter, data, facsimile, telephotograph, video, audio, and such corollary items as distribution systems and communications security facilities.

Telecommunications center.—A facility, normally serving more than one organization or terminal, responsible for transmission, receipt, acceptance, processing, and distribution of incoming and outgoing messages.

Telecommunications service.—1. The transmission, emission, or reception of signals, signs, writing, images, sounds, or intelligence of any nature, by wire, cable, satellite, fiber optics, laser, radio, visual, or other electronic, electric, electromagnetic, or acoustically coupled means. This term can include necessary telecommunications facilities. 2. A specified set of user-information transfer capabilities provided to a group of users by a telecommunications system. (NOTE: The telecommunications service user is responsible for the information content of the message. The telecommunications service supplier has the responsibility for the acceptance, transmission, and delivery of the message.)

Teletypewriter Control Unit (TCU).—A device that serves as the control and coordination unit between teletypewriter devices and a message switching center when using controlled teletypewriter operations.

Terminal.—1. A point at which information can enter or leave a communications network. 2. A device capable of sending, receiving, or sending and receiving information over a communications channel.

Terminal impedance.—The complex impedance as seen at the unloaded output terminals of a transmission equipment or line that is otherwise in normal operating condition.

Test point.—The point within an equipment or equipment string that provides electrical access to signals for the purpose of fault isolation.

Test tone.—A tone sent at a predetermined level and frequency through a transmission system to facilitate alignment of the gains and losses of devices in the transmission circuit.

Threshold.—1. The minimum value of a signal that can be detected by the system or sensor under consideration. 2. A value used to denote predetermined levels pertaining to volume of message storage (i.e., intransit storage or queue storage) utilized in a message switching center. 3. The value of the parameter used to activate a device.

Through group.—A group of 12 VF channels that goes through a repeater as a unit without frequency translation.

Time-Division Multiplexing (TDM).—A method of deriving two or more apparently simultaneous channels from a given frequency spectrum of a transmission medium connecting two or more points by assigning discrete time intervals in sequence to each of the individual channels. During a given time interval, the entire available frequency spectrum can be used by the channel to which it is assigned. (NOTE: In general, time-division multiplexing systems use pulse transmission. The multiplex pulse train may be considered to be the interleaved pulse trains of the individual channels. The individual channel pulses may be modulated either in an analog or a digital manner.)

Torn-tape relay.—An antiquated tape relay system in which the perforated tape is manually transferred by an operator to the appropriate outgoing transmitter position.

Total channel noise.—The sum of random noise and intermodulation noise plus crosstalk. (NOTE: Impulse noise is not included, because different techniques are required for its measurement.)

Total harmonic distortion.—The ratio of the sum of the powers of all harmonic frequency signals (other than the fundamental) to the power of the fundamental frequency signal. This ratio is measured at the output of a device under specified conditions and is expressed in decibels.

Transmission.—1. The transfer of electrical power from one location to another over conductors. 2. The dispatching of a signal, message, or other form of information by means of wire, optical fiber, or radio; e.g., telegraphy, telephony, or facsimile.

Transmission control character.—A character or characters used for transmission control and supervision in communications systems and networks. (NOTE: The character may be one or more characters, symbols, or variable-length fields.)

Transmission level.—The power (in dBm), at any point in a transmission system, that should be measured at that point when a standard test signal (0 dBm, 1000 Hz) is transmitted at some point chosen as a reference point. (NOTE: The transmission level of a point is a function of system design and is a measure of the design (or nominal) gain at 1000 Hz of the system between the chosen reference point (known as the *Zero Transmission Level Point* [0-TLP]) and the test point in question. Absolute measurements of the power of test signals at any point are influenced by the expected level, as well as by any deviations of the system from its desired gain.)

Transmission Level Point (TLP).—A point in a transmission system at which the ratio, in decibels, of the power of the test signal at that point to the power of the test signal at a reference point, is specified. (NOTE: A 0-TLP is an arbitrarily established point in a communications circuit to which all relative levels at other points in the circuit are referred. Very often, the measured power level at a point, expressed in decibels relative to a reference, is so closely associated with the point (place) in the circuit that the power level and the point are used interchangeably. A point where a reading of -16 dBm is expected would be a -16 TL point, sometimes abbreviated -16 TLP.)

Transmission loss.—The decrease, in communications, of power during transmission from one point to another, usually expressed in decibels.

Tremendously High Frequency (THF).—The frequencies from 300 GHz to 3000 GHz.

Troposcatter.—Synonym: *tropospheric scatter*.

Troposphere.—1. The lower layers of atmosphere, in which the change of temperature with height is relatively large. It is the region where clouds form, convection is active, and mixing is continuous and more or less complete. 2. The layer of the earth's atmosphere, between the surface and the stratosphere, in which about 80 percent of the total mass of air is concentrated and in which temperature normally decreases with altitude. (NOTE: The thickness of the troposphere varies with season and latitude; it is usually 16 km to 18 km over tropical regions and 10 km or less over the poles.)

Tropospheric scatter.—The propagation of electromagnetic waves by scattering as a result of irregularities or discontinuities in the physical properties of the troposphere.

Tropospheric wave.—A radio wave that is propagated by reflection from a place of abrupt change in the dielectric constant or its gradient in the troposphere. (NOTE: In some cases, the ground wave may be so altered that new components appear to arise from reflection in regions of rapidly changing dielectric constant. When these components are distinguishable from the other components, they are called *tropospheric waves*.)

Trunk.—A single transmission channel between two points that are switching centers or nodes, or both.

U

UHF.—The abbreviation for *Ultrahigh Frequency*.

Ultrahigh Frequency (UHF).—The frequencies from 300 MHz to 3000 MHz.

Ultralow Frequency (ULF).—The frequencies from 300 Hz to 3000 Hz.

Unbalanced line.—A transmission line in which the magnitudes of the voltages on the two conductors are not equal with respect to ground (i.e., a coaxial line).

User.—A person, organization, or other entity that uses the services provided by a telecommunications system for transfer of information to others. (NOTE: A user functions as a source or final destination of user information, or both.)

V

Very-High Frequency (VHF).—The frequencies from 30 MHz to 300 MHz.

Very-Low Frequency (VLF).—The frequencies from 3 kHz to 30 kHz.

VF.—The abbreviation for *Voice Frequency*.

VFCT.—The abbreviation for *Voice Frequency Carrier Telegraph*.

VHF.—The abbreviation for *Very-High Frequency*.

Video signal.—A signal normally used to transmit pictorial and voice information. (NOTE: The transmission bandwidth depends upon the mode of transmission [e.g., slow-scan TV, full-scan, or digitized full-scan].)

VLF.—The abbreviation for *Very-Low Frequency*.

Voice Frequency (VF).—A frequency lying within that part of the audio range that is used for the transmission of speech. (NOTE: VF ranges from 300 Hz to 3400 Hz.) (Synonym: *telephone frequency*.)

Voice Frequency Carrier Telegraph (VFCT).—Synonym: *voice frequency telegraph*.

Voice frequency channel.—A transmission path suitable for carrying, under certain conditions, analog signals and quasi-analog signals.

Voice Frequency Telegraph (VFTG).—A method in which one or more dc telegraph channels are multiplexed into a composite nominal 4-kHz voice frequency channel for further processing through a metallic or radio network.

Voice grade.—A service, in the public regulated services, described by the Code of Federal Regulations, title 47, part 68. (NOTE: The term does not imply any specific signaling or required supervisory scheme.)

Volume Unit (VU).—The unit of measurement for electrical speech power in communications work, as measured by a VU meter in the prescribed manner. (NOTE: The VU meter is a volume indicator in accordance with American National Standard C16.5-1942. It has a scale and specified dynamic and other characteristics to obtain correlated readings of speech power necessitated by the rapid fluctuation in the level of voice signals. Zero VU equals zero dBm (1 milliwatt) in measurements of sine-wave test tone power.)

VOX.—**1.** The acronym for *Voice-Operated Relay Circuit*. **2.** A voice-operated relay circuit that permits the equivalent of push-to-talk operation of a transmitter by the operator.

Z

Z.—The abbreviation for *ZULU time*.

Zero Transmission Level Point (0-TLP).—An arbitrary point in a communications system chosen as the reference for all relative transmission levels. (NOTE: The absolute level at this point is not necessarily 0 dBm.)

Zone of silence.—Synonym: *skip zone*.

ZULU time (Z).—Synonym: *Greenwich Mean Time*.

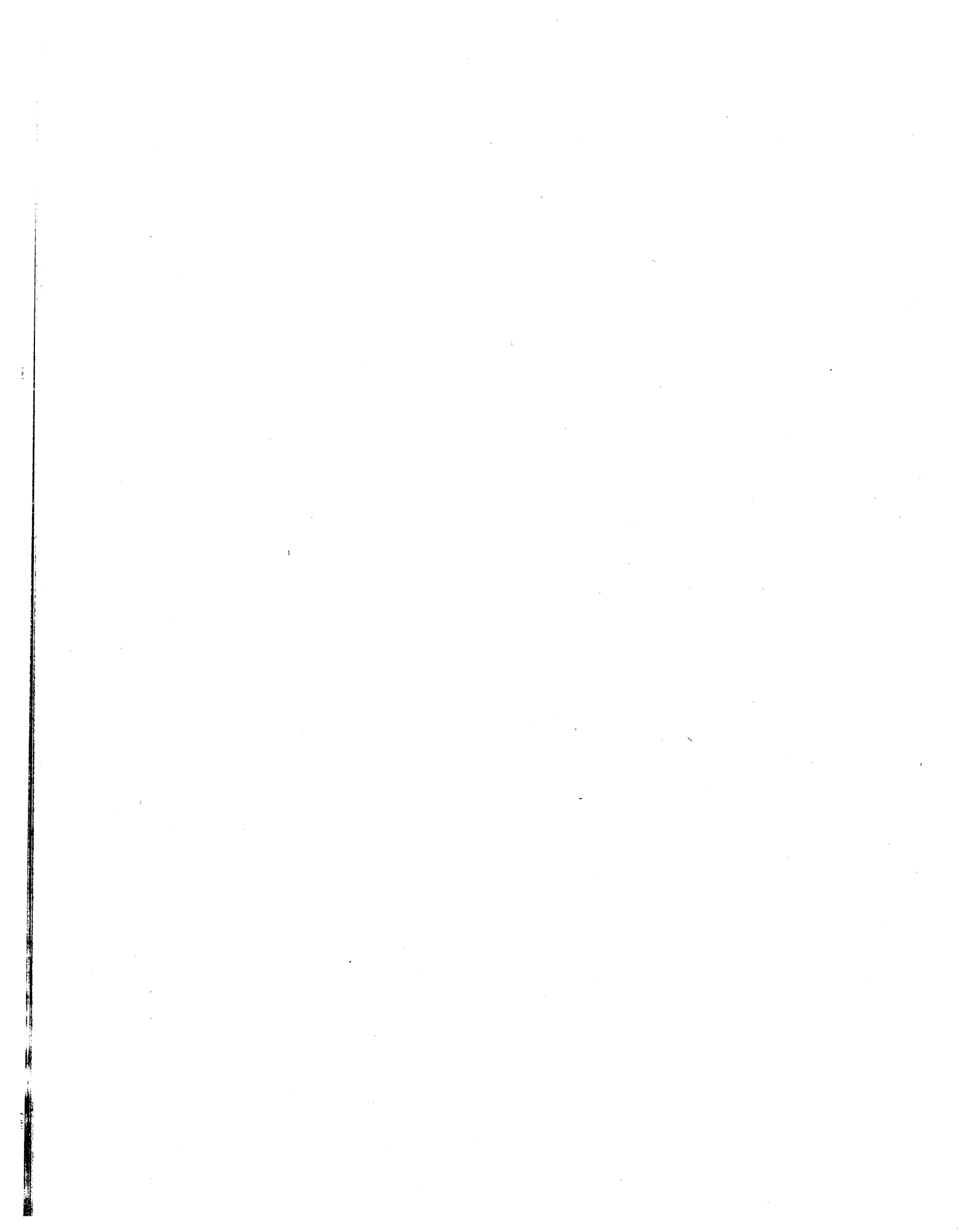

APPENDIX VIII

ACRONYMS AND ABBREVIATIONS

A

ac.—alternate current
ACOC.—Area Communications Operations Center
ACP.—Allied Communications Publication
AF.—Audio Frequency
AM.—Amplitude Modulation
ARS.—Advanced Record System
ASC.—AUTODIN Switching Centers
ASCII.—American Standard Code for Information Interchange
AUTODIN.—Automatic Digital Network
AUTOSEVOCOM.—Automatic Secure Voice Communications
AUTOVON.—Automatic Voice Network.

B

BCDIC.—Binary Coded Decimal Interchange Code
BER.—Bit Error Rate
BERT.—Bit Error Rate Test
bps.—bits per second

C

CASREP.—Casualty Report
CCO.—Communications Control Office
CCSD.—Command Communications Service Designator
CDS.—Clock Distribution System
CHCSS.—Chief, Central Security Service
CIDF.—Classified Intermediate Distribution Frame
CINC.—Commander in Chief
CINCPAC.—Commander in Chief, U.S. Pacific cm.—centimeter
CMS.—CRITICOMM Multiplex System
CNO.—Chief of Naval Operations
COMNAVTELCOM.—Commander, Naval Telecommunications Command
COMSEC.—Communications Security

CPR.—Cardiopulmonary Resuscitation
CRITICOMM.—Critical Intelligence Communications
CRITICOMMSYSMGMT.—CRITICOMM System Management
CRP.—Completion Report
CVSD.—Continuous Variable Slope Delta
CW.—Continuous Wave

D

dB.—decibel
dc.—direct current
DCA.—Defense Communications Agency
DCAC.—DCA Circular
DCAOC.—DCA Operations Center
DCE.—Data Circuit-Terminating Equipment
DCS.—Defense Communications System
DDN.—Defense Data Network
DF.—Direction Finding
DIA.—Defense Intelligence Agency
DIRNSA.—Director, National Security Agency
DOCC.—DCA Operations Control Complex
DOD.—Department of Defense
DSSCS.—Defense Special Security Communications System
DTE.—Data Terminal Equipment
DTS.—Diplomatic Telecommunications Service

E

EBCDIC.—Extended Binary Coded Decimal Interchange Code
EHF.—Extremely High Frequency
EQUIP.—Equipment

F

FAA.—Federal Aviation Agency
FCC.—Federal Communications Commission
FCO.—Facility Control Officer

FDM.—Frequency-Division Multiplexing/
Multiplexer
FLTCINC.—Fleet Commander in Chief
FM.—Frequency Modulation
FTS.—Federal Telecommunications System

G

GENSER.—General Service
GHz.—gigahertz
GMT.—Greenwich Mean Time
GSA.—General Services Administration

H

HAZCON.—Hazardous Condition
HF.—High Frequency
HFDF.—High-Frequency Direction Finding
HSTD.—High-Speed, Time-Division Multi-
plexing
Hz.—Hertz

I

ICN.—Idle Channel Noise
ID.—Identification
IDF.—Intermediate Distribution Frame
IF.—Intermediate Frequency

J

JANAP.—Joint Army-Navy-Air Force Publi-
cation
JCS.—Joint Chiefs of Staff

K

K.—thousand
kbps.—thousand bits per second
kHz.—kilohertz

L

LDX.—Long-Distance Xerography
LED.—Light-Emitting Diode
LF.—Low Frequency
LSB.—Lower Sideband
LSTD.—Low-Speed, Time-Division Multi-
plexing

M

mA.—milliamperes
MBS.—Mission Bit Stream
MDF.—Main Distribution Frame
MF.—Medium Frequency
MHz.—megahertz
MIL-STD.—Military Standard
MODEM.—Modulator and Demodulator
MON.—Monitor
MRC.—Maintenance Requirement Card
ms.—milliseconds
MSL.—Master Station Log
MUSIC.—Multiple-User Special Intelligence
Communications

N

NA.—Not Applicable
NASA.—National Aeronautics and Space Ad-
ministration
NAVELEXSYSCOM.—Naval Electronics Sys-
tems Command
NAVSECGRU.—Naval Security Group
NCA.—National Command Authorities
NCS.—National Communications System
NSA/CSS.—National Security Agency/Central
Security Service
NSGA.—Naval Security Group Activity
NSOC.—National SIGINT Operations Center
NTS.—Naval Telecommunications System

O

O&M.—Operations and Maintenance
ODM.—Operational Directional Message
OPINTEL.—Operational Intelligence
OPNAVINST.—Chief of Naval Operations In-
struction
OPSCOMM.—Operational Communications

P

PAM.—Pulse-Amplitude Modulation
PCM.—Pulse-Code Modulation
PM.—Phase Modulation
PAM.—Pulse-Amplitude Modulation
PTF.—Patch and Test Facility

Q

QC.—Quality Control

R

R/T.—Radiotelephone
RBI.—RED/BLACK Isolator
RCOC.—Regional Communications Operations Center
RF.—Radio Frequency
RFO.—Reason for Outage
RP.—Restoration Priority

S

SATCOM.—Satellite Communications
SECDEF.—Secretary of Defense
SHF.—Superhigh Frequency
SI.—Special Intelligence
SIGINT.—Signals Intelligence
SPINTCOMM.—Special Intelligence Communications
SSB.—Single Sideband
SSO.—Special Security Office/Officer

T

T&A.—Test and Acceptance
TACINTEL.—Tactical Intelligence
TCF.—Technical Control Facility

TCO.—Technical Control Operations
TD.—Test Description
TEP.—Technical Evaluation Program
TDM.—Time-Division Multiplexing/Multiplexer
TICC.—Tactical Information Communications Center
TLP.—Transmission Level Point
TSO.—Telecommunications Service Order
TSR.—Telecommunications Service Request
TTY.—Teletype or Teletypewriter

U

UHF.—Ultrahigh Frequency
UNKN.—Unknown
UPS.—Uninterruptible Power Supply
USB.—Upper Sideband
USMCEB.—U.S. Military Communications Electronics Board

V

VF.—Variable Frequency
VF.—Voice Frequency
VFCT.—Voice Frequency Carrier Telegraph
VHF.—Very-High Frequency
VU.—Volume Unit

W

WB.—wideband

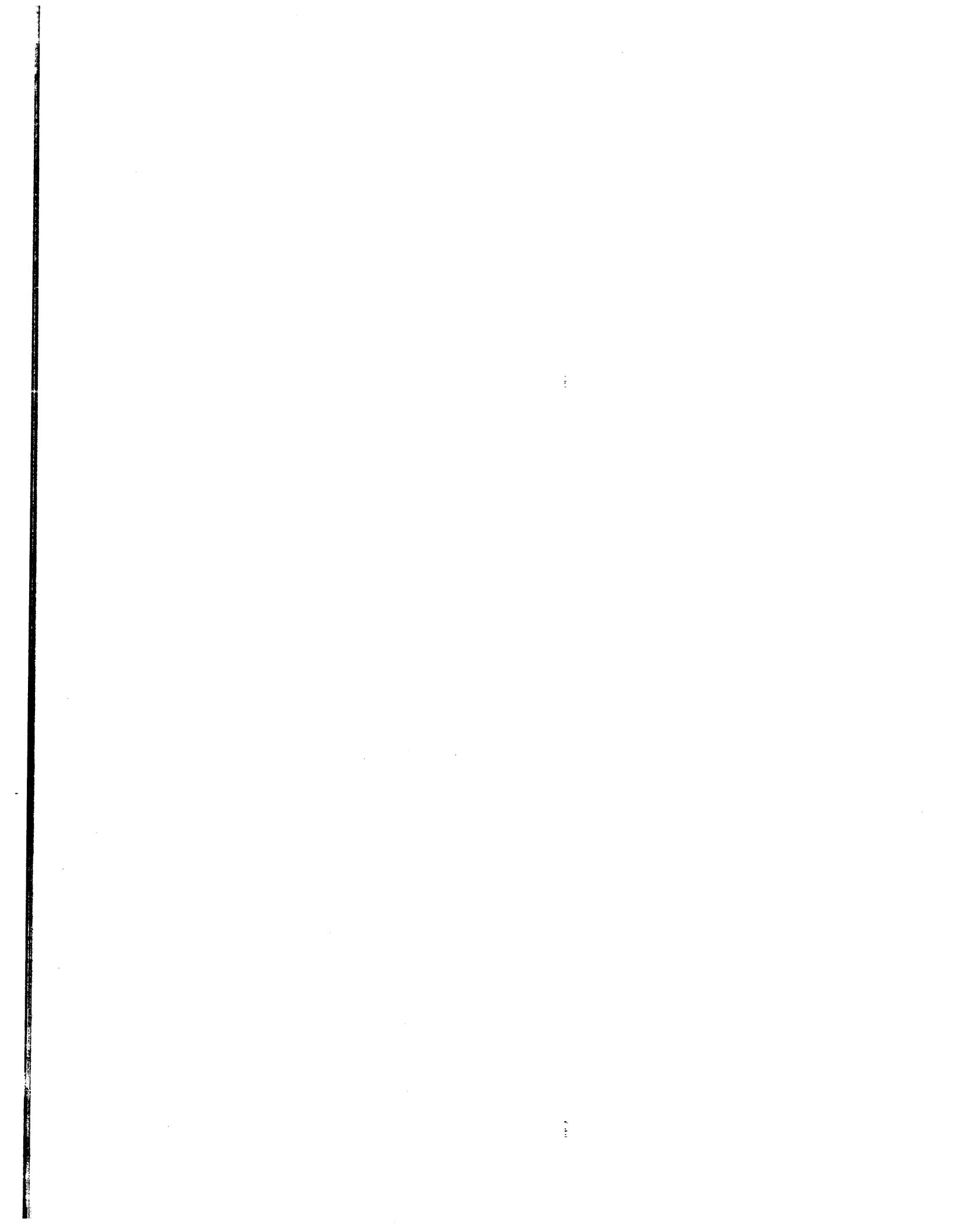

INDEX

A

AC power subsystem, 2-4
Acoustic coupling of modems, 3-16
Acronyms and abbreviations, AVIII-1 to AVIII-3
Alarm & alarm display, 2-2
Alarm circuitry, 4-44
Alarm Panel, SB-3268/UG, 4-23 to 4-25
AM & SSB signals, 3-6
AM receiver, 3-5
AM transmitted signals, 3-6
AM-3A Analyzer Module, AIII-14 to AIII-15
Amplifier, line, 4-11
Amplitude & phase variations, 4-49
Amplitude modulation, 3-1
Amplitude response, AV-7
AN/FCC-100 TDM Terminal, 4-13 to 4-15
AN/USM-329(V)'s analyzer, AIII-30, AIII-32 to AIII-33
AN/USM-329(V)'s oscilloscope, AIII-31, AIII-34
AN/USM-329(V)'s signal generator, AIII-24, AIII-26 to AIII-28
Analog loopback test, 3-16
Analysis, 6-11 to 6-12
Analysis of outages, 6-13
Analysis techniques, AIII-8 to AIII-11
Analyzer & oscilloscope procedures, AIII-31 to AIII-37
Analyzer for the AN/USM-329(V), AIII-30
Analyzer Module, AM-3A, AIII-14 to AIII-15
Analyzer, spectrum, 4-58
Analyzing unknown signals, AIII-11
Antenna systems, 3-8 to 3-12
ASCII, 3-13, AI-6 to AI-7, AIII-21
Asynchronous & synchronous transmission, 3-14 to 3-15
Asynchronous character frame, 3-15
Attenuation-frequency characteristic, 4-50
Audio patch panel, 4-9

B

Ballast Lamp & Fuse Panel, SB-3149/UG, 4-25 to 4-26
Baseband signaling, 4-11
Basic communications theory, 3-1 to 3-24
Baudot code, 3-13
BERTS-25/HP-85, 4-53 to 4-55
Bias distortion, 4-52, AIII-35
Binary coding, AI-1 to AI-2, AI-4
Bit error, 4-46 to 4-47, 4-53 to 4-55
BLACK patch panel, 4-9
Block diagram, FDM system, 3-20
Block diagram, FM receiver & waveforms, 3-6
Block diagram, modulator units, 3-21
Breakout test panels, 4-38 to 4-39
Buffering, 3-16

C

C-notched noise measurement, AV-6
Cable transmission, 3-22
Cardiopulmonary resuscitation, 2-7
CCITT No. 5 Code, AI-7 to AI-8
CDS-10 Clock Distribution System, 4-40 to 4-42
Character Module, CM-2, AIII-18 to AIII-20
Characteristic distortion, 4-52
Circuit, 1-3, 3-18, 3-24, 4-36, 4-44, 4-49, 5-14 to 5-16, 6-1, 6-4 to 6-10, AV-5
Circuit alignment, 1-3
Circuit data card, 5-14 to 5-16
Circuit history folders, 5-16
Circuit interruption, 4-49
Circuit loss measurement, AV-5
Circuit parameter test data, 5-16
Circuit quality control test schedule, 6-5 to 6-8
Circuit routing, 6-1
Circuit switching, 3-18
Classified (RED) patch panel, 4-9
Classified intermediate distribution frame, 4-9

Clock Distribution System, CDS-10, 4-40 to 4-42
 Clocking, AIV-16
 CM-2 Character Module, AIII-18 to AIII-20
 Codes, 3-13, 6-4, AI-1 to AI-9, AIII-9, AIII-20
 to AIII-24
 CODEX LSI-9600 modem, 4-11, AVI-1 to AVI-7
 CODEX LSI-9600 operation, AVI-1 to AVI-4
 CODEX LSI-9600 system test & fault isolation,
 AVI-4 to AVI-7
 Coil, repeat, 4-11
 Communications interface of modems, 3-16
 Communications Patch Panel, SB-3092A/U, 4-30
 Communications Patch Panel, SB-3145/UG, 4-30
 to 4-31
 Communications Patch Panel, SB-3732/UG, 4-33
 to 4-35
 Communications Patch Panel, SB-4012/US, 4-35
 to 4-38
 Communications security, 1-4
 Communications theory, 3-1 to 3-24
 Completion reports, 5-7 to 5-11
 Components of a sine wave, 3-17
 Computer codes, 3-13, AI-3 to AI-9
 Conditioning, line, 3-23
 Continuous-wave transmitter & transmission, 3-2
 to 3-3
 Control cards, AIV-3 to AIV-6, AIV-8 to AIV-11
 Control characters, AI-9
 Controls for AM-3A, AIII-15
 Controls for AN/USM-329(V)'s analyzer, AIII-32
 to AIII-33
 Controls for AN/USM-329(V)'s oscilloscope,
 AIII-34
 Controls for AN/USM-329(V)'s signal generator,
 AIII-26 to AIII-28
 Controls for DM-1B, AIII-18
 Controls for GM-1A, AIII-16 to AIII-17
 Controls for HALCYON 500B, AV-3 to AV-4
 Controls for HALCYON HC-520B2, AVI-1
 to AV-3
 Controls for I/T-1, AIII-12 to AIII-13
 Controls for PP-6521/FG, 4-17, 4-19 to 4-20
 Controls for SB-3145/UG, 4-31
 Controls for SB-3146/UG, 4-32
 Controls for SB-3149/UG, 4-26
 Controls for SB-3268/UG, 4-24
 Controls for SB-3503/FG, 4-23
 Controls for SB-3732/UG, 4-34 to 4-35
 Controls for SB-4012/US, 4-37
 Controls for SMC-200, AIV-1 to AIV-2
 Controls for T16/20, AIV-7 to AIV-11
 Controls for TH-83A/FGC, 4-27
 Coordination, 1-3
 COVERLET system, 2-4, 4-40 to 4-42
 Critical technical load, 2-4

CRITICOMM CSM, 1-9 to 1-10
 Crosstalk, 4-48
 CRT, AII-2 to AII-4
 Crypto Controller, MC-3, 4-15
 Crypto-equipment, 4-9

D

Data circuit control, 3-24
 Data communications, 3-12 to 3-13, 4-55 to 4-56
 Data Communications Analyzer, Data Sentry-10,
 4-55
 Data terminal equipment, 3-13
 Data transmission, AI-9
 Data-switched networks, 3-24
 DCS circuit parameter code cross-reference, 6-4
 DCS technical schedule, 4-50 to 4-51, 6-3 to 6-5
 Dedicated facilities, 3-23
 Defense Communications Agency, 1-8
 Defense Communications System, 1-4, 1-6 to
 1-9
 Delayed service reports, 5-10 to 5-11
 Demultiplexing, SMC-200, AIV-7
 Detection of receivers, 3-3
 Detection, superheterodyne AM receiver, 3-5
 Diagnosis & quality control, 6-1 to 6-14
 Digital Data Distortion Test Set,
 AN/USM-329(V), AIII-21 to AIII-37
 Digital data distortion test sets, 4-59 to 4-61,
 AIII-1 to AIII-37
 Digital data encoding AI-1 to AI-9
 Digital Data Test Set, DIGITECH-2002, 4-60 to
 4-61, AIII-1 to AIII-20
 Digital line drivers, 4-11
 Digital loopback test, 3-16
 Digital modulation rate converter, 4-11
 DIGITECH-2002 Digital Data Test Set, 4-60 to
 4-61, AIII-1 to AIII-20
 Digitizer, voice, 4-11
 Display components, AII-7 to AII-10
 Distortion, 4-51 to 4-52, 6-12, AIII-8 to AIII-11,
 AIII-18, AIII-29, AIII-35 to AIII-36
 Distortion analysis operating procedures, AIII-9
 to AIII-10
 Distortion measurement & analysis techniques,
 AIII-8 to AIII-11
 Distortion Module, DM-1B, AIII-18
 Distribution frames, 4-8 to 4-9
 Distribution Patch Panel, SB-3166/UG, 4-32 to
 4-33
 DM-1B Distortion Module, AIII-18
 Double buffering, 3-16
 DTS-531 Test Set, 4-60 to 4-61
 Dual-trace oscilloscope, AII-1, AII-10

Duties & responsibilities for technical control, 1-1 to 1-3
DYNA-PATCH module wiring, 4-38

E

Early distortion, AIII-10 to AIII-11
EBCDIC, 3-13, AI-5 to AI-6, AIII-22
Echoes, 4-48 to 4-49
EIA standards overview & lines, 3-14
Electrical shock, 2-6 to 2-10
Electromagnetic wave, 3-9 to 3-10, 3-12
Emission designations, 3-22
Encoding & encryption of digital data, AI-1 to AI-9
End distortion measurement, AIII-36
End-to-end testing, 6-9
Envelope delay, 4-51 to 4-52, AV-7
Equalizer, line, 4-11
Equipment descriptions, 4-15 to 4-40
Equipment substitutions, 6-1
Equipment test & acceptance, 6-12 to 6-14
Exception reports, 5-9 to 5-10
Excess-3 BCD code, AI-4
Extended Binary Coded Decimal, AIII-20, AIII-24

F

Facility, typical, 1-5
Fault isolation, 6-2 to 6-3
Fidelity of receivers, 3-4
FM receiver & waveforms, 3-5 to 3-7
Forms, 5-12 to 5-16
Frequency response, AV-7
Frequency modulation, 3-3
Frequency offset, 4-52
Frequency-division multiplexing, 3-19 to 3-20
Full-duplex circuit, 3-24
Fuse Panel, SB-3503/FG, 4-20, 4-22 to 4-23

G

Gaussian noise, 4-46 to 4-47
General circuits, 3-24
Generator Module, GM-1A, AIII-16 to AIII-17
Glossary of terms, AVII-1 to AVII-27
GM-1A Generator Module, AIII-16 to AIII-17
Groundwaves, 3-10

H

HALCYON HC-520B2 Universal Test System, 4-58, AV-1 to AV-7
Half-duplex circuit, 3-24, AIV-7
Hamming codes, AI-8 to AI-9
HAMSTRUNG program, 4-10
Harmonic distortion, 4-52
Heterodyne & superheterodyne AM receivers, 3-5
High-frequency radio transmission, 3-22 to 3-23
High-speed logic control, AIV-2 to AIV-6
High-voltage warning sign, 2-10
Hit measurements, AV-7

I

I/T-1 Input/Timing Module, AIII-11 to AIII-12
Idle channel noise measurement, AV-5 to AV-6
Impulse noise, 4-47
In-effect reports, 5-7 to 5-9
In-service quality control testing, 6-5
In-station circuit diagrams, 5-16
Indicator, volume unit, 4-53
Input/Timing Module, I/T-1, AIII-11 to AIII-12
Intentional shocks, 2-7 to 2-8
Intercommunications subsystem, 2-2
Interface standards, 3-14
Intermediate distribution frame, 4-9
Intermodulation noise, 4-48
International Telegraph Alphabet No. 2 Code, AIII-23
Isolator, 4-43

J

J-2885/UG Terminal Box, 4-6
Jitter, 4-49
Jumpers, 4-8

L

Lamps & switches, SMC-200, AIV-2 to AIV-3
Late peak distortion, AIII-10 to AIII-11, AIII-36
Line amplifier, 4-11
Line capacity & signaling speed, 3-2
Line conditioning, 3-23
Line equalizer, 4-11
Line-of-sight radio transmission, 3-22
Link application, 3-23
Local links, 3-13 to 3-15
Log, master station, 5-12 to 5-13
Logic control, AIV-2 to AIV-6

Long-term path loss variations, 4-50
Loopback test, 3-16
Low-level signals, 4-59

M

M-ary, 4-46 to 4-47, AI-2
Main distribution frame, 4-9
Mainframe terminal boards, 4-8
Major system elements, 4-6 to 4-15
Master station log, 5-12 to 5-13
MC3 Multichannel Crypto Controller, 4-15
ME-400/G Meter Panel, 4-52 to 4-53
Measurement, 4-58 to 4-59, AIII-10 to AIII-11,
AIII-35 to AIII-36, AV-5 to AV-7
Measurement & analysis techniques, AIII-8 to
AIII-11
Media, 3-22
Message switching, 3-18
Meter Panel, ME-400/G, 4-52 to 4-53
Microwave radio, 3-23
Milliammeter, 4-53
Miscellaneous Patch Panel, SB-3146/UG, 4-32 to
4-33
Modem acoustic coupling, 3-16
Modem connectivity, 4-10
Modem control, 3-16
Modem interface, 3-16
Modem synchronization, 4-10 to 4-11
Modem testing, 3-16
Modem timing, 4-10
Modulation, 3-3, 3-20, 3-22
Modulation rate connector, 4-11
Modulation units, 3-21
Module wiring, 4-38
Monitoring, 1-3
Multichannel Crypto Controller, MC3, 4-15
Multicircuit patch cord, 4-36
Multiplexing, 3-17 to 3-20, AIV-7
MUSIC system, 4-1, 4-6

N

National Communications System, 1-8 to 1-9
Naval Telecommunications System, 1-9
Noise, 3-4, 4-46 to 4-48, 6-12, AV-5 to AV-6
Noise-to-ground measurement, AV-6
Non-critical technical load, 2-4
Non-linear attenuation-frequency characteristic,
4-50
Non-linear distortion, AV-6 to AV-7

O

Open wire transmission, 3-22
Operating components, AII-7
OPINTEL system, 4-1, 4-4
OPSCOMM system, 4-1, 4-5
Orderwire subsystem & layout, 2-1 to 2-3
Oscilloscope, 4-56 to 4-57, AII-1 to AII-12,
AIII-31
Out-of-service QC testing, 6-9
Outage analysis, 6-13
Overrun, 3-16

P

P/AR measurement, AV-5
Packet switching, 3-18 to 3-19
Patch cords, 4-36
Patch panels, 4-9, 4-30 to 4-37
Patching & switching, 1-3
Path loss variations, 4-50
Peak distortion, 6-12, AIII-36
Performance monitoring & analysis, 6-11, 6-14
Personal signs, 5-1
Personnel safety, 2-9
Phase & amplitude variation, 4-49
Phase & timing jitter, 4-49, AV-6
Phase change during transmission, 4-48 to 4-49
Phase modulation, 3-3
Phasor operation, AIV-7
Power subsystem, 2-4
Power Supply Assembly, PP-652I/FG, 4-16
to 4-20
Propagation, 3-11 to 3-12
Pseudorandom coding, AI-7 to AI-8
Pulse-trap time duration, 4-39
Pulse-trap wiring diagram, 4-39

Q

Quality control, 6-1 to 6-14

R

Radio communications system, 3-1
Radio transmission, 3-22 to 3-23
RE-1107/UG Relay Assembly, 4-28 to 4-30
Receiver, 3-3 to 3-8
Receiver noise & reception, 3-3 to 3-4
Receiving equipment, 3-1
Records, 5-13 to 5-14
RED patch panel, 4-9

RED/BLACK isolator, 4-43
 Refraction of skywave component, 3-11
 Regenerative repeaters, 4-11
 Relationship of TCF to DCS, 1-7
 Relationship of TCF to PTFs, 1-4
 Relationship of technical control equipments to communications systems, 4-1 to 4-6
 Relay Assembly, RE-1107/UG, 4-28 to 4-30
 Relay stations, 3-22
 Repair service, 6-3
 Repeat coil, 4-11
 Repeater, 3-22, 4-11
 Repeater stations, 3-22
 Reporting, 1-3, 4-54, 5-7 to 5-12
 Rescue of victims, 2-7
 RS-232-C vs RS-449, 3-14
 Rubber matting, 2-8 to 2-9

S

Safety, 2-4 to 2-12
 Satellite radio transmission, 3-22 to 3-23
 SB-3092A/U Communications Patch Panel, 4-30
 SB-3145/UG Communications Patch Panel, 4-30 to 4-31
 SB-3146/UG Miscellaneous Patch Panel, 4-32
 SB-3149/UG Ballast Lamp & Fuse Panel, 4-25 to 4-26
 SB-3268/UG Alarm Panel, 4-23 to 4-25
 SB-3503/FG Fuse Panel, 4-20, 4-22 to 4-23
 SB-3732/UG Communications Patch Panel, 4-33 to 4-35
 Scatter radio, 3-22 to 3-23
 Scope triggering, AII-10
 Screen cycles & patterns, AII-10 to AII-11
 Segmented circuit testing, 6-9 to 6-10
 Select controls, AIII-28 to AIII-31
 Self test, 3-16
 Self-check procedures for HALCYON HC-520B2, AV-4 to AV-5
 Service degradation, 6-3
 Service orders & requests, 5-1 to 5-7
 Set-up procedures for HALCYON HC-520B2, AV-4
 Shocks, 2-7 to 2-8
 Signal, 3-6, 3-23, AIII-11, 4-59
 Signal amplitude components, AII-4 to AII-7
 Signal flow diagrams, 4-2 to 4-7
 Signal generator characteristics, AIII-25
 Signal generator for AN/USM-329(V), AIII-24
 Signaling speed & line capacity, 3-23
 Signals analysis, AIII-11
 Signs, 2-10 to 2-11
 Silo, 3-16

Simplex circuit, 3-24
 Sine wave, 3-17
 Six-bit transcode & code, 3-13, AI-4 to AI-5
 Skywave propagation, 3-10 to 3-11
 SMC-200 TDM Terminal, AI-1 to AI-11
 Spacewave propagation, 3-11 to 3-12
 Spectrum analysis & measurements, 4-58 to 4-59
 Speed error measurement, AIII-10
 SSB communications & receiver, 3-7 to 3-8
 SSB transmitted signals, 3-6
 ST2D terminal device, 4-10
 Start bit, 3-15
 Station loads, 2-5
 Station power subsystem, 2-4
 Status reporting responsibilities, 5-11 to 5-12
 Stop bit, 3-15
 STREAMLINER system, 4-1 to 4-2
 Subvoice band, 3-23
 Superheterodyne AM receiver & waveforms, 3-4 to 3-5
 Superheterodyne FM receiver, 3-5 to 3-7
 Switches & lamps, SMC-200, AIV-2 to AIV-3
 Synchronization, 2-2 to 2-4, AIV-6 to AIV-7
 Synchronous transmission & operations, 3-15, AIII-7
 System diagnosis & quality control, 6-1 to 6-14
 System elements, 4-6 to 4-15

T

T16/20/96 TDM Terminals, 4-13, AIV-7 to AIV-11
 Table top panel, 4-33
 TACINTEL system, 4-1, 4-3
 Tag-out procedures, 2-9 to 2-10
 TCF & PFC loads, 2-5
 TCF equipment arrangement, 4-16
 TDM Terminal, A16/20, AIV-7 to AIV-11
 TDM Terminal, AN/FCC-100, 4-13
 TDM Terminal, SMC-200, AIV-1 to AIV-11
 TDM-modem test sets, 4-55 to 4-57
 Technical control administration, 5-1 to 5-16
 Technical control communications work order 5-14
 Technical control equipments, 4-1 to 4-61
 Technical control logs, 5-1 to 5-16
 Technical control responsibilities, functions & operations, 1-1 to 1-4
 Technical control signal flow diagram, 4-7
 Technical control systems & subsystems, 1-3 to 1-4, 2-1 to 2-12
 Technical load, 2-4
 Telecommunications service orders & requests, 5-1 to 5-7

Telecommunications terminal device, ST2D, 4-10
 Telegraph Hubbing Repeater, TH-83A/FGC,
 4-25, 4-27 to 4-28
 Teletype equipment, 4-9
 Teletypewriter codes, AI-2
 Terminal boards, 4-6, 4-8
 Terminal Box, J-2885/UG, 4-6
 Terminal equipment, 3-1
 Terminal position, 4-9
 Test & acceptance of new equipment, 6-12 to 6-14
 Test panels, 4-38 to 4-39
 Test parameters report, 4-54
 Test procedures for HALCYON HC-520B2,
 AV-5 to AV-7
 Test results, 6-10 to 6-11
 Test schedule flexibility, 6-10
 Test Set, DIGITECH-2002, 4-60 to 4-61
 Test Set, DTS-531, 4-60 to 4-61
 Test Set, TDM-Modem, 4-55, 4-57
 Test Set, USM-329, 4-59 to 4-60
 Testing, 1-3, 3-16, 4-38 to 4-39, 4-52 to 4-61,
 5-16, 6-5 to 6-14
 Testing equipments, 4-52 to 4-60
 Testing order, 6-10
 Testing requirements, 6-10
 Testing with modems, 3-16
 TH-83A/FGC Telegraph Hubbing Repeater,
 4-25, 4-27 to 4-28
 Time-division multiplexing, 3-17 to 3-19, 4-12 to
 4-15, 4-55 to 4-57, AIV-1 to AIV-11
 Time-division switching, 3-17 to 3-19
 Timing & phase jitter, 4-49
 Timing & synchronization subsystem, 2-2 to 2-4
 Total peak measurements, AIII-9 to AIII-10
 Transmission, 3-1, 3-6, 3-15, 3-22 to 3-23, 4-40,
 4-45 to 4-52, 6-1
 Transmission impairments, 4-40, 4-45 to 4-52
 Transmission media, 3-22
 Transmission quality supervision, 6-1
 Transmission signals, 3-6
 Transmitting equipment, 3-1

Trend analysis, 6-11 to 6-12
 Trending noise level, 6-12
 Trending number of outages, 6-13
 Trending peak distortion, 6-12
 Trigger, AII-8 to AII-10
 Tropospheric scatter radio, 3-22 to 3-23
 Trouble & restoration records, 5-13 to 5-14
 Troubleshooting procedures, PP-6521/FG, 4-21
 Troubleshooting procedures, TH-83A/FGC, 4-28
 TSO numbering & distribution, 5-2 to 5-7
 Twenty-mA Loops, 3-13 to 3-14

U

Unclassified (BLACK) patch panel, 4-9
 Universal Test System, HALCYON HC-520B,
 4-58
 U.S. Military Communications Electronics Board,
 1-9
 USM-329 Test Set, 4-59 to 4-60
 Utility load, 2-4

V

Vertical operating mode components, AII-7
 VHF, UHF & microwave radio, 3-23
 Victim rescue, 2-7
 Voice band, 3-23
 Voice digitizer, 4-11
 Volume unit indicator, 4-53

W

Warning tags, signs & posters, 2-7 to 2-11
 Waveform display components, AII-2
 White noise, 4-46 to 4-47
 Wideband grade, 3-23
 Wiring, 4-38 to 4-39

