

NAVSHIPS 91697A

INSTRUCTION BOOK

for

ANTENNA COUPLER
CU-168/FRR

COLLINS RADIO COMPANY
CEDAR RAPIDS, IOWA

BUREAU OF SHIPS

NAVY DEPARTMENT

Contract: NObsr-49175
Contract: NObsr-52727

Approved by BuShips: 10 September 1952

LIST OF EFFECTIVE PAGES

PAGE NUMBERS	CHANGE IN EFFECT	PAGE NUMBERS	CHANGE IN EFFECT
Title page	Original	4-1	Original
A to C	Original	5-0	Original
i to v	Original	6-1	Original
1-0 to 1-2	Original	7-0 to 7-13/7-14	Original
2-1 to 2-3	Original	8-1 to 8-21	Original
3-0 to 3-3/3-4	Original	i-0 to i-2	Original



DEPARTMENT OF THE NAVY
BUREAU OF SHIPS
WASHINGTON 25, D. C.

IN REPLY REFER TO
Code 993-100

10 September 1952

From: Chief, Bureau of Ships
To: All Activities concerned with the Installation,
Operation and Maintenance of the Subject Equipment.

Subj: Instruction Book for Antenna Coupler CU-168/FRR
NAVSHIPS 91697(A)

1. This non-registered publication is the instruction book for the subject equipment and is in effect upon receipt, superseding NAVSHIPS 91697.
2. It contains RESTRICTED SECURITY INFORMATION and shall be handled, transported, and safeguarded in accordance with the U. S. Navy Security Manual for Classified Matter. When superseded by a later edition, this publication shall be destroyed. It may not be carried in aircraft for use therein.
3. Any person known to be in the service of the United States and persons of undoubted loyalty and discretion who are cooperating in government work may have access to this publication. However, information contained herein shall not be communicated to the public or to the press.
4. This document contains information affecting the National Defense of the United States within the meaning of the Espionage Laws, Title 18, U. S. C., Sections 793 and 794. The transmission or the revelation of its contents in any manner to an unauthorized person is prohibited by law.
5. Extracts from this publication may be made to facilitate the preparation of other Department of Defense Publications. It is forbidden to make extracts for any other purpose without specific approval of the Chief of the Bureau of Ships, except as provided for in the U. S. Navy Security Manual for Classified Matter.
6. All requests for NAVSHIPS Electronics publications should be directed to the nearest District Publications and Printing Office. When changes or revised books are distributed, notice will be included in the Bureau of Ships Journal and in the Index of Bureau of Ships General and Electronics Publications, NAVSHIPS 250-020.

H. N. WALLIN
Chief of Bureau

TABLE OF CONTENTS

Paragraph	Page	Paragraph	Page
SECTION 1 - GENERAL DESCRIPTION		SECTION 5 - OPERATOR'S MAINTENANCE	
1. Purpose and Principles	1-1	1. Routine Check Chart	5-0
2. Description of Units	1-1	2. Emergency Maintenance	5-0
3. Reference Data	1-2		
SECTION 2 - THEORY OF OPERATION		SECTION 6 - PREVENTIVE MAINTENANCE	
1. General	2-1	1. Routine Maintenance Check Chart	6-1
2. Circuit Analysis	2-1	2. Lubrication	6-1
a. Transformer	2-1	3. Tropicalization	6-1
b. Artificial Transmission Line	2-2		
c. Termination	2-2	SECTION 7 - CORRECTIVE MAINTENANCE	
d. R-F Amplifier	2-2	Failure Reports	7-0
e. Power Supply	2-3	1. Theory of Localization	7-1
SECTION 3 - INSTALLATION		2. System Trouble Shooting	7-1
1. Unpacking	3-0	3. Unit Trouble Shooting and Repair	7-1
2. Installation	3-0	a. Precautions	7-1
3. Initial Adjustments	3-1	b. Trouble Shooting	7-3
4. Power Connection	3-2	(1) Amplifier Unit	7-3
5. Antenna Connection	3-2	(2) Power Unit	7-3
6. Connection to System	3-2	(3) Transmission Line	7-3
7. Termination	3-2	c. Repair	7-3
a. Single Antenna Coupler	3-2	(1) Electrical Adjustments	7-3
b. Tandem Antenna Coupler	3-2	(2) Mechanical Adjustments	7-3
SECTION 4 - OPERATION		(3) Components Characteristics	7-3
1. Capabilities and Limitations	4-1	SECTION 8 - PARTS LISTS	
2. Operation	4-1		

LIST OF ILLUSTRATIONS

SECTION 1 - GENERAL DESCRIPTION			SECTION 4 - OPERATION		
Figure	Title	Page	Figure	Title	Page
1-1	Antenna Coupler CU-168/FRR and Accessories	1-0	4-1	Antenna Coupler CU-168/FRR, Panel, Front View	4-1
1-2	Antenna Coupler CU-168/FRR, Rear Oblique View	1-1			
SECTION 2 - THEORY OF OPERATION			SECTION 7 - CORRECTIVE MAINTENANCE		
2-1	Antenna Coupler CU-168/FRR, Block Diagram	2-1	7-1	Failure Reports, Sample Form	7-0
2-2	Construction of Transformer T-201	2-2	7-2	Method of Measuring Gain	7-4
			7-3	Main Chassis, Rear View	7-4
			7-4	Main Chassis, Front Internal View	7-5
			7-5	R-F Amplifier (AM-101), Bottom Oblique Interior View	7-5
SECTION 3 - INSTALLATION			7-6	R-F Amplifier (AM-101), Top Interior View	7-6
3-1	Antenna Coupler CU-168/FRR, Dimensional Outline Diagram	3-0	7-7	Power Supply (PU-101), Front Interior View	7-6
3-2	Fabrication Instructions for UG-21B/U to RG-11/U	3-1	7-8	Antenna Coupler CU-168/FRR, Schematic Diagram	7-13/7-14
3-3	Typical R-F Distribution System for Radio Receiver Stations	3-3/3-4			

LIST OF TABLES

SECTION 1 - GENERAL DESCRIPTION		SECTION 7 - CORRECTIVE MAINTENANCE			
1-1	Equipment Supplied	1-2	7-4	Tube Operating Voltages and Currents	7-11
1-2	Equipment Required But Not Supplied	1-2	7-5	Tube Characteristics	7-11
1-3	Shipping Data	1-2	7-6	Winding Data	7-12
1-4	Electron Tube Complement	1-2			
SECTION 5 - OPERATOR'S MAINTENANCE		SECTION 8 - PARTS LISTS			
5-1	Routine Check Chart	5-0	8-1	Weights and Dimensions of Spare Parts Boxes	8-2
SECTION 6 - PREVENTIVE MAINTENANCE		8-2	8-2	Shipping Weights and Dimensions of Spare Parts Boxes	8-2
6-1	Routine Maintenance Check Chart	6-1	8-3	List of Subassemblies	8-2
SECTION 7 - CORRECTIVE MAINTENANCE		8-4	8-3	Table of Replaceable Parts	8-3
7-1	Trouble Shooting Chart	7-2	8-5	Maintenance Parts Kit	8-19
7-2	Terminal Voltage Chart	7-7	8-6	Cross Reference Parts List	8-19
7-3	Terminal Resistance Chart	7-9	8-7	Color Codes and Miscellaneous Data	8-20
			8-8	List of Manufacturers	8-21

GUARANTEE

The equipment, including all parts and spare parts, except vacuum tubes, batteries, rubber and material normally consumed in operation, is guaranteed for a period of one year from the date of delivery of the equipment to and acceptance by the Government with the understanding that all such items found to be defective as to material, workmanship or manufacture will be repaired or replaced, f. o. b. any point within the continental limits of the United States designated by the Government, without delay and at no expense to the Government; provided that such guarantee will not obligate the Contractor to make repair or replacement of any such defective items unless the defect appears within the aforementioned period and the Contractor is notified thereof in writing within a reasonable time and the defect is not the result of normal expected shelf life deterioration.

To the extent the equipment, including all parts and spare parts, as defined above, is of the Contractor's design or is of a design selected by the Contractor, it is also guaranteed, subject to the foregoing conditions, against defects in design with the understanding that if ten percent (10%) or more of any such said item, but not less than two of any such item, of the total quantity comprising such item furnished under the contract, are found to be defective as to design, such item will be conclusively presumed to be of defective design and subject to one hundred percent (100%) correction or replacement by a suitably redesigned item.

All such defective items will be subject to ultimate return to the Contractor. In view of the fact that normal activities of the Naval Service may result in the use of equipment in such remote portions of the world or under such conditions as to preclude the return of the defective items for repair or replacement without jeopardizing the integrity of Naval communications, the exigencies of the Service, therefore, may necessitate expeditious repair of such items in order to prevent extended interruption of communications. In such cases the return of the defective items for examination by the Contractor prior to repair or replacement will not be mandatory. The report of a responsible authority, including details of the conditions surrounding the failure, will be acceptable as a basis for affecting expeditious adjustment under the provisions of this contractual guarantee.

The above one year period will not include any portion of time the equipment fails to perform satisfactorily due to any defects, and any items repaired or replaced by the Contractor will be guaranteed anew under this provision.

INSTALLATION RECORD

Contract Number NObsr-49175	Date of Contract, 2 June 1950
Contract Number NObsr-52727	Date of Contract, 29 June 1951
<i>Serial Number of equipment</i>	
<i>Date of acceptance by the Navy</i>	
<i>Date of delivery to contract destination</i>	
<i>Date of completion of installation</i>	
<i>Date placed in service</i>	

Blank spaces on this page shall be filled in at time of installation.

REPORT OF FAILURE

Report of failure of any part of this equipment, during its entire service life, shall be made to the Bureau of Ships in accordance with current regulations using form NAVSHIPS NBS 383 (revised) except for Marine Corps equipment, in which case the "Signal Equipment Failure Report" form shall be used and distributed in accordance with instructions pertaining thereto. The report shall cover all details of the failure and give the date of installation of the equipment. For procedure in reporting failures see Chapter 67 of the *Bureau of Ships Manual* or superseding instructions.

ORDERING PARTS

All requests or requisitions for replacement material should include the following data:

1. Federal stock number or, when ordering from a Marine Corps or Signal Corps supply depot, the Signal Corps stock number.
 2. Name and short description of part.
- If the appropriate stock number is not available the following shall be specified:
1. Equipment model or type designation, circuit symbol, and item number.
 2. Name of part and complete description.
 3. Manufacturer's designation.
 4. Contractor's drawing and part number.
 5. JAN or Navy type number.

DESTRUCTION OF ABANDONED MATERIAL IN THE COMBAT ZONE

In case it should become necessary to prevent the capture of this equipment, and when ordered to do so, **DESTROY IT SO THAT NO PART OF IT CAN BE SALVAGED, RECOGNIZED, OR USED BY THE ENEMY. BURN ALL PAPERS AND BOOKS.**

Means:

1. Explosives, when provided.
2. Hammers, axes, sledges, machetes, or whatever heavy object is readily available.
3. Burning by means of incendiaries such as gasoline, oil, paper or wood.
4. Grenades and shots from available firearms.
5. Burying all debris, where possible and when time permits.
6. Throwing overboard or disposing of in streams or other bodies of water.

Procedure:

1. Obliterate all identifying marks. Destroy nameplates and circuit labels.
2. Demolish all panels, castings, switch and instrument boards.
3. Destroy all controls, switches, relays, connections and meters.
4. Rip out all wiring and cut interconnections of electrical equipment. Smash gas, oil, and water cooling systems in gas engine generators, etc.
5. Smash every electrical or mechanical part, whether rotating, moving or fixed.
6. Break up all operating instruments such as keys, phones, microphones, etc.
7. Destroy all classes of carrying cases, straps, containers, etc.
8. Bury or scatter all debris.

DESTROY EVERYTHING!

SAFETY NOTICE

The attention of officers and operating personnel is directed to Chapter 67 of the *Bureau of Ships Manual* or superseding instructions on the subject of radio-safety precautions to be observed.

This equipment employs voltage which are dangerous and may be fatal if contacted by operating personnel. Extreme caution should be exercised when working with the equipment.

While every practicable safety precaution has been incorporated in this equipment, the following rules must be strictly observed:

KEEP AWAY FROM LIVE CIRCUITS:

Operating personnel must at all time observe all safety regulations. Do not change tubes or make adjustments inside equipment with high voltage supply on. Under certain conditions dangerous potentials may exist in circuits with power controls in the off position due to charges retained by capaci-

tors. To avoid casualties always remove power and discharge and ground circuits prior to touching them.

DON'T SERVICE OR ADJUST ALONE:

Under no circumstances should any person reach within or enter the enclosure for the purpose of servicing or adjusting the equipment without the immediate presence or assistance of another person capable of rendering aid.

DON'T TAMPER WITH INTERLOCKS:

Do not depend upon door switches or interlocks for protection but always shut down motor generators or other power equipment. Under no circumstances should any access gate, door, or safety interlock switch be removed, short-circuited, or tampered with in any way, by other than authorized maintenance personnel, nor should reliance be placed upon the interlock switches for removing voltages from the equipment.

RESUSCITATION

AN APPROVED POSTER ILLUSTRATING THE RULES FOR RESUSCITATION BY THE PRONE PRESSURE METHOD SHALL BE PROMINENTLY DISPLAYED IN EACH RADIO, RADAR, OR SONAR ENCLOSURE. POSTERS MAY BE OBTAINED UPON REQUEST TO THE BUREAU OF MEDICINE AND SURGERY.

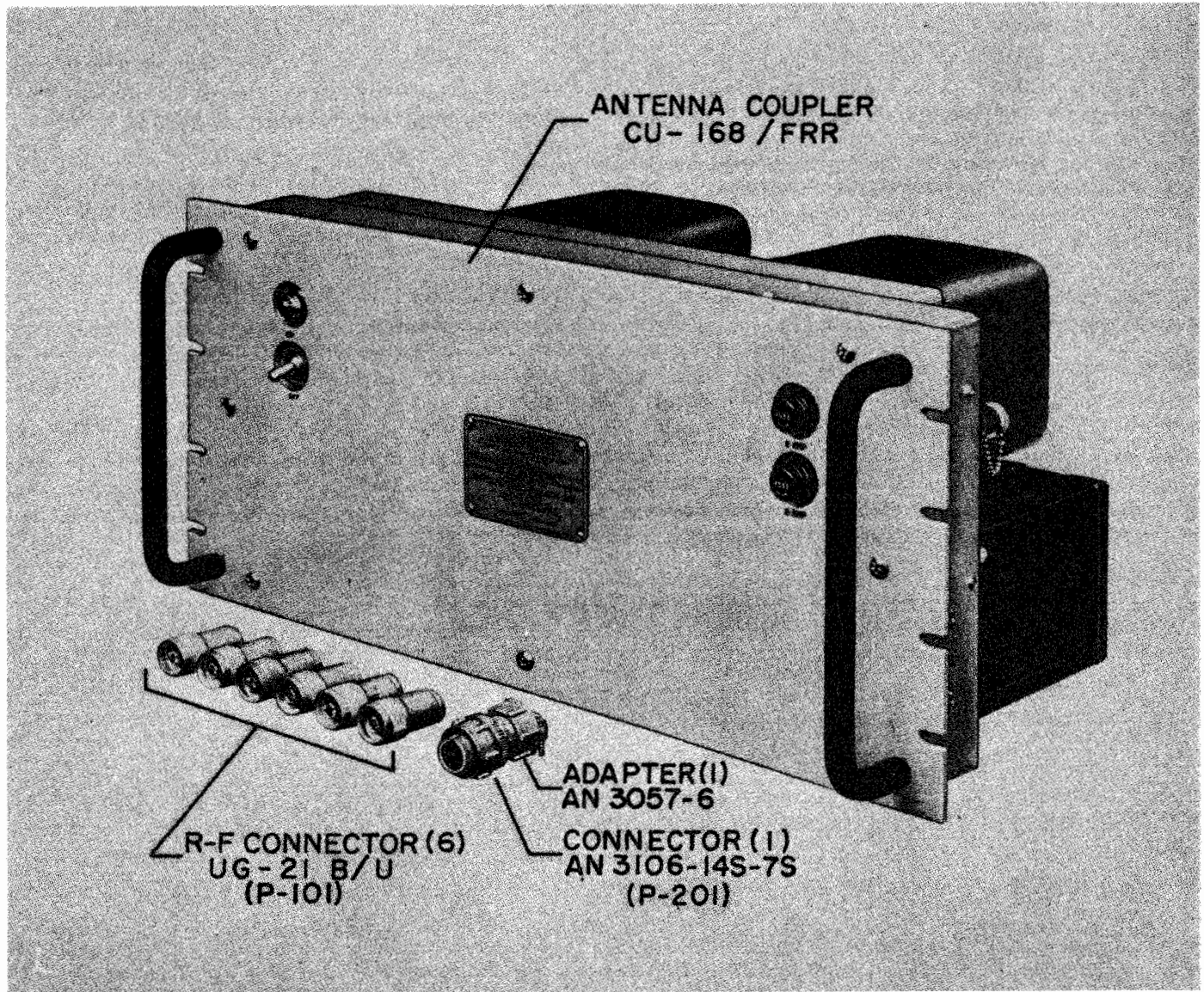

Figure 1-1. Antenna Coupler CU-168/FRR and Accessories

SECTION 1 GENERAL DESCRIPTION

1. PURPOSE AND PRINCIPLES.

Antenna Coupler CU-168/FRR (see figure 1-1) is a shore station equipment which provides means for operating up to five Navy communications receivers from a single receiving antenna. Additional antenna couplers may be connected in tandem in order to provide antenna inputs for additional receivers. The equipment is intended for installation and use in Navy shore receiving stations. The equipment is complete with power supply and contains all necessary parts and circuitry to provide the specified performance. The primary power source can be either 105, 115, or 125 volts, at any frequency from 50 to 400 cps, single-phase. The input circuit to which the antenna is connected is designed for operation from an unbalanced antenna transmission line having a nominal impedance of 70 ohms. Outputs to receivers are also nominal 70 ohms. This equipment permits operation over the frequency range of 2 to 32 megacycles per second. No adjustment or tuning is required.

2. DESCRIPTION OF UNITS.

a. The antenna coupler is mounted on a standard 19-inch rack panel, is 8-3/4 inches high, and is equipped with two pull handles for inserting and removing the

equipment. The front of the panel is finished in standard Navy gray enamel. Other chassis parts, with the exception of the r-f amplifiers, are finished in clear water-dip lacquer. The panel forms the cover of the main chassis, which in turn supports a number of plug-in subassemblies (see figure 1-2).

b. Each of the five r-f amplifiers (see figure 1-2) contains four type 12AU7 double-triode amplifier tubes and related components. Electrical connections are made when the amplifiers are mounted on the main chassis and secured with two captive screws. Connections to the communications receivers are made through the r-f connectors on the rear of each amplifier. Each amplifier has a dust cover which can be removed without interrupting operation of the equipment. The covers are finished in dull black lacquer. They are secured by two dzus fasteners located near jack J-101. The covers may be removed without interrupting operation of the equipment.

c. The power supply subassembly (see figure 1-2) contains a power transformer, type 5U4G rectifier tube, filter, and related components. The subassembly is retained on the main chassis by means of six captive screws. Electrical connections are completed when the power supply is mounted.

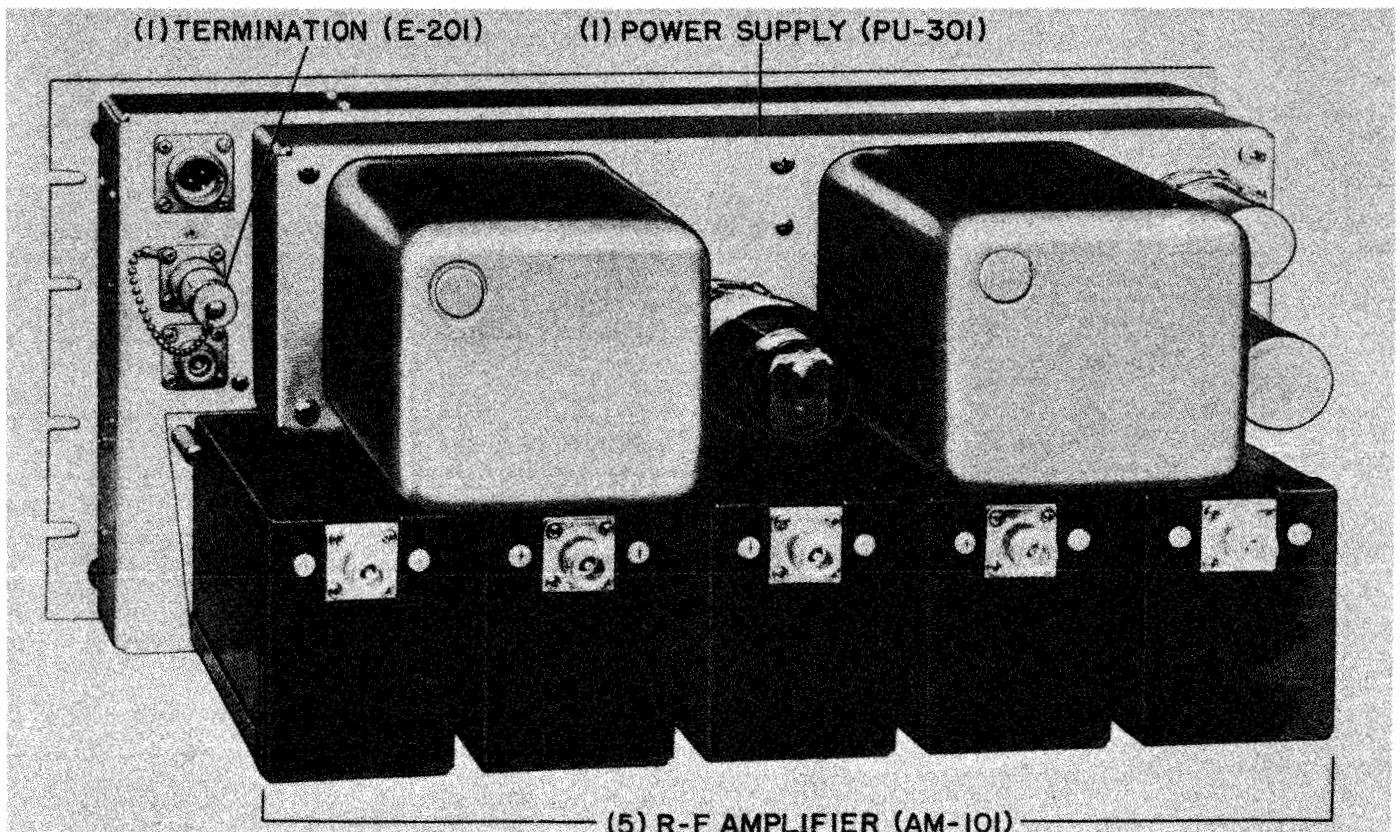

Figure 1-2. Antenna Coupler CU-168/FRR, Rear Oblique View

3. REFERENCE DATA.

- a. Nomenclature: Antenna Coupler CU-168/FRR.
- b. Contract numbers: NObsr 49175, 2 June 1950, and NObsr 52727, 29 June 1951.
- c. Contractor: Collins Radio Co., Cedar Rapids, Iowa.
- d. Cognizant Naval Inspector: Inspector of Naval Material, Los Angeles, California.
- e. Number of packages involved including equipment spares: 1.
- f. Total cubical contents, including equipment spares. Crated: 2.6 cu. ft. Uncrated: 1.2 cu. ft.

- g. Total weight, including equipment spares: Crated: 52 lbs. Uncrated: 43 lbs.
- h. Frequency of equipment: 2 to 32 megacycles per second.
- i. Power requirements: 105, 115, or 125 volts, at any frequency from 50 to 400 cps, single-phase, 125 watts.
- j. Input impedance (from antenna): 70 ohms, nominal.
- k. Output impedance (to receivers and tandem antenna coupler): 70 ohms, nominal.
- l. Number of outputs: 5 (to receivers); 1 (to tandem antenna coupler, if used).

TABLE 1-1. EQUIPMENT SUPPLIED

QUAN- TITY PER EQUIP- MENT	NAME OF UNIT	NAVY TYPE DESIGNATION	OVER-ALL DIMENSIONS			VOLUME	WEIGHT
			HEIGHT	WIDTH	DEPTH		
1	Antenna Coupler	CU-168/FRR	8-3/4	19	12	1.2	41
	Accessories						
1	Connector	AN3106-14S-7S	1-1/8 diam x 1-7/16 lg.				0.055
1	Adapter	AN3057-6	15/16 diam x 1-5/64 lg.				0.029
6	Connector	UG-21B/U	25/32 diam x 1-13/16 lg.				0.123

Unless otherwise stated, dimensions are inches, volume cubic feet, weight pounds.

TABLE 1-2. EQUIPMENT REQUIRED BUT NOT SUPPLIED

QUAN- TITY PER EQUIP- MENT	NAME OF UNIT	NAVY TYPE DESIGNATION	REQUIRED CHARACTERISTICS
1	Antenna System		70-ohm coaxial transmission line.
1 to 5	Radio Receivers		70-ohm (nominal) antenna input facilities.

TABLE 1-3. SHIPPING DATA

SHIPPING BOX NO.	CONTENTS		OVER-ALL DIMENSIONS				
	NAME OF UNIT	NAVY TYPE DESIGNATION	HEIGHT	WIDTH	DEPTH	VOLUME	WEIGHT
1 of 1	Antenna Coupler	CU-168/FRR	23	12	16	2.6	52

Unless otherwise stated, dimensions are inches, volume cubic feet, weight pounds.

TABLE 1-4. ELECTRON TUBE COMPLEMENT

UNIT	NUMBER OF TUBES OF TYPE INDICATED		TOTAL NO. OF TUBES
	12AU7	5U4G	
Antenna Coupler CU-168/FRR	20	1	21

SECTION 2 THEORY OF OPERATION

1. GENERAL.

Antenna Coupler CU-168/FRR is a device which couples up to five independently operating receivers to a single receiving antenna. For accommodation of additional receivers, two or more antenna couplers may be connected in tandem by removing a terminating resistance, and substituting another antenna coupler. The complete schematic diagram is shown in figure 7-8. The antenna coupler receives and passes to the connected equipment all signals within the range 2 to 32 megacycles per second.

2. GENERAL CIRCUITRY. (See figure 2-1.)

Signals from an unbalanced 70-ohm transmission line are introduced through an impedance matching transformer to a balanced, 1,000-ohm, artificial transmission line. The artificial transmission line is terminated through an impedance matching transformer to a 70-ohm load. Five identical isolating r-f amplifiers are connected to this transmission line at points along its length and independently supply signal voltages to the respective receivers. These five r-f amplifiers may be interchanged without affecting overall performance.

Plate voltages for the r-f amplifiers are furnished by the d-c power supply.

3. CIRCUIT ANALYSIS. (See figure 7-8.)

a. TRANSFORMER. (See figure 2-2.) The 70-ohm primary winding of input transformer T-201 accepts signals from an unbalanced, 70-ohm, coaxial transmission line from either an antenna or a preceding antenna coupler. The secondary of T-201 is wound for a nominal impedance of 1,000 ohms and is balanced with respect to chassis ground by means of a center tap. Output transformer T-202 is identical with T-201 but with its electrical functions reversed. A dummy winding on the primary of T-201 (the secondary of T-202) compensates for the unbalanced capacitances between the primary and secondary windings. (See Table 7-6, Winding Data.) The dummy winding is connected to ground at the center tap of the balanced winding. Balancing the distributed capacitances of the transformer in this manner prevents introduction of unbalanced signals into the secondary winding and transmission line. Reference to figure 2-2 should clarify the construction and theory of operation of transformer T-201. Shielding of the transformer is

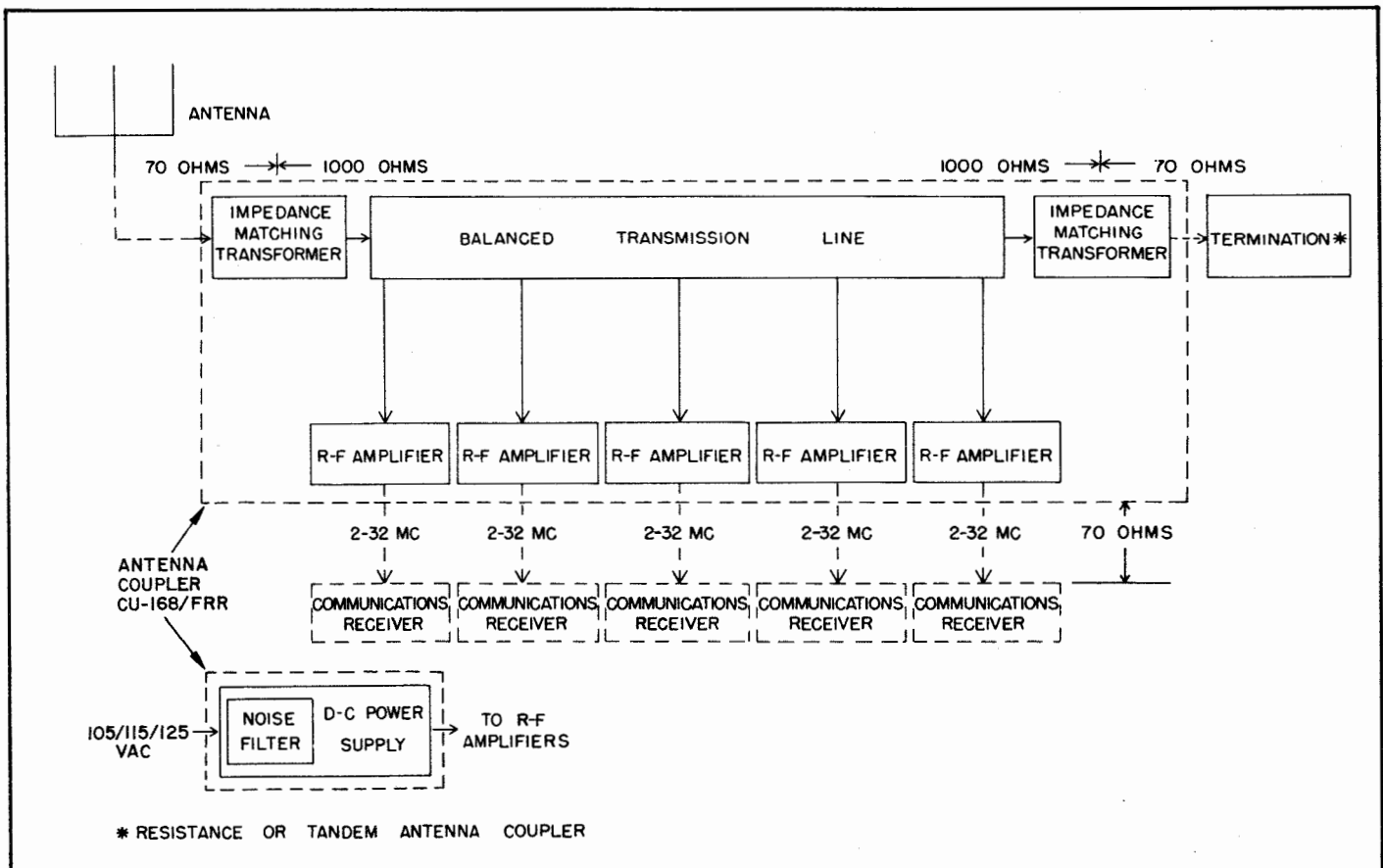

Figure 2-1. Antenna Coupler CU-168/FRR, Block Diagram

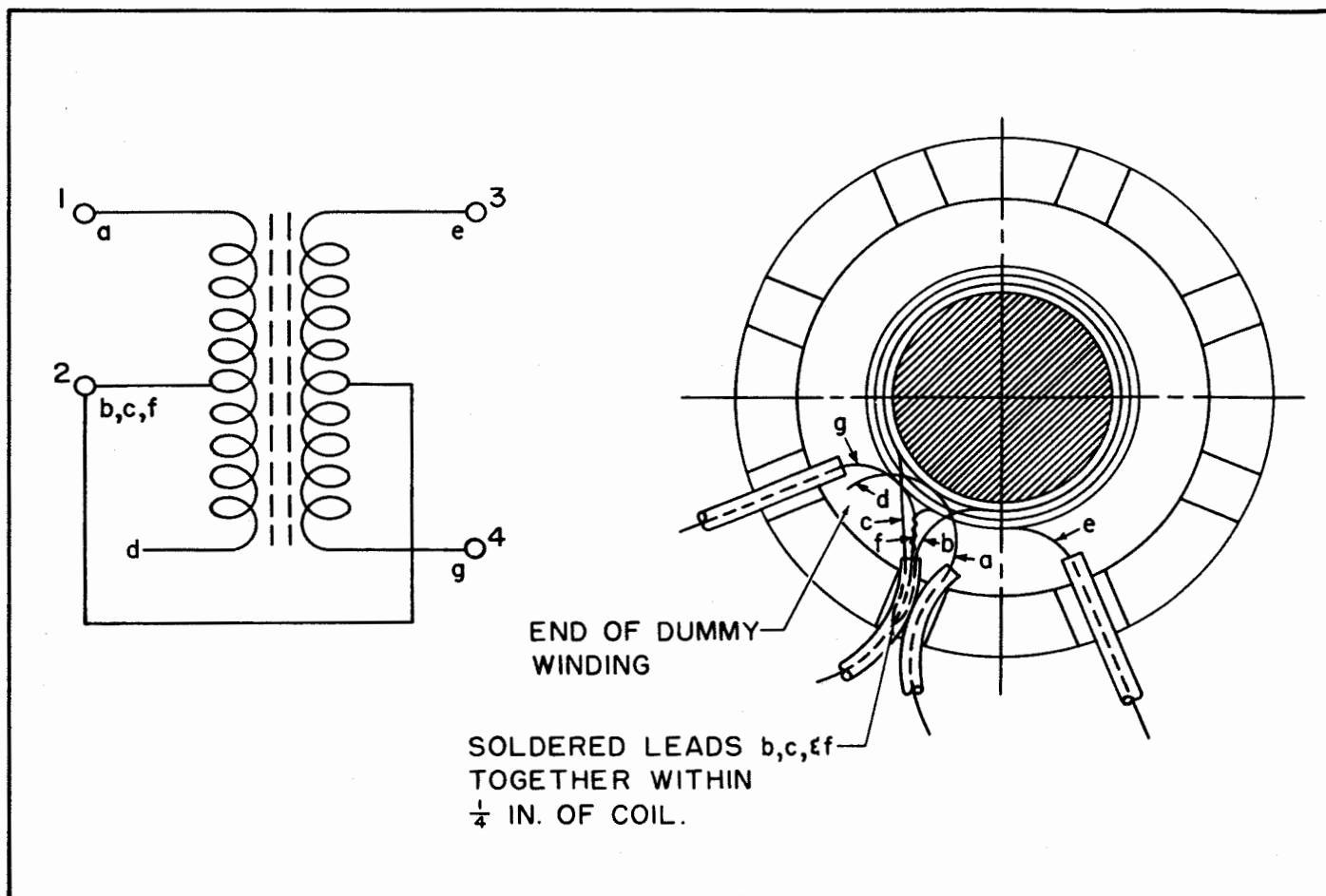

Figure 2-2. Construction of Transformer T-201

secured by the powdered iron cup cores, which virtually enclose the windings.

b. ARTIFICIAL TRANSMISSION LINE. (See figure 7-8.) The artificial transmission line provides a multiple source of balanced, high impedance signals to the string of r-f amplifiers. Balanced operation is desirable to reduce spurious response and utilize advantages of push-pull circuitry in the r-f amplifiers. The transmission line has a nominal characteristic impedance of 1,000 ohms and consists of inductances, connected in series with a portion of the line, and shunting capacitances. The shunting capacitances are supplied by input circuits of the r-f amplifiers rather than by the line itself. Resistors R-204 through R-207 are the series elements of an H-pad which compensates for any unbalanced condition which might exist in transformer T-202.

c. TERMINATION. (See figure 7-8.) Termination of the artificial transmission line is made through impedance-matching transformer T-202 and 70-ohm load. This load may be supplied by resistor R-203, located in detachable plug E-201, or by connecting another antenna coupler at receptacle J-203. In the latter case, resistor R-203 of the second antenna coupler supplies the ultimate termination of the artificial transmission line.

d. R-F AMPLIFIERS. (See figure 7-8.)

(1) Each of the five r-f amplifiers are identical, detachable subassemblies of Antenna Coupler CU-168/FRR. Each contains two push-pull amplification stages with transformer output. The primary function is to isolate the receivers, which form the amplifier loads, from each other and from the antenna. Amplification within these stages compensates for insertion losses inherent in antenna coupler circuits. The low-gain circuit design provides an extremely high degree of linearity and stability over the frequency range of 2 to 32 mc.

(2) The first stage consists of double triodes V-101 and V-102, with both triode sections in each tube connected in parallel. The tubes are cathode-biased for class A, push-pull, cathode-coupled operation by a common cathode resistor R-103. The grids are connected to the balanced, artificial line, and the stray capacitances of these circuits provide the complementary reactances required by the line. During operation, the balanced signals from the line are impressed upon the grids of V-101 and V-102 180 degrees out of phase with respect to each other. The r-f outputs of the tubes are developed across inductors L-101 and L-102 and coupled to the cathodes of the following stages through inductors L-105 and L-106. L-105 and L-106 offer high impedance to high-frequency interference, while passing signals up to 32 megacycles per second. Neutralizing capacitors C-107 and C-108 improve the stability of this stage.

(3) The second stage consists of grounded-grid, push-pull amplifiers V-103 and V-104. These amplifiers operate through the variations in cathode potential with respect to the grid. Cathode-biasing for class A operation is provided by R-103 in common with the first stage. Over the low and mid-range of frequencies the plate load of both tubes consists of the primary of output transformer T-101, center-tapped to r-f ground through C-105. The high range is extended by means of peaking coils L-103 and L-104 and R-C networks consisting of R-104 and C-101 and R-105 and C-102. Plate potential is introduced to the tubes through power-supply decoupling resistor R-107 and the center tap of T-101. Application of the power supply voltage to the secondary winding, as well as the primary, reduces the insulation requirements between windings and makes very high coupling possible. Capacitor C-106 blocks the high voltage d-c from the amplifier output. The stability of the grounded-grid stage is improved by neutralizing capacitors C-109 and C-110.

(4) The cathode-coupled design of the first stage and the grounded-grid design of the second provide the wide frequency response required. In addition, the push-pull operation inherently results in cancellation of even-order harmonics generated within the antenna coupler.

e. POWER SUPPLY. (See figure 7-8.) The d-c power supply consists of power transformer T-301, with three secondary windings: 250-0-250-volt power, 5-volt CT rectifier filament, and 12.6-volt CT for heaters and indicator light. Rectifier tube V-301 is connected for full-wave rectification. The output is filtered by a choke-input filter network consisting of inductor Z-301, and electrolytic capacitors C-301 and C-302. Resistor R-301 bleeds the power supply. The primary of T-301 is protected by two-ampere fuses F-201 and F-202. Noise and r-f coupling to and from the a-c power source are reduced by noise filter Z-201, which in addition establishes a balanced a-c ground for hum reduction.

SECTION 3 INSTALLATION

1. UNPACKING.

There are no special features of this equipment which will be damaged if ordinary care is exercised during unpacking. To check that all parts of the equipment are supplied, refer to Figure 1-1 and Table 1-1.

2. INSTALLATION. (See figure 3-1.)

a. Antenna Coupler CU-168/FRR will usually be mounted in a Navy CY-597A/G or similar cabinet and secured with eight cup washers and eight machine screws.

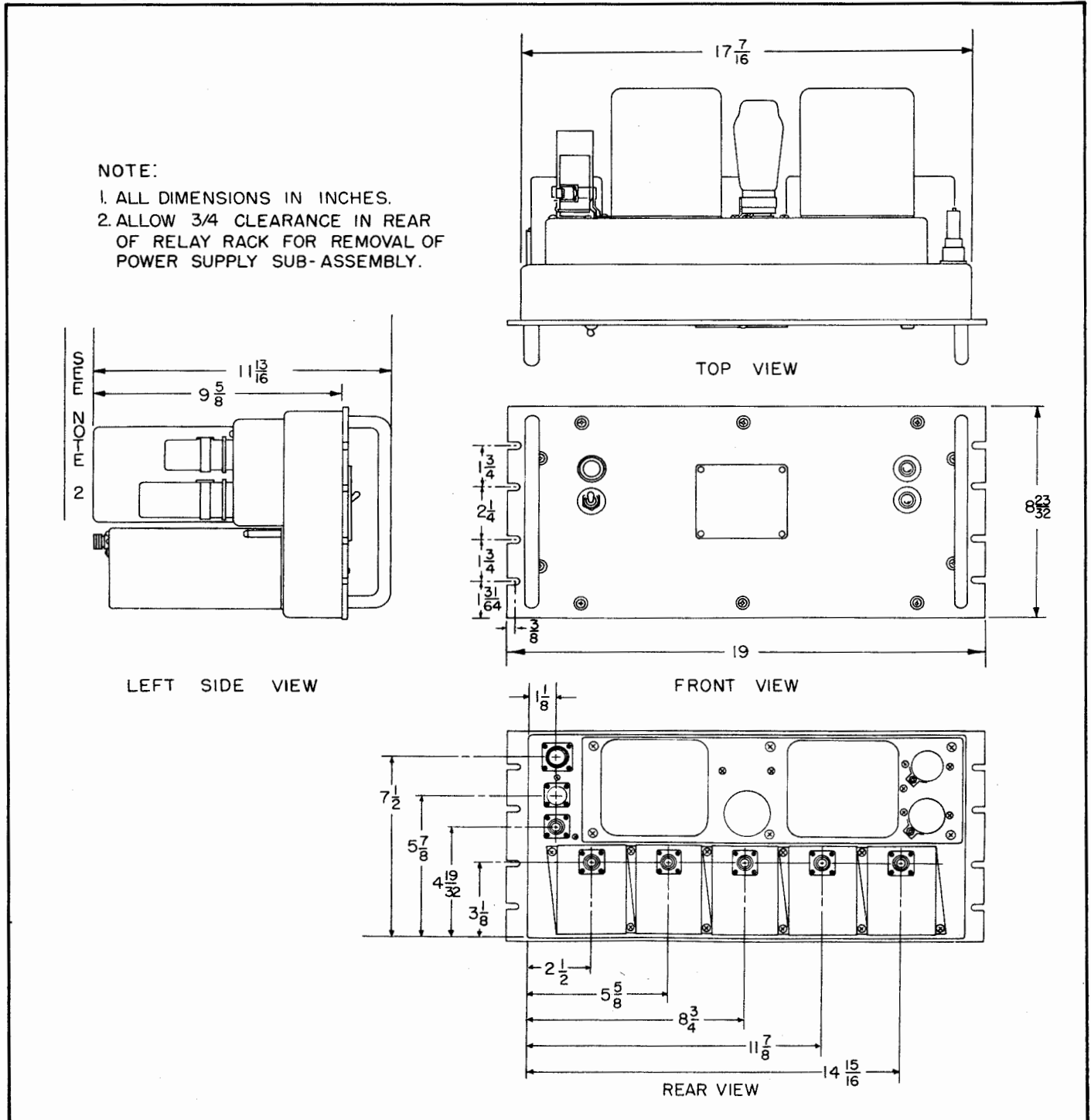

Figure 3-1. Antenna Coupler CU-168/FRR, Dimensional Outline Diagram

b. If several units (5 or more) are installed in one cabinet, a means of forced ventilation should be provided to prevent overheating.

c. Whether installed in CY-597A/G Cabinet or open racks, a 1-3/4' space (size A panel) should be left between units to facilitate air circulation.

d. If they are to be located in non-occupied spaces of air-conditioned buildings, installation may be made in floor-to-overhead open racks.

3. INITIAL ADJUSTMENTS.

a. Measure the a-c rms line voltage between the lines of the single phase source from which the antenna coupler is to be operated. This voltage must be 105, 115, or 125 volts, plus or minus 10 per cent. The power line frequency must be between 50 and 400 cycles.

b. Back out (until loose) the six captive screws which retain the power supply subassembly on the main chassis. Withdraw the power supply subassembly carefully so as

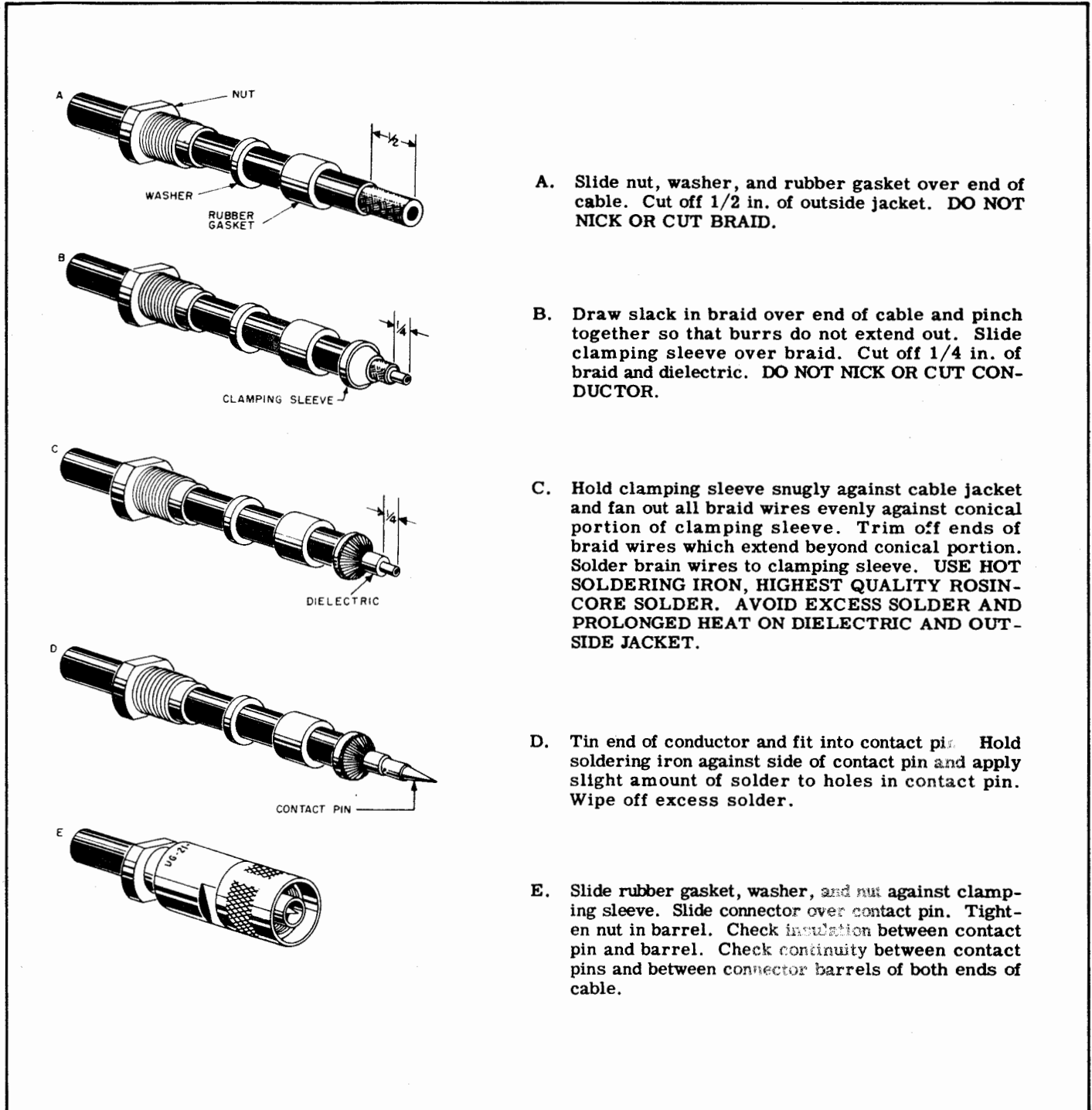

- A. Slide nut, washer, and rubber gasket over end of cable. Cut off 1/2 in. of outside jacket. **DO NOT NICK OR CUT BRAID.**
- B. Draw slack in braid over end of cable and pinch together so that burrs do not extend out. Slide clamping sleeve over braid. Cut off 1/4 in. of braid and dielectric. **DO NOT NICK OR CUT CONDUCTOR.**
- C. Hold clamping sleeve snugly against cable jacket and fan out all braid wires evenly against conical portion of clamping sleeve. Trim off ends of braid wires which extend beyond conical portion. Solder braid wires to clamping sleeve. **USE HOT SOLDERING IRON, HIGHEST QUALITY ROSIN-CORE SOLDER. AVOID EXCESS SOLDER AND PROLONGED HEAT ON DIELECTRIC AND OUTSIDE JACKET.**
- D. Tin end of conductor and fit into contact pin. Hold soldering iron against side of contact pin and apply slight amount of solder to holes in contact pin. Wipe off excess solder.
- E. Slide rubber gasket, washer, and nut against clamping sleeve. Slide connector over contact pin. Tighten nut in barrel. Check insulation between contact pin and barrel. Check continuity between contact pins and between connector barrels of both ends of cable.

Figure 3-2. Fabrication Instructions for UG-21B/U to RG-11/U

not to bend the electrical connectors. Inspect the position of the link of switch S-301 (see figure 7-7); it should be in a marked position corresponding to the measured a-c line voltage. Change to correct position if necessary.



Do not connect Antenna Coupler CU-168/FRR to an a-c source until switch S-301 has been adjusted for the correct line voltage.

4. POWER CONNECTION.

Connect the two conductors of the a-c supply cable to pins "A" and "C" of connector AN3106-14S-7S (P-201). Antenna coupler ground is available through pin "B". Install adapter AN3057-6 on the cable and connector. Connect the cable at power receptacle J-201 and secure by turning the plug retaining collar clockwise.

5. ANTENNA CONNECTION.

Refer to Navships 91047 for a description of the r-f and a-f signal distribution unit. Mount r-f connector UG-21B/U (P-202) on the end of the antenna cable (RG-12/U or equivalent) according to figure 3-2. Insert the plug in receptacle J-202 on the antenna coupler and secure by turning the plug retaining collar clockwise. Connect the other end to jack panel J-239/G in the r-f distribution panel.

6. CONNECTION TO SYSTEM.

Refer to Navships 91047 for a description of the r-f and a-f signal distribution unit. See figure 3-3 for typical installation. Mount r-f connectors UG-21B/U (P-101) on one end of each output cable (RG-12/U or equivalent) and connect the opposite ends to jack panel J-237/G or J-239/G on the r-f distribution panel, depending on whether through line lifts or terminations are desired. Further routing will depend on the individual installation. Secure UG-21B/U plug to the amplifier output jacks.

7. TERMINATION.

a. SINGLE ANTENNA COUPLER.-Install termination subassembly E-201 in receptacle J-203 (see figure 1-2). Secure by turning the plug retaining collar clockwise.

b. TANDEM ANTENNA COUPLER.-Mount r-f connector UG-21B/U (P-203, not supplied by contractor) on RG-12/U or equivalent coaxial cable. Secure the connector to jack J-203 on the antenna coupler, in place of termination E-201. Where tandeming is permanent, run the other end to the input of the following antenna coupler. If a line lift is desired, run through jack panel J-239/G. Where tandem requirements vary, run the line to jack panel J-237/G and devise a new 70-ohm line termination in N.T. 49121A plug.

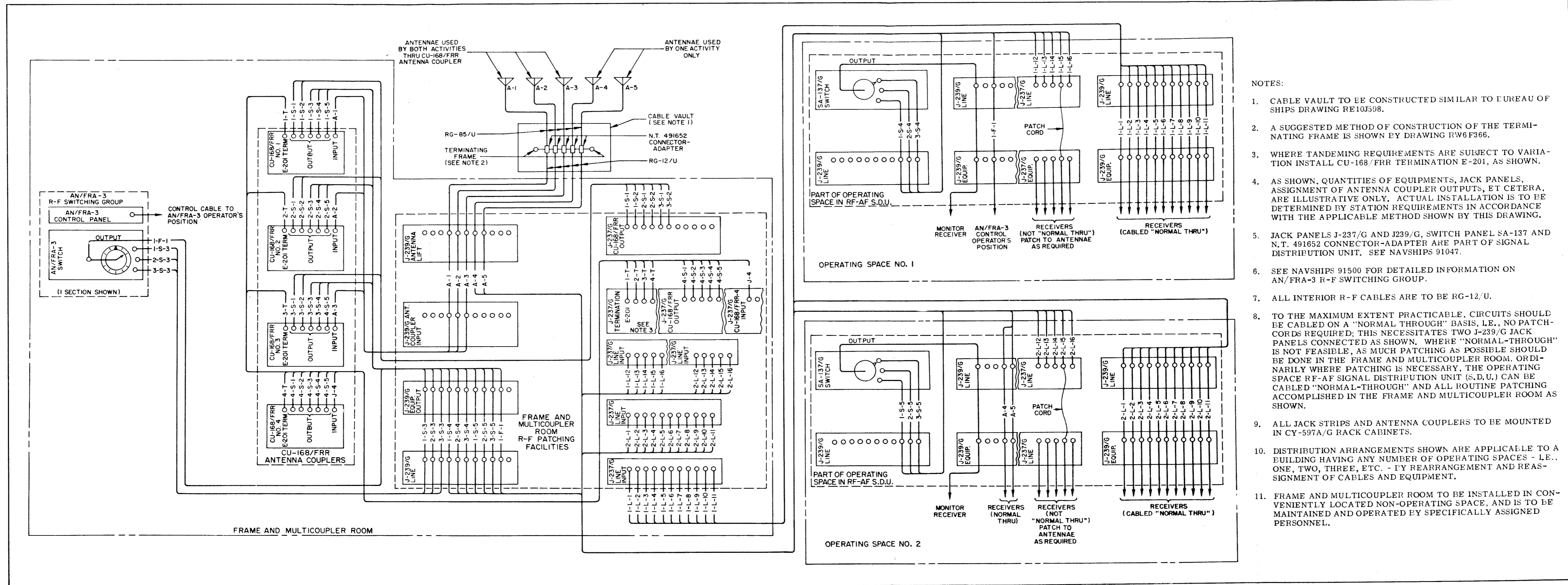

- NOTES:
1. CABLE VAULT TO BE CONSTRUCTED SIMILAR TO BUREAU OF SHIPS DRAWING RE10J598.
 2. A SUGGESTED METHOD OF CONSTRUCTION OF THE TERMINATING FRAME IS SHOWN BY DRAWING RW6F366.
 3. WHERE TANDEMING REQUIREMENTS ARE SUBJECT TO VARIATION INSTALL CU-168/FRR TERMINATION E-201, AS SHOWN.
 4. AS SHOWN, QUANTITIES OF EQUIPMENTS, JACK PANELS, ASSIGNMENT OF ANTENNA COUPLER OUTPUTS, ET CETERA, ARE ILLUSTRATIVE ONLY. ACTUAL INSTALLATION IS TO BE DETERMINED BY STATION REQUIREMENTS IN ACCORDANCE WITH THE APPLICABLE METHOD SHOWN BY THIS DRAWING.
 5. JACK PANELS J-237/G AND J239/G, SWITCH PANEL SA-137 AND N.T. 491652 CONNECTOR-ADAPTER ARE PART OF SIGNAL DISTRIBUTION UNIT. SEE NAVSHIPS 91047.
 6. SEE NAVSHIPS 91500 FOR DETAILED INFORMATION ON AN/FRA-3 R-F SWITCHING GROUP.
 7. ALL INTERIOR R-F CABLES ARE TO BE RG-12/U.
 8. TO THE MAXIMUM EXTENT PRACTICABLE, CIRCUITS SHOULD BE CABLED ON A "NORMAL THROUGH" BASIS, I.E., NO PATCH-CORDS REQUIRED; THIS NECESSITATES TWO J-239/G JACK PANELS CONNECTED AS SHOWN. WHERE "NORMAL-THROUGH" IS NOT FEASIBLE, AS MUCH PATCHING AS POSSIBLE SHOULD BE DONE IN THE FRAME AND MULTICOUPLER ROOM. ORDINARILY WHERE PATCHING IS NECESSARY, THE OPERATING SPACE RF-AF SIGNAL DISTRIBUTION UNIT (S.D.U.) CAN BE CABLED "NORMAL-THROUGH" AND ALL ROUTINE PATCHING ACCOMPLISHED IN THE FRAME AND MULTICOUPLER ROOM AS SHOWN.
 9. ALL JACK STRIPS AND ANTENNA COUPLERS TO BE MOUNTED IN CY-597A/G RACK CABINETS.
 10. DISTRIBUTION ARRANGEMENTS SHOWN ARE APPLICABLE TO A BUILDING HAVING ANY NUMBER OF OPERATING SPACES - I.E., ONE, TWO, THREE, ETC. - BY REARRANGEMENT AND REASSIGNMENT OF CABLES AND EQUIPMENT.
 11. FRAME AND MULTICOUPLER ROOM TO BE INSTALLED IN CONVENIENTLY LOCATED NON-OPERATING SPACE, AND IS TO BE MAINTAINED AND OPERATED BY SPECIFICALLY ASSIGNED PERSONNEL.

Figure 3-3. Typical R-F Distribution System for Radio Receiver Stations

471638 O - 58 (Face p. 18)

SECTION 4 OPERATION

1. CAPABILITIES AND LIMITATIONS.

Antenna Coupler CU-168/FRR provides operation of up to five Navy communications receivers from the same antenna. No operator attention or adjustment is required. The equipment passes all antenna signals in between 2 and 32 mc with minimum frequency discrimination, distortion, noise generation, cross-talk, or response to spurious signals.

2. OPERATION. (See figure 4-1.)

To place the equipment in operation, place power switch S-201 to the "ON" position. The indicator light I-201 indicates that the equipment is in operation. To remove the equipment from operation, throw power switch S-201 to the "OFF" position.

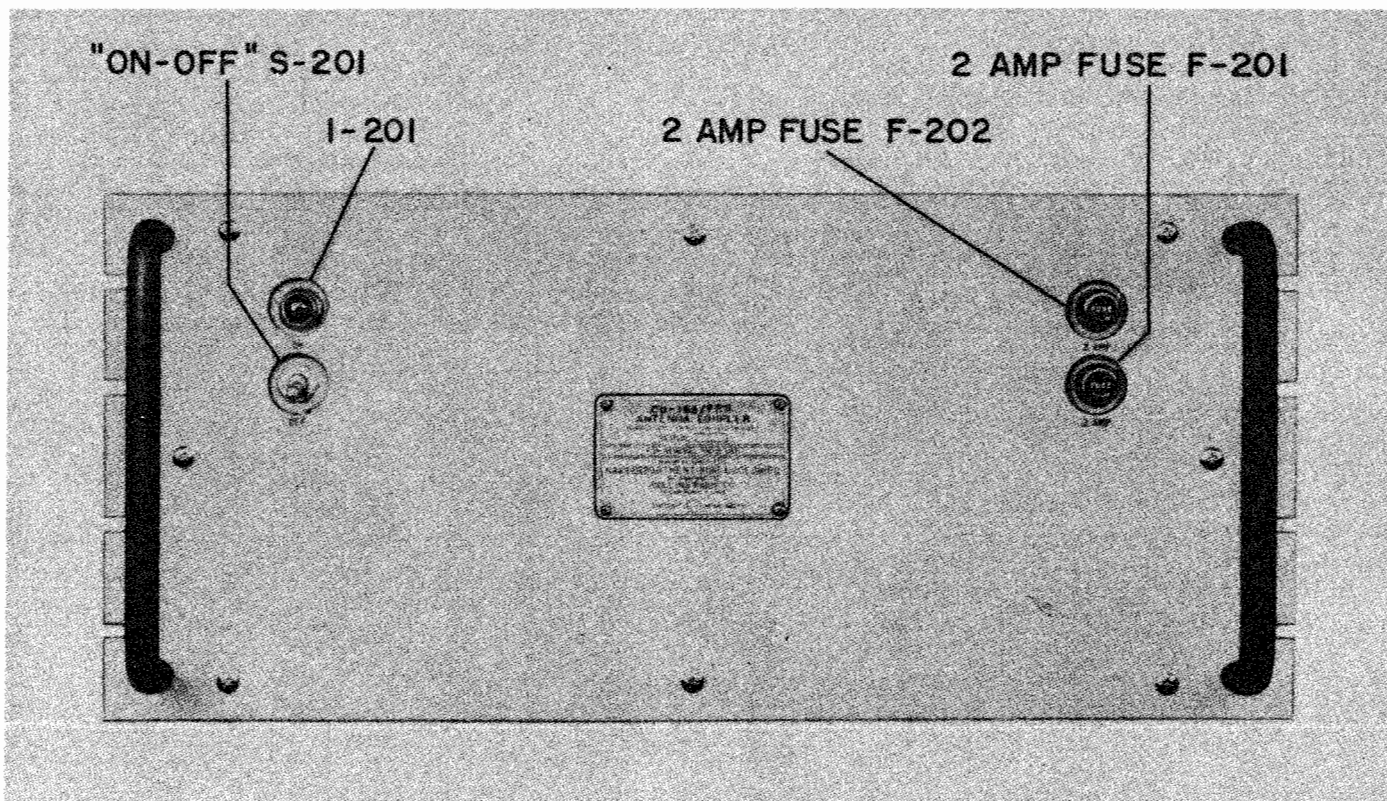

Figure 4-1. Antenna Coupler CU-168/FRR, Panel, Front View

SECTION 5 OPERATOR'S MAINTENANCE

1. ROUTINE CHECK CHART.
2. EMERGENCY MAINTENANCE.

Failure of the antenna coupler to function is probably a symptom of tube or fuse failure.

NOTICE TO OPERATORS

Operators shall not perform any of the following emergency maintenance procedures without proper authorization.

- a. REPLACEMENT OF TUBES AND FUSES.-When tube failure is indicated, replace each tube in turn

with a new or tested tube of the same type, or remove and check all tubes on a standard tube tester such as Tube Tester TV-3/U series, Navy Model OZ series or equivalent. For tube locations, see figures 1-2 and 7-5. For fuse locations, see figure 4-1.

WARNING

Never replace a fuse with one of higher rating unless continued operation of the equipment is more important than probable damage. If a fuse burns out immediately after replacement, do not replace it a second time until the cause has been corrected.

TABLE 5-1. ROUTINE CHECK CHART
WHEN IN USE - EACH WATCH

WHAT TO CHECK	HOW TO CHECK	PRECAUTIONS
1. Indicator light and rectifier tube.	a. Observe glow.	a. If rectifier tube is gassy (purple or blue glow) it must be replaced.

WHEN IN USE - WEEKLY

1. Overall performance.	a. Compare receiver performance for each antenna coupler output in turn. b. Operate receiver directly from antenna, bypassing antenna coupler(s). Compare performance.	a. Test with reception of several types of emission at various frequencies in the 2-to-32 mc band. a. Test with reception of several types of emission at various frequencies in the 2-to-32 mc band.
-------------------------	---	--

SECTION 6 PREVENTIVE MAINTENANCE

1. ROUTINE MAINTENANCE CHECK CHART.

NOTE

THE ATTENTION OF MAINTENANCE PERSONNEL IS INVITED TO THE REQUIREMENTS OF CHAPTER 67 OF THE BUREAU OF SHIPS MANUAL, OF THE LATEST ISSUE.

2. LUBRICATION.

No lubrication is required.

TABLE 6-1. ROUTINE MAINTENANCE CHECK CHART

WHEN IN USE - MONTHLY

WHAT TO CHECK	HOW TO CHECK	PRECAUTIONS
1. Overall conditions.	Remove subassemblies and look for evidences of overheating, loose or dirty pins and connections, corrosion, fungus, etc.	Disconnect from a-c power source.

FAILURE REPORTS

A FAILURE REPORT must be filled out for the failure of any part of the equipment whether caused by defective or worn parts, improper operation, or external influences. It should be made on Failure Report, form NBS-383, which has been designed to simplify this requirement. The card must be filled out and forwarded to BUSHIPS in the franked envelope which is provided. Full instructions are to be found on each card.

Use great care in filling the card out to make certain it carries adequate information. For example, under "Circuit Symbol" use the proper circuit identification taken from the schematic drawings, such as T-101 in the case of a transformer, or R-125, for a resistor. Do not substitute brevity for clarity. Use the back of the card to completely describe the cause of failure and attach an extra piece of paper if necessary.

The purpose of this report is to inform BUSHIPS of the cause and rate of failures. The information is used by the Bureau in the design of future equipment and in the maintenance of adequate supplies to keep the present equipment going. The cards you send in, together with those from hundreds of other ships, furnish a store of information permitting the Bureau to keep in touch with the performance of the equipment of your ship and all other ships of the Navy.

This report is not a requisition. You must request the replacement of parts through your Officer-in-Charge in the usual manner.

Make certain you have a supply of Failure Report cards and envelopes on board. They may be obtained from the nearest District Printing and Publication Office.

FAILURE REPORT—ELECTRONIC EQUIPMENT
NAVSHIPS (NBS) 383 (REV. 5-45)
(FORMERLY NAVSHIPS (NBS) 383 AND NAVSHIPS (NBS) 384)

SHIP NUMBER AND NAME OR STATION _____

CHECK ONE: RADIO

EQUIPMENT MODEL DESIGNATION _____

TYPE NUMBER AND NAME OF MAJOR UNIT INVOLVED _____

TUBE TYPE, INCLUDING PREFIX LETTERS _____

TUBE MANUFACTURER _____

FAILURE OCCURRED IN:

STORAGE OPERATION

HANDLING OTHER (SPECIFY) _____

INSTALLING

NATURE OF FAILURE AND REMARKS _____

NOTICE—Read notes on reverse side. Additional forms and envelopes may be obtained from nearest NMO.

DATE _____

NAME OF PERSON MAKING REPORT _____

ELECTRONIC EQUIPMENT FAILURE REPORT (SIG)
NAVSHIPS (NBS) 383 (REV. 11-45)

NOTICE.—Read notes on cover prior to preparing this form.

*REPORT NO. _____

DATE _____

ORGANIZATION PERFORMING MAINTENANCE _____

NAME AND RANK OF OFFICER ACCOUNTABLE FOR MAINTENANCE _____

EQUIPMENT INVOLVED

Navy Army USMC JAN Commercial Other _____ (Specify)

Radio Radar Sonar Wire Tool Test Power Sound Other _____ (Specify)

EQUIPMENT MODEL DESIGNATION _____ SERIAL NUMBER OF EQUIPMENT _____ NAME OF CONTRACTOR _____ CONTRACT NO. _____

TYPE NUMBER AND NAME OF MAJOR UNIT INVOLVED _____ SERIAL NUMBER OF UNIT _____ CONTRACT OR PO DATA OF UNIT _____ DATE EQUIPMENT RECEIVED _____

ITEM WHICH FAILED

THIS SIDE FOR TUBES		THIS SIDE FOR PARTS (NOTE 9)			
TUBE TYPE, INCLUDING PREFIX LETTERS	SERIAL NO. (NOTE 8)	NAME OF PART	CIRCUIT SYMBOL (e.g. R-134)	NAVY TYPE NO.	
TUBE MANUFACTURER	CONTRACT NO. (NOTE 9)	SERIAL NO.	*CONTRACT DATA	*DATE RECD.	*ARMY STOCK NO.
FAILURE OCCURRED IN	GUARANTEED HOURS (NOTE 8)	DATE OF ACCEPTANCE (NOTE 8)	*CHECK-OFF OR TAG DATA (NOTE 9)	*MANUFACTURER'S DATA (NOTE 9)	
<input type="checkbox"/> Storage <input type="checkbox"/> Operation	ACTUAL HOURS	DATE OF FAILURE	BRIEF DESCRIPTION AND CAUSE OF FAILURE, INCLUDING APPROXIMATE LIFE (CONTINUE ON BACK)		
<input type="checkbox"/> Handling <input type="checkbox"/> Other (Specify in remarks)	TYPE OF FAILURE (NOTE 7)	TUBE CIRCUIT SYMBOL V-			
NATURE OF FAILURE AND REMARKS (NOTE 4) (CONTINUE ON BACK)					
CONCLUSION:					
<input type="checkbox"/> Normal replacement <input type="checkbox"/> Shortage <input type="checkbox"/> Modification <input type="checkbox"/> Failure <input type="checkbox"/> Transportation damage <input type="checkbox"/> Other _____ (Specify)					

*NOT REQUIRED FOR REPORTS SUBMITTED BY NAVAL ACTIVITIES.

16-40551-1 U. S. GOVERNMENT PRINTING OFFICE

Figure 7-1. Failure Report, Sample Form

SECTION 7 CORRECTIVE MAINTENANCE

1. THEORY OF LOCALIZATION.

During the normal service life of any piece of equipment, some faults are expected to develop. Any circuit component in the entire system may be at fault, so, before searching for the defective part, it is necessary that a systematic method be used to localize the trouble and determine what part of the system is the source of the trouble. Before undertaking the job of localizing a faulty component, the technician must be thoroughly familiar with the complete system he is dealing with. The instruction books on the various units used in the system should be consulted until a good working knowledge of the equipment is attained. The theory of operation of Antenna Coupler CU-168/FRR will be found in Section 2 of this book and it is recommended that this section be consulted if the trouble has been isolated to the antenna coupler. A schematic diagram of the antenna coupler is shown in figure 7-8.

A method of localizing the trouble to a certain unit, if that unit happens to be the antenna coupler, is discussed in the next paragraph.

2. SYSTEM TROUBLE SHOOTING.

The entire system, with which Antenna Coupler CU-168/FRR is used, consists of an antenna and 70-ohm coaxial lead in, the antenna coupler, one or more communications receivers having a nominal 70-ohm input impedance, and the associated cables and connectors.

a. LOCATING FAULTY UNIT.-The initial step in system trouble shooting consists of isolating the unit of the system which is at fault. Faulty operation of a unit is indicated by the appearance of an unsatisfactory signal at the output of a properly tuned receiver. The trouble can be localized by the following procedure:

NOTE

UNSATISFACTORY SIGNAL, AS DISCUSSED HERE, IS A SIGNAL WHICH IS WEAK, NOISY, DISTORTED OR OTHERWISE DEGRADED IN QUALITY. UNSATISFACTORY SIGNAL MAY EVEN BE THE ENTIRE ABSENCE OF SIGNAL.

(1) Tune to other stations near the same frequency as the one which provides unsatisfactory operation. If the other stations provide satisfactory reception, the trouble probably is NOT in the receiving installation. If other stations cannot be received satisfactorily, proceed to step (2).

(2) By-pass the antenna coupler at the rf-af distribution panel. Unsatisfactory reception indicates that the trouble is not in the antenna coupler. If this is the case, consult the applicable instruction books for the auxiliary equipments. Check all r-f connectors to determine if they are making good connection. Check all cabling. Satisfactory operation (when the antenna

ORIGINAL

coupler has been by-passed) indicates that the fault is probably in the antenna coupler. If the trouble has been localized to the antenna coupler, the next step is to isolate the fault to some particular part of this unit. Proceed to step (3).

(3) Consecutively switch the receiver input to each of the five antenna-coupler amplifier outputs. If only one amplifier produces an unsatisfactory output, the fault probably lies in that amplifier. It is wise to try another amplifier in this position to be sure the fault is in the amplifier and not in its connector. If the output of two or more of the amplifiers is found to be unsatisfactory, proceed to step (4).

(4) Remove E-201 from J-203. Connect a receiver, known to be in good operating condition, to J-203. Good reception here indicates that the 1,000-ohm transmission line is in good condition. The reception of an unsatisfactory signal indicates a defective transmission line. Remember that a serious trouble such as a shorted input in one of the amplifiers can produce the same effect as a shorted transmission line. If the reception here indicates that the transmission line is good, but unsatisfactory signal is still received from the amplifiers, the power supply is probably defective. Refer to the next subsection for unit trouble shooting and repair.

3. UNIT TROUBLE SHOOTING AND REPAIR.

Antenna Coupler CU-168/FRR consists of only one major unit and its various subassemblies. After isolation of trouble to the antenna coupler, trouble shooting and repair of the antenna coupler itself may be performed as outlined in the succeeding paragraphs.

a. PRECAUTIONS.-While performing repairs of any nature on the antenna coupler, certain basic precautions must be observed.

(1) Every effort should be made to duplicate the exact original condition of the equipment. Standard replacement parts, such as supplied with the equipment, or taken from stock, should be used.

(2) Replaced wires and parts must be installed in exactly the same position as the original items. If this is not done, improper operation may occur. Stray capacitance between wiring and parts is utilized to provide proper circuit balance.

(3) All soldering should be done with resin core solder only. A good mechanical connection, as well as a satisfactory electrical connection, should be made at all times. Be careful not to allow solder to drip down into the chassis. This could easily cause a short circuit which might damage some parts of the equipment, requiring additional expense and valuable time to repair.

(4) Equipment which has been temporarily repaired in an emergency should be clearly marked or tagged

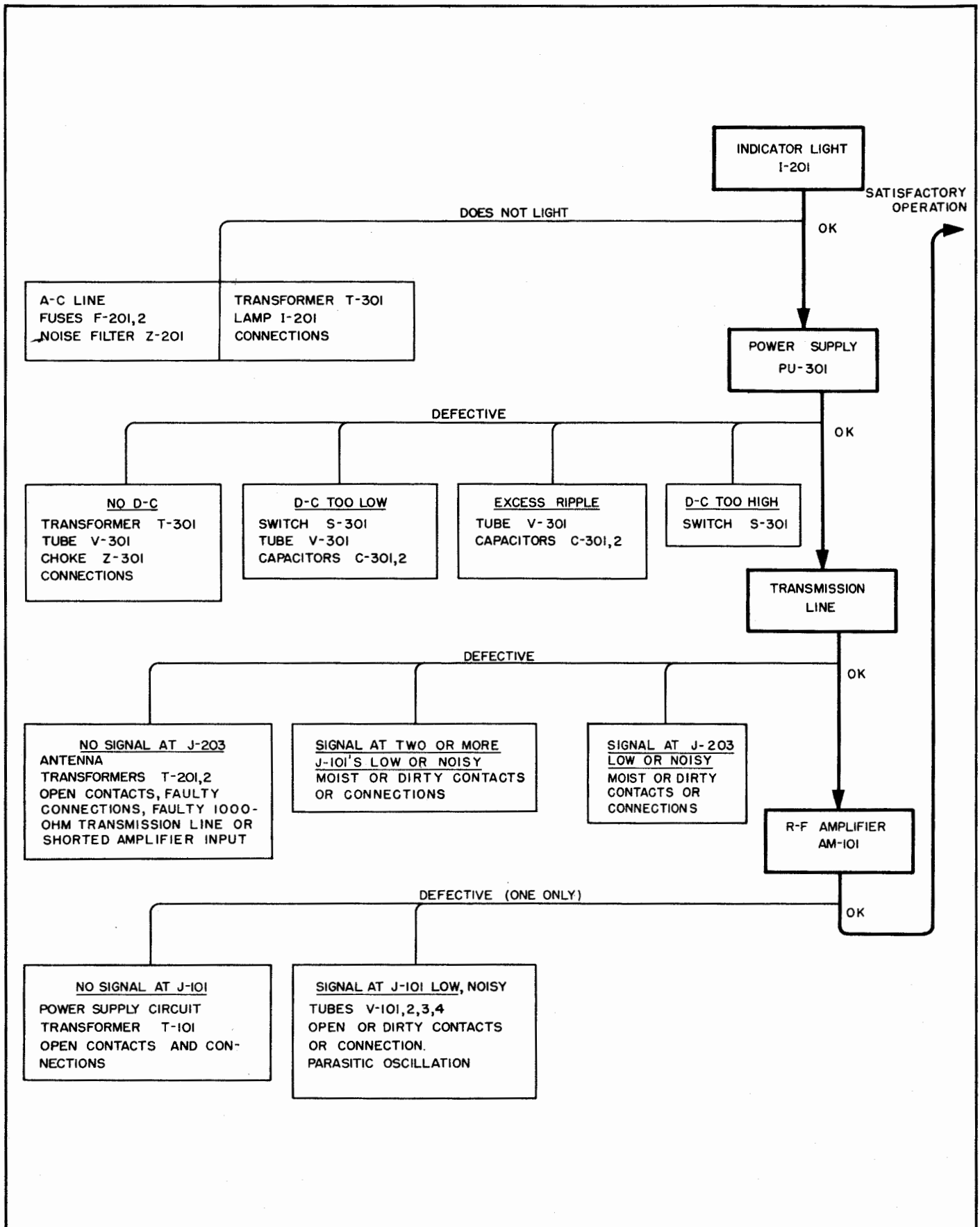

Table 7-1. Trouble Shooting Chart

indicating the nature of the repair. It should be restored to its original condition at the first possible opportunity.

b. TROUBLE SHOOTING.-The trouble is first localized as discussed in sub-section 3. Table 7-1 shows a logical approach to unit trouble shooting and lists typical troubles which may appear. The following paragraphs describe troubles which may occur in each subassembly. Remedies are given for typical faults.

(1) If the trouble has been localized in an amplifier unit, proceed as follows:

(a) Remove dust cover and see if all tube filaments are lit. Replace any tubes whose filaments are not lit. If all filaments are lit, proceed to step (b).

(b) Check tubes; preferably by replacing the tubes, one at a time, with a tube known to be good. Replace any tubes found to be defective. If all tubes are good, proceed to step (c).

(c) Check voltages to see if they are as shown in table 7-2. Measure these voltages by removing the amplifier dust covers, leaving the amplifiers in place on the chassis. Remove the power unit from the chassis in order to obtain greater accessibility. Fabricate locally a jumper cable of sufficient length to connect the power supply to the chassis. If these voltages are the wrong values, the faulty component can probably be located by the following resistance checks.

(d) Make resistance checks as shown in table 7-3. Replace defective components. These resistance checks should be made even if the voltages check out right, because a resistance check will often point out a faulty component which was not indicated by a voltage check.

NOTE

IT MAY BE NECESSARY TO REMOVE AND TEST INDIVIDUAL COMPONENTS IN RARE INSTANCES.

(2) If the trouble has been localized in the power unit, proceed as follows:

(a) Check rectifier tube V-301 visually for indications of overloading (red plates), or burned out filaments. If filaments are burned out, replace the tube. If tube shows evidence of overloading, replace capacitors C-301 and C-302 before trying a new tube. If rectifier tube appears normal, proceed to step (b).

(b) Remove the power supply from antenna-coupler chassis. Check line voltage between pins 7 and 8 of power input jack J-209. If there is no voltage at this point, proceed as follows. Check fuses F-201 and F-202. Check continuity of filter Z-201. Check operation of switch S-201. Replace any parts found to be defective. If proper voltage exists at jack J-209, proceed to step (c).

(c) Check resistances to see if they are as shown in table 7-3. Replace any defective components indicated by the results of these tests. If all resistances are correct, proceed to step (d).

(d) Apply the correct line voltage between pins 7 and 8 of plug P-301. Check voltages per table 7-2. Replace any faulty components indicated by these results.

(3) If the trouble is localized in the transmission line, proceed as follows:

(a) Remove front panel from main chassis. Remove all subassemblies from main chassis. Check resistance values as given in table 7-3. Replace any component found to be defective. If resistances check out correctly, proceed to step (b).

(b) Reassemble antenna coupler except for the front panel. Check voltages in the main chassis per table 7-2. Replace any defective components as indicated by the checks.

c. REPAIR.

(1) No electrical adjustments are required for the antenna coupler other than that described in section 3, paragraph 3. However, the unit may be checked for satisfactory operation as follows:

(a) (See figure 7-2.) Connect a signal generator, such as R-F Signal Generator Set AN/URM-25 Series with a 2-to-32 megacycle frequency coverage, to antenna input jack J-202. Connect a receiver with a 70-ohm input impedance to an output jack. Set the output level of the generator to less than 0.1 volt. Connect an output meter to the receiver. Adjust the receiver for a convenient level on the output meter, being careful that receiver does not block. Then remove the antenna coupler and connect the signal generator directly to the receiver. Adjust the output of the signal generator to give the same reading on the meter without changing any of the receiver controls. The output voltage of the generator, with the coupler in the circuit, must be less than 1.6 times the output voltage, with the antenna coupler removed. This test may be run on any output jack and at any frequency between 2 and 32 megacycles.

(2) MECHANICAL ADJUSTMENTS.-There are no mechanical adjustments other than those listed in section 3.

(3) COMPONENT CHARACTERISTICS.

(a) ELECTRON TUBES.-Tube operating voltages and currents are tabulated in table 7-4. Table 7-5 lists characteristics of all tubes used in Antenna Coupler CU-168/FRR.

(b) WINDING DATA.-Table 7-6 gives winding data for all coils, transformers and r-f chokes used in this equipment. The information listed in this table includes the schematic diagram, wire size, number of turns and d-c resistance of each coil.

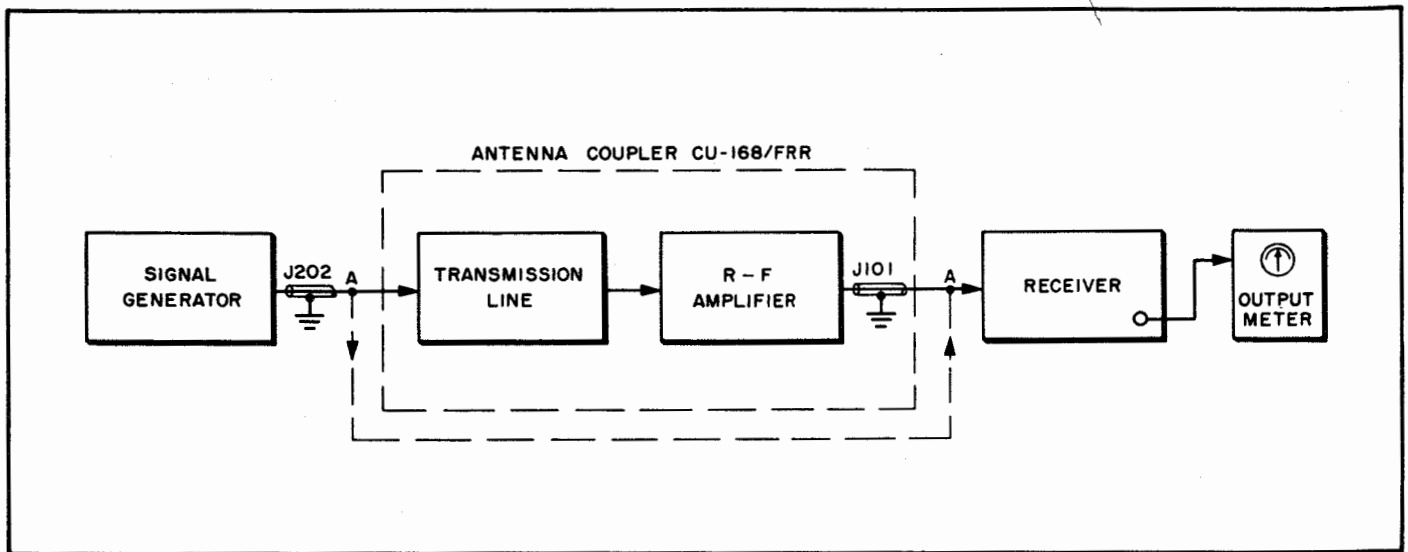

Figure 7-2. Method of Measuring Gain

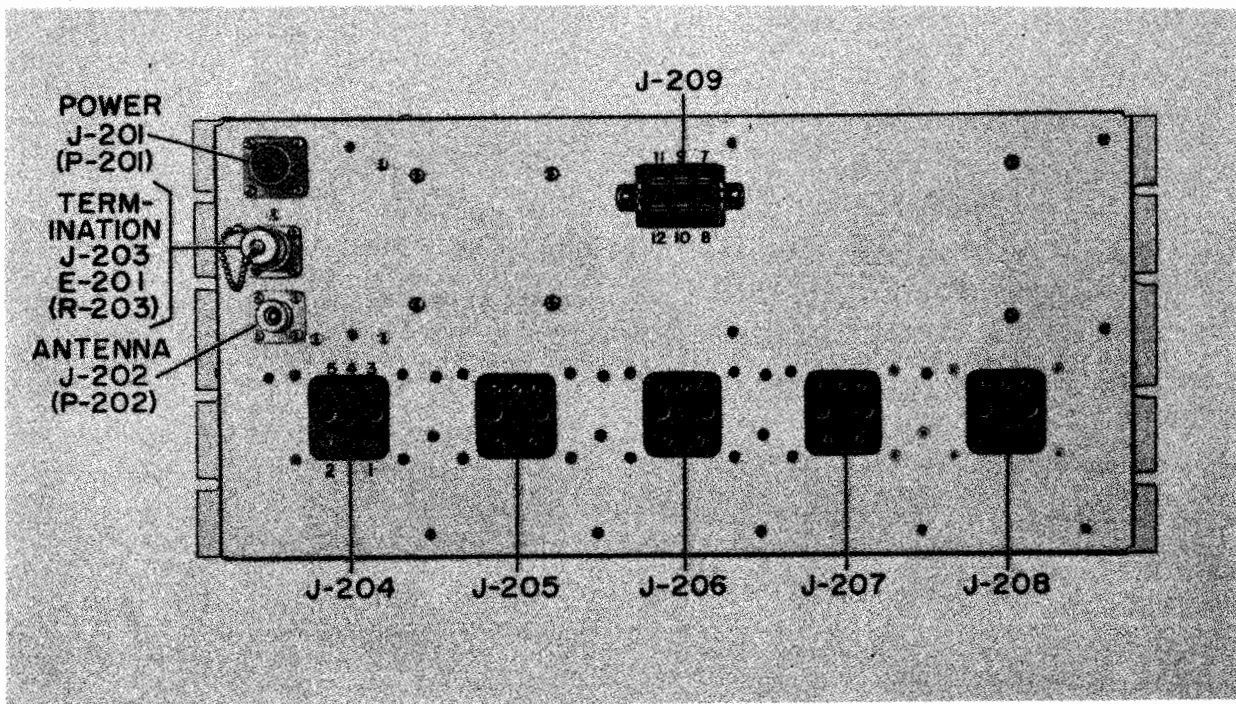

Figure 7-3. Main Chassis, Rear View

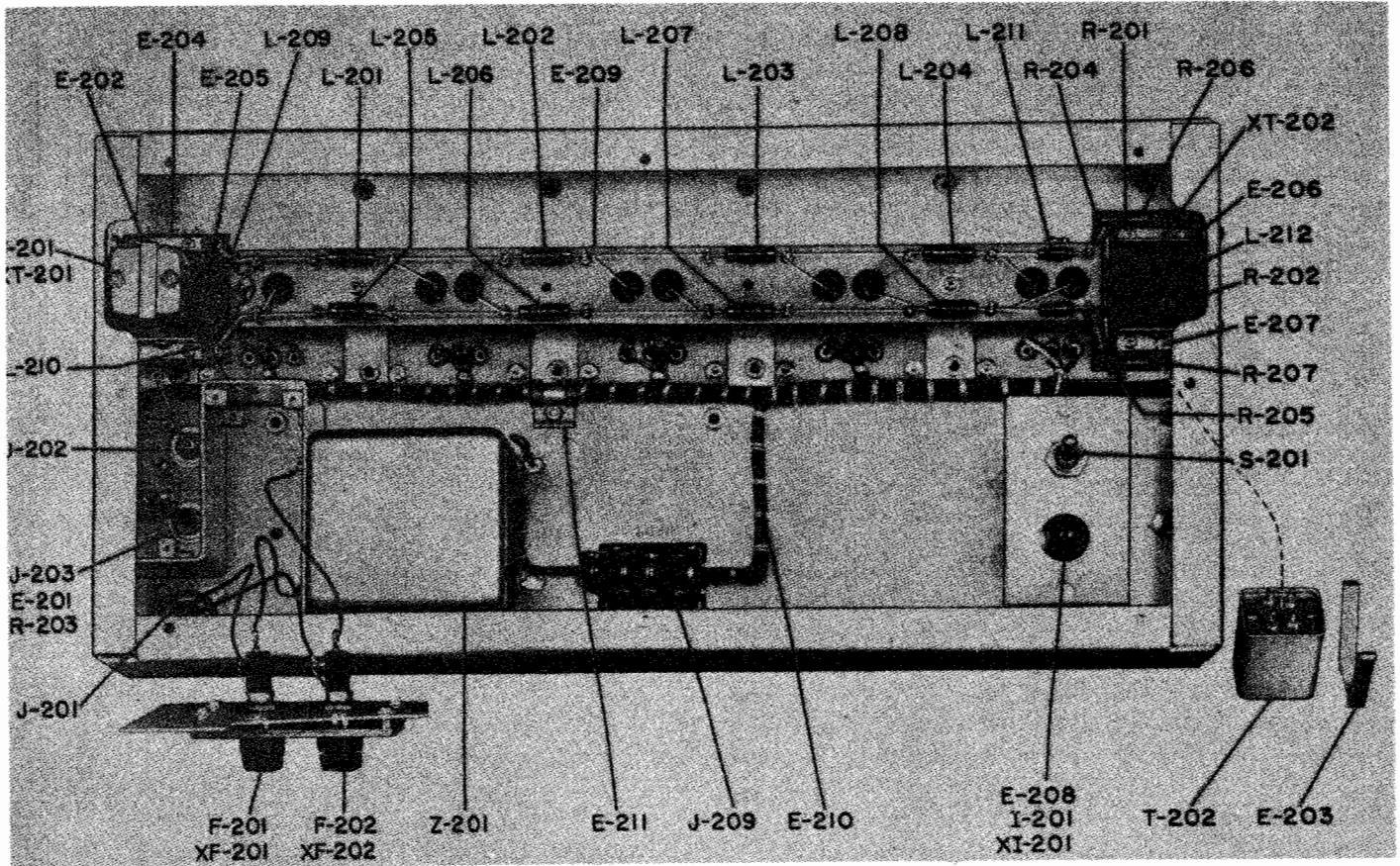

Figure 7-4. Main Chassis, Front Internal View

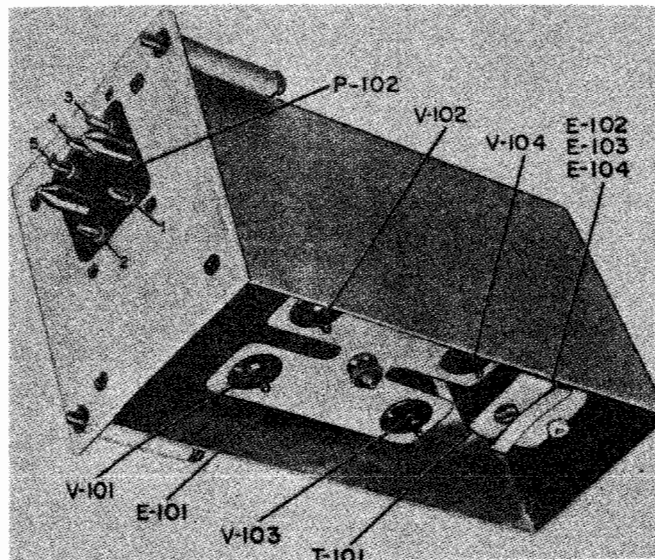

Figure 7-5. R-F Amplifier (AM-101), Bottom Oblique Interior View
(Dust Cover Removed)

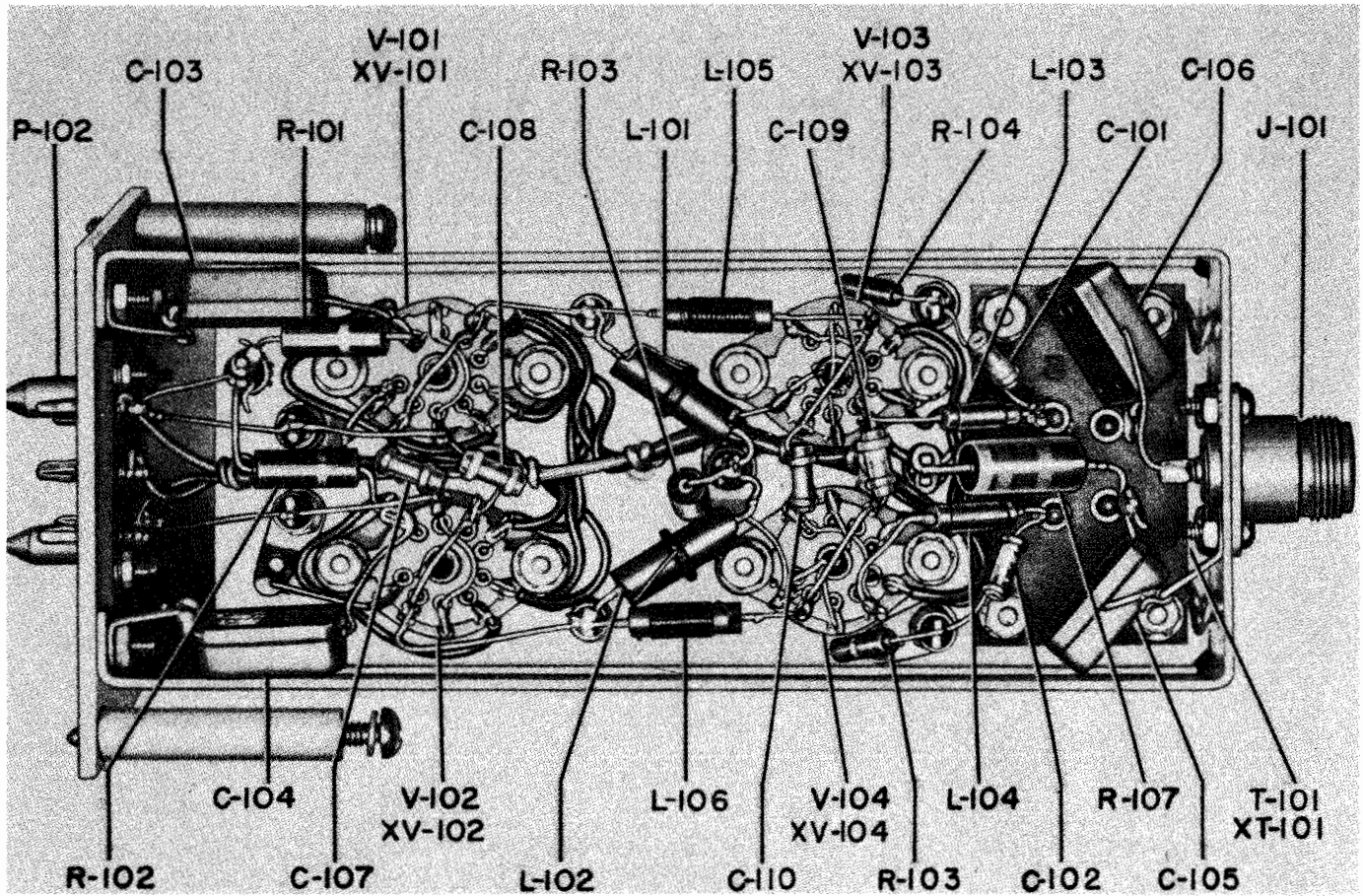

Figure 7-6. R-F Amplifier (AM-101), Top Interior View

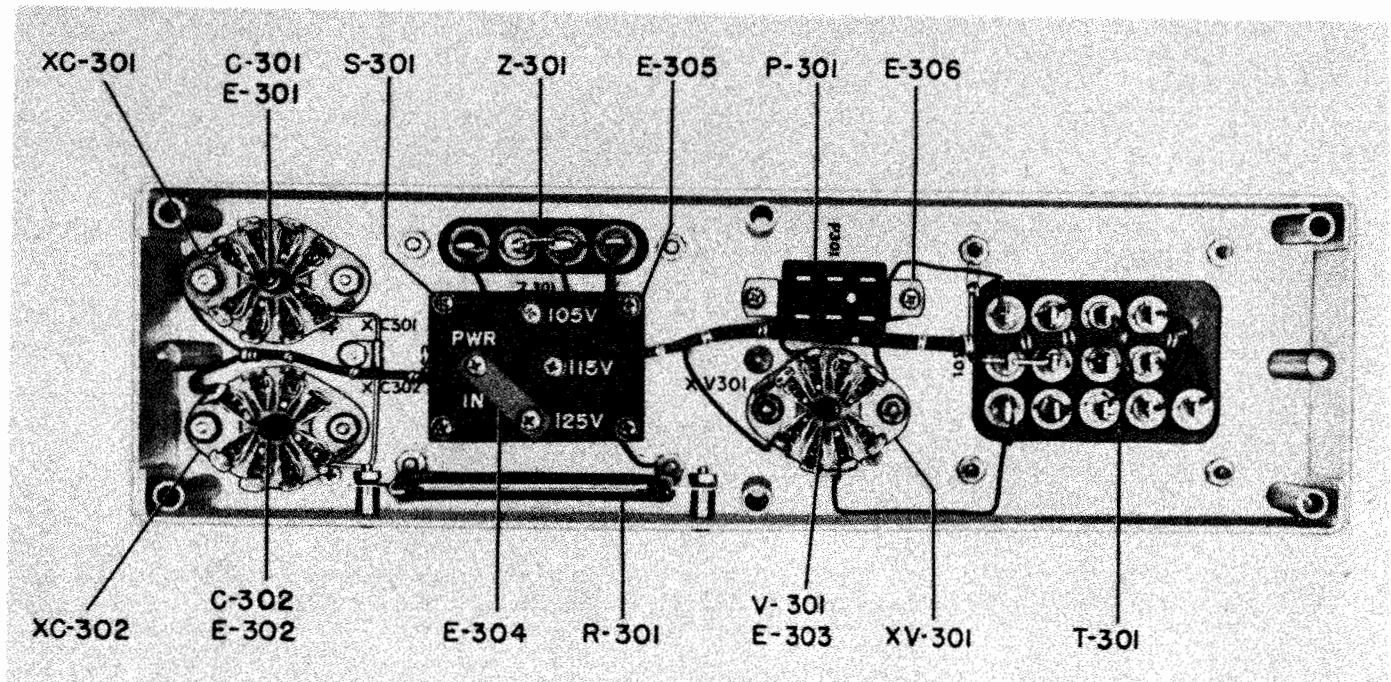

Figure 7-7. Power Supply (PU-301), Front Interior View

TABLE 7-2. TERMINAL VOLTAGE CHART

Unless otherwise indicated, all voltage measurements have been taken with respect to chassis ground; a-c voltages have been measured with a 1,000-ohm-per-volt voltmeter; d-c voltages have been measured with a 20,000-ohm-per-volt voltmeter; PWR IN switch S-301 at "115 V"; 115 volts ac at 60 cps input to "PWR" receptacle J-201; all units in place and connected for operation; no signal input.

R-F AMPLIFIER (AM-101)

Component	Terminal	Voltage	Remarks or Precautions
XV-101, XV-102	1	120 DC	
	2	0.0	
	3	3.0 DC	
	4	6.0 AC	
	5	6.0 AC	
	6	120 DC	
	7	0.0	
	8	3.0 DC	
	9	0.0	
XV-103, XV-104	1	120 DC	
	2	0.0	
	3	3.0 DC	
	4	6.0 AC	
	5	6.0 AC	
	6	120 DC	
	7	0.0	
	8	3.0 DC	
	9	0.0	
P-102	1	0.0	
	2	0.0	
	3	130 DC	
	4	6.0 AC	
	5	6.0 AC	
XT-101	1	120 DC	
	2	120 DC	
	3	120 DC	
	4	120 DC	
MAIN CHASSIS			
J-204 to J-208	1	0.0	
	2	0.0	
	3	130 DC	
	4	6.0 AC	
	5	6.0 AC	
J-209	7	60 AC	Chassis not grounded to a-c line Chassis not grounded to a-c line
	8	60 AC	
	9	130 DC	
	10	6.0 AC	
	11	6.0 AC	
	12	0.0	

TABLE 7-2. TERMINAL VOLTAGE CHART (Cont)

MAIN CHASSIS (Cont)

Component	Terminal	Voltage	Remarks or Precautions
XT-201	1	0.0	Negligibly small
	2	0.0	
	3	0.0	
	4	0.0	
XT-202			Same as T-201
Z-201	1	60 AC	Chassis not grounded to a-c line Chassis not grounded to a-c line Chassis not grounded to a-c line Chassis not grounded to a-c line
	2	60 AC	
	3	60 AC	
	4	60 AC	
J-201	A	60 AC	Chassis not grounded to a-c line Chassis not grounded to a-c line Chassis not grounded to a-c line
	B	0.0	
	C	60 AC	
POWER SUPPLY (PU-301)			
XV-301	1	0.0	
	2	135 DC	
	3	0.0	
	4	215 AC	
	5	0.0	
	6	215 AC	
	7	0.0	
	8	135 DC	
T-301	1	60 AC	Chassis not grounded to a-c line Chassis not grounded to a-c line Chassis not grounded to a-c line Chassis not grounded to a-c line
	2	45 AC	
	3	60 AC	
	4	70 AC	
	5	135 DC	
	6	135 DC	
	8	60 AC	
	9	0.0	
	10	6.0 AC	
	11	215 AC	
	12	0.0	
	13	215 AC	
	Z-301	1	
2		135 DC	
3		135 DC	
4		135 DC	
XC-301, XC-302	1	0.0	
	5	135 DC	
P-301	7	60 AC	Chassis not grounded to a-c line Chassis not grounded to a-c line
	8	60 AC	
	9	130 DC	
	10	6.0 AC	
	11	6.0 AC	
	12	0.0	

TABLE 7-3. TERMINAL RESISTANCE CHART

Unless otherwise indicated, all resistance measurements have been taken with respect to chassis ground; power-input cable has been removed from "PWR" receptacle J-201; antenna lead-in disconnected from jack J-202; termination E-201 disconnected from jack J-203; PWR IN switch S-301 at "115 V"; all subassemblies removed from main chassis.



Make sure that the power-input cable has been removed from jack J-201 and that all capacitors in B-plus circuits have been fully discharged before making resistance readings.

R-F AMPLIFIER (AM-101)

Component	Terminal	Resistance
XV-101, XV-102	1	Infinite
	2	Infinite
	3	60
	4	1.7
	5	1.7
	6	Infinite
	7	Infinite
	8	60
	9	0.0
XV-103, XV-104	1	Infinite
	2	0.0
	3	60
	4	1.7
	5	1.7
	6	Infinite
	7	0.0
	8	60
	9	0.0
P-102	1	Infinite
	2	Infinite
	3	Infinite
	4	1.7
	5	1.7
XT-101	1	Infinite
	2	Infinite
	3	Infinite
	4	Infinite

MAIN CHASSIS

J-204	1	2.5
	2	2.5
	3	Infinite
	4	Infinite
	5	17

Component	Terminal	Resistance
J-205	1	2.8
	2	2.8
	3	Infinite
	4	Infinite
	5	17
J-206	1	3.0
	2	3.0
	3	Infinite
	4	Infinite
	5	17
J-207	1	3.1
	2	3.1
	3	Infinite
	4	Infinite
	5	17
J-208	1	3.3
	2	3.3
	3	Infinite
	4	Infinite
	5	17
J-209	7	Infinite
	8	Infinite
	9	Infinite
	10	Infinite
	11	17
	12	0.0
XT-201°	1	0.2
	2	0.0
	3	2.2
	4	2.2

°See also Winding Data, Table 7-6

TABLE 7-3. TERMINAL RESISTANCE CHART (Cont)

MAIN CHASSIS (Cont)

Component	Terminal	Resistance
XT-202°	1	0.2
	2	0.0
	3	2.3
	4	2.3
Z-201#	1	Infinite
	2	Infinite
	3	Infinite
	4	Infinite
J-201#	A	Infinite
	B	0.0
	C	Infinite

POWER SUPPLY (PU-301)

XV-301	1	Infinite
	2	10,000
	3	Infinite
	4	30
	5	Infinite
	6	32
	7	Infinite
	8	10,000
T-301°	1	Infinite
	2	Infinite

°See also Winding Data, Table 7-6
"ON-OFF" switch S-201 "OFF"

Component	Terminal	Resistance	
	3	Infinite	
	4	Infinite	
	5	10,000	
	6	10,000	
	7	10,000	
	8	0.0	
	9	0.0	
	10	0.0	
	11	30	
	12	0.0	
	13	32	
	Z-301°	1	10,000
		2	10,000
3		10,000	
4		10,000	
XC-301, XC-302	1	0.0	
	5	10,000	
P-301	7	Infinite	
	8	Infinite	
	9	10,000	
	10	0.0	
	11	0.0	
	12	0.0	

°See also Winding Data, Table 7-6

TABLE 7-4. TUBE OPERATING VOLTAGES AND CURRENTS

FUNCTION	¹ V-101, V-102 Cathode- coupled r-f amplifier	V-103, V-104 Grounded- grid r-f amplifier	V-301 Full- wave rectifier
TUBE TYPE	12AU7	12AU7	5U4G
³ FILAMENT VOLTAGE (V)	² 6.3 (4,5)	² 6.3 (4,5)	⁴ 5.0 (2,8)
FILAMENT CURRENT (A)	0.15	0.15	3.0
³ PLATE VOLTAGE (V)	117 (1,6)	119 (1,6)	—
GRID VOLTAGE (V)	0.0 (2,7)	0 (2,7)	—
³ CATHODE VOLTAGE (V)	2.8 (3,8)	2.8 (3,8)	—
PLATE CURRENT (MA)	12.5	12.5	—

¹Both sections are tied together; numbers in parenthesis indicate pins.

²6.3 volts ac to ground from pins indicated; 12.6 v across filament.

³Voltage to ground from pin indicated.

TABLE 7-5. TUBE CHARACTERISTICS





TUBE TYPE	12AU7	5U4G
FILAMENT VOLTAGE (V)	¹ 12.6	5.0
FILAMENT CURRENT (A)	¹ 0.15	3.0
PLATE VOLTAGE (V)	² 250	³ 900 (rms plate-to-plate)
GRID BIAS (V)	² -8.5	—
PLATE CURRENT (MA)	² 10.5	³ 225 (a-c output)
A-C PLATE RESISTANCE (OHMS)	² 7700	—
VOLTAGE AMPLIFICATION FACTOR (MU)	² 17	—
TRANSCONDUCTANCE (MICROMHOS)	² 2200	—

¹Series connected.

²Typical.

³Typical design-center values for full-wave rectifier.

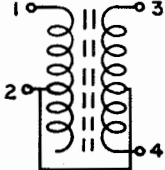
TABLE 7-6. WINDING DATA

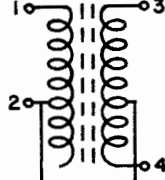
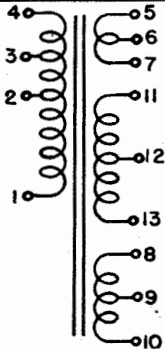
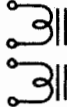
DESIG- NATION SYMBOL	COLLINS PART NUMBER	DIAGRAM	WINDING	WIRE SIZE (AWG)	TURNS	RESIS- TANCE (OHMS)
L-101 L-102 (34uh)	240-9004-009		Choke	No. 40	59	5
L-103 L-104 L-209 L-210 L-211 L-212 (3.2uh)	240-9002-009		Choke	No.34	34	0.5
T-101	596-0715-003		Pri. Sec.	No. 32 No. 40	8 & 8 ± 1/8 39 CT ± 1/8	5.4 0.2
L-201 L-202 L-203 L-204 L-205 L-206 L-207 L-208 (4uh)	240-9003-009		Choke	No. 30	34	0.4
L-105 L-106 (1.4 uh)	240-9001-009		Choke	No. 30	22	0.14
T-201 T-202	596-0712-003		Pri. Sec.	No. 32 No. 40	8 & 8 ± 1/8 31 CT ± 1/8	0.2 4.6
T-301	672-9000-00		Pri. Sec. No. 1 Sec. No. 2 Sec. No. 3			2.0 60 .01 0.16
Z-301	678-9000-00		Choke No. 1 Choke No. 2			3.2 12

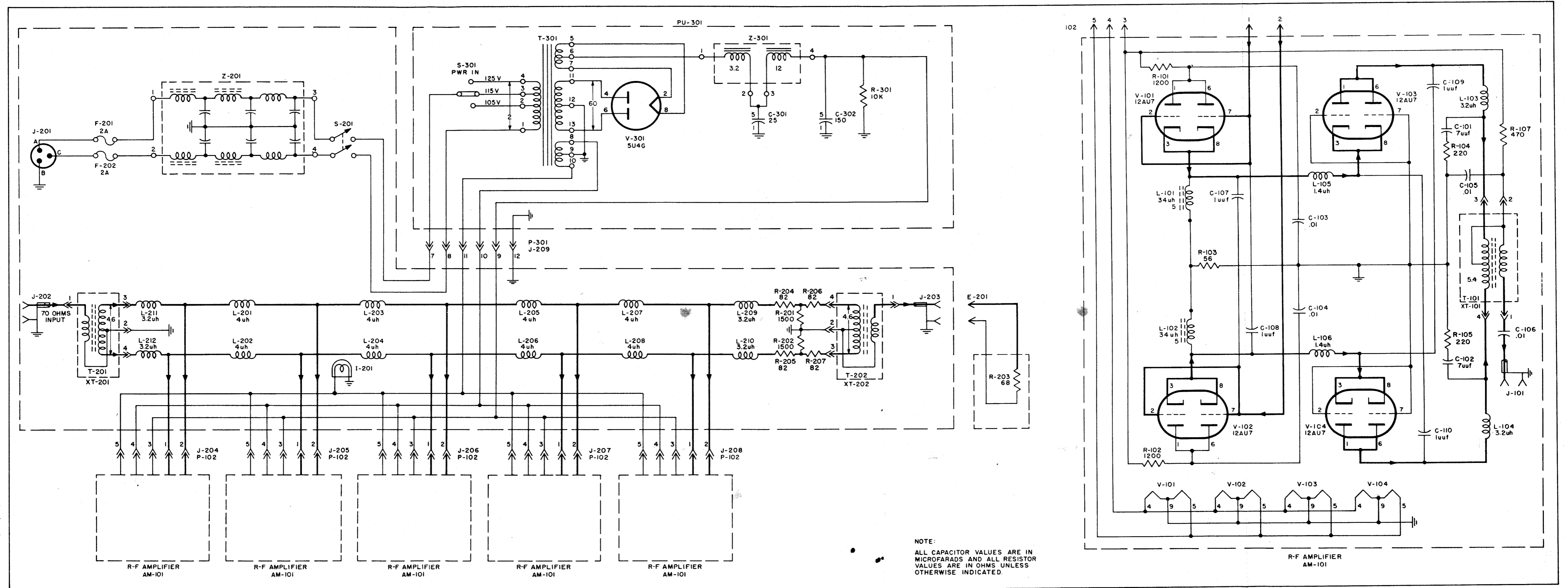

471638 O-58 (Page p. 34)

Figure 7-8. Antenna Coupler CU-168/FRR, Schematic Diagram

SECTION 8
PARTS LIST

TABLE 8-1. WEIGHTS AND DIMENSIONS OF SPARE PARTS BOXES

EQUIPMENT SPARES						TENDER SPARES						STOCK SPARES					
SPARE PARTS BOX	OVERALL DIMENSIONS			VOL-UME	WEIGHT	SPARE PARTS BOX	OVERALL DIMENSIONS			VOL-UME	WEIGHT	SPARE PARTS BOX	OVERALL DIMENSIONS			VOL-UME	WEIGHT
	HEIGHT	WIDTH	DEPTH				HEIGHT	WIDTH	DEPTH				HEIGHT	WIDTH	DEPTH		
	6"	3"	3"	1/32 cu. ft.													

TABLE 8-2. SHIPPING WEIGHTS AND DIMENSIONS OF SPARE PARTS BOXES

EQUIPMENT SPARES						TENDER SPARES						STOCK SPARES								
SHIP-PING BOX NUMBER	SPARE PARTS BOX	OVERALL DIMENSIONS			VOL-UME	WT.	SHIP-PING BOX NUMBER	SPARE PARTS BOX	OVERALL DIMENSIONS			VOL-UME	WT.	SHIP-PING BOX NUMBER	SPARE PARTS BOX	OVERALL DIMENSIONS			VOL-UME	WT.
		HT.	WD.	DP.					HT.	WD.	DP.					HT.	WD.	DP.		
							NONE REQUIRED													

NAVSHIPS 91697(A)

TABLE 8-3. LIST OF SUBASSEMBLIES

SYMBOL GROUP	QUANTITY	NAME OF SUBASSEMBLY	NAVY STOCK NUMBER
101-199	1	R-F Amplifier	N16-A-33715-1001
201-299	1	Main Chassis	*
301-399	1	Power Supply	F16-P-66910-1001

*Not furnished as a maintenance part. If failure occurs, do not request replacement unless the item cannot be repaired or fabricated.

TABLE 8-4. TABLE OF REPLACEABLE PARTS (Cont)

REFERENCE DESIGNATION	STOCK NUMBERS SIGNAL CORPS, NAVY, AIR FORCE	NAME AND DESCRIPTION	LOCATING FUNCTIONS
C-104		Same as C-103	V-102 plate bypass
C-105		Same as C-103	V-103, V-104 plate bypass
C-106		Same as C-103	Output coupling
C-107	<u>N16-C-15368-5828</u>	CAPACITOR, FIXED, CERAMIC DIELECTRIC; body style No. 1, ref dwg group 1; 1 mmf capacity ± 0.25 mmf tolerance; 500 v DC; uninsulated; 0.400 in. lg, 0.200 in. dia; 2 rigid wire terminals; terminal mounted; 0.0 mmf per mf per deg. C temp. coefficient, +250, -340 mmf per mf per deg. C tolerance; JAN Spec No. JAN-C-20A, JAN Type No. CC20CK010C; CASU Part No. CN1-NPO-250-010-N330	Neutralizing Capacitor Amplifier input stage
C-108		Same as C-107	Neutralizing Capacitor Amplifier input stage
C-109		Same as C-107	Neutralizing Capacitor Amplifier output stage
C-110		Same as C-107	Neutralizing Capacitor Amplifier output stage
E-101	*N16-R-503580-250	CLAMP, ELECTRICAL; spring brass, cadmium plate; 3-1/8 in. lg, 2 in. wide, 0.020 in. thick; mounted by one 0.171 in. dia hole in center of clamp; Collins Radio Co. Part No. 596-0697-002	Clamp for V-301 thru V-304
E-102	*N17-B-750001-241	HOLDER, CLAMP; aluminum, caustic dip; transformer clamp hooks through 0.312 in. dia hole in vertical leg of holder; two 0.125 in. dia mounting holes on 0.875 in. mounting center; Collins Radio Co. Part No. 596-0671-001	Bracket for Transformer clamp E-104
E-103		Same as E-102	Bracket for Transformer clamp E-104
E-104	N17-S-46782-3399	CLAMP, ELECTRICAL; beryllium copper, cadmium plate; 0.020 in. thick; two clamp angles; 3 in. lg, 1-1/2 in. high, 1/4 in. wide; mounted by hook in each end through holes in clamp angles; Collins Radio Co. Part No. 596-0686-002	Clamp for RF Transformer T-101

*Not furnished as a maintenance part. If failure occurs, do not request replacement unless the item cannot be repaired or fabricated.

TABLE 8-4. TABLE OF REPLACEABLE PARTS (Cont)

REFERENCE DESIGNATION	STOCK NUMBERS SIGNAL CORPS, NAVY, AIR FORCE	NAME AND DESCRIPTION	LOCATING FUNCTIONS
E-105 thru E-114		TERMINAL, STUD; style No. 55, MBCA ref dwg group 21; solder connection; hot tin dipped brass terminal; molded melamine body, cadmium plated brass insert; 23/32 in. lg, 17/32 in. dia; mounts by tapped insert No. 4-40 NC-2, 3/16 in. deep; Whitso, Inc., Chicago, Ill.	Panel board feed through
H-101		NUT, KNURLED; brass, cadmium plate, No. 8-32 NC-2; 7/16 in. dia across knurl; 5/16 in. over-all height; Pheoll Mfg. Co., Chicago, Ill.	Secures Clamp E-101
J-101	<u>N17-C-73108-5906</u>	CONNECTOR, RECEPTACLE; one rd female contact; non-polarized; straight type; not banana or phone type; 50 ohms nominal impedance; JAN Spec No. JAN-C-71, JAN Type No. UG58A/U; CPH Part No. 82-97; for general purpose use	Amplifier output Connector
L-101	<u>N16-C-73445-5301</u>	COIL, RADIO FREQUENCY; 34 mh at 2.5 mc; 4.3 ohms DC resistance; 50 ma; 59 turns; No. 40AWG wire; copper conductor; enamel-single rayon covered; one pie universal winding; untapped; unshielded; molded phenolic form and core; 11/32 in. dia, 1/16 in. lg coil; 1/4 in. dia, 3/4 in. lg overall coil form; two wire pigtail type terminals; located on ends of coil form; Acme Electronics Co., Los Angeles, Calif., Part No. PC-1-3	Cathode coupling choke
L-102		Same as L-101	Cathode coupling choke
L-103	<u>N16-C-72928-2818</u>	COIL, RADIO FREQUENCY; 3.2 mh at 7.9 mc; 1/2 ohm DC resistance; 15 ma; approx 34 turns No. 34 AWG wire; copper conductor; enameled magnet wire; one single layer winding; unshielded; phenolic form; 0.194 in. dia, 0.225 in. lg coil; 3/16 in. dia, 1/2 in. lg coil form overall; two wire pigtail type terminals; located on end; terminal mounted; peaking coil; Collins Radio Co. Part No. 240-9002-009	Plate peaking choke in output stage
L-104		Same as L-103	Plate peaking choke in output stage
L-105	<u>N16-C-72811-4075</u>	COIL, RADIO FREQUENCY; 1.4 mh at 7.9 mc; 0.135 ohm DC resistance; 30 ma; approx 22 turns No. 30 AWG wire; copper conductor; enameled magnet wire; one single layer winding; unshielded; phenolic form; 0.1983 in. dia, 0.238 in. lg coil; 3/16 in. dia, 1/2 in. lg coil form overall; two wire pigtail type terminals; located on end; terminal mounted; 2 to 32 mc frequency range; Collins Radio Co., Part No. 240-9001-009	Cathode coupling choke

TABLE 8-4. TABLE OF REPLACEABLE PARTS (Cont)

REFERENCE DESIGNATION	STOCK NUMBERS SIGNAL CORPS, NAVY, AIR FORCE	NAME AND DESCRIPTION	LOCATING FUNCTIONS
L-106		Same as L-105	Cathode coupling choke
P-101	N17-C-71416-2550	CONNECTOR, PLUG; one rd male contact; non-polarized; straight type; not banana or phone type; 50 ohms nominal impedance; constant frequency impedance characteristic; JAN Spec No. JAN-C-71; JAN Type No. UG21B/U; CPH Part No. 82-61; for general purpose use	Connects Antenna coupler to receiver
P-102	*N17-C-73506-1484	PLUG BOARD ASSEMBLY; five male contacts; polarized; straight type; banana type connector; natural nylon phenolic, type NPG; 1-15/16 in. lg, 1-17/32 in. wide, 23/32 in. thick; contacts not electrically rated; no impedance rating; non-constant frequency impedance characteristic; rectangular body; natural nylon phenolic, type NPG; non-locking type; not split shell; four 0.96 in. dia mounting holes on 1.687 by 1.125 in. mounting centers; Collins Radio Co. Part No. 596-0688-00; p/o Antenna Coupler CU-168/FRR	Connects Amplifier AM-101 to main chassis
R-101	<u>N16-R-49941-231</u>	RESISTOR, FIXED, COMPOSITION; body style No. 14, MBCA ref dwg group 2; 1200 ohms total resistance $\pm 10\%$ tolerance; 1 watt power dissipation; F resistance temp characteristic; JAN Spec No. JAN-R-11, JAN Type No. RC30BF122K; CBZ; for general purpose use	Plate decoupling resistor for input stage
R-102		Same as R-101	Plate decoupling resistor for input stage
R-103	<u>N16-R-49462-751</u>	RESISTOR, FIXED, COMPOSITION; body style No. 14, MBCA ref dwg group 2; 56 ohms total resistance $\pm 5\%$ tolerance; 1 watt power dissipation; F resistance temp characteristic; JAN Spec No. JAN-R-11, JAN Type No. RC30BF560J; CBZ; for general purpose use	Bias resistor
R-104	<u>N16-R-49661-811</u>	RESISTOR, FIXED, COMPOSITION; body style No. 14, MBCA ref dwg group 2; 220 ohms total resistance $\pm 10\%$ tolerance; 1/2 watt power dissipation; F resistance temp characteristic; JAN Spec No. JAN-R-11, JAN Type No. RC20BF221K; CBZ; for general purpose use	Parasitic suppressor
R-105		Same as R-104	Parasitic suppressor

*Not furnished as a maintenance part. If failure occurs, do not request replacement unless the item cannot be repaired or fabricated.

TABLE 8-4. TABLE OF REPLACEABLE PARTS (Cont)

REFERENCE DESIGNATION	STOCK NUMBERS SIGNAL CORPS, NAVY, AIR FORCE	NAME AND DESCRIPTION	LOCATING FUNCTIONS
R-106		Deleted	
R-107	<u>N16-R-49770-551</u>	RESISTOR, FIXED, COMPOSITION; body style No. 14, MBCA ref dwg group 2; 470 ohms total resistance $\pm 10\%$ tolerance; 2 watt power dissipation; F resistance temp characteristic; JAN Spec No. JAN-R-11, JAN Type No. RC40BF471K; CBZ; for general purpose use	Plate decoupling resistor for output stage
T-101	<u>N17-T-81160-1176</u>	TRANSFORMER, RADIO FREQUENCY; three windings, two layers; 122 mh $\pm 2\%$ at 1 mc primary inductance of windings, 6.30 mh $\pm 2\%$ at 3 mc secondary inductance of windings, shield winding not terminated but grounded at one end; 39 turns No. 40 AWG copper wire primary, 8 turns No. 32 AWG copper wire secondary, 8 turns No. 32 AWG copper wire shield; 5.40 ohms $\pm 5\%$ primary, 0.200 ohms $\pm 5\%$ secondary, DC resistance; 2 to 32 mc frequency range, not tuned; secondary center-tapped 19-1/2 turns; rectangular shield can; aluminum, caustic dip; 1-1/2 in. high overall excluding terminals and mounting attachments, 1-5/32 in. lg, 1-5/32 in. wide; powdered iron coil form and core; 5/8 in. lg, 3/8 in. dia coil form overall; no adjustable tuning; plugs into four contact terminal board assy; four banana plug type terminals located on bottom; coated with varnish; Collins Radio Co. Part No. 596-0715-003; p/o Antenna Coupler CU-168/FRR	RF output transformer
V-101	<u>N16-T-58241</u>	ELECTRON TUBE; dual triode; glass envelope, type RMA T-6-1/2; nine pin type terminations located on bottom; receiving type; JAN Spec No. JAN-1A, JAN Type No. JAN 12AU7; CRC; for general purpose use	Cathode follower input stage
V-102		Same as V-101	Cathode follower input stage
V-103		Same as V-101	Grounded grid output stage
V-104		Same as V-101	Grounded grid output stage
XT-101	_____	SOCKET, TRANSFORMER; four contacts; yellow brass, silver plated; rectangular shape; 2-1/8 in. lg, 1-1/4 in. wide, 5/16 in. thick overall excluding terminals; natural nylon phenolic, type NPG body; screws to chassis; 1 in. dia chassis hole required; four 0.136 in. dia mounting holes on 1.750 in. by 0.875 in. mounting centers; Collins Radio Co. Part No. 596-0702-00; p/o Antenna Coupler CU-168/FRR	Socket for T-101

TABLE 8-4. TABLE OF REPLACEABLE PARTS (Cont)

REFERENCE DESIGNATION	STOCK NUMBERS SIGNAL CORPS, NAVY, AIR FORCE	NAME AND DESCRIPTION	LOCATING FUNCTIONS
XV-101 thru XV-104	<u>N16-S-64063-6456</u>	SOCKET, ELECTRON TUBE; nine contacts; beryllium copper, silver plated; miniature size body; no metal shield; 0.165 in. ID center shield included; oval shape; 1-7/16 in. lg, 27/32 in. wide, 5/8 in. high overall including terminals; ceramic body; one piece saddle mounting; 3/4 in. dia chassis hole required; two 0.125 in. dia mounting holes on 1.125 in. mounting centers; CNA Part No. 491844; for general purpose use	Socket for V-101 thru V-104
201 thru 299	* _____	CHASSIS SUBASSEMBLY, MAIN; aluminum; 14.31 in. lg, 8.46 in. wide, 2-1/4 in. deep; rectangular shape; equipped with pem nuts for mounting components; Collins Radio Co. Part No. 596-0730-005	
A-201	* _____	HANDLE; aluminum; black wrinkle finish; 7.18 in. lg, 1/75 in. high, 1/2 in. dia; tapped hole each end, 1/4-20 NC-2, 5/8 in. deep; Collins Radio Co. Part No. 596-0679-002	Lifting device for main chassis
A-202	* _____	PANEL, FUSE; mounts 2 fuses; rectangular shape; 3-1/8 in. lg, 1-3/4 in. wide, 0.125 in. thick; aluminum, gray enamel finish; four tapped No. 4-40 NC-2 mounting holes on 2.875 and 0.875 in. mounting centers; Collins Radio Co. Part No. 596-0680-002	Mounts F-201 and F-202 fuses
A-203	* _____	COVER INPUT SHIELD; aluminum; 4-1/2 in. lg, 3-5/16 in. wide; four 0.144 in. dia mounting holes on 3.344 and 1-1/4 and 2 in. mounting centers; Collins Radio Co. Part No. 596-0698-002	Cover for input shield A-204
A-204	* _____	SHIELD, ANTENNA COUPLER INPUT; U shaped; aluminum; 4-29/64 in. lg overall, 3-9/32 in. wide overall, 1-53/64 in. high; equipped with four tapped No. 4-40 mounting block; four 0.136 in. dia mounting holes on 1.125 in. mounting center; Collins Radio Co. Part No. 596-0718-003	AC input shield
A-205	* _____	PLATE, ELECTRICAL SWITCH; two 0.159 in. dia mounting holes on 2.937 in. mounting center; aluminum; rectangular shape; 3-5/16 in. lg, 1-7/8 in. wide, 0.125 in. thick; Collins Radio Co. Part No. 596-0685-002	Mechanically mounts S-201 Power Switch and I-201 Pilot Light
A-206	* _____	PLATE, MOUNTING; aluminum, gray enamel finish; 19 in. lg, 8-23/32 in. wide, 0.188 in. thick; eight 0.218 in. dia	Cover for main chassis

*Not furnished as a maintenance part. If failure occurs, do not request replacement unless the item cannot be repaired or fabricated.

TABLE 8-4. TABLE OF REPLACEABLE PARTS (Cont)

REFERENCE DESIGNATION	STOCK NUMBERS SIGNAL CORPS, NAVY, AIR FORCE	NAME AND DESCRIPTION	LOCATING FUNCTIONS
A-206 (Cont)		mounting holes on 7-1/2 in. and 7.18 in. mounting centers; Collins Radio Co. Part No. 596-0721-004	
A-207	* _____	MOUNTING, BRACKET; aluminum; L shaped; 2 in. lg, 7/8 in. deep, 1-3/8 in. wide; four 0.136 in. dia mounting holes on 1.75 and 0.875 in. mounting centers; Collins Radio Co. Part No. 596-0705-002	Part of mounting for T-201 Transformer
A-208		Same as A-207	Mounting for T-202 Transformer
A-209	* _____	CHASSIS SUBASSEMBLY; aluminum; 14.31 in. lg, 8.46 in. wide, 2-1/4 in. deep; rectangular shape; equipped with pem nuts for mounting components; Collins Radio Co. Part No. 596-0731-005	Chassis for Antenna Coupler
E-201	* <u>N16-L-85773-9911</u>	DUMMY, LOAD ELECTRICAL; resistive impedance; 2 watts peak, 0 watts nominal power dissipation; 2 to 30 mc operating frequency range; 68 ohms input impedance; one termination; mounted in standard AN-UC-21b/U plug with cap; located on end; 1-3/4 in. lg, 3/4 in. dia; mounts on standard chassis connector AN-UC-58/U; Collins Radio Co. Part No. 596-0700-002	Load for artificial transmission line
E-202		Same as E-104	Clamp for RF Transformer T-201
E-203		Same as E-104	Clamp for RF Transformer T-202
E-204		Same as E-102	Bracket for RF Transformer Clamp E-202
E-205		Same as E-102	Bracket for RF Transformer Clamp E-202
E-206		Same as E-102	Bracket for RF Transformer Clamp E-203
E-207		Same as E-102	Bracket for RF Transformer Clamp E-203
E-208	N17-L-250627-635	LENS, INDICATOR LIGHT; red; 9/16 in. dia; hemispherical type; glass; smooth, clear; 5/8 in. lg overall, 21/32 in. dia;	Red filter for Lamp I-201

*Not furnished as a maintenance part. If failure occurs, do not request replacement unless the item cannot be repaired or fabricated.

TABLE 8-4. TABLE OF REPLACEABLE PARTS (Cont)

REFERENCE DESIGNATION	STOCK NUMBERS SIGNAL CORPS, NAVY, AIR FORCE	NAME AND DESCRIPTION	LOCATING FUNCTIONS
E-208 (Cont)		holder mounted; brass, chrome plate; threaded type mounting; 9/16-27, 3/8 in. lg including shank; CAYS Part No. 25SP red; general purpose use (Part of X1-201)	
E-209	*N17-B-78142-5051	TERMINAL BOARD; nylon phenolic sheet-type NPG, natural; includes 20 terminals; split, solder type terminal lug; w/o barriers; 13-5/8 in. lg, 1-1/4 in. wide, 31/64 in. thick; four 0.136 in. dia holes, 3-1/8 in. C to C; 18 terminals marked L201 through L210; Collins Radio Co. Part No. 596-0714-003	Support for artificial transmission line
E-210	N17-C-781117-351	CLAMP, ELECTRICAL; aluminum, one screw type fastening device; 5/16 in. dia, 5/8 in. deep; two mounting holes; 0.171 in. dia and 0.203 in. dia; 5/16 in. dia cable; 1/32 in. thick insulation; flame resistant extruded synthetic channel; Tinnerman Products, Inc., Cleveland, Ohio, Part No. A-3044-2; general purpose use	Secures AC and DC wiring
E-211		Same as E-210	Secures AC, DC, and RF wiring
F-201	G17-F-16302-100	FUSE, CARTRIDGE; 2 amp, 250 v; instantaneous operation; ferrule type terminals; 1/4 in. lg, 1/4 in. dia; enclosed type; glass; one time; non-indicating; 1-1/4 in. lg, 1/4 in. dia overall; CFA Part No. 3AG/2A; general purpose use	Overload protector for power Transformer T-301
F-202		Same as F-201	Overload protector for power Transformer T-301
H-201	*	SPACER; fuse; aluminum; round; 0.625 in. OD, 0.576 in. ID, 0.178 in. thick; Collins Radio Co. Part No. 596-0667-001	Spacer for F-201 fuse mounting
H-202		Same as H-201	Spacer for F-202 fuse mounting
H-203	*	SPACER; fuse plate; aluminum; round; 0.250 in. OD, 0.192 in. ID, 0.178 in. thick; Collins Radio Co. Part No. 596-0666-001	Spacer for fuse plate A-202 mounting
H-204		Same as H-203	Spacer for fuse plate A-202 mounting
H-205		Same as H-203	Spacer for fuse plate A-202 mounting

*Not furnished as a maintenance part. If failure occurs, do not request replacement unless the item cannot be repaired or fabricated.

TABLE 8-4. TABLE OF REPLACEABLE PARTS (Cont)

REFERENCE DESIGNATION	STOCK NUMBERS SIGNAL CORPS, NAVY, AIR FORCE	NAME AND DESCRIPTION	LOCATING FUNCTIONS
H-206		Same as H-203	Spacer for fuse plate A-202 mounting
I-201	G17-L-6297 66240-155-8706.	LAMP, INCANDESCENT; 6.3 v, 0.945 w, 0.15 amp; miniature bayonet base; t-3-1/4 clear white bulb; one tungsten filament, not heavy duty; 1-1/8 in. height overall; over 25 hr rated life; any burning position; CG Part No. 47; general purpose use	Pilot light
J-201	N17-C-72604-1516	CONNECTOR, RECEPTACLE; three rd male contacts; polarized; not banana or phone type; 20 amp, 150 v AC rms contacts; not radio frequency connector; JAN Spec No. JAN-C-71; JAN Type No. AN3102-14S-7P; CPH	AC power input receptacle
J-202		Same as J-101	Antenna input connector.
J-203		Same as J-101	Tandem output connector
J-204	*N17-C-73217-3285	CONNECTOR, RECEPTACLE; five rd female contacts; polarized; straight type; banana connector head; natural nylon phenolic sheet, type NPG; 2-1/16 in. lg, 2 in. wide, 13/32 in. thick overall; contacts not electrically rated; non-constant frequency impedance characteristic; rectangular body; natural nylon phenolic sheet; type NPG; non-locking; not split shell; four 0.144 in. dia mounting holes on 1.625 in. by 2.000 in. mounting centers; Collins Radio Co. Part No. 596-0689-00	Connects RF amplifier to main chassis
J-205		Same as J-204	Connects RF Amplifier to main chassis
J-206		Same as J-204	Connects RF Amplifier to main chassis
J-207		Same as J-204	Connects RF Amplifier to main chassis
J-208	N17-C-73227-3359	Same as J-204	Connects RF Amplifier to main chassis
J-209	_____	CONNECTOR, RECEPTACLE; six flat female contacts; polarized; straight type; not banana or phone type; 2-1/2 in. lg, 1-3/16 in. wide, 7/8 in. high overall; 10 amp, 110 v contacts;	Connects power supply to main chassis

*Not furnished as a maintenance part. If failure occurs, do not request replacement unless the item cannot be repaired or fabricated.

TABLE 8-4. TABLE OF REPLACEABLE PARTS (Cont)

REFERENCE DESIGNATION	STOCK NUMBERS SIGNAL CORPS, NAVY, AIR FORCE	NAME AND DESCRIPTION	LOCATING FUNCTIONS
J-209 (Cont)		not radio frequency connector; rectangular body; natural phenolic; non-locking; not split shell; two 0.169 in. dia mounting holes on 2-1/16 in. mounting centers; withstand 48 hr salt spray test; CMG Part No. S-406-AB; for general purpose use	
L-201	<u>N16-C-72959-4535</u>	COIL, RADIO FREQUENCY; 4.0 mh at 8 mc; 0.4 ohm DC resistance; 34 turns; No. 30 AWG wire; copper conductor; enamel; one single layer winding; untapped; unshielded; molded phenolic form and core; 1/4 in. dia, 3/8 in. lg coil; 1/4 in. dia, 3/4 in. lg coil form overall; two wire pigtail type terminals; located on ends of coil form; p/o artificial transmission lines; Collins Radio Co. Part No. 240-9003-009; p/o Antenna Coupler CU-168/FRR	Artificial transmission line choke
L-202		Same as L-201	Artificial transmission line choke
L-203		Same as L-201	Artificial transmission line choke
L-204		Same as L-201	Artificial transmission line choke
L-205		Same as L-201	Artificial transmission line choke
L-206		Same as L-201	Artificial transmission line choke
L-207		Same as L-201	Artificial transmission line choke
L-208		Same as L-201	Artificial transmission line choke
L-209		Same as L-105	Artificial transmission line choke, end section
L-210		Same as L-103	Artificial transmission line choke, end section
L-211		Same as L-103	Artificial transmission line choke, end section
L-212		Same as L-103	Artificial transmission line choke, end section

ORIGINAL

TABLE 8-4. TABLE OF REPLACEABLE PARTS (Cont)

REFERENCE DESIGNATION	STOCK NUMBERS SIGNAL CORPS, NAVY, AIR FORCE	NAME AND DESCRIPTION	LOCATING FUNCTIONS
P-201		CONNECTOR, PLUG; three rd female contacts; polarized; straight type; not banana or phone type; 20 amp, 150 v AC rms contacts; not radio frequency connector; JAN Spec No. AN-W-C-591, JAN Type No. AN3106-14S-7S; CPH; for general purpose use	Connects AC line cord to receptacle J-202
P-202		Same as P-101	Connects antenna transmission line to receptacle J-202
R-201	N16-R-49966-431	RESISTOR, FIXED, COMPOSITION; body style No. 14, MBCA ref dwg group 2; 1500 ohms total resistance $\pm 5\%$ tolerance; 1/2 watt power dissipation; F resistance temp characteristic; JAN Spec No. JAN-R-11, JAN Type No. RC20BF152J; CBZ; for general purpose use	Transmission line termination shunt element
R-202		Same as R-201	Transmission line termination shunt element
R-203	N16-R-49499-171	RESISTOR, FIXED, COMPOSITION; body style No. 14, MBCA ref dwg group 2; 68 ohms total resistance $\pm 5\%$ tolerance; 2 watt power dissipation; F resistance temp characteristic; JAN Spec No. JAN-R-11, JAN Type No. RC40BF680J; CBZ; for general purpose use	Used on E-201
R-204	<u>N16-R-49534-431</u>	RESISTOR, FIXED, COMPOSITION; body style No. 14, MBCA ref dwg group 2; 82 ohms total resistance $\pm 5\%$ tolerance; 1/2 watt power dissipation; F resistance temp characteristic; JAN Spec No. JAN-R-11, JAN Type No. RC20BF820J; CBZ; for general purpose use	Transmission line termination series element
R-205		Same as R-204	Transmission line termination series element
R-206		Same as R-204	Transmission line termination series element
R-207		Same as R-204	Transmission line termination series element
S-201	<u>N17-S-73082-9028</u>	SWITCH, TOGGLE; DPST; 5 amp, 125 v AC; JAN Spec No. JAN-S-23, JAN Type No. ST22K; CHN Part No. 82305; for general purpose use	Power "on" and "off" switch

TABLE 8-4. TABLE OF REPLACEABLE PARTS (Cont)

REFERENCE DESIGNATION	STOCK NUMBERS SIGNAL CORPS, NAVY, AIR FORCE	NAME AND DESCRIPTION	LOCATING FUNCTIONS
T-201	<u>N17-T-81160-8155</u>	TRANSFORMER, RADIO FREQUENCY; three windings, two layers; 7.30 mh $\pm 2\%$ at 3 mc primary inductance of windings, 82 mh $\pm 2\%$ at 1 mc secondary inductance of windings, shield winding not terminated but grounded at one end; 8 turns No. 32 AWG copper wire primary, 31 turns No. 40 AWG copper wire secondary, 8 turns No. 32 AWG copper wire shield; 0.200 ohms $\pm 5\%$ primary DC resistance, 4.60 ohms $\pm 5\%$ secondary DC resistance; 2 to 32 mc frequency range, not tuned; secondary center tapped 15-1/2 turns; rectangular shield can; aluminum, caustic dip; 1-1/2 in. high overall excluding terminals and mounting attachments, 1-5/32 in. lg, 1-5/32 in. wide; powdered iron coil form and core; 5/8 in. lg, 3/8 in. dia coil form overall; no adjustable tuning; plugs into four contact terminal board assy; four banana plug type terminals located on bottom; coated with varnish; Collins Radio Co. Part No. 596-0712-003; p/o Antenna Coupler CU-168/FRR	Transmission line input transformer
T-202		Same as T-201	Transmission line output transformer
XF-201	<u>N17-F-74266-9085</u>	FUSEHOLDER; extractor post type; 15 amp max electrical rating; not spare-fuse holder; accommodates one cartridge type fuse, 1-1/4 in. lg, 1/4 in. dia; phenolic body; extractor type brass contacts, bright alloy plated; 2-17/64 in. lg, 11/16 in. dia overall; two solder lug type terminals; 1/2 in. dia mounting holes; CFA Part No. HKP-JR; for general purpose use	Holder for F-201
XF-202		Same as XF-201	Holder for F-202
XI-201	_____	LAMPHOLDER; consists of one item; accommodates miniature bayonet base lamp, MBCA ref dwg group 7; not electrically rated; steel, cadmium plated; 1-7/32 in. lg, 15/16 in. dia overall; two solder lug type terminals; one 11/16 in. dia stud; CAYS Part No. 50; for general purpose use	Holder for I-201
XT-201	*N17-M-88479-4001	SOCKET, TRANSFORMER; four contacts; yellow brass, silver plated; rectangular shape; 2-1/8 in. lg, 1-3/4 in. wide, 7/8 in. high overall excluding terminals; natural nylon phenolic, type NPG, and aluminum body; screw mounting; two 0.159 in. dia mounting holes on 1.5 in. mounting centers; two tie points on socket; Collins Radio Co. Part No. 596-1532-003; p/o Antenna Coupler CU-168/FRR	Socket for Transformer T-201

*Not furnished as a maintenance part. If failure occurs, do not request replacement unless the item cannot be repaired or fabricated.

TABLE 8-4. TABLE OF REPLACEABLE PARTS (Cont)

REFERENCE DESIGNATION	STOCK NUMBERS SIGNAL CORPS, NAVY, AIR FORCE	NAME AND DESCRIPTION	LOCATING FUNCTIONS
XT-202	*N17-M-88479-5101	SOCKET, TRANSFORMER; four contacts; yellow brass, silver plated; rectangular shape; 2-9/16 in. lg, 1-3/4 in. wide, 7/8 in. high overall excluding terminals; natural nylon phenolic, type NPG, and aluminum body; screw mounting; two 0.159 in. dia mounting holes on 1.5 in. mounting centers; five tie points; Collins Radio Co. Part No. 596-1531-002; p/o Antenna Coupler CU-168/FRR	Socket for Transformer T-202
Z-201	N17-S-51032-1721	SUPPRESSOR, ELECTRICAL NOISE; capacitor and iron core coil type; four capacitors, 2 mf; two capacitors, 0.005 mf; 3.3 mh iron core coil inductor; 120 v AC, 1.5 amp; No. 26 magnet wire; 3 in. lg, 3 in. wide, 1-3/8 in. high; enclosed in case; rectangular metal; enamel finish; four mounting holes, tapped No. 6-32 by 1/4 in. deep, on 2-1/2 in. mounting centers; four solder lug type terminals, located 2 on each end; Collins Radio Co. Part No. 240-9000-00; p/o Antenna Coupler CU-168/FRR	Power line filter
301 thru 399	F16-P-66910-1001	POWER SUPPLY; electronic type, 5U4/G tube, full wave rectification; 150 v DC, 12.6 v AC, 250 ma DC, 3 amp AC, unregulated output; 105/115/125 v AC, 50 to 60 and 400 cycles single phase, 150 w input; overall dim. 15-3/16 in. lg, 4-3/8 in. wide, 7-3/8 in. high; filter included; six No. 10-32 captive mounting screws on 3-5/32 in. mounting centers; Collins Radio Co. Part No. 596-0724-004; p/o Antenna Coupler CU-168/FRR	
A-301	* _____	CHASSIS; aluminum; 15-3/16 in. lg, 4-3/8 in. wide, 2-1/16 in. deep; six 0.285 - 0.288 in. dia mounting holes w/screw retainers on 3.625 and 7.156 in. mounting centers; Collins Radio Co. Part No. 596-0722-004; p/o Antenna Coupler CU-168/FRR	Power Supply PU-301 chassis
C-301	<u>N16-C-19790-9121</u>	CAPACITOR, FIXED, ELECTROLYTIC; case style No. 13, MBCA ref dwg group 1, one section; 25 mf; 250 v DC; -40°C to +85°C working temp range; JAN Spec No. JAN-C-62, JAN Type No. CE51C250M; CD; general purpose use	Power Supply B+ filter
C-302	<u>N16-C-20366-1221</u>	CAPACITOR, FIXED, ELECTROLYTIC; case style No. 13, MBCA ref dwg group 1; one section; 150 mf; 250 v DC; -40°C to +85°C working temp range; JAN Spec No. JAN-C-62, JAN Type No. CE51C151M; CD; general purpose use	Power Supply B+ filter
E-301	_____	CLAMP, ELECTRICAL; stainless steel; one toggle type latch fastening device; 1-1/4 in. dia, 3/4 in. high; one 0.187 in. dia mounting hole in base of clamp; CAIS Part No. 926A-26; general purpose use	Clamp for Capacitor C-301

*Not furnished as a maintenance part. If failure occurs, do not request replacement unless the item cannot be repaired or fabricated.

TABLE 8-4. TABLE OF REPLACEABLE PARTS (Cont)

REFERENCE DESIGNATION	STOCK NUMBERS SIGNAL CORPS, NAVY, AIR FORCE	NAME AND DESCRIPTION	LOCATING FUNCTIONS
E-302	<u>N16-C-302837-594</u>	CLAMP, ELECTRICAL; stainless steel; one toggle type latch fastening device; 1-1/4 in. dia, 3/4 in. high; one 0.187 in. dia mounting hole in base of clamp; without holding spurs; CAIS Part No. 926c; general purpose use	Calmp for Capacitor C-302
E-303	<u>N16-C-300798-866</u>	CLAMP, ELECTRICAL; stainless steel; one toggle type latch fastening device; 1-1/4 in. dia, 3/4 in. high; one 0.187 in. dia mounting hole in base of clamp; CAIS Part No. 926c; general purpose use	Clamp for rectifier Tube V-301
E-304	<u>*N16-L-498001-143</u>	BUS BAR; brass, rectangular; solid; 3/8 in. wide; 0.020 in. thick, 1-1/2 in. lg; one 0.187 in. dia hole and one 0.187 by 9/32 in. slot on lin. center; Collins Radio Co. Part No. 596-0693-00; p/o Antenna Coupler CU-168/FRR	Bus for Switch S-301
E-305	<u>*</u>	SPACER, STANDOFF; aluminum alloy, hexagon shape; 1/2 in. hex; one tapped hole No. 6-32 NC-2 each end; .500 in. lg overall; Collins Radio Co. Part No. 500-5962-001; p/o Antenna Coupler CU-168/FRR	Mounting for Switch S-301
E-306		Same as E-305	Mounting for Switch S-301
E-307		Same as E-305	Mounting for Switch S-301
E-308		Same as E-305	Mounting for Switch S-301
E-309	<u>*</u>	SPACER, STANDOFF; aluminum alloy, caustic dip; hexagon shape; 1/4 in. hex; one tapped hole No. 6-32 NC-2; 0.937 in. lg overall; Collins Radio Co. Part No. 596-0664-001; p/o Antenna Coupler CU-168/FRR	Mounting for Plug Connector P-301
E-310		Same as E-309	Mounting for Plug Connector P-301
P-301	<u>N17-C-73518-8254</u>	CONNECTOR, PLUG; six flat male contacts; polarized; straight type; not banana or phone type; 2-1/2 in. lg, 1 in. wide; 1/2 in. high; 10 amp, 110 v contacts; not radio frequency connector; rectangular body; molded bakelite; non-locking type; not split shell; two 0.169 in. dia mounting holes on 2-1/16 in. mounting center; withstand 48 hour salt spray test; CMG Part No. P-406-AB; for general purpose use	Connects power supply to main chassis

*Not furnished as a maintenance part. If failure occurs, do not request replacement unless the item cannot be repaired or fabricated.

TABLE 8-4. TABLE OF REPLACEABLE PARTS (Cont)

REFERENCE DESIGNATION	STOCK NUMBERS SIGNAL CORPS, NAVY, AIR FORCE	NAME AND DESCRIPTION	LOCATING FUNCTIONS
R-301	N16-R-66397-3966	RESISTOR, FIXED, WIRE WOUND; body style No. 12, MBCA ref dwg group 2; inductive winding; 10,000 ohms $\pm 5\%$ tolerance; 10 w, 125°C power rating; JAN Spec No. JAN-R-26A, JAN Type No. RW22E103; CAO Part No. 555; for general purpose use	Bleeder resistor
S-301	*N17-B-77637-9135	SWITCH TAP; non-fusible; single pole three position; rectangular shape base; natural nylon phenolic, type NPG; 2-3/4 in. lg, 2-1/32 in. wide, 11/16 in. thick; four solder lug terminals; four 0.159 in. dia mounting holes on 2.375 and 1.656 in. mounting centers; terminals marked power in, 105 v, 115 v, and 125v; Collins Radio Co. Part No. 596-0695-00; p/o Antenna Coupler CU-168/FRR	Power transformer primary tap change link
T-301	N17-T-73633-9893	TRANSFORMER, POWER, STEP-DOWN AND STEP-UP; hermetically sealed steel case; 105/115/125 v AC, 50-60 and 400 cycles, single phase input; three output windings; 5 v No. 1 secondary, 12.6 v No. 2 secondary, 460 v No. 3 secondary; 3 amp No. 1 secondary, 3 amp No. 2 secondary, 0.15 amp No. 3 secondary; primary tapped at 105, 115 and 125 v; Nos. 1, 2 and 3 secondaries center tapped; 1500 v primary voltage insulation, 1500 v No. 1 secondary voltage insulation, 725 v No. 2 secondary voltage insulation, 1500 v No. 3 secondary voltage insulation; synthetic resin impregnated; MBCA ref dwg group 12; 4-1/2 in. lg, 4-1/8 in. wide, 5-5/16 in. high; 13 solder lug type terminals located on bottom; four No. 10-32 mounting studs on 3 in. by 3-3/8 in. mounting centers; internal shielding connected to case; CTR Part No. L6278; p/o Antenna Coupler CU-168/FRR	Power transformer
V-301	N16-T-55464	ELECTRON TUBE; full wave rectifier; glass envelope, type RMA ST-16; five pin type terminations located on bottom; receiving type; JAN Spec No. JAN-1A; JAN Type No. JAN 5U4G; CRC; for general purpose use	Rectifier tube
XC-301	N16-S-63471-2811	SOCKET, ELECTRON TUBE; eight contacts; beryllium copper, silver plated; small size body; no metal shield; no center shield; oval shape; 2-5/16 in. lg, 1-11/16 in. wide, 9/16 in. high overall including terminals; ceramic body; one piece saddle mounting; 1.125 in. dia chassis hole required; two 11/64 in. dia mounting holes on 1-49/64 in. mounting centers; CEJ Part No. 228; for general purpose use	Socket for C-301

*Not furnished as a maintenance part. If failure occurs, do not request replacement unless the item cannot be repaired or fabricated.

TABLE 8-4. TABLE OF REPLACEABLE PARTS (Cont)

REFERENCE DESIGNATION	STOCK NUMBERS SIGNAL CORPS, NAVY, AIR FORCE	NAME AND DESCRIPTION	LOCATING FUNCTIONS
XC-302		Same as XC-301	Socket for C-302
XV-301		Same as XC-301	Socket for V-301
Z-301	<u>N16-R-29775-7777</u>	REACTOR FILTER; filter choke type; two sections; 1-1/2 henries overall inductance No. 1 section, 1/2 henry overall inductance No. 2 section; 300 ma DC No. 1 section, 300 ma DC No. 2 section; 15 ohms DC resistance No. 1 section, 5 ohms DC resistance No. 2 section; 2500 v rms test voltage; hermetically sealed steel case; 4-1/2 in. lg, 4-1/8 in. wide, 5-5/16 in. high overall; four No. 10-32 mounting studs on 3-3/8 in. by 3 in. mounting centers; four solder lug type terminals located on bottom; CTR Part No. 16277	Power supply filter inductors

TABLE 8-5. MAINTENANCE PARTS KIT

ITEM NO.	QUANTITY	PART NAME	REFERENCE SYMBOL	COLLINS PART NO.
A	1	Clamp, Spring	E-202	596-0686-002
B	2	Coil, R-F choke	L-101	240-9004-009
C	2	Coil, R-F choke	L-103	240-9002-009
D	1	Coil, R-F choke	L-201	240-9003-009
E	1	Coil, R-F choke	L-105	240-9001-009
F	1	Transformer	T-101	596-0715-003
G	1	Transformer	T-201	596-0712-003

TABLE 8-6. CROSS REFERENCE PARTS LIST

(The necessary information for this table is not available.)

TABLE 8-7. COLOR CODES AND MISCELLANEOUS DATA

RESISTOR COLOR CODES

RMA COLOR CODE FOR FIXED COMPOSITION RESISTORS

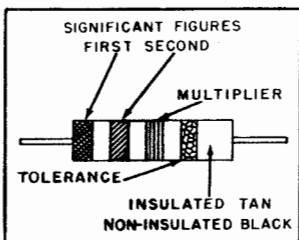

AXIAL TYPE

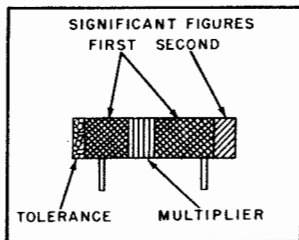

RADIAL TYPE

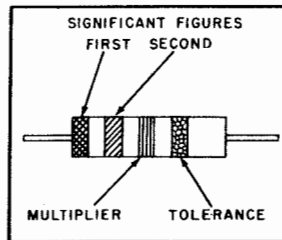

AXIAL TYPE INSULATED

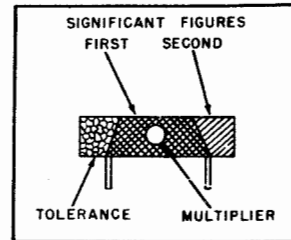

RADIAL TYPE NON-INSULATED

JAN COLOR CODE FOR FIXED COMPOSITION RESISTORS

CAPACITOR COLOR CODES

RMA 3-DOT COLOR CODE FOR MICA-DIELECTRIC CAPACITORS

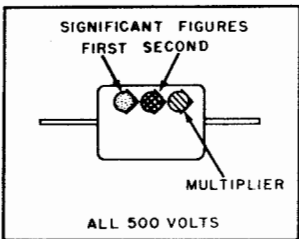

JAN 6-DOT COLOR CODE FOR PAPER DIELECTRIC CAPACITORS

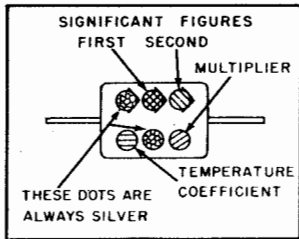

RMA 6-DOT COLOR CODE FOR MICA-DIELECTRIC CAPACITORS

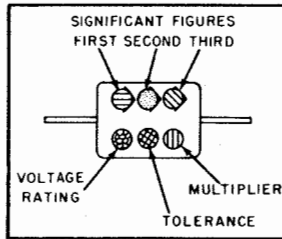

JAN 6-DOT COLOR CODE FOR MICA-DIELECTRIC CAPACITORS

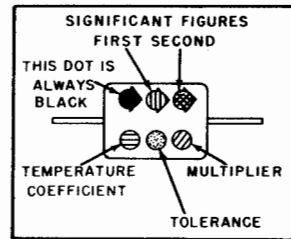

RMA COLOR CODE FOR TUBULAR CERAMIC-DIELECTRIC CAPACITORS

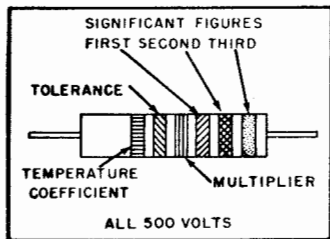

AXIAL TYPE

JAN COLOR CODE FOR TUBULAR CERAMIC CAPACITORS

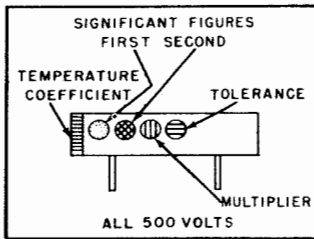

AXIAL TYPE INSULATED

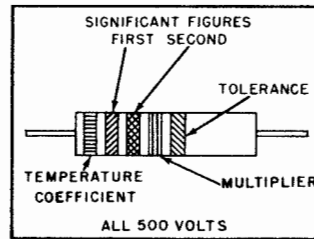

RADIAL TYPE NON-INSULATED

COLOR	SIGNIFICANT FIGURE	MULTIPLIER	PERCENT TOLERANCE	VOLTAGE RATING	TEMPERATURE COEFFICIENT
BLACK	0	1			A
BROWN	1	10		100	B
RED	2	100		200	C
ORANGE	3	1,000		300	D
YELLOW	4	10,000		400	E
GREEN	5	100,000		500	F
BLUE	6	1,000,000		600	G
VIOLET	7			700	
GRAY	8	0.1*		800	
WHITE	9	0.01*		900	
GOLD	0.1	0.1	5	1000	
SILVER	0.01	0.01	10	2000	
NO COLOR			20	500	

* JAN TUBULAR CERAMIC CAPACITORS ONLY

NOTE: JAN, JOINT ARMY-NAVY; RMA, RADIO MANUFACTURERS ASSOCIATION

TABLE 8-8. LIST OF MANUFACTURERS

PRE FIX	NAME	ADDRESS
CBZ	Allen Bradley Co.	Milwaukee, Wis.
CPH	American Phenolic Corp.	Chicago, Ill.
CHN	Arrow-Hart and Hegeman Electric Co.	Hartford, Conn.
CAIS	Birtcher Corp.	Los Angeles, Calif.
CFA	Bussman Mfg. Co.	St. Louis, Mo.
CBN	Centralab Div., Globe Union, Inc.	Milwaukee, Wis.
CTR	Chicago Transformer Div., Essex Wire Corp.	Chicago, Ill.
CMG	Cinch Mfg. Corp.	Chicago, Ill.
CD	Cornell Dubilier Electric Corp.	South Plainfield, N.J.
CAYS	Drake Mfg. Co.	Chicago, Ill.
CASU	Electrical Reactance Corp.	Franklinville, N.Y.
CG	General Electric Co.	Schenectady, N.Y.
CEJ	Johnson, E.F., Co.	Waseca, Minn.
CNA	National Co., Inc.	Malden, Mass.
CRC	Radio Corp. of America	Harrison, N.J.
CAO	Ward Leonard Electric Co.	Mt. Vernon, N.Y.

INDEX

SUBJECT	FIGURE OR TABLE	SECTION	PARAGRAPH
A			
Adjustments - initial	3-5	3	3
Antenna connection	1-1	3	
Antenna - coupler and accessories		1	
C			
Capabilities and limitations		4	1
Circuit analysis		2	3
transformer		2	3a
artificial transmission line		2	3b
termination		2	3c
r-f amplifiers		2	3d
power supply		2	3e
Circuitry - general		2	2
Connection to system		3	6
Contents - table of		Front matter	(page i)
D			
Description of units - general		1	2a, 2b, 2c
Destruction notice		Front matter	(page iv)
Diagram block -			
antenna coupler	2-1	2	
Diagram - dimensional outline	3-1	3	
Diagram - schematic	7-8	7	
E			
Electron tube complement	1-4	1	
Equipment required but not supplied	1-2	1	
Equipment supplied	1-1	1	
F			
Fabrication instructions	3-2	3	
Failure - report of		Front matter	(page iv)
Failure reports	7-1	7	
G			
General - (theory of operation)		2	1
Guarantee		Front matter	(page iii)
I			
Installation - equipment		3	2
Installation record		Front matter	(page iii)
L			
Limitations - capabilities and		4	1
Localization - theory of		7	1
Lubrication		6	2
M			
Main chassis - front internal view	7-4	7	
Main chassis - rear view	7-3	7	
Measuring gain - method of	7-2	7	

SUBJECT	FIGURE OR TABLE	SECTION	PARAGRAPH
O			
Operation	4	2
P			
Panel - antenna coupler, front view	4-1	4	
Parts list	8	
replaceable - table of	8-4	8	
Parts - ordering	Front matter	(page iv)
Power connection	3	4
Power supply - front interior view	7-7	7	
Purpose and principles - general	1	1
R			
R-F amplifier -			
bottom oblique interior view	7-5	7	
top interior view	7-6	7	
R-F distribution system - typical	3-3	3	
Reference data.	1	3
nomenclature	1	3a
contract numbers	1	3b
contractor	1	3c
cognizant Naval Inspector	1	3d
number of packages	1	3e
cubical contents	1	3f
total weight	1	3g
frequency	1	3h
power requirements	1	3i
input impedance	1	3j
output impedance	1	3k
number of outputs	1	3l
Resuscitation notice	Front matter	(page v)
Routine check chart	5-1	5	
Routine check chart	5	1
emergency maintenance	5	2
replacement of tubes and fuses	5	2(a)
Routine maintenance check chart	6-1	6	
Routine maintenance check chart	6	1
lubrication	6	2
S			
Schematic diagram	7-8	7	
Shipping data	1-3	1	
Shipping weights and dimensions of spare parts boxes	8-2	8	
Spare parts boxes - weights and dimensions	8-1	8	
Subassemblies - list of	8-3	8	
T			
Terminal resistance chart	7-3	7	
Terminal voltage chart	7-2	7	
Termination	3	7
single antenna coupler	3	7a
tandem antenna coupler	3	7b
Trouble shooting chart	7-1	7	
Trouble shooting and repair - unit	7	3
precautions	7	3a
trouble shooting	7	3b
repair	7	3c
mechanical adjustments	7	3c(2)

SUBJECT	FIGURE OR TABLE	SECTION	PARAGRAPH
Trouble shooting and repair - unit (Continued)			
component characteristics	7	3c(3)
electron tubes	7	3c(3)(a)
winding data	7	3c(3)(b)
Trouble shooting - system	7	2
locating faulty unit	7	2a
Tube characteristics	7-5	7	
Tube operating voltages and currents	7-4	7	
U			
Unpacking	3	1
W			
Weights and dimensions - spare parts boxes . .	8-1	8	
Winding data	7-6	7	