

NAVSHIPS 93127

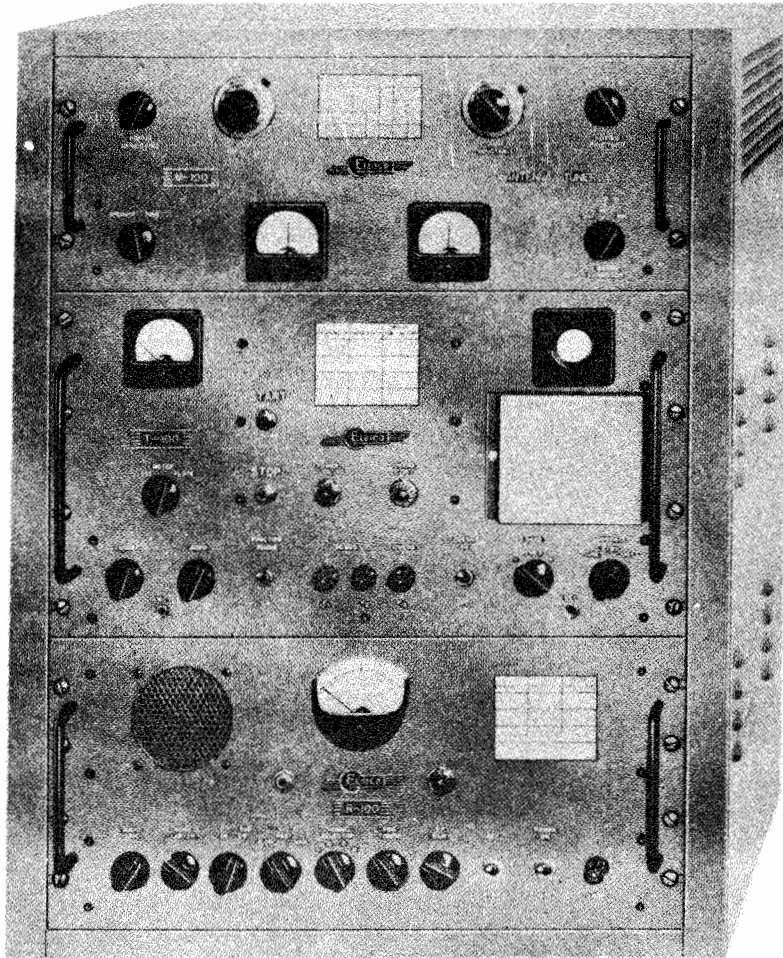

# *S-100*

## *Communications System*

### NOTICE

IT IS STRONGLY RECOMMENDED THAT THIS INSTRUCTION MANUAL BE READ THOROUGHLY BEFORE ANY ATTEMPT IS MADE TO PUT THE UNIT INTO OPERATION. FAILURE TO COMPLY WITH THIS NOTICE MAY RESULT IN SERIOUS DAMAGE TO THE EQUIPMENT.

# TABLE OF CONTENTS

## S-100 Communications System

### SECTION I - DESCRIPTION

1.1	Introduction . . . . .	1
1.2	Description . . . . .	1
1.3	Unpacking and Installation . . . . .	2
1.4	Operation of S-100 System . . . . .	3
1.5	SSB Operation . . . . .	4
1.6	Operation on AM . . . . .	5
1.7	Operation on CW . . . . .	6
1.8	Remote Operation . . . . .	7
1.9	Changing Channels . . . . .	7
1.10	Shutting Down . . . . .	7

## R-100 Receiver

### SECTION I - DESCRIPTION

1.1	Introduction . . . . .	1
1.2	Features . . . . .	1
1.3	Specifications . . . . .	1

### SECTION II - INSTALLATION

2.1	Location and Mounting . . . . .	3
2.2	External Connections . . . . .	3

### SECTION III - OPERATION

3.1	Controls . . . . .	5
3.2	Operating Procedure . . . . .	6

### SECTION IV - THEORY OF OPERATION

4.1	General . . . . .	7
4.2	RF Amplifier, V-1 . . . . .	7
4.3	First Mixer, V-2 . . . . .	7
4.4	First Oscillator, V-7 . . . . .	7
4.5	Second Mixer Oscillator, V-3 . . . . .	7
4.6	Crystal Filter, XF1-A . . . . .	8
4.7	Second IF Amplifier, V-4 and V-5 . . . . .	8

SECTION IV (Continued)

4.8	Noise Limiter, V-6 . . . . .	8
4.9	AM Detector, V-9 . . . . .	8
4.10	SSB/CW Detector, V-10 . . . . .	8
4.11	413 Kc Oscillator, V-8a . . . . .	8
4.12	Audio Preamplifier, V-11 . . . . .	9
4.13	Audio Output, V-12 . . . . .	9
4.14	AVC IF Amplifier, V-13 . . . . .	9
4.15	AVC Detector, V-14 . . . . .	9
4.16	Bias Rectifier, V-15 . . . . .	9
4.17	Rectifier and Power Supply, V-16 . . . . .	0

SECTION V - MAINTENANCE

5.1	Service Adjustments . . . . .	11
5.2	Trouble Shooting . . . . .	13
5.3	Alignment Procedure . . . . .	17
	PARTS LIST . . . . .	18
	RESISTANCE CHARTS . . . . .	26
	VOLTAGE CHARTS . . . . .	28
	GRID PARTS LOCATION . . . . .	30

**T-100 Transmitter**

SECTION I - DESCRIPTION

1.1	Introduction . . . . .	1
1.2	Features . . . . .	1
1.3	Specifications . . . . .	2

SECTION II - INSTALLATION

2.1	Unpacking . . . . .	5
2.2	Location and Mounting . . . . .	5
2.3	External Connections . . . . .	5

SECTION III - OPERATION

3.1	Controls . . . . .	7
3.2	Initial Adjustments . . . . .	8
3.3	CW Operation . . . . .	8
3.4	AM Operation . . . . .	8
3.5	SSB Operation . . . . .	9

SECTION IV - THEORY OF OPERATION

4.1	General . . . . .	11
4.2	Driver and Power Amplifier . . . . .	12
4.3	CW and AM Signals . . . . .	12
4.4	Oscilloscope . . . . .	13
4.5	Power Supply . . . . .	13
4.6	Control Circuits . . . . .	13
	M-102 . . . . .	14

SECTION V - MAINTENANCE

5.1	Service Adjustments . . . . .	15
5.2	Recommended Equipment for Making Adjustments	15
5.3	Procedure . . . . .	15
5.4	Miscellaneous Adjustments . . . . .	17
5.5	Removal of V-13, Final Amplifier . . . . .	18
	TRUBLE SHOOTING CHART . . . . .	19
	PARTS LOCATION . . . . .	21
	VOLTAGE CHARTS . . . . .	32
	RESISTANCE CHARTS . . . . .	34
	PARTS LIST . . . . .	37

**M-100 Antenna Tuner**

SECTION I - DESCRIPTION

1.1	Introduction . . . . .	1
1.2	Features . . . . .	1
1.3	Specifications . . . . .	1

SECTION II - INSTALLATION

2.1	Location and Mounting . . . . .	3
2.2	External Connections . . . . .	3

SECTION III - OPERATION

3.1	Controls . . . . .	5
3.2	Preliminary Adjustments . . . . .	5
3.3	Operation Procedure . . . . .	7

SECTION IV - THEORY OF OPERATION

4.1	General . . . . .	9
4.2	Impedance Detector . . . . .	9
4.3	Phase Detector . . . . .	9
4.4	Matching Network . . . . .	10

SECTION V - MAINTENANCE

5.1	General . . . . .	13
5.2	Checking Phase and Impedance Meters . . . . .	13
5.3	Lubrication . . . . .	14
	PARTS LIST . . . . .	15

**LIST OF ILLUSTRATIONS**

**S-100 Communications System**

Frontispiece - S-100 Communications System	
SSB Oscilloscope Patterns . . . . .	4
AM Oscilloscope Patterns . . . . .	5
Interchassis Cable Connections and Remote Control Hookup . . . . .	9
S-100 System, Cabling Diagram . . . . .	11

**R-100 Receiver**

Frontispiece - R-100 Receiver	
R-100 Bottom View . . . . .	31
R-100 Top View . . . . .	34
R-100 Schematic Diagram . . . . .	35

**T-100 Transmitter**

Frontispiece - T-100 Transmitter	
Oscilloscope Patterns . . . . .	9
M-102, Schematic Diagram . . . . .	14
M-102, Rear View . . . . .	14a
M-102, Front View . . . . .	14b
T-100, Exciter Section, Bottom View . . . . .	22
T-100, Exciter Section, Top View . . . . .	23

T-100 TRANSMITTER (continued)

T-100 Transmitter, Top View . . . . .	25
Oscilloscope Chassis, Rear View . . . . .	27
Power Supply Chassis, Bottom View . . . . .	31
T-100 Schematic Diagram . . . . .	45

**M-100 Antenna Tuner**

Frontispiece - M-100 Antenna Tuner	
Tuning Diagrams, No. 1 and No. 2 . . . . .	12
M-100 Top View . . . . .	17
M-100 Bottom View . . . . .	18
M-100 Schematic Diagram . . . . .	19

## SECTION I

### DESCRIPTION

#### 1.1 INTRODUCTION

The Eldico S-100 Single Sideband Transmitter/Receiver system consists of four individual units. These are the M-100 Antenna Tuner, the T-100 Transmitter, the R-100 Receiver and the M-102 microphone bias supply. The four units which comprise the S-100 system are supplied as an integral unit in a steel rack cabinet. Provision is made for easy servicing, as all major units can be rolled out on slides.

Remote control features have been incorporated so that the complete system can be operated from one or more distant locations. Operating in either single sideband, amplitude modulation or continuous wave, the S-100 system is compatible with any and all existing communications equipment. Frequency coverage of the system is from 2.2 to 30.0 megacycles in four pre-selected channels. Any oscillators which contribute to the frequency stability in both the receiver and transmitter are crystal controlled. The more critical oscillators are equipped with oven controlled crystals, with variable padder capacitors for exact frequency adjustment. The receiver has a front panel control which will permit the operator to compensate for slight frequency variations in other transmitters. Power output is in the order of 100 watts when operating single sideband, which is equivalent to approximately 400 watts in amplitude modulated systems. Continuous wave output is 50 watts, and amplitude modulation output is 20 watts. These ratings are conservative. The M-100 Antenna Tuner is designed to operate into a wide variety of loads over the complete frequency range. It incorporates phase and impedance indicators to aid in adjustment. Also included is the M-102 microphone bias supply which will supply 12 volts DC for excitation of a carbon microphone. It is designed to supply 700 Ma continuous duty.

#### 1.2 DESCRIPTION

First, Amplitude Modulated signals consist of three parts. These are the lower sideband, a carrier of constant amplitude, and an upper sideband. When a carrier is "modulated", heterodyning takes place, beating the audio signal against the carrier, resulting in the signal described previously. Obviously, transmission can be accomplished by transmitting only one sideband, since both sidebands contain exactly the same information. Therefore, one of these sidebands can be removed without impairing any information. The carrier, being of constant amplitude and containing a great deal of power, serves no purpose in the actual transmission of the modulated signal. The carrier, therefore, can be removed at the transmitter. This results in an amplitude modulated signal with both carrier and one sideband removed. What remains is called single sideband suppressed carrier, or more simply, SSB.

At the receiver, the loss of the carrier leads to a slight difficulty, as conventional AM detectors cannot be used. Therefore, to satisfy the detector requirements, the

receiver must supply a synthetic carrier. This carrier must have the proper frequency relationship with the incoming SSB signal. If it does not, the speech will become distorted. Assuming that the locally generated "carrier" and the incoming SSB signal are correctly arranged, the detected output is identical with the original signal, which is then amplified and applied to the speaker or phones in the normal manner.

### 1.3 UNPACKING & INSTALLATION

- A. Open packing cartons carefully to avoid damage to the equipment. Examine the packing material carefully for any small packages. Examine equipment for possible signs of damage and try all controls for bent shafts and broken couplings. Report any damage to the proper authorities. Original packing material should be preserved. See that all tubes and crystals are properly seated in their sockets.

**CAUTION: DO NOT, UNDER ANY CONDITIONS, REMOVE THE CRYSTALS FROM THE CRYSTAL FILTER UNITS. DO NOT ATTEMPT ANY ADJUSTMENT OF THESE UNITS. THE ADJUSTMENT AND SELECTION OF CRYSTALS IS EXTREMELY CRITICAL AND IS FACTORY SET FOR OPTIMUM PERFORMANCE. VIOLATION OF THIS CAUTION WILL RESULT IN SERIOUS DEGRADING OF PERFORMANCE.**

The equipment should be set in a cool, dry area convenient to the operator. Allow for the free passage of cool air around all vent slots.

- B. Connect 110-117 volts, 60 cps, single phase AC to terminals 5 and 6 on TB-3 located on microphone bias supply, M-102. Access to all terminal boards may be had by removing rear panel from rack cabinet. The microphone bias supply is fastened to the bottom of the cabinet.

- C. Connect the antenna lead to the output fitting on the M-100 unit.

- D. For Remote Operation:

Terminals 1, 2, 3 and 4 on TB-3 are for connection to Navy Type Radio Set Control C-1138/UR or equivalent. In the event that such equipment is not available, connections are as follows:

Terminals 1 and 2: START (momentary short button).

Terminals 3 and 4: STOP (momentary short button).

Terminals 1 and 4: 117 volt pilot lamp for remote "POWER ON" indication.

**NOTE: UNIT WILL BE INOPERATIVE UNLESS "OVEN" SWITCH IS "ON" AND YELLOW LAMP ON T-100 PANEL INDICATES.**

Terminals 7 and 8: Remote 600 ohm line input, requires "0" dbm for full modulation.



Terminal 9: Remote "TRANSMIT" connection. This terminal is returned to ground through the remote push-to-talk switch (connect to terminal 11 on C-1138/UR).

Terminals 10 and 11: 12 volts DC supply for carbon microphone. Terminal 10 is negative; Terminal 11 is positive which is normally supplied grounded.

Terminals 12 and 13: 600 ohm output for remote speaker or head set. To disable speaker on R-100 unit, plug headphones into jack on front panel. Leave audio gain at normal level.

**E. Internal Interchassis Cable Connections: (See Figure 1)**

The S-100 system is supplied complete with a cable harness connected to all proper terminals.

**F. Physical Description of Rack Cabinet:**

Height:	28 inches
Width:	21-3/4 inches
Depth:	19 inches
Weight:	175 pounds
Finish:	Eldico Gray

**1.4 OPERATION OF S-100 SYSTEM**

(Tune-up procedure for each individual unit should be followed. These are found in the section of this manual concerned with that particular unit.)

The S-100 system is supplied with controls set to four pre-selected channels as noted on the frequency charts appearing on the front panels on the R-100 and T-100. Refer to the M-100 section of this manual for the preliminary tune-up procedure. When the M-100 is first tuned up, the control settings of the M-100 should be noted on the front panel logging chart of that unit.

**A. START:**

- (1) THE FOLLOWING SWITCHES SHOULD BE IN THE INDICATED POSITIONS AND LEFT "ON" AS LONG AS ANY OPERATION IS CONTEMPLATED.

T-100

OVENS SWITCH "ON" (YELLOW PILOT LIGHT ON). IF OVEN SWITCH IS "OFF", ALLOW AT LEAST 10 MINUTES FOR OVENS TO STABILIZE.

R-100

POWER SWITCH "ON" (RED PILOT LIGHT ON).

REC/STBY SWITCH TO STBY POSITION. (AS LONG AS RED PILOT LIGHT IS ON AND REC/STBY SWITCH IS IN STBY POSITION, THE RECEIVER IS OPERATIVE AND WILL REMAIN SO UNTIL THE TRANSMITTER IS ON THE AIR. THIS ALLOWS CONTINUOUS MONITORING OF THE PRE-SELECTED CHANNEL. )

(2) TO ENERGISE THE TRANSMITTER, PRESS START BUTTON. ALLOW AT LEAST ONE MINUTE FOR TUBES TO HEAT.

B. TUNE-OPERATE SWITCH ON M-100 MUST BE IN OPERATE POSITION IN ORDER TO TRANSMIT OR RECEIVE.

**1.5 SSB OPERATION**

- A. Select desired channel and set bandswitch on T-100, R-100 and controls of M-100 to corresponding settings.
- B. Rotate CARRIER control on T-100 fully counterclockwise.
- C. Switch FUNCTION switch on T-100 to PHONE position.
- D. Switch OPERATE switch on T-100 to XMIT position.
- E. Press microphone button, speak closely into microphone and advance AUDIO control on T-100 until proper oscilloscope pattern appears as indicated.



SSB pattern  
excessive bias on  
5894 stage.

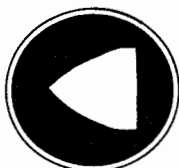

improper SSB pattern  
reduce drive  
change loading.

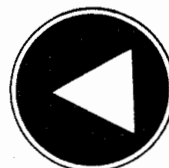

SSB pattern  
correct adjustment

- F. Advance RF GAIN control on R-100 fully clockwise.
- G. Place AM-SSB/CW switch on R-100 in SSB/CW position.
- H. Set AVC switch on R-100 to SLOW position.
- I. Adjust AUDIO GAIN control on R-100 until a suitable level is reached.
- J. Adjust FINE TUNING control on R-100 while an incoming signal is present for most pleasing quality.

- K. NOISE LIMITER control on R-100 should be fully counterclockwise unless excessive noise is present, in which case adjust for best readability (only while signals are being received).

Under some receiving conditions it may be advisable to switch AVC switch on R-100 to MAN position, turn AUDIO GAIN control fully clockwise and adjust RF GAIN for comfortable level. This position should be used ONLY under actual communications conditions, and should not be left in MAN position once communications have ceased. If left in this position, weak signals will not be heard at all. This method should be considered only if a long series of transmissions are contemplated with incoming signals of equal strength or full familiarization of the equipment has been attained.

- L. If set up as indicated in Sections A to J, continued operation on the selected channel can be accomplished merely by pressing push-to-talk button on microphone or handset.
- M. When OPERATE switch on T-100 is in STBY position, push-to-talk is disabled, transmitter heaters are on and the transmitter is available for instant use with no required warm-up period once the switch has been returned to the XMIT position. Normally, between communication periods, this switch is left in the STBY position.

## 1.6 OPERATION ON AM

### A. T-100

- (1) Select desired channel and set BAND SWITCH on T-100, R-100 and M-100 to proper settings.
- (2) Set FUNCTION switch to PHONE.
- (3) Set OPERATE switch to XMIT.
- (4) Turn CARRIER control for plate current reading of 125 Ma.
- (5) Press push-to-talk switch on microphone and advance AUDIO GAIN control until proper oscilloscope patterns appear as indicated:

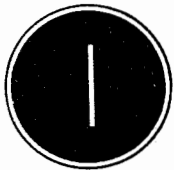

Unmodulated carrier  
or single tone.

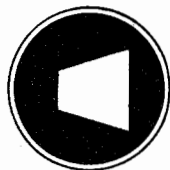

AM pattern,  
60% modulation.

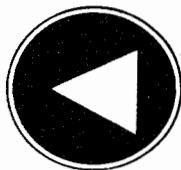

AM pattern  
100% modulation

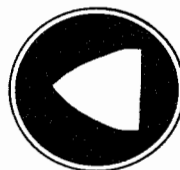

improper  
AM pattern  
reduce drive  
change loading.



AM pattern  
excessive bias on  
5894 stage.

#### B. R-100

- (1) Advance RF GAIN control on R-100 fully clockwise.
- (2) Place AM-SSB/CW switch in AM position.
- (3) Set AVC switch to SLOW.
- (4) Adjust AUDIO GAIN control on R-100 until a suitable level is reached.
- (5) Adjust FINE TUNING control on R-100 while a signal is coming in for the most pleasing quality.
- (6) NOISE LIMITER control on R-100 should be fully counterclockwise unless excessive noise is present, in which case adjust for best readability while signals are being received.

Under some receiving conditions, it may be advisable to switch AVC switch on R-100 to MAN position, turn AUDIO GAIN control fully clockwise and adjust RF GAIN for comfortable level. This position should be used only under actual communications conditions and should not be left in MAN position once communications have ceased. If left in this position, weak signals will not be heard at all. This method should be considered only if a long series of transmissions are contemplated with incoming signals of equal strength or full familiarization with the equipment has been attained.

### I.7 OPERATION ON CW

#### A. T-100

- (1) Proceed as in Step 1.5 (Single Sideband Operation).
- (2) Set FUNCTION switch to CW.
- (3) Switch OPERATE switch to XMIT position.
- (4) Insert key and remove microphone.

#### B. R-100

- (1) Advance RF GAIN control on R-100 fully clockwise.
- (2) Place AM-SSB/CW switch on R-100 in SSB/CW position.
- (3) Set AVC switch to SLOW.
- (4) Adjust AUDIO GAIN control on R-100 until a suitable level is reached.
- (5) Adjust FINE TUNING control on R-100 while an incoming signal is present for the most pleasing quality.
- (6) NOISE LIMITER control on R-100 should be set fully counterclockwise unless excessive noise is present, in which case adjust for best readability while signals are being received.

Under some receiving conditions, it may be advisable to switch AVC switch on R-100 to MAN position, turn AUDIO GAIN control

fully clockwise and adjust RF GAIN for comfortable level. This position should be used only under actual communications conditions and should not be left in MAN position once communications have ceased. If left in this position, weak signals will not be heard at all. This method should be considered only if a long series of transmissions are contemplated with incoming signals of equal strength or full familiarization with the equipment has been attained.

NOTE: IN ORDER TO RECEIVE, IT WILL BE NECESSARY TO RETURN "OPERATE" SWITCH TO "STBY" POSITION.

## 1.8 REMOTE OPERATION (AM AND SSB ONLY)

Procedures 1.4 through 1.7 must be followed. OPERATE switch on T-100 must be in XMIT position. Unit must operate by pressing and releasing of microphone push-to-talk switch only. Allow for warm-up time if remote START-STOP buttons are used.

## 1.9 CHANGING CHANNELS

### A. M-100

- (1) Set M-100 controls (A, B, C, D and E) as indicated on logging chart on front panel.
- (2) Be sure TUNE-OPERATE switch is in OPERATE position or equipment will NOT function.

### B. T-100

- (1) Set BAND SWITCH to desired channel.

### C. R-100

- (1) Set BAND SELECTOR to corresponding band on T-100.

## 1.10 SHUTTING DOWN

- A. Press STOP button.
- B. Operate OVENS switch to OFF position.

### ALTERNATE:

- A. Press STOP button.
- B. Throw POWER switch on R-100 to "OFF". This method allows the ovens to remain heated, but disconnects all other power.

CONNECTIONS FOR RADIO SET CONTROL C-1138/UR

TB3 C-1138/UR

TB3	CONNECT TO
1	1
2	2
3	3
4	4
7	10
8	9
9	11
10	7
11	8
12	14
13	13

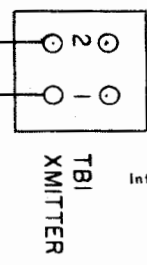
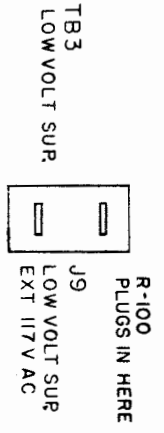
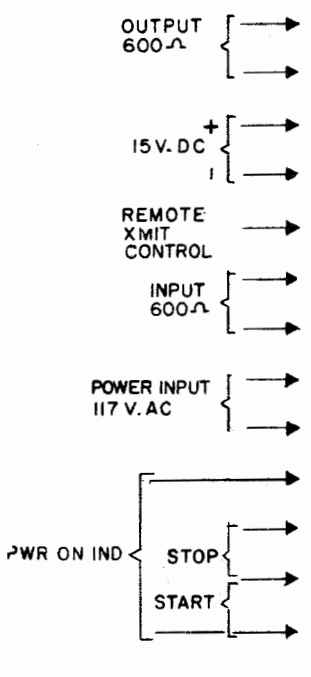
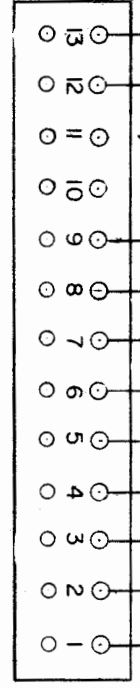
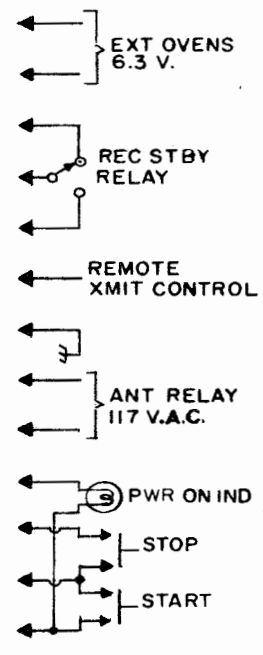
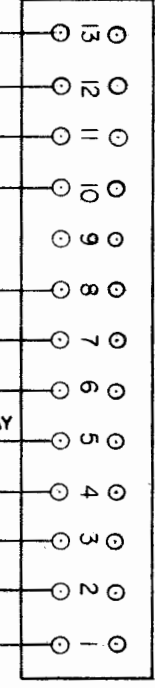
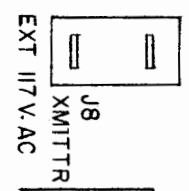
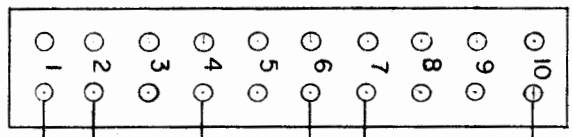
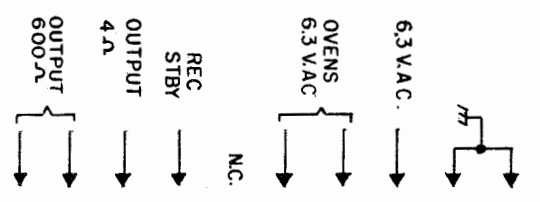

Interchassis Cable Connections & Remote Control Hookup

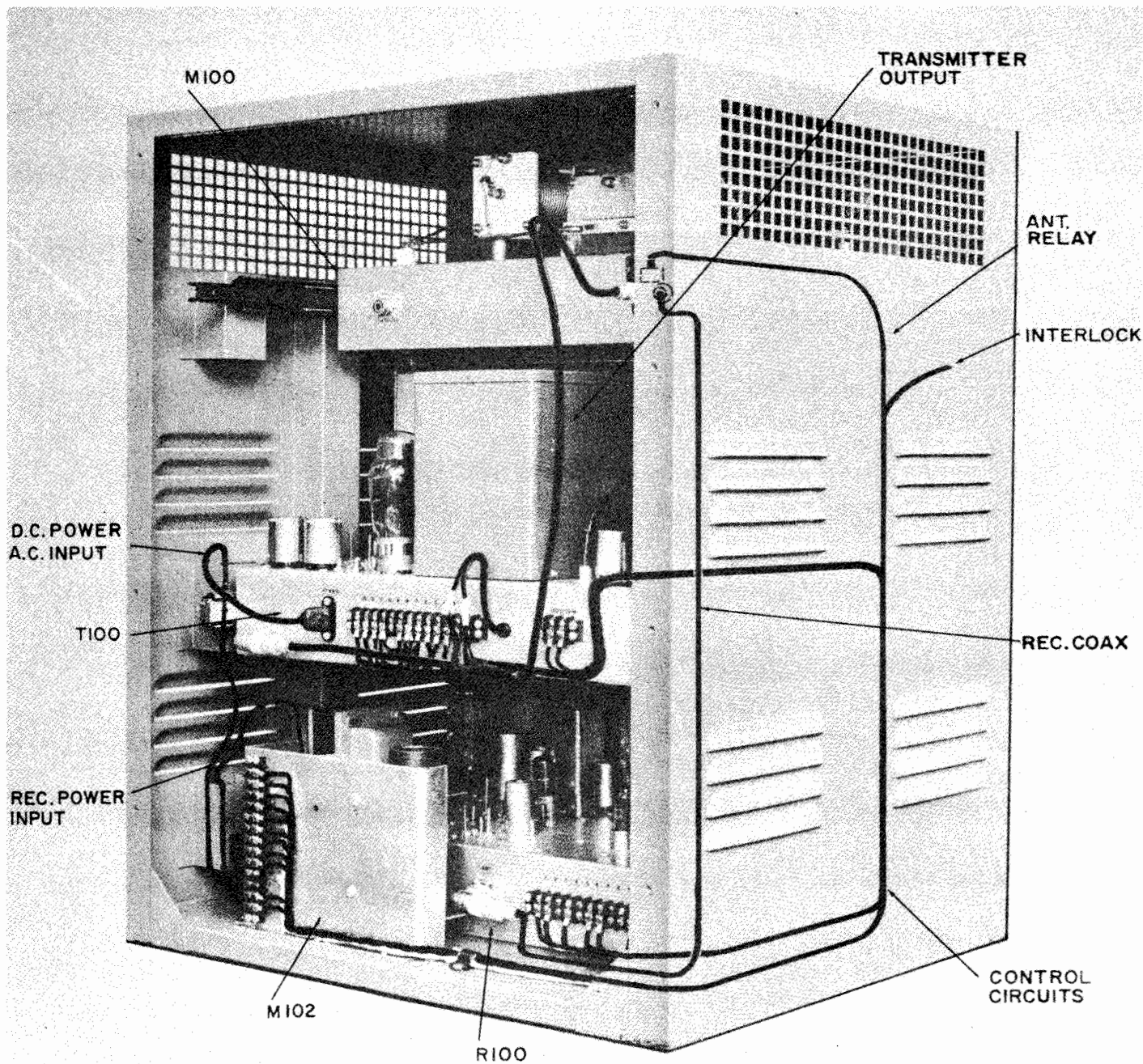

S-100 COMMUNICATIONS SYSTEM CABLING DIAGRAM

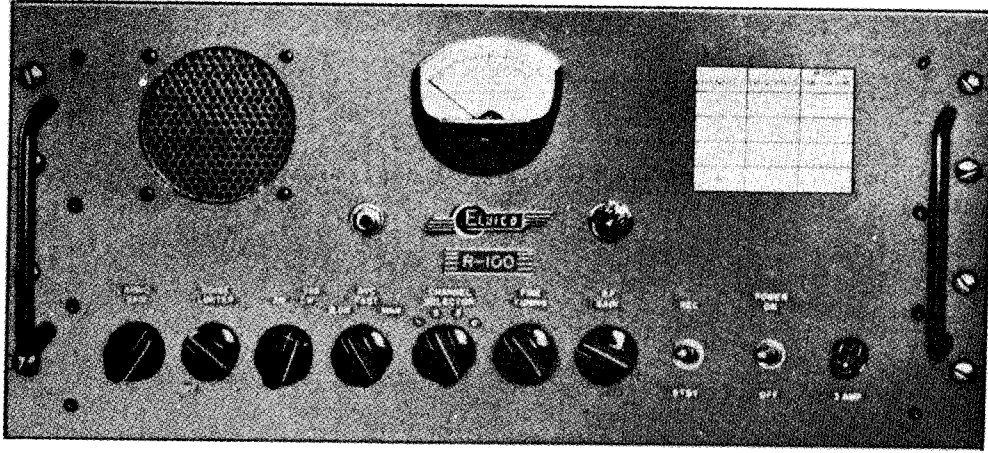

***R-100***  
***Receiver***



# SECTION I

## DESCRIPTION

### I.1 INTRODUCTION

The Eldico R-100 Receiver is a double conversion, four channel superheterodyne circuit, incorporating a narrow band pass crystal lattice filter. The R-100 is designed to cover the frequency range of 2.2 to 30.0 megacycles in four preselected, crystal controlled channels.

### I.2 FEATURES

- A. Double conversion assures image rejection and high skirt selectivity.
- B. A dual section crystal filter provides steep skirts and an essentially flat pass-band of approximately three kilocycles. The rejection outside the pass-band of the filter is at least fifty decibels, assuring high attenuation of adjacent channel signals.
- C. The IF noise limiter allows operation under noisy conditions. This type of limiter, operating in the IF strip has been found to be superior to noise limiters which operate in the audio channel. Both peaks are limited symmetrically.
- D. Two separate detectors are used. A diode detector is employed in the reception of Amplitude Modulation signals, and a mixer-type detector is used for Single Sideband and Continuous Wave reception.
- E. Separate stages are used for Automatic Gain Control, IF, Detector and Amplifier.
- F. Oven controlled crystals are used in high frequency oscillators.

### I.3 SPECIFICATIONS

- A. Operating Range: 2.2 to 30.0 megacycles.
- B. Channels: 4 channels, crystal controlled, 2.2 to 30.0 megacycles.
- C. Sensitivity: 5 microvolts for 10 db signal-to-noise ratio at 1 watt audio output.
- D. Stability: Oven controlled crystal high frequency oscillator.
- E. Selectivity: 2.9 Kc at 6 db down; 7.0 Kc at 50 db down.

F. Image Rejection:	Greater than 50 db.
G. AVC	Less than 2.5 db increase in audio output for 50 db signal increase.
H. AVC Time Constants:	Fast: .005 second rise, .03 second decay Slow: .005 second rise, .5 second decay.
I. Noise Limiter:	IF noise limiter, adjustable threshold, automatic signal reference on AM and SSB/CW.
J. Audio Output:	2 watts at 1000 cycles with less than 10 per cent distortion.
K. Output Impedance:	4 ohms unbalanced, 600 ohms balanced.
L. RF Input Impedance:	52 ohms, nominal.
M. Power Input:	117 volts AC, 60 cycles, single phase, 85 watts.
N. Dimensions:	8-3/4 inches high, 19 inches wide, 15 inches deep. Weight - 20 pounds.
O. Finish:	Eldico Gray.

## SECTION II

### INSTALLATION

#### 2.1 LOCATION AND MOUNTING

While this unit was designed for rack cabinet installation and does not generate very much heat, it is advised that provision for adequate circulation of air be included in any installation. Select a location that is cool and dry to assure maximum life of all components.

#### 2.2 EXTERNAL CONNECTIONS

- A. AC line cord: May be plugged into any source of switched AC (for remote operation) or into any 110 volt, 60 cycle source.
- B. Phone Jack: May be used with low impedance earphones. Inserting the earphone plug into this jack will automatically disconnect the loudspeaker.
- C. Terminals 1 and 2: These terminals provide 600 ohm audio output for remote locations.
- D. Terminals 3 and 10: (Terminal 10 is grounded.) Provide 4 ohm audio output for remote locations.
- E. Terminal 4: Used for remote receive/standby switching. To put into operation, connect a wire from Terminal 4 to switch that will connect this lead to ground, putting the receiver in a receive condition.

NOTE: THIS TERMINAL WILL NOT FUNCTION IF RECEIVER "STANDBY/RECEIVE" SWITCH ON FRONT PANEL IS IN "RECEIVE" POSITION.

- F. Terminals 6 and 7: These terminals are provided for use of an external source of 6.3 volts, 60 cycles AC voltage to provide current to heat the oven.
- G. Terminals 8 and 9: Provide 6.3 volts AC output. (This may be used to heat the ovens instead of external source as described in Paragraph F. preceding.)
- H. Terminal 10: Chassis ground connection.
- I. Terminal 5: Spare connection.
- J. Antenna: Connect to antenna or to antenna tuner through changeover relay and/or antenna tuner M-100.

## SECTION III

### OPERATION

#### 3.1 CONTROLS

A. Power Switch: Turns on AC power to unit.

NOTE: IF AC IS TO BE SWITCHED REMOTELY, THIS SWITCH MUST BE IN THE "ON" POSITION AT ALL TIMES.

B. Receive/Standby Switch: Turns receiver on and off without permitting components to cool.

NOTE: IF UNIT IS TO BE SWITCHED REMOTELY, THIS SWITCH MUST BE IN "STANDBY" AT ALL TIMES.

C. Channel Selector Switch: Sets receiver to desired frequency as noted on frequency chart.

D. Fine Tuning: Used for making slight frequency adjustments.

E. RF Gain Control: This control determines the RF amplifier gain of the receiver.

F. Audio Gain Control: Set to level for comfortable listening. If receiver AVC switch is in MAN position, AUDIO GAIN control should be rotated fully clockwise.

G. AVC Switch: This three position switch can select slow AVC, fast AVC and manual gain control. Set this control to fast to receive AM only. The slow position is used for the reception of SSB and CW. The AVC, under these conditions, will not follow rapid excursions in signal level. Use the MAN position when signals are coming in with consistent strength and the RF GAIN control is adjusted to a suitable level with the AUDIO GAIN fully clockwise. (This will tend to eliminate receiver noise when no signals are present.)

NOTE: IF A WEAK SIGNAL IS PRESENT UNDER THE ABOVE STATED CONDITIONS, IT WILL NOT BE HEARD.

H. AM-SSB/CW Switch: Switches in the proper detector and oscillator for the mode of operation being employed.

I. Noise Limiter: Controls the level at which the limiter will operate. This level decreases as the control is advanced in a clockwise direction. This limiter is especially effective in subduing pulse-type noise. In the extreme counterclockwise position, the noise limiter is switched out of the circuit.

NOTE: IF ROTATED TOO FAR IN THE CLOCKWISE DIRECTION, SOME AUDIO DISTORTION MAY RESULT.

J. S-Meter: Provides a relative indication of signal strength.

### 3.2 OPERATING PROCEDURE

#### A. Operating the Receiver on Single Sideband.

- (1) Turn on receiver using either POWER switch or remote control.
- (2) Set receiver to desired channel, using CHANNEL SELECTOR switch.
- (3) Set AM-SSB/CW switch to SSB/CW position.
- (4) Put AVC switch in SLOW position.
- (5) Turn RF GAIN control fully clockwise.
- (6) Adjust AUDIO GAIN control to a suitable level.
- (7) When receiving a signal, adjust FINE TUNING control. Adjust this control for natural speech.
- (8) If noise is present, turn NOISE LIMITER control clockwise. Adjust this control until noise level is sufficiently reduced.

#### B. Operating the Receiver in Continuous Wave.

- (1) Turn receiver ON using either POWER switch or remote control.
- (2) Set receiver to desired channel, using CHANNEL SELECTOR switch.
- (3) Set AM-SSB/CW switch to SSB/CW position.
- (4) Put AVC switch in SLOW position.
- (5) Adjust RF GAIN control fully clockwise.
- (6) Turn AUDIO GAIN control clockwise until a suitable level is reached.
- (7) Adjust FINE TUNING control for a suitable beat note.
- (8) Use NOISE LIMITER control as conditions dictate.

#### C. Operating the Receiver on Amplitude Modulation

- (1) Turn receiver ON using POWER switch or remote control.
- (2) Set receiver to desired channel, using CHANNEL SELECTOR switch.
- (3) Switch AM-SSB/CW switch to AM position.
- (4) Put AVC switch in FAST position.
- (5) Adjust RF GAIN control fully clockwise.
- (6) Adjust AUDIO GAIN control to a suitable level.
- (7) Adjust FINE TUNING control until a good balance is obtained between the high and low audio frequencies. This will occur close to the point where the "S" meter reacts erratically with severe distortion.

## SECTION IV

### THEORY OF OPERATION

#### 4.1 GENERAL

This receiver is a double conversion superheterodyne unit, set up for four channel operation. It is equipped with a sharp crystal band pass filter which approaches the ideal response for a single sideband receiver. Critical oscillators are crystal controlled by oven controlled crystals to assure a high order of frequency stability.

#### 4.2 RF AMPLIFIER, V-1

This is a conventional tuned RF amplifier with variable grid and plate circuits. The CHANNEL SELECTOR switch on the front panel selects one coil/capacitor combination for the grid circuit and one coil/capacitor combination for the plate circuit, in each of its four positions. The coils and capacitors are adjustable, and access to the capacitor shafts and coil slugs is available on top of the chassis.

#### 4.3 FIRST MIXER, V-2

This is used to heterodyne the incoming signal to an intermediate frequency of 2.0 megacycles. This is accomplished by the use of the injection crystal oscillator (V-7) which has a frequency 2.0 megacycles higher than the incoming carrier frequency.

#### 4.4 FIRST OSCILLATOR, V-7

This Pierce oscillator uses oven controlled crystals to assure maximum stability on the high frequency bands. The crystal is selected 2.0 megacycles higher than the incoming carrier frequency. Variable capacitors C-97 through C-100 are used to adjust the oscillator frequency over a small range to compensate for slight frequency variations in the system.

#### 4.5 SECOND MIXER-OSCILLATOR, V-3

This is used to heterodyne the 2.0 megacycles signal to 413 Kc. This mixer uses either a 2413 or 1587 Kc injection signal, depending on which sideband is to be received. For lower sideband operation, the 2413 Kc crystal should be used. Conversely, the upper sideband would require the use of the 1587 Kc crystal. The fine tuning control, C-21, changes the frequency slightly to permit corrections.

#### 4.6 CRYSTAL FILTER, XF1-A

This modified crystal lattice filter has a flat pass band and steep skirts to approach closely the ideal response for the reception of single sideband signals. The bandwidth of this filter is about three kilocycles.

CAUTION: THIS FILTER IS EXTREMELY CRITICAL. COMPONENTS HAVE BEEN MATCHED TO CLOSE TOLERANCES, AND ADJUSTMENTS HAVE BEEN FACTORY SET FOR THE MAXIMUM IN PERFORMANCE. ANY ATTEMPT TO ADJUST THE CRYSTAL FILTER WILL SERIOUSLY DEGRADE THE PERFORMANCE CHARACTERISTICS OF THE RECEIVER.

#### 4.7 SECOND IF AMPLIFIER, V-4 and V-5

These are conventional IF amplifiers and serve to further amplify the signal at 413 Kc.

#### 4.8 NOISE LIMITER, V-6

This 6AL5 serves as a symmetrical pulse-type noise limiter. When resistor R-27 is switched into the circuit, capacitors C-38 and C-39 charge to the average peak level with such polarity that they oppose the flow of current in the 6AL5 (V-6). When a sudden change in level occurs, the excess signal is shunted across the IF transformer, IFT-3. This prevents a large percentage of noise from passing through the receiver.

#### 4.9 AM DETECTOR, V-9

This 6AL5 is a conventional diode detector. It is switched into the circuit by means of switch SW-2. The AM output is taken from the junction of resistors R-37 and R-38.

#### 4.10 SSB: CW DETECTOR, V 10

This mixer-type detector uses a locally generated signal at 413 Kc, which is crystal controlled. The high frequency products which result from the heterodyning process are filtered out through the capacitor/resistor network, C-49, R-36 and C-50. This detector is switched in or out of the circuit by switch SW-2 which also controls the B+ to the 413 Kc oscillator and the SSB/CW detector.

#### 4.11 413 KC OSCILLATOR, V-8a

This oscillator is used, as previously explained, to receive single sideband and continuous wave signals.

#### 4.12 AUDIO PREAMPLIFIER, V 11

This is a resistance/capacitance coupled two stage amplifier. Putting the receiver in the standby condition applies a high negative bias to the grid of the second stage, thereby cutting it off.

#### 4.13 AUDIO OUTPUT, V 12

This stage provides audio output to the built-in loudspeaker or to a remote location. The design of this stage includes negative feedback for the improvement of audio quality. In the standby condition, this tube is biased to a high negative level, putting the tube in the cut-off region.

#### 4.14 AVC, IF AMPLIFIER, V 13

This conventional IF amplifier has its input capacitively coupled to the grid of V-5. Therefore, signals coming through the crystal filter are also amplified by this stage.

#### 4.15 AVC DETECTOR, V 14

One half of this dual-diode (pins 2 and 5) operates as a conventional diode detector which generates the AVC voltage. Sudden noise pulses are shunted through the other half of the tube, and through C-67 to ground. When C-67 charges, the diode stops conducting. This protects the receiver from being desensitized by noise pulses. AVC delay is applied in the form of a positive voltage obtained from the junction of resistors R-56 and R-57 and applied through IF transformer IFT-4 to the cathode of the AVC detector tube.

#### 4.16 BIAS RECTIFIER, V 15

One half of this 6AL5 (pins 2 and 5) is used as a rectifier to provide bias voltage which is used to manually set the bias on the AVC line. This is accomplished by varying R-67 (RF GAIN control on front panel). The other half of V-15 (pins 7 and 1) functions as a bias gate. When the AVC voltage generated by V-14 is more negative with reference to the voltage selected by R-67, the AVC rectifier no longer controls the AVC line voltage. When the voltage generated by V-14 falls below the voltage set by the RF GAIN control, R-67, the diode gate conducts, and the RF GAIN control takes over. To simplify this explanation, we can say that the RF GAIN control determines the minimum level of the AVC voltage.

#### 4.17 RECTIFIER & POWER SUPPLY, V 16

This 5U4 rectifier and associated choke input filter system are of conventional design.



## SECTION V

### MAINTENANCE

#### 5.1 SERVICE ADJUSTMENTS

##### A. Changing Channel Frequency

- (1) Select the proper crystal frequency for the high frequency oscillator by adding 2.0 megacycles to the desired carrier frequency. Be sure that the crystal selected is of the fundamental frequency type and is of the correct physical size with the proper pin diameters and spacing. (Type HC-6/U)

- (2) The input frequency tuning range of the channels is as follows:

Channel	Frequency Range	Coil	Capacitor
1	2.2 to 4.1 Mc	L-1, L-5	C-1, C-5
2	4.1 to 10.0 Mc	L-2, L-6	C-2, C-6
3	6.0 to 16.0 Mc	L-3, L-7	C-3, C-7
4	11.0 to 30.0 Mc	L-4, L-8	C-4, C-8

- (3) For preliminary settings of the RF coils (L-1 through L-8) and the RF capacitors (C-1 through C-8), refer to the chart provided. This will serve to facilitate the tune-up procedure.
- (4) Tune a signal generator to near the desired output frequency and connect it to the RF input connector. Set RF GAIN control at maximum; the REC/STBY switch in REC; the AUDIO GAIN control at a suitable level; the AM-SSB/CW switch to SSB/CW and the CHANNEL SELECTOR switch to the appropriate channel. Sweep the generator through this frequency until the signal is heard in the receiver. Peak the signal by varying the tuning slugs or variable capacitor. (If "C" is at maximum, use the coil for this peaking operation. If the coil is at maximum, use the capacitor.)
- (5) Gradually reduce the RF input level and at the same time continue to peak the signal with the proper tuning adjustment until maximum sensitivity has been attained.

##### B. Frequency Setting

- (1) There are four trimmer capacitors which are used to set the receiver channels to the precise frequency. These are located directly behind the crystal filter, and to the front of the crystal ovens. Each is marked for the corresponding band. When the receiver is used as a part of the S-100 system, this operation is greatly facilitated.

NOTE: TRANSMITTER MUST BE TUNED TO CORRECT FREQUENCY. (SEE APPROPRIATE MANUAL.)

- (2) Turn RF GAIN control to fully counterclockwise position and AUDIO GAIN control to maximum clockwise position. AM-SSB/CW switch should be in SSB/CW position, AVC switch to MAN position, and REC/STBY switch to REC.
- (3) Turn on transmitter (using SSB mode) and switch M-100 TUNE-OPERATE switch to TUNE position. While speaking into microphone, gradually raise RF GAIN control on R-100 until audio is heard in receiver.
- (4) Set FINE TUNING to mid-range and adjust proper crystal trimmer to frequency. (Until audio in receiver sounds most natural.) Repeat operation for all channels.
- (5) Fill in appropriate information on front panel chart on R-100 Receiver.
- (6) Turn TUNE-OPERATE switch on M-100 to OPERATE position. Set REC/STBY switch on R-100 to STBY and the unit is ready for operation.

NOTE: AFTER CHANGING CHANNEL FREQUENCIES, THE M-100 ANTENNA TUNER SHOULD BE READJUSTED AS PER APPROPRIATE MANUAL.

CHANNEL 1

Freq. /Mc	C	L-1	L-5
2.2	MAX	7 turns from top	8 turns from top
2.5	MAX	5 turns from top	6 turns from top
3.0	7/8 MAX	At top	At top
3.5	1/2 MAX	At top	At top
4.1	1/4 MAX	At top	At top

CHANNEL 2

Freq. /Mc	C	L-2	L-6
4.1	MAX	11 turns from top	10 turns from top
4.5	MAX	7 turns from top	5 turns from top
5.0	MAX	4 turns from top	3 turns from top
5.5	MAX	2 turns from top	1-1/2 turns from top
6.0	near MAX	Top	Top
6.5	7/8 cap	Top	Top
7.0	3/4 cap	Top	Top
7.5	5/8 cap	Top	Top
8.0	1/2 cap	Top	Top
8.5	1/2 cap	Top	Top
9.0	3/8 cap	Top	Top
9.5	1/4 cap	Top	Top
10.0	1/4 cap	Top	Top

### CHANNEL 3

Freq. /Mc	C	L-3	L-5
6.0	MAX	8 turns from top	6 turns from top
6.5	MAX	6 turns from top	5 turns from top
7.0	MAX	4-1/2 turns from top	3-1/2 turns from top
8.0	MAX	3 turns from top	1/2 turn from top
9.0	MAX	1/2 turn from top	Top
10.0	3/4 cap	Top	Top
11.0	1/2 cap	Top	Top
12.0	1/2 cap	Top	Top
13.0	3/8 cap	Top	Top
14.0	3/8 cap	Top	Top
15.0	1/4 cap	Top	Top
16.0	1/8 cap	Top	Top

### CHANNEL 4

	C	L-4	L-8
11	MAX	7-1/2 turns from top	6 turns from top
12	MAX	6 turns from top	5 turns from top
13	MAX	5 turns from top	3 turns from top
14	MAX	3-1/2 turns from top	1-1/2 turns from top
15	MAX	2 turns from top	Top
17	7/8 cap	Top	Top
19	5/8 cap	Top	Top
20	1/2 cap	Top	Top
22	1/2 cap	Top	Top
24	3.8 cap	Top	Top
27	1/4 cap	Top	Top
28	1/8 cap	Top	Top
30	Near MIN	Top	Top

## 5.2 TROUBLE SHOOTING

In general, this double conversion receiver may be serviced by following the usual servicing procedures. However, this unit has several unique circuits which require unusual techniques. The primary difference is the crystal filter which has a flat pass band with sharp cut-off at each edge of the three kilocycle pass band.

**CAUTION:** THIS FILTER HAS BEEN PRE-SET AT THE FACTORY FOR OPTIMUM PERFORMANCE. NO ATTEMPT SHOULD BE MADE TO READJUST OR SERVICE THIS FILTER. ANY SUCH ATTEMPT WILL SERIOUSLY DEGRADE THE PERFORMANCE OF THE RECEIVER.

### A. Signal Substitution in the R-100 Receiver.

The following steps should facilitate the isolation of trouble and the stage responsible for the trouble:

- (1) Set receiver controls as follows:

AUDIO GAIN control . . . . .	Halfway position
RF GAIN control . . . . .	Maximum clockwise position
REC/STBY switch . . . . .	REC position
NOISE LIMITER . . . . .	OFF
AM-SSB/CW switch . . . . .	AM
AVC switch . . . . .	MAN
POWER switch . . . . .	ON

- (2) Audio Frequency Output: Connect an audio signal generator to pins 1 and 7 of V-12 through an appropriate blocking capacitor (.01 mfd). The signal generator frequency should be 400 cps at a level of 5 volts. If a moderately loud audio signal appears at the loudspeaker, it may be assumed that the audio output stage is functioning. If not, voltage and resistance checks as well as tube and capacitor substitution will show the location of the problem.
- (3) Audio Frequency Driver: Connect the audio generator to pin 7 of V-11 through a .01 mfd blocking capacitor. Set the generator to 400 cps at about the 1 volt level. A moderately loud signal should be heard in the loudspeaker. If not, voltage, resistance and capacitance checks should be made to reveal the specific cause of the trouble.
- (4) Audio Frequency Preamplifier: Connect the audio frequency generator to pin 2 of V-11. Set the generator to 400 cps at about .1 volt. A moderately loud audio signal should be heard in the loudspeaker. If this is not the case, make voltage, resistance and capacitor substitution checks to isolate the cause of the trouble.
- (5) AM Detector: Connect an RF generator to pin 7 of V-9 through a 500 mmfd capacitor. Set the generator to 413 Kc modulated by 400 cps audio. The maximum level should be about 100,000 microvolts. Audio should be heard in the loudspeaker with AUDIO GAIN maximum clockwise. If not, make usual resistance, voltage and capacitance substitution checks to locate the source of the trouble.
- (6) SSB/CW Detector: Connect an RF signal generator to pin 7 of V-9 through a 500 mmfd capacitor. Set the generator to a level of 100,000 microvolts at a frequency of 413 Kc with no modulation. Set the AM-SSB/CW switch on the R-100 to the SSB/CW position. Carefully tune the signal generator until an audio tone is heard in the loudspeaker. Set the generator on the low frequency side of the zero beat. Leave the generator at this frequency. If an audio beat note is not heard in the loudspeaker, trouble is indicated in V-10 or V-8A. Make voltage, resistance and capacitance checks to isolate the trouble. Reset AM-SSB/CW switch to AM.
- (7) IF Amplifier II: Connect the RF generator to pin 1 of V-5 through a 500 mmfd block capacitor. Set the frequency as in Step 6, preceding, and apply a 400 cps modulation. Audio should be heard in the loudspeaker. If not, a defect in V-5 and/or its associated circuitry is

indicated. Voltage, resistance and capacitance checks should isolate the difficulty.

- (8) IF Amplifier I: Connect the RF generator to pin 1 of V-4. Use a 500 mmfd block capacitor. Set the generator as in Step 6, preceding, with 400 cps modulation. Audio should be heard in the loudspeaker, or a malfunction is indicated in V-4 or its associated circuitry. Voltage, resistance and capacitance substitution checks will isolate the cause of the failure.

NOTE: AS THESE STEPS PROCEED TOWARD THE RF AMPLIFIER SECTION, IT WILL BE NECESSARY TO REDUCE THE RF OUTPUT OF THE SIGNAL GENERATOR TO COMPENSATE FOR THE GAIN OF THESE STAGES.

- (9) Second Converter: With the generator set as in the preceding step, apply the signal through a 500 mmfd capacitor to pin 7 of V-3. It may be necessary to slightly retune the signal generator in order to again bring the signal into the pass band of the filter. This will indicate that the filter is functioning properly. To check further, set the AM-SSB/CW switch to SSB/CW, turn off the 400 cps modulation at the generator and gradually tune the signal generator through the pass band of the filter. At the zero beat point, the generator should be tuned to 413 Kc. Above this frequency, the filter should prevent much audio from appearing at the loudspeaker. Below the zero beat point, the audio output level should be higher and then, at about three kilocycles, should drop sharply to a low level. While performing this check, be sure that the RF generator is set to a very low level or spurious indications may result.

NOTE: A BEAT MAY OCCUR NEAR 400 KC. THIS IS DUE TO HARMONICS FROM THE SIGNAL GENERATOR.

CAUTION: DO NOT ATTEMPT TO READJUST THIS FILTER. SPECIAL EQUIPMENT IS REQUIRED TO MAKE ANY ADJUSTMENTS AND ANY ATTEMPT TO MAKE SUCH ADJUSTMENTS WITHOUT THIS EQUIPMENT WILL RESULT IN SEVERELY DEGRADED PERFORMANCE OF THE EQUIPMENT. IF THE FILTER IS DEFECTIVE, IT SHOULD BE RETURNED TO THE FACTORY FOR MAINTENANCE OR TO A QUALIFIED ESTABLISHMENT EQUIPPED WITH THE PROPER EXPERIENCE AND TOOLS.

With the signal generator connected as before, set the frequency to 2.0 Mc. Tune the generator through this frequency and a beat note should be heard. If not, check the oscillator section of this tube. The usual tests should isolate the cause of the difficulty.

- (10) First Converter (V-2): Connect the RF signal generator to pin 7 of V-2 through a 500 mmfd capacitor. Set the generator to 2.0 Mc and set the AM-SSB/CW switch to SSB/CW position. Tune the generator through the 2.0 Mc point. A variable beat note should be heard louder on one side of zero beat than on the other. If this occurs, the plate circuit of the tube is operating. Tune the signal generator to the proper channel frequency and leaving the control set in this position,

tune the generator through the channel frequency. If the stage is operating properly, a variable beat note will be heard as before. The signal should now be louder below the zero beat point than above. If no audio is heard at the loudspeaker, it indicates that conversion is not taking place, which may be due to defects in either the oscillator (V-7) or in the first converter (V-2).

- (11) **RF Amplifier:** For alignment, follow procedure outlined in Section 5.1 (Changing Channel Frequencies). To check the operation, set AM-SSB/CW switch to AM. Tune the signal generator to 400 cps audio at a level of 5 microvolts (30%). If the receiver is functioning properly, a moderately loud audio signal will be heard at the loudspeaker. This signal will be practically free of noise. The usual tests should reveal any difficulty.
- (12) **Noise Limiter:** To check this circuit, set up the receiver and signal generator as in Step 11, preceding. Reduce the output level of the signal generator until a noticeable amount of noise is present with the signal. Turn the noise limiter control clockwise and the noise level should decrease. If any difficulty is encountered, the usual measurements and substitution checks should reveal the source.
- (13) **Bias Rectifier (V-15):** This rectifier produces 110 volts DC. After filtering, this is applied to the RF GAIN control. The other half of V-15 is a bias gate to prevent the AVC voltage generated by V-14 from being shorted through R-67 (when at minimum). Voltage measurements will detect any faults in this circuit.
- (14) **"S" Meter Amplifier (V-8b):** With the receiver set up as before (signal generator disconnected), turn RF GAIN to minimum (fully counterclockwise) and the AVC switch to SLOW. The "S" meter should indicate full scale and beyond. In the event this does not occur, servicing is indicated.
- (15) **AVC IF Amplifier (V-13) & AVC Detector (V-14):** Inject a 413 Kc signal into pin 1 of V-13. When properly set up, the "S" meter should deflect with the AVC switch in the SLOW position. Check the tuning of IFT-4. If all previous checks have been made and this does not occur, difficulty is indicated in V-13 or V-14 and their associated components. If this check shows everything to be all right, connect a signal generator set at the correct channel frequency to J-1 (antenna jack). Set the signal generator output level to 100 microvolts modulated by 400 cps to 30%. When the generator is tuned in, the "S" meter should read S-9 with the AVC switch in the SLOW position. This will occur if everything is properly functioning. Rapidly tune the generator through the pass band of the receiver. The "S" meter should kick up rapidly and settle down slowly. In the FAST position of the AVC switch, the "S" meter should both kick up and settle back rapidly. If this does not occur, the capacitor, C-69, is probably open since this capacitor controls the decay time of the AVC line.
- (16) **"S" Meter Zero:** To adjust the "S" meter, disconnect the signal gen-

erator and set the AVC switch in the MAN position. Adjust R-63 located on top of the chassis near V-8.

- (17) Power Rectifier (V-16): The power supply is of usual design, and voltage and resistance checks should isolate the cause of any difficulty.

### 5.3 ALIGNMENT PROCEDURE

A. Set the receiver controls as follows:

AF GAIN . . . . .	Maximum clockwise
NOISE LIMITER . . . . .	OFF
AM-SSB/CW switch . . . . .	AM (Remove V-7 from socket)
AVC switch . . . . .	MAN
RF GAIN . . . . .	Maximum clockwise
REC/STBY switch . . . . .	REC
POWER switch. . . . .	ON

B. Connect a source of 412 Kc RF (modulated by 400 cps) through a blocking capacitor to pin 7 of V-3. Raise the level (not in excess of 100,000 microvolts) until a signal is heard at the loudspeaker.

- (1) The signal generator may have to be tuned back and forth until it is heard through the crystal filter. Leave the generator at this frequency. When properly tuned, the modulation should sound undistorted.

**CAUTION: DO NOT ATTEMPT TO ADJUST THE CRYSTAL FILTER OR SERIOUS DIFFICULTIES WILL RESULT.**

C. Peak IFT-2 and IFT-3 for maximum audio output. Adjust IFT-4 for maximum "S" meter deflection.

D. Connect the signal generator to pin 7 of V-2 through a blocking capacitor. (Remove V-7 from socket.) Tune the signal generator to 2.0 Mc with 400 cps modulation. With the signal generator at a level of 100 microvolts, tune through the 2.0 Mc point until output is heard clearly and undistorted.

- (1) Peak IFT-1 for maximum sensitivity and replace V-7. For RF amplifier alignment, see Section 5.1.

## PARTS LIST

Part No.	Description
R-1	Resistor, carbon, 10K ohm, 1/2 watt, 10%
R-2	Resistor, carbon 47K ohm, 1/2 watt, 10%
R-3	Resistor, carbon, 10K ohm, 1/2 watt, 10%
R-4	Resistor, carbon, 1M ohm, 1/2 watt, 10%
R-5	Resistor, carbon, 10K ohm, 1/2 watt, 10%
R-6	Resistor, carbon, 68 ohm, 1 watt, 10%
R-7	Resistor, carbon, 22K ohm, 1/2 watt, 10%
R-8	Resistor, carbon, 4.7K ohm, 1/2 watt, 10%
R-9	Resistor, carbon, 8.2K ohm, 1/2 watt, 10%
R-10	Resistor, carbon, 33K ohm, 1/2 watt, 10%
R-11	Resistor, carbon, 220 ohm, 1/2 watt, 10%
R-12	Resistor, carbon, 10K ohm, 1/2 watt, 10%
R-13, R-14	Omitted
R-15	Resistor, carbon, 15K ohm, 1 watt, 10%
R-16	Resistor, carbon, 5.6K ohm, 2 watt, 10%
R-17	Resistor, carbon, 47K ohm, 1/2 watt, 10%
R-18	Resistor, carbon, 1M ohm, 1/2 watt, 10%
R-19	Resistor, carbon, 3.9M ohm, 1/2 watt, 10%
R-20	Resistor, carbon, 150 ohm, 1/2 watt, 10%
R-21	Resistor, carbon, 47K ohm, 1/2 watt, 10%
R-22	Resistor, carbon, 2.2K ohm, 1/2 watt, 10%
R-23	Resistor, carbon, 1M ohm, 1/2 watt, 10%
R-24	Resistor, carbon, 2.2M ohm, 1/2 watt, 10%
R-25	Resistor, carbon, 150 ohm, 1/2 watt, 10%
R-26	Resistor, carbon, 120K ohm, 1/2 watt, 10%
R-27	Resistor, carbon pot, 2 watt w/switch, 5M ohm, linear taper
R-28	Resistor, carbon, 120K ohm, 1/2 watt, 10%
R-29	Resistor, carbon, 47K ohm, 1/2 watt, 10%



Part No.	Description
R-30	Resistor, carbon, 2.2K ohm, 1/2 watt, 10%
R-31	Resistor, carbon, 39K ohm, 1/2 watt, 10%
R-32	Resistor, carbon, 220 ohm, 1/2 watt, 10%
R-33	Resistor, carbon, 10K ohm, 1/2 watt, 10%
R-34	Resistor, carbon, 2.7K ohm, 1/2 watt, 10%
R-35	Resistor, carbon, 33K ohm, 1/2 watt, 10%
R-36	Resistor, carbon, 47K ohm, 1/2 watt, 10%
R-37	Resistor, carbon, 220K ohm, 1/2 watt, 10%
R-38	Resistor, carbon, 180K ohm, 1/2 watt, 10%
R-39	Resistor, carbon, 47K ohm, 1/2 watt, 10%
R-40	Resistor, carbon, 1K ohm, 1/2 watt, 10%
R-41	Resistor, carbon, 22K ohm, 1/2 watt, 10%
R-42	Resistor, carbon pot, 2 watt, 5M ohm, taper
R-43	Resistor, carbon, 100K ohm, 1/2 watt, 10%
R-44	Resistor, carbon, 2.2K ohm, 1/2 watt, 10%
R-45	Resistor, carbon, 100K ohm, 1/2 watt, 10%
R-46	Resistor, carbon, 2.2K ohm, 1/2 watt, 10%
R-47	Resistor, carbon, 100K ohm, 1/2 watt, 10%
R-48	Resistor, carbon, 100K ohm, 1/2 watt, 10%
R-49	Resistor, carbon, 68K ohm, 1/2 watt, 10%
R-50	Resistor, carbon, 1M ohm, 1/2 watt, 10%
R-51	Resistor, carbon, 330 ohm, 1 watt, 10%
R-52	Resistor, carbon, 1M ohm, 1/2 watt, 10%
R-53	Resistor, carbon, 150 ohm, 1/2 watt, 10%
R-54	Resistor, carbon, 47K ohm, 1/2 watt, 10%
R-55	Resistor, carbon, 2.2K ohm, 1/2 watt, 10%
R-56	Resistor, carbon, 270K ohm, 1/2 watt, 10%
R-57	Resistor, carbon, 3.3K ohm, 1/2 watt, 10%
R-58	Resistor, carbon, 4.7M ohm, 1/2 watt, 10%
R-59	Resistor, carbon, 10K ohm, 1/2 watt, 10%
R-60	Resistor, carbon, 470 ohm, 1/2 watt, 10%
R-61	Resistor, carbon, 470 ohm, 1/2 watt, 10%
R-62	Resistor, carbon, 56K ohm, 1/2 watt, 10%
R-63	Resistor, carbon pot, 2 watt, 5K ohm, linear taper

Part No.	Description
R-64	Resistor, carbon, 2.2K ohm, 1/2 watt, 10%
R-65	Resistor, carbon, 330K ohm, 1/2 watt, 10%
R-66	Resistor, carbon, 330K ohm, 1/2 watt, 10%
R-67	Resistor, carbon pot, 10K ohm, linear taper
R-68	Resistor, carbon, 4.7K ohm, 1/2 watt, 10%
R-69	Resistor, carbon, 1K ohm, 1/2 watt, 10%
R-70	Resistor, carbon, 1K ohm, 1/2 watt, 10%
R-71	Omitted
R-72	Resistor, carbon, 39K ohm, 1/2 watt, 10%
R-73	Resistor, carbon, 3.9M ohm, 1/2 watt, 10%
R-74	Resistor, carbon, 180 ohm, 1/2 watt, 10%
R-75	Resistor, carbon, 2.2K ohm, 1/2 watt, 10%
R-76	Resistor, carbon, 22K ohm, 1/2 watt, 10%
R-77	Resistor, carbon, 10 ohm, 1 watt, 10%
R-78	Resistor, carbon, 33K ohm, 1 watt
R-79	Resistor, carbon, 680 ohm, 1/2 watt
R-80	Resistor, carbon, 1M ohm, 1/2 watt, 10%
R-81	Resistor, carbon, 18K, 1/2 watt, 10%
R-82	Resistor, carbon, 1K ohm, 1/2 watt, 10%
C-1	Capacitor, variable, 100 mmfd
C-1B	Capacitor, 50 mmfd, TCZ
C-2	Capacitor, variable, 100 mmfd
C-3	Capacitor, variable, 100 mmfd
C-4	Capacitor, variable, 100 mmfd
C-5	Capacitor, variable, 100 mmfd
C-5B	Capacitor, 50 mmfd, TCZ
C-6	Capacitor, variable, 100 mmfd
C-7	Capacitor, variable, 100 mmfd
C-8	Capacitor, variable, 100 mmfd
C-9	Capacitor, ceramic disc, .001 mfd, 600 WVDC
C-10	Capacitor, ceramic disc, .001 mfd, 600 WVDC
C-11	Capacitor, ceramic disc, .001 mfd, 600 WVDC
C-12	Capacitor, ceramic disc, .001 mfd, 600 WVDC

Part No.	Description
C-13	Capacitor, ceramic disc, .001 mfd, 600 WVDC
C-14	Capacitor, 100 mmfd, 500 WVDC, Durmica
C-15	Capacitor, 100 mmfd, 500 WVDC, Durmica
C-16	Capacitor, ceramic disc, .01 mfd, 600 WVDC
C-17	Capacitor, ceramic disc, .001 mfd, 600 WVDC
C-18	Capacitor, ceramic disc, .01 mfd, 600 WVDC
C-19	Capacitor, ceramic disc, .01 mfd, 600 WVDC
C-20	Capacitor, ceramic disc, .01 mfd, 600 WVDC
C-21	Capacitor, variable, 25 mmfd
C-22, C-23	Omitted
C-24	Capacitor, ceramic disc, .025 mfd, 600 WVDC
C-25	Capacitor, 250 mmfd, Durmica, 10%
C-26	Capacitor, ceramic tubular, 15 mmfd, TCZ
C-27, C-28	Omitted
C-29	Capacitor, ceramic disc, .01 mfd, 600 WVDC
C-30	Omitted
C-31	Capacitor, metalized paper, .1 mfd, 200 V
C-32	Capacitor, ceramic disc, .025 mfd, 600 WVDC
C-33	Capacitor, ceramic disc, .025 mfd, 600 WVDC
C-34	Capacitor, ceramic disc, .01 mfd, 600 WVDC
C-35	Capacitor, metalized paper, .1 mfd, 200 V
C-36	Capacitor, ceramic disc, .025 mfd, 600 WVDC
C-37	Capacitor, ceramic disc, .001 mfd, 600 WVDC
C-38	Capacitor, metalized paper, .1 mfd, 200 V
C-39	Capacitor, metalized paper, .1 mfd, 200 V
C-40	Capacitor, ceramic disc, 330 mmfd, 600 WVDC
C-41	Capacitor, ceramic tubular, 10 mmfd, TCZ
C-42	Capacitor, Durmica, 500 mmfd, 300 WVDC
C-43	Capacitor, Durmica, 200 mmfd, 500 WVDC
C-44	Capacitor, electrolytic tubular with leads, 10 mfd, 50 WVDC
C-45	Capacitor, ceramic disc, .01 mfd, 600 WVDC
C-46	Capacitor, ceramic disc, .01 mfd, 600 WVDC
C-47	Capacitor, electrolytic tubular with leads, 8 mfd, 250 WVDC
C-48	Capacitor, electrolytic tubular with leads, 8 mfd, 250 WVDC

Part No.	Description
C-49	Capacitor, Durmica, 500 mmfd, 300 WVDC
C-50	Capacitor, ceramic disc, .001 mfd, 600 WVDC
C-51	Capacitor, Durmica, 200 mmfd, 500 WVDC
C-52	Capacitor, ceramic disc, .005 mfd, 600 WVDC
C-53	Capacitor, Durmica, 100 mmfd, 500 WVDC
C-54	Capacitor, metalized paper, .1 mfd, 200 V
C-55	Capacitor, ceramic disc, .01 mfd, 600 WVDC
C-56	Capacitor, ceramic disc, .01 mfd, 600 WVDC
C-57	Capacitor, ceramic disc, .005 mfd, 600 WVDC
C-58	Capacitor, ceramic disc, .01 mfd, 600 WVDC
C-59	Capacitor, metalized paper, .1 mfd, 200 V
C-60	Capacitor, electrolytic tubular with leads, 4 mfd, 50 WVDC
C-61	Capacitor, ceramic disc, .01 mfd, 600 WVDC
C-62	Capacitor, ceramic disc, .025 mfd, 600 WVDC
C-63	Omitted
C-64	Capacitor, ceramic disc, .025 mfd, 600 WVDC
C-65	Capacitor, metalized paper, .1 mfd, 200 V
C-66	Capacitor, metalized paper, .1 mfd, 200 V
C-67	Capacitor, metalized paper, .1 mfd, 200 V
C-68	Capacitor, ceramic disc, 330 mmfd, 600 WVDC
C-69	Capacitor, metalized paper, .1 mfd, 200 V
C-70	Capacitor, metalized paper, .1 mfd, 200 V
C-71	Capacitor, electrolytic tubular with leads, 50 mfd, 150 WVDC
C-72	Capacitor, electrolytic tubular with leads, 50 mfd, 150 WVDC
C-73	Capacitor, electrolytic, 40/40 mfd
C-74	Capacitor, ceramic disc, .01 mfd, 600 WVDC
C-75	Capacitor, ceramic disc, .01 mfd, 600 WVDC
C-76	Capacitor, ceramic disc, .005 mfd, 600 WVDC
C-77	Capacitor, ceramic disc, .001 mfd, 600 WVDC
C-78	Capacitor, ceramic disc, .025 mfd, 600 WVDC
C-79	Capacitor, ceramic tubular, 33 mmfd, TCZ
C-80	Capacitor, ceramic tubular, 33 mmfd, TCZ
C-81	Capacitor, ceramic tubular, 33 mmfd, TCZ
C-82	Capacitor, ceramic tubular, 33 mmfd, TCZ

Part No.	Description
C-83	Capacitor, ceramic tubular, 33 mmfd, TCZ
C-84	Capacitor, ceramic disc, .025 mfd, 600 WVDC
C-85	Capacitor, ceramic tubular, 33 mmfd, TCZ
C-86	Capacitor, ceramic tubular, 33 mmfd, TCZ
C-87	Capacitor, ceramic disc, .003 mfd, 2 KV
C-88	Capacitor, ceramic disc, .003 mfd, 2 KV
C-89	Capacitor, ceramic disc, .01 mfd GMV
C-90	Capacitor, ceramic disc, .01 mfd GMV
C-91	Capacitor, ceramic disc, .01 mfd GMV
C-92	Capacitor, ceramic disc, .01 mfd GMV
C-93	Capacitor, ceramic tubular, 10 mmfd, TCZ
C-94	Capacitor, Durmica, 84 mmfd
C-95	Capacitor, ceramic disc, .01 mfd
C-96	Capacitor, filter, 16 mfd, 450 WVDC
C-97	Trimmer, miniature, 20 mmfd
C-98	Trimmer, miniature, 20 mmfd
C-99	Trimmer, miniature, 20 mmfd
C-100	Trimmer, miniature, 20 mmfd
C-101	Capacitor, ceramic disc, .025 mfd
C-102	Capacitor, ceramic disc, .005 mfd
L-1	Antenna coil, Channel A
L-2	Antenna coil, Channel B
L-3	Antenna coil, Channel C
L-4	Antenna coil, Channel D
L-5	RF coil, Channel A
L-6	RF coil, Channel B
L-7	RF coil, Channel C
L-8	RF coil, Channel D
IFT-1	IF transformer, 2.0 Mc
IFT-2	IF transformer, 413 Kc
IFT-3	IF transformer, 413 Kc
IFT-4	IF transformer, 413 Kc

Part No.	Description
T-1	Transformer, power, Eldico ET-338
T-2	Transformer, audio, Eldico ET-328E
CH-1	Filter choke, Eldico EC-337
CH-2	Filter choke, Eldico EC-329
M-1	"S" meter, special scale
O-1	Crystal oven, (for use with HC-6/U crystal holder only)
O-2	Crystal oven, (for use with HC-6/U crystal holder only)
XF-1A	Crystal filter assembly
SW-1A	Switch, rotary, wafer, PA-1,
SW-1B	Switch, rotary, wafer, PA-11
SW-1C	Switch, rotary, wafer, PA-11 (all on PA-302 detent, CRL)
SW-1D	Switch, rotary, wafer, PA-1
SW-1E	Switch, rotary, wafer, PA-1
SW-2A, 2B, 2C	Switch, rotary, PA-5 wafer on PA-300 detent, CRL
SW-3	N.L. On-Off switch on R-27
SW-4	Switch, toggle, SPST
SW-5	Switch rotary, 2 pole, 3 position, PA-3 wafer on PA300 detent, CRL
SW-6	Switch, toggle, SPST
V-1	6DC6 tube
V-2	6BA7 tube
V-3	6BE6 tube
V-4	6BA6 tube
V-5	6BA6 tube
V-6	6AL5 tube
V-7	12AT7 tube
V-8	12AU7 tube
V-9	6AL5 tube
V-10	6BE6 tube

Part No.	Description
V-11	12AT7 tube
V-12	6AQ5 tube
V-13	6AU6 tube
V-14	6AL5 tube
V-15	6AL5 tube
V-16	5U4 tube
V-17	OB2 tube
J-1	Connector
J-2	Jack
	Loudspeaker, 3" diameter, 4 ohm impedance
F-1	Fuseholder 5 amp fuse for above
I-1	Pilot lamp assembly Pilot lamp, NE-51
RFC-1	Choke, 2.2 mh.

## R-100 RESISTANCE CHARTS

TUBE		PIN 1	PIN 2	PIN 3	PIN 4	PIN 5	PIN 6	PIN 7	PIN 8	PIN 9	PIN 10
V-1	6DC6	4Meg	180	0	.1	80K	110K	0	-	-	-
V-2	6BA7	80K	22K	680	0	.1	0	1.2Meg	0	72K	-
V-3	6BE6	47K	44	0	.1	70K	85K	340K	-	-	-
V-4	6BA6	1.9Meg	0	0	.1	70K	100K	150	-	-	-
V-5	6BA6	1Meg	0	0	.1	70K	110K	150	-	-	-
V-6	6AL5	Inf.	Inf.	0	.1	70K	0	70K	-	-	-
V-7	12AT7	80K	33K	220	.1	.1	80K	33K	220	0	-
V-8	12AU7	38K	840K	measure R-63	.1	.1	80K	22K	0	0	-
V-9	6AL5	0	410K	0	.1	0	0	410K	-	-	-
V-10	6BE6	22K	220	0	.1	50K	100K	42K	-	-	-
V-11	12AT7	150K	470K	2.2K	.1	.1	150K	200K	2.2K	0	-



TUBE	PIN 1	PIN 2	PIN 3	PIN 4	PIN 5	PIN 6	PIN 7	PIN 8	PIN 9	PIN 10
V-12 6AQ5	180K	330	0	.1	70K	70K	180K	-	-	-
V-13 6AU6	1Meg	0	0	.1	70K	100K	150	-	-	-
V-14 6AL5	2Meg	2Meg	0	.1	3.5K	0	4.7Meg	-	-	-
V-15 6AL5	0	18K	0	.1	220	0	2Meg	-	-	-
V-16 5U4	Inf.	70K	Inf.	75	70K	75	Inf.	70K	-	-
V-17 OB2	Inf.	0	Inf.	0	70K	Inf.	Inf.	-	-	-
Term.Strip	Inf.	Inf.	.3	80K	Inf.	Inf.	Inf.	.1	0	0

All measurements made with AC power plug disconnected, using 20,000-ohms-per-volt volt/ohm meter.

Panel controls set in following positions:

AUDIO GAIN	MAXIMUM	RF GAIN	MAXIMUM	NOISE LIMITER	ON, MAX.
AM-SSB/CW	AM*	POWER	ON	REC/STBY	STBY
AVC	SLOW	CHANNEL SEL.	1	FINE TUNING	CENTERED

\* V-10 and V-8A; AM-SSB/CW switch in SSB/CW position.

## R-100 VOLTAGE CHARTS

TUBE	PIN 1	PIN 2	PIN 3	PIN 4	PIN 5	PIN 6	PIN 7	PIN 8	PIN 9	PIN 10
V-1 6DC6	-.05 0	2.05 1.3	0	6.3AC	250	150	0	-	-	-
V-2 6BA7	87 120	-1.8 0	.75 8.0V	0	6.3AC	0	0	0	240	-
V-3 6BE6	0 0	.5	0	6.3AC	280	120	-1.2	-	-	-
V-4 6BA6	-.15 0	0	0	6.3AC	300	125	1.8V	-	-	-
V-5 6BA6	-.15 0	0	0	6.3AC	300	120	1.8	-	-	-
V-6 6AL5	205 300	205 300	0	6.3AC	300	0	300	-	-	-
V-7 12AT7	82 78	-2.35 -6	.65 .8	6.3AC	6.3AC	82 78	-2.35 -6.0	.65 .8	0	-
V-8 12AU7	102 140	-.1 0	5.5 6.0	6.3AC	6.3AC	0-55 -.4	-1.78 -.55	0	0	-
V-9 6AL5	0	-.5 -.3	0	6.3AC	0	0	-.5 -.3	-	-	-
V-10 6BE6 AM-SSB CW	-.5 -1.8	0 3.0	0 0	6.3AC 6.3AC	3 95	-.5 120	0 0	-	-	-

TUBE	PIN 1	PIN 2	PIN 3	PIN 4	PIN 5	PIN 6	PIN 7	PIN 8	PIN 9	PIN 10
V-11 12AT7 stby 150 rec 145	150	0	3.25	6.3AC	6.3AC	300	90	0	0	-
V-12 6AQ5 stby -90 rec 0	-90	0	0	6.3AC	320	320	-90	-	-	-
V-13 6AU6	0	0	0	6.3AC	280	140	1.5	-	-	-
V-14 6AL5	-.7	-.7	0	6.3AC	3.8	0	-1.0	-	-	-
V-15 6AL5	0	-110	0	6.3AC	112AC	0	-.8	-	-	-
V-16 5U4	0	350	0	300AC	300AC	300AC	0	350	-	-
V-17 OB2	111	0	0	0	111	0	0	-	-	-
Term Strip	0	0	0	-110	0	0	0	6.3AC	0	0

All measurements taken with 20,000 ohms-per-volt volt/ohm meter. Line voltage 120 volts AC. All conditions same as for resistance charts, except that "FINE TUNING" control set at maximum capacity. (White line marker horizontal and to right.)

## R-100 GRID PARTS LOCATION

### RESISTORS

R-1	D9	R-31	G2, H2
R-2	F9, F10	R-32	G6
R-3	F8, F9	R-33	F6, G6
R-4	H11	R-34	G6
R-5	I12	R-35	F6, G6
R-6	H13	R-36	F6
R-7	I12	R-37	I3
R-8	J12, K12	R-38	I2, I3
R-9	J12, J13	R-39	E5, F5
R-10	I13	R-40	G6, H6
R-11	I13	R-41	F4, G4
R-12	J13	R-42	N2, O2
R-13	Omitted	R-43	E2
R-14	Omitted	R-44	D3
R-15	L14	R-45	D3
R-16	K17, L17	R-46	D2, E2
R-17	M15, M16	R-47	D2, E2
R-18	L7, L8	R-48	D4
R-19	L7	R-49	J16, K16
R-20	M6, M7	R-50	D5
R-21	M6	R-51	E5
R-22	N5	R-52	L4
R-23	M5	R-53	L4
R-24	N5	R-54	M3, M4
R-25	J5	R-55	M4
R-26	J3	R-56	K1, K2
R-27	J4, K4	R-57	K1, K2
R-28	J3	R-58	M1, M2
R-29	H6, I6	R-59	M3
R-30	G6	R-60	E4

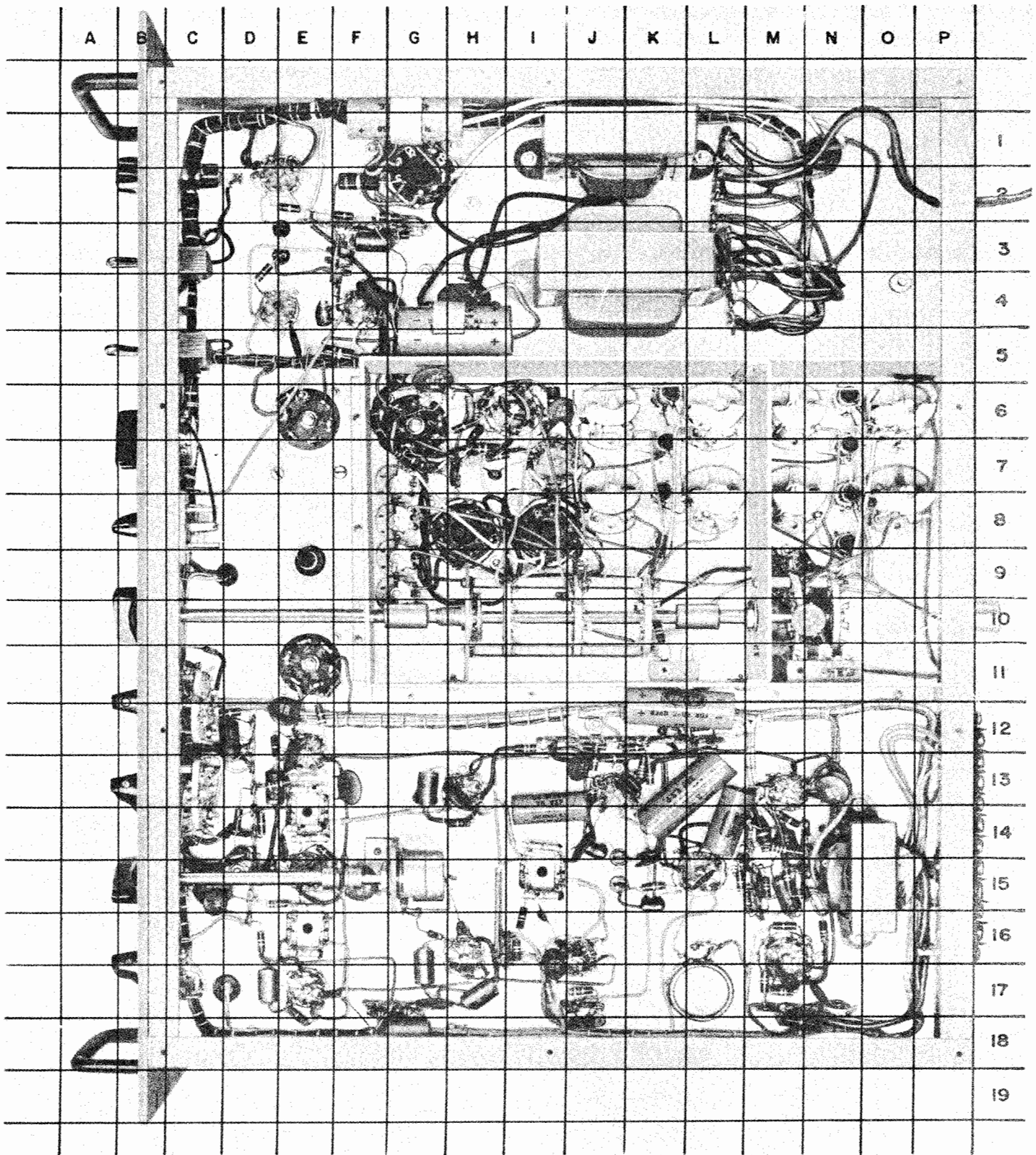

R-100 BOTTOM VIEW

R-61	E4
R-62	E4
R-63	E2, F2
R-64	N7
R-65	N7
R-66	N8
R-67	O12, O13
R-68	K16
R-69	K16, L16
R-70	M17
R-71	Omitted

R-72	J13
R-73	C8
R-74	D9
R-75	M13
R-76	G6
R-77	D1, D2
R-78	D4, D5
R-79	E3, E4
R-80	N5, O5
R-81	E7, F7
R-82	L16

### CAPACITORS

C-1	B13, C13
C-1b	B12, C12
C-2	D13
C-3	B11, C11
C-4	D11
C-5	E13, F13
C-5b	F12
C-6	G13
C-7	E11, F11
C-8	G11
C-9	D9, D10
C-10	C9, D9
C-11	D10
C-12	H11
C-13	K12, K13
C-14	(In IFT-1) K13
C-15	(In IFT-1) K13
C-16	J12
C-17	H12, H13
C-18	J12

C-19	I12
C-20	H9
C-21	N11
C-22	Omitted
C-23	Omitted
C-24	K15
C-25	L15
C-26	L15
C-27	Omitted
C-28	Omitted
C-29	L7, L8
C-30	Omitted
C-31	N6, N7
C-32	L6, M6
C-33	L6
C-34	M4, M5
C-35	J5, J6
C-36	J5, J6
C-37	J3
C-38	I2, J2

C-39	J2, J3	C-71	I14, J14, K14
C-40	H3	C-72	I14, J14, K14
C-41	H2	C-73	I15, J15
C-42	H1, H2	C-74	D8, D9
C-43	G4, G5	C-75	D9
C-44	H5	C-76	H13
C-45	H6	C-77	I12
C-46	G6	C-78	L14
C-47	F5, F6	C-79	L5, M5
C-48	E7, F7, G7	C-80	L5, M5
C-49	G6	C-81	L5, M5
C-50	E7, F7	C-82	H5, I5
C-51	F4, G4	C-83	H4, I4
C-52	F4, G4	C-84	G5, H5
C-53	F4, G4	C-85	L3, M3
C-54	D4, D5	C-86	L3, M3
C-55	N6	C-87	E16
C-56	D2, D3	C-88	E16
C-57	D2	C-89	J2
C-58	C6, D6	C-90	H2, H3
C-59	E3, E4	C-91	F4
C-60	E5	C-92	E4
C-61	C6, D6	C-93	I13, J13
C-62	K4, L4	C-94	H13
C-63	Omitted	C-95	J12
C-64	N4	C-96	J18, K18
C-65	J1, K1	C-97	K9
C-66	J11, J12	C-98	K10
C-67	M2	C-99	K11
C-68	L2	C-100	K11, K12
C-69	N6, N7	C-101	J13, J14
C-70	K16, L16	C-102	N3, N4

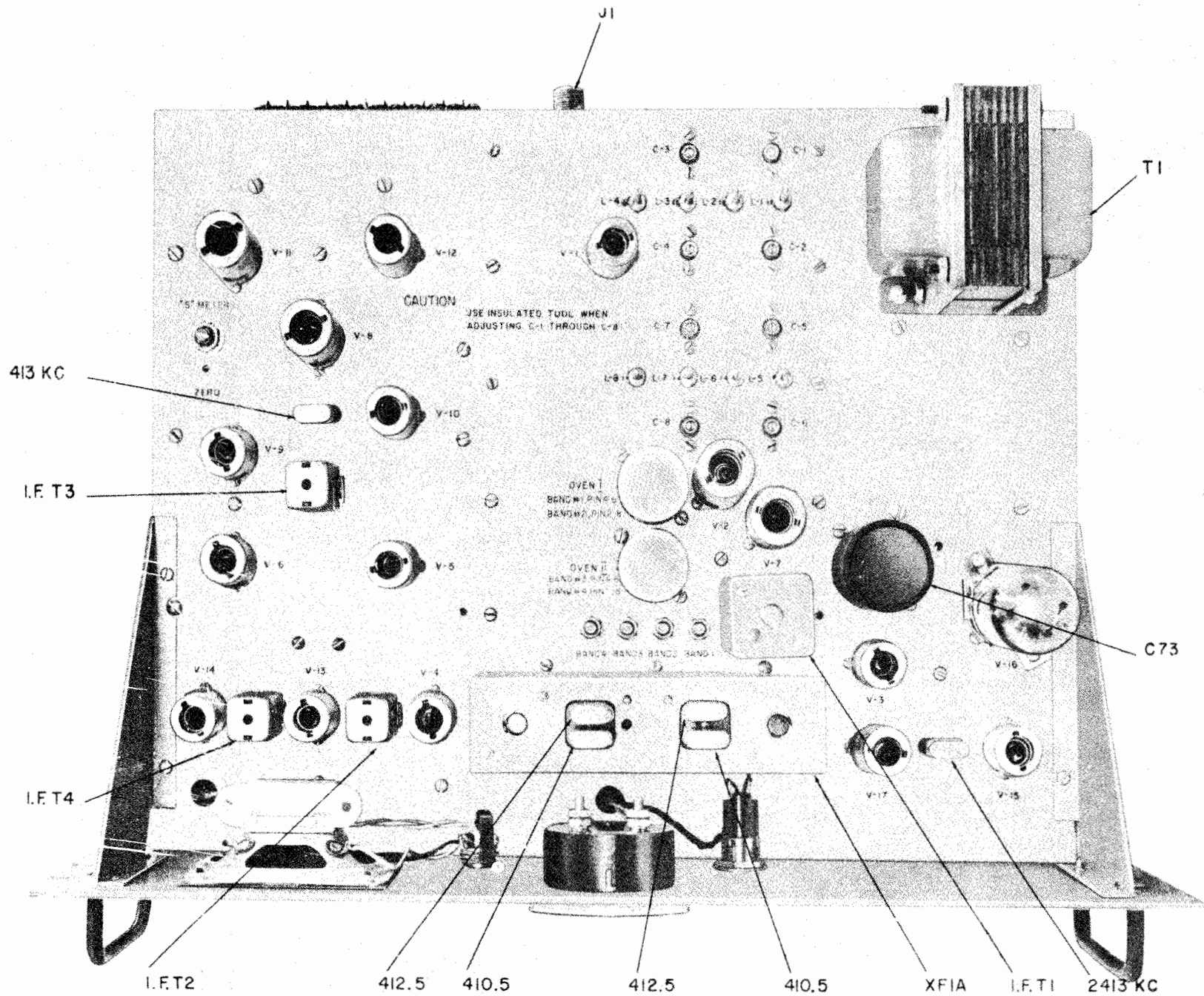

R-100 TOP VIEW



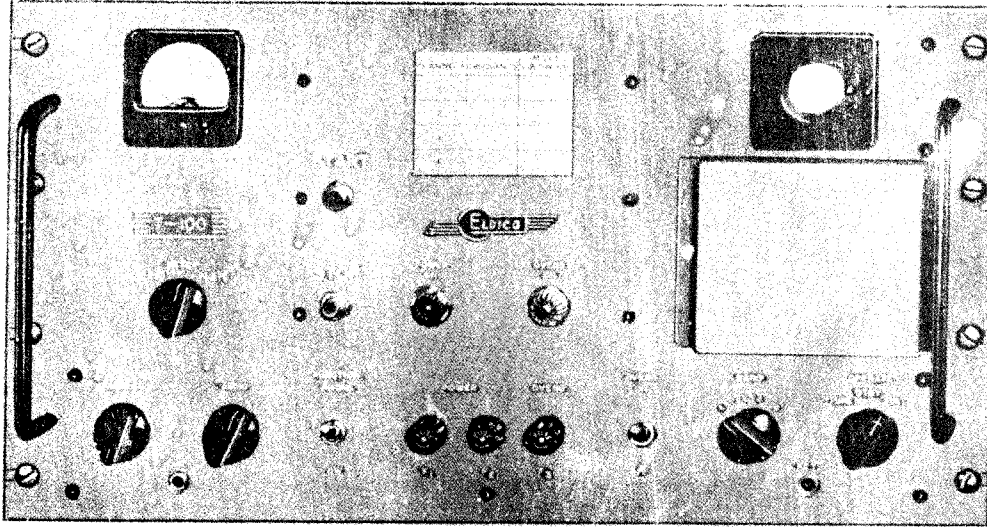

***T-100***

***Transmitter***

## SECTION I

### DESCRIPTION

#### 1.1 INTRODUCTION

- A. The T-100 Transmitter is a single sideband suppressed carrier transmitter of medium power. Incorporated in the unit are additional features so that the transmitter may be operated in the following modes; SSB, AM and CW. As a result, it is compatible with existing equipment, should operation in a mode other than single sideband be required.
- B. Frequency range of the transmitter is 2.2 to 30.0 megacycles in four pretuned channels, selectable by a front panel switch. All channels are controlled by crystal oscillators, using oven controlled crystals to furnish an added margin of stability where required. Peak envelope power is 100 watts, occupying a band width of three kilocycles, as compared with six kilocycles required by a conventional amplitude modulated transmitter. Output is normally lower sideband, suppressed carrier, unless otherwise preset.

#### 1.2 FEATURES

The T-100 Transmitter has been designed to provide the utmost in flexibility without compromising the performance characteristics up to now available only in highly specialized equipment. Among the features that contribute to the high grade performance of this transmitter are the following:

- A. Highly stable crystal filter type exciter section providing a minimum of 50 db unwanted sideband and carrier attenuation.
- B. Audio shaping for maximum intelligibility, sharp audio quality and conservation of valuable spectrum space.
- C. Inverse RF feedback for low distortion.
- D. Compact design includes all control circuits for S-100 system (if incorporated) plus receiver muting and antenna changeover.
- E. Built-in one inch oscilloscope for continuous monitoring of the linearity in all mixers and amplifiers between the exciter and power output stage.
- F. Preset frequency channels selected by front panel switch.
- G. Push-to-talk operation controlled by switch on microphone.

- H. Remote control operation if desired.
- I. 600 ohm line input.

### 1.3 SPECIFICATIONS

- A. Operating Frequency: 2.2 through 30.0 megacycles in four pre-tuned crystal controlled channels.
- B. Type of Transmission: Single sideband, suppressed carrier, one sideband with carrier (AM); Continuous Wave (CW).
- C. Power Output:
 

Peak envelope power:	100 watts
CW output:	50 watts
AM output (one sideband with carrier)	20 watts
- D. Unwanted Sideband: Unwanted sideband attenuation: 50 db or better.
- E. Carrier Attenuation: Carrier attenuation: 50 db or better.
- F. Distortion: Unwanted sideband distortion products, 35 db down or greater at full output.
- G. Transmitter Bandwidth: Approximately 3.3 Kc at 6 db points on voice signals.
- H. Transmitter Carrier Injection: Front panel controlled; from 50 db down to full rated power output, provided for tuning purposes, AM and CW operation.
- I. Audio Input: High impedance crystal or dynamic microphone (-55 db) on front panel.
- J. 600 ohm Input: Terminals provided on rear of chassis for 600 ohm line input at zero db maximum for full rated output.
- K. Transmitter Output: 52 ohms, unbalanced. (Transmitter output is applied to matching network M-100 when supplied.)
- L. CW Operation: CW operation provided, chirpless and clickless, consistent with modern engineering practice.

M. Metering and Monitoring:

Plate circuit meter provided, switchable with spring return for monitoring crystal oscillator section. A one-inch 1CP1 oscilloscope is provided, complete with associated circuitry for constant monitoring of the outgoing signal under all conditions of operation.

N. Physical Specifications:

Width: 19"  
Height: 10-1/2"  
Depth: 17"  
Finish: Eldico Gray

## SECTION II

### INSTALLATION

#### 2.1 UNPACKING

Open packing carton carefully to avoid damage to the equipment. Check all packing material for small packages. Inspect transmitter for signs of possible damage and check all panel controls for bent shafts and broken couplings. Any damage should be reported to the proper authorities at once, and original packing material should be preserved.

#### 2.2 LOCATION & MOUNTING

- A. While normally supplied as part of installation S-100, the T-100 transmitter could conceivably be used separately. In choosing a location, select a position convenient to the operator which is cool and dry. Allow sufficient clearance on back and sides to permit the free circulation of air.
- B. When used in installation S-100, the T-100 transmitter is furnished as part of a rack cabinet and is the center panel of the three.

#### 2.3 EXTERNAL CONNECTIONS

- A. RF Output: This is the antenna terminal, an 83-1R coaxial connector. In the S-100 system, this connector is fed to the antenna matching network (M-100) through a coaxial relay.
- B. 117 Volt AC Output: This convenience receptacle is controlled by the OVENS switch, SW-4A. In the S-100 installation, it is connected to the M-102 power supply.
- C. Terminal Strip, rear of chassis: The terminals are identified as follows:

Terminals 1, 2, 3 and 4: For remote connection of START-STOP switching and indicator light.

Terminals 5 and 6: 117 VAC supply, switched by push-to-talk switch on microphone. Supplies voltage to external antenna relay.

Terminal 7: Ground.

Terminal 8: Remote transmit control, connected between push-to-talk switch and ground in remote unit.

Terminals 9, 10 and 11: Receiver standby circuits; permit automatic quieting of receiver during transmit condition. Single pole, double throw contacts on internal relay. Numbers 10 and 11 are normally closed.

Terminals 12 and 13: Provide 6.3 volts for external ovens.

- D. Power Cord, rear of chassis: To be connected to 117 volts, 60 cps mains, or connected to terminal strip of M-102, if supplied.
- E. 600 Ohm Line: Provides input facility for phone patch operation. Requires zero db for full rated output.
- F. Microphone Input: This jack accommodates a dynamic, high impedance microphone. Push-to-talk circuits are incorporated
- G. Key Input: This jack is a closed circuit type which connects the grid-block bias keying circuit when key is inserted.

NOTE: DO NOT INSERT BOTH KEY AND MICROPHONE AT THE SAME TIME. THE CLOSED CIRCUIT FEATURES WILL PREVENT EITHER UNIT FROM OPERATING.

CAUTION: DO NOT OPERATE THIS EQUIPMENT WITHOUT AN EXTERNAL LOAD. EXCESSIVE RF VOLTAGES WILL DEVELOP, CAUSING SEVERE DAMAGE TO THE COMPONENTS.

It is suggested that the operator use a 52 ohm dummy load first to familiarize himself with the equipment. In case a dummy load is not readily available, a 60 or 100 watt, 110 volt light bulb will serve this purpose.

If used as part of the S-100 system, place the TUNE-OPERATE switch on the M-100 Antenna Tuner to the TUNE position. This will apply a built-in load to the transmitter and prevent the radiation of signals.

## SECTION III

### OPERATION

#### 3.1 CONTROLS

- A. OVENS Switch: This is the main AC power switch which controls voltage to all ovens in the transmitter and receiver. Also controls AC to receiver power circuits and M-102 Power Supply.
- B. START-STOP Switches: Control primary power to transmitter power supply circuits (plate, filament, bias, etc.).

WARNING: HIGH VOLTAGE IS PRESENT ON ALL CIRCUITS WHEN THE START SWITCH IS PRESSED, REGARDLESS OF THE POSITIONS OF OTHER FRONT PANEL SWITCHES.

- C. OPERATION Switch: In the standby position, no voltages are applied to the exciter, mixer and crystal oscillator stages. Blocking bias to the final amplifier provides plate current cut-off. In the TUNE position, a resistance is inserted in series with the screen grid of the final amplifier (V-13) to prevent excessive current drain, and a small amount of voltage is applied to keyer tube (V-6), which operates any necessary relays. In the TRANSMIT position, full voltage is applied to all operating circuits.
- D. FUNCTION Switch: Used to select the desired mode of operation. In the CW position, the audio circuits become inoperative. In the PHONE position, the audio circuits become operable, and the T-100 will operate in either AM or SSB, depending on the position of the CARRIER control.
- E. AUDIO Control: The AUDIO GAIN control should be adjusted for proper oscilloscope pattern. Gain increases with clockwise rotation.
- F. CARRIER Control: This control feeds carrier around the crystal filter for operation of AM, CW and tuning purposes. Carrier injection increases with clockwise rotation.
- G. METER Switch: This spring return switch normally reads plate current of the final amplifier tube. In the OSCILLATOR GRID position, it measures the grid current of the crystal oscillator (V-11) and is an indication of crystal activity.
- H. BAND SELECTOR Switch: This switch permits the operator to select any one of the four pretuned channels.

### 3.2 INITIAL ADJUSTMENT

#### A. Preliminary Control Settings:

- (1) Select the desired mode of operation, using the FUNCTION switch.
- (2) Select the desired band using the channel frequency chart on the front panel for reference.
- (3) Turn crystal OVENS switch to "ON" position. (Amber lamp will light.)
- (4) Press START button. (Red pilot lamp will light.)

### 3.3 CW OPERATION

#### A. For CW operation, proceed as follows:

- (1) Place OPERATE switch in XMIT position.
- (2) Place FUNCTION switch in CW position.
- (3) Press Key
- (4) Rotate CARRIER control clockwise. Plate current meter should read approximately 100 to 125 Ma.

NOTE: FOR CW OPERATION, IT WILL BE NECESSARY FOR THE OPERATOR TO TURN THE "OPERATE" SWITCH BACK TO THE "STBY" POSITION MANUALLY IN ORDER TO RECEIVE.

### 3.4 AM OPERATION

#### A. For AM operation, remove key and insert high impedance dynamic microphone in MIC jack. Then, proceed as follows:

- (1) Turn OVEN switch "ON".
- (2) Select desired channel, referring to frequency chart on front panel.
- (3) Place FUNCTION switch in PHONE position.
- (4) Press START button. (Red pilot lamp will light.)
- (5) Place OPERATE switch in XMIT position.
- (6) Press push-to-talk switch on microphone.
- (7) Observing oscilloscope, adjust CARRIER control for indication of 100 to 125 Ma. on plate current meter; then turn AUDIO control clockwise for proper pattern while speaking into microphone. (refer to illustration, top of next page.)





Unmodulated carrier  
or single tone.



AM pattern,  
60% modulation.



AM pattern  
100% modulation

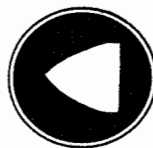

improper  
AM pattern  
reduce drive  
change loading.



AM pattern  
excessive bias on  
5894 stage.

### 3.5 SSB OPERATION

A. For SSB operation, proceed as follows:

- (1) Turn OVEN switch "ON".
- (2) Place Function switch in PHONE position.
- (3) Turn CARRIER control fully counterclockwise.
- (4) Select desired channel, using frequency chart on front panel.
- (5) Press START button. (Red pilot lamp will light.)
- (6) Place OPERATE switch in XMIT, press PUSH-TO-TALK switch on microphone, and while speaking into microphone, adjust AUDIO control for proper pattern on oscilloscope.



SSB pattern  
excessive bias on  
5894 stage.

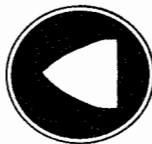

improper SSB pattern  
reduce drive  
change loading.



SSB pattern  
correct adjustment

## SECTION IV

### THEORY OF OPERATION

#### 4.1 GENERAL

The T-100 Transmitter may be regarded as a double conversion receiver in reverse. All circuits and conversion steps necessary to such a receiver are contained in the T-100, but the signal path follows the circuits in the opposite direction.

The audio signal is applied to the speech amplifier (V-1, 12AT7). This is a two stage amplifier, the output of which is controlled by the audio gain control (R-8). 600 ohm line input is fed into the second stage cathode through an input network. Audio output is then applied to V-2 (12AT7), a balanced modulator. Carrier injection to the modulator is supplied by V-7 (12AT7).

In order to reinsert carrier without disturbing the crystal filter, the cathode resistor of V-7 is made variable, making it possible to tap off the correct amount of carrier voltage for reinjection beyond the crystal filter. This is used for CW and AM operation.

V-2, the balanced modulator, is actually a balanced mixer. Carrier is fed into the cathodes driving the 12AT7 (V-2) in push-push. The plate circuit is connected in push-pull and is tuned to 413 Kc. With this type of circuit, provided that tube gains, voltages, etc., are properly matched, the carrier voltage can be adjusted to more than 50 db down with R-13 (carrier balance control).

Audio is applied in a push-pull manner to the grid, heterodyning against the carrier, producing sum and difference frequencies between audio and carrier. (The balanced modulator also functions as an audio phase inverter.) The phase relationships are such that these mixer products appear in the proper phase to cause signal voltages to appear in the plate circuit of the 12AT7 (V-2). The result of this is that the mixer products (sidebands) appear in the plate circuit, while leaving the carrier suppressed.

The double sideband signal is then passed through a crystal lattice filter which removes the higher order sidebands and passes only the lower sideband. At the output of the crystal lattice filter, the single sideband signal is fed into the mixer (V-3, 6BA7). For amplitude modulation, some of the 413 Kc which was removed by the balanced modulator is also fed into the mixer, so that an AM signal (one sideband plus carrier) is obtained. The signal (SSB) is mixed with a crystal controlled signal in V-3 (6BA7) for output at 2.0 Mc at T-1.

The crystal filter is a more elaborate version of the type found in most communications receivers. The crystals are used to provide steep skirts to the selectivity curve, while maintaining a relatively flat top.

Crystals at the output of the filter serve as series resonant traps to increase the sideband and carrier attenuation. The passband of this filter is approximately 3 Kc.

**CAUTION: NO READJUSTMENT OF THE FILTER SHOULD BE ATTEMPTED. CRYSTALS SHOULD NOT BE REMOVED OR REPLACED. ANY ATTEMPT TO ADJUST THIS FILTER WILL RESULT IN SERIOUSLY DEGRADED PERFORMANCE.**

As the T-100 normally operates in the lower sideband, the 413 Kc single sideband signal is mixed with a 2413 Kc signal in V-3, which gives a 2000 Kc lower sideband signal. Output of this mixer is then applied to a 2.0 Mc IF transformer which suppresses unwanted mixer products.

The signal next enters V-4 (12AT7), a cathode follower and grounded grid amplifier combination. Signal is taken from the common cathode of this tube and fed into the power amplifier chassis. Part of the same signal is fed into the envelope detector (V-5) after being amplified in the grounded grid amplifier.

Some of the signal is detected in V-5 in order to provide two different types of output. One, the envelope of the SSB signal, is applied to the 6AU6 (V-8) deflection amplifier. The DC component of the signal from V-5 is also applied directly to the grid of the 1CP1 oscilloscope tube (V-9) to provide automatic beam intensification when signal is present.

A single sideband signal at 2.0 megacycles enters the power amplifier chassis through R-87, C-46, L-2 and C-47 input network. This is actually a pi-network in reverse and steps up the input signal voltage to the grid of the second mixer, V-10 (6X8).

Conversion to the desired output frequency takes place in the 6X8 (V-10). Injection voltage is supplied by V-11, a 12AT7 connected in parallel. The plate circuit of V-10 is tuned to the desired output frequency.

## 4.2 DRIVER AND POWER AMPLIFIER

The driver and power amplifiers consist of a 12BY7A (V-12) and a 5894 (V-13) respectively. The driver is a pentode, and the 5894 a dual beam tetrode. The 12BY7A driver operates in Class A and the amplifier in Class AB1. This allows linear operation without distortion. Previous to this point, neutralization was not required, because the output of various stages were not tuned to the same frequency, the gain of a particular stage was low, or the stage was inherently stable. However, these final stages DO require neutralization, as the gain is quite high and the input and output frequencies are always the same. These stages are much more susceptible to feedback via the grid-plate capacity and, therefore, bridge neutralization is employed. To further assure linearity, inverse feedback is used around to the 12BY7A driver cathode, reducing further any distortion of the emitted wave.

## 4.3 CW AND AM SIGNALS

AM signals are produced in the following manner: Carrier is reinserted into the signal channel around the crystal filter. This is added to the previously formed single sideband signal, producing single sideband with carrier which can be received

in the ordinary manner. For all practical purposes, this signal is identical with an AM signal.

For CW signals (function switch in CW position), the audio circuits are disabled. Carrier is reinserted with the carrier control to obtain the proper level. Keying is accomplished through grid block keying applied to V-4 and V-12.

#### 4.4 OSCILLOSCOPE

The oscilloscope provides comparison with the envelope of the low level single side-band signal and RF voltage present at the plate of the final stage. This is accomplished by first detecting the signal coming from V-4 (pin 6) and amplifying the detected signal. This amplified signal is then applied to the horizontal deflection plates of the 1CP1 oscilloscope.

The RF signal at the plate is picked up by a coupling capacitor from the plate of the final amplifier and applied to the vertical deflection plate of the 1CP1. To furnish automatic beam intensification, the DC component of the signal is rectified and applied to the control grid of the scope. The oscilloscope intensity potentiometer should be set so that the screen is blanked out when a "no signal" condition exists.

#### 4.5 POWER SUPPLY

The power supply delivers three operating voltages. High voltage for the final amplifier and oscilloscope, medium voltage for lower level stages and the screen of the final amplifier, also bias voltage for operating bias and blocking bias. High voltage is rectified by V-16 (5R4), medium voltage is rectified by V-17 (5U4), and bias voltage by SR-1 and SR-2, selenium rectifiers. All supplies are properly filtered for excellent regulation, and have low ripple. Across the medium voltage supply are two voltage regulator tubes, V-15 (OB2) and V-14 (OA2). These supply regulated voltage to the 6X8 (V-10) mixer, 12AT7 (V-11) crystal oscillator, V-7 (12AT7) carrier oscillator, and the screen of the 6BA7 (V-3) converter.

#### 4.6 CONTROL CIRCUITS

Main AC power is controlled by a latching relay, RL-2, RL-3. Pressing the START button actuates RL-3 which is then held closed by the latch on RL-2. Pressing the STOP button actuates RL-2 whose armature pulls in, releasing the RL-3 armature, removing primary voltage from T-2. Application of blocking bias, plate voltage and switching, etc., is accomplished by RL-1 which is controlled by the keyer tube (V-6). Operation of V-7 is as follows: Cut-off bias is applied to the grid through R-3, from the bias supply, with voltage divider R-28 and R-29 in series to ground. When plate voltage is present as controlled by the OPERATE switch, it is fed in series with the relay coil and R-32 current limiting resistor. Short-circuiting R-29 to ground reduces the amount of grid bias to a value permitting plate current to flow, thereby closing the relay. When the OPERATE switch is in TUNE position, B+ voltage is applied to V-6 grid through a 2.4 megohm resistor. This again reduces grid bias, allowing the relay to close.

## M-102

Bias voltage for carbon microphone operation is provided by the DC supply, M-102. Basically, it consists of a power transformer (ET-345), bridge rectifier (SR-3), filter choke (EC-346), filter capacitor (C-116) and load resistor (R-85). The output voltage is 12 volts (nominal) at 700 Ma continuous duty.

Part of the M-102 is a terminal strip used as a tie point for remote control connections as well as audio input and output.

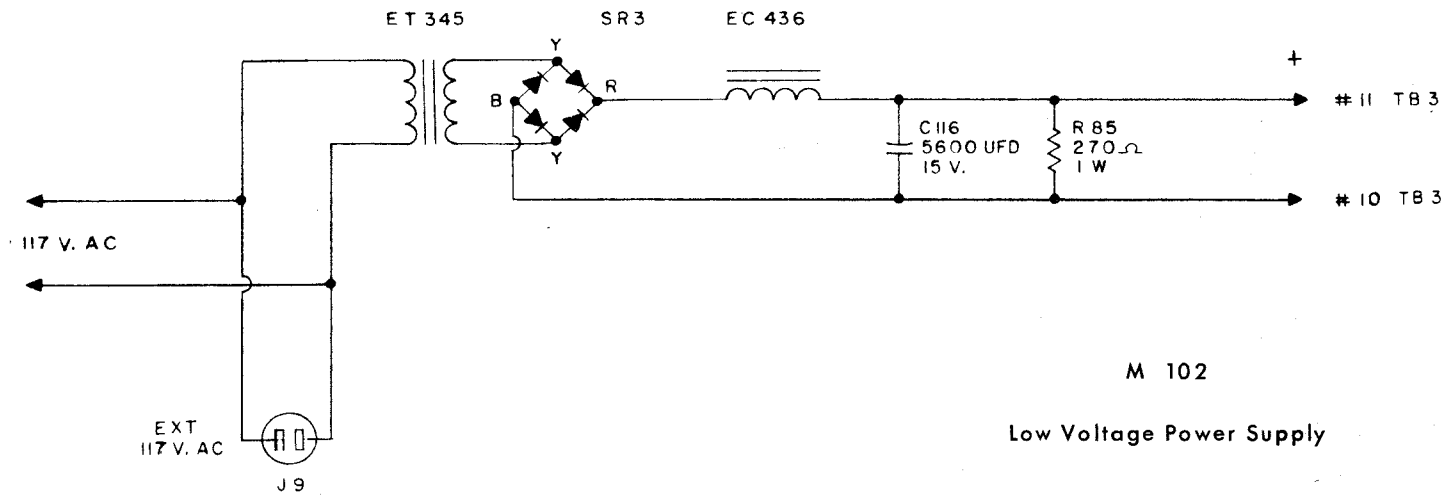

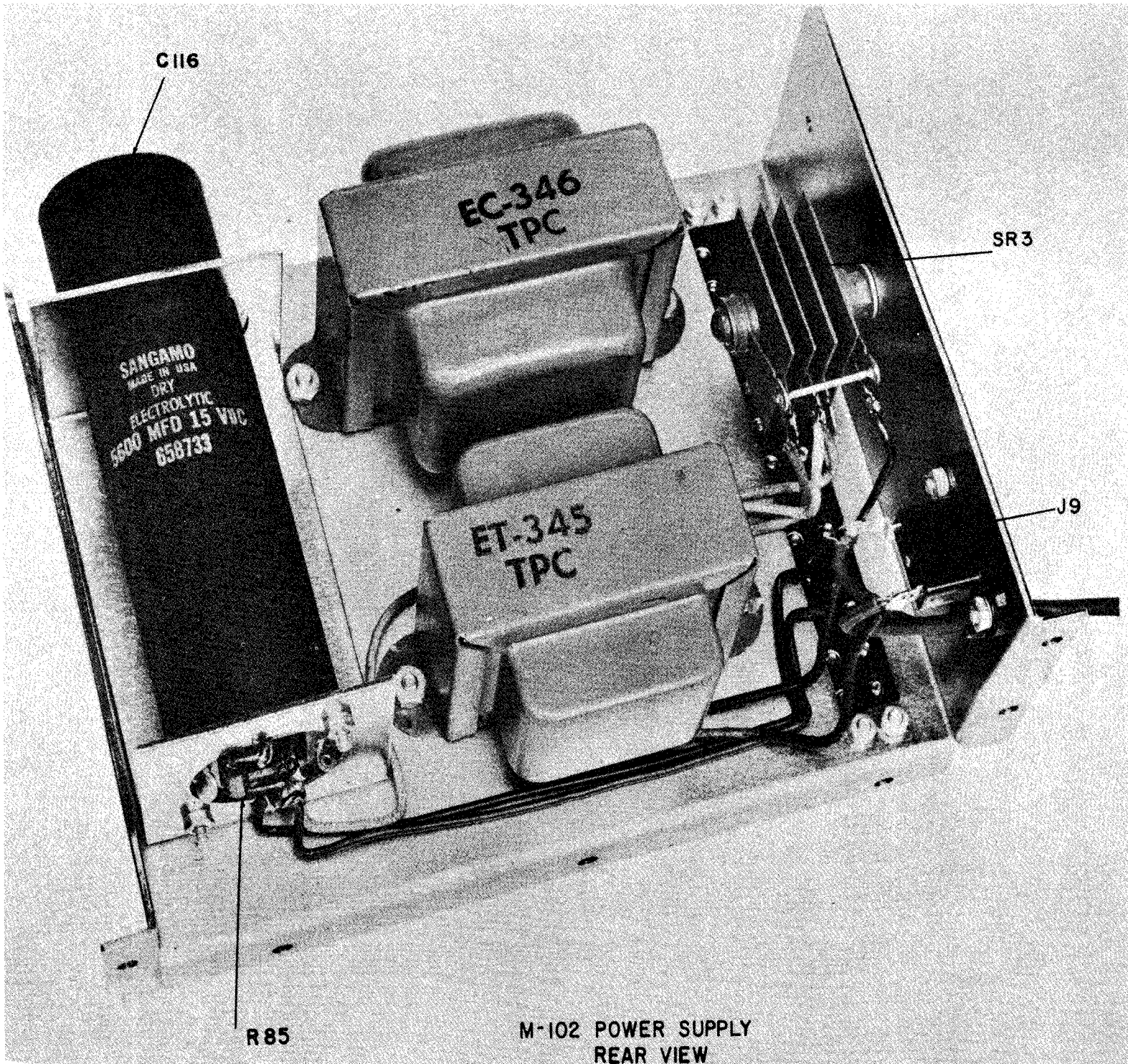

C116

EC-346  
TPC

SR3

SANGAMO  
MADE IN USA  
DRY  
ELECTROLYTIC  
6500 MFD 15 VDC  
658733

ET-345  
TPC

J9

R85

M-102 POWER SUPPLY  
REAR VIEW

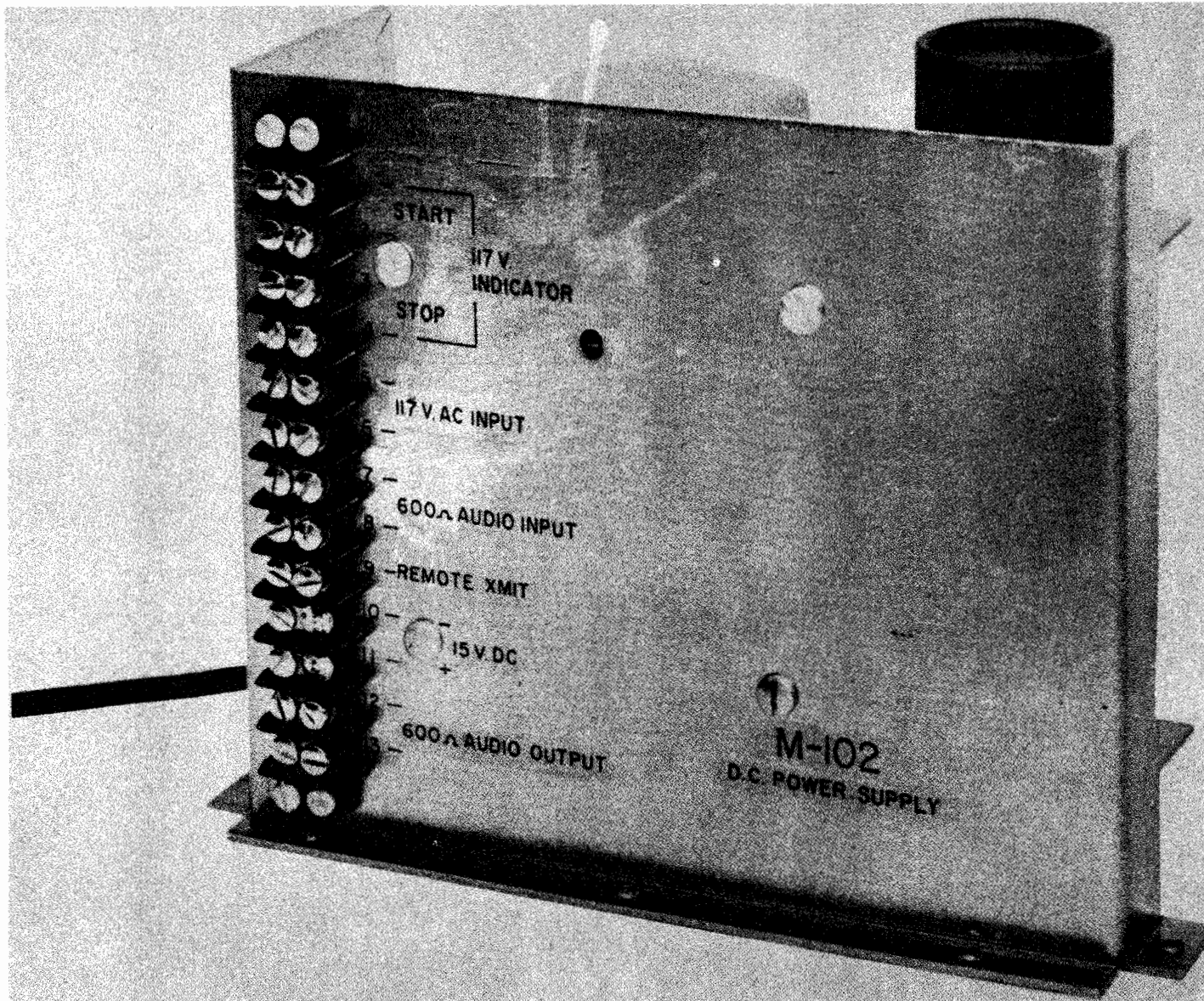

FRONT VIEW

## SECTION V

### MAINTENANCE

#### 5.1 SERVICE ADJUSTMENTS

Initial tune-up procedure of the T-100 is not difficult, providing care is used in setting up the proper circuits. Crystals used in the high frequency oscillator are 2.0 megacycles higher than the desired output carrier frequency. On some bands it will be possible to tune the mixer and driver stages to the crystal frequency. When this occurs, it will not be possible to reduce plate current to a normal idling value of 40 Ma with the carrier control.

NOTE: MOVING THE ADJUSTING SLUG INTO THE COIL OR INCREASING THE TUNING CAPACITY WILL REDUCE THE RESONANT FREQUENCY OF A TUNED CIRCUIT.

#### 5.2 RECOMMENDED EQUIPMENT FOR MAKING ADJUSTMENTS

- A. Signal generator of reasonable accuracy, with an output of approximately .5 volts minimum at the desired output frequency.
- B. Power output indicator (if available).
- C. 52 ohm load. (Load built into M-100 Antenna Tuner can be used.)

#### 5.3 PROCEDURE

- A. Connect signal generator to TEST INPUT jack.
- B. Connect power output indicator between transmitter output jack and antenna tuner input.
- C. Set TUNE-OPERATE switch on M-100 to TUNE position.

NOTE: IF M-100 IS NOT AVAILABLE, CONNECT POWER OUTPUT INDICATOR BETWEEN TRANSMITTER OUTPUT TERMINAL AND 52 OHM DUMMY LOAD (two 100 ohm, 25 watt, non-inductive resistors in parallel).

- D. Turn OVEN switch "ON".
- E. Press START button.
- F. Rotate CARRIER control fully counterclockwise.



- G. Rotate AUDIO GAIN control fully counterclockwise.
- H. Place FUNCTION switch to PHONE position.
- I. Ground Lug 8 on rear terminal strip (TB-2).
- J. Place OPERATE switch in XMIT position.
- K. Adjust plate current to 40 Ma using control located at top of chassis near final tank coil. (Bias control R-72)
- L. Remove crystal oven associated with band to be adjusted.

M. Select proper channel using BAND SELECTOR control.

Ch.	Freq. Range	Mixer L/C	Driver L/C	Final Cap	Load. Cap	Xtal Trimmer
1	2.2-4.1 Mc	L3, C54	L7, C74	C89	C93	C58
2	4.1-10.0 Mc	L4, C55	L8, C75	C92	C94	C59
3	6.0-16.0 Mc	L5, C56	L9, C76	C90	C95	C60
4	11.0-30.0 Mc	L6, C57	L10, C77	C91	C96	C61

**CAUTION:** USE ONLY AN INSULATED TOOL FOR TUNING ADJUSTMENTS. HIGH VOLTAGE PRESENT ON TUNING CAPACITORS AT ALL TIMES.

- N. Increase signal generator output until plate meter indicates. If circuits are badly out of resonance, no plate reading may be had, or a very slight reading will be obtained. In all cases, keep plate current reading below 120 Ma by reducing input from signal generator.
- O. Tune 12BY7A (V-2, Driver) plate to resonance. This will be indicated by an upward swing on the meter. Tuning slugs and capacitors are located on the top of the chassis at the rear of the final tank assembly. With coil slugs rotated fully upward out of the coils, adjust the tuning capacitor through its 180 degree range and peak at the greatest plate current value. Keep plate current below 120 Ma as in Section N, above. In the event that a peak cannot be found, readjust coil slug two turns into coil and readjust capacitor. Adjust for maximum indication on plate meter.
- P. Set slugs in mixer coils to approximately the same height as was found in operation O and tune the associated condensers for maximum amplitude. Keep plate current below 120 Ma by reducing signal generator input.

**NOTE:** SLOTS ON TUNING CAPACITORS WILL INDICATE EITHER MAXIMUM OR MINIMUM CAPACITANCE WHEN SET SO THAT THEY FALL ON A LINE WITH THE CAPACITOR MOUNTING SCREWS. SLUGS AND CAPACITORS SHOULD BE ADJUSTED SO THAT THERE IS AN ADDITIONAL TUNING RANGE IN BOTH.

- Q. Insert proper crystal for band chosen in oven and replace oven in socket. Locate crystal according to screening on chassis as to pin connections for the desired channel.

- R. Remove signal generator.
- S. Turn loading capacitor under front panel cover fully clockwise (maximum capacity).
- T. Turn final tank capacitor (located on final assembly shield) to maximum capacity.
- U. Advance CARRIER control so that plate meter indicates a reading below 120 Ma.
- V. Readjust slugs for maximum plate reading, reducing current if necessary by turning CARRIER control counterclockwise.
- W. Increase plate current to approximately 135 Ma with CARRIER control, then quickly resonate plate circuit with final tank capacitor. Plate current should dip as resonance is reached.
- X. Reduce capacity of loading condenser slightly. Then re-resonate plate tank. Continue this procedure until approximately 125 Ma plate current is indicated at resonance. At this point, the power output indicator should read maximum output. In the event that resonance cannot be reached with the plate tuning capacitor, move the top of the plate coil up for less inductance, or down for more inductance.
- Y. Adjust C-89, C-92, C-90, C-91 on each band so that power output will be approximately the same as each channel is selected. After adjusting these condensers, repeak 12BY7A circuit and recheck output. The transmitter is now adjusted for one preselected channel. Repeat the same procedure for the other three channels.
- Z. Remove ground from Lug 8 on rear terminal strip (TB-2).

#### 5.4 MISCELLANEOUS ADJUSTMENTS

- A. Carrier Balance Control: This should only be adjusted if there is definite evidence of carrier present in the signal when operating in the SSB mode, or if the 12AT7 balanced modulator is required. To adjust, set all controls as indicated in Paragraph 1.5, Section I for SSB operation. With CARRIER control counterclockwise, press push-to-talk switch. Tune in the carrier on a monitor receiver and adjust CARRIER balance control R-13 for minimum output. If minimum cannot be found (the null is very sharp), try another 12AT7 as this circuit is rather critical as to tube balance. Very little difficulty should be experienced with normal tubes, however.
- B. Oscilloscope Blanking Control: Located on the oscilloscope chassis is potentiometer R-81. Rotate this control so that when push-to-talk is pressed and AUDIO CARRIER controls are counterclockwise, the dot appearing on the face of the oscilloscope is just blanked out.

**CAUTION: DO NOT ATTEMPT ANY ADJUSTMENTS TO THE EXCITER UNIT. ADJUSTMENTS ARE EXTREMELY CRITICAL AND ARE PRESET AT THE FACTORY. ANY VIOLATION OF THIS CAUTION WILL UNDOUBTEDLY**

RESULT IN SEVERE DOWNGRADING OF THE PERFORMANCE OF THE UNIT.

- C. Crystal Trimmers C-58, C-59, C-60 and C-61:° These trimmers are connected across the crystals so that they may be set exactly on frequency using a receiver and a frequency standard. To adjust, set transmitter up for AM operation, turn AUDIO control counterclockwise and advance carrier until signal is heard. Then rotate associated trimmer for zero beat with frequency standard.

#### .5 REMOVAL OF V:13, FINAL AMPLIFIER

- A. Push STOP button.
- B. Remove panel/cabinet bolts.
- C. Remove four screws holding perforated shield to final assembly.
- D. Short plate connections of 5894 (V-13) to ground with insulated hand screwdriver.
- E. Remove plate clips.
- F. Lift tube straight up, tilt and remove.
- G. To reinsert, reverse the above procedure.

## TROUBLE SHOOTING CHART

SYMPTOM	POSSIBLE DEFECT
OVENS pilot lamp does not light.	Replace fuse F-3. Replace pilot lamp I-2. Loss of AC line voltage.
START button does not actuate relay. Relay "chatters" (does not hold in).	Replace fuse(s) F-1 and/or F-2. Hold-in armature binding or rubbing on START armature. Free and apply light grease (lubriplate) as required.
Tubes light, no output in any mode.	Bad rectifiers, relay contacts dirty and/or relay tube defective.
Low output.	Defective crystal, defective tubes, unit improperly tuned to frequency and/or relay contacts dirty.
Carrier cannot be balanced out.	Check V-2. Change if defective.
Radio telephone output is low.	Check V-1 and/or microphone circuits.
No horizontal deflection on oscilloscope.	V-8 or V-5 defective. Check and replace as required.
Push-to-talk circuits no operating.	Resistor R-32 increased in value. Tube V-6 and/or microphone incorrectly wired. Check and correct.
Oscilloscope does not blank.	V-5 defective or intensity control R-81 set too high.
Low output on all modes.	Defective tubes, L-2 detuned, defective crystal, or crystal oscillator V-11, or circuits improperly aligned.
Plate current abnormally high.	SR-1, SR-2 defective. Relay contacts defective. Bias control (R-72) improperly set.
No crystal current.	Crystal defective. Crystal improperly inserted in crystal oven. V-11 defective.
Transmitter does not load on one or more bands.	Loading capacitors C-93 to C-96 shorted. Load impedance incorrect (should be approximately 52 ohms).

SYMPTOM

POSSIBLE DEFECT

No plate current reading.

Relay contact dirty. V-13 defective.  
R-68 or R-66 open.

In case of difficulty, if the transmitter has been properly aligned and given proper service before troubles developed, we recommend that tubes be checked initially and that readings be taken and compared with voltage and resistance charts located elsewhere in this manual.

If possible, attempt to isolate the problem to a particular stage and compare readings in that stage with readings given.

It is understood that the operator is familiar with front panel controls.

# PARTS LOCATIONS

## EXCITER CHASSIS

NOTE: Refer to bottom view of Exciter Chassis for following locations.

R-1	E20	R-29	F16, F17
R-2	C21	R-30	E15
R-3	D20	R-31	E16
R-4	E19	R-32	D15, E15
R-5	E21	R-33	H21, H22
R-6	D22	R-34	H21
R-7	E9	R-35	H23
R-8	D23, E24	R-36	F21
R-9	F20	R-37	F22
R-10	F19, F20	R-38	H23, H24
R-11	F19	R-39	F22, F23
R-12	G19	R-90	H4
R-13	F18	R-91	E2
R-14	G19, G20	R-92	E9
R-15	H19	R-93	E2
R-16	J16		
R-17	H8	C-1	E20
R-18	G9	C-2	D9, E9
R-19	G7	C-3	F9
R-20	G7	C-4	D21, D22
R-21	G6	C-5	E22
R-22	G4, H4	C-6	F22
R-23	H4	C-7	H21
R-24	F5, G5	C-8	H21, H22
R-25	F5	C-9	J19
R-26	F4, F5	C-10	J16, J17
R-27	D5, E5	C-11	H7
R-28	E17	C-12	H7

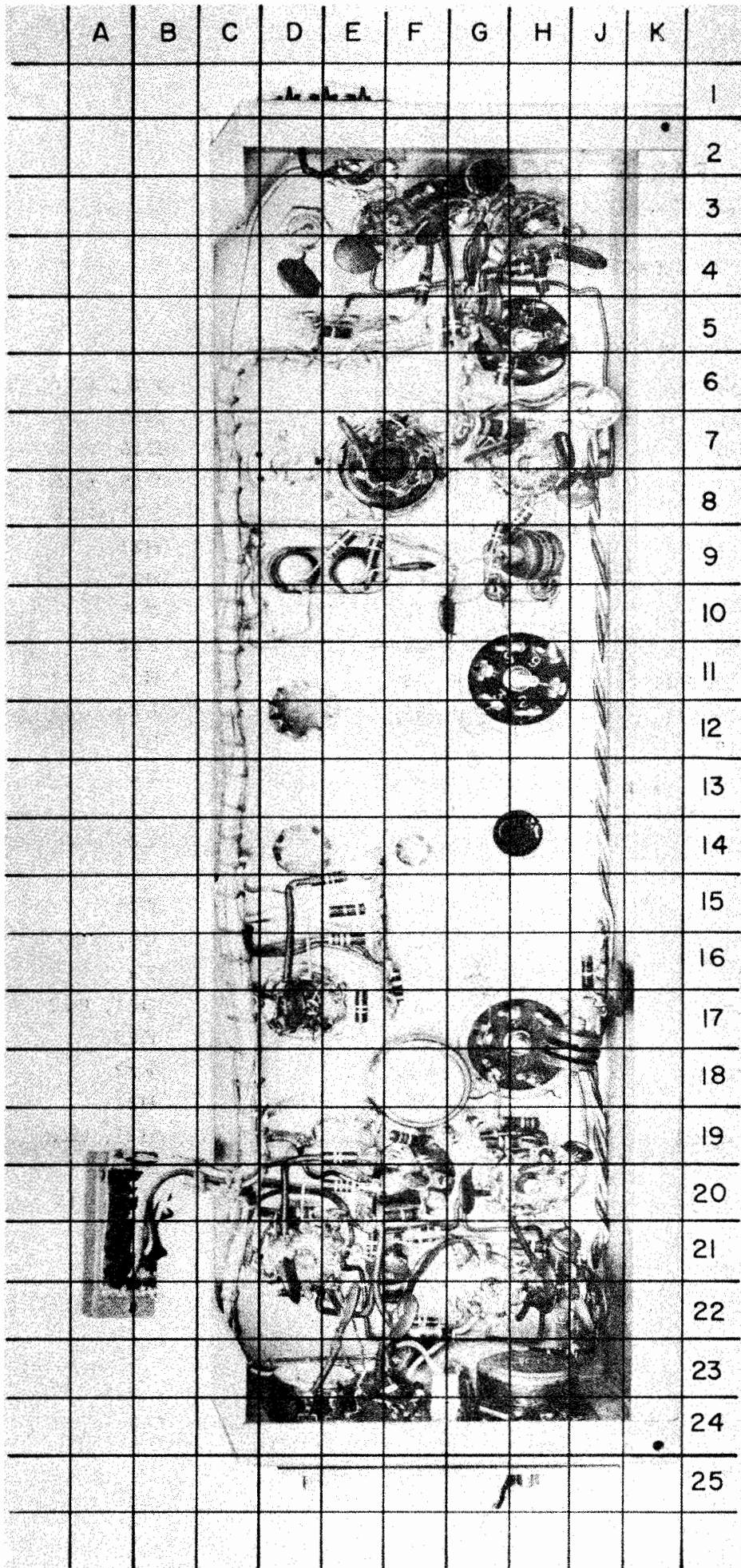

T-100 EXCITER SECTION  
BOTTOM VIEW

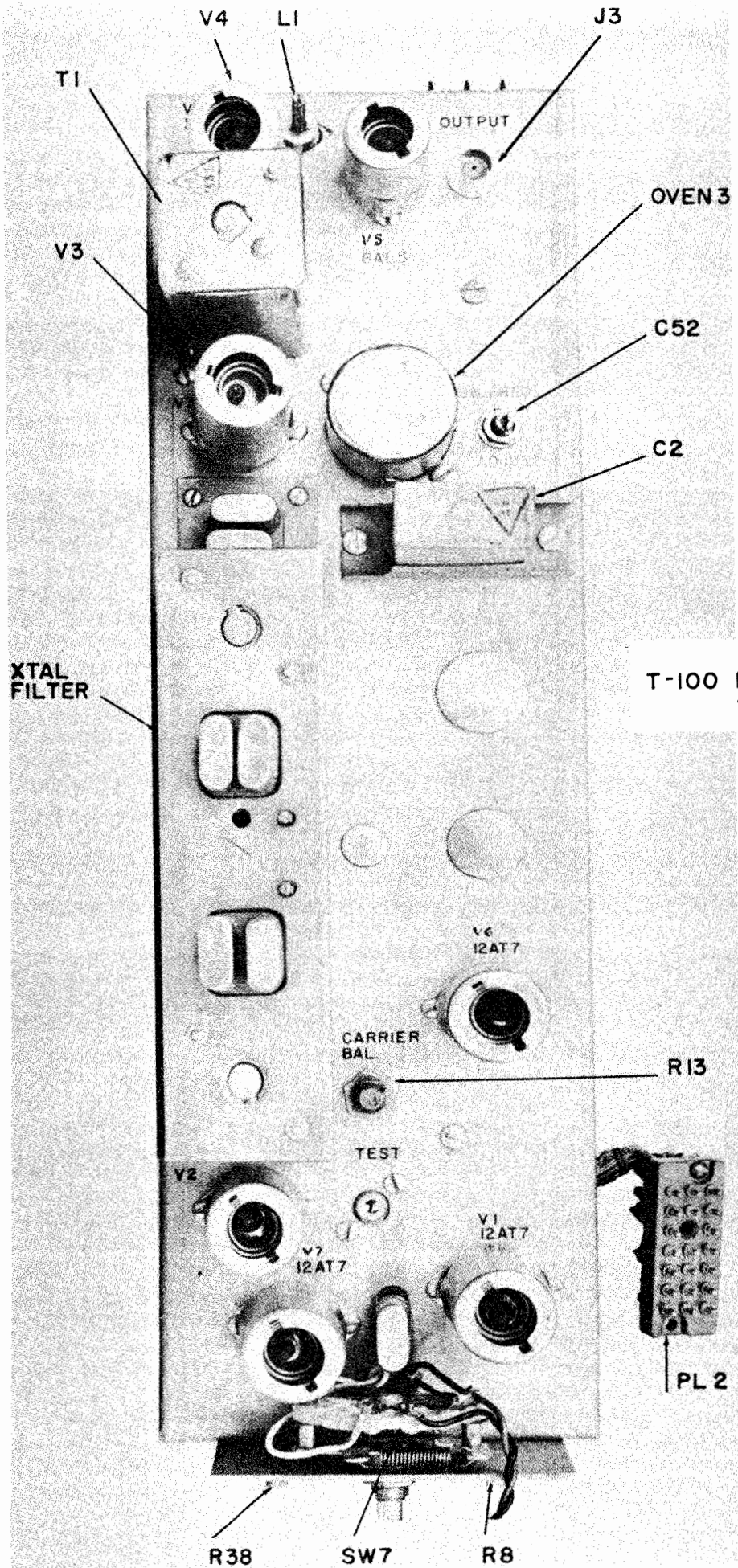

T-100 EXCITER SECTION TOP VIEW



C-13	G7	C-33	H8, J8
C-14	G4, G5	C-34	G3, G4
C-15	G5	C-35	E4
C-16	Inside T-1	C-36	D17
C-17	Inside T-1	C-37	K21, K22
C-18	J4	C-52	D7, D8
C-19	D4	C-114	G9, H9
C-20	F3	C-116	E7
C-21	F3		
C-22	F3, F4	RFC-1	H17, J17 H18, J18
C-23	F3	RFC-2	J6, J7
C-24	E5	RFC-9	H9
C-25	J22		
C-26	F21	L-1	G2, G3
C-27	F22	J-1	F23, F24
C-28	F21	J-2	F20
C-29	G19	J-3	D3, D4
C-30	F10	PL-1	A20, A21
C-31	E31, F31	TB-1	D1, E1
C-32	G20		

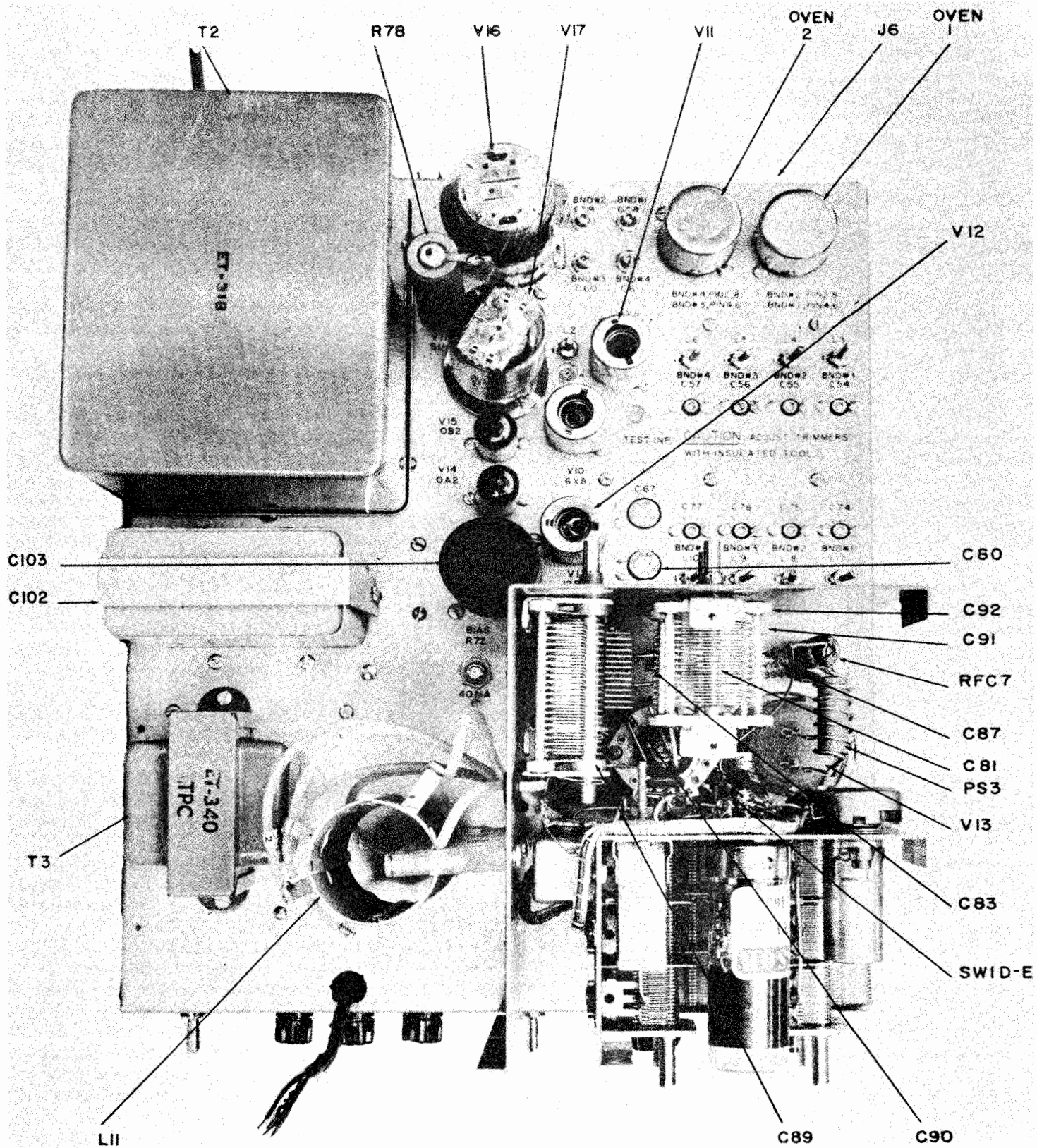

T-100 TRANSMITTER  
TOP VIEW

## PARTS LOCATIONS

### OSCILLOSCOPE CHASSIS

NOTE: Refer to the Oscilloscope Chassis view for the following parts.

R-40	D8, E8
R-41	E8, F8
R-42	D4, E4
R-43	D9, D10
R-44	K25, L25
R-45	H17, J17
R-46	J15, K15
R-47	G13, G14
R-48	F10, G10, H10
R-81	M6
C-38	J19, M19
C-39	C6, D6
C-40	J23, N23
C-41	H15
C-42	F20
C-43	H13
C-44	D13
C-45	E10
C-104	H4
C-105	N13
V-8	F6
V-9	K13

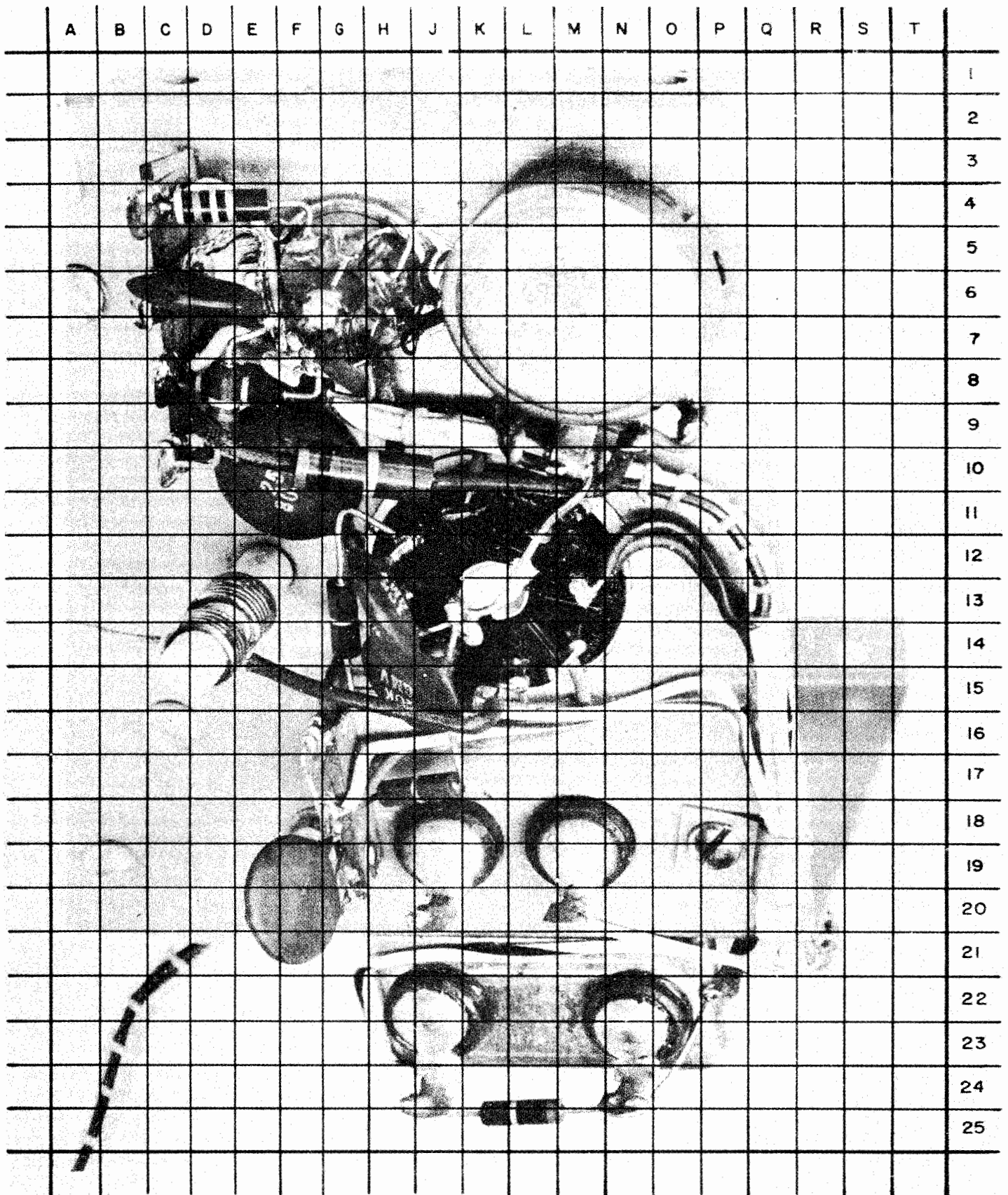

OSCILLOSCOPE CHASSIS  
REAR VIEW

## PARTS LOCATIONS

### POWER SUPPLY CHASSIS

NOTE: Refer to the bottom view of the Power Supply Chassis for the following parts.

R-49	K21	R-78	On top of chassis
R-50	L10, L11	R-79	P15, P16
R-51	K12	R-80	Q18
R-52	M12	R-82	S21, T21
R-53	L11	R-83	J11, J12
R-55	K12	R-86	L19
R-56	J8	R-87	L9, L10
R-57	H8, H9	R-88	H12
R-58	K8	R-89	H18
R-59	L8		
R-60	M11	C-46	M8
R-61	L12	C-47	L9
R-62	L12	C-48	J11
R-63	J15	C-49	M12
R-64	K17	C-50	K10
R-65	K16	C-51	L11
R-66	F23	C-53	B9
R-67	F25	C-54	B11
R-68	E21	C-55	D11
R-69	C25, D25	C-56	E11
R-70	W21, W22	C-57	G11
R-71	K21	C-58	J4
R-72	O20	C-59	K4
R-73	Z23	C-60	K6
R-74	Z23	C-61	J6
R-75	Z23	C-62	G8
R-76	Z23	C-63	K8
R-77	S20	C-64	J10

C-65	O11	C-101	V20
C-66	L12	C-102	T17, W17
C-67	H14, H15	C-103	M17, N17
C-69	K12	C-106	K12
C-70	L15	C-107	J9
C-71	J20	C-108	L15, M15
C-72	K17	C-109	B24
C-73	B17	C-110	Z17
C-74	B15	C-111	Z17
C-75	D15	C-112	E4
C-76	E15	C-113	B6
C-77	G15	C-114	M12
C-78	J19	C-115	Across meter
C-79	G16	C-117	H21, J21
C-80	H16	C-118	H21, J21
C-81	Top of chassis	C-119	H21, J21
C-82	H16	C-120	H21, J21
C-83	Top of chassis	C-121	H14, J14
C-84	K21	C-122	K7
C-85	G24	C-123	G6
C-86	E20		
C-87	Top of chassis	SW-1F	H20, J20
C-88	Top of chassis	SW-1E	Top of chassis
C-89	Top of chassis	SW-1D	Top of chassis
C-90	Top of chassis	SW-4	M31
C-91	Top of chassis	SW-5	P26, R26
C-92	Top of chassis	SW-3	Y31
C-93	Top of chassis	SW-2	D31
C-94	Top of chassis		
C-95	Top of chassis	J-7	F31
C-96	Top of chassis	J-8	K2, L2
C-97	V20		
C-98	Z19	RLY-1	U26-29
C-99	Z22	RLY-2	Q23
C-100	F30	RLY-3	P26

TB-2	N-W1	Oven-1	C5
		Oven-2	F5
CH-1	W13		
CH-2	W8	V-10	K11
		V-11	J9
T-2	Top of chassis	V-12	K15
T-3	Top of chassis	V-13	D23
		V-14	N14
PL-2	Z27	V-15	N12
		V-16	M5
SR-1	R20	V-17	N10
SR-2	R20		

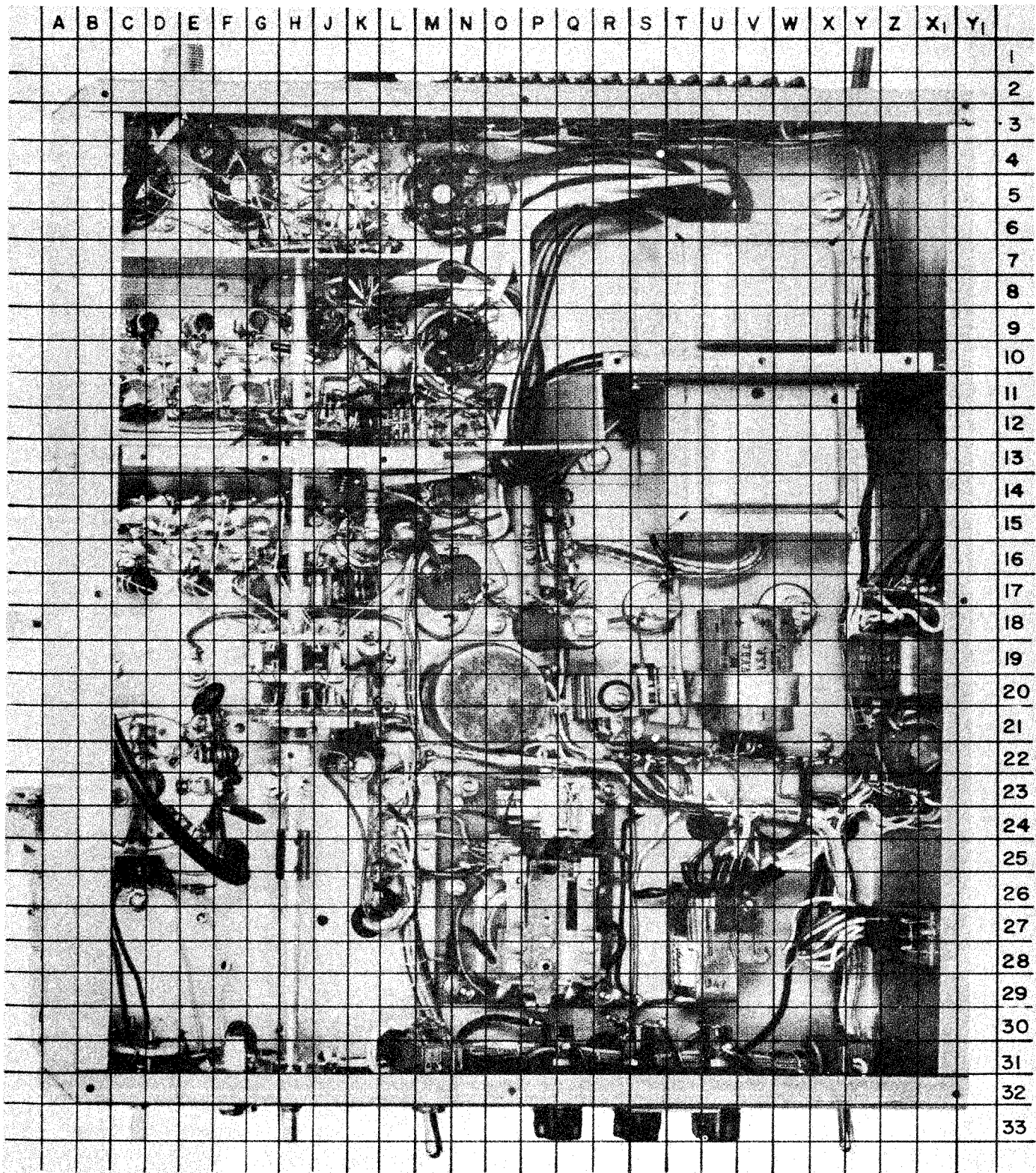

POWER SUPPLY CHASSIS  
BOTTOM VIEW



## VOLTAGE CHARTS

TUBE		PIN 1	PIN 2	PIN 3	PIN 4	PIN 5	PIN 6	PIN 7	PIN 8	PIN 9
V-1	12AT7	55	0	1	6.2AC	6.2AC	154	0	2.35	0
V-2	12AT7	325	.73	10.4	6.2AC	6.2AC	328	.33	10.4	0
V-3	6BA7	106	-10.8	.42	0	6.2AC	0	-1.45	0	345
V-4	12AT7	332	0	4.45	6.2AC	6.2AC	342	0	4.45	0
V-5	6AL5	.45	-.28	0	6.2AC	0	0	0	-	-
V-6	12AT7	185	-3.8	0	6.2AC	6.2AC	185	-3.8	0	0
V-7	12AT7	54	-47	0	6.2AC	6.2AC	305	0	10.5	0
V-8	6AU6	0	0	0	6.2AC	145	105	2.3	-	-
V-9	1CP1	6.2AC	760	640	640	.44	640	28.5	0	-
V-10	6X8	0	0	245	6.2AC	0	7.2	-8.4	145	245
V-11	12AT7	145	-23.5	1.45	6.2AC	6.2AC	145	-23.5	1.45	0

TUBE		PIN 1	PIN 2	PIN 3	PIN 4	PIN 5	PIN 6	PIN 7	PIN 8	PIN 9
V-12	12BY7A	1	-2.3	0	6.2AC	6.2AC	0	373	197	0
V-13	5894	6.3AC	-41.5	373	1.95	0	-41.5	6.3AC	-	-
V-14	OA2	150	0	0	0	150	0	0	-	-
V-15	OB2	255	150	0	150	255	0	150	-	-
V-16	5R4	0	850	0	900	0	900	0	850	-
V-17	5U4	0	355	0	310	0	310	0	355	-

All measurements made with VTVM at 117 volts AC input.

Controls set as follows:

XTAL switch	ON	AUDIO control	Counterclockwise
START button	Pressed	CHANNEL SEL.	1
FUNCTION switch	PHONE	PLATE CURRENT	40 Ma.
OPERATE switch	XMIT	Lug 8, TB-2 grounded	(rear of transmitter)
CARRIER control	Counterclockwise		

## RESISTANCE CHARTS

TUBE		PIN 1	PIN 2	PIN 3	PIN 4	PIN 5	PIN 6	PIN 7	PIN 8	PIN 9
V-1	12AT7	220K	980K	680	.1	.1	70K	1Meg	680	0
V-2	12AT7	110K	120K	2.5K	.1	.1	110K	120K	2.5K	0
V-3	6BA7	Inf.	50K	35	0	.1	0	45K	0	100K
V-4	12AT7	110K	110K	480	.1	.1	110K	0	480	0
V-5	6AL5	1Meg	100K	0	.1	0	0	0	-	-
V-6	12AT7	55	260K	0	.1	.1	55	260K	0	0
V-7	12AT7	Inf.	470K	0	.1	.1	100K	100K	1K	0
V-8	6AU6	470K	0	0	.1	165K	470K	1.2K	-	-
V-9	1CP1	.1	1Meg	3.3Meg	3.4Meg	1Meg	3.2Meg	100K	0	-
V-10	6X8	0	30K	.1	0	580	120K	Inf.	30K	-
V-11	12AT7	50K	33K	270	.1	.1	50K	33K	270	0

TUBE		PIN 1	PIN 2	PIN 3	PIN 4	PIN 5	PIN 6	PIN 7	PIN 8	PIN 9
V-12	12BY7A	25	24K	0	.1	.1	0	120K	100K	0
V-13	5894	.1	8.5K	27K	10	0	8.5K	.1	-	-
V-14	OA2	Inf.	0	Inf.	0	Inf.	Inf.	0	-	-
V-15	OB2	27K	Inf.	Inf.	Inf.	29K	Inf.	Inf.	-	-
V-16	5R4	Inf.	24K	Inf.	170	Inf.	170	Inf.	24K	-
V-17	5U4	Inf.	26K	Inf.	37	Inf.	37	Inf.	26K	-

-35-

All measurements made with VTVM at 117 volts AC input.

Controls set as follows:

XTAL switch	OFF
STOP button	Pressed
FUNCTION switch	PHONE
OPERATE switch	XMIT

CARRIER control	Counterclockwise
AUDIO control	Counterclockwise
CHANNEL SEL.	1

## PARTS LISTS, T-100

Part No.	Description
R-1	Resistor, carbon, 47K ohm, 1/2 watt 10%
R-2	Resistor, carbon, 1 meg ohm, 1/2 watt, 10%
R-3	Resistor, carbon, 680 ohm, 1/2 watt, 10%
R-4	Resistor, carbon, 220K ohm, 1/2 watt, 10%
R-5	Resistor, carbon, 47K ohm, 1/2 watt, 10%
R-6	Resistor, carbon, 1 meg ohm, 1/2 watt, 10%
R-7	Resistor, carbon, 1.8K ohm, 1/2 watt, 10%
R-8	Resistor, carbon pot., 1 meg ohm, 2 watt
R-9	Resistor, carbon, 1K ohm, 1/2 watt, 10%
R-10	Resistor, carbon, 680 ohm, 1/2 watt, 10%
R-11	Resistor, carbon, 270 ohm, 1/2 watt, 10%
R-12	Resistor, carbon, 2.2K ohm, 1/2 watt, 10%
R-13	Resistor, carbon pot., 500 ohm, 2 watt
R-14	Resistor, carbon, 120K ohm, 1/2 watt, 10%
R-15	Resistor, carbon, 270 ohm, 1/2 watt, 10%
R-16	Resistor, carbon, 1K ohm, 1/2 watt, 10%
R-17	Resistor, carbon, 47K ohm, 1/2 watt, 10%
R-18	Resistor, carbon, 220K ohm, 1/2 watt, 10%
R-19	Resistor, carbon, 4.7K ohm, 1 watt, 10%
R-20	Resistor, carbon, 47K ohm, 1/2 watt, 10%
R-21	Resistor, carbon, 120K ohm, 1/2 watt, 10%
R-22	Resistor, carbon, 2.2K ohm, 1/2 watt, 10%
R-23	Resistor, carbon, 470 ohm, 1/2 watt, 10%
R-24	Resistor, carbon, 100K ohm, 1/2 watt, 10%
R-25	Resistor, carbon, 2.2K ohm, 1/2 watt, 10%
R-26	Resistor, carbon, 10K ohm, 1/2 watt, 10%
R-27	Resistor, carbon, 1 meg ohm, 1/2 watt, 10%
R-28	Resistor, carbon, 22K ohm, 1/2 watt, 10%

Part No.	Description
R-29	Resistor, carbon, 470K ohm, 1/2 watt, 10%
R-30	Resistor, carbon, 2.4 meg ohm, 1/2 watt, 5%
R-31	Resistor, carbon, 470K ohm, 1/2 watt, 10%
R-32	Resistor, carbon, 12K ohm, 1/2 watt, 10%
R-33	Resistor, carbon, 1K ohm, 1/2 watt, 10%
R-34	Resistor, carbon, 150K ohm, 1/2 watt, 10%
R-35	Resistor, carbon, 2.2K ohm, 1/2 watt, 10%
R-36	Resistor, carbon, 470K ohm, 1/2 watt, 10%
R-37	Resistor, carbon, 100K ohm, 1/2 watt, 10%
R-38	Resistor, carbon pot., 1K ohm, 2 watt
R-39	Resistor, carbon, 47 ohm, 1/2 watt, 10%
R-40	Resistor, carbon, 470K ohm, 1/2 watt, 10%
R-41	Resistor, carbon, 150K ohm, 1/2 watt, 10%
R-42	Resistor, carbon, 470K ohm, 1/2 watt, 10%
R-43	Resistor, carbon, 120 ohm, 1/2 watt, 10%
R-44	Resistor, carbon, 1K ohm, 1/2 watt, 10%
R-45	Resistor, carbon, 2.2 meg ohm, 1/2 watt, 10%
R-46	Resistor, carbon, 2.2 meg ohm, 1/2 watt, 10%
R-47	Resistor, carbon, 2.2 meg ohm, 1/2 watt, 10%
R-48	Resistor, carbon, 1 meg ohm, 1 watt, 10%
R-49	Resistor, carbon, 1 meg ohm, 1/2 watt, 10%
R-50	Resistor, carbon, 47 ohm, 1/2 watt, 10%
R-51	Resistor, carbon, 120K ohm, 1/2 watt, 10%
R-52	Resistor, carbon, 560 ohm, 1/2 watt, 10%
R-53	Resistor, carbon, 680 ohm, 1/2 watt, 10%
R-54	Omitted
R-55	Resistor, carbon, 680 ohm, 1/2 watt, 10%
R-56	Resistor, carbon, 22K ohm, 1/2 watt, 10%
R-57	Resistor, carbon, 270 ohm, 1/2 watt, 10%
R-58	Resistor, carbon, 10K ohm, 1/2 watt, 10%
R-59	Resistor, carbon, 8.2K ohm, 1/2 watt, 10%
R-60	Resistor, carbon, 12K ohm, 1/2 watt, 10%
R-61	Resistor, carbon, 100K ohm, 1/2 watt, 10%
R-62	Resistor, carbon, 10K ohm, 1/2 watt, 10%

Part No.	Description
R-63	Resistor, carbon, 1K ohm, 1/2 watt, 10%
R-64	Resistor, carbon, 22K ohm, 1 watt, 10%
R-65	Resistor, carbon, 82K ohm, 1 watt, 10%
R-66	Resistor, carbon, 10 ohm, 1 watt, 10%
R-67	Resistor, carbon, 2.2K ohm, 1/2 watt, 10%
R-68	Resistor, carbon, 47 ohm, 1/2 watt, 10%
R-69	Resistor, carbon, 10K ohm, 2 watt, 10%
R-70	Resistor, carbon, 1.2K ohm, 2 watt, 10%
R-71	Resistor, carbon, 2.2 meg ohm, 1/2 watt, 10%
R-72	Resistor, wire wound, pot., 10K ohm, 4 watt
R-73	Resistor, carbon, 56K ohm, 1 watt, 10%
R-74	Resistor, carbon, 82K ohm, 1/2 watt, 10%
R-75	Resistor, carbon, 15K ohm, 1/2 watt, 10%
R-76	Resistor, carbon, 470K ohm, 1/2 watt, 10%
R-77	Resistor, carbon, 470K ohm, 5 watt, 10%
R-78	Resistor, wire wound, 25K ohm, 50 watt
R-79	Resistor, wire wound, 2.5K ohm, 10 watt
R-80	Resistor, wire wound, 30K ohm, 20 watt
R-81	Resistor, carbon pot., 100K ohm, 2 watt
R-82	Resistor, wire wound, 2K ohm, 5 watt
R-83	Resistor, carbon, 120K ohm, 1/2 watt, 10%
R-84	Resistor, carbon, 1K ohm, 1/2 watt, 10%
R-85	Resistor, carbon, 270 ohm, 1 watt, 10%
R-86	Resistor, carbon, 1K ohm, 1/2 watt, 10%
R-87	Resistor, carbon, 470 ohm, 1/2 watt, 10%
R-88	Resistor, carbon, 12K ohm, 1/2 watt, 10%
R-89	Resistor, carbon, 12K ohm, 1/2 watt, 10%
R-90	Resistor, carbon, 10 ohm, 1/2 watt, 10%
R-91	Resistor, carbon, 330 ohm, 1/2 watt, 10%
R-92	Resistor, carbon, 330 ohm, 1/2 watt, 10%
R-93	Resistor, carbon, 560 ohm, 1/2 watt, 10%
PSI-1	Resistor, carbon, 47 ohm, 1/2 watt, 10%
PSI-2	Resistor, carbon, 47 ohm, 1 watt, 10%
PSI-3	Resistor, wire wound, 50 ohms, 5 watts

Part No.	Description
C-1	Capacitor, ceramic disc, 330 mmf, GMV, 600 VW
C-2	Capacitor, oil, 1 mfd, 500 VW
C-3	Capacitor, ceramic disc, .005 mfd, 600 VW
C-4	Capacitor, disc, .01 mfd, GMV, 600 VW
C-5	Capacitor, disc, .01 mfd, GMV, 600 VW
C-6	Capacitor, disc, .01 mfd, GMV, 600 VW
C-7	Capacitor, ceramic disc, .001 mfd, 600 VW
C-8	Capacitor, ceramic disc, .005 mfd, 600 VW
C-9	Capacitor, ceramic disc, .001 mfd, 600 VW
C-10	Capacitor, disc, .025 mfd, GMV, 500 VW
C-11	Capacitor, ceramic, 15 mmf, 10%
C-12	Capacitor, mica, 242 mmfd, 10%
C-13	Capacitor, disc, .025 mfd, GMV, 500 VW
C-14	Capacitor, disc, .01 mfd, GMV, 600 VW
C-15	Capacitor, disc, .01 mfd, GMV, 600 VW
C-16	Capacitor, mica, 100 mmfd, 10%
C-17	Capacitor, mica, 100 mmfd, 10%
C-18	Capacitor, disc, .01 mfd, GMV, 600 VW
C-19	Capacitor, disc, .01 mfd, GMV, 600 VW
C-20	Capacitor, disc, .01 mfd, GMV, 600 VW
C-21	Capacitor, mica, 200 mmfd, 10%
C-22	Capacitor, mica, 100 mmfd, 10%
C-23	Capacitor, mica, 100 mmfd, 10%
C-24	Capacitor, disc, .025 mfd, GMV, 500 VW
C-25	Capacitor, disc, .025 mfd, GMV, 500 VW
C-26	Capacitor, ceramic disc, .005 mfd, 600 VW
C-27	Capacitor, ceramic tubular, 15 mmfd, 10%, 300 VW
C-28	Capacitor, ceramic, 10 mmf, TCZ
C-29	Capacitor, disc, .025 mfd, GMV, 500 VW
C-30	Capacitor, ceramic disc, .005 mfd, 600 VW
C-31	Capacitor, ceramic disc, .005 mfd, 600 VW
C-32	Capacitor, ceramic disc, .005 mfd, 600 VW
C-33	Capacitor, ceramic disc, .005 mfd, 600 VW
C-34	Capacitor, ceramic disc, .005 mfd, 600 VW



Part No.	Description
C-35	Capacitor, ceramic disc, .005 mfd, 600 VW
C-36	Capacitor, ceramic disc, .005 mfd, 600 VW
C-37	Capacitor, ceramic disc, .005 mfd, 600 VW
C-38	Capacitor, oil, 1 mfd, 500 VW
C-39	Capacitor, disc, .01 mfd, GMV, 600 VW
C-40	Capacitor, bathtub, 50 mfd, 50 VWDC
C-41	Capacitor, disc, .01 mfd, GMV, 600 VW
C-42	Capacitor, disc, .003 mfd, GMV, 2 KV
C-43	Capacitor, disc, .01 mfd, GMV, 600 VW
C-44	Capacitor, scope coupling, Eldico
C-45	Capacitor, disc, .025 mfd, GMV, 50 VW
C-46	Capacitor, mica, 1000 mmf, 5% 500 V
C-47	Capacitor, mica, 200 mmfd, 10%, 300 VW
C-48	Capacitor, ceramic disc, .001 mfd, 600 VW
C-49	Capacitor, ceramic disc, .001 mfd, 600 VW
C-50	Capacitor, ceramic tubular, 100 mmfd
C-51	Capacitor, ceramic disc, .005 mfd, 600 VW
C-52	Capacitor, variable, 5-20 mmfd
C-53	Capacitor, ceramic, 50 mmf, 10%
C-54	Capacitor, variable, 100 mmfd
C-55	Capacitor, variable, 100 mmfd
C-56	Capacitor, variable, 100 mmfd
C-57	Capacitor, variable, 100 mmfd
C-58	Capacitor, variable, 5-20 mmfd
C-59	Capacitor, variable, 5-20 mmfd
C-60	Capacitor, variable, 5-20 mmfd
C-61	Capacitor, variable, 5-20 mmfd
C-62	Capacitor, ceramic disc, .001 mfd, 600 VW
C-63	Capacitor, disc, .01 mfd, GMV, 600 VW
C-64	Capacitor, ceramic disc, .001 mfd, 600 VW
C-65	Capacitor, ceramic disc, .005 mfd, 600 VW
C-66	Capacitor, ceramic tubular, 100 mmfd
C-67	Capacitor, variable, 5-30 mmfd
C-68	Capacitor, mica, 200 mmfd, 10%, 300 VW

Part No.	Description
C-69	Capacitor, ceramic disc, .005 mfd, 600 VW
C-70	Capacitor, disc, .01 mfd, GMV, 600 VW
C-71	Capacitor, feed-thru, 1000 mmf
C-72	Capacitor, disc, .01 mfd, GMV, 600 VW
C-73	Capacitor, ceramic, 50 mmf 10%
C-74	Capacitor, variable, 100 mmfd
C-75	Capacitor, variable, 100 mmfd
C-76	Capacitor, variable, 100 mmfd
C-77	Capacitor, variable, 100 mmfd
C-78	Capacitor, ceramic, 33 mmf
C-79	Capacitor, ceramic tubular, 15 mmfd, 10%, 300 VW
C-80	Capacitor, variable, 5-30 mmfd
C-81	Capacitor, ceramic tubular, 3 mmfd, 10%, 300 VW
C-82	Capacitor, mica, 200 mmfd, 10%, 300 VW
C-83	Capacitor, ceramic tubular, 1 mmfd, 300 VW
C-84	Capacitor, disc, .01 mfd, GMV, 600 VW
C-85	Capacitor, disc, .01 mfd, GMV, 600 VW
C-86	Capacitor, disc, .01 mfd, GMV, 600 VW
C-87	Capacitor, 500 mmfd, 12.5KV
C-88	Capacitor, disc, .003 mfd, GMV, 3 KV
C-89	Capacitor, variable, 300 mmf
C-90	Capacitor, variable, 200 mmfd
C-91	Capacitor, variable, 200 mmfd
C-92	Capacitor, variable, 200 mmfd
C-93	Capacitor, variable, 3X450 mmfd
C-94	Capacitor, variable, 3X450 mmfd
C-95	Capacitor, variable, 3X450 mmfd
C-96	Capacitor, variable, 3X450 mmfd
C-97	Capacitor, electrolytic, 16 mfd, 450 VWDC
C-98	Capacitor, bathtub, 15 mfd, 150 VWDC
C-99	Capacitor, tubular, .5 mfd, 100 VWDC
C-100	Capacitor, ceramic disc, .005 mfd, 600 VW
C-101	Capacitor, electrolytic, 16 mfd, 450 VWDC
C-102	Capacitor, oil, 10 mfd, 1000 V

Part No.	Description
C-103	Capacitor, electrolytic, 2X40 mfd, 450 V
C-104	Capacitor, ceramic disc, .005 mfd, 600 VW
C-105	Capacitor, ceramic disc, .005 mfd, 600 VW
C-106	Capacitor, ceramic disc, .005 mfd, 600 VW
C-107	Capacitor, ceramic disc, .005 mfd, 600 VW
C-108	Capacitor, ceramic disc, .005 mfd, 600 VW
C-109	Capacitor, ceramic disc, .005 mfd, 600 VW
C-110	Capacitor, disc, .003 mfd, GMV, 2KV
C-111	Capacitor, disc, .003 mfd, GMV, 2 KV
C-112	Capacitor, ceramic disc, .005 mfd, 600 VW
C-113	Capacitor, ceramic disc, .005 mfd, 600 VW
C-114	Capacitor, ceramic disc, 25 mmfd,
C-115	Capacitor, ceramic disc, .005 mfd, 600 VW
C-116	Capacitor, electrolytic, 5600 mfd, 15 volts
C-117	Capacitor, variable, 5-30 mmfd
C-118	Capacitor, variable, 5-30 mmfd
C-119	Capacitor, variable, 5-30 mmfd
C-120	Capacitor, variable, 5-30 mmfd
C-121	Capacitor, ceramic, 33 mmf
C-122	Capacitor, ceramic, 10 mmf
C-123	Capacitor, mica, 84 mmf, 5%, 300 V
CH-1	Choke, swinging, Eldico #EC-315
CH-2	Choke, smoothing, Eldico #EC-329
T-1	Transformer, special, Eldico
T-2	Transformer, power, Eldico ET-318
T-3	Transformer, filament, Eldico ET-340
RL-1	Relay, automatic
RL-2	Relay, latching
RL-3	Relay, latching
RL-4	Relay, coaxial, 117 VAC coil

Part No.	Description
M-1	Meter, 0-1 Ma.
XF-1	Crystal filter, Eldico XF 410-413
ET-345	Transformer, bias
EC-346	Choke, bias, .05 hy at 2 amps
V-1	12A T7 vacuum tube
V-2	12A T7 vacuum tube
V-3	6BA7 vacuum tube
V-4	12A T7 vacuum tube
V-5	6AL5 vacuum tube
V-6	12A T7 vacuum tube
V-7	12A T7 vacuum tube
V-8	6AU6 vacuum tube
V-9	1CP1 cathode ray tube
V-10	6X8 vacuum tube
V-11	12A T7 vacuum tube
V-12	12B Y7A vacuum tube
V-13	5894 vacuum tube
V-14	OA2 vacuum tube
V-15	OB2 vacuum tube
V-16	5R4GY vacuum tube
V-17	5U4GB vacuum tube

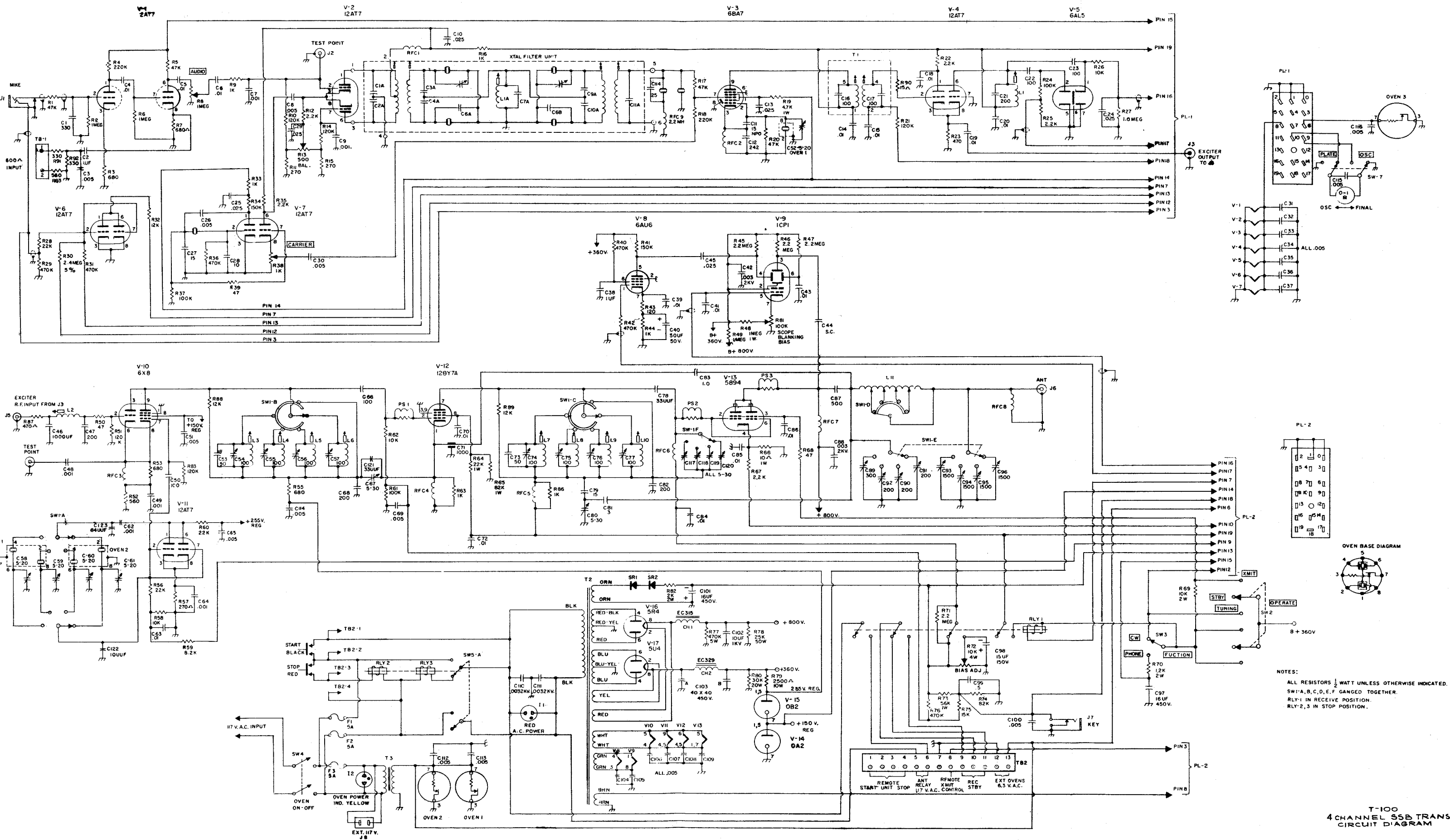

NOTES:  
 ALL RESISTORS 1/2 WATT UNLESS OTHERWISE INDICATED.  
 SW1-A, B, C, D, E, F GANGED TOGETHER.  
 RLY-1 IN RECEIVE POSITION.  
 RLY-2, 3 IN STOP POSITION.

T-100  
 4 CHANNEL SSB TRANS.  
 CIRCUIT DIAGRAM

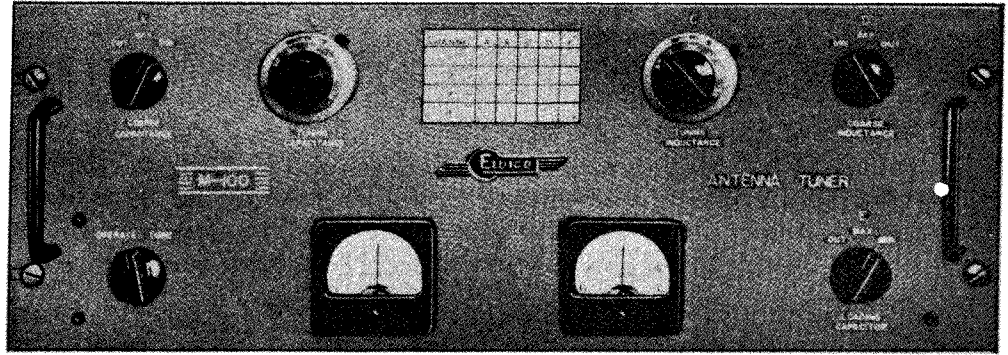

***M-100***

***Antenna Tuner***

# SECTION I

## DESCRIPTION

### 1.1 INTRODUCTION

- A. The Eldico M-100 Antenna Tuner is a device intended to match coaxial lines having standing waves to a 50 ohm line. This unit is similar to an adjustable RF transformer that will transform a reasonable range of impedances to a 50 ohm resistive impedance.
- B. To facilitate adjustment, phase ( $\phi$ ) and impedance ( $Z$ ) meters are included in the unit.

### 1.2 FEATURES

- A. Combination of "L" or "T" network for transformation of low or high impedances to a 50 ohm resistive impedance (nominal).
- B. Phase meter: Measures the relative phase between the voltage and current entering the network.
- C. Impedance meter: Measures the ratio between the voltage and current determining the impedance at the input to the network. This meter reads impedance, whether it is resistive, capacitive or inductive.

### 1.3 SPECIFICATIONS

- A. Operating Range: 2.2 to 30.0 megacycles.
- B. Matching Network: "L" or "T" network, depending on load impedance.
- C. Metering: RF impedance bridge and RF phase bridge are included in unit. Bridges are of the null type, indicating both phase and magnitude of the load impedance presented to transmitter.

## **SECTION II**

### **INSTALLATION**

#### **2.1 LOCATION AND MOUNTING**

While this unit may be mounted in any convenient location, it is usually mounted as the uppermost panel in the S-100 system. The unit does not generate any heat and is relatively insensitive to heat.

#### **2.2 EXTERNAL CONNECTIONS**

- A. Input: RF energy from the transmitter is brought into the unit at this point, an 83-1R coaxial connector.
  
- B. Output: The antenna lead is to be connected to the unit at this point, an 83-1R coaxial connector.



## SECTION III

### OPERATION

#### 3.1 CONTROLS

- A. **OPERATE-TUNE:** This switch is used when tuning the companion transmitter. When this switch is in the TUNE position, a dummy load is connected. In the OPERATE position, the dummy load is disconnected and the M-100 functions with the antenna tuning circuits connected to the transmitter.

CAUTION: DO NOT OPERATE SWITCHES WHILE RF ENERGY IS APPLIED TO THE UNIT FROM THE TRANSMITTER!

- B. **COARSE CAPACITANCE:** This controls the amount of series capacitance in the network. When in the OUT position, the capacitor is short-circuited. In the MAX position, the capacitance range is 1000 to 2000 micro-microfarads. When switched to the MIN position, the range of the tuning capacitor becomes 50 to 1000 micro-microfarads.
- C. **TUNING CAPACITANCE:** This varies the capacitance over the range selected by the COARSE CAPACITANCE switch.
- D. **TUNING INDUCTANCE:** This is a continuously variable inductance, whose tuning range is selected by the COARSE INDUCTANCE control.
- E. **COARSE INDUCTANCE:** This three position switch progressively disconnects the inductor. The positions are OUT, MIN (2 to 15 microhenries) or MAX (15 to 30 microhenries).
- F. **LOADING CAPACITOR:** In certain circumstances, a simple "L" network will not match the load. To overcome this difficulty, a capacitor may be switched in series with the load, making a "T" network. In the OUT position, this capacitor is short-circuited. In the MAX position, a 200 mmfd capacitor is placed in series with the load. In the MIN position, a 50 mmfd capacitor is placed in series with the load.

#### 3.2 PRELIMINARY ADJUSTMENTS

- A. These instructions are to be followed whenever a change is made in the antenna and/or transmission line. These steps are also to be taken if a change is made in the frequency of operation (when changing channels).
- (1) Set switches A, D and E to OUT.
  - (2) Set TUNE-OPERATE switch to OPERATE.
  - (3) Make sure proper antenna has been connected.

- (4) Set transmitter channel selector switch to desired channel and turn AUDIO GAIN and CARRIER controls fully counterclockwise. Turn OPERATE switch to XMIT.
- (5) Increase carrier control clockwise (on transmitter) until meters on M-100 indicate. The meters may indicate several possible combinations.

NOTE: THE IMPEDANCE METER IS INHERENTLY LESS SENSITIVE THAN THE PHASE METER AND, THEREFORE, MAY NOT SEEM TO INDICATE WHEN THE PHASE METER IS FULLY DEFLECTED. IT MAY BE NECESSARY TO TUNE OUT REACTANCE WITH THE NETWORK AND RAISE THE CARRIER LEVELS TO MAKE THE IMPEDANCE METER DEFLECT.

- (6) If no deflection occurs, check to see that the transmitter is properly connected to the antenna relay and that the antenna relay is functioning. If proper operation of these components is indicated, servicing will be required. Check the appropriate manual. In unusual circumstances a 50 ohm resistive load may be presented to the antenna tuner. When this occurs, the meter will only deflect very slightly. To check for this, remove the antenna and gradually increase the carrier level from zero (on T-100) until the meters deflect. If they do deflect, the antenna tuner is working correctly and no adjustment is necessary.

#### B. Making Adjustments:

- (1) Before starting, the variable inductor should be set to the zero position on Dial "C" (maximum counterclockwise position), and the variable capacitor should be set to the maximum position on Dial "B" (maximum counterclockwise).

CAUTION: BEFORE OPERATING ANY SWITCHES ON M-100, TURN CARRIER CONTROL ON TRANSMITTER TO ZERO (COUNTERCLOCKWISE). AFTER SWITCHING, RAISE CARRIER CONTROL UNTIL METER READS.

- (2) If the IMPEDANCE meter reads low, set switch "E" to MAX. If IMPEDANCE meter still reads low, set switch "E" to MIN. If IMPEDANCE meter reads high from the outset, allow switch "E" to remain in the OUT position.
- (3) If PHASE meter reads CAP after Step 2, follow procedure outlined in left hand column. If PHASE meter reads IND., follow steps outlined in right hand column.

Set switch "D" to MAX. Turn control "C" clockwise until phase meter just reads IND. If the stop (15th turn) is reached before phase meter reads IND, reset knob "C" to zero. Set switch "D" to MIN. Turn knob "C" clockwise until phase meter just reads the inductive condition.

Set switch "A" to MAX and turn knob "B" counterclockwise until phase meter just reads CAP. If zero on dial "B" is reached before meter reads CAP, reset knob "B" to 380 and set switch "A" to MIN. Turn knob "B" counterclockwise until phase meter just reads CAP.

Set switch "A" to MAX and adjust knob "B" counterclockwise until resonance is reached on the phase meter (r). If the zero position on knob "B" is reached before the phase meter reads R (center), set switch "A" to MIN position and starting from 380 on the dial, readjust knob "B" counterclockwise until resonance is indicated on the phase meter. Proceed to Step 4.

Set switch "D" to MAX and adjust knob "C" in the clockwise direction until phase meter is centered. If this condition is not reached, set switch "D" to MIN and "C" to zero (maximum counterclockwise). Turn knob "C" clockwise until resonance is reached. Proceed to Step 4.

- (4) When resonance (R) has been reached, check the impedance meter. If it is centered, increase the level of the carrier. (CARRIER knob clockwise, not in excess of 150 Ma on the T-100). If the meter remains centered, the network is adjusted. If the impedance meter reads low, set switch "E" to MAX, and repeat Steps 3 through 4. If the impedance meter reads low again, set switch "E" to MIN and repeat Steps 3 through 4. The impedance meter may read high. In this case, turn knob "C" clockwise about a half turn and adjust the variable capacitor for resonance as indicated on the phase meter. The impedance meter should now read closer to center. Turn knob "C" clockwise to reduce the impedance and re-resonate with knob "B". Repeat this process as often as necessary to bring both meters to center.

If the impedance has to be decreased, turn knob "C" clockwise about half a turn. Then bring the network back into resonance with the knob "B". If the impedance is to be raised slightly, reverse the above procedure.

- (5) In unusual circumstances, as explained in the "Theory of Operation", it may be impossible to center the meters. If this is the case, set switches "A", "D" and "E" to OUT and retune the plate circuit of the final. Before Steps 3 through 6 are completed, the meters will center. To check for verification, turn the CARRIER control on the T-100 to zero (maximum counterclockwise position). Disconnect the antenna cable from the antenna relay, turn the control up from zero until the meters deflect. If meters deflect, the proper tuning has been made.
- (6) When the above steps have been completed, enter the information on the logging chart provided on the front panel. (Example: Channel, KNOB A OUT, KNOB B 1.37, KNOB C 6.27, KNOB D OUT, and KNOB E OUT.)
- (7) Repeat Steps 1 through 5 for all channels, being sure to enter the information on the log sheet.

### 3.3 OPERATING PROCEDURE

- A. Check logging chart to see that proper information has been recorded in spaces provided. (If this information is not available, the section on Preliminary Adjustments should be followed.)

B. Set all controls to positions recorded on logging chart. (Set in accordance with transmitter channel in use. Be sure the TUNE-OPERATE switch is in the OPERATE position.)

## SECTION IV

### THEORY OF OPERATION

#### 4.1 GENERAL

The antenna tuner consists of two parts; a matching network and two bridges that measure the phase and impedance looking into the matching network.

#### 4.2 IMPEDANCE DETECTOR... See Schematic

The DC voltage across C-1 is directly proportional to the RF voltage from the line to ground (as determined by the ratio R3:R4). This is a DC voltage rectified by D-1, a crystal diode. The RF voltage across L-1 is proportional to the current in the line. This RF voltage is detected by D-2, another crystal diode. The two voltages appear across R-5, a balancing potentiometer. This potentiometer is preset so that the meter (M-2) is centered when the impedance at the input to the matching network is 50 ohms. The bridge circuit measures total impedance: that is, the vector sum of the resistive and reactive components of the impedance looking into the matching network. If the meter reads 50 ohms, this does not mean that the network is resistive, since the phase meter is used for this information.

#### 4.3 PHASE DETECTOR... See Schematic

The phase detector is designed to balance meter M-3 when the RF voltage and RF current are in phase. This is accomplished by measuring the vector voltages across the terminals of L-2. In simpler terms, there are two voltages present at each end of the coil. One voltage is induced into L-2 by the RF current in the line. This voltage leads the current by 90 degrees. R-7, R-8 and R-9, R-10 form the voltage dividers across each end of L-2. (Resistors R-8 and R-9 effectively form a center tap across L-2).

The RF voltage on R-8 consists of two voltages 90 degrees out of phase (provided the network appears resistive.) Similarly, the two RF voltages across R-9 are also 90 degrees out of phase when the network appears resistive.

If the load appears reactive, the voltage induced in L-2 changes its phase relationship, and the two voltages in R-8 (for example) will come closer together in phase, while the voltages at the other tap (R-9) are further out of phase. This creates an unbalanced condition, causing the phase meter to read an unbalance towards either CAP or IND, depending on the phase of the impedance of the network.

#### 4.4 MATCHING NETWORK

The matching network is an "L" or "T" network depending on the load condition. The operation is as follows (refer to Figure 1.): Assume the impedance looking into the transmission line is at point A (125 ohms inductive and 175 ohms resistive). It can be proved mathematically that adding a variable inductance in parallel with the load can be plotted in the manner indicated. If the reactance decreases from some very large value toward zero, the total impedance will change from A to 2. The impedance now is 50 ohms resistive and 115 ohms reactive. If a series capacitor is now connected between the transmitter and the paralleled inductor and the transmission line, impedance can be transformed from 2 to 3. This, in effect, "tunes" out the reactance of the load. The load presented to the transformer is now 50 ohms resistive. This is the correct loading impedance for the transmitter.

If, for example, the impedance is at point B, it becomes obvious that the reactance can be tuned out as was done before, by using the same amount of capacitive reactance, but with a different amount of inductive reactance.

The shaded region in Figure 1 illustrates the points that cannot be matched with the "L" network. To overcome this difficulty, additional capacitance may be switched into the network, altering the circuit to a "T" network. At point C, for example, adding this capacity changes the impedance to point 4. Switching in and adjusting the inductor will transform the impedance from point 4 to point 5. Switching in and adjusting the variable capacitor should then complete the transformation by making the impedance appear to be 50 ohms.

To use the tuner, first refer to the Diagrams I and II. The phase meter reading the angle  $\theta$ , shows when the angle is zero. The impedance meter responds to the distance from zero ohms to point A, completely ignoring the angle  $\theta$ .

The following is a description of what occurs when the recommended tuning procedure is followed. If the COARSE CAPACITY, COARSE INDUCTANCE and LOADING CAPACITOR are switched to OUT, the phase meter and the impedance meter will read high. If the point is at A, the meters will read HIGH and IND. To bring the load to resonance, the tuning capacitor should be switched in and adjusted for the resonant condition. (See Figure 2.) The impedance will now be at point 2. The impedance, which is still too high, will require further adjustment. The inductance will be switched in with the next trial. The inductance is adjusted until the impedance meter indicates a decrease. This throws the network off resonance (phase meter no longer centered) as in point 3, Figure 2. The variable capacitor is used to resonate the network moving the impedance to point 4. Repeat these steps until the correct point is reached (50 ohms resistive; zero ohms reactive).

If starting from point B, the meters will read HIGH and CAP. Switch in the inductor and adjust it until the phase meter reads RESONANCE and then IND. Proceed as before with the resonating and re-resonating process until the desired conditions are fulfilled.

If starting from point C, the meters will again read as in the case of point A. However, it will be obvious that when the tuning capacitor is switched in and adjusted for resonance, the impedance meter will read LOW. Any further adjustment using only the tuning capacitance and inductance will nearly bring the impedance lower. To overcome this difficulty, switch in the loading capacitance.

#### 4.4 MATCHING NETWORK (Continued)

When starting from point D, the impedance meter will read LOW. It will then be necessary to switch in the loading capacitor. From this point the tuning will proceed as outlined for point B.

To cover the entire range of possible impedances would necessitate the use of network components whose impedance would vary from zero ohms to infinite ohms. Since this is impossible, and to give the greatest amount of flexibility, two ranges have been incorporated into each element. These ranges are marked on the associated switch.

NOTE: MAXIMUM REACTANCE OF THE VARIABLE ELEMENTS OCCURS WHEN DIALS ARE SET TO ZERO (minimum "C", maximum "L").

It is obvious from this discussion that when the impedance presented to the network is very large or very low (VSWR very high), it becomes impossible to tune the load to 50 ohms. On the other hand, when the load presented to the antenna tuner is almost 50 ohms (VSWR 1:1) resistive, the tuner cannot load to 50 ohms resistive. In these conditions, the best compromise is to leave switches A, D and E in the OUT positions. In the first instance, (VSWR very high) very little can be done. By switching out the network, some power will be transmitted. When this is the case, it will be necessary to recheck and if necessary, readjust the loading and tuning controls in the accompanying transmitter. (See appropriate instruction manuals.)

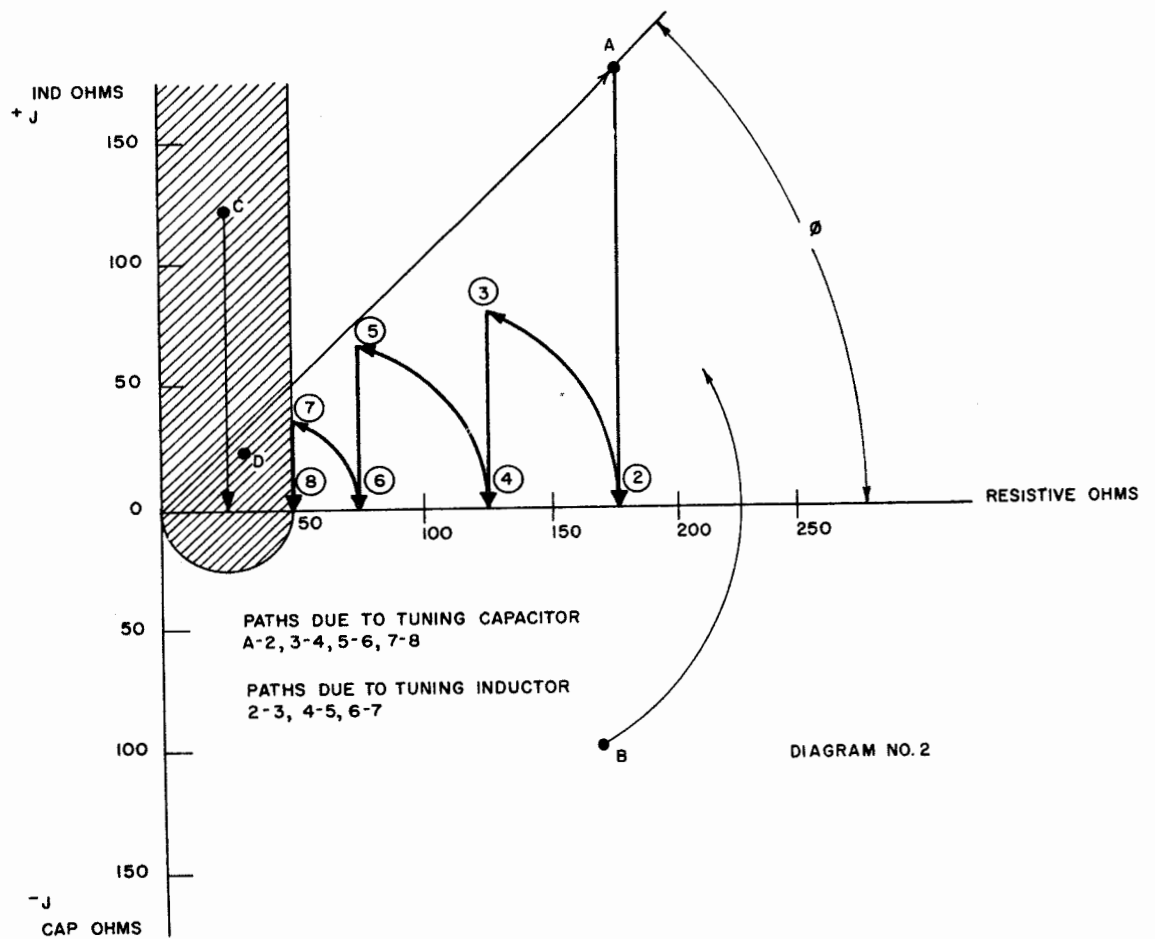
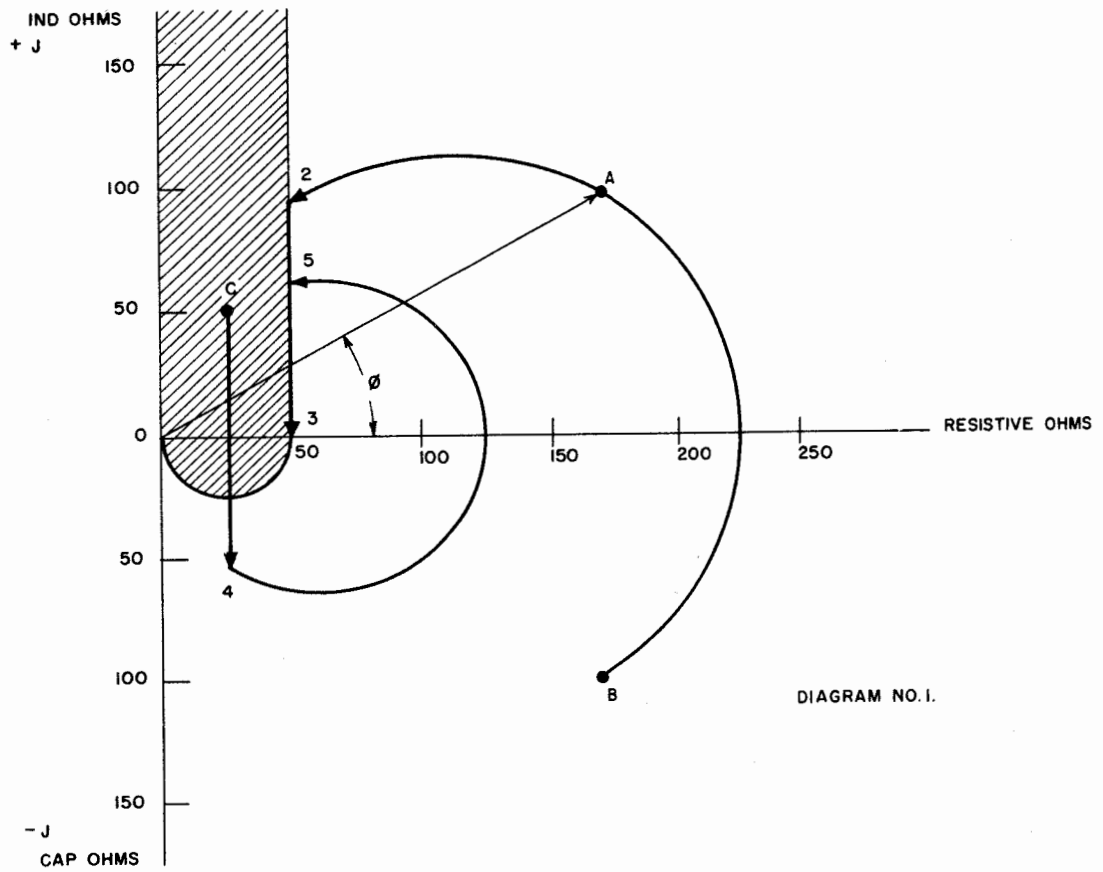



## SECTION V

### MAINTENANCE

#### 5.1 GENERAL

Maintenance of this antenna tuner is relatively simple since the unit is a passive device. Careful study of the schematic diagram will indicate that many difficulties can be isolated by simple resistance check. Difficulties arising from faulty tuning network elements will become apparent upon simple visual examination. Switches may be badly burned by operation while RF energy is applied.

#### 5.2 CHECKING PHASE AND IMPEDANCE METERS

- A. Operate switches A, D and E to the OUT position. Attach a purely resistive 50 ohm load.

NOTE: IF NO SUCH LOAD IS AVAILABLE, A JUMPER WIRE MAY BE ATTACHED FROM THE OUTPUT END OF THE PHASE AND IMPEDANCE DETECTOR HOUSING (JUNCTION OF R-10 AND C-5) BACK TO THE JUNCTION OF R-1, R-2 AND SW-1.

- B. The test frequency signal should be no more than 4 Mc, and the connection to the antenna should be removed.

- C. The Z BAL balancing potentiometer, located on top of the chassis should be adjusted for a 50 ohm center reading on the impedance meter. By deliberately misadjusting the potentiometer, the meter should be made to indicate either side of center. If this is not the case, a defect is indicated in one of the crystal diodes.

CAUTION: TO AVOID DAMAGE WHEN MAKING RESISTANCE CHECKS IN THE DIODE CIRCUITS, ONE OF THE LEADS SHOULD BE REMOVED FROM THE ASSOCIATED METER MOVEMENT.

- D. The phase meter may be checked similarly by adjusting the  $\emptyset$  BAL phase balance control on top of the chassis. The meter should swing to either side of zero as the control is varied. Should both detectors pass these tests, adjust the potentiometers so the associated movements can be centered.

NOTE: MAKE THESE ADJUSTMENTS ONLY WHEN THE BOTTOM COVER OF THE DETECTOR ASSEMBLY IS IN PLACE.

- E. Remove the jumper and reconnect the antenna. Then put the unit back into operation. (When making diode resistance checks with diode out of the circuit,

the forward resistance should be approximately 50 ohms and the back resistance approximately 100K ohms).

### 5.3 LUBRICATION

"Lubriplate" should be applied to all bearing surfaces to assure freedom of movement.

NOTE: IF, FOR ANY REASON, IT BECOMES NECESSARY TO RESET THE DIALS "B" AND "C", THE CAPACITOR IS SET TO 390 WHEN FULLY MESHED AND THE INDUCTOR IS SET AT ZERO WHEN THE ROLLER CONTACT WHEEL IS SET AT THE END FURTHEST FROM THE FRONT PANEL.

## PARTS LIST

Part No.	Description
R-1	Resistor, wire wound, non-inductive, 100 ohm
R-2	Resistor, wire wound, non-inductive, 100 ohm
R-3	Resistor, carbon, 4.7K ohm, 1/2 watt, 10%
R-4	Resistor, carbon, 33 ohm, 1/2 watt, 10%
R-5	Resistor, carbon pot., 250K ohm, 2 watt, linear taper, Shaft length 1/2 screwdriver adjust
R-6	Resistor, carbon, 10 ohm, 1 watt, 10%
R-7	Resistor, carbon, 47K ohm, 1/2 watt, 10%
R-8	Resistor, carbon, 10K ohm, 1/2 watt, 10%
R-9	Resistor, carbon, 10K ohm, 1/2 watt, 10%
R-10	Resistor, carbon, 47K ohm, 1/2 watt, 10%
R-11	Resistor, carbon pot., 1K ohm, 2 watt, linear taper, Shaft length 1/2 screwdriver adjust.
C-1	Capacitor, ceramic disc, .001 mfd, 600 WVDC
C-2	Capacitor, ceramic disc, .001 mfd, 600 WVDC
C-3	Capacitor, ceramic disc, .001 mfd, 600 WVDC
C-4	Capacitor, ceramic disc, .001 mfd, 600 WVDC
C-5	Capacitor, variable, 1000 mmfd
C-6	Capacitor, mica, transmitting type, .001 mfd
C-7	Capacitor, mica, transmitting, 200 mmfd
C-8	Capacitor, ceramic, transmitting, 50 mmfd
L-1	Toroid Inductor
L-2	Toroid Inductor
L-3	Inductor, variable, 15 uh
L-4	Inductor, 15 uh, 2-1/2 inch length

**NOTE:** R-3 MAY VARY +30% FROM VALUE SPECIFIED TO HELP CENTER R-5.  
THIS IS A PRODUCTION ADJUSTMENT.

Part No.	Description
RFC-1	RF choke, 3 mh
RFC-2	RF choke, 3 mh
RFC-3	RF choke, 3 mh
RFC-4	RF choke, 3 mh
M-1	Omitted
M-2	Meter, 50-0-50 microampere, special scale
M-3	Meter, 50-0-50 microampere, special scale
S-1	Switch, 1 pole, 2 pos., rotary ceramic
S-2	Switch, 1 pole, 3 pos., rotary ceramic
S-3	Switch, 1 pole, 3 pos., rotary ceramic
S-4	Switch, 1 pole, 3 pos., rotary ceramic
J-1	Coaxial jack
J-2	Coaxial jack
D-1	Crystal diode
D-2	Crystal diode
D-3	Crystal diode
D-4	Crystal diode

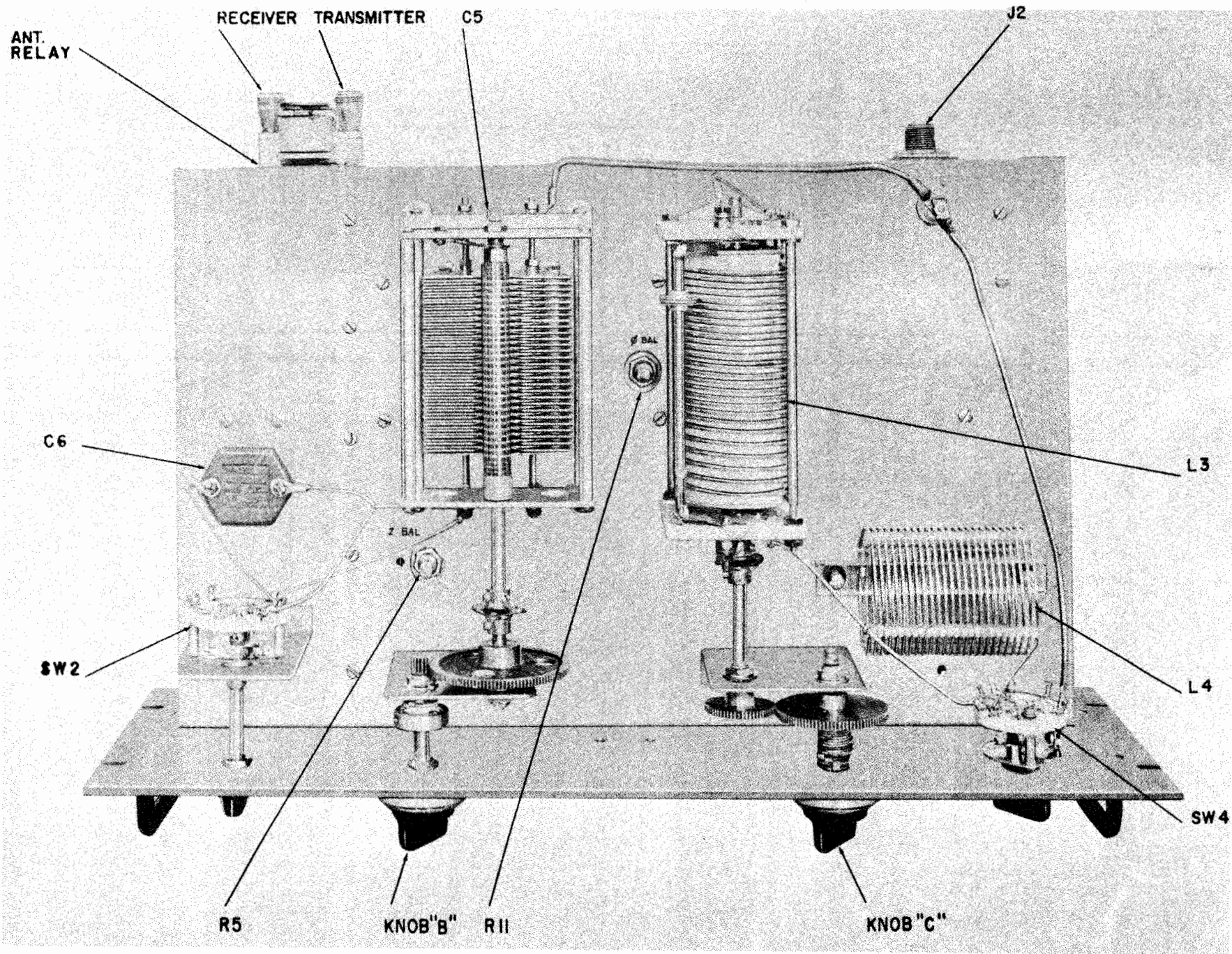

M-100 TOP VIEW

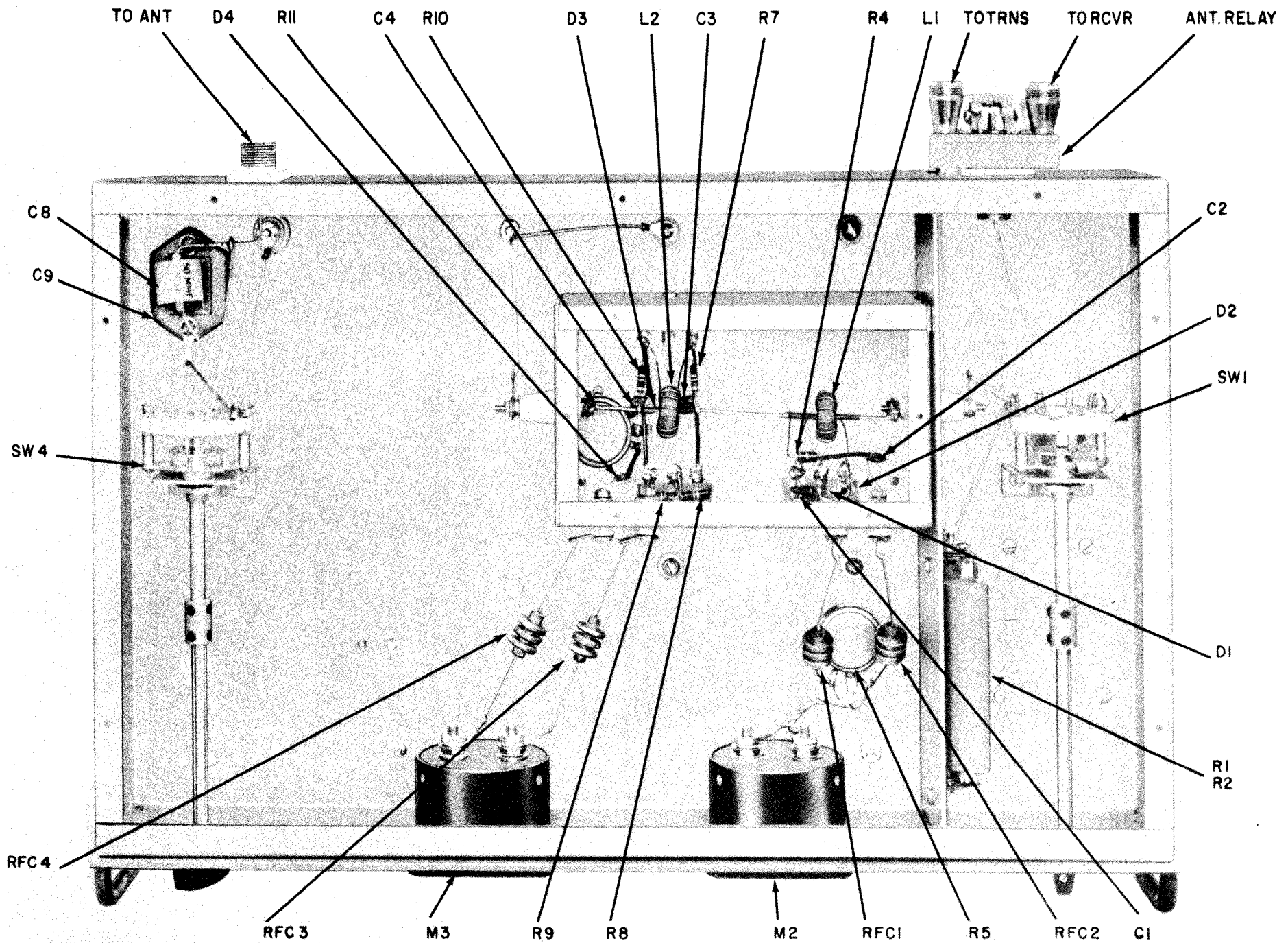

M-100 BOTTOM VIEW

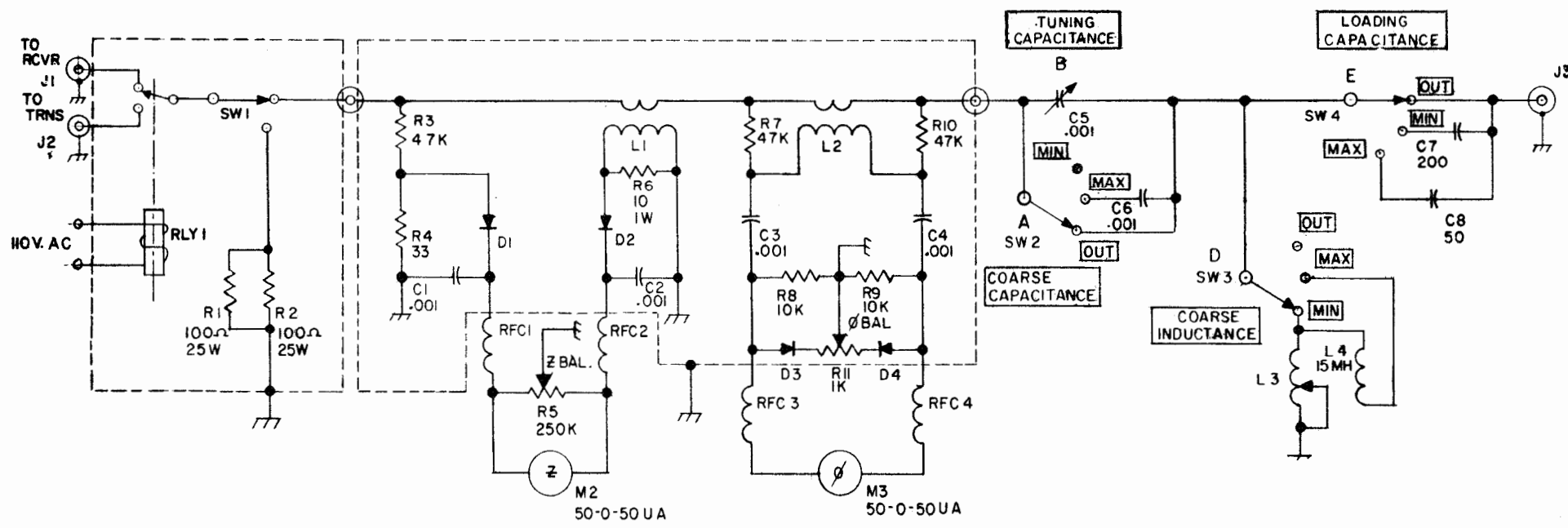

M-100  
CIRCUIT DIAGRAM