

0367 - 070 - 5010  
NAVSHIPS 92228

INSTRUCTION BOOK  
for  
**TRANSMITTER  
CONTROL-MONITOR  
MODEL AN/FRQ-3**

TRANSMITTER CONSOLE  
TYPE OA - 490/FRQ - 3

MONITOR GROUP  
TYPE OA - 489/FRQ - 3

ELECTRONICS DIVISION  
U.S. NAVAL GUN FACTORY

DEPARTMENT OF THE NAVY  
BUREAU OF SHIPS

Electronics Division  
Charleston Naval Shipyard  
U. S. Naval Base,  
Charleston, S. C.

*Approved by BuShips: 18 May 1954*

16 AUG 1956

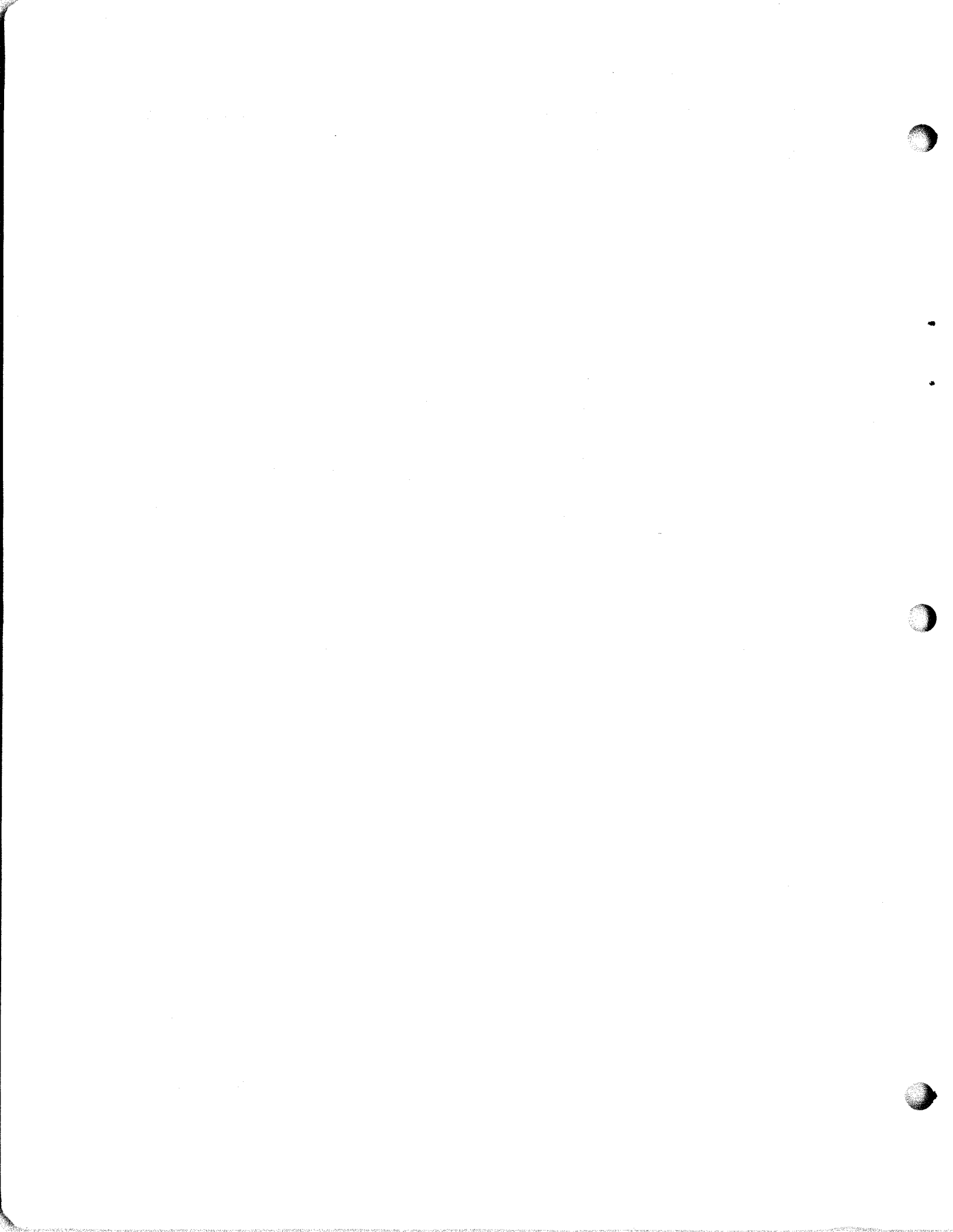



DEPARTMENT OF THE NAVY  
BUREAU OF SHIPS  
WASHINGTON 25, D. C.

IN REPLY REFER TO  
Code 993-100  
18 May 1954

From: Chief, Bureau of Ships  
To: All Activities Concerned with the  
Installation, Operation and Main-  
tenance of the Subject Equipment

Subj: Instruction Book for Transmitter  
Control-Monitor Model AN/FRQ-3,  
Transmitter Console Type OA-496/FRQ-3,  
Monitor Group Type OA-489/FRQ-3  
NAVSHIPS 92228

1. This is the instruction book for the subject equipment and is in effect upon receipt.
2. When superseded by a later edition, this publication shall be destroyed.
3. Extracts from this publication may be made to facilitate the preparation of other Department of Defense Publications.
4. All Navy requests for NAVSHIPS Electronics publications should be directed to the nearest District Publications and Printing Office. When changes or revised books are distributed, notice will be included in the Bureau of Ships Journal and in the Index of Bureau of Ships General and Electronics Publications, NAVSHIPS 250-020.

W. D. LEGGETT, JR.  
Chief of Bureau

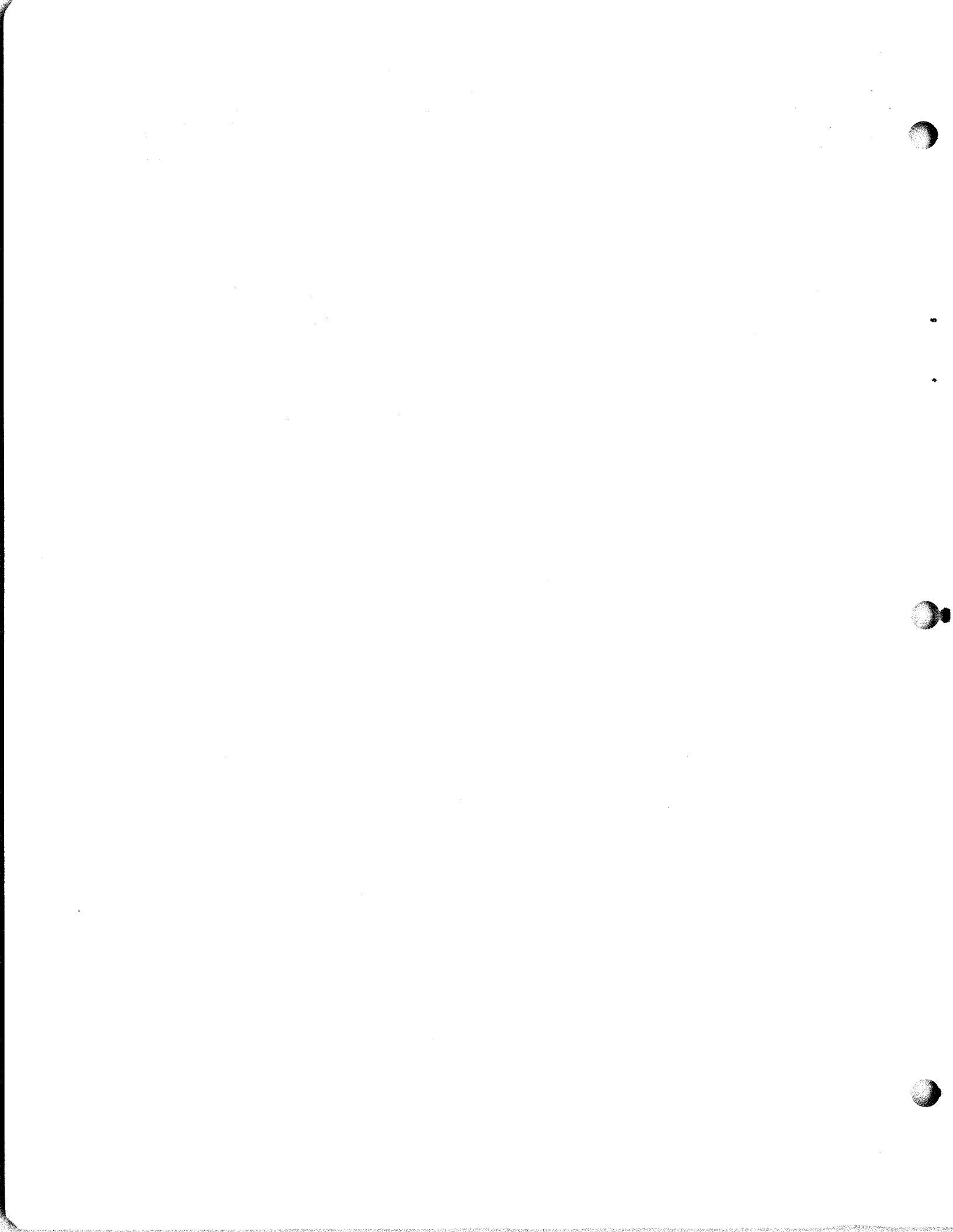



## SAFETY NOTICE

The attention of officers and operating personnel is directed to Chapter 67 of the Bureau of Ships Manual or superseding instructions on the subject of radio safety precautions to be observed.

This equipment employs voltages which are dangerous and may be fatal if contacted by operating personnel.

Extreme caution should be exercised when working with the equipment.

While every practicable safety precaution has been incorporated in this equipment the following rules must be strictly observed.

## KEEP AWAY FROM LIVE CIRCUITS

Operating personnel must at all times observe all safety regulations. Do not change tubes or make adjustments inside equipment with high voltage supply on. Under certain conditions dangerous potentials may exist in circuits with power controls in the off position due to charges retained by capacitors. To avoid casualties always remove power and discharge and ground circuits prior to touching them.

## DO NOT SERVICE OR ADJUST ALONE

Under no circumstances should any person reach within or enter the enclosure for the purpose of servicing or adjusting the equipment without the immediate presence or assistance of another person capable of rendering aid.



## REPORT OF FAILURE

Report of failure of any part of this equipment during its entire service shall be made to the Bureau of Ships in accordance with current regulations. The report shall cover all details of the failure and give the date of installation of the equipment. For procedure in reporting failures see Chapter 67 of the Bureau of Ships Manual or superseding instructions.

## ALTERATIONS

No alterations or modifications of this equipment shall be undertaken without approval of, or direction by the Bureau of Ships, except in cases of actual emergencies. Refer to Chapter 67-151 of Bureau of Ships Manual for proper method and procedure relating to alterations and modifications of electronic equipment.



## TABLE OF CONTENTS

## SECTION I - GENERAL DESCRIPTION

	Page
Purpose	1-1
Design	1-1
Description	1-2
Jack Panel	1-2
Switching Panel	1-2
Volume Level Indicator	1-3
Oscilloscope	1-4
Volt-Ohm-Millimeter	1-4
Radio Receiver	1-4
Audio Oscillator	1-5
R.F. Jack Panel	1-6
A.F. Jack Panel	1-6
R.F. Switch Panel	1-6
A.F. Switch Panel	1-7
Audio Oscillator	1-8
Antenna Coupler Unit	1-8
Frequency Shift Converter	1-9
Speaker Panel Assembly	1-9
Frequency Meter	1-10

## SECTION II - INSTALLATION

Location of Transmitter Console	2-1
Assembly	2-1
Power Wire	2-1
Internal Jack Wiring	2-1
Terminal Board Wiring	2-2
Checking External Wiring	2-2
Transmitter Carrier Indicator	2-2a
Indicator Lamp Wiring	2-3

## SECTION IIa - INSTALLATION

Location of Frequency Monitor Group	2-4
Assembly	2-4
Power Wiring	2-4
Internal Wiring	2-4
Wiring of Incoming Cable	2-5

## SECTION III - OPERATION

	Page
General Description	3-1
Selector Push Buttons	3-1
Example Using Selector Push Button Unit	3-2
Description of Patching Facilities	3-3
Example Using Patch Facilities	3-3
Example Using Patch Facilities and Selector Keys	3-3
Visual Indicator	3-5

## SECTION IV - PARTS LISTS

Major Units -	
Volume Level Indicator, TS-629/U	1-3
Cathode Ray Oscilloscope, OBL-3a	1-4
Volt-Ohm-Milliameter, OBQ-4	1-4
Radio Receiver, Model RCH	1-4
Audio Oscillator, Hewlett Packard 200 ABR	1-5
R.F. Switch Panel, SA-138/G	1-7
A.F. Selector Switch, SA-135/G	1-7
Antenna Coupler, CU-168/FRR	1-8
Audio Oscillator, El-Tronics TE200K	1-8
Frequency Shift Converter, Model CV-60/URR	1-9
Speaker Assembly, LS-139/G	1-9
Frequency Meter, Navy Model LR	1-10
Components	4-1

## SECTION V - ILLUSTRATIONS AND DIAGRAMS

Figure 5-1	Console Jack Panel Wiring Details	5-1
Figure 5-2	Wiring Details Switching Unit	5-2
Figure 5-3	Typical Switching Diagram	5-3
Figure 5-4	Plan View of Console	5-4
Figure 5-5	Typical RF Jack Diagram	5-5
Figure 5-6	Typical AF Jack Diagram	5-6
Figure 5-7	Base Floor Plan for Transmitter Control Console	5-7
Figure 5-8	Power Wiring for Transmitter Control Console	5-8
Figure 5-9	Cabling Diagram for Transmitter Control Console	5-9
Figure 5-10	Cabling Diagram for Transmitter Control Console	5-10
Figure 5-11	RF Monitor Unit Diagram	5-11
Figure 5-12	Frequency Monitoring Group Equipment Plan	5-12
Figure 5-13	Frequency Monitoring Group Power Wiring	5-13

## SECTION V - ILLUSTRATIONS AND DIAGRAMS (CONT)

	Page
Figure 5-14 Audio Jack Wiring Cabinet Number Eleven	5-14
Figure 5-15 Frequency Monitoring Group R.F. Jack Diagram	5-15
Figure 5-16 Audio Jack Wiring Cabinet Number Seven	5-16
Figure 5-17 Audio Switch Wiring Diagram	5-17
Figure 5-18 Frequency Monitoring Equipment Audio Jack	5-18
Figure 5-19 Floor Plans for Transmitter Console and Frequency Monitoring Bay	5-19

## LIST OF ILLUSTRATIONS

Figure 1-1 Transmitter Control Console and Frequency Monitoring Group	
Figure 1-2 Transmitter Control Console	
Figure 1-3 Monitoring Group	
Figure 1-4 Jack Panel (Console)	1-2
Figure 1-5 Switching Panel (Console)	1-3
Figure 1-6 Volume Level Indicator (Console)	1-3
Figure 1-7 Cathode Ray Oscilloscope (Console)	1-4
Figure 1-8 VTVM OBQ-4	1-4
Figure 1-9 Radio Receiver Model RCH	1-4
Figure 1-10 Audio Oscillator, Hewlett Packard Type 200 AB	1-5
Figure 1-11 Jack Panel AN Type J-239/G	1-6
Figure 1-12 RF Coaxial Switch	1-7
Figure 1-13 AF Selector Switch	1-7
Figure 1-14 Audio Oscillator El-Tronics Type TE200K	1-8
Figure 1-15 Antenna Coupler CU-168/FRR	1-8
Figure 1-16 Frequency Shift Converter CV-60/URR	1-9
Figure 1-17 Speaker Panel Assembly	1-9
Figure 1-18 Frequency Meter, Navy Model LR	1-10
Figure 2-1 Internal Wiring Using Thomas and Betts Grounding Ferrules	2-2a
Figure 2-2 RF Monitor Unit	2-3
Figure 3-1 Location of Selector Key to Connect Transmitter Number Seven to Channel Number Five	3-2
Figure 3-2 Location of Selector Key to Connect Transmitter Number Seventeen, Number Twenty, Number Twenty-five and Number Twenty-eight to Channel Number Sixteen	3-4

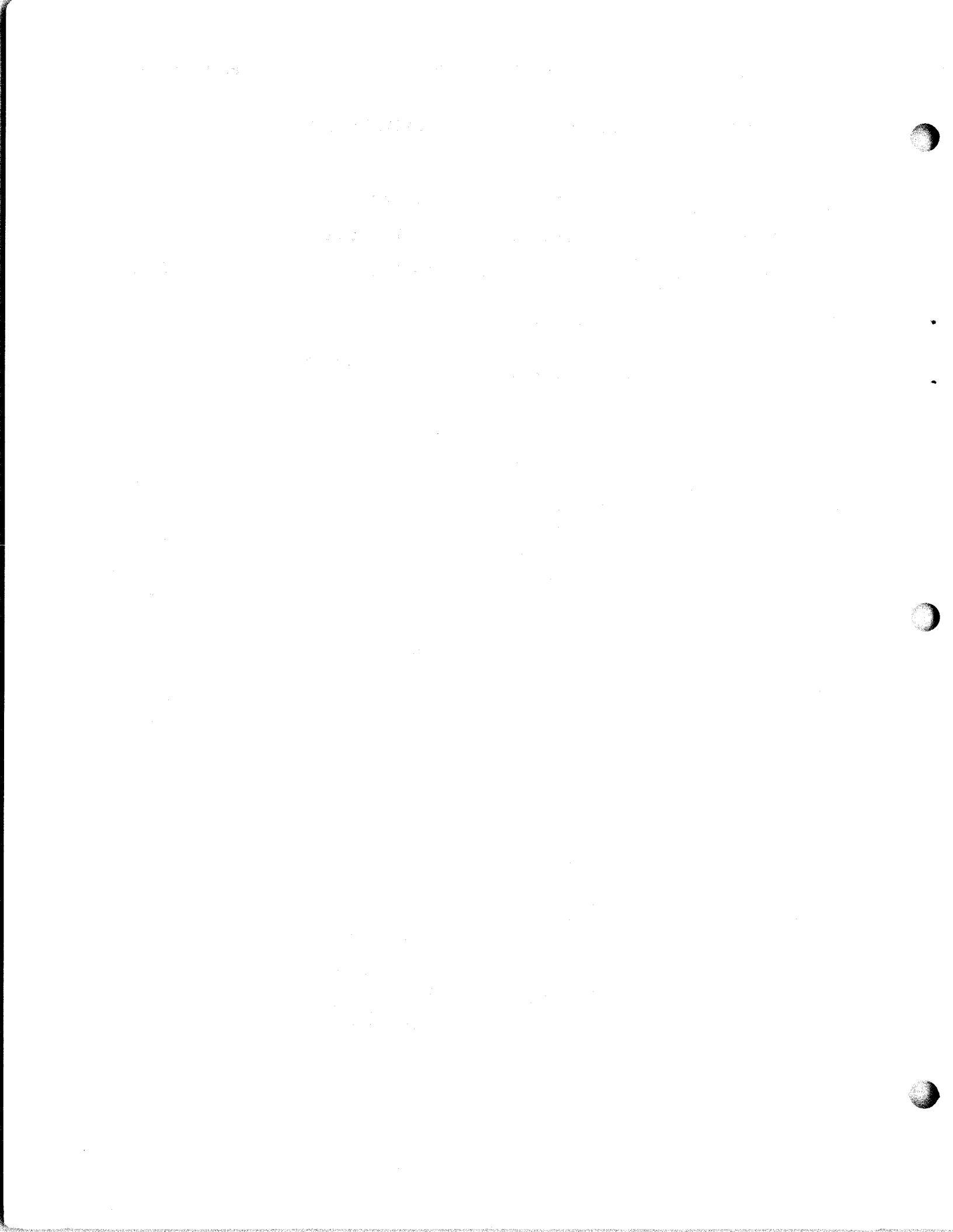



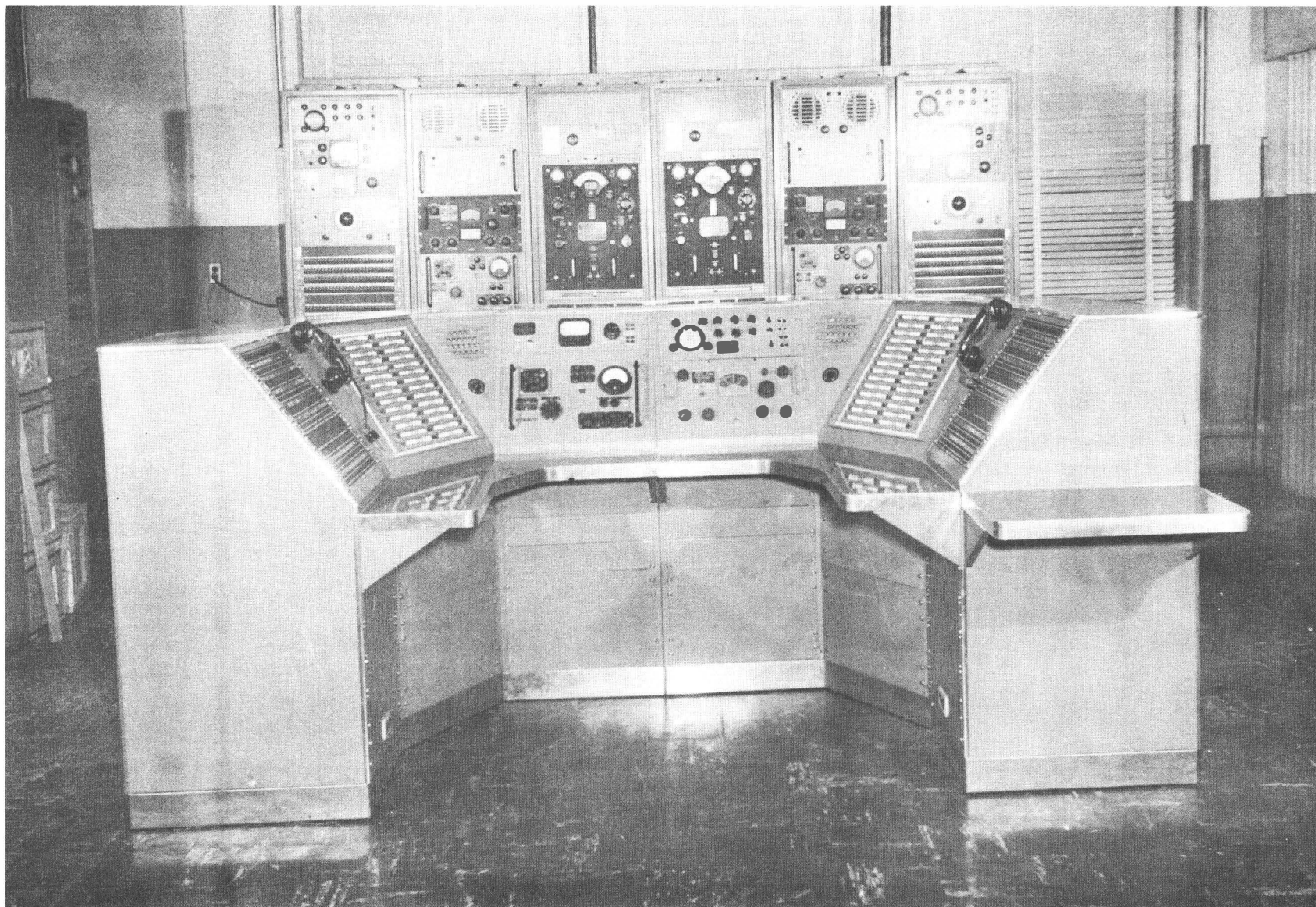

Model AN/FRQ-3 Transmitter Control - Monitor.

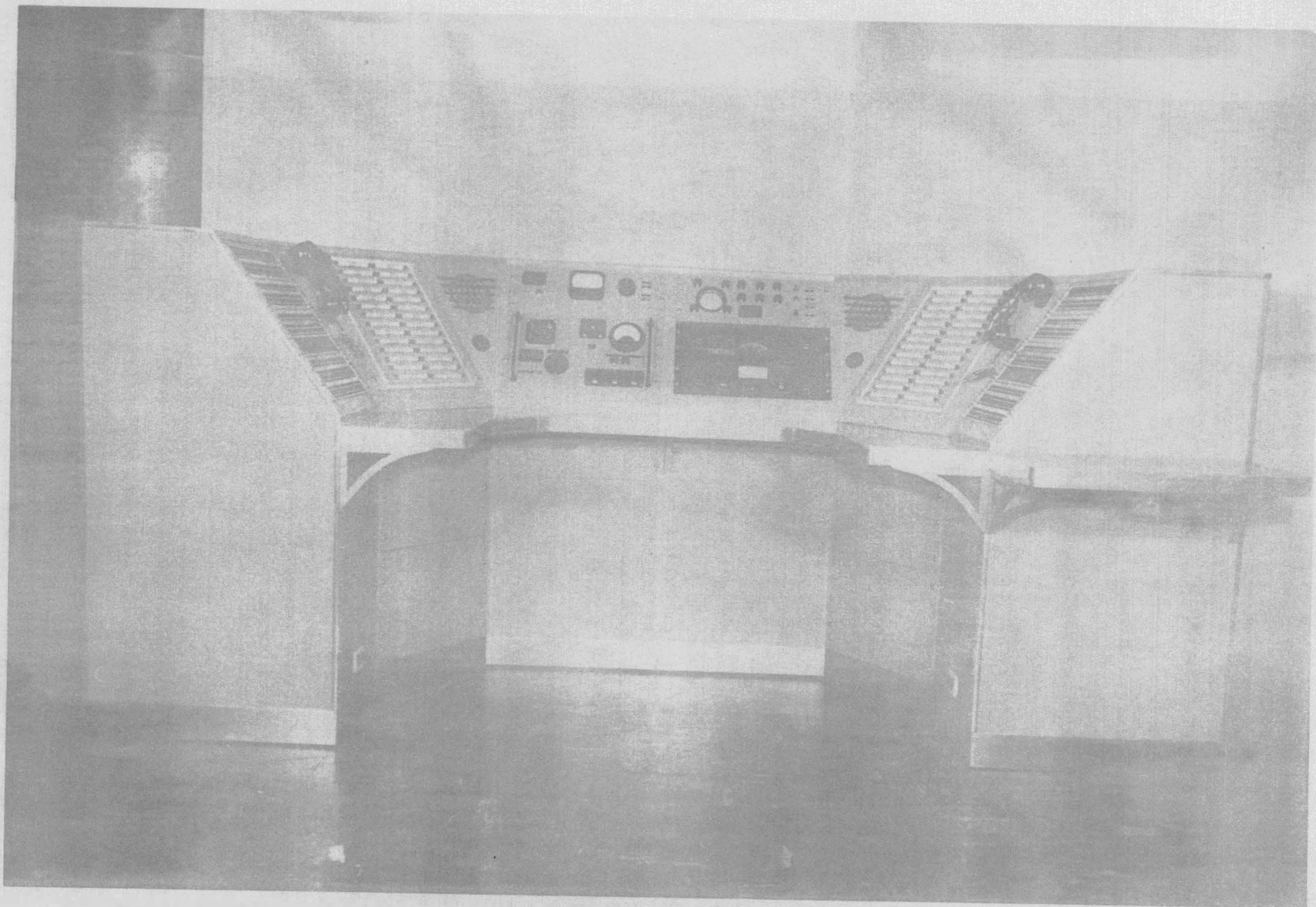

Front View of Communications Console.



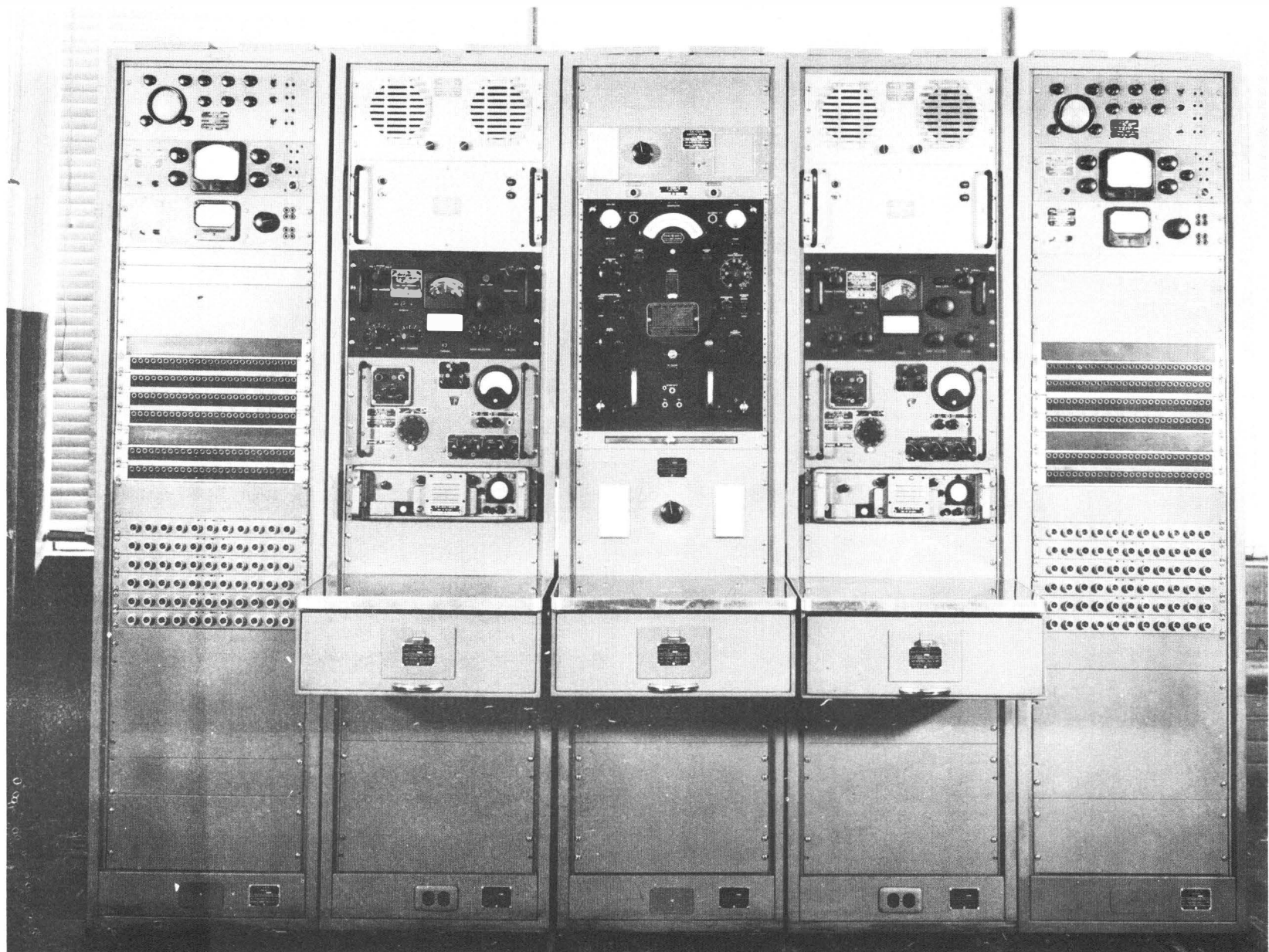

Console Monitoring Equipment "Frequency Monitoring Cabinets"



SECTION I

GENERAL DESCRIPTION

1. General Description

a. PURPOSE: The Navy Transmitter Control Console and Frequency Monitoring Equipment Model AN/FRQ-3 (See Figure 1-1), is a standard RF and AF manually operated switching and monitoring equipment for use in Naval Shore Transmitter Stations.

The equipment permits standardization of components, methods of installation and wiring, and provides maximum operational flexibility when installed.

b. DESIGN: To meet the requirements of paragraph 1.a. the following features are incorporated in the Transmitter Control Console and Monitoring Group.

The Navy Type OA-490/FRQ-3 Transmitter Control Console is delivered in two (2) sections, each section designed to mount standard 19" components. Basic operating procedures and components are the same for both sections, except for the console monitoring equipment, which is intended for use at either section of the console (See Figure 1-2).

The Navy Type OA-489/FRQ-3 Frequency Monitoring Equipment is delivered in five (5) cabinets, each cabinet designed to mount standard 19" panels (See Figure 1-3).

## SECTION Ia

DESCRIPTION TRANSMITTER CONSOLE  
NAVY TYPE OA-490/FRQ-3

The Transmitter Control Console consists of three (3) major sections as follows:

- (1) Jack Panel
- (2) Switching Panel
- (3) Monitoring Equipment

The Jack Panel (Figure 1-4) consists of jack positions capable of patching any of seventy-eight (78) channel outputs to any of seventy-eight (78) transmitter inputs. Wired with transmitter and channel jacks are monitoring indicators. These indicators display which channel and/or transmitter are activated.

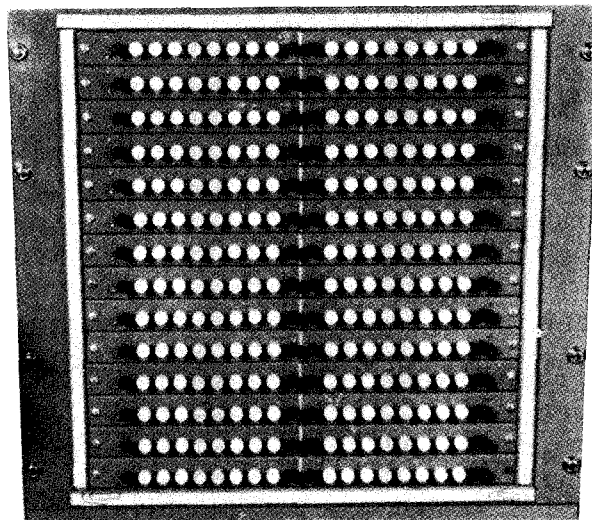

FIG. 1-4  
JACK PANEL (CONSOLE)

Parallel jacks are provided to facilitate the use of several transmitters simultaneously keyed from one signal source. The jack panel further provides a single row of monitoring, line and equipment jacks. This row of jacks is useable for link or wire line output and terminal equipment input. The jacks can also be used for line out and transmitter audio input.

The Switching Panel is designed for line and equipment type switching and consists of a stack of fourteen 20 key, two make contact, push key strips, of the self-restoring mechanical interlocking type, divided into two (2) sections of 10 keys each, mounted on a standard relay rack panel 19" wide by 17-15/32" high.

This assembly is complete with designation strips on front panel, removable back cover 10-1/4" deep with "Pushers" in the rear to assist in removing the key strips, male separable connectors to receive the key strips and the terminal strip for making connection to lines and equipments (See Figure 1-5). For wiring details refer to Figure 5-2.

The keys are wired to provide two separate cross bar switching systems each with 10 lines and 14 equipment circuits for a total of 20 lines and 28 equipments.

SECTION Ia

The switching panel selector keys are connected normal through from the related jacks. The transmitter jack pair number one connects to the first half

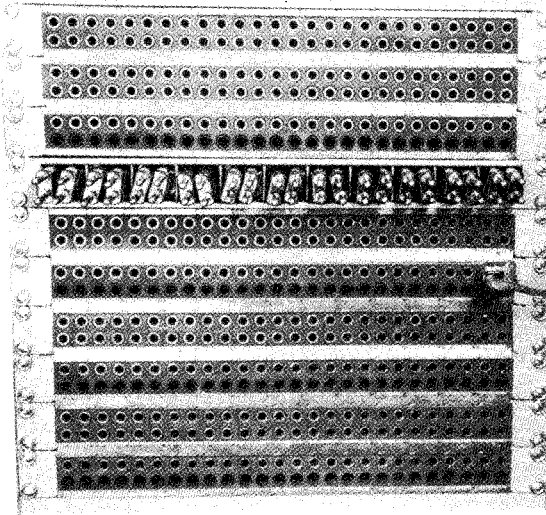

FIG. 1-5  
SWITCHING PANEL (CONSOLE)

of the horizontal row of selector buttons and channel jack pair number one connects to the first complete vertical row of selector push buttons. Thus transmitter number one can be connected to channels number one thru ten or channel number one can be connected to transmitters one thru fourteen by means of the mechanical selector keys. The wiring between jacks and push buttons and internal wiring of the push buttons has been accomplished by the manufacture, thereby no cross connects are necessary between the

jacks and selector push button keys. For wiring see Figures 5-2 and 5-3.

The Monitoring Section consists of the following:

- (1) Volume Level Indicator AN Type TS-629/U
- (2) Cathode Ray Oscilloscope, Navy Model OBL-3a
- (3) Volt-Ohm-Milliammeter, Navy Model OBQ-4
- (4) Radio Receiving Equipment, Model RCH
- (5) Audio Oscillator, Hewlett Packard Type 200 AB

The Volume Level Indicator (Figure 1-6) is intended to measure the relative volume of audio signals, and is used mainly to monitor incoming line or link

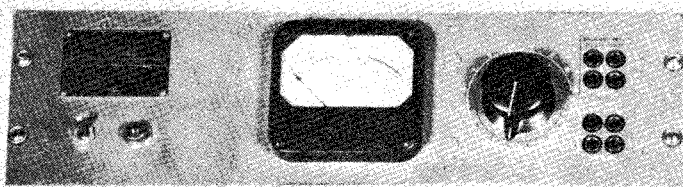

FIG. 1-6  
VOLUME LEVEL INDICATOR (CONSOLE)

audio channels. For a complete description of the physical properties and operation of this equipment refer to Instruction Book for Audio Level Test Panel TS-629/U, NAVSHIPS 91072.

## SECTION Ia

The Cathode Ray Oscilloscope, Navy Model OBL-3a, is an instantaneous indicating device for making electrical measurements. It can be used to visualize both recurrent and transient electrical phenomena such as analysis of audio frequency distortion, amplifier gain or overload, phase shift, etc., and is mainly used for measurement of frequency spread of FSK Transmissions. It provides sweep repetition rates of 7 to 30,000 cycles (See Figure 1-7). For complete information refer to NAVSHIPS 900,224-1B.

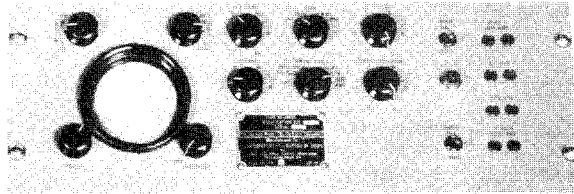

FIG. 1-7  
CATHODE RAY OSCILLOSCOPE (CONSOLE)

The Volt-Ohm-Milliammeter, Navy Model OBQ-4 (See Figure 1-8) is a combination AC and DC voltmeter, ohmmeter and milliammeter which can be used wherever it is necessary to make voltage, resistance, and current measurement, and is used mainly to monitor keying voltages on the patch board. For more complete information refer to NAVSHIPS 900,988 Instruction Book for Vacuum Tube Volt-Ohm-Milliammeter.

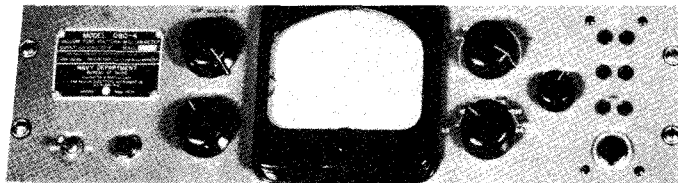

FIG. 1-8  
VOLT-OHM-MILLIAMMETER

The Radio Receiving Equipment, Model RCH, is suitable for monitoring equipment at Naval Radio Shore Stations.

The receiving equipment covers the frequency ranges of 80 to 560 kilocycles and 1.9 to 24 megacycles in five frequency bands. The equipment is suitable for the reception of radio telephone or telegraph signals (either CW or MCW) by either headphones or loudspeaker. For detailed instructions refer to Instruction Book for Radio Receiving Equipment, Model RCH.

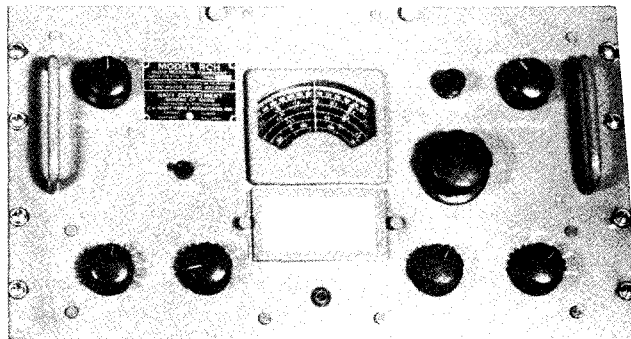

FIG. 1-9  
RADIO RECEIVER-RCH



SECTION Ia

The Audio Oscillator is designed for general purpose audio testing and measurements of FSK spread. The resistance-capacity oscillator used in this instrument will retain its high degree of

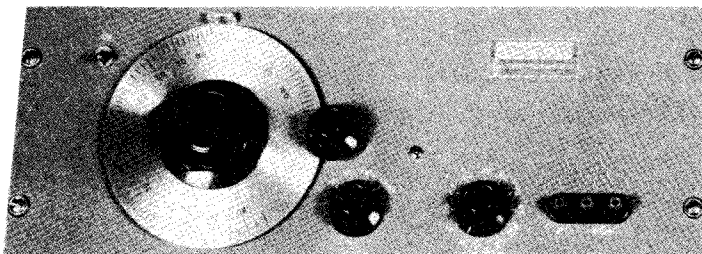

FIG. 1-10  
AUDIO OSCILLATOR

accuracy for long periods of time with no adjustment. The push-pull output amplifier used in this equipment has a large amount of overall negative feedback for maximum stability and low distortion. The output impedance of the instrument is 600 ohms balanced or unbalanced. The output voltage is 24.5 volts

(1 watt) across 600 ohm resistive load over the full range of 20 to 40,000 cycles/second and is sufficient for modulating voice transmitters as a means of checking percentage of modulation in conjunction with the receiver and oscilloscope.

For a plan view showing audio jack field, push key strip, speakers, monitoring section and mounting dimensions refer to Figure 5-3.

## SECTION Ib

DESCRIPTION MONITORING GROUP  
NAVY TYPE OA-489/FRQ-3

The Monitoring Group consists of three major sections as follows:

- (1) RF/AF Jack Position
- (2) RF/AF Switching Position
- (3) Monitoring Equipment

The RF Jack Panel (Figure 1-11) consists of one hundred and thirty-two Navy Type ClA-491388 RF Jack Switches, eighty of which are used to monitor transmitter frequency, and the remaining fifty-two for miscellaneous use. (A typical plan for such installation is shown in Figure 5-4).

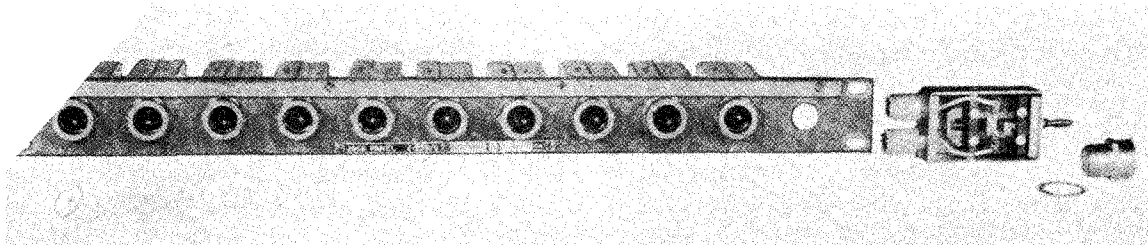

FIG. 1-11  
RF JACK PANEL AN TYPE J-239/G

The design of the Jack Switch is such that when no patchcord is inserted into the front receptacle the two rear connectors in the Jack Switch are bridged together with a sliding silver alloy contact. The monitored signal is therefore applied to the RF Jack Switch (See Figure 1-11). When a patchcord is inserted in the front receptacle, the upper rear connector is disconnected from the circuit and the lower rear connector is connected with the inserted plug. This enables the operator to disconnect the normal RF coaxial switch and by patchcord connect directly to the LR Frequency Meter. For typical diagram refer to Figure 5-4.

The AF Jack Positions consists of 156 Western Electric Type 218A Jacks heavily insulated, singly mounted. These Jacks are wired as "normal through" to the audio switch (See Figure 5-13). The AF Jacks are wired using tips of patchcord plugs thereby requiring two jacks for each circuit.

The RF Switch Panel AN Type SA-138/G is a 60 position coaxial switch which consists of a silver plated brass contact ring in which specially constructed coaxial silver plated contacts are arranged in two concentric circles, each circle containing half the total number (See Figure 1-12). Each contact is surrounded by a polystyrene insulator which is fitted into an appropriate hole in the contact ring.

SECTION 1b

A connector screws into the bottom of the contact ring to mate with the silver contacts. The contacts protrude slightly above the plane of the contact ring. The rotor of the switch consists of an arm fitted with specially designed RF spring loaded coaxial fittings on each end which make contact with the contact ring. The arms are

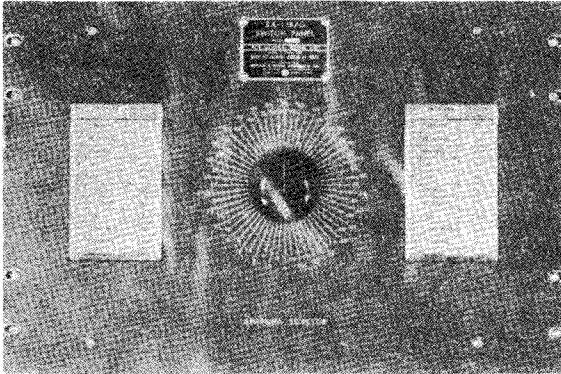

FIG. 1-12  
RF COAXIAL SWITCH

of different lengths so that one makes contact with the inner circle of contacts and the other makes contact with the outer circle. The contacts in the contact ring are staggered so that one arm is making contact while the other is between contacts. A suitable detent mechanism is included which insures positive positioning of the rotor at the proper point.

The AF Switch AN Type SA-135/G is a selector type, non-shortening, non-grounding construction (See Figure 1-13). This

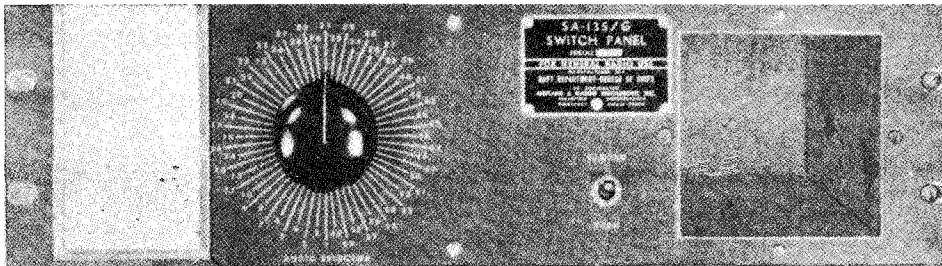

FIG. 1-13  
AF SELECTOR SWITCH

switch contains two (2) sections, one for each side of the circuit. It consists of two synthane wafers with silver plated contacts. It is continuously rotatable to any of 60 positions.

The Monitoring Section consists of the following:

QUANTITY	DESCRIPTION	NAVY TYPE
2	Cathode Ray Oscilloscope	Model OBL-3a
2	Audio Oscillators El-Tronics	Model TE200K
2	Antenna Coupler	Model CU-168/FRR

## SECTION Ib

2	Radio Receiving Equipment	Model RCH
2	Frequency Shift Converter	Model CV-60/URR
2	Speaker Panels	LS-139/G
1	Frequency Meter	Model LR-1 or FR/36U

The Cathode Ray Oscilloscope, Navy Model OBL-3a, is identical to the scope used in the Console Monitoring Equipments, refer to Figure 1-7.

The Audio Oscillator El-Tronics Type TE200K (See Figure 1-14) is of the resistance tuned type employing both positive and negative feedback for constant output voltage. This model features highly accurate dial calibration, excellent stability, and constant output voltage. The purpose of the audio oscillator is for checking frequency spread of FSK type of emission or modulation percentage check.

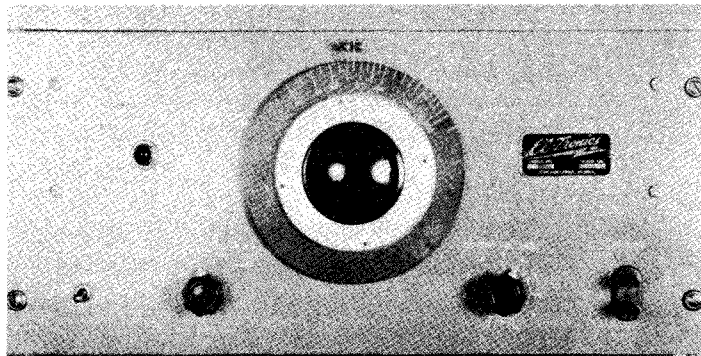

FIG. 1-14  
AUDIO OSCILLATOR

An electronic regulated power supply is incorporated for stable operation even with large line voltage fluctuations. All circuits are designed for stable operation under extreme conditions of humidity and wide temperature ranges.

The Antenna Coupler CU-168/FRR (See Figure 1-15) provides means for operating up to five Navy Communications Receivers from a single antenna, and may be used to provide antenna outputs to the repair shop or other testing facilities in addition to requirements of the console and monitor bays. The equipment is complete with power supply and contains all necessary parts and circuitry to provide the specified performance.

FIG. 1-15  
ANTENNA COUPLER CU-168/FRR

SECTION Ib

The input circuit to which the antenna is connected is designed for operation from an unbalanced antenna transmission line having a nominal impedance of 70 ohms. This equipment permits operation over the frequency range of 2 to 32 megacycles per second. No adjustment or tuning is required. For detailed information refer to NAVSHIPS 91697, Instruction Book for Antenna Coupler CU-168/FRR.

Radio Receiving Equipment, Model RCH, is identical to that used in the Console Monitoring Equipment refer to Figure 1-9.

This Frequency Shift Converter Model CV-60/URR (See Figure 1-16) is designed to operate on frequency shift keyed radio tele-

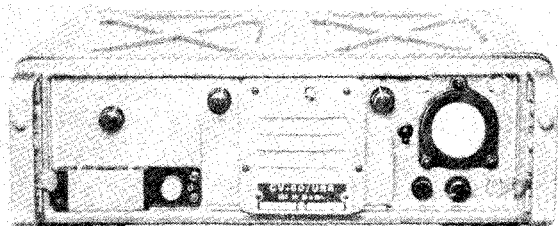

FIG. 1-16  
CV-60/URR FREQUENCY SHIFT CONVERTER

graph signals as derived from the audio-frequency outputs of communications receiving equipments, to provide keying facilities for the operation of teletype printers or other similar automatic recording devices. Its purpose is to provide an "off the air" monitor of FSK transmission when used in conjunction

with the RCH receiver and a TTY monitor machine. For detailed information refer to Instruction Book for Frequency Shift Converter CV-60/URR, NAVSHIPS 91339.

Speaker Assembly AN Type LS-139/G (See Figure 1-17) is a size E panel on which are mounted two Navy Type CPS-491814 permanent magnet speakers

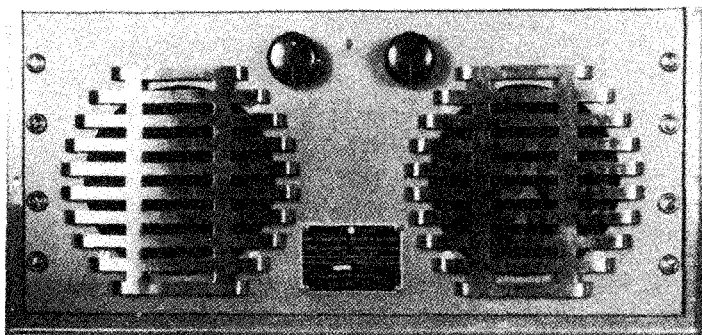

FIG. 1-17  
SPEAKER PANEL ASSEMBLY

with an attenuator for each. Output transformers are mounted on speaker frames for impedance matching. A terminal board containing two screw connectors is provided for each speaker.

## SECTION Ib

The Frequency Meter, Navy Model LR (Figure 1-18) or AN/FR-36U is intended to measure frequencies from 160-30,000 KCS. It consists of a single unit containing the power supply, heterodyne frequency meter, crystal calibrator, detector-audio amplifier, and electronic frequency meter. For complete information refer to the Instruction Book entitled "Combined Heterodyne Frequency Meter and Crystal Controlled Calibrator Equipment Model LR", or FR-36U Data Book.

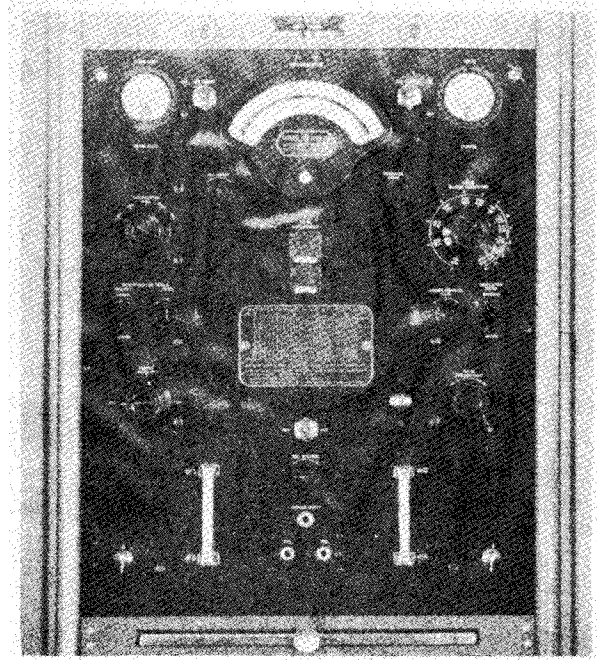

FIG. 1-18  
FREQUENCY METER LR

All test equipment appears on equipment jacks and the following is a summary:

The outputs of the Audio Oscillators in Cabinets 7 and 11 appear on equipment jacks number 17 and 18 in Cabinets 7 and 11.

The inputs for the OBL-3a Scopes in Cabinets 7 and 11 appear as follows: The vertical plates on equipment jacks number 19 and 20 in Cabinets 7 and 11 and the horizontal plates on equipment jacks number 21 and 22 in cabinets 7 and 11.

The output of the RCH Receiver in Cabinet number 8 appears on equipment jacks number 9 and 10 in Cabinet number 7. The output of the RCH Receiver in Cabinet number 10 appears on equipment jacks number 9 and 10 in Cabinet number 11.

The input to the CV-60 Converter in Cabinet number 8 appears on equipment jacks number 11 and 12 in Cabinet number 7, and the output appears on equipment jacks number 13 and 14 in Cabinet number 7. The input to the CV-60 Converter in Cabinet number 10 appears on equipment jacks number 11 and 12 in Cabinet number 11 and the output on equipment jacks number 13 and 14 in Cabinet number 11.

The Audio output of the LR appears on equipment jacks number 15 and 16 in both cabinets number 7 and 11.

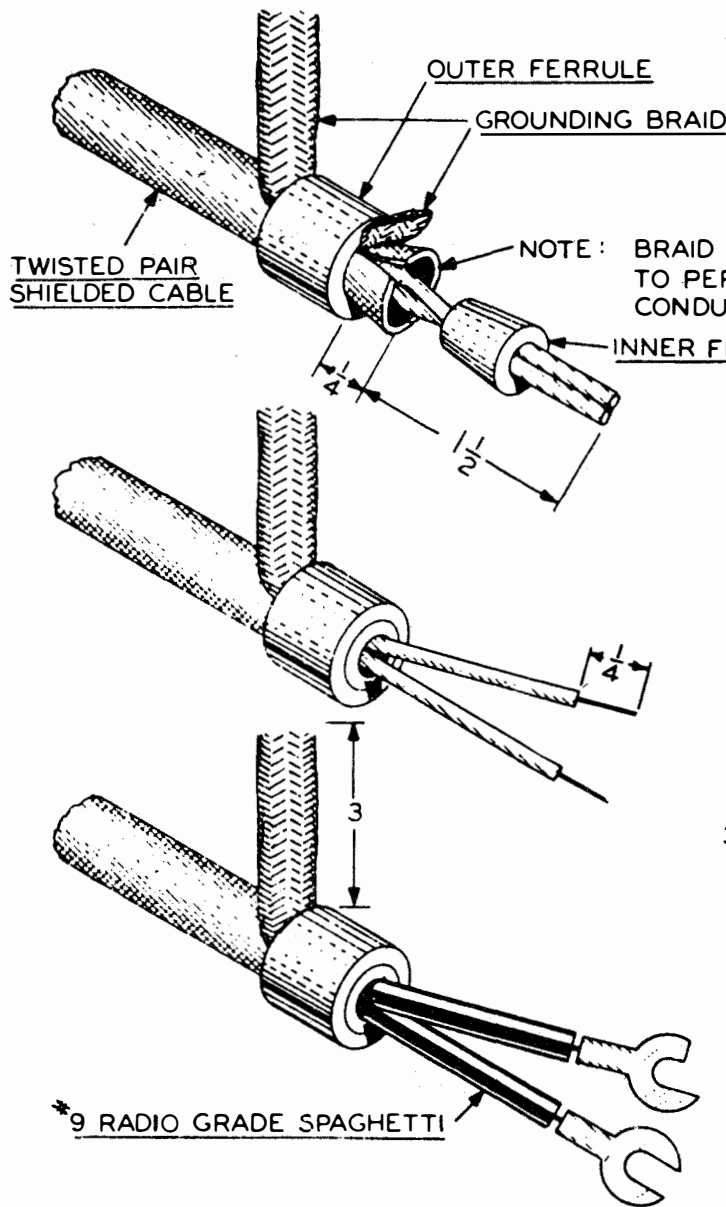

1. SLIP BACK METAL SHIELD ABOUT 1 1/2 INCHES SLIP PIECE OF 1/4 INCH METAL BRAID THROUGH THOMAS & BETTS OUTER FERRULE \*200-30006 AND SLIP FERRULE OVER BRAID OF TWISTED PAIR. SLIP INNER FERRULE OVER CONDUCTORS.

2. PRESS INNER FERRULE INTO OUTER FERRULE USING THOMAS & BETTS WEDGE-ON PLIERS \*21000 OR EQUIVALENT. THE BRAID WILL AUTOMATICALLY TRIM SKIN CONDUCTORS AS SHOWN.

3. SLIP \*9 RADIO GRADE SPAGHETTI 1 INCH LONG OVER EACH CONDUCTOR AND CRIMP AND SOLDER ON SUITABLE SPADE LUG. CLIP SPADE LUG ON EACH END OF ONE CONDUCTOR TO INDICATE POLARITY. CUT GROUNDING BRAID TO 3 INCHES AND SOLDER TO GROUND BUS.

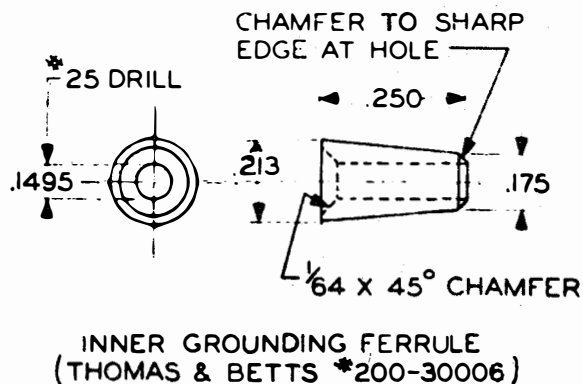
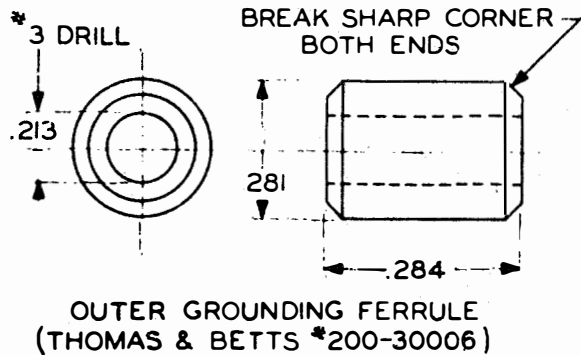

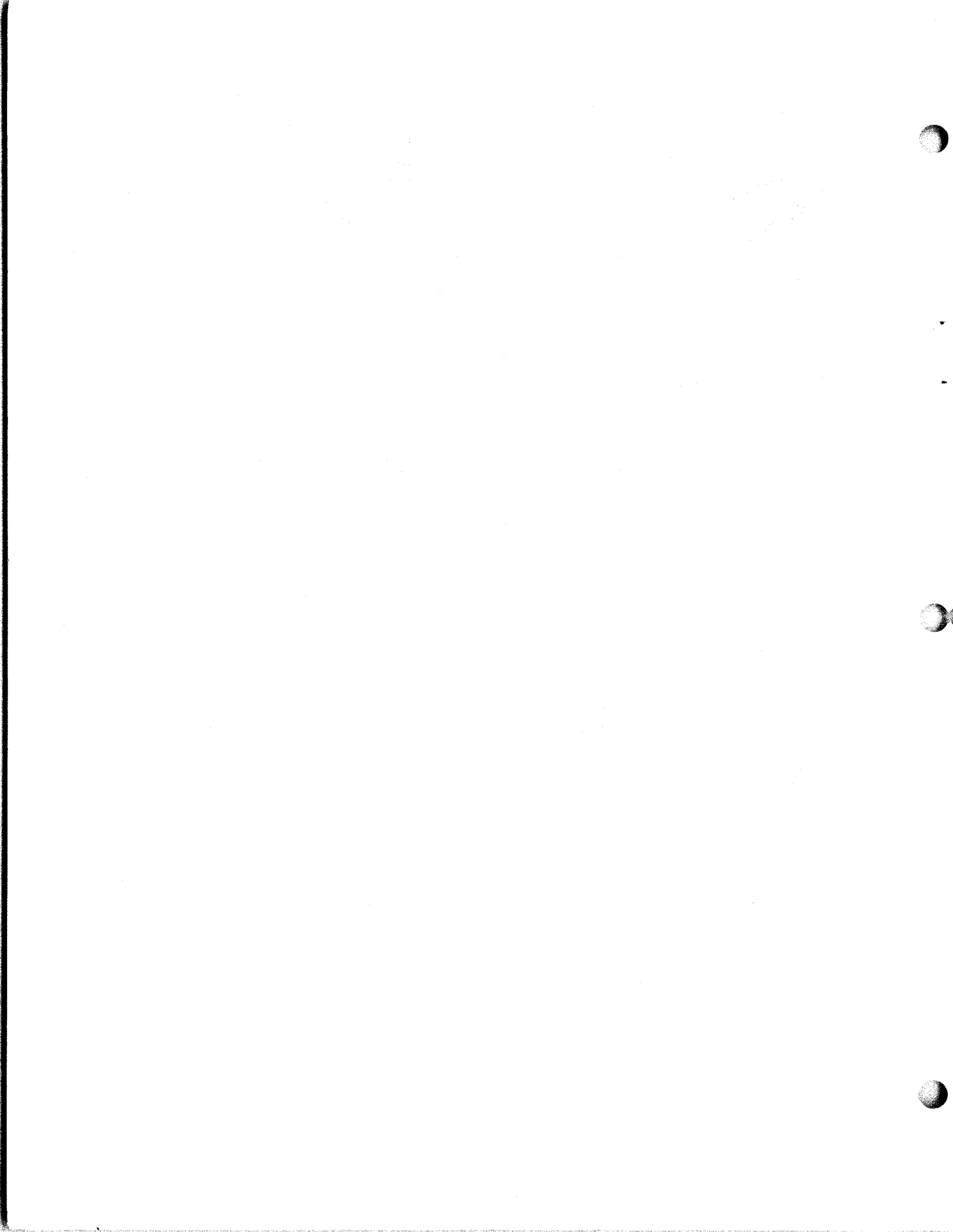



SECTION 1b

TYPICAL HOOKUPS

TTY HOOKUP

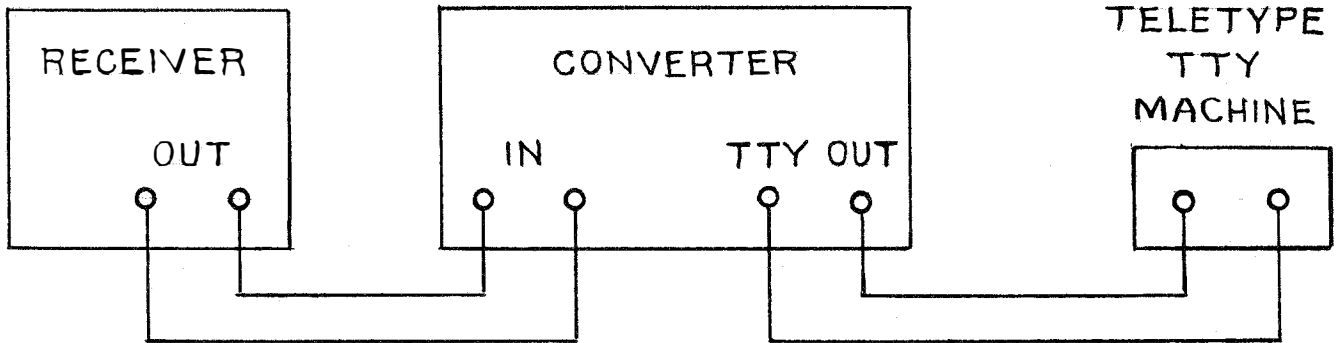

FSK MEASUREMENTS

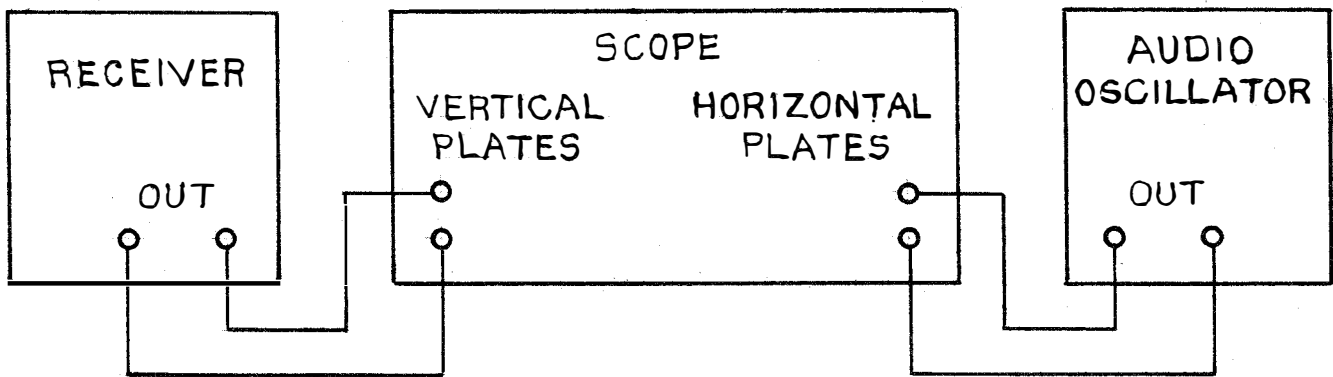

MULTICOUPLER HOOKUP

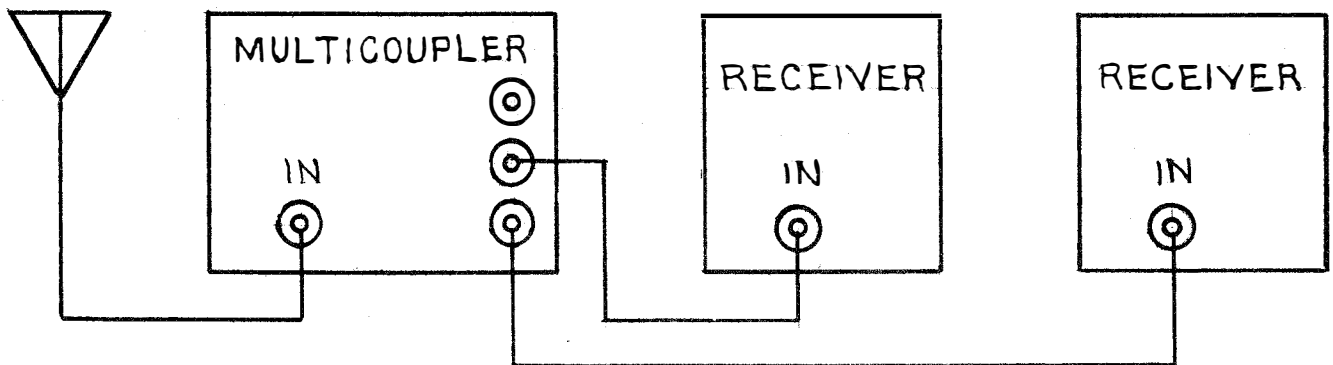

## SECTION II

INSTALLATION OF TRANSMITTER CONTROL CONSOLE  
NAVY TYPE OA-490/FRQ-3

This section includes instructions relative to the installation of the Transmitter Control Console. Since this equipment is quite flexible and may be varied in its application the instructions are based on a typical installation only. The installing activity may find it desirable to depart from procedures outlined herein by adding trunk wiring or other circuitry to fit the operating procedures peculiar to the operating activity. It is however desirable to maintain standardization throughout all installations in so far as practical.

In selecting the location for the transmitter control console within a station, several factors must be considered. In general this equipment should be centrally placed so as to be readily accessible to the supervisor of the watch and in such a position that he will have unobstructed view of the operators from his normal position in front of the unit. All installations should allow 42" to the rear of the console to permit maintenance personnel to work with the rear doors open. For floor plan details refer to Figure 5-19.

Since the two sections of the console butt together, it is necessary that mounting surfaces be true and level or gaps will appear between sections, and when fastened together additional strain will be placed against center sections of the console leaving a gap between floor and mounting frame of the console units. In cases where level surfaces are not available necessary shim material must be incorporated.

Before positioning the console a drilling template should be made from the plan as shown in Figure 5-6. Two large openings are required under frames No. 1 and 6. (See Figure 5-3) for incoming and outgoing signal cables. These openings should be approximately 18" x 6". Care must be taken in positioning these holes so that no structural members of the flooring are cut. In addition to the above openings two smaller holes, one each should be located under console frames Nos. 3 and 4, these holes are for power wiring of the two sections of the console. These holes should have an opening no larger than that necessary to feed a one half inch standard conduit or thin wall tubing.

The power wiring required to operate the Transmitter Control Console should be sufficient to carry 115 volts, 60 cycle, single phase, at 20 amps, two circuits required. The terminations for power wiring is available in cabinets Nos. 3 and 4. For power wiring details refer to Figure 5-7.

The internal wiring between the jack panel and push buttons has been accomplished by the manufacturer. This wiring conforms to the plans as shown in Figure 5-1 (Control Console Jack field wiring details) and 5-2 (Wiring diagram for switching unit). The external wiring between the Console, terminal equipment frame, and transmitters, should be accomplished in accordance with Figures 5-8 and 5-9

## SECTION II

(Cabling diagrams for Transmitter Control Console). All in and out pairs from the console should terminate on a main wire frame. This simplifies future circuit changes. The only change to be made for any future circuit change is the cross-connections between the jacks and the equipments. No other wiring need be touched.

The terminals on the boards are numbered in pairs. These numbers correspond with the pairs of similarly numbered Jacks on the Jack strips. Figures 5-8 and 5-9 are a typical connection diagram. The actual connections will of necessity be determined by the needs of the individual station. It is important, however, that all terminal pairs be wired identical to each other. This can best be accomplished by first determining which Jack will be positive and which will be negative. If, for example, all Jacks on the left of each Jack pair are considered positive, then the keying voltage to the channel input Jacks should be wired accordingly. Following the diagram in Figure 5-1 connect the positive side of the channel output keying voltage to terminal board T-113 terminal number one (1) and the negative side to terminal number two (2). In order to complete this circuit it is important that the transmitter input keying voltage is connected in a like manner. Again following the diagram in Figure 5-1 connect the positive side of the transmitter input keying voltage to terminal number one (1) on terminal board T114 and the negative side to terminal number two (2). After completing this wiring the circuit should be checked by means of a battery and a DC voltage meter. Using a step-by-step procedure first connect the battery to the tips of the channel output Jack observing the polarity, and check the auxiliary contacts on terminal board T-101. If no reversals are observed, press the first selector push button for channel one (1), transmitter one (1) than connect the volt meter to terminal board T-114 terminals one (1) and two (2), again observe the polarity. If there is no difference in polarity between the input and output Jacks than this circuit is properly connected and the next circuit should be wired. It is important however to check each circuit for polarity and continuity before proceeding to wire the next circuit.

In making the connections on the terminal strip end of the wiring it is recommended that Thomas and Betts Grounding Ferrules #200-20006 or the equivalent are used, these ferrules are installed as illustrated in Figure 2-1. To connect the transmitter carrier indicator the RF monitor unit (See Figure 2-2), must first be installed on the appropriate transmitter. This monitor unit is capacitively coupled through an RF probe to the transmitter antenna feeders. Coupling of this unit should be sufficient to supply only enough energy to ionize the 2050 tube. Do not install unit within transmitter cabinet. This will then supply enough voltage to ionize the neon indicator at the RF monitor unit and the indicator on the control console panel. The potentiometer as shown in Figure 5-10 is for fine adjustment, care should be taken in

## SECTION II

making this adjustment so that adjacent transmitters will not energize the RF monitor unit thus giving a false indication. This RF monitor unit incorporates an untuned circuit and no adjustment should be necessary after the initial installation. It should be further noted that this indicator will only indicate when the carrier is on.

After the above has been accomplished it is then necessary to install two leads from the terminal block located inside the RF monitor unit to the transmitter console terminal boards T-110 thru T-112 and T-610 thru T-612. (The sequence by which these lamps are to operate is left to the judgment of

the individual station to fit their operational requirements). A rubber grommet has been provided in the side of the monitor unit for ease of installing these wires. This RF monitor unit requires 115/230 volts AC at 15 watts input power. These monitoring units have been wired for 230 volt input - if 115 volt input is desired - change of the primary tap on the filament transformer is required.

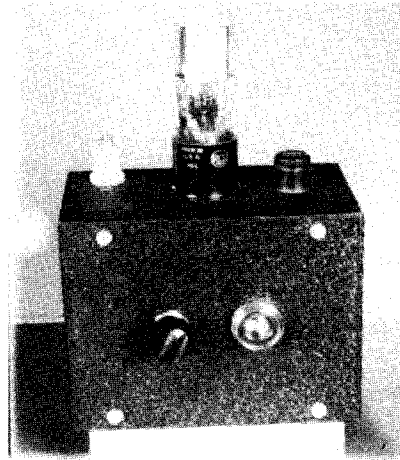

FIG. 2-2  
RF MONITOR UNIT

## SECTION IIa

INSTALLATION OF FREQUENCY MONITORING GROUP  
NAVY TYPE OA-489/FRQ-3

This section includes instruction relative to the installation of the Frequency Monitoring Group Navy Type OA-489/FRQ-3. Since this equipment is quite flexible and may be varied in its application the instructions are based on a typical installation only. The installing activity may find it desirable to depart from procedures outlined herein by adding trunk wiring or other circuitry to fit the operating procedures peculiar to the operating activity. It is however desirable to maintain standardization throughout all installations in so far as practical.

In selecting the location for the frequency monitoring group several factors must be considered. In general this equipment should be centrally placed so as to be readily accessible to the supervisor of the watch and the operations personnel. This unit must operate in conjunction with all transmitting equipment thereby necessitating the unit to be located accordingly. All installations should allow 42" to the rear of the cabinets to permit maintenance personnel to work with the rear doors open. Sufficient room must be allowed in front of the frequency monitoring group to allow personnel to operate this equipment (See Figure 5-19).

Since this equipment is delivered in five (5) separate cabinets it is recommended that a mounting base be fabricated of hard wood, which will allow a minimum of 3" opening between the bottom of the cabinets and the floor. This opening is necessary for inter-connecting cables between cabinets.

Before positioning the frequency monitoring group a drilling templete should be made. This templete requires a large 12" x 8" opening under cabinet numbers 7 and 11 for incoming and outgoing cables. In addition to these openings three smaller holes, one each should be located under cabinets 8, 9, and 10, these holes are for power wiring of the frequency monitor group cabinets and should be no larger than is necessary to feed a one-half inch standard conduit or thin wall tubing.

The power wiring required to operate the frequency monitor group should be sufficient to carry 115 volts single phase at 10 amps, five such circuits required, one each to be terminated in cabinets 7 thru 11. The termination for the power wires is available in these cabinets, refer to Power Distribution Diagram, Figure 5-12.

In wiring the Frequency Monitoring group, cabinets number 7 and 11, consideration must be given to the types of operations that are necessary. One method of selection is to have the frequency monitoring groups divided into two sections. Cabinets numbers 7 and 8 to operate with all transmitting equipment in one half the building and cabinets numbers 10 and 11 to operate with

## SECTION IIa

all equipments in the remaining half of the building. This can be easily accomplished as cabinets 7 and 8 are identical to cabinets 10 and 11. This leaves cabinet number 9 to operate common with both sections. If wiring is to be accomplished by the above outlined method then it will only be necessary to inter-connect one half of the audio switch and RF switch located in cabinet 9 to cabinet 7 and the remaining half of these switches to cabinet number 11. This type of installation can be used to control a greater quantity of transmitters through the patch boards leaving ample space for expansion. An installation of this type is shown by Figures 5-4 and 5-13. Following the RF circuit as shown in Figure 5-4 the incoming signal is first terminated in RF switching jack field cabinet number 7. Using the total RF switch capacity, the number of equipments which can be terminated in this cabinet, will be sixty (60). The manufacturer has wired the RF Jack switch to a rear panel, which is hinged mounted. This panel will terminate RG-59/U coaxial cable directly to the chassis connectors provided. Due to the separation between cabinets 7 and 9 the inter-connecting cables must be supplied by the installing activity. These inter-connections are to be terminated between Jacks 1 thru 30 in cabinets number 7 to the RF switch positions 1 thru 30 in cabinet number 9. In a similar manner inter-connections are required between cabinet number 11 and 9. In this case Jack 1 thru 30 will be connected to RF switch position 31 thru 60. This being a 60 position RF coaxial switch its capacity is limited; namely, thirty (30) equipments from cabinet 7 and thirty (30) equipments from cabinet 11. This however does not limit the total number of equipments to sixty (60) units. In each of cabinets 7 and 11 in the Frequency Monitor group there are sixty-six (66) RF Jacks. These jacks can be used for the termination of additional equipments. This type of installation could be accomplished by using six (6) RF Jacks for paralleling between cabinets number 7 and 11 and forty (40) Jacks in each of these cabinets to give frequency monitoring control to a total eighty (80) transmitters, of this eighty (80), sixty (60) are "normalled through" to the RF coaxial switch. (For typical panel layout plan refer to Figure 5-15). In wiring the RF termination points each of the incoming cables should be checked for continuity before attaching the coaxial connector. Referring to Figure 5-4 the incoming RF cable is terminated to the main contacts of the RF Jack Switch. From this RF Jack switch the auxiliary contacts are connected to the input of the RF coaxial switch which is common through to the LR Frequency Meter RF input Jack. In making the installation, as mentioned above, the RF coaxial switch can be by-passed with the use of RF patchcords.

To wire the audio section of the Frequency Monitoring group refer to Figure 5-17. This diagram shows the wiring from the audio switch which is located in cabinet number 9 to the terminal blocks T-901 thru T-906. In order to connect the audio switch to cabinet number 9, it will be necessary to sequentially wire terminals one (1) thru thirty (30) from the audio switch to Jacks one (1) thru thirty (30) in cabinet 7. (See Figure 5-19). In the same manner terminal numbers thirty-one (31) thru sixty (60) on the audio switch are to

## SECTION IIa

be wired to Jacks one (1) thru thirty (30) in cabinet number 11. (See Figures 5-14, 5-16 and 5-17).

In inter-connecting the RF Jacks in Cabinets 7 and 9 to RF Switch use RG-59/U cable, terminated on each end with an Amphenol Connector Plug #31-012, Type UG-260/U.

All Audio Jacks should be wired with shielded wire, #22 or #20. Runs between Monitor Bay and Frame should use shielded cable in multiple pairs and runs between equipment and bays may use either multiple cable or single pairs whichever is satisfactory.

## SECTION III

OPERATION OF TRANSMITTER CONTROL CONSOLE  
NAVY TYPE OA-490/FRQ-3

The transmitter control console is divided into three operating sections, each of which are duplicated excepting the monitor or test equipment section. These three sections consists of a patching facility section, automatic push button section, and a monitoring section. The push button section is the most important as it is wired "normal through" the patching facility. To operate this equipment the operating personnel should be thoroughly familiar with the physical arrangement of this section of the console. The push buttons are located in consoles frames number one and five. (See Figure 5-3). This will allow the operator to control a total of forty channel output circuits to a total of fifty-six transmitter input circuits without the use of external patchcords. The switch panels are divided into four banks each of which are capable of connecting any one of ten output channels to any one or multiple of fourteen transmitter inputs, or ten channels to a maximum of a combination of fourteen transmitters.

There are twenty channel output circuits numbered one to twenty across the top of each automatic push button section and twenty circuits numbered one to fourteen and fifteen to twenty-eight listed vertically at the left of each section.

Each key (button) when operated connects two circuits.

To connect a piece of equipment with a selected channel output, press key at intersection of channel output and transmitter input key rows.

A key, when pressed, locks in position and at the same time automatically releases any key in the same horizontal section of ten keys which has previously been operated.

Only one key may be locked in position in any horizontal section of ten keys, by reason of the mechanical interlocking feature, whereas, as many keys as desired may be locked in position in the vertical row of fourteen keys. In other words, channel output circuits cannot be locked together; whereas, any one channel output circuit may be connected (in multiple) with as many transmitter input circuits as desired within the capacity of the push button unit. If, for example, channel output circuit number five is to be connected to transmitter input circuit number seven, count over the horizontal row of push buttons until number five is located than count down the vertical row until key number seven is located. When this key is depressed, the circuit will have been completed. (Refer to Figure 3-1). Another example of a more complex operation would be to connect channel output number sixteen to transmitters number seven-teen, twenty, twenty-five and twenty-eight. To accomplish this it is again necessary to locate channel sixteen in the horizontal row of buttons, then count down the vertical row and locate transmitter



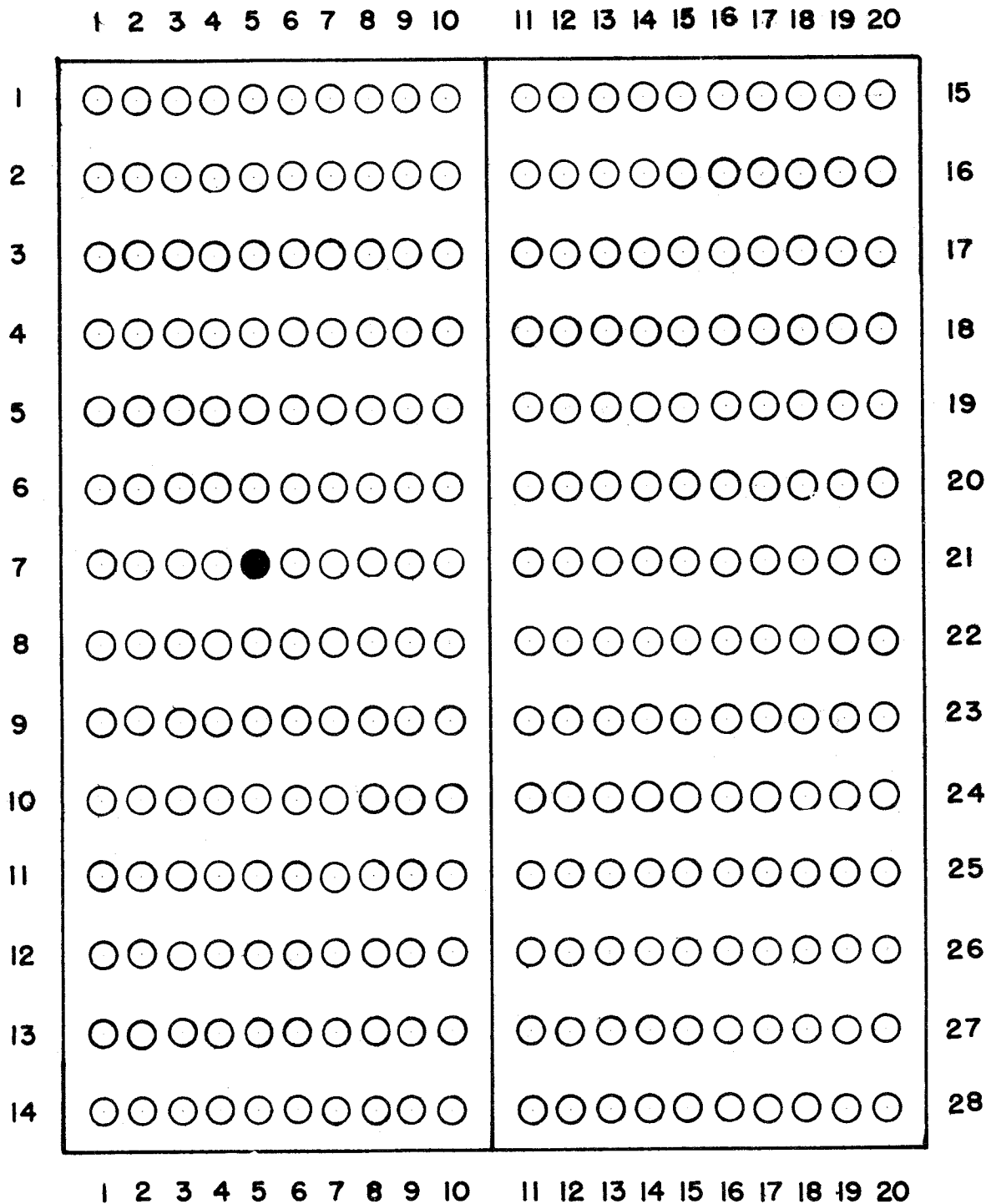

FIGURE 3-1

LOCATION OF SELECTOR KEY TO CONNECT  
TRANSMITTER NUMBER SEVEN TO CHANNEL NUMBER FIVE

## SECTION III

input circuits number seventeen, twenty, twenty-five, and twenty-eight. When each of these keys are depressed all transmitters are paralleled on the same OUTPUT channel. (Refer to Figure 3-2). The above description outlines some of the automatic features of the transmitter control console; however, this console also incorporates patching facilities, which will allow the operator to control a greater quantity of channel output circuits and transmitter input circuits. These jacking facilities are located in console frames numbers one and six. (Refer to Figure 5-3). In each of these frames Jacks have been provided to control thirty-nine transmitter input circuits and thirty-nine channel output circuits. These Jacking circuits are wired for "normal through" operation. When a Jack plug is inserted in either the channel output circuit or the transmitter input circuit the related push buttons are disconnected. With this in mind, the operator should take the necessary precautions to avoid the possible error of using the automatic push button circuit when a patchcord is inserted.

The operator should be familiar with the patching arrangement of the transmitter console before proceeding with operation. One of the important phases of operating this patch facility is to have the same polarity throughout any single circuit. The method to accomplish this is by utilizing the serrated part of the patchcord plug. If, for example, it is predetermined that the serrated part of the patchcord plug should be located to the left side, then all patchcord plug serrations throughout the console should be located in the same direction for the serrated part of the patchcord plug is of little importance; however, it is very important to maintain a standard which all operators can follow.

The operator should study the various phases of operation, which can be obtained through the patchcord unit.

The examples given are based on the patchboard being wired in a sequential pattern. Channel output circuit number one is located with transmitter input circuit one, starting at the top group of channel monitor one, channel out, and transmitter-in Jack numbered sequentially from left to right.

In the transmitter control console patchboard two Jacks are required per circuit (using Jack tips only). This will give thirteen circuit groups per row, and three rows, providing a total of thirty-nine circuit groups per patchboard frame.

A typical example for operating the patchboard is to complete the circuit between channel output number five to transmitter input number thirty-nine. The operator counting across the top group of channel Jacks until he locates channel number five insert a patchcord plug in channel number five Jacks. Locate transmitter input Jack number thirty-nine and insert the opposite end of the patchcord plug. Check for polarity by observing the serration on each end of the patchcord plugs.

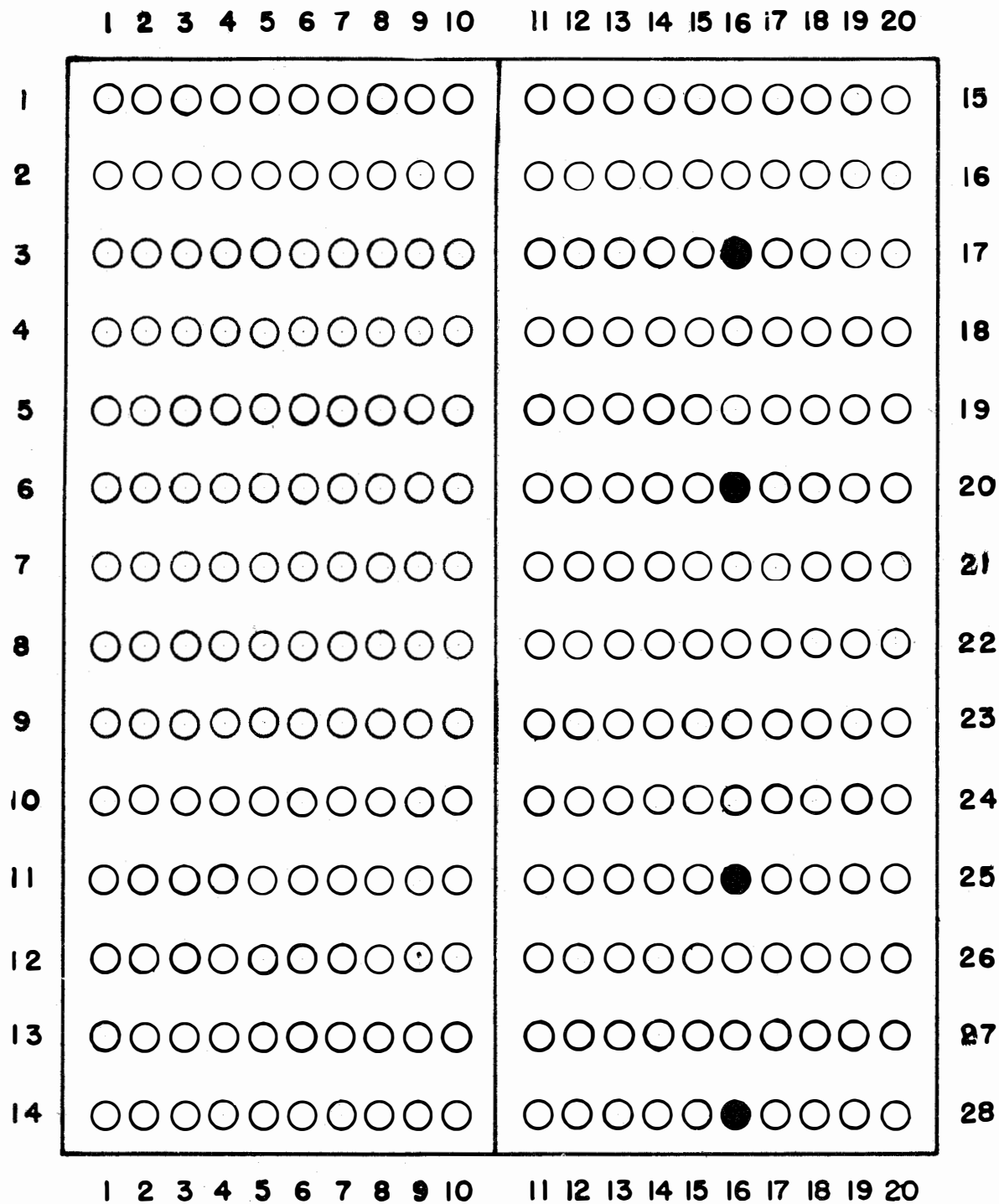

FIGURE 3-2

LOCATION OF SELECTOR KEY TO CONNECT  
TRANSMITTER NUMBER SEVENTEEN, NUMBER TWENTY, NUMBER TWENTY-FIVE  
AND NUMBER TWENTY-EIGHT TO CHANNEL NUMBER SIXTEEN

## SECTION III

A more complex connection would be to connect channel output circuit number three to transmitter input circuits numbers three, seven, nine, and eleven. To accomplish this mode of operation, the operator must use the parallel jacks, which are located at the bottom of the patchboard unit. By inserting a patchcord between the channel circuit jack number three and the parallel jacks - then a patchcord between the parallel jacks and each of the transmitter jacks number three, seven, nine, and eleven will complete these circuits. It is important at this point to note that the operator must insert a patchcord between the parallel jack group and transmitter number three even though channel number three is the controlling circuit. This is necessary because the channel jacks are normal through to the push button unit rather than the transmitter input circuits.

Another typical mode of operation is to use the combination of patchboard unit and selector push button unit. To provide a combined operation a typical problem would be to connect channel out circuit number one to transmitters input circuits numbers one, five, ten, and twenty-eight. To accomplish this it will first be necessary for the operator to press the buttons corresponding to channel output circuit number one to transmitter input circuits numbers one, five, and ten. This will complete the automatic push button circuits. However, due to the limitations of the selector push button unit, transmitter twenty-eight cannot be automatically selected. To provide for the completion of transmitter circuit twenty-eight, to channel circuit number one, it is necessary to use the monitor jack of channel output number one. When a patchcord is inserted between the monitor jack of channel circuit number one, and transmitter input circuit number twenty-eight, this will complete the circuits for this problem.

Other features which are incorporated in the transmitter control console, are channel indicators, and transmitter indicators. The channel indicators are 1/10 watt neon bulbs, which will ionize when a keying voltage is supplied to the channel output circuit. The transmitter indicators will indicate the transmitter carrier is on. This indication will be above the transmitter jack circuits that are being keyed. To demonstrate this type of visual monitor, suppose that channel output circuit number one is keying a group of transmitters. To determine which transmitters are being keyed the operator will first check the indicator above channel output circuit number one. If the bulb is ionized then the operator can check the transmitter indicators which correspond to the buttons pressed in the first vertical row. If, for example, transmitter keys number one, seven, and ten are pressed, then the indicators located above the corresponding transmitter Jacks should give the proper visual indication.

Top row monitor line and equipment Jacks are designed to terminate link receiver audio outputs, audio line outputs or telegraph terminal audio inputs. Patching between link or wire line outputs to telegraph terminal inputs may be accomplished in the normal manner.

Jack strip located at the bottom marked "audio" may be used for miscellaneous purposes such as transmitting audio input for modulation.

## SECTION III

A typical FSK measurement to determine carrier frequency shift of transmitters used in a frequency-shift system may be made at the console as follows:

1. The console receiver is tuned to zero beat with the desired carrier frequency with the receiver adjusted for CW operation and the transmitter in CARRIER condition.
2. The audio output of the console receiver is then patched to the vertical deflection plates of the OBL-3A oscilloscope using the console patching facilities.
3. The output of the H-P Model 200ABR audio oscillator is patched in a similar manner to the horizontal deflection circuit of the OBL-3A.
4. The audio oscillator is adjusted to provide an output of 425 c.p.s. at an amplitude sufficient to give a satisfactory horizontal presentation on the OBL-3A.
5. With the transmitter under measurement in a MARK keying condition, the resulting audio output of the console receiver is adjusted in amplitude to give a symmetrical Lissajou figure on the OBL-3A. This figure will be a 1/1 ratio when the frequency shift being observed is 425c.p.s.
6. The transmitter is then placed in a SPACE keying condition and again a 1/1 Lissajou figure should be observed on the OBL-3A indicating a maximum shift of 850 c.p.s. which is symmetrical about the basic carrier axis.

## SECTION IIIa

OPERATION OF FREQUENCY MONITORING GROUP  
NAVY TYPE OA-489

The frequency monitoring group equipments are divided into three sections for operation. These sections are the Jack facilities, the monitoring equipment, and the automatic RF and AF switching section. The operation of the various standard navy types of equipments are omitted from these operating instructions. For detailed explanation, of test equipment operation, refer to the appropriate instruction book. Instruction books for each piece of test equipment have been supplied with the transmitter control console.

The examples given in this section are made on the premise that all transmitter equipment referred to are sequentially wired to the RF and AF patchboard located in the frequency monitoring groups.

The operation, of the various test equipments used in the frequency monitoring group, is designed for standard frequency measurement methods now employed at most shore station transmitter sites.

A unique feature of the frequency monitoring equipment is the utilization of RF and AF switching equipment in lieu of direct patching operation. For example, transmitter number five is to be set at a given frequency: First set the frequency meter to the given frequency, then the sample RF out from the master oscillator of the transmitter is fed into the frequency meter RF input Jack. This is accomplished by turning the RF monitor switch to position five. The AF output of the heterodyne frequency meter is fed back to the transmitter by means of the AF switch. By setting this AF switch to position five the RF input to the heterodyne frequency meter and the AF output from the frequency meter circuits are complete. (The heterodyne beat note can also be heard by using a headset inserted into the frequency meter AF Jack).

The RF and AF switches can be bypassed by using RF and AF patchcords. To accomplish the same operation as described in the preceding paragraph it is necessary for the operator to patch a RF patchcord between the frequency meter RF input, and transmitter number five RF output. An audio patchcord from the AF output of the frequency meter to the transmitter audio line.

The spare RF and AF Jacks are used for paralleling RF input and output circuits and the AF circuits from the heterodyne frequency meter. If the double pole double throw toggle switch is used in the AF switching panel it will be necessary to throw this switch to the off position before this circuit is complete to the patchboard frequency meter AF Jack.

Item No.	Name of Part and Description	Function	JAN & N.S.T.	Mfgr.& Desig.	Contr. Part No.	Total/ Equip.
1	Switch, Rotary: Single Pole, 60 Position; Steel case, cad. plated; 12-13/64" wd. x 12-13/64" h x 5-1/16" d. overall; terminals consists of 61 jacks, NT 49191; Mounts by mtg. holes on 10" mtg/C for No. 10/32 screws; Mt. on size "G" Panel; Equip. with dedent mech. for positive positioning.	60 Position RF Switch	SA-141/U	CIA	C955A-1040	1
2	Cable Assembly: Spec. purpose; Four conductor cable, Navy Type FT-4, 36"/g; fitted ea. end with Navy Type 491242 twin plugs, Dwg #RE49F411.	AF Patchcords for panel MX-814/G	491397-A	CN	B955A 1049-10	4
3	Jack Switch: RF type; Fitted w/jack (NT 49120 modified) one end; fitted w/two NT 49191 connectors other end; 47/32" lg. x 1-45/64" wd. x 17/32" h.; Case aluminum w/gray enamel finish; mounts with conn. w/3/4" dia. mts. hole.	RF circuit Switching on J-239/G	491388	CIA	C955A 1020	12
4	Retainer, Pulley Assembly; Height 2-3/4" width 20-1/4" depth 3-3/4", volume per cu. ft. 0.12 and unit weight 8.5 lbs.	MX-813G	N-16- P8903- 130			4

Item No.	Name of Part and Description	Function	JAN & N.S.T.	Mfgr.& Desig.	Contr. Part No.	Total/ Equip.
5	Jack Panel: Height 1-23/32" width 19" depth 2-1/8" vol. per cu. ft. 0.04 and unit wt. per lb. 14.	J-265/G		N17-C-74112-8061		1
6	Mounting: Height 1-23/32" width 19" depth 16-7/8" Volume per cu. ft. 0.33 and unit wt. per lb. 12.1.	MT-571/G		N16-M-77553-5541		1
7	Speaker: Dynamic 6" dia. cone; PM field; 5.0 watt; normal output; voice coil impedance 3.2 ohm nominal; 6-3/32 lg. x 6-3/32 wd. x 3-9/64" d.; four 13/64" x 19/64" slots provided for mtg. at 90° to each other on 3-3/32" rad. from center.	Speaker for LS-139/G	491814	CJS #P6-T	B-7240	2
8	Switch: Rotary 2 pole 60 position; 2 section (1 pole, 60 position/section); silver plated brass contacts; synth. body; 5" lg. x 5" wd. x 3-9/16" d.; solder lug wired to ter. bd. consist of 124 screw type term; bushing 3/8"-32 x 3/8" lg. shaft 1/4" dia x 1/2" lg. flatted one side 3/8" lg.; four 7/32" dia. mtg. noles spaced 5-1/4" x 4-1/2" mtg./C.	Audio Switching for SA-135/G	241259	CSM	C955A 1041	1

PARTS LISTS

NAVSHIPS 92228

SECTION 4



Item No.	Name of Part and Description	Function	JAN & N.S.T.	Mfgr. & Desig.	Contr. Part No.	Total/ Equip.
9	Utility Cabinets: Bud Radio Inc. #CU-728, Size 3" x 5" x 4", Black.			Bud Radio Inc.	CU-728	50
10	Terminal Strip: Cinch Jones, Type 3-141.			Cinch Jones	3-141	50
11	Instulator: Three panel E. F. Johnson Co., Type 135-44.		N-17- I- 59611- 9750	E. F. Johnson Co.	135-44	50
12	Grommet: 5/8" H. H. Smith #2170.		None	H. H. Smith	2170	50
13	Knobs: Bakelite 1/4" Shaft, Black, General Cement #1114.		N-16- C- 90341- 1161	Gen. Cement	1114	50
14	Strips: Terminal Jones Type 13-141.		None	Jones	13-141	140
15	Cable: RG-59/U Amph. #21-025.	RG-59/U				1000 ft.
16	Connector Plug: Complete w/reduce. adapter Amph. #83-750(UG-111/U) N17-C-71414-5363.	UG-111/U			71414- 5363	326

Item No.	Name of Part and Description	Function	JAN & N.S.T.	Mfgr. & Desig.	Contr. Part No.	Total/ Equip.	PARTS LISTS
17	Jacks: Amph. #31-011 (UG-262/U) N-17-C-73108-7660.	UG-262/U	N-17-C-73108-7660		73108-7660	324	PARTS LISTS
18	Connector: Plug Amph. #31-012, N-17-C-71408-3425.	UG-260/U	N-17-C-71408-3425		71408-3425	324	
19	Wire: Buss #10 solid copper tinned Birnbach #1403.		None	Birnbach	1403	80 ft.	
20	Wire: Two conductor plus ground shielded W.E. Code "p".		None	W.E.		4500 ft.	NAVSHIPS 92228
21	Tubing: Plastic #10 Birnbach.		None	Birnbach		400 ft.	
22	Jack Spaces: WE 168A dimensions A-19"; B-18-1/4"; C-17-1/8"; D-17-5/16".			W.E.	168A	2	
23	Sets, Hand: Includes 289B plug and switch in handle. Trans. unit No.-F1; Rec. unit No.-HA1; Hand set handle No.-F3-3 and Cord No.-H4AA.	Use with 289B plug and switch in handle		W.E.	F3BW-3	2	SECTION 4

4-5

Item No.	Name of Part and Description	Function	JAN & N.S.T.	Mfgr. & Desig.	Contr. Part No.	Total/ Equip.
24	Hanger, Handset: WE 9A 2-31/32" x 2-7/8" overall.			W.E.	9A	2
25	Neon Indicator Lamps: GE NE-2 T-2 Clear Sylv. S-type T-2 Base 902 Sym. 32B-2.			Fed Supply Schedule  17-L- 5100 Sub Stern M-311		156
26	Speakers: Jensen 5" Model P5-V O.D. 5" Depth 2-7/16" Imped. ohms 3-4 Power Watts 2.5.		N-17- L- 91294- 1453	P5-V	ST-107	2
27	Transformers: Imped. matching, Jensen #ZL-2021 Core size 1/2" x 1/2".	Mount on Speaker P5-V	N-17- T- 63381		ZL-2021	2
28	Pads: "T" 500 ohms.		36-S- 51950			2
29	Resistors: 2700 ohms 1 watt carbon.					208
30	Resistors: 100,000 ohms 1 watt carbon.					78
31	Ferrules: Ground T & B #200-30006		None			4500

SECTION 4

NAVSHIPS 92228

PARTS LISTS

Item No.	Name of Part and Description	Function	JAN & N.S.T.	Mfgr. & Desig.	Contr. Part No.	Total/ Equip.
32	Strips: Double designation, width 15/32" x length 16-9/32".	230A Jack Mountings		W.E.	99B	14
33	Strips: Single designation, width 15/64" x length 16-9/32".	230A Jack Mountings		W.E.	99A	18
34	Jack: Heavily insulated mounting centers - Horizontal 5/8" and vertical 7/8".	For use with plugs		W.E.	218A	936
35	Jack: Heavily insulated mounting centers - Horizontal 5/8" and vertical 1-3/4".	For use with plugs		W.E.	410A	52
36	Jack: Heavily insulated singly mounted 230A, Mounting centers - Horizontal 5/8", vertical 7/8" in same direction.	Use with 218A Jacks		W.E.	230A	18
37	Jack: Heavily insulated singly mounted, 230B mounting centers - Horizontal 5/8", vertical 1-1/8".	Use with 218A Jacks		W.E.	230B	12
38	Sockets: Lamp - Mounted singly, used with Lamp No. 2 and Cap No. 2 and 72. Thickness of shelf 5/8".	Used with Lamp No. 2		W.E.	47B	156

PARTS LISTS

NAVSHIPS 92228

SECTION 4

Item No.	Name of Part and Description	Function	JAN & N.S.T.	Mfgr. & Desig.	Contr. Part No.	Total/ Equip.
39	Blanks: Apparatus aluminum, Black, Dimensions - 5/32" x 45/64" x 37/64" x 1/2".	Used with No. 13 type Lamp socket and No. 17 Type Plugs		W.E.	42B	52
40	Resistor: Composition 2.4 megohms 1 watt IRC plus or minus 5%.					50
41	Resistor: Composition 18,000 ohms 2 watt IRC plus or minus 10%.					50
42	Resistor: Composition 36,000 ohms 1 watt IRC plus or minus 5%.					50
43	Condensers: .01 mfd. 600 V, Mallory PT611.		36-S-75856	Mallory	PT611	100
44	Lamp: Neon type NE45 Candelabra screw base.					50
45	Lens and Holder for NE45, Dial Light Co. #66BN-831.		36-S-75118	Dial Light Co.	66BN-831	50
46	Fuse: 1 amp. Fusitron Type AGC Size 1/4" x 1-1/4".		N-17-F-16302-0080			50
47	Holder: Fuse, Fusitron Type HKP					50

Item No.	Name of Part and Description	Function	JAN & N.S.T.	Mfgr. & Desig.	Contr. Part No.	Total/ Equip.
48	Plug Caps: Hubbell #9754.		None	Hubbell	9754	12
49	Connector Bodies: Hubbell #9953.		N-17- C- 71148- 3947	Hubbell	9953	12
50	Receptacle: Pass and Seymour, 660 watt 600 volts #54, Porcelain sign.		None	Pass & Seymour	54	25
51	Tube: JAN Type 2050.	Spec. Type	JAN Type 2050		2050	50
52	Socket: Tube 8 Pin Octal Amphenol Type 78-S-8.		N-16- S- 63462- 8227		78-S-8	50
53	Transformer: Filament 230 V to 6.3 V.		None	Balt. Transf. Co.		50
54	Potentiometer: 1000 ohms Centralab N-158		None			50
55	Capacitor: 8 mfd, 450 VDC					1
56	Resistor: 10,000 ohms, 20 W, W.W.			IRC	Type 2D	2

PARTS LISTS

NAVSHPIS 92228

SECTION 4

Item No.	Name of Part and Description	Function	JAN & N.S.T.	Mfgr. & Desig.	Contr. Part No.	Total/ Equip.
57	Potentiometer: 750 ohms, 25 W, W. W.			Claro-stat	PW25-750	1
58	Resistor: 300 ohms, 1 W, Carbon.					2
59	Resistor: 1 megohm, 1 W, Carbon.					1
60	Switch: SPST toggle, 110 V, 3 Amp.					1
61	Fuse: 1.5 Amps.		G17-F-16302-90			1
62	Fuse Holder		N17-F-74267-6101			1
63	Pilot Light Lens and Holder.			Dial Light Co. of America	Type No. 810B-431	1
64	Dial Lamp: 6 V.		#47			1
65	Milliammeter: 100-0-100 MA. DC.			Westinghouse	NX-35 NY-37441-2	1
66	Terminal Strip: 3 terminals			Cinch-Jones	Type 140-Y	1

SECTION 4

NAVSHIPS 92228

PARTS LISTS

Item No.	Name of Part and Description	Function	JAN & N.S.T.	Mfgr. & Desig.	Contr. Part No.	Total/ Equip.
67	Same as Item #52.					4
68	Choke: 11 hys. @ 0 MA, 6 hys. @ 200 MA, 2 hys. @ 300 MA.			Thordar- son	T-20C55	1
69	Power Transformer: 350-0- 350 V, 120 MA; 5 V @ 3A, 6.3 V @ 3.5 A.CT.			Thordar- son	TS-24R05	1
70	Jack: Closed circuit.		N17-J- 39253- 3043			1
71	Tube: 5V4.			N16-T- 56611		1
72	Tube: VR-105			N16-T- 53050		2
73	Tube: 6AS7			N16-T- 55474		1

PARTS LISTS

NAVSHIPS 92228

SECTION 4



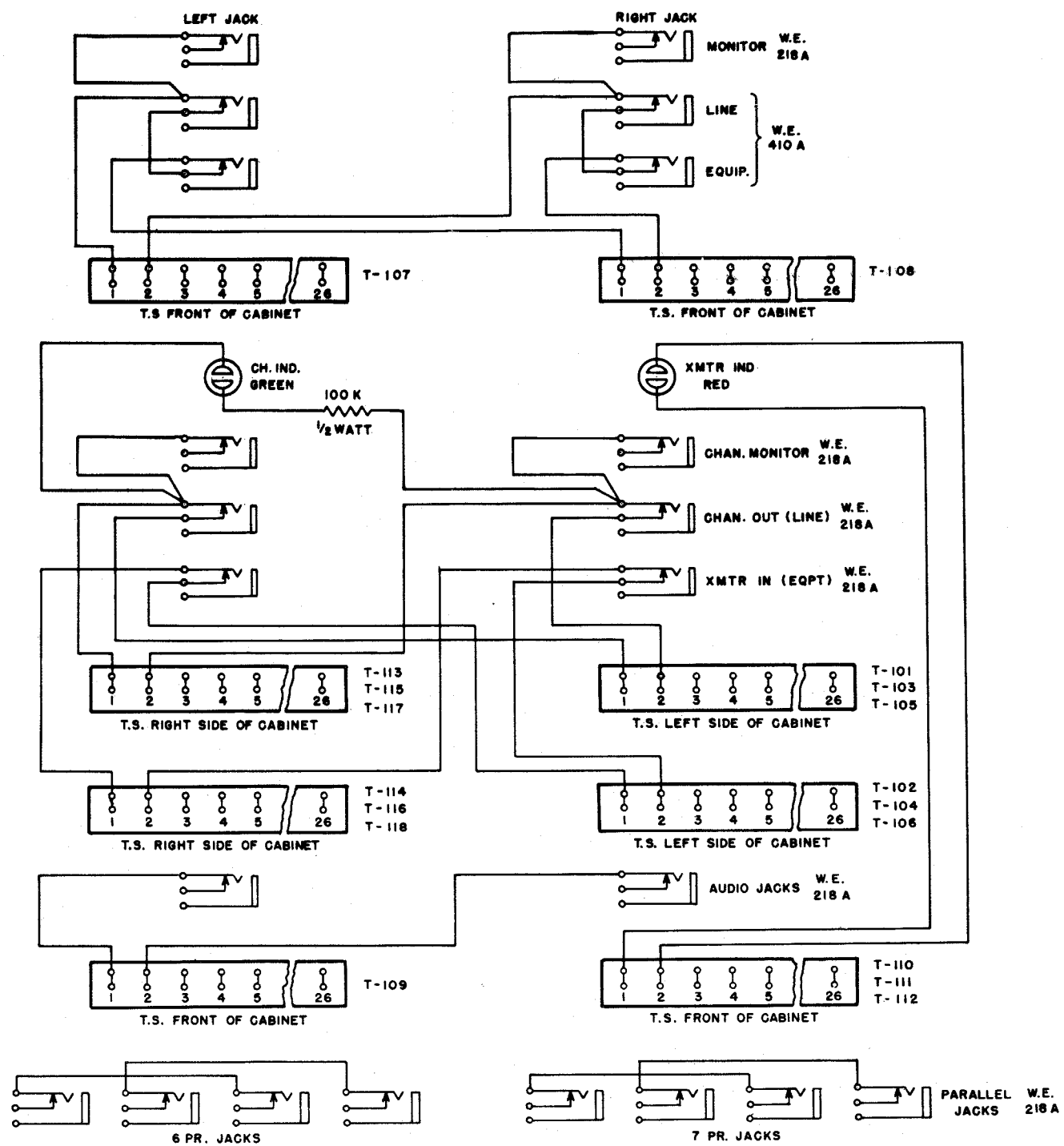

CABINET NO. 1 CONSOLE VIEWED FROM REAR

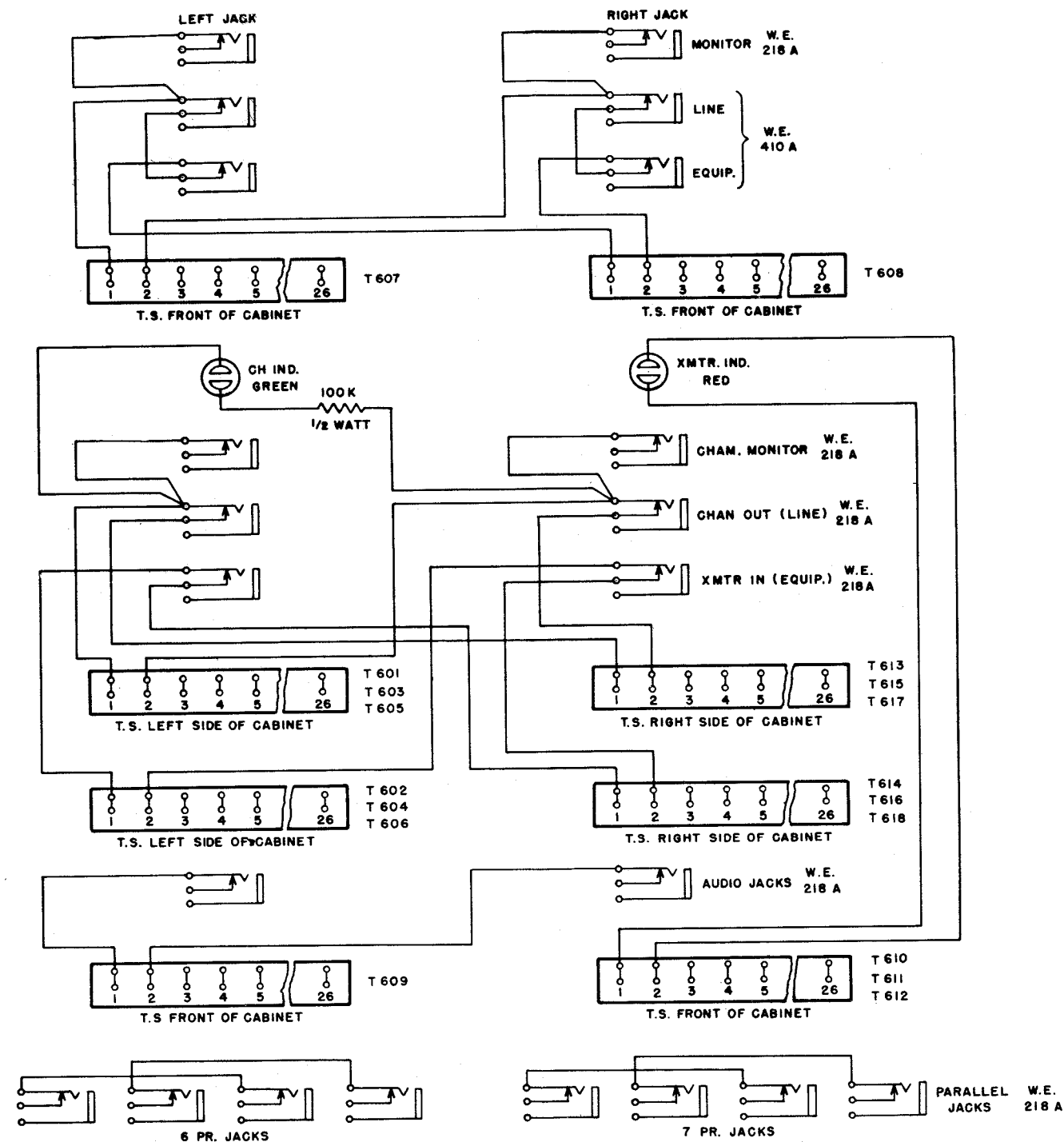

CABINET NO. 6 CONSOLE VIEWED FROM REAR

CONTROL CONSOLE  
JACK FIELD WIRING DETAILS

DRAWN <i>J. Bug</i>	ELECTRONICS DIVISION NO.	REV
ELECTRONICS PLAN	RW 23 D 379	A
SCALE	SHEET 32 OF 36	

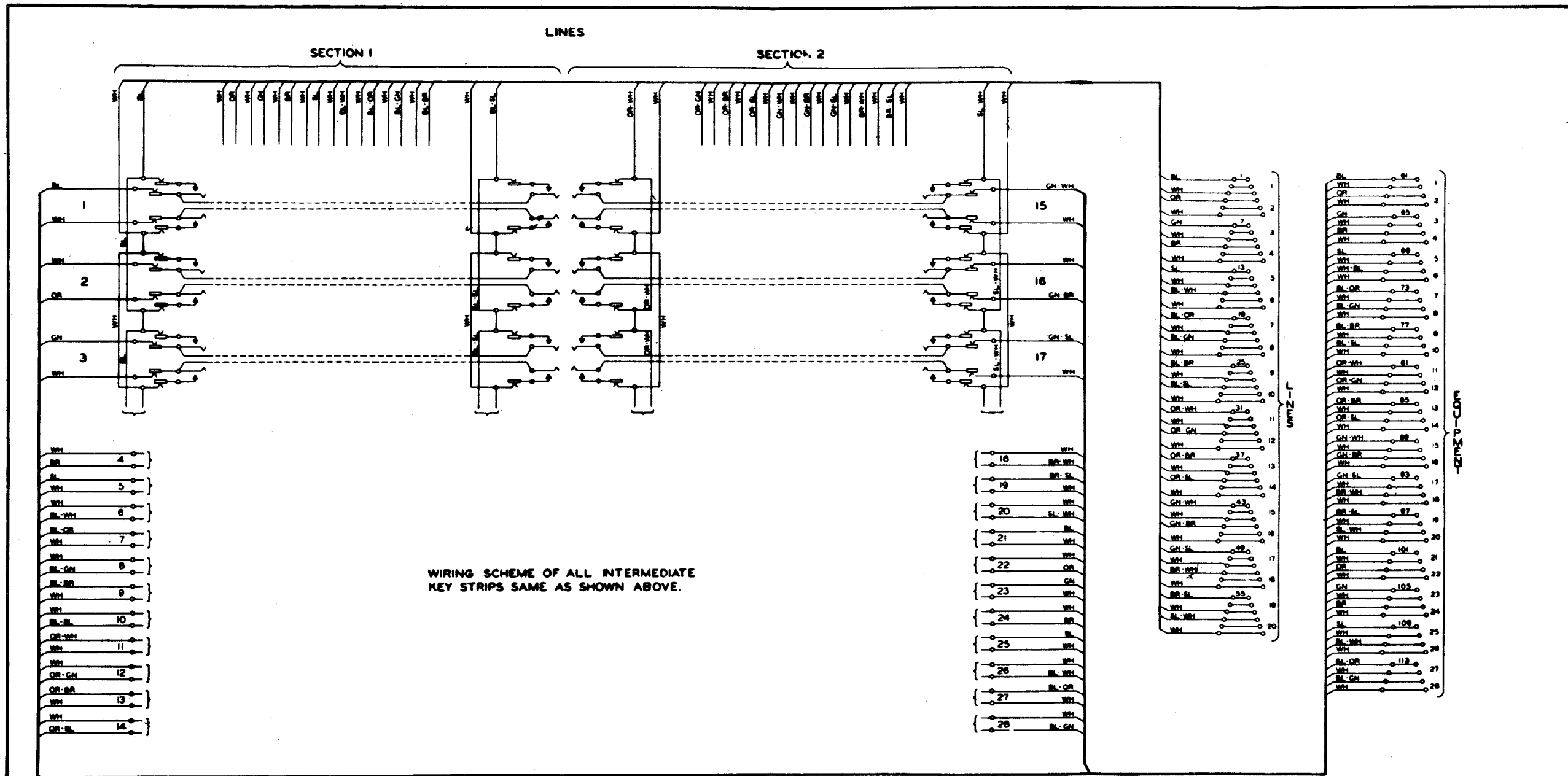

WIRING SCHEME OF ALL INTERMEDIATE  
KEY STRIPS SAME AS SHOWN ABOVE.

**FRONT VIEW**

POWER EQUIPMENT CO.  
EL PASO, TEXAS  
**WIRING DIAGRAM**  
FOR  
**PEC 788 SWITCHING UNIT**  
DRAWN BY WSP  
SCALE 1:10-52  
DRAWING NO.  
**WG-1844-5**

TRACED		ELECTRONICS DIVISION NO	REV
DRAWN	<i>W. B. B.</i>	<b>RW 23 D 379</b>	<b>A</b>
<b>ELECTRONICS PLAN</b>		SCALE	SHEET 34 OF 38

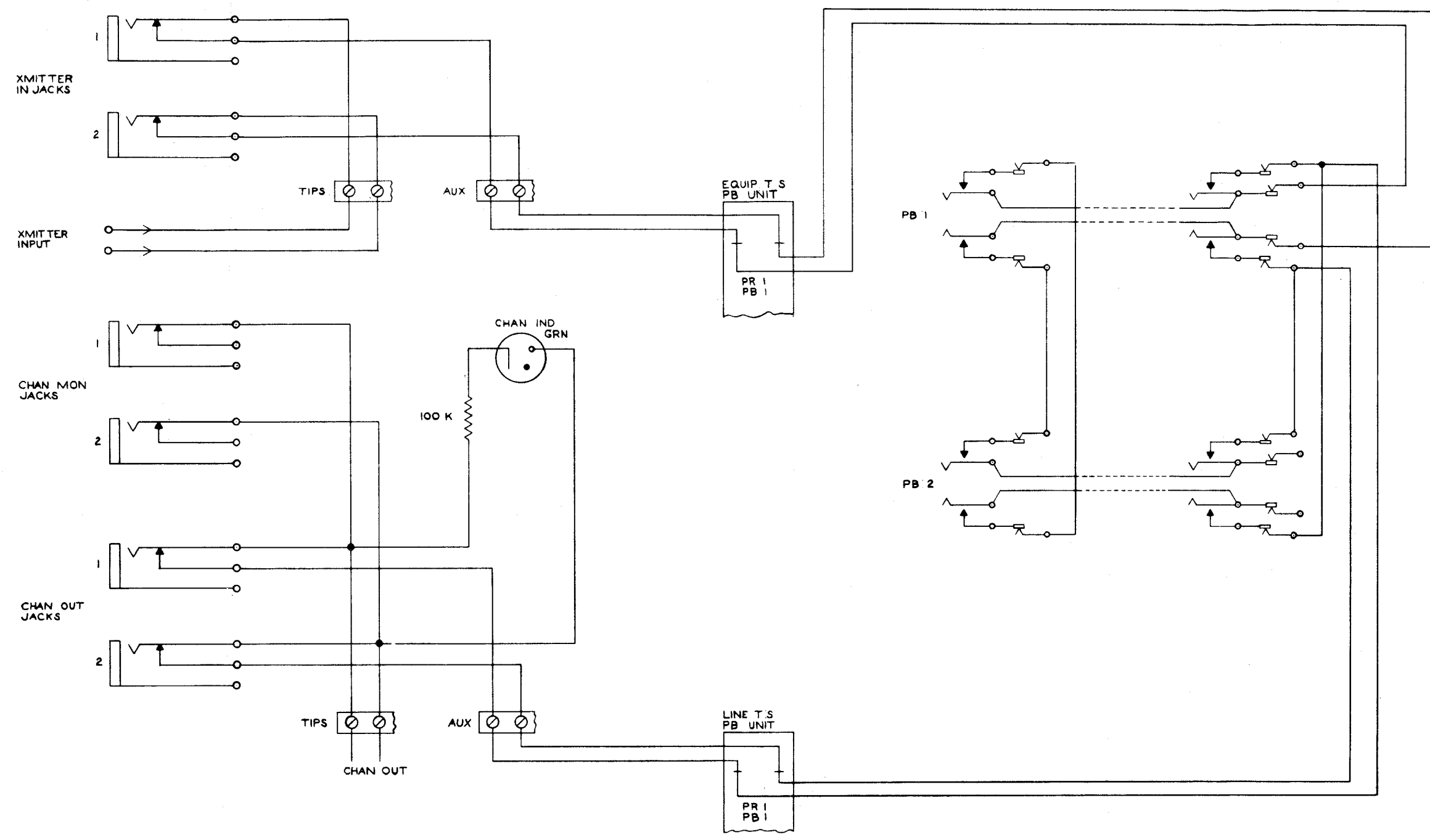

COMMUNICATIONS CONSOLE  
PUSH BUTTON CIRCUIT DIAGRAM

CHENG	ELECTRONICS DIVISION NO.	REV.
DRAWN S. CHMURA		
ELECTRONICS PLAN	RW 23 D 379	
SCALE	SHEET	OF

FIG. 5-3

REV	DATE	ALTERATION	BY
A	3-4-53	SHEET 35 ADDED	FA
B	4-22-53	OBQ-4 & AUDIO OSCILLATOR ADDED TO FRAME NO. 3	FA

NOTE:  
ALL ITEMS EXCEPT AS  
NOTED TO HAVE BAKED  
GRAY ENAMEL FINISH

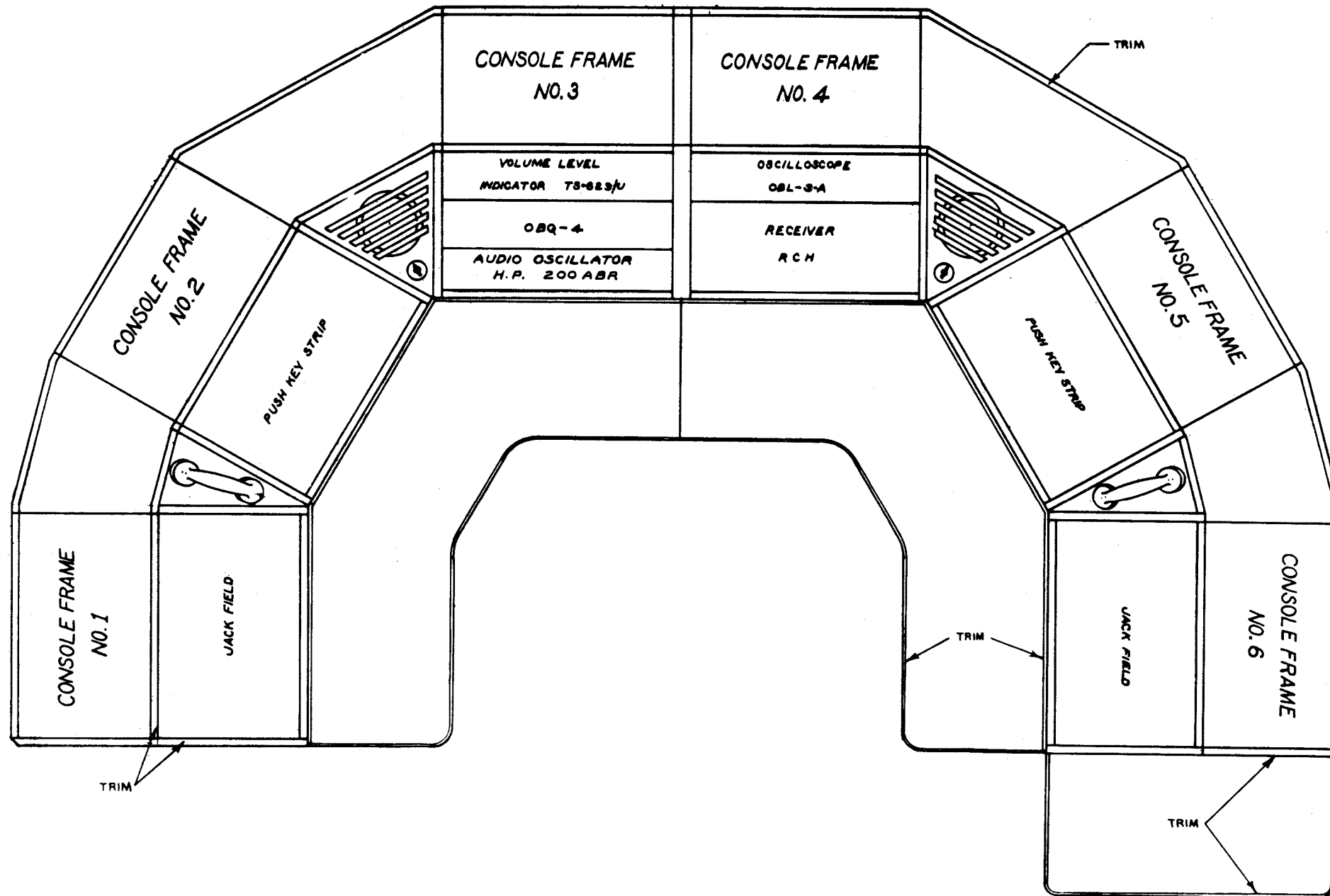

PLAN VIEW OF CONSOLE ASSEMBLY

U.S. NAVAL GUN FACTORY		WASHINGTON, D.C.	
<b>ELECTRONICS DIVISION</b>			
PUBLIC WORKS DEPARTMENT			
<b>EXAMINED</b>		<b>COMMUNICATIONS CONSOLE</b>	
OFFICIAL	SIGNATURE		
DATE			
ENGINEER			
PROJECT			
IN CHARGE OF			
TRACED		APPROVED	DATE
ELECTRONICS PLAN		FOR SUPT. OF E.S.P. E.M.O. CDR. U.S.N.	
ELECTRONICS DIVISION NO.		REV	
RW-23-D		370	
SCALE - 3/4" = 1" 0"		SHEET 1 OF 36	

FIG. 5-4

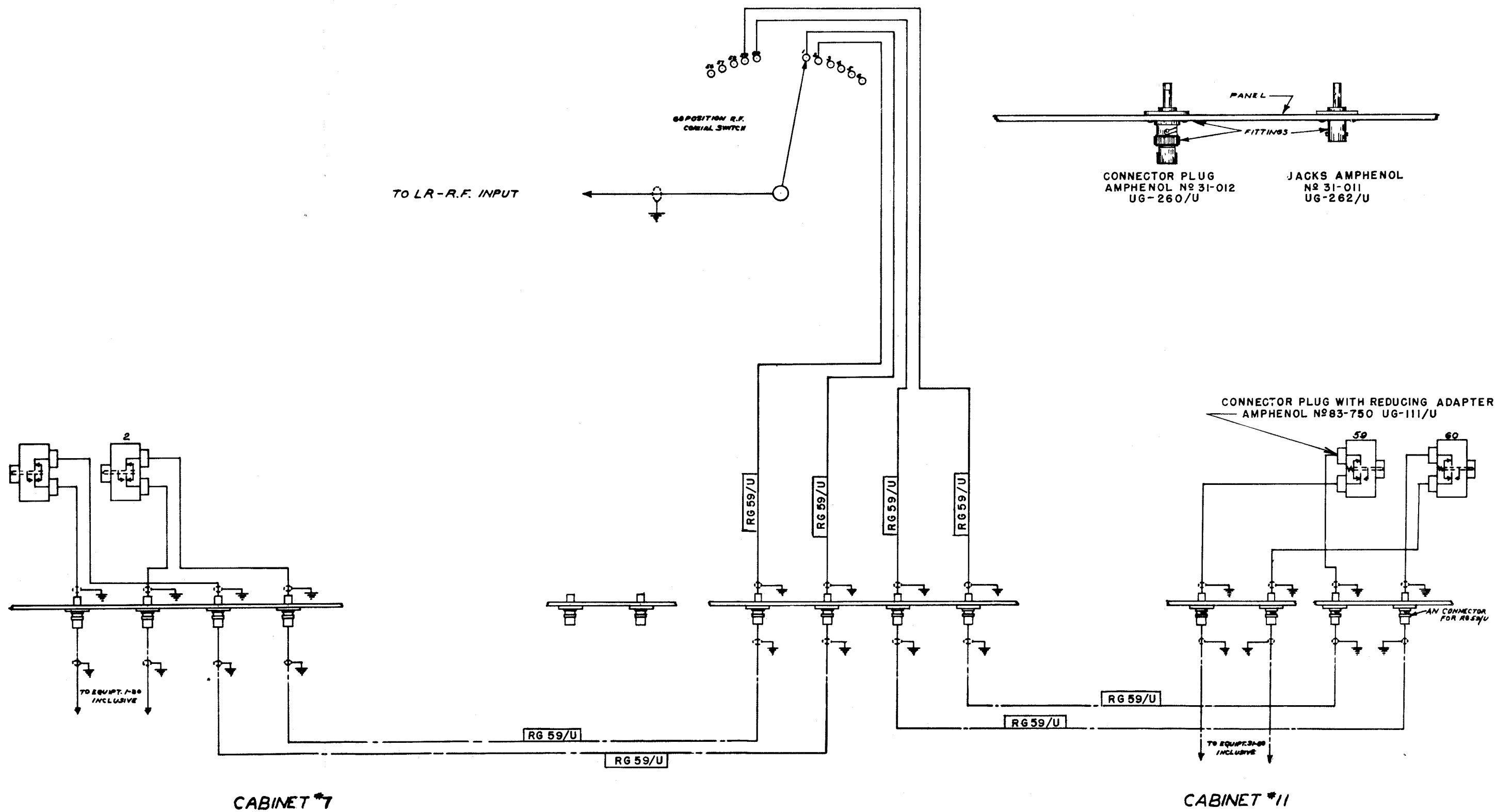

R.F. JACK SYSTEM

TRACED	W.S. O'Neil	ELECTRONICS DIVISION		NO.	REV.
DRAWN	R.S. Zand	RW	23 D	380	
ELECTRONICS PLAN		SCALE 00		SHEET 2 OF 11	

FIG. 5-5

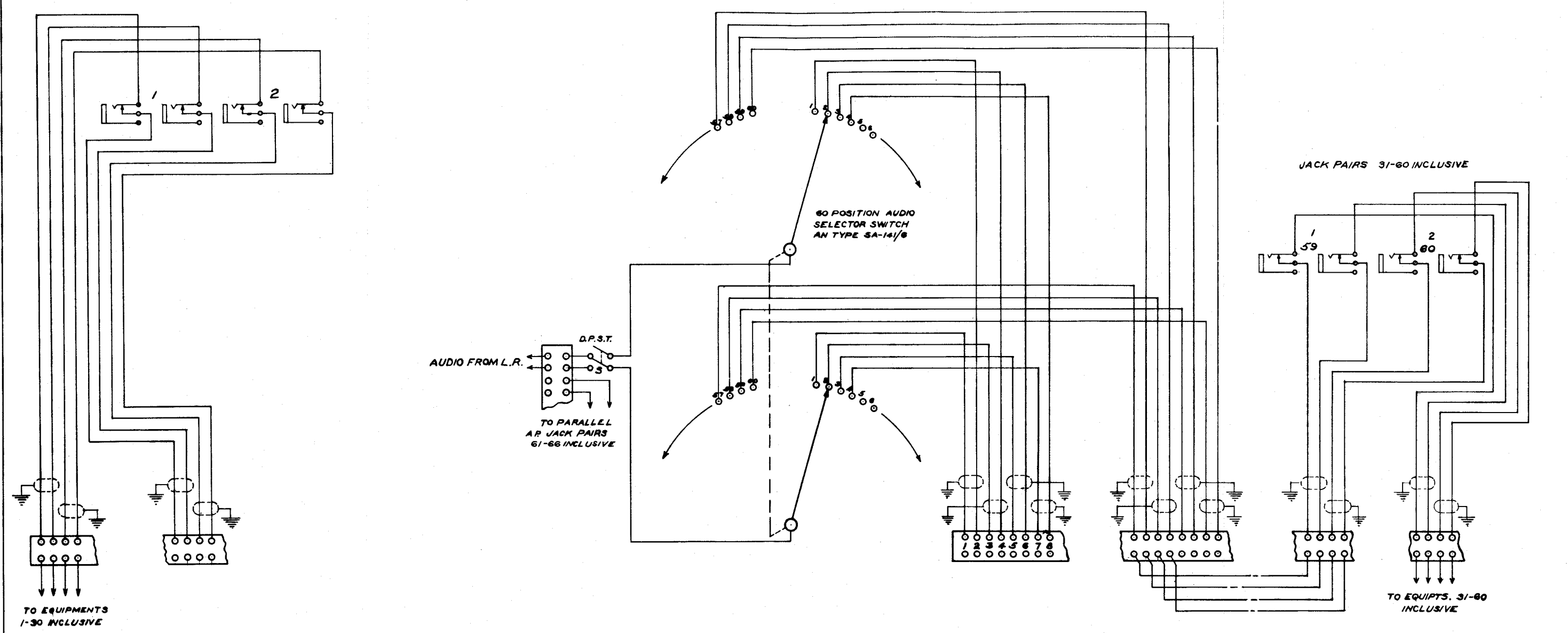

TO EQUIPMENTS  
1-30 INCLUSIVE

AUDIO FROM L.R.  
D.P.S.T.  
TO PARALLEL  
A/R JACK PAIRS  
61-66 INCLUSIVE

60 POSITION AUDIO  
SELECTOR SWITCH  
AN TYPE SA-14/B

JACK PAIRS 31-60 INCLUSIVE

TO EQUIPTS. 31-60  
INCLUSIVE

LEFT CABINET # 7

AUDIO JACK SYSTEM

RIGHT CABINET # 11

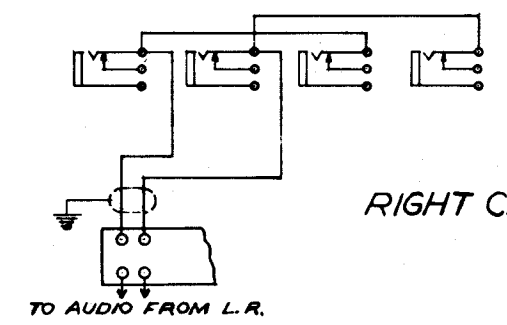

TO AUDIO FROM L.R.

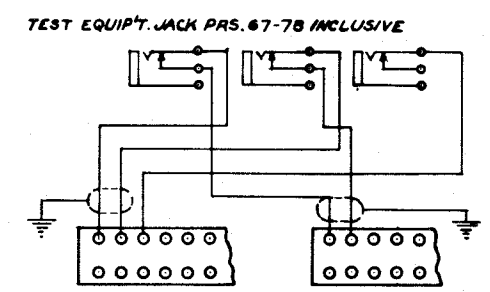

TEST EQUIPT. JACK PARS. 67-78 INCLUSIVE

TRACED <i>[Signature]</i>	ELECTRONICS DIVISION NO	REV
DRAWN <i>[Signature]</i>	RW 23D 380	
ELECTRONICS PLAN	SCALE 5	SHEET 3 OF 11

FIG. 5-6

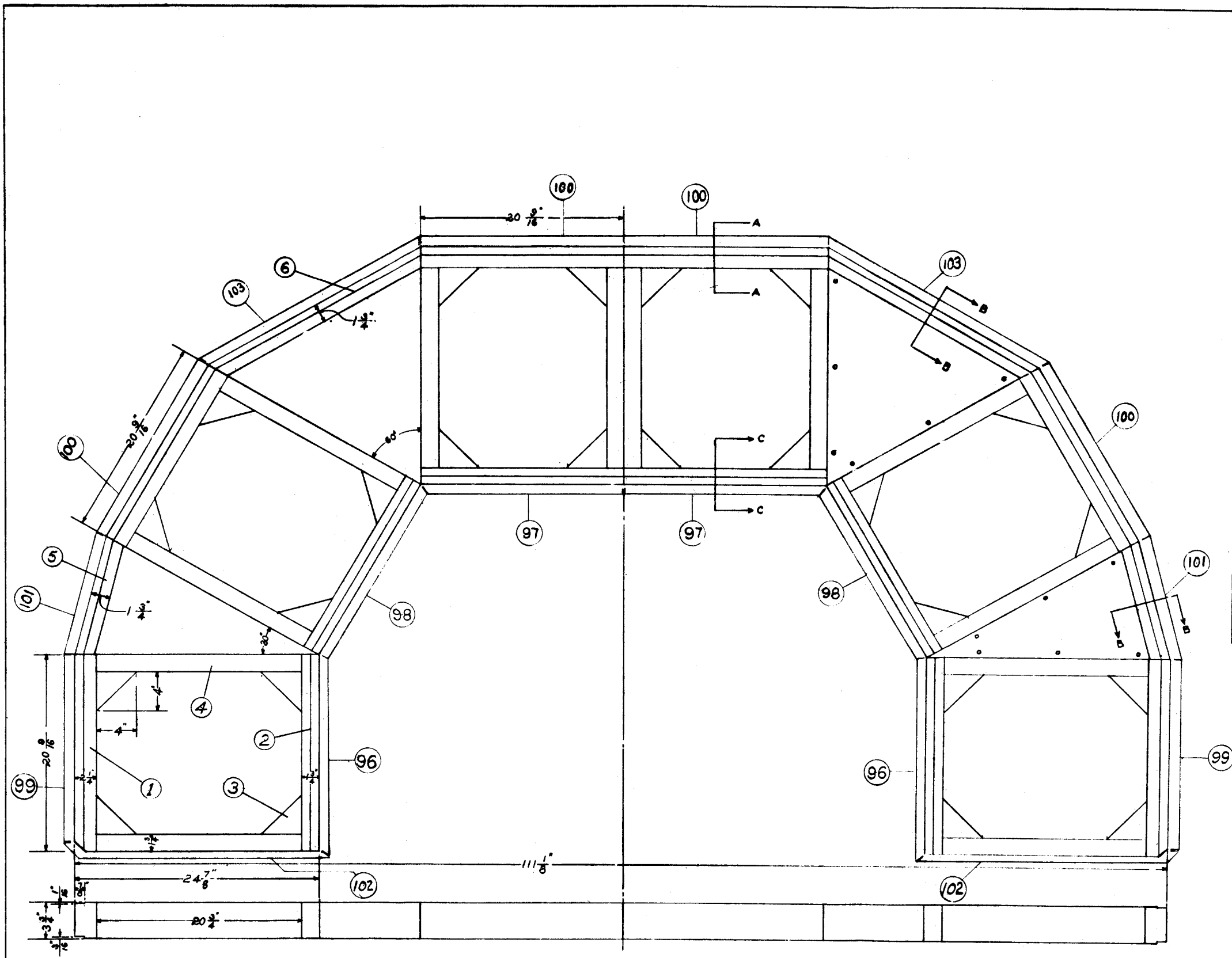

SECTIONS OF WOODEN FOUNDATION FOR CONSOLE

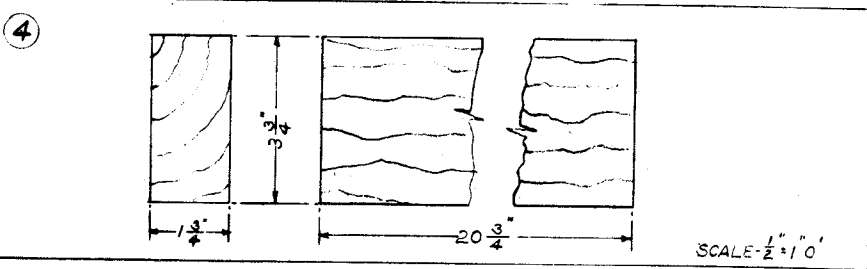
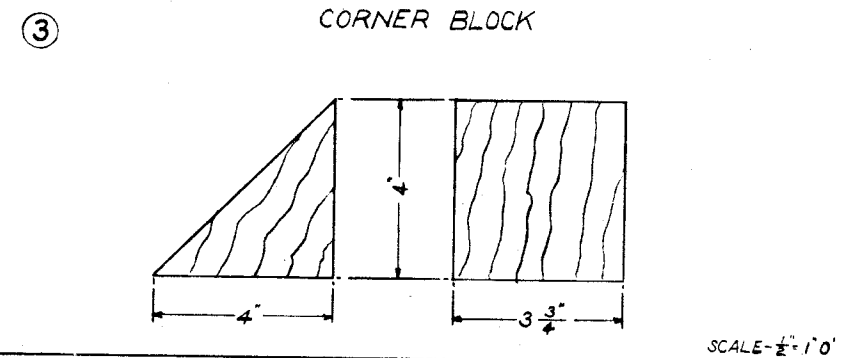
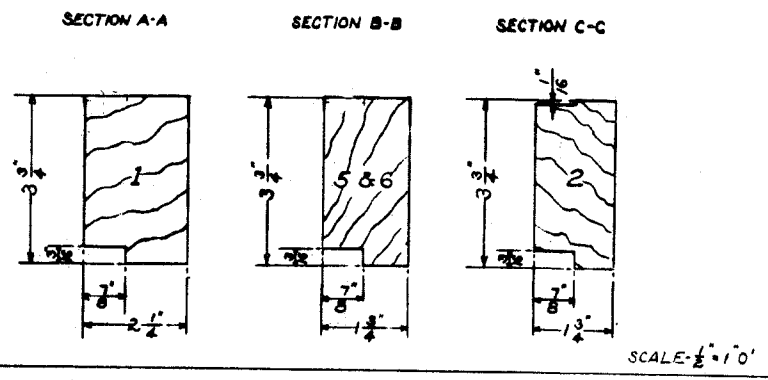

6	60" FILLER BASE	2
	WOOD-	
5	30" FILLER BASE	2
	WOOD-	
4	CABINET BASE SIDE	12
	WOOD-	
3	CORNER BLOCK	24
	WOOD-	
2	CABINET BASE FRONT	6
	WOOD-	
1	CABINET BASE REAR	6
	WOOD-	

TRACED	ITEM	NOMENCLATURE	NO. REQD.
DRAWN	No.		PER UNIT
ELECTRONICS		ELECTRONICS DIVISION NO.	REV
PLAN		RW- 23-D - 379	A
P.O. LEM		SCALE-1/2"=1' 0"	SHEET 4 OF 36

FIG. 5-7

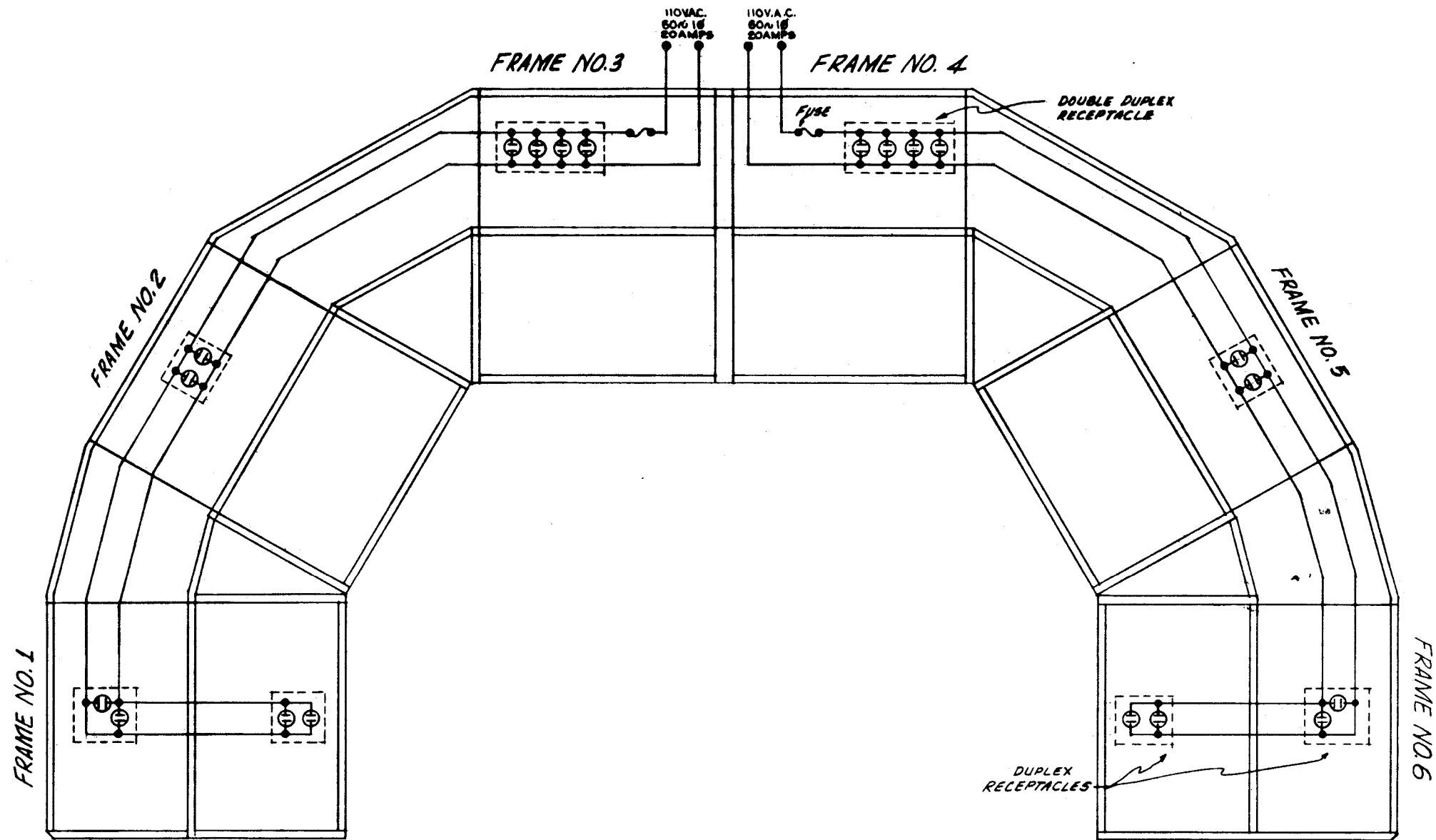

COMMUNICATIONS CONSOLE  
POWER DISTRIBUTION WIRING

ELECTRONICS PLAN	ELECTRONICS DIVISION NO.	REV.
	RW23D379	
SCALE:	SHEET 36 OF 36	



JACK PANELS - LEFT SIDE OF CONSOLE - CABINET NO. 1 (VIEWED FROM REAR)

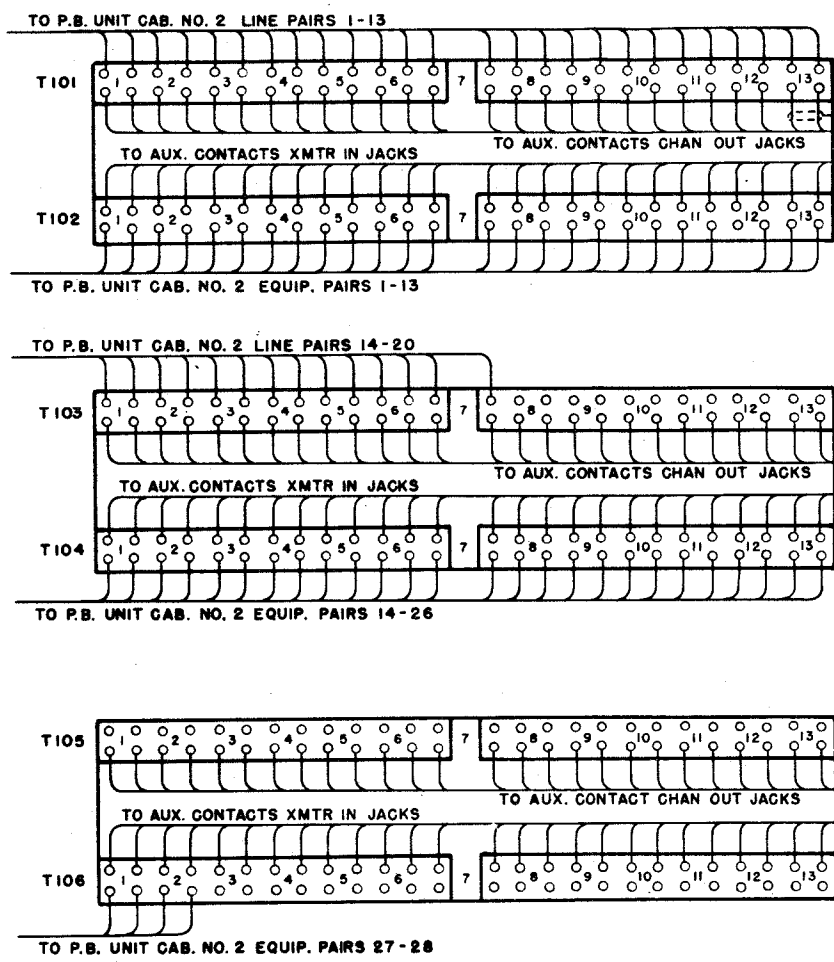

LEFT SIDE OF CONSOLE - LEFT SIDE OF CABINET NO. 1  
VIEWED FROM REAR

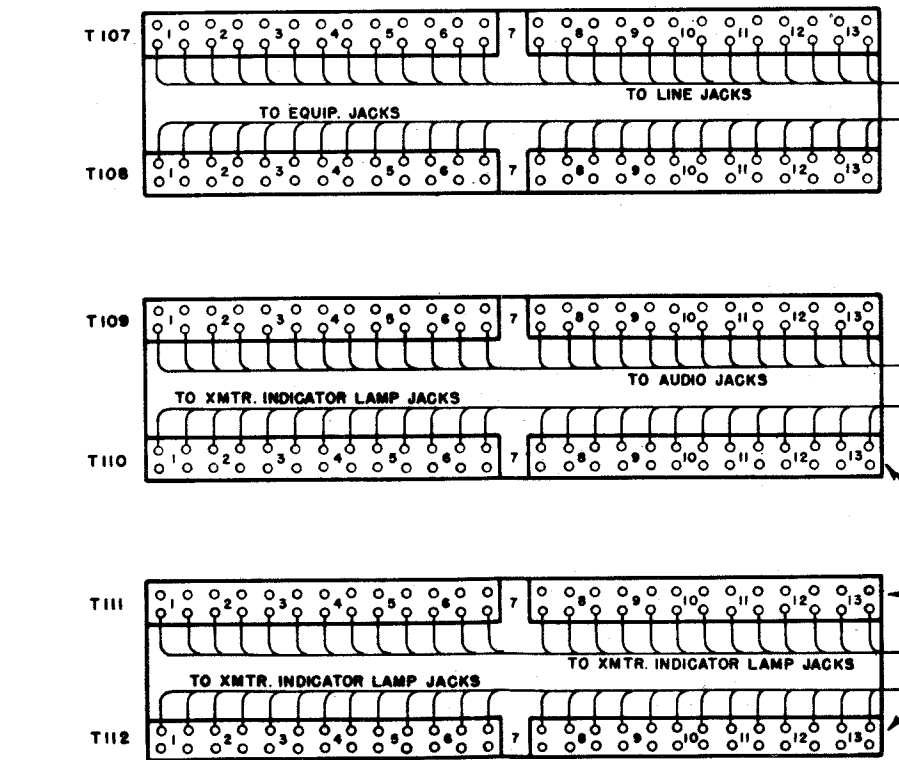
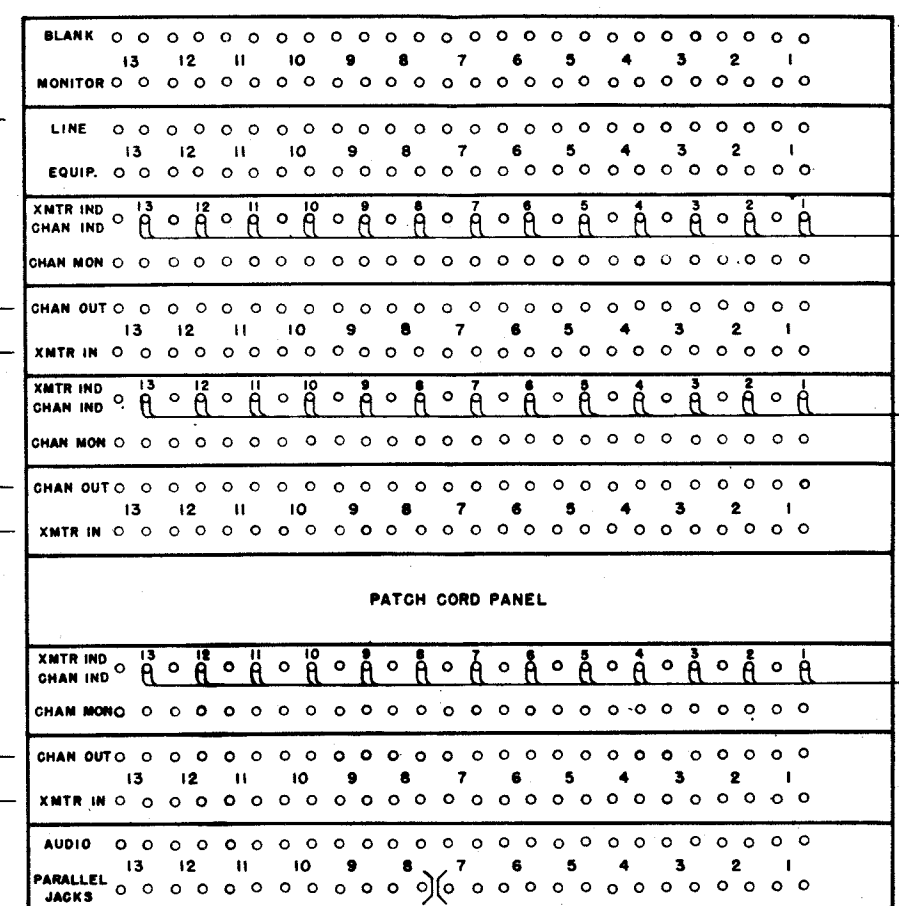

LEFT SIDE OF CONSOLE - CENTER OF CABINET NO. 1 (VIEWED FROM REAR)

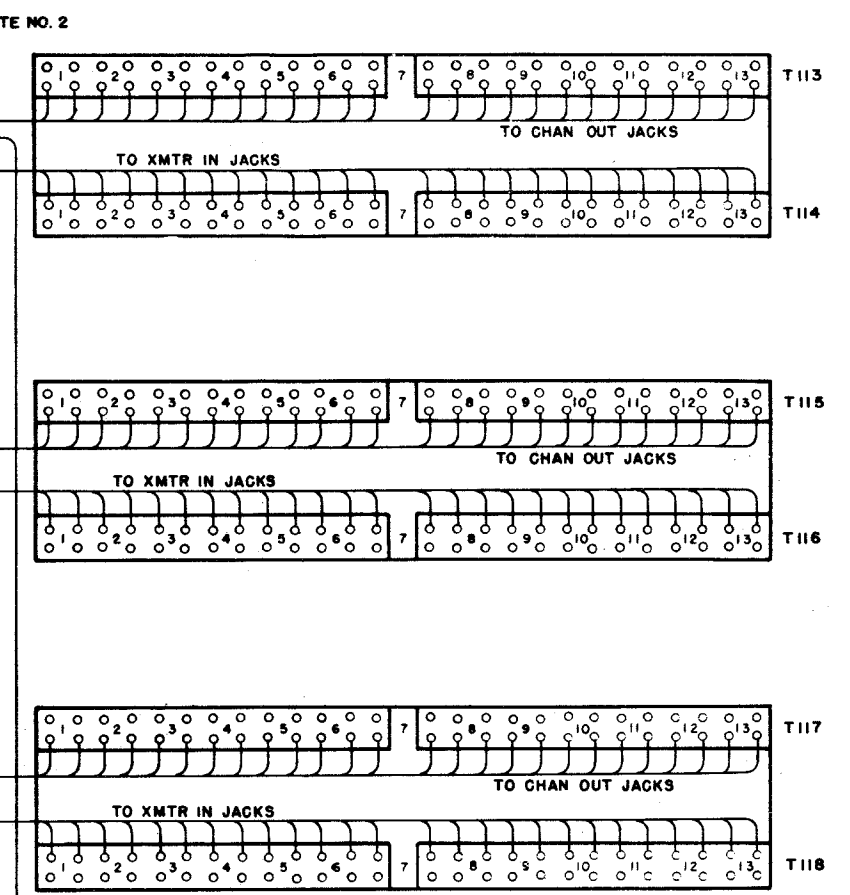

LEFT SIDE OF CONSOLE - RIGHT SIDE OF CABINET NO. 1  
VIEWED FROM REAR

- NOTES:
- (1) ALL PAIRS IN ALL CABLE RUNS TO BE SHIELDED AND GROUNDED.
  - (2) JACK PANEL VIEWED FROM REAR WIRED IN SEQUENCE RIGHT TO LEFT.
  - (3) ALL TERMINAL STRIPS WIRED IN SEQUENCE LEFT TO RIGHT.
  - (4) TO BE USED WITH R.F. DETECTOR UNIT ONLY OTHERWISE MUST HAVE 100K OHM SERIES RESISTOR IN ONE SIDE OF INDICATOR LINES.

CABLING DIAGRAM

DRAWN <i>B. B. W.</i>	ELECTRONICS DIVISION NO.	REV
ELECTRONICS PLAN	RW 23 D 379	A
SCALE	SHEET 31 OF 30	

JACK PANELS - RIGHT SIDE OF CONSOLE - CABINET NO. 6 (VIEW FROM REAR)

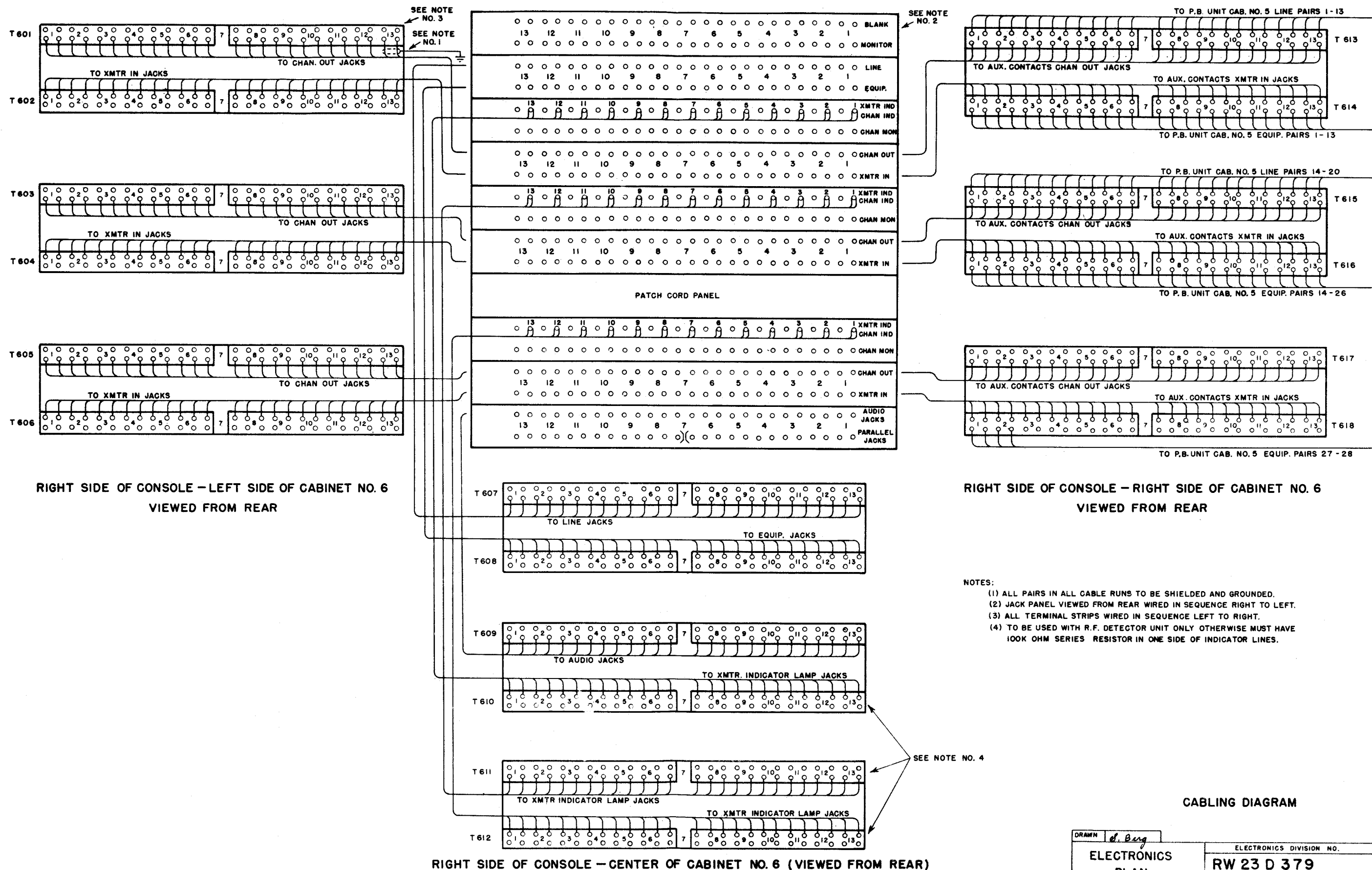

CABLING DIAGRAM

DRAWN <i>d. Berg</i>	ELECTRONICS DIVISION NO.	REV
ELECTRONICS PLAN	RW 23 D 379	A
SCALE	SHEET 30 OF 36	

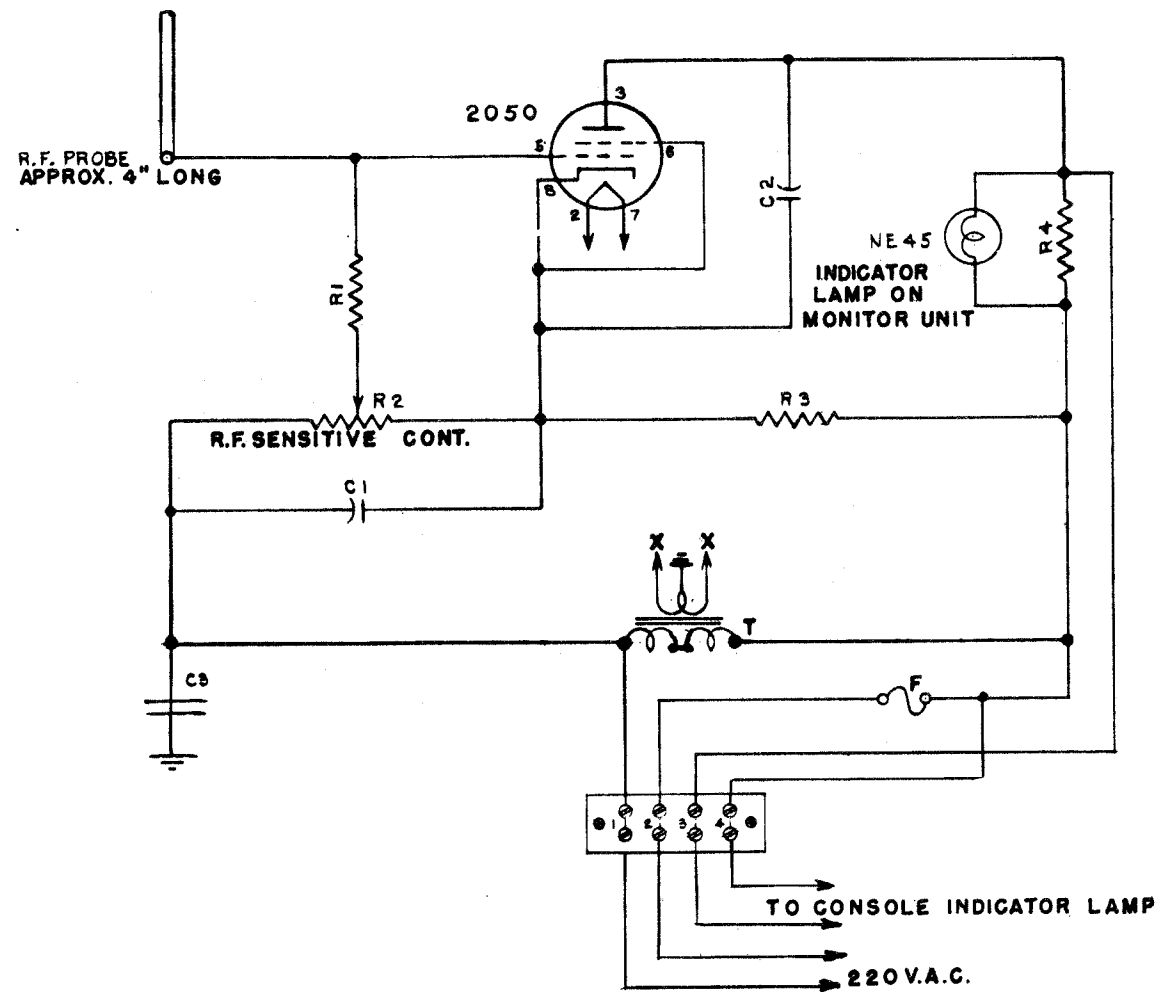

NOTES:—  
 1- CIRCUIT IS ENTIRELY SHIELDED EXCEPT  
 GLASS ENVELOPES OF 2050, NE-45.  
 2- FOR 110 V.A.C. OPERATION PRIMARY OF  
 TRANSFORMER MUST BE PARALLELED

C1 - 0.01 MFD CONDENSER  
 C2 - 0.01 MFD CONDENSER  
 C3 - 0.01 MFD CONDENSER  
 R1 - 2.4 MEG RESISTOR  
 R2 - 1K POTENTIOMETER  
 R3 - 18K RESISTOR  
 R4 - 36K RESISTOR  
 F - 1-AMP  
 T - FILAMENT TRANSFORMER  
 PRIMARY 110-220 V.A.C.  
 SECONDARY 6.3 V.A.C. 1.3 AMP.

R F MONITOR SCHEMATIC

TRACED		ELECTRONICS DIVISION NO.	REV.
DRAWN	<i>S. Berg</i>	RW 23 D 379	E
ELECTRONICS PLAN		SCALE	SHEET 35 OF 38

REV. DATE	ALTERATION	INL.
A 4-22-53	REMOVE OBQ-4 CABINET NO. 7 & 11	2-52
B 6-24-53	REMOVE (2) OCT. 2 + (2) FN-26/G	1-1

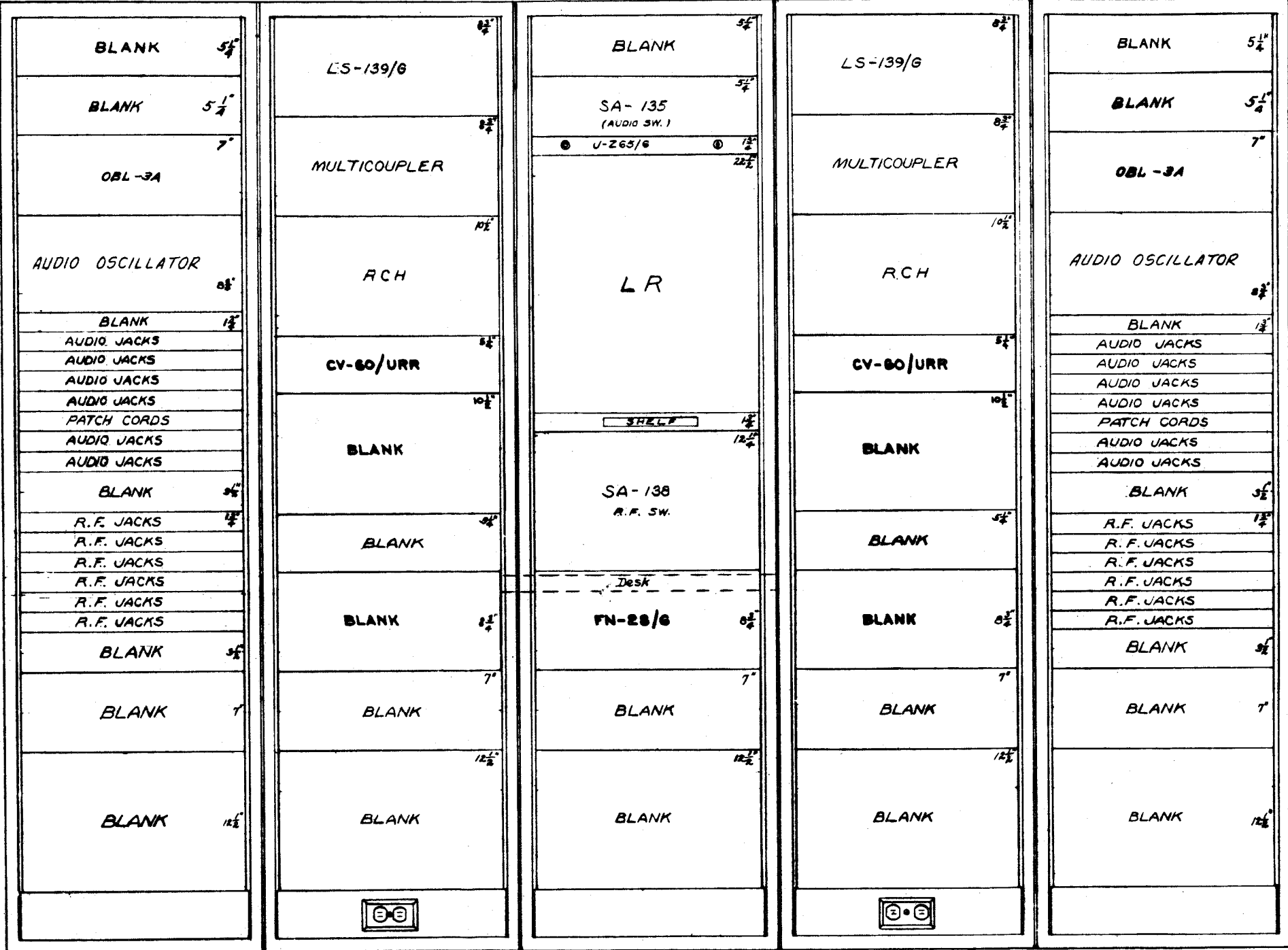

CABINET NO. 7

CABINET NO. 8

CABINET NO. 9

CABINET NO. 10

CABINET NO. 11

U.S. NAVAL AIR FACTORY		WASHINGTON, D.C.	
<b>ELECTRONICS DIVISION</b>			
PUBLIC WORKS DEPARTMENT			
EXAMINED		<b>FREQUENCY MONITOR</b>	
OFFICIAL SIGNATURE		<b>EQUIPMENT</b>	
DATE	ENGINEER	<b>CABINET LAYOUT</b>	
TRACED	APPROVED	DATE 10-6-52	
DRAWN		FOR SUPT OF N.S.F. E.M.O. COR. U.S.N.	
<b>ELECTRONICS PLAN</b>		ELECTRONICS DIVISION NO.	
		RW 23D 380 B	
		SCALE 3/4" = 1" SHEET 1 OF 11	

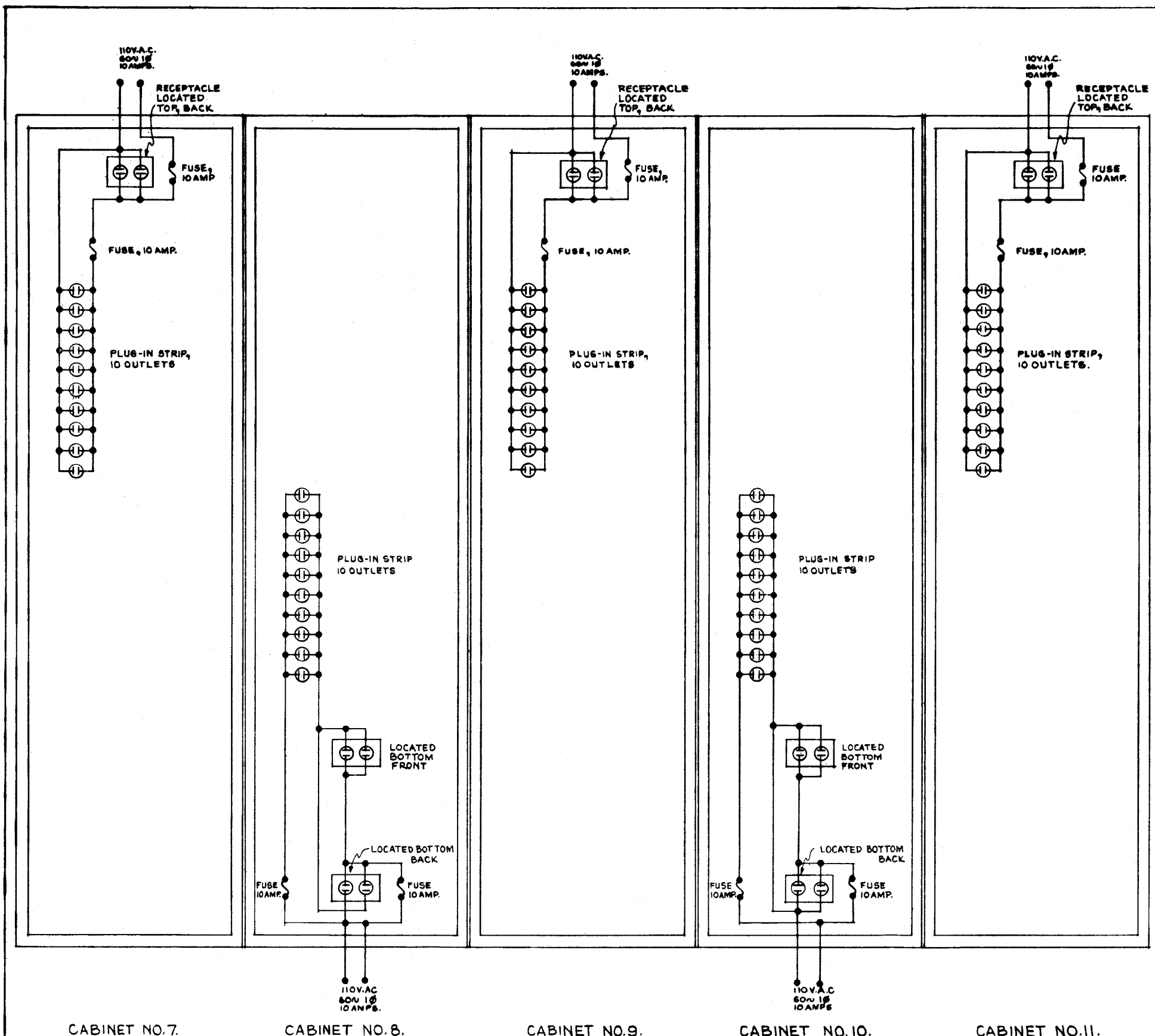

FREQUENCY MONITOR EQUIPMENT  
POWER DISTRIBUTION WIRING

ELECTRONICS PLAN	ELECTRONICS DIVISION NO.	REV.
	RW 23D 380	
	SCALE: ~	SHEET 11 OF 11

**CABINET NO. 11 FREQUENCY MONITOR EQUIPMENT  
"REAR VIEW"**

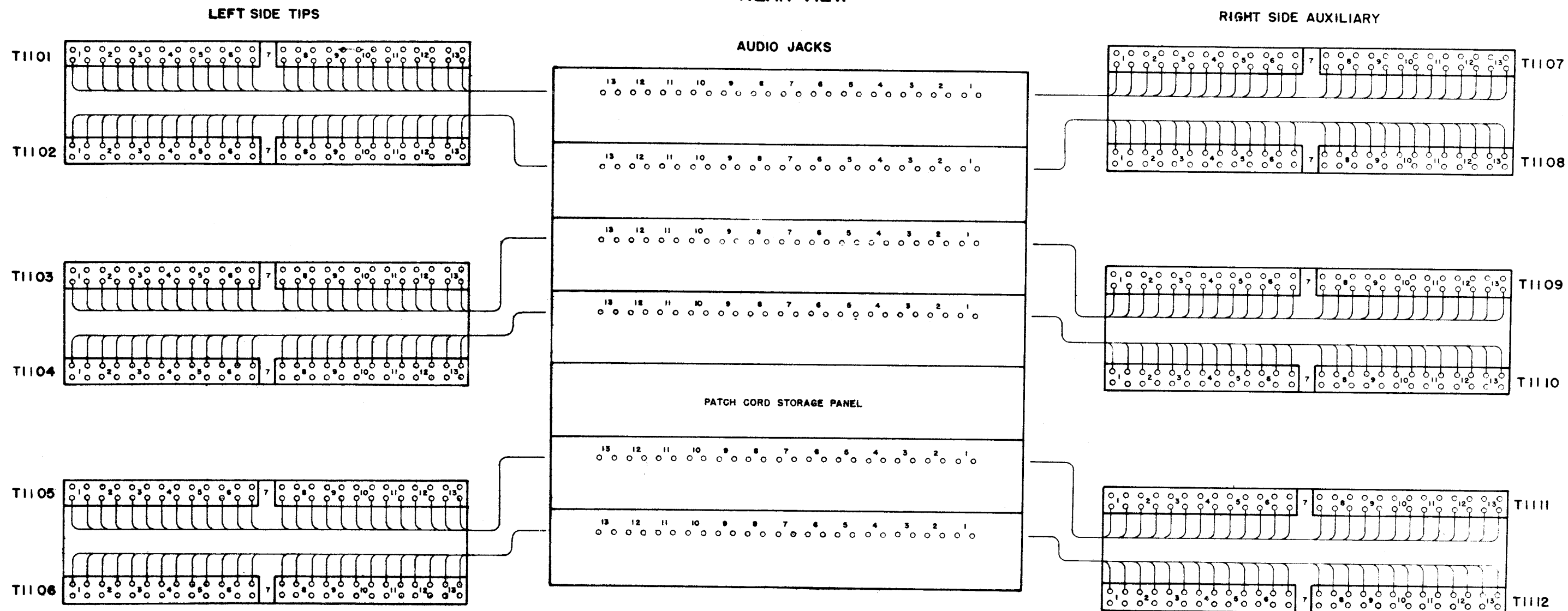

FREQUENCY MONITOR EQUIPMENT AUDIO JACKS WIRING CABINET NO. 11			
TRACED		ELECTRONICS DIVISION NO.	REV.
DRAWN	<i>W. S. M.</i>	<b>RW23 D380</b>	
<b>ELECTRONICS PLAN</b>		SCALE	SHEET 5 OF 11

**FIG. 5-14**

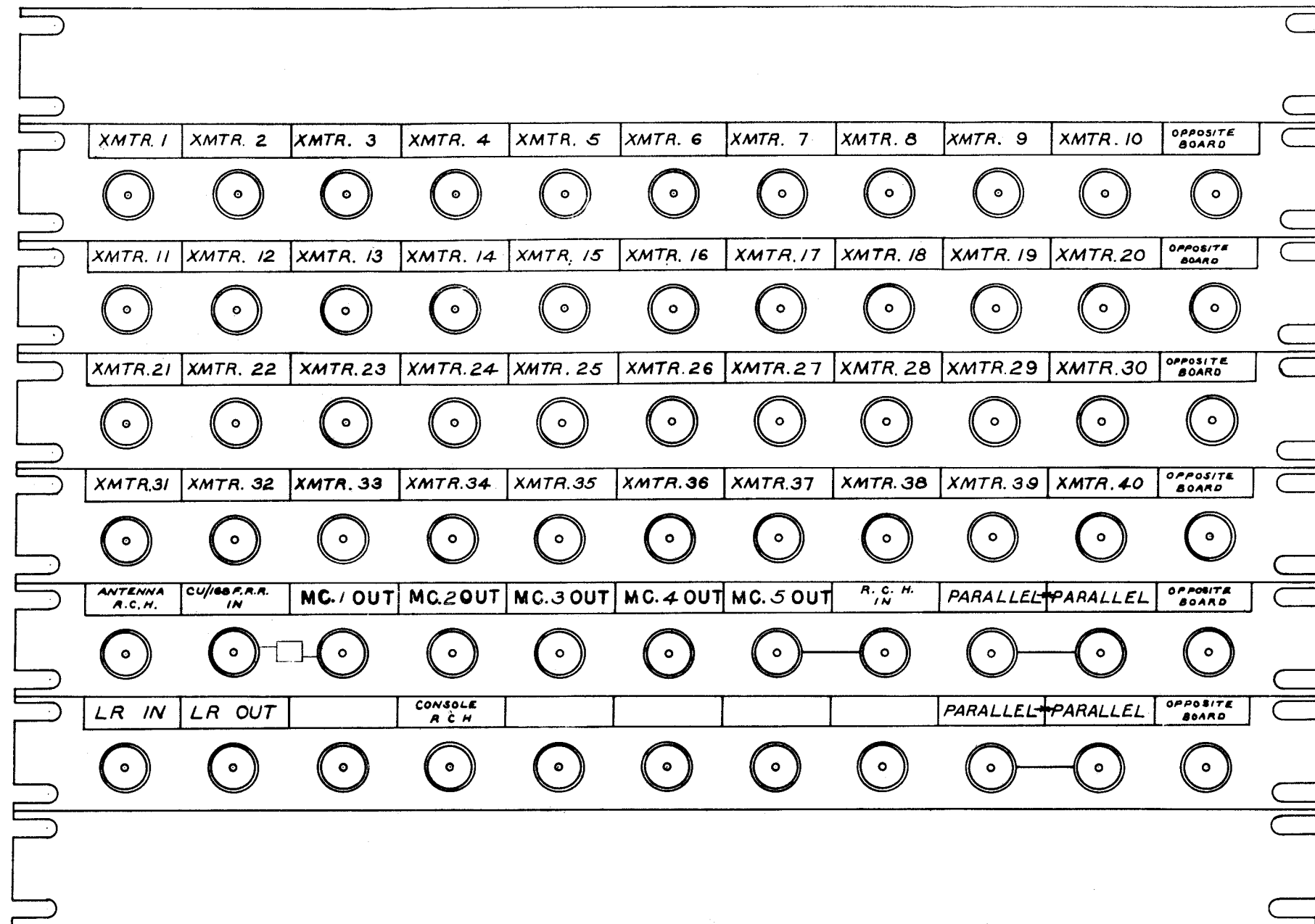

FREQUENCY MONITOR EQUIPMENT  
R.F. JACK LAYOUT  
CABINETS NO. 7 & 11

TRACED			
DRAWN			
ELECTRONICS PLAN		ELECTRONICS DIVISION NO. RW23D 380	REV.
F.B.L.M.		SCALE	SHEET 8 OF 11

FIG. 5-15

**CABINET NO. 7 FREQUENCY MONITOR EQUIPMENT  
"REAR VIEW"**

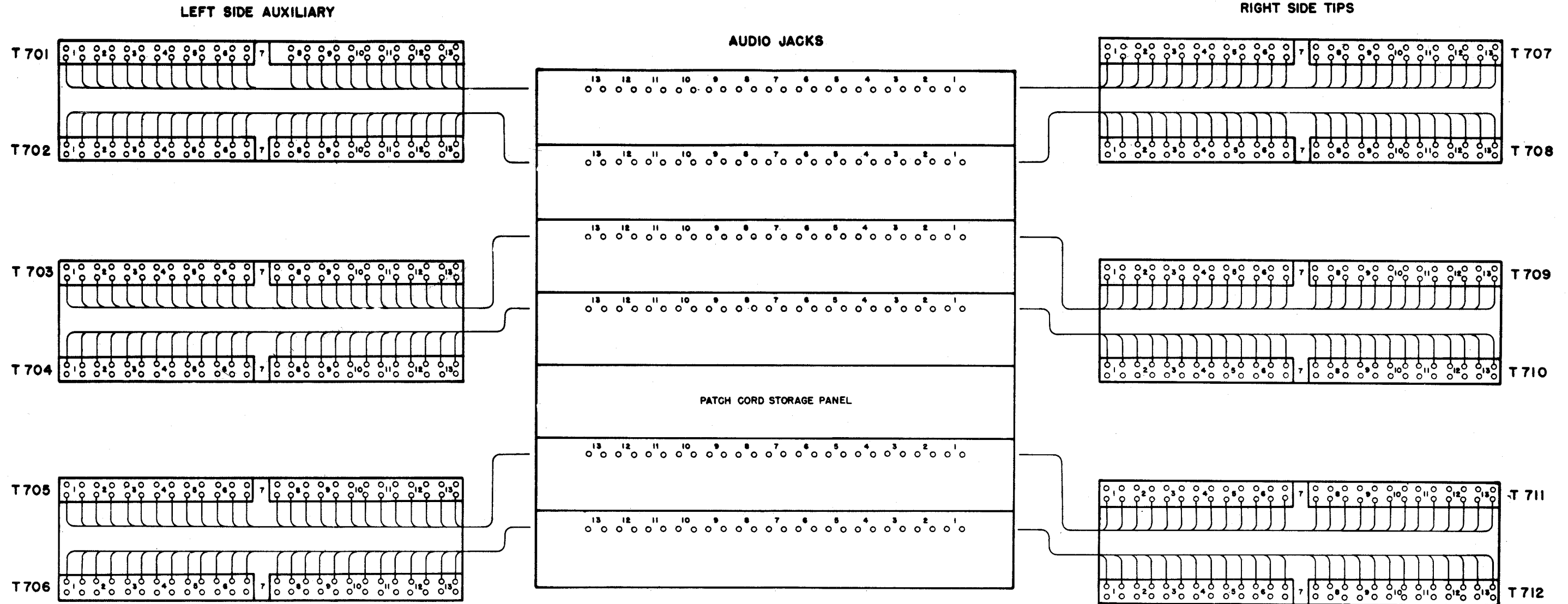

FREQUENCY MONITOR EQUIPMENT		ELECTRONICS DIVISION NO.	
AUDIO JACKS WIRING		RW 23 D 380	
CABINET NO. 7		REV.	
TRACED		ELECTRONICS	SCALE
DRAWN	<i>H. Berg</i>	PLAN	SHEET 4 OF 11

FIG. 5-16



# CABINET NO.9 FREQUENCY MONITOR EQUIPMENT (REAR VIEW)

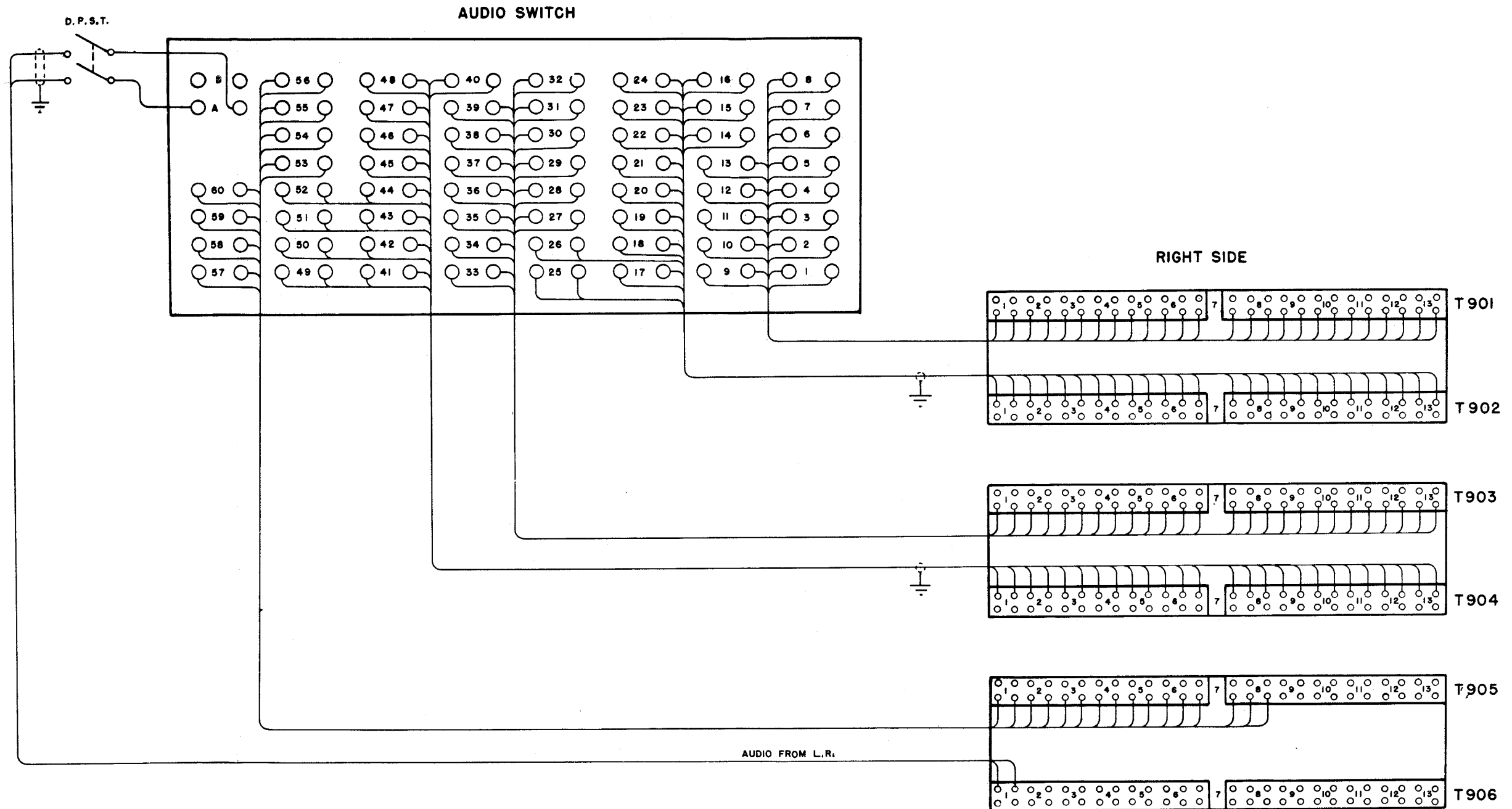

FREQUENCY MONITOR EQUIPMENT  
AUDIO SWITCH WIRING  
CABINET NO. 9

TRACED			REV
DRAWN	<i>J. King</i>	ELECTRONICS DIVISION NO.	
<b>ELECTRONICS PLAN</b>		<b>RW 23 D 380</b>	
		SCALE 00	SHEET 6 OF 11

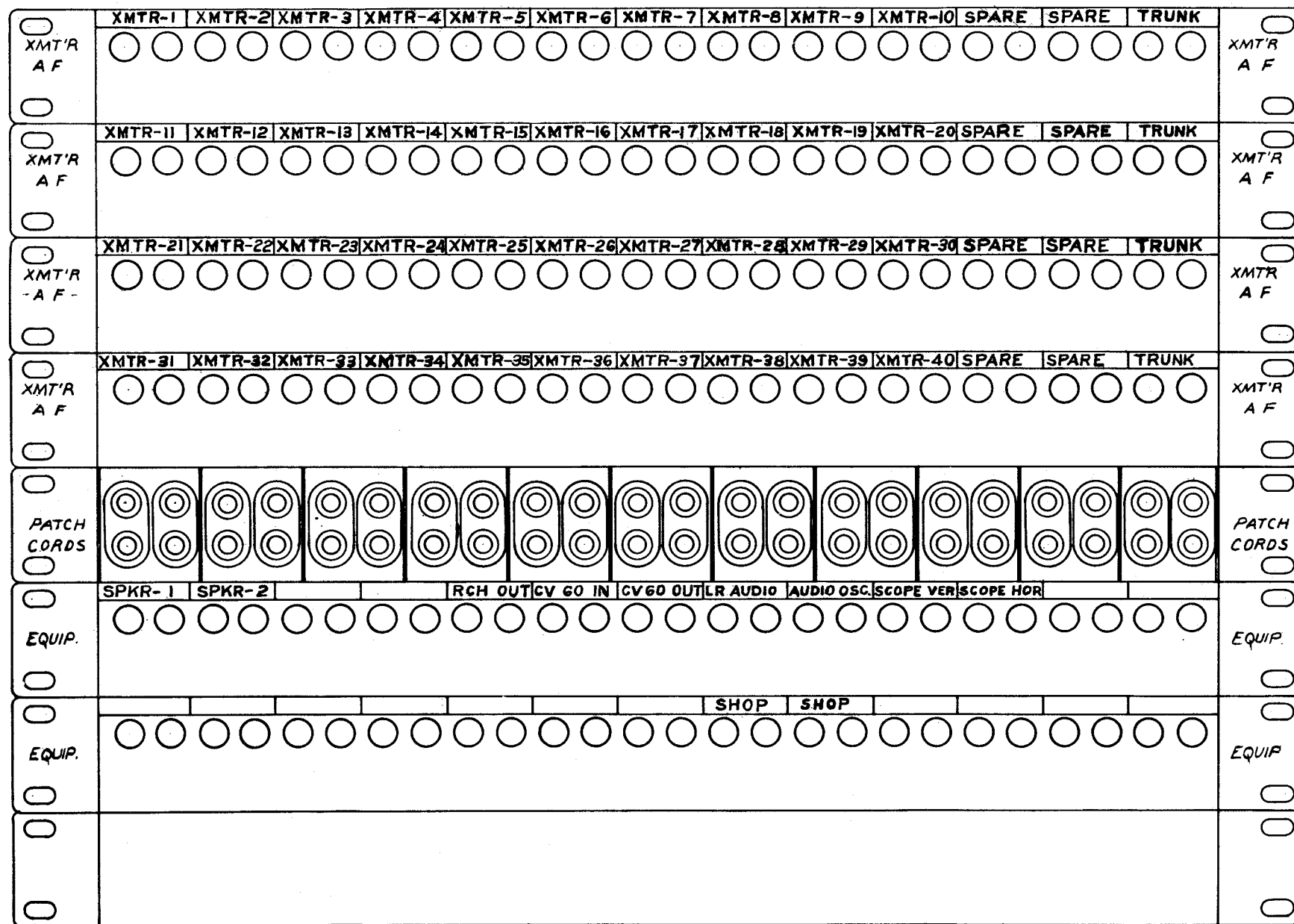

FREQUENCY MONITOR EQUIPMENT  
AUDIO JACKS  
CABINETS NO. 7 & 11

TRACED		
DRAWN		
ELECTRONICS PLAN	ELECTRONICS DIVISION NO.	REV.
	RW 23D 380	
SCALE	SHEET 7 OF 11	

FIG. 5-18

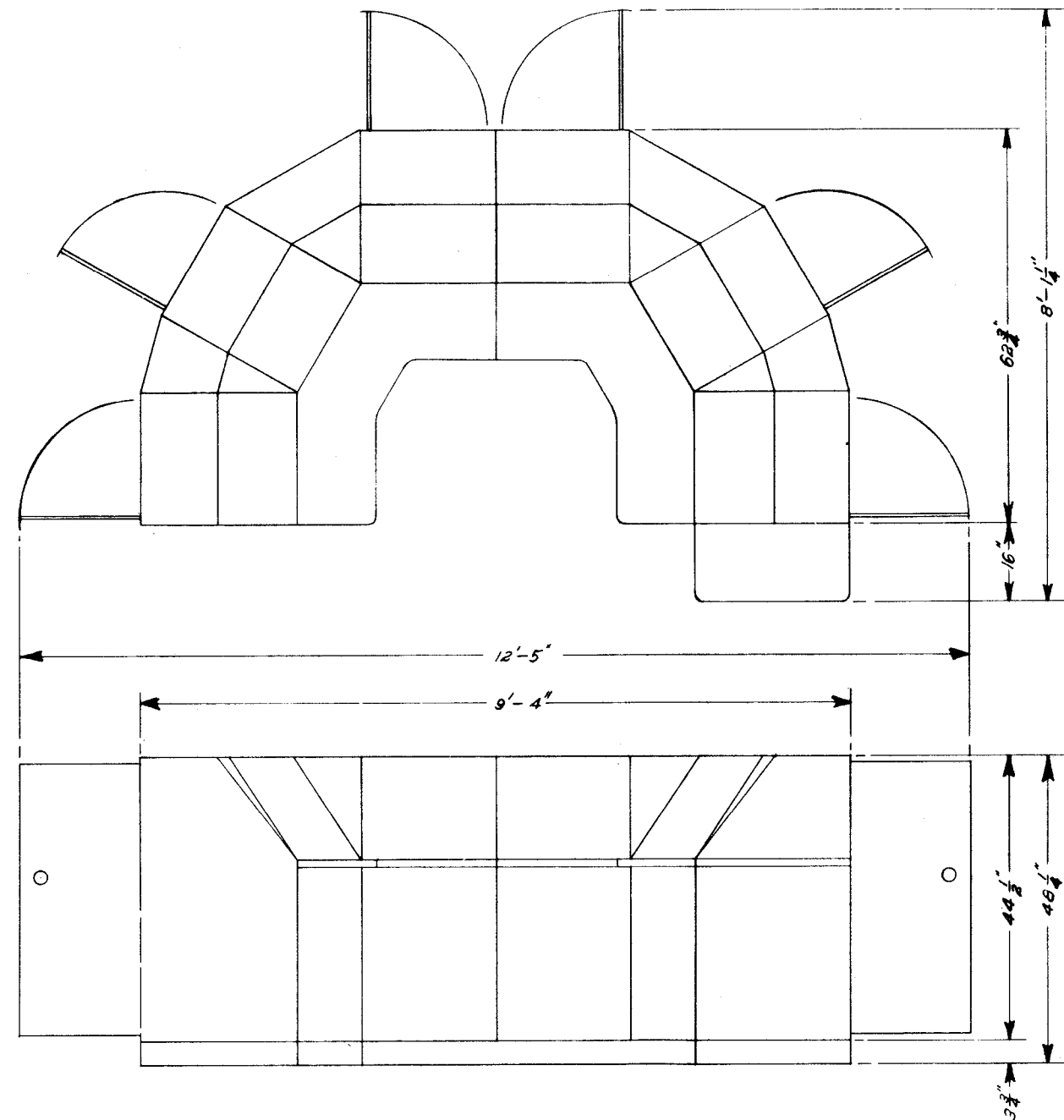
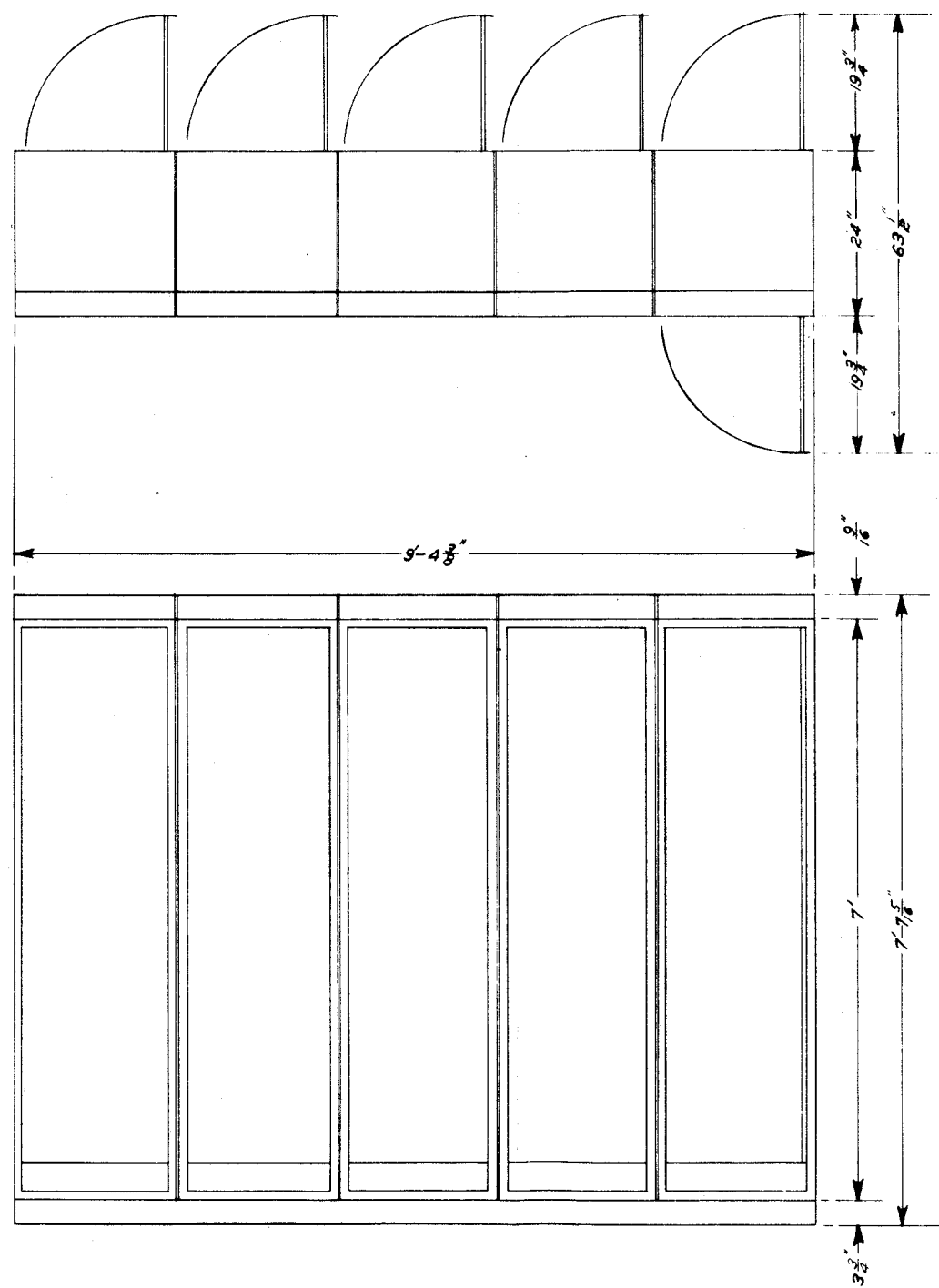

U.S. NAVAL GUN FACTORY		WASHINGTON, D.C.	
		ELECTRONICS DIVISION	
		PUBLIC WORKS DEPARTMENT	
EXAMINED			
OFFICIAL	SIGNATURE	COMMUNICATIONS CONSOLE AND FREQUENCY MONITOR BAY (SPACE REQUIREMENTS)	
C IN C			
STATION			
CHIEF			
ENGINEER	<i>T. P. Collins</i>		
ENGINEER	<i>Chas. Y. ...</i>		
PROJECT	<i>...</i>	DATE 11 MAR 34	
ENGINEER	<i>...</i>	APPROVED <i>...</i>	
IN CHARGE OF	<i>...</i>	FOR SUPT OF N.G.F. E.N.O. - CDR. USN.	
TRACED	<i>...</i>	ELECTRONICS DIVISION NO. _____ REV. _____	
DRAWN	<i>J. P. ...</i>	ELECTRONICS PLAN	
		RW 23 D 413	
		SCALE 1"=1'-0" SHEET 1 OF 1	