

ADA 084225

LEVEL II

①

B.S.

DDC FILE COPY

MAY 16 1980

A

<b>REPORT DOCUMENTATION PAGE</b>		<b>1. REPORT NO.</b> NRL 8300	<b>2.</b> AD-A084 225	<b>3. Recipient's Accession No.</b>
<b>4. Title and Subtitle</b> Evolution of Naval Radio-Electronics and Contributions of the Naval Research Laboratory,			<b>5. Report Date</b> 1979	
<b>7. Author(s)</b> Louis A. Gebhard			<b>6.</b>	
<b>9. Performing Organization Name and Address</b>  Naval Research Laboratory Washington, D.C. 20375			<b>8. Performing Organization Rept. No.</b> NRL 8300	
<b>12. Sponsoring Organization Name and Address</b>			<b>10. Project/Task/Work Unit No.</b>	
			<b>11. Contract(C) or Grant(G) No.</b> (C) (G)	
			<b>13. Type of Report &amp; Period Covered</b>	
			<b>14.</b>	
<b>15. Supplementary Notes</b>  This document is a revision of NRL 7600. <i>Cancelled - p. 201</i>				
<b>16. Abstract (Limit: 200 words)</b>  The document, entitled, "Evolution of Naval Radio-Electronics and Contributions of the Naval Research Laboratory" reviews the U.S. Navy's <del>outstanding</del> achievements in the field of Electronics beginning with its early work in Radio Communication in 1899. Because of its vital need for communication with and between its ships at sea, the Navy held a dominant position in the development of this field during the early years, supported by funds readily obtained from Congress when other interests were quite limited financially. The document also includes a history of the Origin of the Naval Research Laboratory, its organizational development and its establishment as a major part of the Office of Naval Research. The largest part of the document is devoted to a review of the many outstanding achievements of NRL in Electronics since its establishment in 1923. Dr. Louis A. Gebhard, who wrote the document, has had 63 years of service in Naval Electronic Research and Development including 57 years of service to NRL.				
<b>17. Document Analysis a. Descriptors</b> Electronics Communication and radio systems Radio equipment Naval research laboratories  History Radar Radio navigation Electronic countermeasures  <b>b. Identifiers/Open-Ended Terms</b>          <b>c. COSATI Field/Group</b> <i>11.5.1.1/200</i>				
<b>18. Availability Statement:</b> Approved for public release; distribution unlimited.		<b>19. Security Class (This Report)</b> U		<b>21. No. of Pages</b> 462
		<b>20. Security Class (This Page)</b> U		<b>22. Price</b>

## DO NOT PRINT THESE INSTRUCTIONS AS A PAGE IN A REPORT

### INSTRUCTIONS

Optional Form 272, Report Documentation Page is based on Guidelines for Format and Production of Scientific and Technical Reports, ANSI Z39.18-1974 available from American National Standards Institute, 1430 Broadway, New York, New York 10018. Each separately bound report—for example, each volume in a multivolume set—shall have its unique Report Documentation Page.

1. **Report Number.** Each individually bound report shall carry a unique alphanumeric designation assigned by the performing organization or provided by the sponsoring organization in accordance with American National Standard ANSI Z39.23-1974, Technical Report Number (STRN). For registration of report code, contact NTIS Report Number Clearinghouse, Springfield, VA 22161. Use uppercase letters, Arabic numerals, slashes, and hyphens only, as in the following examples: FASEB/NS-75/87 and FAA/RD-75/09.
2. **Leave blank.**
3. **Recipient's Accession Number.** Reserved for use by each report recipient.
4. **Title and Subtitle.** Title should indicate clearly and briefly the subject coverage of the report, subordinate subtitle to the main title. When a report is prepared in more than one volume, repeat the primary title, add volume number and include subtitle for the specific volume.
5. **Report Date.** Each report shall carry a date indicating at least month and year. Indicate the basis on which it was selected (e.g., date of issue, date of approval, date of preparation, date published).
6. **Sponsoring Agency Code.** Leave blank.
7. **Author(s).** Give name(s) in conventional order (e.g., John R. Doe, or J. Robert Doe). List author's affiliation if it differs from the performing organization.
8. **Performing Organization Report Number.** Insert if performing organization wishes to assign this number.
9. **Performing Organization Name and Mailing Address.** Give name, street, city, state, and ZIP code. List no more than two levels of an organizational hierarchy. Display the name of the organization exactly as it should appear in Government indexes such as Government Reports Announcements & Index (GRA & I).
10. **Project/Task/Work Unit Number.** Use the project, task and work unit numbers under which the report was prepared.
11. **Contract/Grant Number.** Insert contract or grant number under which report was prepared.
12. **Sponsoring Agency Name and Mailing Address.** Include ZIP code. Cite main sponsors.
13. **Type of Report and Period Covered.** State interim, final, etc., and, if applicable, inclusive dates.
14. **Performing Organization Code.** Leave blank.
15. **Supplementary Notes.** Enter information not included elsewhere but useful, such as: Prepared in cooperation with . . . Translation of . . . Presented at conference of . . . To be published in . . . When a report is revised, include a statement whether the new report supersedes or supplements the older report.
16. **Abstract.** Include a brief (200 words or less) factual summary of the most significant information contained in the report. If the report contains a significant bibliography or literature survey, mention it here.
17. **Document Analysis.** (a). **Descriptors.** Select from the Thesaurus of Engineering and Scientific Terms the proper authorized terms that identify the major concept of the research and are sufficiently specific and precise to be used as index entries for cataloging.  
(b). **Identifiers and Open-Ended Terms.** Use identifiers for project names, code names, equipment designators, etc. Use open-ended terms written in descriptor form for those subjects for which no descriptor exists.  
(c). **COSATI Field/Group.** Field and Group assignments are to be taken from the 1964 COSATI Subject Category List. Since the majority of documents are multidisciplinary in nature, the primary Field/Group assignment(s) will be the specific discipline, area of human endeavor, or type of physical object. The application(s) will be cross-referenced with secondary Field/Group assignments that will follow the primary posting(s).
18. **Distribution Statement.** Denote public releasability, for example "Release unlimited", or limitation for reasons other than security. Cite any availability to the public, with address, order number and price, if known.
19. & 20. **Security Classification.** Enter U.S. Security Classification in accordance with U.S. Security Regulations (i.e., UNCLASSIFIED).
21. **Number of pages.** Insert the total number of pages, including introductory pages, but excluding distribution list, if any.
22. **Price.** Enter price in paper copy (PC) and/or microfiche (MF) if known.

# DISCLAIMER NOTICE

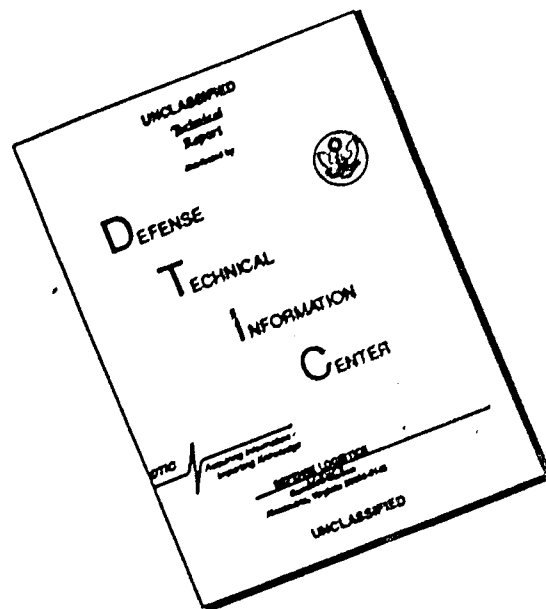

THIS DOCUMENT IS BEST QUALITY AVAILABLE. THE COPY FURNISHED TO DTIC CONTAINED A SIGNIFICANT NUMBER OF PAGES WHICH DO NOT REPRODUCE LEGIBLY.

WILL

①

NRL Report 8300

⑥

**Evolution of Naval Radio-Electronics  
and Contributions of the  
Naval Research Laboratory,**

Revision

⑩

LOUIS A. GEBHARD

⑭

NRL-8300

⑫

456

⑪

1979

SELECTED  
MAY 16 1980

A



NAVAL RESEARCH LABORATORY  
Washington, D.C.

251950 80 5 14 103

## DEDICATION

To all of those individuals, both military and civilian, with whom I have been associated in advancing the capability to defend our country, and particularly to the many persons whose contributions have made this document possible.

ASSOCIATION FOR	
MEMBERSHIP	<input checked="" type="checkbox"/>
DOC. TAG	<input type="checkbox"/>
UNIFORMS	<input type="checkbox"/>
JURISDICTION	<input type="checkbox"/>
\$ 12.00	
Distribution/ <u>GPO</u>	
Availability for books	
Dist	Avail and/or special
A 24	

Library of Congress Catalog Number 79-600083

For sale by the Superintendent of Documents, U.S. Government Printing Office  
Washington, D.C. 20402

Stock Number 008-060-00189-5

## Preface

From the beginning of the twentieth century, the Navy has been a pioneer in initiating new developments in radio-electronics and a leader in their utilization in military operations. Since radio-electronics has become an instrumentality of major importance, vital to the defense of the United States, this document has been written to give adequate expression, with supporting evidence, to the important steps in its evolution as far as possible. From its establishment in 1923, the Naval Research Laboratory (NRL), through its research and development activities, has played a major role in this evolution, so the principal part of this document is devoted to its contributions in this field and their impact on military operations.

By way of introduction to the subject, the Navy's early important radio-electronics developments through World War I are summarized in Chapter 1. The impact of radio-electronics upon the course of events leading to the establishment of the Laboratory, its early program generation, and organizational development are reviewed in Chapter 2. The remaining nine chapters state NRL's many accomplishments which have been achieved through its research and development work with respect to radio-electronic phenomena, systems, equipment, and components in support of the Navy's operational needs. The resulting developments have greatly improved the operational capability not alone of the Navy but also of the other military services and other government departments of this country and its allies and commercial interests.

Besides its general informative function, this document may prove of value when change in duty brings new responsibilities to officials requiring background information on pertinent specific radio-electronic topics as a basis for

planning of future activities. Furthermore, it may be useful to personnel beginning to engage in work in specific fields through acquainting them with what has transpired prior to their entrance. An objective of this document is to identify NRL's numerous scientific reports which are associated with specific radio-electronic topics, so that the detailed information these reports contain may be made readily accessible to those who may be involved with the subject matter in the future. The document is so arranged that each chapter can be considered as a separate and distinct evolutionary treatise on the specific radio-electronics areas of radio communication; radar; radio remote control-missile guidance; radio identification; radio navigation; electronic countermeasures; precise radio frequency, time, and time interval; electronic systems integration; and satellite electronics.

About 1910, the original word "wireless," as relating to matters pertaining to propagated electromagnetic waves, was superseded by the word "radio" in the United States. To bring about advancement in the radio field, the electron tube was developed. The versatility of this tube led to the word "electronics" to express its broad field of applications. The term "radio-electronics" as used in this document is intended to indicate that the scope of the document concerns that part of electronics dealing with the utilization of radiations in the radio-frequency spectrum of particular interest to the Navy and the other military services. The document cites the Laboratory's contributions which have advanced the operational capability of the Navy in this field. It is not intended that it cover the Laboratory's electronic achievements in such

fields as acoustics and optics, since these have been treated by other authors.\*

The author of this document, during his career of over 58 years in Naval research and development, has had the great privilege of witnessing, from an advantageous observation point, most of the 75 years of evolution of naval radio-electronics. Participation in activities in this field from the beginning of his scientific career in early Naval laboratories, association with NRL since its establishment in 1923, and service as superintendent of the later Radio Division of the Laboratory during a period of nearly 23 years has enabled the author to develop and maintain contacts with many knowledgeable members of the Navy who have made important contributions, both operationally and scientifically, to the advancement of Naval radio-electronics. The author is greatly indebted to these individuals, whose provision of much unique information has made possible the writing of this document.

For nearly half of his career the author had the opportunity of being associated with the Navy's senior radio-electronics scientist, Dr. A. Hoyt Taylor, whose scientific career spanned World Wars I and II. This association provided the author with invaluable insight into the scientific interpretation and treatment of Navy operational problems. During World War I, Dr. Taylor, in addition to his Naval military responsibilities, conducted research for the Navy in radio communication. After this war, he was head of the Naval Aircraft Radio Laboratory, Naval Air

Station, Washington (Anacostia), D.C. In 1923, through transfer of this Laboratory, he became superintendent of the original Radio Division of NRL, a position he held until the end of World War II. The original staff of this division grew from a total of 23 to over 1000 during World War II. The Laboratory's present Electronics Area has resulted from the evolution of this original Radio Division. As superintendent of this division, Dr. Taylor was responsible for original developments in radio communication at high frequency, very high frequency, and ultra high frequency, and in the fields of radar, radio identification, radio remote control with respect to guided missiles, radio navigation, electronic countermeasures, and precise frequency and time.

From an operational standpoint, Rear Admiral Stanford C. Hooper, whose career covered the period from 1905 through the early days of radio and World Wars I and II, had a marked influence on the Laboratory's early radio program. His activities benefited the author's understanding of Naval objectives, viewpoints, and procedures. During his career, Rear Admiral Hooper held many key radio operational positions, including that of the Fleet's first radio officer, and Head of the Bureau of Engineering's Radio Division, which sponsored the Laboratory's early radio program. His career culminated in the position of Director of Naval Communications under the Chief of Naval Operations. During their careers, Dr. Taylor and Rear Admiral Hooper, each in his respective field, had tremendous impact on the advancement of Naval radio-electronics.

To make NRL's achievements readily apparent to the reader, highlights of special significance have been set forth in the text in boldface letters.

At the end of each chapter, appropriate references to support the statements made in the document are given, insofar as it has been possible to locate the pertinent written material. Reference sources include the Annual Reports of the Secretary of the Navy (1898-1910), available in the Navy Department Library of the Naval Historical Center. The NRL Library has available the Bureau of Engineering's Monthly Radio and Sound

\*H.C. Hayes, "A Brief History of the Sound Division, NRL," Jan. 1947, NRL Library V394.B4.H396 Ref

Elias Klein, "Underwater Sound and Naval Acoustical Research and Applications before 1939," J. Acoust. Soc. Am., May 1968, pp. 931-947, NRL Library V394.B4.K55 Ref

Homer R. Baker, "A Brief History of the NRL Sound Division Under the Leadership of Dr. Harold L. Sutton, 1948-1967," [Washington, 1967], NRL Library V394.B4.B3 Ref

J.A. Sanderson, "Optics at the Naval Research Laboratory," Applied Optics, Dec. 1967, pp. 2029-2043, NRL Library V394.B4.525 Ref

R.Tousey, "Highlights of Twenty years of Optical Space Research," Applied Optics, Dec. 1967, p.p. 2044-2070, NRL Library V394.B4.T6 Ref



Reports (1919-1948), later called Bulletins, and referred to in this document as NRSR (NRL Library VG77.A15.B8 Ref); "Naval Research Laboratory Legislative History, 1916-1942" (NRL Library V394.B4.U56 Ref); and "Establishment and Organizational Documents of the Naval Research Laboratory" (NRL Library V394.B4.G41 Ref), containing copies of important papers relating to the formation and organizational development of the Laboratory. The NRL correspondence files, stored in the National Archives and the Federal Record Center, are available through letter file numbers and index in NRL's Correspondence and Records Management Office (CRMO, as used in the references). Reference sources for both early and

later advances in Naval radio-electronics include Proceedings of the Institute of Radio Engineers (IRE, now the Institute of Electrical and Electronic Engineers, IEEE) and other journals, available in NRL Library, as well as numerous reports and documents available in NRL's document room. Important references to NRL's contributions are Dr. A. Hoyt Taylor's "Radio Reminiscences: A Half Century," available in NRL's Library (V394.B4.T3 Ref), and "The First 25 Years of the Naval Research Laboratory" (V394.B4.T31 Ref).

The pictures in this document are numbered to permit identification and location in the Laboratory's photographic files.

LOUIS A. GEBHARD

This document is a revision of NRL Report 7600.

## Foreword

Rare it is to find the combination of scientist and historian—and in the right place at the right time. The first fifty years of the exploitation and development of ideas in radio and electronics at the Naval Research Laboratory spanned an exciting time in both fields. In the 1920s, radio was in its infancy and radar was yet to be discovered. In the interim, through the development of electronic tube technology and breakthroughs in transistor and printed circuit board technology, radio has progressed to its present state of sophistication; and radar, having progressed from theory to practicality to military application, is now a reality. High-frequency communication, the mainstay of the Navy in radio communication, has its technological basis in the development work done at the NRL during these fifty years.

And the man who chronicles these events as they occurred in radioelectronics at NRL, Dr. Louis A. Gebhard, is that rare combination. In 1913, at the age of 17, he was issued one of this country's first radio operator's licenses. In 1917, he was engaged in radio work while on active duty in the U.S. Navy, stationed at the Naval Radio Research Laboratory, Great Lakes, Illinois. In 1919, as a civilian, he began original research in aircraft radio communication at the Anacostia Naval Research Station, Washington, D.C. Dr. Gebhard transferred to the NRL in 1923 on the establishment of the Laboratory.

By 1935, Dr. Gebhard had advanced to the position of Assistant to the Superintendent of the Radio Division; in 1945 he was appointed Superintendent, a position he held until his

retirement in 1965. He was responsible for many of the developments in radar, electronic countermeasures, navigation, electronic data systems, cryptographic techniques, high-frequency radio communications, and satellite communication. He engaged in many activities which established the basic guidelines of the Navy's research programs after World War II.

Throughout his long career, Dr. Gebhard displayed a remarkable ability to recognize and exploit new and revolutionary technical approaches applicable to a multiplicity of serious naval problems. His insight, leadership, and unflagging enthusiasm supported his staff in prompt exploration and application of many important scientific breakthroughs to benefit the Navy. He has received many awards for his outstanding accomplishments, among them is the Presidential Certificate which he received in 1946.

In 1924, Dr. Gebhard earned a L. L. B. degree from Georgetown University; he was admitted to the Bar and was accepted to practice before the Supreme Court. He earned a B.S. in Electrical Engineering from George Washington University in 1930. He was awarded a Doctor of Juris degree by Georgetown University in 1967. Over 90 patents have been issued in his name.

Dr. Gebhard's interest and enthusiasm for NRL and science have not been abated by retirement, but have resulted in this history of radioelectronics during the first fifty years of the Laboratory—a fitting pinnacle to a distinguished scientific career.

  
ALAN BERMAN  
Director of Research

## CONTENTS

Preface.....	iii
Foreword.....	vii

### CHAPTER 1 EARLY NAVY RADIO-ELECTRONICS

INTRODUCTION .....	1
THE INCEPTION OF U.S. NAVAL RADIO.....	2
BEGINNING OF THE NAVY'S RADIO COMMUNICATION SYSTEM.....	2
EARLY RADIO EQUIPMENT DEVELOPMENT.....	5
EARLY RADIO TRANSMITTERS.....	5
<u>Spark Transmitters</u> .....	6
<u>Arc Transmitters</u> .....	6
<u>High-Frequency (HF) Alternator Transmitters</u> .....	10
EARLY RADIO RECEIVERS.....	11
EARLY VACUUM TUBE RADIO EQUIPMENT.....	12
INCEPTION OF NAVAL IN-HOUSE RADIO RESEARCH.....	15
AIRCRAFT RADIO COMMUNICATION.....	16
THE BEGINNING OF THE NAVY'S IN-HOUSE DEVELOPMENT OF RADIO EQUIPMENT.....	18
U.S. NAVAL RADIO LABORATORY, GREAT LAKES, ILLINOIS.....	20
NAVY TRANSATLANTIC COMMUNICATION SYSTEM AND RESEARCH ACTIVITIES (1917-1918).....	20
U.S. NAVAL AIRCRAFT RADIO LABORATORY, WASHINGTON (ANACOSTIA), D.C.....	21
<u>Radio Broadcasting</u> .....	21
<u>Radio Detection</u> .....	24
<u>Aircraft Radio</u> .....	24
REFERENCES .....	25

### CHAPTER 2 THE ESTABLISHMENT OF THE NAVAL RESEARCH LABORATORY

INTRODUCTION .....	27
THE NAVAL CONSULTING BOARD.....	27

ORGANIZATION OF THE NAVAL RESEARCH LABORATORY.....	31
ADMINISTRATIVE STATUS OF NRL.....	34
SCOPE OF THE LABORATORY'S ACTIVITIES .....	36
POSTWAR ORGANIZATIONAL STRUCTURE.....	37
NRL'S RADIO-ELECTRONICS PROGRAM.....	39
REFERENCES .....	40

### CHAPTER 3 RADIO COMMUNICATION

INTRODUCTION .....	43
COMMUNICATION IN THE HIGH-FREQUENCY BAND .....	43
<u>Radio Propagation</u> .....	43
<u>The Navy's Adoption of High Frequencies</u> .....	45
<u>Radio-Frequency Channel Allocation</u> .....	47
<u>High-Frequency Equipment</u> .....	49
Intrafleet HF Equipment .....	49
Piezoelectric (Quartz) Crystal Frequency Control.....	49
Crystal-Controlled Transmitters .....	51
Shore Station High-Frequency, High-Power Transmitters.....	53
Ship High-Frequency Transmitters .....	54
Ship High-Power, High-Frequency Transmitters .....	55
Submarine High-Frequency Transmitters .....	55
"Electron-Coupled" Oscillator-Controlled Transmitters .....	57
High-Frequency Transmitter Development, 1930 to 1945 .....	58
High-Frequency Receivers.....	58
Superheterodyne High-Frequency Receivers.....	60
High-Frequency Receiver Development, 1930 to 1945 .....	61
Navy Outfitted with High-Frequency Equipment.....	61
Aircraft High-Frequency Equipment .....	63
<u>Teleprinter-Facsimile</u> .....	67
<u>Television</u> .....	70
<u>Communication Circuit Multiplexing</u> .....	71
<u>High-Frequency Single-Sideband System</u> .....	72
<u>Communication Security</u> .....	73
Electronic Encryption System .....	73
Cipher Key Quality.....	75
Electronic Station Call Sign Encryptor .....	75
Compromising Emanations .....	76
<u>High-Frequency Antennas</u> .....	78
Integration of Ship Superstructure in HF Antenna Systems .....	78
Conical Monopole Antenna .....	79
Conical Monocone Antenna.....	80
High-Frequency Shipboard Antenna Radiation Characteristics .....	82

<u>High-Frequency Antenna Multiplexing</u> .....	82
<u>Transmitter Multiplexing</u> .....	84
Receiver Multiplexing.....	86
<u>High-Frequency Communication from Submerged Submarines</u> .....	88
<u>Transosonde System</u> .....	89
<b>COMMUNICATION IN THE VERY-HIGH AND ULTRA-HIGH</b>	
<b>FREQUENCY BANDS</b> .....	94
<u>Introduction</u> .....	94
<u>Very-High-Frequency Band (VHF)</u> .....	96
<u>The Ultra-High-Frequency Band (UHF)</u> .....	99
Introduction.....	99
UHF Equipment .....	100
Amplitude Modulation vs Frequency Modulation	
in UHF Communication Systems.....	104
Communication Systems Planning.....	105
UHF Antennas.....	105
Directive Antenna System .....	107
UHF Antenna Multiplexing.....	107
Tropospheric Scatter Communication .....	107
Radio Buoys.....	111
<b>COMMUNICATION AT SUPER-HIGH FREQUENCIES</b> .....	114
<u>Introduction</u> .....	114
<u>Millimeter Waves</u> .....	114
<u>Satellite Communication</u> .....	114
Early Satellite Communication .....	115
First Operational Satellite Communication System.....	116
Ship-Shore Satellite Communication System.....	118
NRL Sugar Grove Satellite Communication Research Facility .....	123
NRL Waldorf Satellite Communication Research Facility.....	123
Communication with Active Satellites.....	124
The Defense Satellite Communication System.....	127
Satellite Characteristics .....	127
Target Photo Transmissions, Southeast Asia to Washington.....	129
Navy Shipboard SATCOM Terminals .....	129
Acquiring Satellites from Shipboard Terminals.....	130
Navy Procurement of Shipboard Satellite Terminals .....	130
The Defense Satellite Communication System, Phase II .....	133
Tactical Satellite Communication System (TACSATCOM).....	134
<b>COMMUNICATION AT THE LOWER RADIO FREQUENCIES</b> .....	136
<u>Introduction</u> .....	136
<u>Radio-Wave Propagation at the Lower Frequencies</u> .....	137
<u>Long-Wave Propagation Center</u> .....	138
<u>Radio-Wave Propagation at the Very-Low Frequencies</u> .....	138
<u>Very-Low-Frequency Communication Coverage Prediction</u> .....	141
<u>Airborne VLF Transmission</u> .....	142

<u>Communication with Submerged Submarines Via Satellites</u> .....	142
<u>Lower Frequency Antennas</u> .....	144
<u>Submarine Trailing-Wire Antennas</u> .....	145
<u>Lower Frequency Shipboard Antennas</u> .....	145
<u>Very-Low-Frequency Transmission</u> .....	147
<u>Communication Between Completely Submerged Submarines</u> .....	148
<u>Radio Reception by Submerged Submarines</u> .....	151
<u>Lower Frequency Radio Receivers</u> .....	155
REFERENCES .....	157

#### CHAPTER 4 RADAR

ORIGIN OF RADAR .....	169
FIRST OBJECT DETECTION BY RADIO.....	169
DISTANCE MEASUREMENT WITH REFLECTED RADIO PULSES.....	169
FIRST DETECTION OF AIRCRAFT BY RADIO .....	171
ASSOCIATION OF TECHNIQUES FOR RADAR .....	172
FIRST RADARS.....	172
200-MHz RADAR.....	176
RADAR ANTENNA DUPLEXER .....	176
FIRST SHIPBOARD RADAR .....	176
HIGHER PULSE POWER WITH RECEIVER PROTECTION.....	178
THE FLEET'S FIRST RADAR - MODEL XAF .....	179
SEARCH RADARS FOR WORLD WAR II.....	183
SUBMARINE SEARCH RADAR.....	186
SUPER-HIGH-FREQUENCY (MICROWAVE) SEARCH RADARS.....	187
POSTWAR SHIPBOARD SEARCH RADARS .....	189
LOWER FREQUENCY RADARS .....	190
MICROWAVE SEARCH - FIGHTER AIRCRAFT DIRECTION RADAR .....	191
RADAR INFORMATION DISPLAYS.....	193
FIRE-MISSILE CONTROL RADAR .....	195
CONICAL-SCAN RADAR.....	198
MONOPULSE RADAR (SIMULTANEOUS LOBING) .....	198
AIRBORNE RADAR .....	201
AIRBORNE MICROWAVE RADAR .....	203
POSTWAR AIRBORNE RADAR .....	204
AIRBORNE WEAPON SYSTEMS - GUIDED MISSILE RADAR.....	205
AIRBORNE EARLY WARNING RADAR (AEW).....	206

UHF-AEW RADAR .....	209
AIRBORNE SEA SURVEILLANCE RADAR .....	212
OVER-THE-HORIZON (OTH) HIGH-FREQUENCY RADAR.....	212
REFERENCES .....	216

**CHAPTER 5  
RADIO REMOTE CONTROL—MISSILE GUIDANCE**

INTRODUCTION .....	223
FIRST FLIGHT OF A RADIO-CONTROLLED PILOTLESS AIRCRAFT .....	224
RADIO REMOTE CONTROL OF TRANSMITTERS .....	227
RADIO-CONTROLLED DRONES .....	227
ASSAULT DRONES .....	229
COMBAT USE OF GUIDED MISSILES DURING WORLD WAR II .....	232
RADIO-GUIDED BOMBS.....	232
POSTWAR RADIO GUIDED MISSILES.....	233
BAT MISSILE .....	235
GORGON MISSILE.....	236
GARGOYLE MISSILE.....	236
LARK AND SKYLARK GUIDED MISSILES.....	236
KINGFISHER GUIDED MISSILE .....	239
BULLPUP GUIDED MISSILE .....	240
LOON SHIP-TO-SURFACE GUIDED MISSILE.....	241
REGULUS ASSAULT GUIDED MISSILE.....	242
POLARIS MISSILE .....	243
NRL'S GENERAL CONTRIBUTIONS TO GUIDED MISSILE .....	247
REFERENCES .....	247

**CHAPTER 6  
RADIO IDENTIFICATION — IFF**

INTRODUCTION .....	251
FIRST IFF SYSTEM.....	251
PULSE IFF.....	253
IFF WITH CRYPTOGRAPHIC SECURITY.....	253
WORLD WAR II-IFF .....	253
MARK III IFF SYSTEM.....	255

MARK V IFF SYSTEM.....	256
MARK X IFF SYSTEM.....	257
MARK X (SIF) IFF SYSTEM.....	258
MARK XII IFF SYSTEM.....	258
PULSE BEACONS.....	259
REFERENCES.....	260

## CHAPTER 7 RADIO NAVIGATION

RADIO DIRECTION FINDERS—"RADIO COMPASS".....	263
THE NAVY'S COASTAL RADIO DIRECTION-FINDER SYSTEM.....	264
RADIO DIRECTION-FINDER DEVELOPMENT (SHORE).....	264
RADIO DIRECTION-FINDER DEVELOPMENT (SHIP).....	267
AIRCRAFT DIRECTION FINDERS.....	267
AIRCRAFT HOMING SYSTEM.....	271
AMPHIBIOUS LANDING SYSTEM.....	274
AIRCRAFT NAVIGATORS (ALTITUDE, GROUND SPEED, DRIFT).....	274
AUTOMATIC AIRCRAFT NAVIGATOR.....	276
CARRIER AIRCRAFT TRAFFIC AND LANDING CONTROL.....	279
PULSE NAVIGATIONAL SYSTEMS.....	280
OMEGA—VLF WORLDWIDE, ALL-WEATHER, RADIO NAVIGATION SYSTEM.....	283
LANE IDENTIFICATION.....	287
AIRBORNE OMEGA.....	287
DIFFERENTIAL OMEGA.....	290
OMEGA SYSTEM IMPLEMENTATION.....	293
HIGH-PRECISION RADIO NAVIGATION SYSTEMS.....	293
REFERENCES.....	294

## CHAPTER 8 ELECTRONIC COUNTERMEASURES

INTRODUCTION.....	299
ELECTRONIC COUNTERMEASURES DURING WORLD WAR I.....	300
NRL'S EARLY ELECTRONIC COUNTERMEASURES DEVELOPMENTS.....	300
WORLD WAR II ELECTRONIC COUNTERMEASURES.....	300
POSTWAR ELECTRONIC COUNTERMEASURES.....	307
HIGH-FREQUENCY INTERCEPT AND DIRECTION FINDING.....	307



SHIP HIGH-FREQUENCY RADIO DIRECTION FINDERS.....	308
WIDE-APERTURE, CIRCULARLY DISPOSED DIRECTION FINDER .....	311
RADIO DIRECTION FINDER CALIBRATION WITH A SATELLITE.....	315
AIRBORNE VHF-UHF-SHF INTERCEPT AND DIRECTION FINDER SYSTEMS.....	315
SUBMARINES VHF-UHF-SHF INTERCEPT AND DIRECTION-FINDER SYSTEMS.....	316
"UNIVERSAL" SHIP RADAR INTERCEPT SYSTEM .....	320
SHIPBOARD SHF INTERCEPT RECEIVER-DIRECTION FINDER.....	320
SHIPBOARD INTERCEPT RECEIVER BLANKING .....	323
INTERCEPT SIGNAL ANALYSIS.....	325
SIGNAL RECORDING .....	325
JAMMERS .....	330
ELECTRONIC DECEPTION-PULSE REPEATERS .....	335
RADAR PASSIVE DECEPTION AND CONFUSION .....	338
REFERENCES .....	340

**CHAPTER 9  
PRECISE RADIO FREQUENCY, TIME, AND TIME INTERVAL**

INTRODUCTION.....	343
RADIO-FREQUENCY CHANNEL ALLOCATION .....	343
DESIGNATION OF RADIO-SPECTRUM FUNCTIONS BY FREQUENCY .....	345
DETERMINATION OF RADIO FREQUENCY FROM TIME.....	346
RADIO-FREQUENCY STANDARDS AND INSTRUMENTATION .....	348
FREQUENCY STANDARDIZATION.....	349
RADIO-FREQUENCY METERS FOR THE HIGHER FREQUENCIES .....	350
RADIO-FREQUENCY MONITORING SYSTEM.....	351
HIGH-PRECISION FREQUENCY COMPARATOR.....	355
DECADE FREQUENCY SYNTHESIZER .....	356
HIGH PRECISION SHIPBOARD RADIO-FREQUENCY STANDARD.....	357
NAVAL TASK FORCE RADIO FREQUENCY MONITORING SYSTEM .....	357
ATOMIC FREQUENCY STANDARDS.....	358
ATOMIC HYDROGEN MASER FREQUENCY STANDARD .....	361
OFFICIAL STANDARD TIME FOR THE UNITED STATES.....	361
STANDARD TIME TRANSMISSIONS WITH QUARTZ-CRYSTAL CLOCK .....	363
TIME-TRANSMISSION EQUIPMENT FOR REMOTE STATIONS.....	364

VLF WORLDWIDE PRECISION TIME AND FREQUENCY TRANSMISSION SYSTEM.....	365
PRECISE TIME TRANSMISSION VIA COMMUNICATION SATELLITES.....	369
CENTRALIZED FREQUENCY AND TIME CONTROL.....	369
REFERENCES .....	373

**CHAPTER 10  
ELECTRONIC SYSTEMS INTEGRATION**

INTRODUCTION .....	375
ELECTRONIC TACTICAL DATA SYSTEMS.....	379
PROJECT COSMOS.....	381
THE NAVY'S ELECTRONIC DATA SYSTEM .....	381
NAVAL TACTICAL DATA SYSTEM (NTDS).....	384
THE NAVY'S AIRBORNE TACTICAL DATA SYSTEM (ATDS).....	386
MARINE TACTICAL DATA SYSTEM (MTDS).....	390
REFERENCES .....	393

**CHAPTER 11  
SATELLITE ELECTRONICS**

INTRODUCTION .....	395
PROJECT VANGUARD.....	395
SATELLITE DEVELOPMENT.....	400
SOLRAD .....	403
TIMATION SATELLITE.....	407
U.S. NAVAL SPACE SURVEILLANCE SYSTEM (WS-434).....	407
REFERENCES .....	413
INDEX.....	415

## Chapter 1

### EARLY NAVY RADIO-ELECTRONICS

#### INTRODUCTION

At the beginning of the twentieth century, the U.S. Navy realized that radio communication had reached a stage of practicality such that its use might have great impact on tactics and strategy. Long-distance communication with ships underway, hitherto impossible, could increase the effectiveness of its operations at sea. Rapid, direct control from Washington of its sea forces as they ranged the oceans of the world would be possible, enhancing their application and power. The nation would gain in worldwide prestige and in its diplomatic and economic posture. As these considerations became manifest, the Navy proceeded with initial installations on its ships and at its shore stations of the best radio-communication equipment it could procure. The Navy thereafter followed a program of improvement which has continued to the present day. The conduct of the program resulted in the Navy's becoming the principal sponsor of radio-electronics in this country and a pioneer in its early development.

The importance and uniqueness of radio communication relative to Navy use gave the Navy dominance over other users and placed it in a strong position to obtain funding from Congress. Thus, the Navy was able to provide the principal support in fostering the rapid growth of a radio industry in this country. Due to the availability of this industry, possible compromise of national security through reliance upon foreign suppliers, particularly in wartime, was avoided. Navy sponsorship was particularly important to the new industry during the critical period following the initial installation of equipment on commercial vessels, to provide for safety at sea. After this initial activity, little financial return was to

be had from other commercial radio manufacturing. This situation continued for nearly two decades, until the advent of radio broadcasting during the 1920's.

The Navy's recognized leadership in radio placed it in an authoritative position to have important influence on national legislation and international agreements to control the use of radio to avoid interference. The Navy became the spokesman for the executive department of the government in an effort which resulted in the first legislation to control radio use in the United States. It also originated the plan which became the basis for the international control of the assignment of frequency channels in the radio spectrum, accepted by the nations of the world. At the beginning of World War I, the President designated to the Navy responsibility for taking control of all the nation's radio-communication facilities (except Army field activities) and operating them for the duration of the war. During the war the Navy had the responsibility for handling all radio-communication traffic with foreign nations. After the war the Navy played a major part in the formation and establishment of the organization which became the present Federal Communications Commission.

Among the achievements resulting from the Navy's early initiative and sponsorship of research, one of far-reaching importance was the development of the reliable electron tube during World War I. Prior to this development, tubes had such short life and poor performance as to make them unsatisfactory for service use. The availability of reliable electron tubes after the war was a major factor in the great expansion the radio industry experienced with the advent of radio broadcasting. The versatility of the elec-

## EARLY NAVY RADIO-ELECTRONICS

tron tube ushered in the new era of electronics which in later years was to have a tremendous impact on the nation's economy and interests.

The Navy was early to recognize the value of an in-house scientific activity to provide support in the radio field and established a laboratory for this purpose in 1908. Later, this support was augmented by additional facilities to engage in other phases of the radio field. These activities proved their worth, particularly during periods of lack of commercial interest in the Navy's progressive needs, which was strongly evident both before and after World War I, when profits from large procurements were not available. When the establishment of the Naval Research Laboratory was proposed, those members of the Navy staff directly responsible for the existing radio activities gave early and strong support to the proposal. They realized that consolidation of radio activities at one location in the new Laboratory, and association with other fields of science in which the Laboratory was to engage, would bring increased effectiveness and productivity. In the Naval Research Laboratory, the Navy gained a fertile capability in radio-electronics which placed at its command new scientific means of critical import to its success in contending with the new and much more powerful modes of warfare it was to experience in future years.

The highlights of the technological progress in radio-electronics brought about by the Navy, the sequence of events following the early origin of the Navy's in-house research activity in this field, culminating in its consolidation with the establishment of the Naval Research Laboratory, and the extensive contributions of this Laboratory which have enabled the Navy through the ensuing years to maintain its scientific leadership in the field, are reviewed in this document.

### THE INCEPTION OF U.S. NAVAL RADIO

Toward the close of the 19th century experimenters had achieved considerable success in demonstrating the practicality of radio com-

munication.<sup>1-4</sup> The Navy followed these developments with keen interest, in view of its increasing need for more rapid communication between the Navy Department in Washington and Naval squadrons operating in various parts of the world.<sup>5</sup> Cables to many remote points were available, but rapid communication between these points and ships at sea was lacking. In 1898 this need was highlighted by Admiral George Dewey's experience at Manila Bay during the war with Spain, in which fighting could have been terminated sooner if prompt communication had been available.<sup>6</sup> When Guglielmo Marconi first brought his radio equipment to this country to report the International Yacht Races held off the New Jersey coast in September 1899, the Navy arranged for a group of officers to witness its performance. The favorable results obtained<sup>7</sup> led to a demonstration of Marconi's equipment installed on the USS NEW YORK (armored cruiser No. 2), the battleship USS MASSACHUSETTS (BB-2), and the torpedo boat USS PORTER (DD-59), and on shore at the Highland Light at Navesink, New Jersey. The Navy appointed a board of officers to observe tests of the equipment, which were conducted in late October and during November 1899.<sup>8</sup> The tests were successful and demonstrated the utility of ship-shore and ship-ship radio communication.<sup>9</sup> The USS MASSACHUSETTS was able to receive transmissions from the USS NEW YORK out to a distance of 46 miles. On 2 Nov. 1899, the first "official" naval message transmitted from a naval ship was sent from the USS NEW YORK to the Navesink, New Jersey, station to provide for refueling the ship at the Navy Yard.<sup>10</sup>

### BEGINNING OF THE NAVY'S RADIO COMMUNICATION SYSTEM

At the conclusion of the 1899 tests the Navy proceeded to negotiate with the Marconi Wireless Telegraph Company to obtain equipment in quantity for installation on its ships and at its shore stations. However, this company was

EARLY NAVY RADIO-ELECTRONICS

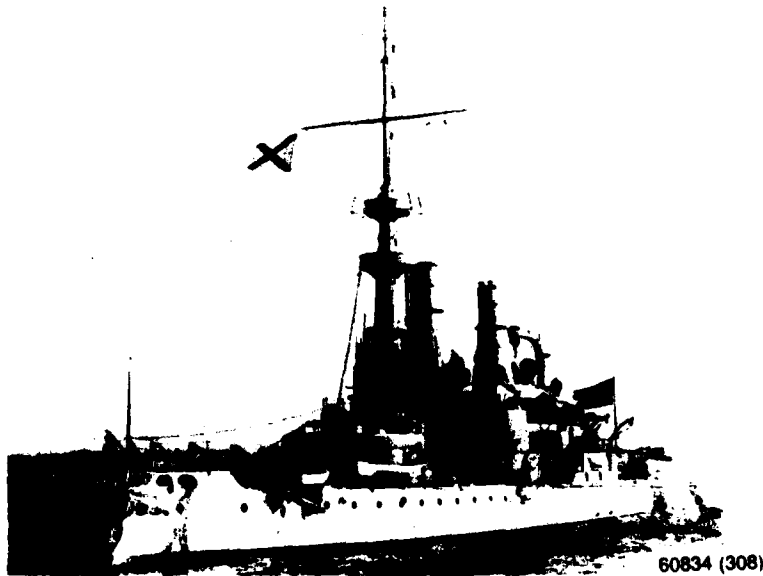

**USS NEW YORK AND USS MASSACHUSETTS**

In the Navy's first trials of ship-to-ship radio communication, Marconi's equipment was used successfully to send transmissions between the USS NEW YORK (top) and the USS MASSACHUSETTS (bottom) (1899).

## EARLY NAVY RADIO-ELECTRONICS

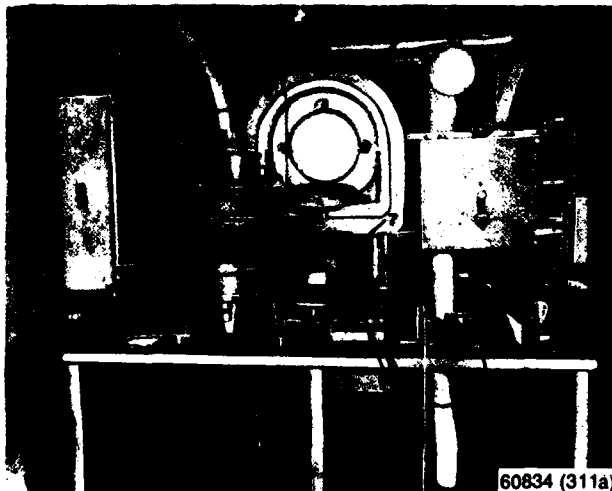

### COMPONENTS

- 1 - High voltage induction coil
- 2 - Mercury-jet rotary primary current interrupter
- 3 - "Variable inductance" - HF autotransformer, with seven Leyden jars inside - total capacitance - 0.014 uF
- 4 - Adjustable spark gap
- 5 - Transmitting key
- 6 - Receiver unit with an antenna switch, relays, coherer (glass tube 4 mm inner diameter filled with nickel-silver alloy oxidized filings - exhausted - electrodes 1 to 3 mm long)
- 7 - Receiver tuning coil
- 8 - Morse tape printer

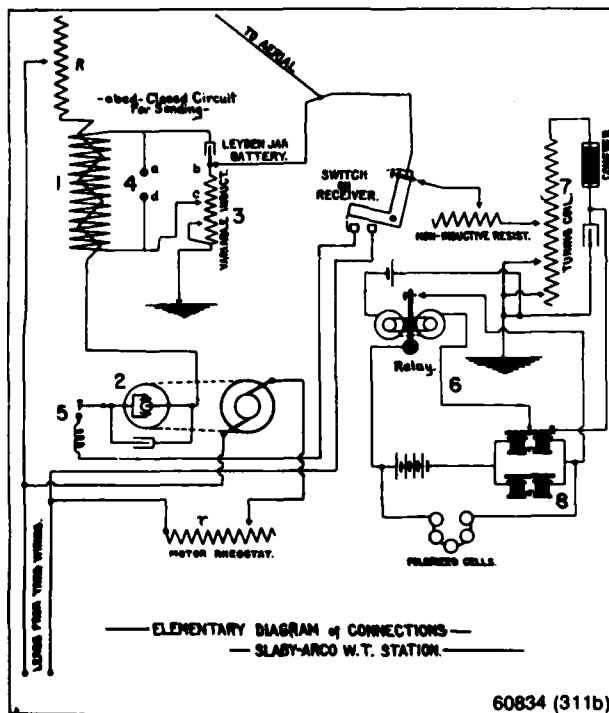

### NAVY'S FIRST RADIO EQUIPMENT

The U.S. Navy's first "wireless" (radio) equipment is shown here as installed on the USS PRAIRIE (1902). This equipment, called the Slaby-Arco system, was produced by the General Electric Company, Berlin. The "spark" transmitter had a power input of 1 kW and a range of 100 miles, and it operated at a wavelength of 200 to 400 meters (750 to 1500 kHz). The receiver used a coherer detector and a telegraph signal printer.

## EARLY NAVY RADIO-ELECTRONICS

reluctant to sell equipment outright and instead offered a royalty arrangement which was not acceptable, since the Navy believed it would lead to a monopoly in this country. Furthermore, there was concern over interference experienced in the tests when two stations were transmitting at the same time and whether adequate selectivity could be provided to avoid this interference. In view of these considerations the Navy decided to investigate all likely sources of equipment and to select the best for quantity procurement.<sup>11</sup>

Radio equipments produced by United States and European organizations were studied to determine their potentialities and availability. As a result, prior to the end of 1902, the Navy purchased equipments from two American and four European companies for comparison. Test stations were established at the Washington Navy Yard and the U.S. Naval Academy, Annapolis, Maryland. Two ships, the USS PRAIRIE and USS TOPEKA, were made available.<sup>12</sup> Testing conducted during the fall of 1902 and the spring of 1903 resulted in the selection of the Slaby-Arco System, produced by the General Electric Company, Berlin.<sup>13</sup> During the tests, communication was maintained between the USS PRAIRIE and the Annapolis station out to a distance of 90 miles, and between the two ships out to 62 miles.<sup>14</sup> Forty-seven Slaby-Arco equipments were purchased in 1903. These, together with other equipments obtained for the tests, provided a total of 58 equipments which were installed on ships and at shore stations. With the completion of these initial radio installations early in 1904, the U.S. Navy's radio-communication system was launched.<sup>15</sup>

### EARLY RADIO EQUIPMENT DEVELOPMENT

In 1903 the Bureau of Equipment of the Navy Department established a Radio Division, to have cognizance over the procurement of radio equipment. This division proceeded to provide additional equipment for expansion of the Navy's

system. Equipments of higher power and greater sensitivity were needed to cover greater distances and to operate without mutual interference and with greater reliability. The newly acquired Panama Canal Zone brought about the requirement for communication with the mainland and with ships and bases in the Caribbean Sea.<sup>16</sup> The diplomatic difficulties encountered in the use of submarine cables at Manila during the Spanish-American War emphasized the importance of radio to provide communication coverage of the Pacific. Sources of supply of radio equipment within the United States were sought to avoid procurement hazards inherent in relying on foreign sources, particularly in wartime. By 1906 the Navy had obtained from seven commercial concerns equipments for 57 ship and 39 shore stations, totaling 96, nearly half the total number of stations in the world.<sup>17</sup> In the tests of these equipments which followed, ranges up to 640 miles between ships were covered.<sup>18</sup> Shore stations were established at 23 key points on the east and west coasts of the United States. A station in Panama gave acceptable communication with one in Florida, providing the required contact with the Canal Zone. Stations in Cuba and Puerto Rico provided additional coverage of the Caribbean. Installations at Pearl Harbor, Hawaii, and Cavite, Philippine Islands, and on the islands of Guam, Marianas, and Tatoosh (Washington), provided the first coverage of the Pacific.<sup>19</sup>

### EARLY RADIO TRANSMITTERS

Heinrich Hertz, in demonstrating the basic principles of radio for the first time (1887-1888), used line-of-sight propagated frequencies (approximately 24 to 960 cm, or 31.3 to 1250 MHz).<sup>20</sup> The range possible in direct transmission over the surface of a curved earth was thus severely limited. Marconi's success was due to the use of the lower frequencies, which extended the transmission range through refraction by the ionosphere. A frequency of approximately 313 kHz (960 meters) was used in the first trans-Atlantic radio transmission emitted from the

10-kW station at Poldhu, England, and received by Marconi on 12 Dec. 1901, at Saint John's Newfoundland.<sup>21</sup> Another factor attending his success was his use of the "coherer," attributed to Edouard Branly (1890),<sup>22</sup> which provided a much more sensitive detector than the "spark gap" used by Hertz. Furthermore, with the "spark" technique then available, the use of the lower frequencies permitted the generation of much higher radio-frequency transmitter power.

### Spark Transmitters

Early radio installations utilized the spark transmitter, which derived its energy from the discharge of a capacitor (Leyden jars) across a fixed gap. The capacitor was charged by an induction coil operated on direct current through an interrupter (vibrator, mercury, or electrolytic) or by a transformer powered by alternating current. Antennas were made as large and high as ship masts and superstructure permitted. The wavelength of the transmitter was largely controlled by the characteristics of the antenna. Only rudimentary tuning was incorporated in to the circuits. Due to the spark method of generation, the radio-frequency energy was spread over a very wide frequency band, resulting in serious mutual interference between stations. By 1906, coupled circuits were extensively utilized, with primary and secondary circuits separately tuned; this innovation provided some improvement in limiting the spread of the energy in the radio-frequency spectrum.<sup>23</sup> Subsequently, the spectrum occupancy was further reduced through "quenching" of the spark. The fixed enclosed quench gap, the rotary quenched gap, and the "timed spark" were introduced to accomplish this reduction. The interference experienced was to a certain extent also due to the lack of proper assignment of frequency channels to stations and to inadequate disciplinary control of personnel.

The standard wavelength for spark transmissions from Navy ships and shore stations was first set at 320 meters (938 kHz). Later this assignment was changed to 600 to 1000 meters

(300 to 500 kHz) for ships.<sup>24</sup> Shore stations were assigned wavelengths up to 2700 meters (111 kHz). Navy procurement of transmitters for ships continued at power levels from 1/2 kW up to 10 kW. By 1906 power levels up to 35 kW had been attained for shore stations. Power capabilities continued to increase until the peak of the spark-type transmitter was reached in the 100-kW synchronous rotary spark-gap transmitter, which the Navy obtained from the National Electric Signalling Company and installed at the Arlington, Virginia station in 1912.<sup>25</sup> In comparative long-distance tests at that time, this spark transmitter (2500 meters, 120 kHz) proved inferior to a 35-kW "arc" transmitter developed by the Federal Telegraph Company and installed at the same station (1913). This event, together with the subsequent availability of the vacuum-tube transmitter, resulted in the decline in procurement of spark transmitters, which ceased altogether after World War I. The spark technique basically was not capable of improvement to meet the Navy's recognized requirements for interference-free, tactical and strategic communications. However, it had served well in providing a simple, readily available means of generating radio-frequency energy to facilitate the early utilization of a new and important communication capability.

### Arc Transmitters

The superior qualities of undamped, continuous waves, particularly with respect to mutual circuit interference, were recognized quite early, but difficulties in generation, frequency stability, control, and reception had to be overcome before they were acceptable. The "arc" method of generating continuous waves through the use of a resonant circuit containing a direct-current arc between carbon-copper electrodes in a magnetic field and a hydrogen atmosphere had been introduced by Valdemar Poulsen in 1903. **However, not until 1907 did the Navy obtain its first arc transmitters as part of its first radio-telephone equipment.** This equipment was intended to meet the Navy's



EARLY NAVY RADIO-ELECTRONICS



60834 (313a)

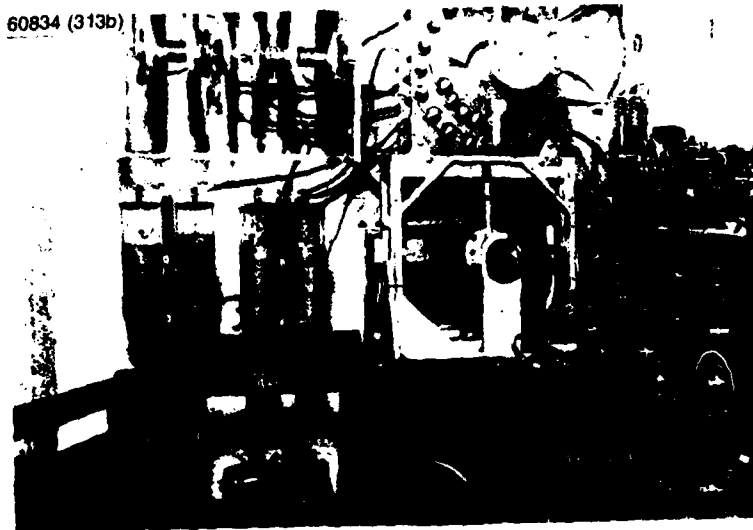

60834 (313b)

EARLY RADIO COMMUNICATION INSTALLATION BATTLESHIP  
USS NEW JERSEY (1914)

The "spark" transmitting and receiving equipment in the radio room of the USS NEW JERSEY is a typical pre-World War I installation. To the left is the spark transmitter; the spark gap is below the shelf, the Leyden jar capacitance is above, and the loading coils are at the top. To the immediate right is the oscillation transformer (on bench), and the "wave changer" is at the top. The crystal receiver is at the extreme right.

## EARLY NAVY RADIO-ELECTRONICS

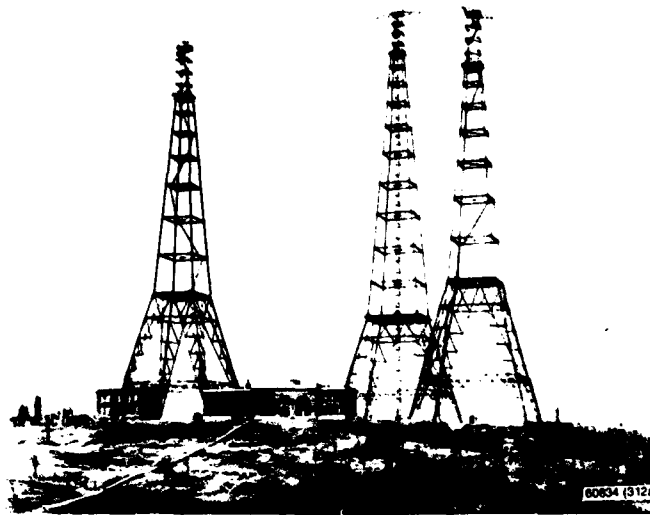

**THE NAVY'S PRIMARY RADIO STATION,  
WASHINGTON, D.C. (1913-1956)**

NAA was the Navy's "central" radio station for communication from the Navy Department to Fleet Commanders and provided coverage of the Atlantic and continental U.S. The installation included the highest radio towers in the U.S., the "Three Sisters" (one 600 ft, two 400 ft), located at Arlington, Virginia, and the most powerful transmitter in the U.S. (100 kW, 113 kHz). This transmitter (lower picture) comprised a generator and rotary spark gap (lower left), compressed-air capacitance (in tanks, lower right), and oscillation transformer (top).

## EARLY NAVY RADIO-ELECTRONICS

fleet tactical communication requirements. Two equipments, constructed by the DeForest Company, and installed on the battleships USS CONNECTICUT and USS VIRGINIA, gave fair results. Subsequently, 26 equipments were obtained and installed on the ships participating in the famed Great White Fleet in its around-the-world cruise begun in late 1907.<sup>26</sup> Hasty construction due to the short time allowed for delivery and lack of follow-up and of adequately trained operating personnel caused poor performance, resulting in abandonment of the equipment. As a result the Navy was without radiotelephone equipment until about 1917. This experience was an important factor in retarding the development of intrafleet radio communication.

The arc transmitter, due to its output of undamped waves, produced much less interference than the spark transmitter. This factor became of considerable operational importance. As previously mentioned, an arc transmitter of 30-kW rating had outperformed a 100-kW spark transmitter. This accomplishment occurred

in 1913 in overseas (Atlantic) tests carried out to a distance of 2100 miles in daytime, using the same large antenna at the Arlington, Virginia station for both transmitters. Based on the results of these tests, the Navy ordered ten 30-kW arc transmitters for shipboard use and one of 100-kW power for installation at the Darien, Canal Zone station. Subsequently the Navy, in developing its high-power chain of radio stations, installed arc transmitters at Chollas Heights, California (200 kW), Pearl Harbor, Hawaii (350 kW), Cavite, Philippine Islands (350 kW), and Annapolis, Maryland (500 kW), the last being completed in 1918.<sup>27</sup> These were the highest powered arc transmitters in the United States. They were replaced by the model TBJ 500-kW vacuum-tube transmitters in June 1934. A considerable number of arc transmitters of 2 to 30 kW power levels were installed, principally on the larger Navy ships. However, reception aboard the same ship during arc transmissions, even with large frequency separation, was impractical due to interference from arc "mush" and the proximity of the equipments.

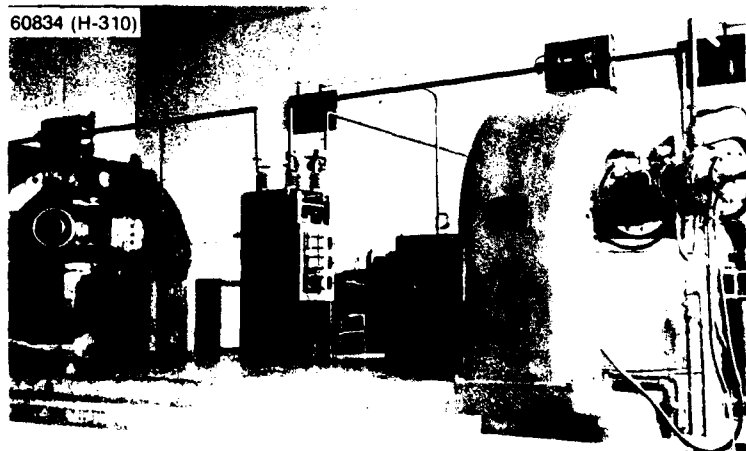

**THE HIGHEST POWER ARC GENERATORS  
IN THE UNITED STATES**

Two 500-kW arcs (17.50 kHz) were installed in the U.S. Naval Radio Station, Annapolis, Maryland (NSS) (1918) for coverage of the Atlantic Ocean, England, and Europe. The arcs were replaced by the Model TBJ 500-kW vacuum-tube transmitter (1934).

## EARLY NAVY RADIO-ELECTRONICS

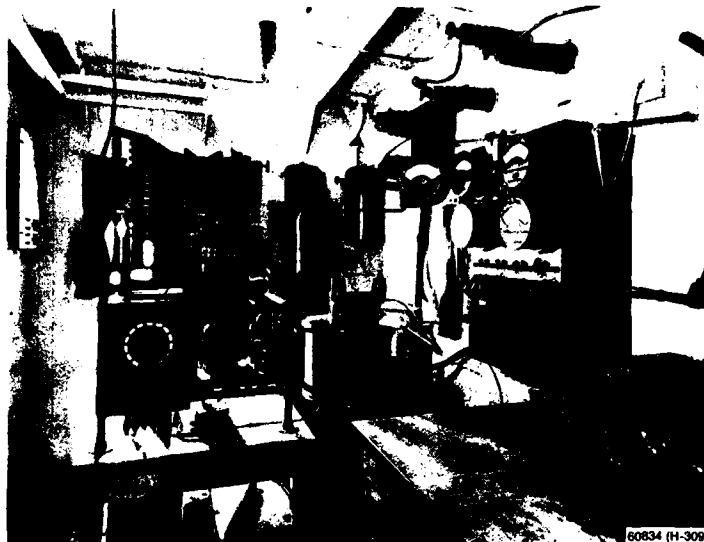

**TYPICAL WORLD WAR I ARC TRANSMITTING AND RECEIVING SHIPBOARD INSTALLATION**

The 5-kW arc transmitter is shown at the center, the loading coil at the upper left, and the receiver at the lower right. These equipments provided ranges up to 4000 miles operating on wavelengths between 1200 and 3000 meters (250 to 100 kHz).

This interference could be avoided in shore installations, which permitted adequate physical separation of reception and transmission facilities. Arcs gave their best performance at the longer wavelengths and were assigned channels principally in the range 2000 to 4000 meters (75 to 150 kHz) for ship installations and 4000 to 17,000 meters (17.5 to 75 kHz) for shore installations. The arc transmitter reached its peak at the 1000-kW level, as developed by the Federal Telegraph Company under Navy sponsorship for the Lafayette Radio Station near Bordeaux, France. This station was turned over to France in 1920.<sup>28</sup>

By this time, the vacuum-tube transmitter proved capable of greater effectiveness in spectrum occupancy than the arc, since it could be far more precisely controlled in frequency and was free of the "mush" attending the generation of the arc's radio-frequency energy, which caused considerable interference. Furthermore, vacuum-

tube circuits were capable of amplification and modulation with great flexibility and precision, a capability not possessed by the arc. By 1922, the problem of producing a vacuum-tight seal between copper and glass had been solved, making the use of the water-cooled metal anode tube feasible.<sup>29,30</sup> High radio-frequency power to match that of the arc could then be produced; the arc was thereafter displaced by the vacuum-tube transmitter. Its demise was accelerated during the 1920's through the advent of extensive national interest in radio broadcasting and the reaction of the public to the annoyance caused by the "arc mush" interference.

### High-Frequency (HF) Alternator Transmitters

Beginning in 1903, the HF alternator, in the form of a rotating machine, had been looked

## EARLY NAVY RADIO-ELECTRONICS

upon as an attractive source of HF energy. It was free of the mush, characteristic of the arc, but presented difficulties in design with respect to high power, frequency stability, modulation, and operation at a sufficiently high radio frequency, which had to be overcome. In early 1917, the General Electric Company completed a 50-kW HF alternator based on a design by Dr. E. F. W. Alexanderson. Two such alternators were installed at the American Marconi Company station at New Brunswick, New Jersey, which was taken over by the Navy at the beginning of World War I. These alternators were found to have performance superior to that of a 100-kW arc due to the relatively pure sine wave of the generated power, high efficiency, and ease of modulation. Subsequently, the General Electric Company developed a 200-kW, HF alternator (22.05 kHz) which was installed at the New Brunswick station in January 1918 for Navy operation.<sup>31</sup> This transmitter carried the bulk of the radio traffic between this country and Europe for the remainder of World War I and for a period thereafter. On 1 Mar. 1920, President Wilson approved the return of the radio stations taken over by the Navy during World War I to their owners, thus causing the transfer of the New Brunswick station and the alternators to the Radio Corporation of America, successor of the Marconi Company. The superiority of the alternators and their value to radio communication was well recognized by the Navy. However, the progress made in the development of vacuum tubes with water-cooled copper anodes which could provide high power with mechanical simplicity, ease in changing frequency over a wide range, capability of operation at very high frequencies, and far better control brought about the Navy's abandonment of the HF alternator.

### EARLY RADIO RECEIVERS

Early radio receivers used the "coherer" detector, comprising a tube containing metal filings which became conductive through coalescence when subjected to a radio-frequency field. The coherer operated a tape recorder and a "tapper"

which decohered the filings by striking the tube, thus reactivating the circuit. In some installations the coherer was connected directly to the antenna and ground, and in others it was coupled through a transformer. As was the case with the early transmitter, the selectivity of the early receiver depended almost entirely upon the characteristics of the antenna to avoid interfering signals.

As a result of the early radio tests, the Navy was convinced that the solution of the problem of selectivity was vital to success in its utilization of radio circuits for communication between its various ships and shore stations, many of which must operate simultaneously. Immediate attention was focused on this problem. By 1902, the use of tuned coupled circuits to improve selectivity had begun. Inductances, adjustable with taps and continuously variable by means of "sliders," and continuously variable capacitors had been developed. By 1906 circuits of improved selectivity were in general use. However, the extent of improvement was limited by the efficiency of the circuit components available at that time and by the limitations of Navy procurement procedures in the selection and control of contractors. By 1906 the superior properties of the electrolytic, magnetic, and crystal (e.g., silicon, carborundum, galena) detectors had become recognized, and these displaced the coherer. The telephone receiver headphones accompanied these new detectors to provide a combination for aural reception having considerably greater sensitivity than the coherer.

The Navy's adoption of arc transmitters for operational use required a new means of detection suitable for reception of the continuous waves generated by the arc. This need brought about the development of the "tikker" circuit, employing a rotating metallic wheel with a brush in light contact. This device, due to variability of the contact, produced groups of audible sounds in the headphones corresponding to the transmissions by the charge and discharge of a capacitor. The tikker was soon superseded by the "heterodyne" method of reception, which,

## EARLY NAVY RADIO-ELECTRONICS



**EARLY RADIO RECEIVER (MODEL IP-76)**

This receiver (circa 1910) comprised a primary coil for the antenna circuit, into which a secondary coil for the local circuit could slide for "coupling" adjustment. The "tuning" was accomplished with taps on the coils. The receiver used a crystal detector. An experimental "audion" tube detector is shown on the table at the right, with another somewhat to the left. The vertical cylindrical containers with knobs on top are early variable condensers. Several pairs of headphones are also seen. A considerable number of the IP-76 receivers were procured and distributed to the Fleet and to land stations.

although devised by Reginald Fessenden in 1902, was not found practical until the oscillating vacuum-tube circuit became available in 1913.

### **EARLY VACUUM TUBE RADIO EQUIPMENT**

Although Lee DeForest invented the three-element vacuum tube ("audion") in 1906, it was not until 1912 that the multistage audio amplifier, and in 1913 the oscillator using these tubes, became available. During 1913 the Navy purchased a number of DeForest audio amplifiers equipped with audion tubes, assigning one to each ship and shore station. The amplifiers,

although quite limited in gain, nonuniform in performance, and unreliable, were used to some extent until early in World War I. The Navy also obtained a considerable number of DeForest vacuum-tube oscillators, termed "ultraaudion," about this time, but they were of such poor quality the Navy had to redesign them. However, their use made feasible the Fessenden heterodyne method of reception which, with its clear "beat" note, was for continuous-wave reception far superior to the tikker method.

The Navy, in its efforts to utilize vacuum tubes, experienced great difficulty in obtaining tubes of adequate performance, uniform quality, long life, and of low enough cost to make their

## EARLY NAVY RADIO-ELECTRONICS

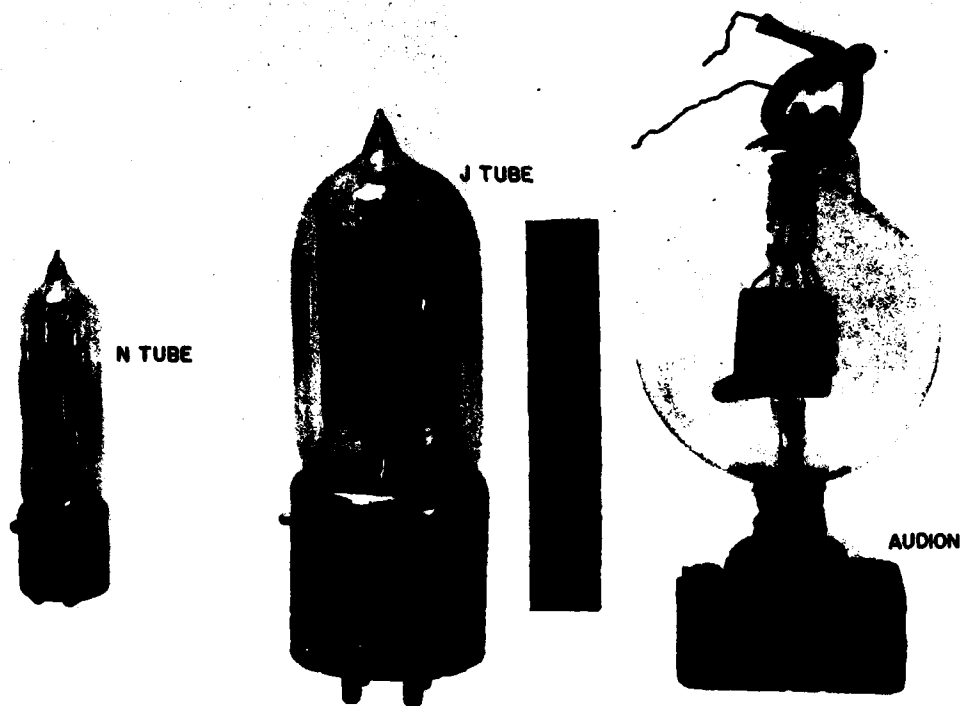

60834 (523)

### ELECTRON RECEIVER TUBES USED IN EARLY NAVY RADIO EQUIPMENT

The audion (1912) gave very little amplification and was soon replaced by the J tube (1913), which gave excellent amplification at audio frequencies, was reliable, and had a good life span. The N tube (1919) was the first attempt at miniaturization and had reasonably good life. It was used in the first detection of ships by means of radio waves (1922).

general use economically feasible. Although attempts were made by various organizations to improve the vacuum tubes, considerable time elapsed before acceptable tubes became available. By 1913 the American Telephone and Telegraph Company (AT&T Co.) had developed a receiving vacuum tube employing an oxide-coated cathode, which had substantial gain and reasonably long life. This tube, which became known as the J tube (later CW933), was subsequently incorporated in many Navy radio receivers.<sup>32a</sup> In 1920 a small counterpart of the J tube, known as the N tube, was developed for the Navy (AT&T Company) as a first attempt at miniaturization.

However, this tube found only limited use. These tubes were followed by a thoriated-filament tube (SE1444) which had superior performance in receiver amplifiers operating at radio frequencies. It was used to a considerable extent in communication and navigation equipment, particularly that for aircraft. These tubes were all triodes, and truly superior amplification performance in receiver tubes did not become available until the tetrode tube, with its shielded grid, appeared later in the 1920's.

Substantial increase in the power output of vacuum tubes was not attained until 1915, when the AT&T Company developed the first vacuum

tube producing as much as 5 watts output. This tube was incorporated by the AT&T Company into a transmitter comprising a master oscillator and two-stage power amplifier which provided a historic demonstration of the potentialities of radio telephony during the period from June through October 1915. The final amplifier used 550 tubes in parallel to obtain high power (2.5 kW). The transmitter was installed at the Navy's Arlington, Virginia, station and was connected to its 600-ft-high antenna. The voice and music transmissions (120 kHz) were heard by Navy stations at Darien, Canal Zone, Mare Island, California, and Honolulu, Hawaii, and by the Eiffel Tower station in France.<sup>33</sup>

The equipment was used again during the war mobilization period in May 1916 for two-way conversation between Navy Secretary Daniels in Washington and USS NEW HAMPSHIRE off the Virginia Capes, which used a lower-powered radiophone equipment.

The transmitter tubes used in the AT&T Company Arlington equipment proved to have very short life and thus were not satisfactory for normal Navy operations. Under Navy sponsorship, the AT&T Company developed a 5-watt transmitting tube, known as the E tube (later CW931), which also employed an oxide-coated cathode.<sup>34a</sup> This tube had acceptable service performance and was incorporated together with the J receiving tube by the AT&T Company into equipment for the Navy (1916).<sup>35a</sup> During World War I, over 1000 sets operating at 500 to 1500 kHz (CW936), using these tubes and designed for shipboard operation, were installed on submarine chasers, destroyers, and battleships. These equipments were of inestimable value in the antisubmarine campaign. The British also made use of this equipment in their operations. This equipment provided a considerable improvement over the spark and arc equipments in reduced interference between stations and facility of operation. **This vacuum-tube equipment made effective voice communication for Fleet operations available for the first time.**<sup>36</sup> A similar equipment (CW1058), designed for aircraft operation, found service use, although

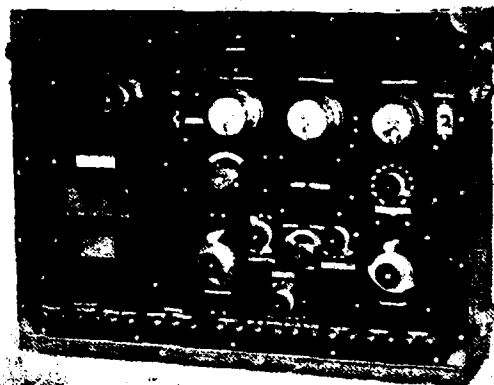

60834 (524)

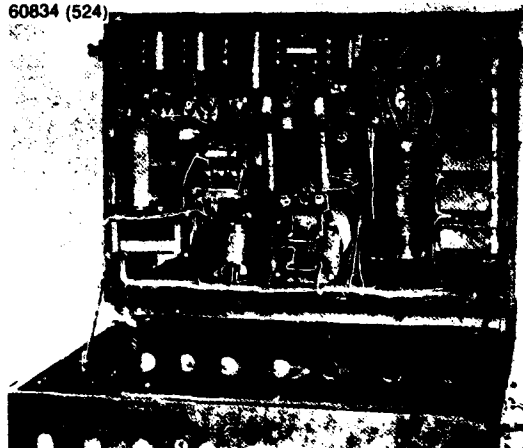

#### FIRST EFFECTIVE VOICE COMMUNICATION EQUIPMENT

This equipment, the CW936, was intended for Fleet operations and was used extensively during World War I.

reception performance on aircraft was very poor due to the existing high interference levels.<sup>34b</sup>

Toward the end of World War I the General Electric Company began the development of a series of highly evacuated tungsten filament vacuum tubes with power levels of 5 watts (type T, later CG1162), 50 watts (type U, later CG1144), and 250 watts (type P, later CG916). These tubes, although not having the emission



## EARLY NAVY RADIO-ELECTRONICS

efficiency of the oxide-coated cathode, proved to have acceptable life, uniformity, and reliability and were "standardized" for Navy service.<sup>37,38</sup>

By early 1921 the General Electric Company had produced a 1-kW tube (type CG2172), and by late 1921 a 5-kW (nominal) tube (CG1353). At this time both the General Electric Company and the AT&T Company had developed tubes employing water-cooled metal anodes, and this type of tube was used thereafter to provide the higher powers in Navy equipment. The lower power tubes were further improved through replacing the pure tungsten filaments with thoriated filaments, thus considerably increasing the electron emission and power-level performance of the tubes.

Tubes of the General Electric Company series were first used in several aircraft radio transmitters produced for the Navy and made by the General Electric Company at the end of World War I.<sup>32b,34c</sup> Subsequently, they were incorporated into a series of transmitters of several power levels for shipboard and shore-station operation, covering frequency bands in the medium and lower frequency parts of the radio spectrum.<sup>35b</sup>

### INCEPTION OF NAVAL IN-HOUSE RADIO RESEARCH

Early Navy radio equipment was developed by commercial companies under Navy sponsorship, since the Navy did not possess a suitable in-house capability. Although Naval military personnel made such modifications of equipment as were possible with available facilities, their attention was directed principally to the drafting of specifications, the issuance of contracts, supervision of tests, and acceptance of equipment under procurement. The Navy had to place considerable reliance upon the statements of manufacturers as to the performance which could be expected from equipment. Up to 1908, assessment of the performance of radio equipment was almost entirely on a qualitative basis. Quantitative measurements, even by the commercial concerns developing the equipment, were limited. Some measurements of wavelength,

capacity, and inductance had been made, but no quantitative measurements had been attempted for aspects such as energy losses in components. The determination of the efficiency of transmitting and receiving equipment could not properly be made. There was no "well-defined conception of the laws relating the energy sent out from the sending antenna and that received at the receiving antenna, beyond a distance of a few miles."<sup>39</sup> As a result, specifications and tests were directed primarily to the communication distance covered and to the capability of equipment to continue operating, particularly in a shipboard environment.

As previously mentioned, by 1908 the Navy had experienced failure to obtain satisfactory performance from a considerable number of early radio-telephone equipments it had procured. It was realized that this failure was due largely to the lack of an in-house organization with adequate technical competence which could concentrate its efforts on radio problems. This situation led to the establishment of the U.S. Naval Radio Telegraphic Laboratory in the autumn of 1908, under the Navy's Bureau of Equipment. Working space and facilities were made available for it at the National Bureau of Standards, although a considerable portion of the work for it was done at Navy radio stations ashore and on shipboard. The laboratory was placed under the direction of Dr. L. W. Austin, a noted physicist and an authority on radio, who continued as its head until the laboratory was merged with others to form the Radio Division of the U.S. Naval Research Laboratory (NRL) in 1923. Its staff reached a peak of approximately ten persons.

The Naval Radio Telegraphic Laboratory carried on an extended effort to obtain data on laws which govern the radiation of radio waves over long paths. Observations were made on transmissions from various Navy ship and shore stations on low and medium frequencies. As a result, what is considered to be the first formula for radio-wave propagation over ionospheric paths, supported by experimental data, was developed.<sup>40</sup> This became known as

## EARLY NAVY RADIO-ELECTRONICS



60834 (314)

### U.S. NAVAL RADIO TELEGRAPHIC LABORATORY (1908-1923)

NRTL was the Navy's first radio laboratory. A Type IP-76 radio receiver (far right) is being investigated using audion tube equipment (on table). This receiver was widely used until early in World War I.

the Austin-Cohen formula. Original work was also done on the measurement of antenna radiation resistance, the losses in inductances and capacitances, the performance of various crystal detectors, the analysis of three-element vacuum-tube circuits, and the characteristics of arc oscillation generators. The laboratory also assisted the Navy in the preparation of specifications and the testing of radio equipment.

### AIRCRAFT RADIO COMMUNICATION

The Navy's interest in the use of aircraft for scouting and gun shot spotting brought about the first radio transmissions from Naval air-

craft in flight to the USS STRINGHAM, located three miles away in the vicinity of the U.S. Naval Academy, Annapolis, Maryland, on 26 July 1912. A quenched-spark transmitter powered by a 500-cycle generator driven by the aircraft engine and a fixed antenna suspended from the aircraft wing were used. Reception on the aircraft (by crystal detector) was limited to very strong signals from nearby stations, due to the ignition and other noises of the plane.<sup>34d</sup>

Following this early demonstration, the weight limitation on available aircraft was a deterrent to further action until 1916, when equipments were purchased by the Navy from four commercial companies. The need for adequately

## EARLY NAVY RADIO-ELECTRONICS



60834 (315)

### FIRST NAVAL AIRCRAFT USED FOR IN-FLIGHT RADIO TRANSMISSIONS

The first radio transmissions made from a Naval aircraft were made from this Navy Wright B-1 aircraft (1912). This aircraft was one of the Navy's first two aircraft. It was obtained from the Wright Company at the same time the other was obtained from the Curtiss Company.

testing these equipments brought about the establishment of the Naval Aircraft Radio Laboratory at the Naval Air Station, Pensacola, Florida, in the summer of 1916.<sup>34d</sup> The only equipment that showed promise at that time (type CE615, by E. J. Simon) comprised a 500-watt spark transmitter using a trailing-wire antenna of variable length. The receiver used a vacuum tube in a regenerative circuit, but it had to contend with aircraft electrical interference, which limited its reception range. The equipment weighed 100 pounds and transmitted signals over a distance of 150 miles. Using one of these equipments, the first "official" message was transmitted from a seaplane in flight over a distance of 20 n. mi. to the cruiser USS NORTH CAROLINA on 15 March 1916.<sup>34e</sup>

On 1 January 1918, the Naval Aircraft Radio Laboratory was transferred to the Naval Air Station, Hampton Roads, Virginia, where the work of testing aircraft radio equipment was continued.<sup>34f</sup>

Late in 1917, after the United States entered the war, the need for aircraft radio equipment for antisubmarine patrol, convoy, scouting, and shot spotting became evident. Contracts were placed with the International Radio Telegraph Company, Cutting and Washington, National Electric Supply Company, Western Electric Company, and the Marconi Company to provide both spark and vacuum-tube transmitters. These equipments were tested by the Aircraft Radio Laboratory, but their use during World War I was limited.<sup>34g</sup> The laboratory also devised a helmet with headphones which could be worn with comfort.<sup>34h</sup> It was at this laboratory that the first measurements of aircraft antenna characteristics were made.<sup>34h</sup>

Early work was done by the laboratory on radio direction finders for aircraft. A rotating-loop type equipment for mounting in the tail area was developed. However, bearing errors were considerable due to the high radio and acoustic noise levels on aircraft and due to deviations

introduced by close proximity to metallic parts of the aircraft structure. The "minimum" method of bearing determination could not be used. Instead, a "maximum" method was used employing two loops disposed at right angles; a reversing switch through which the voltage of one loop could be added to or subtracted from the other permitted determination of the equisignal point and the bearing, as the loops were rotated.<sup>32d,34h</sup>

### THE BEGINNING OF THE NAVY'S IN-HOUSE DEVELOPMENT OF RADIO EQUIPMENT

The performance of radio equipment the Navy had been able to obtain for a considerable period prior to 1915 lagged behind that possible with the existing state of the art. For instance, low-loss inductances had been designed, but commercial standards did not permit their use. The Navy had procured a radio receiver (IP-76) from the Wireless Specialty Company in which tuning was accomplished by the cumbersome and inadequate method of taps on inductances selected with switches. This receiver, obtained in large numbers even though it was known to have poor selectivity, was installed on practically all Navy ships and shore stations and remained in service until early in World War I. The patent situation was also a deterrent factor in obtaining updated equipment, since commercial concerns were required by the Navy to assume responsibility for any patent infringement involved in equipment they furnished. Furthermore, the equipment produced under the standards used by commercial manufacturers lacked the ruggedness necessary to contend with Navy shipboard environment. The many serious deficiencies were forcefully brought to attention during the Mexican incident in 1914, when President Wilson ordered the Navy to seize the city of Veracruz. The simultaneous transmissions from the many ships, both United States and foreign, concentrated at Veracruz, caused severe interference with communications between the Fleet and Washington.

To meet the problem, the Bureau of Steam Engineering\* decided to establish an in-house capability to develop its own radio equipment, to draft rigid specifications, and to manufacture the equipment commercial companies would not agree to make. In June 1915, the Bureau designated six of its Navy Yards to assume responsibility, each for certain radio components.<sup>41</sup> Civilian expert radio aides were obtained to take charge of the work in the several Navy Yards. Of this effort, the greatest impact on the Navy's system was brought about by the work of the Washington Navy Yard, assigned the development of radio receivers and wave-meters. This activity became known as the Radio Test Shop (RTS). Its establishment at this time coincided with the beginning of the exploitation of the vacuum tube, permitting the RTS to make important original contributions in this field.

The RTS, in 1915, proceeded to develop a series of long-wave, medium-wave, and short-wave radio receivers, which were manufactured in large quantities and used practically exclusively throughout the Navy during World War I. Some types were used for many years thereafter. The first of these, the SE95 (30 to 300 kHz) and the SE143 (100 to 1200 kHz), had preselector and vacuum-tube circuits arranged in separate cabinets, with provision made for the use of crystal detectors if necessary. These were the first receivers to have dials directly calibrated in wavelength, and the first with low-loss inductances which used multiple insulated conductors to reduce eddy-current loss. These receivers were followed shortly by the SE1420 (43 to 1260 kHz), which provided for the first time a vacuum-tube feedback circuit for regenerative gain on damped signals and oscillator operation for heterodyne reception on continuous waves.<sup>42a</sup>

\*The Bureau of Equipment was dissolved, and the responsibility for radio was assigned to the Bureau of Steam Engineering on 30 June 1910.

## EARLY NAVY RADIO-ELECTRONICS

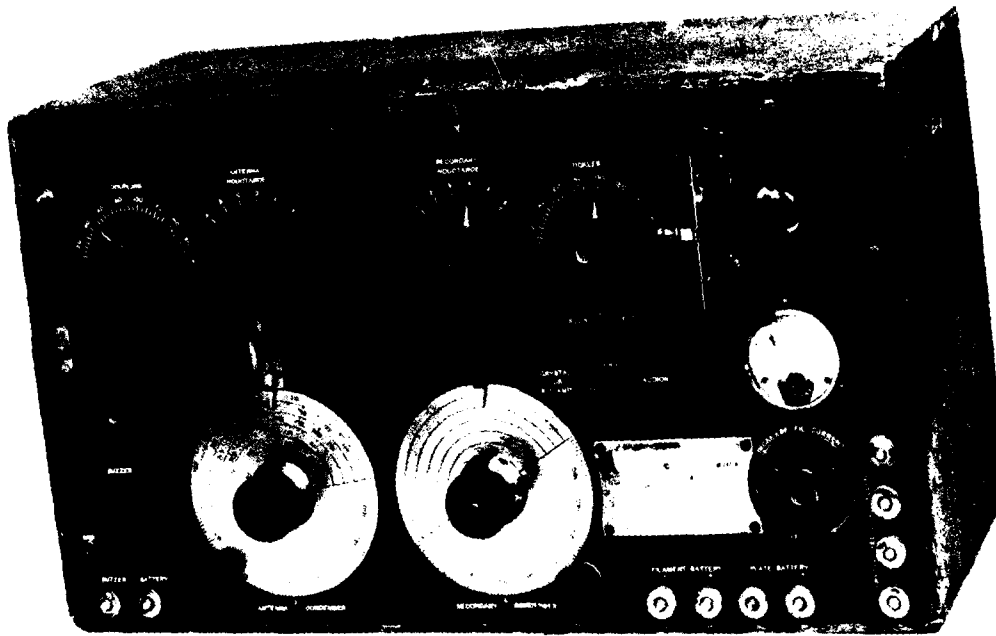

60834 (324)

THE NAVY'S FIRST RADIO RECEIVER  
WITH INTEGRAL ELECTRON TUBE HETERODYNE CIRCUIT -  
THE TYPE SE 1420

The RTS developed the first standard vacuum-tube audio amplifier unit (SE1000), which contained two audio amplifier stages, to go with the preselector circuits (1913). These were also made in large numbers.<sup>426</sup>

In 1918 the RTS developed the SE950 receiver (120 to 1000 kHz) for Naval aircraft, the first Navy standard receiver with amplifying circuits integral with the preselector circuits. This aircraft receiver included for the first time means for the determination of the direction of received signals, a system which has previously been described.<sup>32e</sup>

The RTS developed the first "standard" vacuum-tube radio-frequency amplifiers (1919).

These amplifiers comprised three radio-frequency stages, which, with a detector and two audio stages, were included in a single compact unit. A large number of these amplifiers were made for various frequency ranges, e.g., SE1615 (30 to 100 kHz), SE 1605B (130 to 500 kHz, designed for aircraft communication and direction finder operation), and were used throughout the Navy.<sup>32f</sup>

After World War I the activities of the Navy Yard groups, including the RTS, were curtailed. The work of the RTS was then limited principally to assisting in the design of tube transmitters, the provision of receiving systems, and the development of uni-wave keyers for arcs. The group at the Philadelphia Yard was able thereafter to

## EARLY NAVY RADIO-ELECTRONICS

effect certain improvements in direction-finder apparatus. In 1923 the radio research and development work of the Navy Yard groups, together with associated personnel, was transferred to NRL to become part of the newly formed Radio Division.

### U.S. NAVAL RADIO LABORATORY, GREAT LAKES, ILLINOIS

Early in 1917, at the beginning of U.S. entry into World War I, Dr. A. Hoyt Taylor left his position as head of the Physics Department of the University of North Dakota and became District Communication Superintendent for the Great Lakes Naval District with headquarters at the U.S. Naval Training Station, Great Lakes, Illinois. Dr. Taylor was responsible for all war-time radio and wire communications activities in an area encompassing the Great Lakes, west to the Mississippi River, and south to Kentucky. In addition, his previous interest in radio research led to his establishment of a radio laboratory and assembly of a suitable staff at that station during the summer of 1917. The Navy at that time was greatly concerned over the possibility of the transatlantic cables being cut by German submarines. **To contend with this threat, early work was undertaken to determine the potentialities of underground and underwater antennas to improve reception from overseas very-low-frequency (VLF) stations (20 to 75 kHz). The results obtained by the Laboratory were sufficiently favorable that these antennas were considered for use in proposed transatlantic communication installations.** Experiments on these types of antennas, both transmitting and receiving, were also conducted at medium frequency (500 kHz) to determine their operational performance and optimum length with respect to frequency. The feasibility of transmission from an antenna buried in the ground was demonstrated by transmissions over a distance of 30 miles to Chicago, Illinois, using a 250-watt vacuum-tube DeForest transmitter.<sup>43</sup>

In 1917 the Navy had to use shore-station sites separated by a considerable distance for

the functions of radio transmission and reception to reduce interference and to allow simultaneous operation. Naval Radio Station NAJ, located on the Training Station site, served as a relay point for messages sent between Washington, D.C. and the west coast, since direct transmission was not satisfactory. Simultaneous transmission and reception at the site was not feasible due to the high-power arc transmitter interference. **Circuits were devised by the laboratory using long wire and loop antennas which "balanced out" the transmitter interference, including arc mush, thus for the first time permitting simultaneous transmission and reception on a single site.** A doubling of communication traffic capacity resulted (August 1917).

Early in 1918 the activities of the Great Lakes Radio Laboratory were transferred to the Naval Radio Station at Belmar, New Jersey.

### NAVY TRANSATLANTIC COMMUNICATION SYSTEM AND RESEARCH ACTIVITIES (1917-1918)

In October 1917, Dr. Taylor was directed by the Navy Department to assume responsibility for the establishment and operation of a transatlantic radio communication system with headquarters at Belmar, New Jersey. This system comprised facilities taken over by the Navy from commercial interests, principally the Marconi Wireless Company, under powers incident to war. The facilities included transmitting stations located at New Brunswick, New Jersey (call letters WII, later NFF, 200 kW, 22.05 kHz), Tuckerton, New Jersey (call letters WGG, later NWW, 100 kW, 18.85kHz), Sayville, Long Island, (call letters SLI, later NDD, 100 kW), and receiving stations at Belmar, New Jersey, Chatham, Massachusetts, and Bar Harbor, Maine. This system represented the most comprehensive assembly and centralized control of radio equipment accomplished up to that time. Through its use the principal functions of radio communication during World War I, i.e., communication with European stations and broadcasts

## EARLY NAVY RADIO-ELECTRONICS

to ships in the Atlantic, were carried out. All World War I transatlantic radio communications were handled by this system, with Belmar as a relay center for messages to and from Washington via telegraph circuits. Communication was maintained with high-power foreign radio stations at Carnarvon, England (call letters MUU, 300 kW, 21.13 kHz), Lyons, France (call letters YN, 150 kW, 22.2 kHz), Nantes, France (call letters UA, 33.35 kHz), Stavanger, Norway (call letters LCM, 300 kW, 25.00 kHz), and Rome, Italy (call letters IDO, 350 kW, 28.57 kHz).<sup>44</sup> The German version of the war events, transmitted from the high-power station at Nauen, Germany (call letters POZ, 600 kW, 23.80 kHz) was monitored. The messages leading to the armistice were interchanged directly with the Nauen station.

Early radio countermeasures intercept was accomplished at the Belmar station through the observation of certain transmissions from the Nauen station on an unusual frequency, considered to be used for communication to the German submarines in the Atlantic.

In addition to carrying out these responsibilities, Dr. Taylor continued his interest in research, through reassembling most of the Great Lakes research group. Work on long underwater and underground wire antennas was continued to seek improved transatlantic reception. Means of "balancing" loop with wire antennas were devised which provided discriminatory antenna patterns; these patterns created improved signal-to-noise ratios on European stations with respect to static from the tropics. This technique was then used extensively for transatlantic reception operations. Considerable field intensity and signal-to-noise-ratio data were obtained on the VLF stations over the long oversea paths. The results of studies of this data were utilized in determining the design of subsequent Navy VLF communication installations.<sup>45</sup>

Early work on radio-frequency amplification was also done here. The techniques developed were incorporated in the transatlantic receiving circuits, providing improved reception.

In July 1918, Dr. Taylor was directed by the Radio Division of the Bureau of Steam Engineering to proceed to the U.S. Naval Air Station Hampton Roads, Virginia, to assess the status of aircraft radio development with view to determining action necessary to advance progress of the work.

### **U.S. NAVAL AIRCRAFT RADIO LABORATORY, WASHINGTON (ANACOSTIA), D.C.**

The Bureau of Steam Engineering decided that aircraft radio could be more expeditiously advanced if research activities were located in Washington, D.C. As a result, in October 1918, Dr. Taylor was directed by the Bureau to establish the U.S. Naval Aircraft Radio Laboratory (NARL) at the U.S. Naval Air Station, Washington (Anacostia), D.C.<sup>46</sup> The Laboratory staff subsequently assembled included members of the research groups previously associated with Dr. Taylor and members of the staff of the Naval Aircraft Radio Laboratory, Hampton Roads, Virginia, which upon their transfer was disestablished. The staff of the Washington group totaled about 15. Due to lack of space at the Naval Air Station, part of the staff was located for a while at the National Bureau of Standards. That part of the staff located at the air station utilized a building provided previously for the testing of aircraft receivers. Although its title designated the laboratory as "aircraft" oriented, the research work extended to many other aspects of the radio field, and soon NARL found itself acting as principal advisor to the Radio Division of the Bureau of Steam Engineering on all phases of radio.

### **Radio Broadcasting**

In 1919, NARL began the exploration of those frequencies immediately above the medium-frequency band to determine their capability to provide additional channels for Navy communications. Transmitting and receiving equipments operable at the higher frequencies were

## EARLY NAVY RADIO-ELECTRONICS

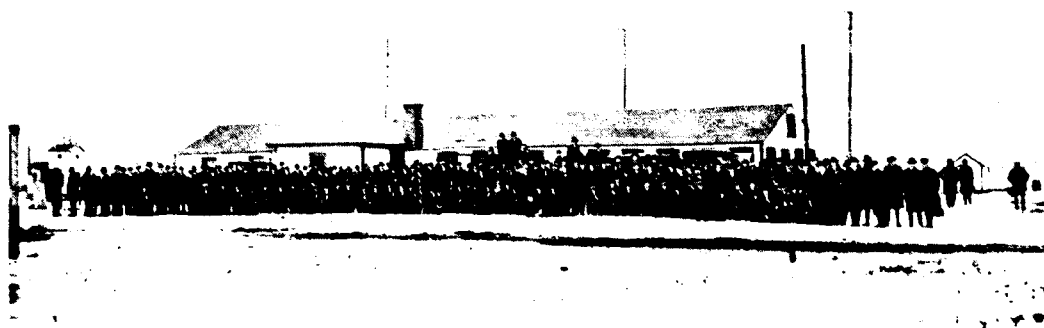

60834 (5/5)

### THE NAVAL AIRCRAFT RADIO LABORATORY (1918-1923)

The Naval Aircraft Radio Laboratory was located at the Naval Air Station, Washington (Anacostia), D.C. pending the construction of facilities at NRL. As shown, the Laboratory was host to members of the American Radio Relay League (amateurs) during their convention in Washington, February 1922. It was the excellent cooperation of the radio amateurs acting as observers throughout the nation that made it possible for the Laboratory to determine the skip distance versus frequency characteristics of high-frequency wave propagation. It was at this Laboratory that the first detection of ships with reflected radio waves was accomplished (1922). The Laboratory was also a pioneer in radio broadcasting (1922).

developed using vacuum tubes then available. To obtain observers for the conduct of propagation investigations, contact was established with radio amateurs, who at that time were restricted to the use of the higher frequencies. Through their excellent cooperation considerable data were obtained on NARL's transmissions from points throughout the United States.

The Anacostia laboratory, soon to become one of the original parts of the Naval Research Laboratory, sought additional observers to

provide increased data for its propagation investigations by instituting regular radio broadcasts. The rapid rise of active public interest in broadcasting brought into being an extensive audience, which by 1920 was demanding scheduled broadcasts of all sorts of new material. Music, songs by noted singers, and talks by distinguished persons were broadcast, principally on 350 meters (858 kHz). The laboratory station call letters, NSF and NOF, became widely known. Many reports from grateful listeners throughout the country



## EARLY NAVY RADIO-ELECTRONICS



**FIRST RADIO BROADCAST BY A PRESIDENT OF THE UNITED STATES (1922)**

The address of President W. G. Harding at the dedication of the Lincoln Memorial on 30 May 1922 was broadcast from the Naval Aircraft Radio Laboratory, Anacostia, and the Navy's Radio Central station at Arlington, Virginia. The equipment used for both stations was developed by scientists who later became part of the original staff of NRI. The equipment at Anacostia is shown in the inset at lower right.

were received. During 1922, a number of original broadcasts were accomplished, including that of the first address by a Congressman, by a Senator, by a Chief Justice of the U.S. Supreme Court, and by a President of the United States. The first broadcast of a session of Congress was also made (1922). The first talks to be broadcast, a series on scientific subjects, were given beginning on 20 May 1921, by members of the staff of NARL. Public-health lectures, a series given by the U.S. Public Health Service, were first broadcast on 16 Dec. 1921 (858 kHz).<sup>47</sup> These were scheduled twice a week and were first made by the Surgeon General of

the United States. First broadcasts of note were those by Congressman (J. L. Cable of Ohio, 10 Feb. 1922), a Senator (Senator Henry Cabot Lodge of Massachusetts), a Chief Justice of the Supreme Court (Chief Justice White), the U.S. Marine Band (17 May 1922), and the U.S. Navy Band. An address of the President of the United States was first broadcast on 30 May 1922, when President W. G. Harding dedicated the Lincoln Memorial in Washington, D.C. (728 kHz).<sup>48</sup> The first broadcast of a session of Congress was accomplished on 8 Dec. 1922, when President Harding delivered his annual address to a joint session of both houses (700 kHz).<sup>49,500</sup>

## EARLY NAVY RADIO-ELECTRONICS

The Laboratory constructed a radio broadcast equipment and installed it at the Navy's station at Arlington, Virginia, in late 1922, so that it could be relieved of the routine broadcast work, which was beginning to interfere with its research.<sup>50b</sup> This equipment was the first to provide regular voice broadcasts of weather reports (423 kHz).

This early radio broadcast work included the development of several broadcasting techniques, the need of which became obvious as the work progressed. Means for signal-modulation monitoring, audio-frequency equalization to avoid distortion, acoustic treatment of broadcast enclosure walls, microphone placement and switching, and "on-the-air" signals were introduced.<sup>51a</sup>

This work of NARL on the higher frequencies provided a substantial contribution toward the advancement of radio broadcasting. The work also demonstrated to the Navy the possibilities of these frequencies for long-range radio communication.

### Radio Detection

NARL proceeded to develop vacuum-tube transmitting and receiving equipment capable of operating at frequencies up to 300 MHz and used this equipment in the conduct of short-range communication experiments. With this equipment (at 150 MHz, with a 50-watt tube), the reflections of radio waves from a ship were first observed (1922). The possibilities of detection and location of objects by this method was brought to the attention of the Bureau of Engineering.<sup>52</sup> The results of the work are considered a significant step toward radar.

The first multiple radio transmission system which permitted the simultaneous operation of three transmitters on one antenna was devised (1922).<sup>51b</sup> Two vacuum-tube transmitters on different radio frequencies and a low-frequency arc transmitter were accommodated,

<sup>a</sup>The title of the Bureau of Steam Engineering was changed to the Bureau of Engineering on 4 June 1920.

using a "nodal point" technique. The first multiple radio reception system, allowing many radio receivers to be operated from a single antenna, was also devised (1922).<sup>53,54</sup> This receiving system was installed on the battleship USS WYOMING and was successfully demonstrated during operations in the Caribbean Sea and in Pacific waters during the early part of 1923. The "centralization" of radio equipment and the establishment of a "radio central" was first accomplished in an installation aboard the USS COLORADO (1923). The installation incorporated the multiple reception system.

The transmitting and receiving functions were separated to reduce interaction by locating the transmitting function at one end of the ship and the receiving function at the other end, with transmitter controls and receivers in a "radio central." This practice is continued in current shipboard installations.<sup>50c</sup>

### Aircraft Radio

During its existence, NARL was the principal military organization engaged in radio research directed to the solution of aircraft problems. Some of the original work done at this laboratory follows.

The "night effect" at low radio frequencies was discovered (1919).<sup>55</sup> This effect is characterized by violent fluctuations of radio bearings due to nocturnal variations of the ionosphere. The discovery was made during investigations conducted to determine the feasibility of navigation through the use of radio direction-finder bearings obtained on signals from foreign high-power radio stations, in preparation for the first crossing of the Atlantic by airplane, later accomplished by the Navy's NC-4 seaplane.

Aircraft radio shielding was devised which made feasible for the first time effective two-way aircraft radio communication at medium frequencies (1920).<sup>56,57</sup> The radio energy generated by an aircraft engine ignition system was prevented from radiating, and thus interfering with radio reception, by enclosing all spark plugs, cables, and attending devices within an

## EARLY NAVY RADIO-ELECTRONICS

encompassing metallic shield. This shielding was a major factor in demonstrating for the first time the feasibility of "homing" by aircraft to aircraft carriers over long distances (190 miles), through the use of radio bearings on ship transmissions (F-5-L aircraft flight to USS OHIO at sea, 6 July 1920).<sup>58</sup> This technique was subsequently used by aircraft carriers.

The first aircraft radio-communication equipments giving effective and extended service in the Navy (1922) were developed.<sup>51c,59,60</sup> Both fighter plane (SE1375, 20 watts, 570 to 750 kHz) and patrol plane (SE1385, 500 watts, 300 to 570 kHz) equipments were provided. These were purchased in quantities and installed in virtually every Navy operating aircraft.

The first radio transmissions of teletype printed messages were accomplished by NARL, with instrumentation devised to make the use of teletype feasible over radio circuits. Transmissions were made for aircraft to ground (and the reverse) while the aircraft was in flight (1922).<sup>61</sup> The devising of this instrumentation was an important step toward effective remote control by radio.

Since these projects were elements of a continuing program conducted by personnel awaiting the availability of new research facilities, they will be more completely treated subsequently in this document, under appropriate subject titles. On 16 Apr. 1923, when the facilities of the Naval Research Laboratory first became available, the personnel and activities of NARL were transferred to become the major component of its newly formed Radio Division.

## REFERENCES

1. Bradley A. Fiske, "From Midshipman to Rear Admiral," New York: The Century Co., pp. 97-101, 1919. In 1888, LT Bradley A. Fiske USN (later ADM Fiske) transmitted signals from USS ATLANTA, lying at the New York Navy Yard, to a tug over short distances by the use of interrupted direct current through a coil of several turns wound around the Atlanta. The voltage induced in a similar coil wound around the tug produced signals in a telephone receiver connected to the coil. However, it appears that this transmission was accomplished through "induction" rather than through "radiation" of an electromagnetic field.

Summaries of the work of early experimenters include the following three references.

2. R.H. Marriott, "Radio Ancestors," IEEE Spectrum, June 1968
3. C. Susskind, "Papov and the Beginning of Radiotelegraphy," IRE, pp. 2036-2047, Oct. 1962
4. C. Susskind, "The Early History of Electronics," IEEE Spectrum
  - a. Part 1, Aug. 1968, p. 90
  - b. Part 2, Dec. 1968, p. 57
  - c. Part 3, Apr. 1969, pp. 69-74
  - d. Part 4, Aug. 1969, pp. 66-70
5. Report of the Secretary of the Navy, 1900, p. 319; Navy Department Library
6. "Admiral Dewey and the Manila Campaign," 1947, pp. 88-89, Naval Historical Foundation, Inc., Washington, D.C.; Navy Department Library, Wa. 8.245.C.1
7. Bureau of Equipment, Navy Department letter to SECNAV of Nov. 9, 1899, forwarding reports of observers; National Archives, Washington, D.C.; also see J.B. Blish, LT USN, "Notes on the Marconi Wireless Telegraph," U.S. Naval Inst. Proc., 1899, pp. 857-864
8. SECNAV letter to LCDR J. T. Newton of Oct. 23, 1899; files of Bureau of Equipment, National Archives, Washington, D.C.
9. Report of the Secretary of the Navy to the President, 1900, p. 319
10. Report of Board on Marconi System of Wireless Telegraphy," Nov. 4, 1899; files of Bureau of Equipment, National Archives, Washington, D.C.
11. Report of the Secretary of the Navy, 1902, pp. 30-31 and 375-376; Navy Department Library
12. W.H.G. Bullard, CAPT, USN, "U.S. Naval Radio Service," U.S. Naval Inst. Proceedings, 1914, pp. 432-471
13. J.M. Hudgins, LT USN, "Instructions for the Use of Wireless Telegraph Apparatus," Bureau of Equipment, 1903; Navy Department Library, SET: U: E 64H, NRL Library 621.3843.H884 (Ref.)
14. "Report of the U.S. Naval Wireless Telegraph Board," Aug. 28, 1903; files of the Bureau of Equipment, National Archives, Washington, D.C.
15. Report of the Secretary of the Navy to the President
  - a. 1903, pp. 373-375
  - b. 1904, pp. 62-64
  - c. 1905, pp. 319-320
16. Report of the Secretary of the Navy to the President, 1904, p. 18
17. Report of the Secretary of the Navy, FY 1906, pp. 50-52; Navy Department Library
18. Letter, Commander-in-Chief, U.S. Atlantic Fleet, to SECNAV, Jan. 22, 1906; Office of Naval Records and Library, Series RG45
19. Report of the Secretary of the Navy to the President, 1904, 1905
20. Heinrich Hertz, "Electric Waves," 1888. English translation by D.E. Jones, 1900; NRL Library 537 H536
21. O.E. Dunlop, "Marconi - The Man and His Wireless," MacMillan, New York, 1937, p. 96
22. E. Branly, *Comptes Rendus*, 1890, Vol. III, p. 785
23. R.H. Marriott, "United States Radio Development," Proc. IRE, June 1917, pp. 179-195
24. S.S. Robison, "Manual of Radio Telegraphy and Telephony," 1918, United States Naval Inst.
25. W.H.G. Bullard, CAPT, USN, "Arlington Radio Station and its Activities in the General Scheme of Naval Radio Communication," IRE, Oct. 1916, p. 421
26. "Report of the Secretary of the Navy," 1907, p. 346, 1908, p. 313; Navy Department Library

## EARLY NAVY RADIO-ELECTRONICS

27. "Report of the Secretary of the Navy," Bureau of Steam Engineering, Section 1919, p. 620; 1920, p. 714; Navy Department Library
28. L.F. Fuller, "The Design of Poulsen Arc Converters for Radio Telegraphy," Federal Telegraph Co., IRE, Oct. 1919, Vol. 7, No. 5; also Report of the Secretary of the Navy to the President, 1920, pp. 704, 714-715
29. W. Wilson, "A New Type of High Power Vacuum Tube," Bell System Tech. J., July 1922, pp. 4-17
30. W.R.G. Baker, "Commercial Radio Tube Transmitter," IRE, Dec. 1923, pp. 601-659
31. E.F.W. Alexanderson, "Trans-Oceanic Radio Communication," IRE, Aug. 1920, p. 263
32. T. Johnson, Jr., "Naval Aircraft Radio," IRE, Apr. 1920, Part II
  - a. pp. 110,111
  - b. pp. 87-99
  - c. pp. 109,110
  - d. pp. 119,120
  - e. pp. 111-114, 121
  - f. pp. 115-119
33. S.C. Southworth, "Forty Years of Radio-Research," 1962, pp. 22-25; NRL Library 621.384 S728
34. T. Johnson, Jr., "Naval Aircraft Radio," IRE, Feb. 1920, Part I
  - a. pp. 42-44
  - b. pp. 55-57
  - c. pp. 40-55
  - d. p. 5
  - e. p. 6
  - f. p. 10
  - g. pp. 32-40
  - h. p. 7
35. T. Johnson, Jr., "Naval Radio Tube Transmitters," IRE, Oct. 1921
  - a. pp. 393-397
  - b. pp. 397-433
36. R.S. Griffin, RADM, "History of the Bureau of Engineering, Navy Department During the World War," Navy Department Office of Naval Records Library, Publication Part I, No. 5 (1922), NRL Library 359.0072 T2381 (Ref)
37. NRSR, Mar. 1920, pp. 19-23
38. T. Johnson, Jr., "Naval Radio Tube Transmitters," IRE, Oct. 1921, pp. 381-433
39. L.W. Austin, "The Work of the U.S. Naval Radio-Telegraphic Laboratory," J. American Society of Naval Engineers, Vol. 24, No. 1, Feb. 1912
40. L.W. Austin, "Some Quantitative Experiments in Long Distance Radiotelegraphy," National Bureau of Standards Bulletin, Vol. 7, 1911, p. 315
41. "Plan for Coordination of Work at Navy Yards," Bureau of Steam Engineering, June 15, 1915
42. NRSR, 16 Aug. 1919
  - a. pp. 47-48
  - b. p. 49
43. A. Hoyt Taylor, "Short Wave Reception and Transmission on Ground Wires (Subterranean and Submarine)," IRE, Aug. 1919, pp. 337-362
44. "Report of the Secretary of the Navy," 1918, p. 529, Navy Department Library
45. A. Hoyt Taylor, "Long Wave Reception and the Elimination of Strays on Ground Wires (Subterranean and Submarine)," IRE, Dec. 1919
46. "Report of the Secretary of the Navy," 1919, p. 633, Navy Department Library
47. NRSR, Jan. 1922, p. 63
48. NRSR, Aug. 1922, pp. 8-11
49. New York Times, 9 Dec. 1922
50. NRSR, Feb. 1923,
  - a. p. 7
  - b. pp. 7-8
  - c. pp. 16-27
51. NRSR, "Experiments in Radio Telephony," July 1922
  - a. "Experiments in Radio Telephony" pp. 115,116,
  - b. p. 4
  - c. Problems 162-A, 163-A pp. 24,25
52. NARL letter from C.O., U.S. Naval Air Station, Anacostia, D.C. to Bureau of Engineering, 1323-A-48, 27 Sept. 1922, "Radio Telegraph-Experiments with Extremely Short Waves," NRL file S67/43(X)-1, "Transmission and Reception at Ultra-High Frequencies," Federal Record Center, NRL CRMO
53. NRSR, Oct. 1922, p. 29
54. NRSR, Nov. 1923, pp. 3-10
55. A. Hoyt Taylor, "Variations in Direction of Propagation of Long Electromagnetic Waves," National Bureau of Standards Papers No. 15, 1919, pp. 419-433
56. NRSR, Radio Research Problem No. 3, "Elimination of Induction Onboard Aircraft," Dec. 1919, pp. 29,30
57. NRSR, Problem No. 3, "Elimination of Induction Onboard Aircraft, Feb. 1920, pp. 43,44
58. NRSR, Aug. 1920, pp. 50-53
59. NRSR, July, Aug. 1927, pp. 1-14
60. NRSR, Oct., Nov., Dec. 1928, pp. 44-62
61. NRSR, Oct. 1922, pp. 25-29, Problem 126 B

## Chapter 2

# THE ESTABLISHMENT OF THE NAVAL RESEARCH LABORATORY

### INTRODUCTION

For many years, to improve its materiel, the Navy had utilized the products of science insofar as circumstances permitted. It had also undertaken in-house scientific work in certain fields of interest. To advance navigation, the Navy initiated specific efforts in hydrography (1830), standard time (1830), and astronomy (1834), the responsibilities for which were assigned to the Naval Observatory and the Hydrographic Office in 1866.<sup>1,2</sup> The Navy had long been concerned with technology which would improve its ordnance, ship-hull design, propulsion, machinery, fuels, and lubrication, and solve its fouling and corrosion problems. From time to time it had set up particular activities to deal with these subjects. Official acknowledgement of the importance of science to the Navy was expressed when Secretary of the Navy, the Honorable William C. Whitney, in his annual report to the President (1885), stated "A Naval vessel at the present moment is a product of science... It is of little service to a nation to have any Navy at all unless it is a fair expression of the highest scientific resources of its day."<sup>3</sup> However, in his efforts to attain this objective the Secretary came to realize that serious and frustrating impediments existed.

Under the Navy Bureau system, established in 1842, the Congress had imposed such detailed control of Navy funding and such rigid organizational structure, with closely specified functions, as nearly to preclude opportunity for basic scientific investigation and exploratory

innovation. Such work as could be done to improve technology was carried out principally at Navy Yards, where anything of an exploratory nature was subjugated to the exigencies of their prime functions of construction and maintenance, and it suffered accordingly. The scope of such work was limited usually to the area of responsibility of the particular Bureau, Division, or Branch involved, and also by the meager scientific resources available. When a proposed project embraced the responsibilities of more than one Bureau, difficulties in jurisdiction and funding arose which tended to discourage progress. No means existed to bring together expertise in several scientific disciplines, familiar with naval problems, which could provide that cooperative interdisciplinary scientific activity leading to the generation and development of new ideas. Serious effort to bring about a change in this situation did not occur until the nation's involvement in World War I was imminent.

### THE NAVAL CONSULTING BOARD

Early in World War I, the devastating effectiveness of Germany's submarines forcefully demonstrated to the American public the impact science could have on warfare capability and the necessity for preparedness should this country be drawn into the conflict. Thomas A. Edison, in an interview reported in the *New York Times Magazine* issue of 30 May 1915, expressed his views on preparedness for war,

## ESTABLISHMENT OF NRL

and proposed that "...the government should maintain a great research laboratory, jointly under military and Naval and civilian control..." In this laboratory "...could be developed the continually increasing possibilities of great guns, the minutiae of new explosives, all the technique of military and Naval progression without any vast expense..."<sup>4</sup>

The Secretary of the Navy, then the Honorable Josephus Daniels, the first government official to initiate action to deal with the new conditions of warfare, decided to establish a "Department of Invention and Development" in the Navy to consider all new ideas and suggestions for improvement of the Navy and to perfect those selected as worthy. The Secretary, on 7 July 1915, outlined his plan in a letter to Mr. Edison, requesting him to act as advisor to a board to be established to recommend means for attaining the Secretary's objective. Mr. Edison assented to this request on 13 July 1915.

The "Naval Consulting Board" which resulted from this action comprised 24 "...leaders in the inventive, engineering and industrial world..." nominated by 11 of the largest engineering societies of the country. This board was a pioneer organization in dealing with inventions and scientific work in preparedness for war. Mr. Edison became the board's first chairman. Its first formal meeting was held at the Navy Department in Washington on 7 October 1915.<sup>5</sup>

An "Office of Inventions" was established under the Secretary of the Navy "to coordinate the considerations of all suggestions, ideas, devices and inventions—and to refer such as were deemed worthy..." to the "...Board and Departmental experts." On 7 December 1915, RADM William Strother Smith (then Captain) was appointed head of this office and Liaison Officer with the board.<sup>6</sup>

In its early days, the board covered a wide field, carrying on a general campaign for industrial preparedness which led to the formation of the Council of National Defense. Since the council concerned itself with the broader functions of preparedness, the board soon limited

its scope to consideration of new ideas and inventions submitted for advancing warfare and eventually assumed this function for the entire military organization. In dealing with these new ideas the board soon recognized the need of adequate experimental facilities. Although the Navy had available such organizations as the Naval Observatory and the Naval Experimental Station, Annapolis, Maryland, it was considered that the existing facilities were wholly inadequate to contend with the problems looming so large on the horizon at that time.

The provision of suitable facilities was the subject of a study by a special committee headed by Mr. Edison, who took a great personal interest in the matter. It was considered that the Navy should have a new laboratory "...for experimental research only..." which would have "...a corps of technically trained men...developed during peacetimes...who would be familiar with Naval Affairs and the present state of development of the arts used in Naval Warfare whenever war comes. This technical personnel would be the nucleus for the mobilization of scientists for war. ...Money could be spent on research and development without first making an exact estimate of cost. ...Experiments on new ideas could be conducted...without expecting... a useable product out of each experiment. ...The Laboratory's objective...would be to increase the knowledge of the Navy in regard to the Arts and Sciences...the management would be civilian...under the direction of a Naval Officer...of high rank... distinguished by his scientific attainments and managerial capacity who should report directly...to the Navy Department..." free from "...Bureau Control..." "The various Bureau Chiefs should turn over their problems...to the Laboratory."<sup>7a</sup>

On 15 Mar. 1916, Secretary Daniels, Mr. Edison, and certain members of the board appeared before the House Naval Affairs Committee of Congress in support of the proposed Laboratory.<sup>7</sup> It was considered that the Laboratory owes its existence to the work of the board, and particularly to its chairman, Mr. Edison, since

## ESTABLISHMENT OF NRL



The Naval Consulting Board of the United States

This group of distinguished scientists, an advisory panel for technical matters formed by Secretary of the Navy Josephus Daniels, made the original proposal for a "Naval Experimental Laboratory" in 1915.

- |                              |                         |                                |                              |
|------------------------------|-------------------------|--------------------------------|------------------------------|
| 1. Dr. Frank J. Sprague      | 10. Mr. W. L. R. Emmett | 19.                            | 27. Admiral Ridley McLain    |
| 2. Mr. Lawrence Addicks      | 11. Dr. A. G. Webster   | 20.                            | 28. Mr. B. B. Thayer         |
| 3. Dr. M. R. Hutchinson      | 12. Dr. L. H. Baekeland | 21. Admiral Wm. Strother Smith | 29. Maj. Gen. Lejeune (USMC) |
| 4. Mr. Thomas A. Edison      | 13. Admiral Leigh       | 22.                            | 30. Dr. W. R. Whitney        |
| 5. Mr. Josephus Daniels      | 14. Mr. Spencer Miller  | 23. Mr. Elmer A. Sperry        | 31. Admiral D. W. Taylor     |
| 6. Mr. Wm. L. Saunders       | 15. Mr. Thomas Robbins  | 24. Admiral W. H. Benson       | 32. Mr. Matthew B. Sellers   |
| 7. Mr. Franklin D. Roosevelt | 16. Mr. A. M. Hunt      | 25. Mr. Bion J. Arnold         | 33. Mr. Hudson Maxim         |
| 8. Mr. Howard E. Coffin      | 17. Mr. Andrew L. Riker | 26. Admiral J. Straus          | 34. Dr. R. S. Woodward       |
| 9. Dr. Peter Cooper Hewitt   | 18.                     |                                |                              |

60060

### COMMITTEE OF THE NAVAL CONSULTING BOARD CONCERNED WITH A NEW NAVAL LABORATORY (NRL)

Thomas Edison (Chairman) (center); Dr. L. H. Baekeland (12), President of the Bakelite Corporation, nominated by the American Chemical Society; Dr. W. R. Whitney (30), Director of the General Electric Research Laboratory, nominated by the American Chemical Society; Dr. R. S. Woodward (34), Carnegie Institute of Washington, D.C., nominated by the American Mathematical Society; Mr. H. E. Coffin (8), Vice President of the Hudson Motor Car Co., nominated by the Society of Automotive Engineers.

### COMMITTEES OF THE NAVAL CONSULTING BOARD CONCERNED WITH SCIENTIFIC AREAS IN WHICH NRL WAS EVENTUALLY TO BE ENGAGED

"Wireless and Communications" (Radio), Dr. Peter Cooper Hewitt (Chairman) (9), inventor of the mercury arc light and rectifier, nominated by the Inventor's Guild; Dr. W. R. Whitney (30); Dr. A. G. Webster (11), professor of Physics, Clark University, nominated by the American Mathematical Society; "Special Problems" (including detection of submarines with Sound), Dr. B. G. Lamme (Chairman) ( ), nominated by the American Institute of Electrical Engineers. "Chemistry," Dr. W. R. Whitney (Chairman) (30); "Physics," Dr. A. G. Webster (Chairman) (11); "Metallurgy," Dr. J. W. Richards (Chairman) ( ); "Electricity," Dr. F. J. Sprague (Chairman) (1); "Optical Glass," Dr. L. H. Baekeland (Chairman) (12).

## ESTABLISHMENT OF NRL

**Experimental and research laboratory. Equipment, operation, etc.** **EXPERIMENTAL AND RESEARCH LABORATORY:** For laboratory and research work on the subject of gun erosion, torpedo motive power, the gyroscope, submarine guns, protection against submarine, torpedo and mine attack, improvement in submarine attachments, improvement and development in submarine engines, storage batteries and propulsion, aeroplanes and aircraft, improvement in radio installations, and such other necessary work for the benefit of the Government service, including the construction, equipment, and operation of a laboratory, the employment of scientific civilian assistants as may become necessary, to be expended under the direction of the Secretary of the Navy (limit of cost not to exceed \$1,500,000), \$1,000,000: *Provided*, That nothing herein shall be construed as preventing or interfering with the continuation or undertaking of necessary experimental work during the fiscal year ending June thirtieth, nineteen hundred and seventeen, as heretofore conducted under other appropriations: *Provided further*, That the Secretary of the Navy shall make detailed reports to the Congress not later than June thirtieth, nineteen hundred and seventeen, and annually thereafter, showing the manner in which all expenditures hereunder have been made.

Approved, August 29, 1916.

### THE ACT OF CONGRESS ESTABLISHING THE NAVAL RESEARCH LABORATORY

Public Law 241, approved 29 August 1916, H.R. 15947, 64th Congress, Session I.



#### GROUND-BREAKING FOR NRL'S FIRST BUILDING

Secretary of the Navy, the Honorable Josephus Daniels, broke ground for NRL's Building 1 on 6 Dec. 1920. It was Secretary Daniels' interest in advancing the technology of the Navy and his initiative, as the first government official to take action to deal with the new conditions of warfare, which led eventually to the establishment of NRL. ADM R.E. Coontz, USN, then Chief of Naval Operations, is to the immediate right of the Secretary and in the background. RADM William Strother Smith, USN, NRL's first Director, appears further to the right and in the foreground.



## ESTABLISHMENT OF NRL

on 29 Aug. 1916, Congress appropriated \$1,000,000 for construction of a Naval "Experimental and Research Laboratory,"<sup>8</sup> a sum which was increased to \$1,500,000 by Congress on 4 Mar. 1917.<sup>9</sup> The name of the Laboratory was changed later to the "Naval Research Laboratory" (NRL). This change was recommended by the Director in 1924, during Congressional hearings for FY 1926 appropriations, and it appeared in Public Law 398, approved 11 Feb. 1926.<sup>10a</sup>

The board, after considering several sites for the location of the Laboratory, recommended its consolidation with the Naval Experimental Station, Annapolis, Maryland. Mr. Edison did not agree with this, preferring a site on the Sandy Hook Peninsula in New Jersey. In later years, in a letter to the Director of NRL, complimenting the Laboratory on its development, Mr. Edison said that his objections to an alternate location had apparently been without foundation.<sup>11a</sup> However, this lack of agreement on a site at a critical time, together with the beginning of direct U.S. involvement in World War I on 6 Apr. 1917, delayed the start of construction of the Laboratory until the war was over.

After the war, a report of the Navy's Engineer-in-Chief, Chief Constructor and Chief of the Bureau of Ordnance, transmitted to the Secretary of the Navy, recommended proceeding with construction of the Laboratory as proposed by a preliminary committee representing the Bureaus of Steam Engineering, Construction and Repair, Ordnance, and Yards and Docks. Acting on this recommendation, Secretary Daniels on 20 Oct. 1919 authorized construction of the Laboratory and directed the Bureau of Yards and Docks to proceed.<sup>12</sup> This action included the decision by Secretary Daniels that the site for the Laboratory would be at the "Bellevue Arsenal...on the Potomac River...down the river from Washington."<sup>13</sup> Surveys, plans, and specifications were prepared and proposals opened on 15 Oct. 1920.<sup>14</sup> Ground was broken for the first Laboratory building (now numbered 1) on 6 Dec. 1920, by Secretary

Daniels, with the Chief of Naval Operations, then ADM R. E. Coontz, present.

On 13 Sept. 1921, RADM William Strother Smith was ordered to additional duty as Director of the Laboratory by the Secretary of the Navy, then, the Honorable Edwin Denby, in recognition of his valuable contributions to obtaining the Laboratory.<sup>15</sup> However, RADM Smith retired on 15 Sept. 1921, before construction was completed. CAPT E. L. Bennett was appointed to succeed him on 31 Dec. 1921, and was the Laboratory's director at the time of its formal commissioning on 2 July 1923.

## ORGANIZATION OF THE NAVAL RESEARCH LABORATORY

At the time the construction of NRL's first buildings was nearing completion, the bureaus of the Navy Department evinced little or no interest in sponsoring work at NRL, with the exception of the Radio Division of the Bureau of Engineering. Other bureaus felt they had adequate facilities, such as those at the Naval Engineering Experiment Station, Annapolis, Maryland. The head of the Radio Division of the Bureau of Engineering, CDR Stanford C. Hooper (later RADM Hooper), was strongly convinced of the importance of consolidating the radio and sound research work of the several laboratories of his division in one location. He thought that this work should be done at NRL.<sup>16</sup> In this matter he had to contend with the objections of the Chief of the Bureau of Engineering, then ADM J. K. Robinson, who considered existing facilities adequate. The nation's economy was then just recovering from the postwar depression of the early 1920's, and funding was difficult to obtain. The great pressure for disarmament caused Congress to scrutinize closely all military appropriations, and the project for a new laboratory was an attractive target to effect economy, particularly in view of the lack of general Navy bureau support. The funding that had previously been provided by Congress was barely adequate to cover construction, and the additional amount sought for

## ESTABLISHMENT OF NRL



THE COMMISSIONING OF THE NAVAL RESEARCH LABORATORY

The Laboratory was formally commissioned on 2 July 1923 by the Assistant Secretary of the Navy, then the Honorable Theodore Roosevelt, Jr. (seated fourth from left). The Laboratory's Director, CAPT E.L. Bennett, USN, (standing), is shown accepting the completed Laboratory. The commissioning ceremonies were held in front of NRL Building 1.

fiscal year 1923 would provide only a minimum for "maintenance" and little for "operations." The funding provided through CDR Hooper's organization and the prospects of the transfer of the research activities he sponsored became important factors. It was through CDR Hooper's aggressive interest, and the support given by RADM Smith and several members of the Naval Consulting Board in appealing directly to Congress, that cancellation of funding for NRL by Congress was avoided. Had it not been for their persistent efforts the establishment of

NRL as an organization devoted to Naval research would not have been realized at that time.<sup>11b</sup> Congress finally appropriated \$100,000 for FY 1923, for maintenance and operations<sup>10b</sup>, and the Laboratory got underway.

Construction of NRL's buildings reached a stage of completion making occupancy possible early in 1923. The Radio Division of the Bureau of Engineering had formulated a plan for the consolidation of its radio and sound research and development activities at NRL.<sup>17</sup> In accordance with this plan, the staff and facilities

## ESTABLISHMENT OF NRL



### THE NAVAL RESEARCH LABORATORY, PAST AND PRESENT

NRL at the time of its formal opening possessed five buildings—a laboratory (Building 1), a machine shop (Building 2), a foundry and other support facilities (Buildings 3 and 4), and a power plant (Building 5). The original NRL buildings are now surrounded by over one hundred structures housing laboratories and support facilities, some general-purpose and some highly specialized. The original five NRL buildings are seen outlined in heavy lines.

## ESTABLISHMENT OF NRL

of the Naval Aircraft Radio Laboratory and the Naval Radio Telegraphic Laboratory were transferred to NRL on 16 Apr. 1923, to form its Radio Division, with Dr. A. Hoyt Taylor as its Superintendent.<sup>18</sup> At the same time, the Sound Research Section of the Naval Engineering Experiment Station, Annapolis, Maryland, part of a research group assembled at New London, Connecticut, during World War I, and temporarily quartered at Annapolis, was transferred to NRL to become its Sound Division, with Dr. H. C. Hayes as its Superintendent. Due to these transfers of personnel, 16 Apr. 1923 is the date of the actual beginning of NRL's scientific activities. However, the Laboratory was formally commissioned on 2 July 1923 (1 July was a Sunday) by the Honorable Theodore Roosevelt, Jr.,<sup>19</sup> then the Assistant Secretary of the Navy. The two divisions first to be organized, Radio and Sound, were begun with scientific staffs totalling 14 for Radio and 3 for Sound. On the date the Laboratory was officially commissioned, the research staff had increased to 24, and this personnel, together with that of the Director's office and shops, brought the total Laboratory staff to approximately 55. To complete the Bureau of Engineering's plan, the development and design activities of the Radio Test Shop, Washington Navy Yard, were transferred to NRL's Radio Division in September 1923.

### ADMINISTRATIVE STATUS OF NRL

On 25 Mar. 1922, the Secretary of the Navy, then the Honorable Edwin Denby, "established and placed [the Laboratory] under the Assistant Secretary of the Navy ...under the direction of a Naval Officer not below the rank of Captain, who will be designated 'The Director'...and be attached to the Office of the Assistant Secretary of the Navy."<sup>20</sup> From the establishment of the Laboratory, and until March 1932, the Director also was assigned the duties of "Technical Aide for Inventions" to the Secretary of the Navy.<sup>21</sup> Until 1932, the Office of the Director

was located at the Navy Department, with the responsibility for the immediate operation of the Laboratory residing in the Assistant Director. On 13 Nov. 1928, the Laboratory was "established as an independent unit under the Assistant Secretary of the Navy,"<sup>22</sup> then the Honorable Curtis D. Wilbur.

In 1931, the Chief of the Bureau of Engineering, supported by the Chiefs of the other technical bureaus, recommended that the Laboratory be transferred to the cognizance of the Bureau of Engineering, since this bureau had provided most of its support during its existence by allocation of funds and assignment of problems. The legality of this action, relative to the Act of Congress establishing the Laboratory, was questioned. The Judge Advocate General of the Navy, whose opinion was sought, reported that the Secretary of the Navy had authority under existing statutes to so act.<sup>23</sup> Although the proposed transfer of the Laboratory contravened the important principle which led to its establishment originally, the Laboratory was "placed under the cognizance of the Bureau of Engineering" on 5 Nov. 1931, by the Secretary of the Navy, the Honorable C. E. Adams.<sup>24</sup>

Shortly thereafter (1931), the Secretary requested the Navy's General Board to consider "the question as to the policy which should be pursued with respect to the Naval Research Laboratory, its proper functions and its proper position in the Naval Establishment." The board held hearings to obtain the views of the several bureaus and offices concerned and visited the Laboratory. On 9 Feb. 1932, the board reported to the Secretary that "(a) Naval research, of which the Naval Research Laboratory is an essential agent, is a necessary Naval activity and should be continued. (b) The activities of the Laboratory should be confined to research and primary or laboratory experimentation. Subsequent full scale experimentation, service test, and production should devolve upon the material bureaus. (c) The Office of the Chief of Naval Operations is best fitted to administer the Naval Research Laboratory because the Chief of Naval Operations is fundamentally

## ESTABLISHMENT OF NRL

responsible for the basic technical improvement of the Fleet and for its readiness for war."<sup>25</sup> The Chief of Naval Operations opposed the recommended transfer of the Laboratory to his office on the grounds that personnel already on the rolls of the bureaus would have to be duplicated. Thus, the Laboratory continued to remain under the Bureau of Engineering. During the hearings of the Navy Department Subcommittee of the House Appropriations Committee on FY 1933 funding held on 1 and 4 Mar. 1932, the subcommittee considered research operations in general, hearing the testimony of the heads of several major industrial laboratories. No change in the administrative position of the Laboratory was indicated by the subcommittee. However, it ruled that the appropriation of funds for the Laboratory were to be kept separate from those for the Bureau of Engineering's other activities to prevent "research" from being interrupted by the urgency of "production."<sup>26</sup> With this special annual appropriation (\$100,000 for FY 1924, to \$213,000 for FY 1933) the Laboratory, in addition to providing for its "operation and maintenance," had been able to make a modest start on new areas of research and this function was continued.

On 9 Apr. 1932, the Bureau of Engineering, then headed by RADM S. M. Robinson, in stating its policy with respect to the Laboratory, established very close control over NRL's organization and administration.<sup>27</sup> On 4 Aug. 1932, the bureau required the Laboratory to separate the research work of its Radio Division from its engineering work through establishment of separate "research" and "engineering" divisions.<sup>28</sup> On 29 Dec. 1933, the bureau stated that "this has proved unsatisfactory for a number of reasons" and required that the two divisions be brought together again as a single Radio Division.<sup>29</sup> This close control was found cumbersome, and the internal administrative control was turned over to the Director, except for questions on general policy, early in 1934. This arrangement to some extent was implied in "Regulations Governing the Operation of the Naval Research Laboratory," issued by the Honorable

C. A. Swanson, then the Secretary of the Navy, on 13 May 1935.<sup>30</sup> However, these regulations still required that "All correspondence both to and from the Laboratory shall be sent through the Bureau of Engineering."

On 14 Sept. 1939, the Laboratory was "established as an independent unit under the Secretary of the Navy by the Honorable Charles Edison, then Secretary of the Navy."<sup>31</sup> The policy established (1 Nov. 1939) by the Secretary gave the Laboratory a large measure of administrative freedom.<sup>32</sup> Secretary Edison had taken great interest in the Laboratory, and had visited it a number of times. His action undoubtedly reflected the personally acquired understanding of the factors attending the administrative status of the Laboratory, as well as the views of his father, Mr. Thomas A. Edison, in this regard.

On 8 Dec. 1939, Secretary Edison established a Navy Department Council for Research to provide a "...higher degree of coordination of Research..." in the Navy. The Secretary was convinced that "...it was absolutely necessary and the time had come to coordinate and centralize the control of research for the Navy in order to make greater progress and to emphasize the value of research for the Navy."<sup>33</sup> The council comprised members representing the material bureaus, with the Director of NRL presiding as senior member. The Director, NRL, was also designated "technical aid to the Secretary of the Navy" and was required to "Keep the Secretary informed of the progress of research problems."<sup>34</sup>

In January 1941, the Director of the Laboratory, then RADM H. S. Bowen, recommended to the Secretary of the Navy that bureau status be given to the Laboratory, that its name be changed to the "Naval Research Center," and that it supervise all research for the Navy.<sup>35</sup> The proposal was not implemented.

On 27 June 1940, with the approval of President F. D. Roosevelt, the Council of National Defense created the National Defense Research Committee to mobilize American scientists for the purpose of preparing the United States for

## ESTABLISHMENT OF NRL

participation in World War II, should it be drawn into the conflict, which had been underway since 1 Sept. 1939. The position of this committee was greatly strengthened when it was included in the Office of Scientific Research and Development, established in the executive office of the President with the issuance of an executive order by President Roosevelt on 28 June 1941.<sup>35b</sup> There was concern in the Navy respecting the relationship between this committee and the Laboratory in the matter of mobilizing scientists to deal with antisubmarine warfare; the Laboratory held the position that it should have jurisdiction. Upon the recommendation of the Director of the Laboratory, the Secretary of the Navy, then the Honorable Frank Knox, requested the Navy's General Board to review the Navy's research and development policy in general and the coordination of research within the Navy Department.<sup>35c,36</sup> As a result of the board's report, on 12 July 1941, the Secretary placed the Laboratory under the cognizance of the Bureau of Ships.<sup>37</sup> At the same time, the Secretary established a Naval Research and Development Board "...to recommend to the Secretary of the Navy action in respect to Research and Development matters." The board comprised members representing the several materiel bureaus and the Chief of Naval Operations, with a chairman who was also "Coordinator of Research and Development."<sup>37,35d</sup> It was this board that provided liaison between the Navy and the National Defense Research Committee during the war.

On 19 May 1945, the "Office of Research and Inventions" was established in the Office of the Secretary of the Navy by the Honorable James Forrestal, then Secretary, to improve the patent situation in the Navy in view of congressional criticism. By the Secretary's order the Laboratory was included in this office.<sup>38</sup> RADM H. S. Bowen, NRL's former director, was appointed head of this office.

<sup>35</sup>The Bureau of Engineering and the Bureau of Construction and Repair were merged to form the Bureau of Ships on 1 July 1940 with RADM S. M. Robinson (later VADM Robinson) as its Chief.

When the Office of Naval Research was established by action of the 79th Congress on 1 Aug. 1946, the Laboratory was included as part of this organization.<sup>39</sup> VADM Bowen was appointed the first head of this office, with the title "Chief of Naval Research." This action gave research a strong position in the Naval establishment, since the Office of Naval Research had acquired statutory authority and its own congressional appropriation. The Laboratory was then again in a position to serve all bureaus, but free of the direct control of any one. Since the National Defense Research Committee was a temporary wartime agency, as it was phased out of existence the Laboratory proceeded to absorb such parts of its scientific components as were determined suitable to fit into the Laboratory's research program.

### SCOPE OF THE LABORATORY'S ACTIVITIES

An indication of the scientific areas in which the Laboratory was eventually to be engaged was given in the committee structure of the Naval Consulting Board. Committees were established to consider "wireless" and communications (radio), chemistry, physics, electricity, optics, and metallurgy.<sup>36</sup> A special problems committee gave particular attention to the use of sound in the detection of enemy submarines.<sup>5c</sup> Mr. Edison's special committee on the proposed new Naval Experimental and Research Laboratory also recommended conduct of work in most of these areas.<sup>3d</sup> However, the Act of Congress establishing the Laboratory (1916) stated broadly that it was for "laboratory and research work" in certain materiel areas which it enumerated.

When the Laboratory was activated in 1923, two of the scientific areas of work envisioned by the Naval Consulting Board, "radio" and "sound," were provided for under the plan of the Radio Division of the Bureau of Engineering by the transfer of existing facilities to become NRL's Radio and Sound Divisions. On 1 Aug. 1923, a small "ballistics and high pressure" research unit maintained by the

## ESTABLISHMENT OF NRL

Bureau of Ordnance at the Bureau of Standards was transferred to the Laboratory.<sup>40</sup> Since other offices of the bureaus were not interested in sponsoring divisions, particularly with "scientific" designations, their establishment had to be accomplished through increases in NRL's separate congressional appropriation, which otherwise was hardly adequate for its routine "operations and maintenance". Although forewarned of the probable adverse effects competition might bring to their own divisions, it was through the foresight of the Superintendents of the Radio and Sound Divisions, Dr. A. Hoyt Taylor and Dr. H. C. Hayes, and their persistence in overcoming the objections of the Director of the Laboratory, that new research divisions were instituted.<sup>41</sup> Sufficient funds were available to begin a "Heat and Light" Division (the title was changed to "Physical Optics" in 1931, later to "Optics", and still later to "Optical Physics") on 4 June 1924, with Dr. E. O. Hulburt as its Superintendent.<sup>42</sup> A "Physical Chemistry" Division (title changed to "Chemistry" in 1934) was started on 15 Aug. 1927, with Dr. F. R. Bichowsky as Superintendent.<sup>43</sup> On 1 Sept. 1927, a "Physical Metallurgy" Division (title later changed to "Metallurgy") was set up, with Dr. R. T. Mehl as Superintendent.<sup>44</sup> In June 1931 a "Thermodynamics" Division was started, under Dr. R. L. Canfield.<sup>45</sup> This division was merged with the "Metallurgy" Division in July 1934. A "Mechanics and Electricity" Division was begun in 1931, under Dr. D. L. Hay, with the "ballistics" research unit previously mentioned included in it.<sup>46</sup> In 1940 this division also acquired the thermodynamics activities of the Metallurgy Division.

With the establishment of these divisions, the several scientific areas of work set forth by the Naval Consulting Board were brought to fruition. In the years that followed, their research character was preserved by virtue of the recognition of the value of their contributions to the Navy, even during periods when the Laboratory was under bureau direction. The separation of the Radio Division into "re-

search" and "engineering" components during the period August 1932 to December 1933, and the existence of an "Aircraft" Division from January 1934 to March 1935,<sup>46</sup> both required by bureau action, had no substantial adverse effect in this regard. The Laboratory organizational structure at the division level remained otherwise unchanged until near the end of World War II.

While the Laboratory's growth was slow during the period prior to World War II, it expanded rapidly with the approach of and during the War. In March 1934, when some growth began after the great economic depression, the population of the Research Department was 83, of which 40 were in the Radio Division. Near the end of the war in 1945 the Research Department population had reached 3209, of which 1020 were members of the Radio Division.<sup>47</sup>

### POSTWAR ORGANIZATIONAL STRUCTURE

In May 1945 the Bureau of Aeronautics requested the Laboratory to establish an Aircraft Electronics Division.<sup>48</sup> Consideration of this request led to a decision by the Laboratory to subdivide the original Radio Division into four divisions, i.e., an Aircraft Radio Division, a Ship-Shore Radio Division, a Fire Control Division, and an Electronics Special Research Division. The first three divisions, corresponding respectively to the Bureaus of Aeronautics, Ships, and Ordnance, were to be supported principally by these bureaus. The Electronics Special Research Division was to be supported principally by the Laboratory. The Laboratory's decision to establish these divisions was made effective 1 July 1945. Dr. A. Hoyt Taylor then became Coordinator for these divisions and later Consultant for Electronics to the Director of the Laboratory, a position he held until his retirement in 1948.

During 1946, the Bureau of Aeronautics decided to establish a radio organization under its own direct control and located at some site apart from NRL, preferring this to the NRL

## ESTABLISHMENT OF NRL

divisional structure. The new organization was planned to be formed through the transfer of personnel and facilities of the NRL Aircraft Radio Division. Delay in the determination of a new location and other uncertainties was accompanied by the loss of a considerable number of key personnel. Furthermore, a large percentage of the remaining personnel did not wish to leave NRL. The situation was further complicated because it was not found feasible to localize completely the work of a particular Bureau in one division. The Laboratory finally decided to abandon the Bureau alignment of divisions. It reduced the number of Radio Divisions from four to three and renamed them on 26 Nov. 1946.<sup>49</sup> The Electronics Special Research Division became Radio Division I, the Ship-Shore Radio Division became Radio Division II, and the Fire, Missile, and Pilotless Aircraft Division (name changed from Fire Control Division on 15 Dec. 1945) became Radio Division III. Radio Division III absorbed the personnel remaining from the Aircraft Radio Division, which was disestablished.

Originally the superintendents of the Laboratory's several scientific divisions reported directly to the Director of the Laboratory. When the 80th Congress, under Public Law 313, authorized the establishment of positions of "specially qualified scientific and professional personnel," the Secretary of the Navy allocated one of these positions to the Laboratory. As directed by the Chief of Naval Research relative to this allocation, the Director of the Laboratory on 20 May 1948 established the position of Director of Research, interposed "... between the Director of the Laboratory and the ten scientific divisions, ... the position to be filled by a civilian scientist ...".<sup>50</sup> At the same time, the position of Director of Administration was interposed "... between the Director of the Laboratory and the eight administrative offices ... to be filled by a Naval Officer." The first appointment to this position was made effective 24 Jan. 1949.<sup>51</sup>

Effective 28 Jan. 1949, the Director of the Laboratory appointed Dr. Edward O. Hulbert

to the position of Director of Research as its first incumbent.<sup>52</sup> Three Consultants to the Director of Research were appointed to assist him in the direction of the several scientific divisions. These Consultants were Division Superintendents, who retained the responsibilities relative to their respective divisions. Effective 24 Dec. 1952, these Consultants were designated Associates to the Director of Research, to perform functions, each "... for a group of divisions as designated by the Director of Research."<sup>53</sup> The Consultants were relieved of their responsibilities as division superintendents.

On 17 June 1953, the Director of the Laboratory established a committee to review the scientific program and organization of the Laboratory and to make recommendations on advisable changes.<sup>54</sup> The committee made its report to the Director on 18 Jan. 1954.<sup>55</sup> The Director, after accepting the recommendations of this committee, established effective 1 Mar. 1954 a Research Department under the Director of Research with three principal scientific areas—Electronics, Materials, and Nucleonics.<sup>56</sup> Also, the Associates to the Director of Research became the Associate Directors of Research for Electronics, Materials, and Nucleonics, respectively. They were assigned "line responsibility" for their respective fields and were also responsible for "jointly assisting the Director of Research in formulation, direction and management of the Research Department and its program." The Nucleonics Area was renamed the General Sciences Area effective 27 Feb. 1966.<sup>57</sup>

The Electronic Area, as established on 1 Mar. 1954, included the three Radio Divisions and the Sound Division. Radio Division I was renamed the Electronics Division. Radio Division II became the Radio Division, and Radio Division III became the Radar Division, absorbing the radar activities of Radio Division II. Also, a new Division, the Applications Research Division, was established through the transfer of the remnants of a Systems Coordination Division previously established which had not achieved its intended purpose. In addition, the Applications Research Division acquired the



## ESTABLISHMENT OF NRL

"systems" activities of Radio Division II and the operational research and engineering psychology work of Radio Division III.

On 16 Sep. 1966, the Electronic Countermeasures activities of the Radio Division were transferred to a new division, then established under the title "Electronics Warfare Division."<sup>58</sup> On 16 Aug. 1968, the title of the Radio Division was changed to Communications Sciences Division.<sup>59</sup>

The Sound Division was transferred from the Electronics Area to form part of a new Oceanology Area, a fourth major research area of NRL, when this area was established on 1 Sept. 1967.<sup>60</sup>

On 19 Feb. 1971, several organizational changes were made.<sup>61</sup> In the Electronics Area, the Applications Research Division was disestablished and a Tactical Electronic Warfare Division was established, replacing the Electronic Warfare Division. The Materials Area was renamed the Materials and General Sciences Area. The General Sciences Area was renamed the Space Science and Technology Area.

### NRL's RADIO-ELECTRONICS PROGRAM

At the end of World War I, the Navy sponsored developments leading to vacuum-tube transmitters which would accommodate the transition from the Navy's spark and arc equipments. After the war, commercial organizations limited their work for the Navy principally to the production of these lower frequency equipments. The rapid rise of the public's interest in radio broadcasting, with prospects of extensive public demand and large profits, provided a strong incentive for commercial companies to become heavily involved in the broadcast field. Their developmental efforts, therefore, were concentrated on improvements in broadcasting equipment, particularly broadcast receivers. As a result, solutions of the Navy's longer range radio problems were of little interest to them. Undoubtedly, the drastically diminished Naval appropriations due to extensive national disarmament efforts during this period had a strong influence on the situation.

As a result, the consolidation of the Navy's radio research and development activities at NRL in 1923 made the Laboratory the Navy's sole in-house organization with full responsibility for advancing the Navy's *radio capability, with little outside assistance.*

The radio staff assembled at NRL in 1923 represented experience in most aspects of radio work active at that time. The Laboratory's initial radio program was an integration and extension of the previous efforts of this staff, as agreed to with the Bureau of Engineering. Although limited to a certain degree by the problems assigned by the Bureau, considerable latitude was enjoyed in their generation and execution. **The areas of NRL's effort included Radio Propagation, Radio Communication, Radio Direction Finding (Navigation), Radio Control, Radio Standards and Instrumentation, particularly Precise Frequency Determination, Generation, Measurement, and Control.** Problems pertaining to surface ships, submarines, and aircraft were carried out.

The passage of time witnessed work on a succession of new phases of these subjects. The exploitation of the radio-frequency "pulse" principle brought about radar and the radio identification of targets (IFF), which became major parts of the radio program. The work on radio control led to the development of guided missiles. Although prior work had been done, the incidence of World War II resulted in an extensive and continuing effort in radio countermeasures, including interception, source location, jamming and deception. As the amount of radio-electronic equipment aboard ship grew to unmanageable proportions, efforts were directed to its consolidation through multiplexing and systems integration. **Throughout the years, a great deal of effort was devoted to new components and materials, since these have been found to be a key to important advances in equipment and systems.** New phases of these various subjects have continued to be parts of the Laboratory's program.

## ESTABLISHMENT OF NRL

### REFERENCES

1. G.S. Bryan, RADM, "The Naval Hydrographic Office," U.S. Naval Inst. Proc. Nov. 1946, pp. 1395-1403
2. G.A. Weber, "The Naval Observatory—Its History, Activities and Organization," 1926, Navy Dept. Library Ha 58 W 374
3. "Report of the Secretary of the Navy for 1885," pp. 33,34, Navy Dept. Library
4. Edward Marshall, "Edison's Plan for Preparedness," The New York Times Magazine, Sunday, 30 May 1915
5. "Naval Consulting Board of the United States," Lloyd N. Scott, Liaison Officer to the Board, Government Printing Office, 1920, NRL Library 359.0072.S 427 (Ref)
  - a. pp. 109-113, 226
  - b. pp. 14,15
  - c. pp. 67-81
  - d. pp. 109-113
6. "The Naval Consulting Board—Origin, Formation, and Activities, During the World War," Navy Dept. Library NA 1d N327
7. "Hearings Before Committee on Naval Affairs House of Representatives," 15 Mar. 1916, No. 50, pp. 3343-3364, see "NRL Legislative History, 1916-1942," NRL Library 359.0072.N3189 (Ref)
8. Public Law 241, approved 29 Aug. 1916, H.R. 15947, 64th Congress, First Session, Chapter 417, 1916, p. 570, Vol. 39, Part 1, Public Laws
9. Public Law 391, approved 4 Mar. 1917, H.R. 20632, 64th Congress, Second Session, 39 Statutes 1168 to 1179
10. "Hearing Before Subcommittee of House Committee on Appropriations," Navy Dept. Appropriation Bill for 1926, 68th Congress, Second Session, 9 Dec. 1924, see "NRL Legislative History, 1916-1942," NRL Library 359.0072.N3189 (Ref)
  - a. pp. 890-895
  - b. p. 890
11. A. Hoyt Taylor, "The First 25 Years of the Naval Research Laboratory," NRL Library 359.0072T2381 (Ref)
  - a. p. 4
  - b. p. 2
12. Letter to Secretary of the Navy, dated 1 Oct. 1919, and 1st endorsement from SecNav to Bureaus of Yards and Docks, Ordnance, Construction and Repair, and Steam Engineering letter dated 20 Oct. 1919, copy in NRL file S67/A-1, "Plans, Projects and Policies," National Archives; also see "The Establishment and Organization of the Naval Research Laboratory," NRL Library 359.0072.N318211 (Ref)
13. NRSR, 1 Sept. 1920, pp. 91-92; also see A. Hoyt Taylor, "The First 25 Years of the Naval Research Laboratory," NRL Library 359.0072T2381 (Ref)
14. "Report of the Secretary of the Navy, 1920," p. 525, Navy Dept. Library
15. Letter of 13 Sept. 1921, from Secretary of the Navy, Honorable Edwin Denby to RADM W.S. Smith, NRL file S67/A-1, "Plans, Projects and Policies," National Archives; also see "The Establishment and Organization of the Naval Research Laboratory," NRL Library 359.0072.N318211 (Ref)
16. NRSR, 1 Sept. 1920, pp. 91-92
17. Bureau of Engineering memorandum of 12 Feb. 1923, "Centralization of Radio and Sound Research and Development at the U.S. Naval Research Laboratory at Bellevue," copy in NRL file S67/A-1, National Archives; also see "The Establishment and Organization of the Naval Research Laboratory," NRL Library 359.0072.N318211 (Ref)
18. NRSR, 1 June 1923, p. 36
19. Naval Research Laboratory Station Journal, 1923-1931, p. 3, see NRL Technical Information Div.
20. Navy General Order No. 84, issued 25 Mar. 1922, for Navy General Order, see "General Orders, Navy Department, 1913-1941," Navy Dept. Library Na. 1.U:N327 GO, 1913-1941; also see "The Establishment and Organization of the Naval Research Laboratory," NRL Library 359.0072.N318211 (Ref)
21. Hearings of the Subcommittee of the House of Representatives on Navy Dept. Appropriations for FY 1923, held on 23 Mar. 1922, p. 879, see "NRL Legislative History, 1916-1942," NRL Library 359.0072.N3189 (Ref)
22. Navy General Order No. 182, 13 Nov. 1928, Navy Dept. Library; also see "The Establishment and Organization of the Naval Research Laboratory," NRL Library 359.0072.N318211 (Ref)
23. Second Endorsement. Ltr from the Judge Advocate General to the Secretary of the Navy, NP14/A3-1(6) (311022) 3 Nov. 1931, Navy Dept. Library; also see "The Establishment and Organization of the Naval Research Laboratory," NRL Library 359.0072.N318211 (Ref)
24. Naval General Order No. 223, 5 Nov. 1931, Navy Dept. Library; also see "The Establishment and Organization of the Naval Research Laboratory," NRL Library 359.0072.N318211 (Ref)
25. Third Endorsement, General Board, G. B. No. 410 (Serial No. 1556) from Senior Member Present to the Secretary of the Navy, 9 Feb. 1932, Navy Dept. Library; also see "The Establishment and Organization of the Naval Research Laboratory," NRL Library 359.0072.N318211 (Ref)
26. Hearings of the Subcommittee of the House of Representatives on Navy Department Appropriations for FY 1933, held 1-4 Mar. 1932, pp. 438-443, 505-520; "NRL Legislative History, 1916-1942," NRL Library 359.0072.N3189 (Ref)
27. Bureau of Engineering letter to Director, NRL, NP14/N83-22-Ds), 9 Apr. 1932, "Bureau Policy Concerning Organization and Administration of the Naval Research Laboratory," NRL's letter in reply dated 12 Apr. 1932; copies in NRL file S67/A-1, National Archives; also see "The Establishment and Organization of the Naval Research Laboratory," NRL Library 359.0072.N318211 (Ref)
28. Bureau of Engineering letter NP14 (6-27-Ds), 4 Aug. 1932; see "The Establishment and Organization of the Naval Research Laboratory," NRL Library 359.0072.N318211 (Ref)
29. Bureau of Engineering letter to Director, NRL, NP14(6-27-W1), 29 Dec. 1933; see "The Establishment and Organization of the Naval Research Laboratory," NRL Library 359.0072.N318211 (Ref)
30. Navy General Order No. 41, 13 May 1935, see "Navy Department General Orders (1935-1948)," Navy Dept. Library 1 Na GO, U:N327, C3 (1935-1948); also see "The Establishment and Organization of the Naval Research Laboratory," NRL Library 359.0072.N318211 (Ref)
31. Navy General Order No. 124, 14 Sept. 1939, Navy Dept. Library; also see "The Establishment and Organization of the Naval Research Laboratory," NRL Library 359.0072.N318211 (Ref)
32. Letter from the Secretary of the Navy to the Chief of Naval Operations, 1 Nov. 1939, "Organization and Administration of the Naval Research Laboratory, Policy Concerning," see "The Establishment and Organization of the Naval Research Laboratory," NRL Library 359.0072.N318211 (Ref)
33. Hearings of the Subcommittee of the House of Representatives

## ESTABLISHMENT OF NRL

- on Navy Department Appropriations for FY 1941, pp. 693-694; see "NRL Legislative History, 1916-1942," NRL Library 359.0072.N3189 (Ref)
34. Navy General Order No. 130, issued 8 Dec. 1939, Navy Dept. Library; also see "The Establishment and Organization of the Naval Research Laboratory," NRL Library 359.0072.N318211 (Ref)
  35. J.A. Furer, RADM, "Administration of the Navy Department in World War II, NRL Library 359.690.F983 (Ref)
    - a. p. 755
    - b. pp. 761-772
    - c. pp. 775-776
    - d. pp. 779-796
  36. H.G. Bowen, VADM, "Ships Machinery and Mossbacks," pp. 165-166, 176-178, Princeton Univ. Press, Princeton, NJ., 1954
  37. Navy General Order No. 150, 12 July 1941, Navy Dept. Library; also see "The Establishment and Organization of the Naval Research Laboratory," NRL Library 359.0072.N318211 (Ref)
  38. Navy General Order No. 219, 19 May 1945, cancelling Nos. 150 and 159; Secretary of the Navy letter OGC/H.H., hg/vc, 19 May 1945; also see "The Establishment and Organization of the Naval Research Laboratory," NRL Library 359.0072.N318211 (Ref)
  39. Public Law 588, 79th Congress, approved 1 Aug. 1946
  40. Hearings of the Subcommittee of the House of Representatives on Navy Department Appropriations for FY 1924, held 12 Jan. 1924, pp. 843-849; see "NRL Legislative History, 1916-1942," NRL Library 359.0072.N3189 (Ref)
  41. A. Hoyt Taylor, "The First 25 years of the Naval Research Laboratory," p. 14, NRL Library 359.0072T2381 (Ref)
  42. A. Hoyt Taylor, "Radio Reminiscence: A Half Century," p. 104, NRL Library 359.0072T238 (Ref); see also Naval Research Laboratory Station Journal, 1923-1931, in NRL Technical Information Div.
  43. Hearings of the Subcommittee of the House of Representatives on Navy Department Appropriations for FY 1929, held 10 Mar. 1928, pp. 1077-1088; "NRL Legislative History, 1916-1942," NRL Library 359.0072N3189 (Ref); also Naval Research Laboratory Station Journal, 1923-1931, in NRL Technical Information Div.
  44. Hearings of the Subcommittee of the House of Representatives on Navy Department Appropriations for FY 1931, held 5 Mar. 1930, pp. 939-952; "NRL Legislative History, 1916-1942," NRL Library 359.0072N3189 (Ref)
  45. Hearings of the Subcommittee of the House of Representatives on Navy Department Appropriations for FY 1933, held 4 Mar. 1932, pp. 505-520; "NRL Legislative History, 1916-1942," NRL Library 359.0072N3189 (Ref)
  46. NRL Station Regulations, 1 July 1937, NRL File A2-5 in National Archives; "NRL Legislative History, 1916-1942," NRL Library 359.0072N3189 (Ref)
  47. Personnel Complement, Monthly Report, 1 Sept. 1945; NRL File P-16-1, see NRL CRMO; A.T. Drury, "War History of the Naval Research Laboratory," NRL Library 359.0072.D796 (Ref)
  48. "Establishment of Aircraft Electronics Division at NRL," Navy Department Bureau of Aeronautics letter to Director NRL, 29 May 1945; NRL File C-F42-1/A1, Folder 4; Federal Records Center, File No. JO 11101, Records Group 181
  49. "Reorganization of Radio Divisions," Laboratory Order 41-46, 26 Nov. 1946, NRL File A3-2(8), Folder 5; Federal Records Center, File No. JO 11704, Records Group 181, Location 9/76:25-2
  50. "Reorganization of Naval Research Laboratory to Accommodate a Director of Research," Chief of Naval Research Letter to Director, NRL EXOS:ONR 100, Serial 8491, 14 May 1948, NRL File A1, Folder 7; Federal Records Center, File No. JO 11704, Records Group 181
  51. "Deputy Director, Abolishment of Position and Title of," Laboratory Order 9-49, 4 Feb. 1949, NRL File A3-2(8), Folder 7; Federal Records Center, File No. JO 11704, Records Group 181, Location 9/76:25-2
  52. "Director of Research (Acting) - Appointment of," Laboratory Order 8-49, 28 Jan. 1949, NRL File No. A3-2(8), Folder 7; Federal Records Center, File No. JO 11704, Records Group 181, Location 9/76:25-2
  53. "Organizational Changes," Laboratory Order 66-52, 24 Dec. 1952, NRL File No. A2-6/1, Folder 1, NRL Branch Identification No. 1616-71/52; Federal Records Center, File No. JO 16288, Records Group 181, Location 19/41:13-1
  54. "Establishment of Scientific Program and Organization Committee," NRL Instruction 3927.1, 17 June 1953; available in Office of Management Engineer
  55. O.T. Marzke, E.H. Krause, and R.M. Page, "Review of the Scientific Program and Organization of NRL," NRL Report 4300, Jan. 1954
  56. "Research Department Organization," NRL Instruction 5400.3, 17 Feb. 1954; available in Office of Management Engineer
  57. "Organizational and Personnel Changes in the Research Department," NRL Notice 5400, 18 Feb. 1966, available in Office of Management Engineer
  58. "Organizational Changes in the Research Department," NRL Notice 5400, 29 Sept. 1966; available in Office of Management Engineer
  59. "Radio Division (Code 5400); redesignation of," NRL Notice 5400, 16 Aug. 1968, available in Office of Management Engineer
  60. "Reorganization of the Research Department," NRL Notice 5400, 1 Sept. 1967; available in Office of Management Engineer
  61. "Laboratory Organizational Changes," NRL Notice 5400, 19 Feb. 1971; available in Office of Management Engineer

## Chapter 3

# RADIO COMMUNICATION

### INTRODUCTION

Since its establishment, NRL has conducted the Navy's principal in-house research program in radio communication. This program, through the ensuing years, has provided the Navy with the technical basis for continually improving its radio-communication capability. In the high-frequency (HF) band, NRL's pioneering work in radio propagation, quartz-crystal frequency control, antennas, power generation, reception techniques, security, and equipment development led to the adoption and extensive utilization of HF by the Navy. As the Laboratory was able to determine propagation characteristics and to devise means of power generation, radiation, reception, and control at increasingly higher radio frequencies, the Navy was able, successively, to utilize these frequencies, which became known as the very-high (VHF), ultra-high (UHF), and super-high (SHF) frequency bands. The Laboratory's original work in satellite communication resulted in the Navy's establishment of the world's first satellite-communication system. NRL's continuing satellite-communication program has served to further advance the Navy's operational capability. At the other end of the frequency spectrum, the very-low-frequency band (VLF), the Laboratory has conducted a research program which has continued to enhance the Navy's capability for communication with its submarines wherever they might be on the high seas, and particularly when they are submerged. There is hardly an installation of Naval radio communication equipment afloat, aloft, or ashore that does not incorporate some NRL contribution.

### COMMUNICATION IN THE HIGH-FREQUENCY BAND

That part of the radio-frequency spectrum known as the high-frequency band (2 to 30 MHz) is of major importance to the Navy today, since it continues to carry the great bulk of its radio-communication traffic. The exploration of this frequency band was a major phase of the Laboratory's initial effort, an effort which has continued for many years in order to obtain the maximum capabilities of the band.

#### Radio Propagation

When the Laboratory began its radio program in 1923, the Navy's longer range radio-communication circuits and those of commercial interests were established on the medium and lower frequency channels (below 600 kHz). The Navy had made very little use of the higher frequencies, although it had planned to use the 600 to 1250 kHz band for short-range intrafleet communication. As previously described, members of NRL's staff had demonstrated the possibilities of this frequency band for long-distance transmission. However, Navy officials responsible for operations considered the diurnal and seasonal performance of these higher frequencies to be so erratic and unreliable as to make them operationally unacceptable for use over long distances. Indeed, in issuing instructions for the operation of new intrafleet communication equipment under procurement and intended for short-distance use, stress was placed on the need to take care to minimize transmitter power at

the higher frequencies to avoid possible interception by a potential enemy over long distances through "freak transmission conditions."<sup>1</sup>

During the early 1920's the public interest in radio broadcasting had grown to such an extent that many of the channels in the intrafleet frequency band became occupied by broadcasting stations.<sup>2</sup> Considerable political pressure was brought to bear upon the Navy to relinquish its use of this band. To this, the Navy after vigorous objection reluctantly agreed.<sup>3,4</sup> The frequency band from 550 to 1500 kHz, then became known as the "radio-broadcast band." As a result, the frequencies above this band would have to be used if substantial naval communication channel expansion were to be effected.

Prior experience had convinced the Laboratory's staff that when the propagation characteristics of the higher frequencies were better known, their utility in serving the Navy for long-range communication would be manifest. In order to obtain the evidence necessary to convince the Navy of their value, transmitting and receiving equipments at progressively higher frequencies were developed. In seeking observers to obtain propagation data on transmissions, the cooperation of radio amateurs throughout the United States and abroad was sought and obtained. These amateurs had increased rapidly in number and, although restricted by the Federal law of 1912 to the use of frequencies above 1500 kHz, had developed considerable competence around this frequency limit. To increase their effectiveness these amateurs were aided by the Laboratory in improving their equipment for operation at increasingly higher frequencies. Through their splendid cooperation, extensive propagation data were acquired at frequencies up to the limit of influence of the ionosphere.<sup>5,6</sup>

Study of the data revealed that signals which disappeared after the "ground wave" was dissipated would reappear at a considerable distance which would vary with frequency, time of day, and season. This phenomenon, named the "skip-distance effect," was not accounted for by the earlier ionospheric-wave propagation theories suitable for the lower radio frequencies. NRL

then devised propagation theory involving equations based on the free-electron density distribution in the ionosphere and on classical formulas of magneto-optics containing a critical frequency term which adequately explained the high-frequency "skip-distance effect" and which agreed with the experimental data (1925).<sup>7a,8,9,10,11a,12,13,14a,15,16</sup> This work laid the foundation for HF wave propagation theory.

During 1925, a new method of studying the characteristics of the ionosphere was employed, using HF pulses reflected from its conducting layers. The heights of the layers were obtained through determination of the time elapsed in transit over the path. Means for generating short, high-power, HF pulses were devised. Oscillographic recordings of the received HF pulses reflected from the ionosphere gave unique positive proof, for the first time, of the existence of its layers and data on its reflection characteristics (first observations, 28 July 1925 on 4200 kHz).<sup>17-20</sup> This HF pulse technique, first used in measuring the heights of ionospheric layers, was later applied by NRL in its development of radar for range determination. The radio-transmission characteristics of the ionosphere were investigated relative to diurnal variations, the influence of magnetic disturbances, and correlation with solar flares. This work was done collaboratively with the Carnegie Institute of Washington.

The pulse method has been in continual use and is currently employed by the many ionospheric sounding stations throughout the world in observing the properties of the ionosphere over the HF band and in obtaining data on which to base predictions of its future condition as influencing circuit performance. These predictions have been of considerable value in the selections of the radio-frequency channels best suited for particular communication circuits.

Other HF phenomena were uncovered in NRL's propagation work (1925-1928). The existence of additional "transmission zones" and corresponding "skip zones" at progressively greater distances from the transmitting

## RADIO COMMUNICATION

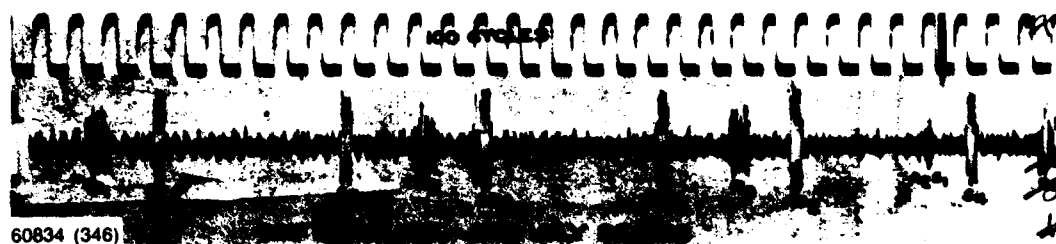

"ROUND-THE-WORLD" RADIO TRANSMISSIONS

NRL was first to make recordings of these phenomena of which this is typical (1928).  $S_1$ ,  $S_2$ , and  $S_3$ , are pulses initiated by NRL's transmitter.  $R_1$ ,  $R_2$ , and  $R_3$ , are echoes or "splashback" returns from the first reflection zone via the ionosphere.  $AS_1$  and  $AS_2$  are received pulses which have travelled around the world.  $A_2S_1$  is a received pulse which has circled the world twice. The upper recording is a 100-cycle timing wave. The observations on "splashback" returns generated the first concept leading later to "over-the-horizon" (OTH) radar.

source due to successive refractions by the ionosphere and reflections at the earth's surface was verified. NRL demonstrated that round-the-world HF transmissions could be obtained through successive reflections from the ionosphere with the proper choice of frequency, time of day, and season (1926). Encirclement of the globe not only once but as many as three times in the same transmission and in both directions was observed (1926). At the same time, reflections of the pulsed HF transmissions from earth surface prominences, called "splashbacks," were first observed. Splashback echoes from the first, second, and third reflection zones were identified. The conditions associated with these phenomena and the interference they might cause in the use of HF circuits were determined. The transit time of the splashback transmissions provided a means of determining the distance of the prominences from the point of transmission (1926). These observations of HF splashbacks generated the first concept of detecting and ranging on targets over very long distances, using two-way reflections of HF pulses by the ionosphere. This concept led to the later development of "over-the-horizon" (OTH) radar.<sup>9,21-23</sup> To provide recording of the transmissions and timing, a high-speed oscillograph was devised comprising a rapidly rotating drum carrying a

photographic film with a lightbeam-galvanometer type sensor.

The results of NRL's propagation work permitted useful prediction of the performance of the ionosphere at HF under various operational conditions; this capability was important to the Navy's acceptance of these frequencies. To aid the Navy's operating forces in using HF circuits, charts were prepared based on the results obtained which were used in selecting the most favorable radio-frequency channels for specific transmission paths.<sup>7a,b,100,110,140</sup>

### The Navy's Adoption of High Frequencies

In addition to its views as to the erratic nature of high frequencies, the Navy also questioned the feasibility of making the frequent changes in channel assignment required to maintain circuit continuity in contending with the diurnal changes in propagation path and varying transmission distances. At the lower frequencies the Navy had assigned channels with the assumption that these designations would hold over long periods. The Navy was concerned that the technical and disciplinary difficulties involved in making the frequent channel changes required by HF might cause unreliability and delay which could be disastrous in the midst of important operations.

To instill confidence in the feasibility of using high frequencies for operational functions, a

## RADIO COMMUNICATION

series of demonstrations was carried out. High-frequency transmitters and receivers were developed by NRL and installed on several classes of ships and at shore stations. Quartz-crystal frequency control had reached a stage of development warranting incorporation in some of these equipments, to insure frequency stability and channel adherence. These HF equipments were used on a variety of Navy communication circuits during various types of operations. During October 1924, the Navy's great dirigible, the USS SHENANDOAH, made its historic transcontinental trip from Lakehurst, New Jersey, to the west coast and return, and established contacts with many stations

throughout the nation with HF equipment provided by the Laboratory.<sup>24</sup> Interest in this demonstration was widespread. Naval Radio Communication Control, Navy Department, Washington, used the 10-kW HF transmitter located at the Laboratory through remote radio control for a period of a year beginning December 1924. This station handled official Navy communication traffic with Panama, Canal Zone, London, and San Diego, California, particularly at times when the low-frequency, 500-kW, arc transmitter at the Navy's radio station, Annapolis, Maryland could not be received due to heavy atmospherics.<sup>25</sup> The results of these and many other demonstrations impressed the Navy with

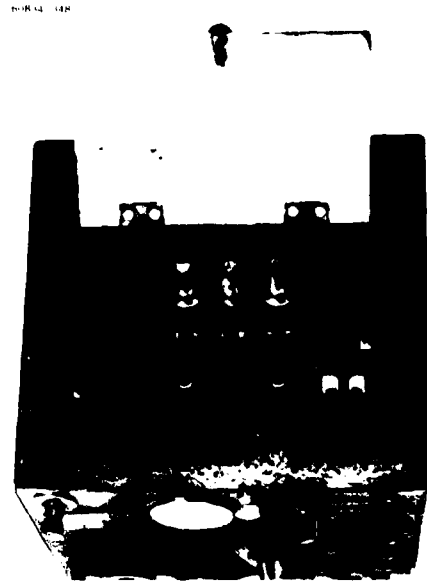
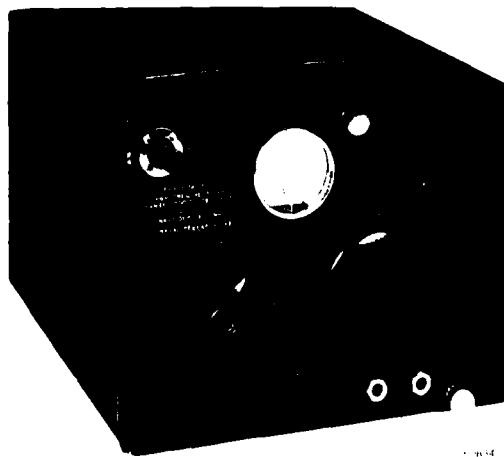

HISTORIC USS SHENANDOAH HF COMMUNICATION (1924)

An important factor in the Navy's adoption of high frequencies was the performance of the NRL-developed HF transmitter and receiver carried by the Navy's great dirigible during its sensational trip from Lakehurst, New Jersey to the west coast and return in October 1924. This equipment accomplished the then unusual feat of remaining in communication with NRL throughout the entire trip. Contacts were also made with many radio stations throughout the country. The transmitter was capable of both voice and keyed operation on 3332 kHz with a power output of 50 watts. The receiver employed three N tubes and covered a frequency range of 2000 to 6000 kHz. The receiver shown here was similar to the receiver used, but with extended frequency range. It was aboard the USS Shenandoah during the disaster, which occurred in a severe storm over Ohio on 3 Sept. 1925. The receiver was salvaged in good condition. The tubes shown are type "N," the first successful "Miniaturized" tubes.

## RADIO COMMUNICATION

the superior capabilities of high frequencies as compared with the performance of the lower frequencies. The important advantages attainable in long-range communication with relatively low power, with compact, light equipment, and at relatively low cost provided a powerful incentive for the Navy's acceptance of the high frequencies. However, it was the pressing need for more frequency channels and the experience of high command with high frequencies that brought about official acceptance.

On 1 July 1922, the Navy consolidated its then existing Atlantic and Pacific Fleets into a single U.S. Fleet composed of four elements: the Battle Fleet, the Scouting Fleet, the Control Force, and the Fleet Base Force. The newly organized Fleet engaged in exercises during the winter of 1922-1923 which, as reported by the Commander-in-Chief on March 1923, disclosed that communications within the Fleet and between the Fleet and the Navy Department were neither satisfactory nor reliable.<sup>26</sup>

During World War I, the primary need for communication had been that between the United States and Europe, accomplished as stated previously. The communication needs for operations at sea were limited to convoy protection, antisubmarine actions, and the broadcasting of intelligence, meteorological, and hydrographic information. The new Fleet organization made necessary radio circuits between the Navy Department, the Commander-in-Chief, Fleet and Force Commanders, Sub-commanders, and all ships, thus greatly increasing the total number of channels required. Simultaneous operation of several transmitting and receiving circuits aboard a ship had to be provided for many ships. Experience in the Fleet exercises had shown that arc and spark transmitters created such interference that simultaneous reception aboard the same ship was practically impossible when they were used, and they had to be abandoned. It was the Navy's good fortune that high-frequency techniques had then reached a state of development which could provide the greatly increased capability needed.

During the summer and fall of 1925, the U.S. Fleet engaged in maneuvers in the vicinity of Hawaii and then cruised to Australia and New Zealand. Considerable success was experienced during this trip in maintaining communication directly with Washington using high-frequency equipment installed on the flagship, USS SEATTLE, working with that located at NRL.<sup>27a</sup> At Melbourne, for a period of ten days, traffic was handled on high frequencies which was found impossible at the low frequencies due to the presence of heavy atmospherics not affecting HF. Convinced of their utility, the Commander-in-Chief, U.S. Fleet, then ADM R. E. Coontz, in his report to the Chief of Naval Operations dated 16 Sept. 1925, in view of the results obtained with high frequencies by the USS SEATTLE on the Australian cruise recommended that all flagships of the Fleets and Forces, all cruisers and all high and medium power radio stations be provided with HF equipment.<sup>27b</sup> On 5 Nov. 1925, the Bureau of Engineering, based on NRL's extensive efforts, made a final decision to include HF equipment in the Navy's Radio Modernization Plan, then being revised, greatly extending planned HF installations beyond the original recommendations.<sup>28</sup>

### Radio-Frequency Channel Allocation

The advent of high frequencies introduced a new aspect in the problem of radio-frequency channel allocation requiring reconsideration of previous allocations based on the properties of the lower frequencies. It was evident that high frequencies could cause interference over great distances and that the low cost of installation would make their use attractive to many interests. Frequency allocation would, henceforth, have to be accomplished from a worldwide viewpoint. Accordingly, the Bureau of Engineering, based on NRL's work and with its assistance, prepared a new frequency-allocation plan which included the high-frequency band. This plan was adopted by the nations of the world and, for the first time, established order





60834 (349)

**NRL EXPERIMENTAL HIGH-FREQUENCY  
CRYSTAL-CONTROLLED TRANSMITTER**

This transmitter was first to communicate with Australia on 15,000 kHz. It handled traffic directly with the U.S. Fleet flagship, USS SEATTLE, during the cruise of the Fleet to Australia in 1925, a demonstration which contributed importantly to the Navy's adoption of high frequencies. L. C. Young, shown here, who developed the equipment, was Associate Superintendent of NRL's Radio Division during the period 1936-1945.

in the utilization of the radio-frequency spectrum (1929). NRL's propagation work had shown that such a plan had to take into account the diurnal and seasonal effects with respect to distance and frequency. Its work on quartz-crystal frequency control, to be reviewed subsequently, had shown the need to have frequency assignments for stations harmonically related for effective transmitter design. The Navy's plan received the approval of the Interdepartmental Radio Advisory Committee on 25 Feb. 1926.<sup>29</sup> The plan was submitted for consideration to the

Fourth International Radio Conference, convened in Washington on 4 Oct. 1927, and attended by representatives of 80 countries (the largest international conference in history up to that time). At that time the frequency stability maintained by a large percentage of the world's radio stations did not exceed 0.1 percent. NRL had demonstrated the feasibility of maintaining a frequency stability of 0.01 percent over a period of several months, which if adhered to would make many more frequency channels available.<sup>30</sup> This demonstration permitted the

Navy to insist that the nations attending the conference accept higher stability. The conference agreed, stating in its regulations that "...Waves emitted by a station must be maintained upon their authorized frequency, as exactly as the state of the art permits..."<sup>31</sup>

The Navy's plan became the basis for the agreement of the conference on the allocation of radio-frequency channels and the control of emitted frequency.<sup>31</sup> The convention resulting from the conference became effective 1 Jan. 1929 for the ratifying governments. This agreement was of far-reaching importance, since it established order in the international use of the radio-frequency spectrum and made available a greatly increased number of frequency channels having worldwide clearance.

#### High-Frequency Equipment

General interest in high frequencies grew rapidly, and many demands were placed on NRL by both the Navy and outside interests for equipment for installation on ships, aircraft, and shore stations. Upon the approval of the Navy's Modernization Plan, the Laboratory was charged by the Bureau of Engineering with the development of the radio equipment necessary to meet its objectives. Demands for Fleet equipment became so pressing that interim measures were resorted to, such as the quick assembly of "breadboard" equipment and the provision of instructions to enable Fleet personnel to modify the Navy's first successful voice-communication equipment, the CW 936, which operated at the lower frequencies.<sup>32</sup>

Early high-frequency transmitters employed the master oscillator-power amplifier principle, which, while providing satisfactory frequency stability at the lower frequencies, was soon found to need improvement for operation at high frequency. Difficulty was experienced in maintaining a beat note of sufficient constancy with the main mode of operation, continuous-wave and heterodyne reception. The lack of rigidity of components, changes in their characteristics due to temperature variations, and

changes in antenna properties and power-supply voltages were major causes. Nationwide attention was drawn to the difficulty in the transcontinental trip of the dirigible USS SHENANDOAH, previously referred to, during which wild excursions of the beat note resulted from the swinging of the trailing-wire antenna when underway.

#### Intrafleet HF Equipment

To provide improved frequency stability, NRL, in its development of the first intrafleet equipment for the newly adopted frequency band, 2000 to 3000 kHz, provided components of maximum rigidity and constancy and which used relatively low coupling between master and amplifier circuits (1923). To minimize the influence of antenna variations the transmission line, matched at both ends, to feed the transmitter output to the antenna was introduced. This combination provided frequency stability considered acceptable in the assigned frequency band at that time.<sup>33,34</sup> Experimental models (100 watts output) were given service tests on the USS CALIFORNIA and USS TENNESSEE and were reported to "exceed expectations" (1924). Patterned after NRL's design, 110 of these equipments were obtained from commercial manufacturers and installed on battleships, cruisers, and destroyers. These equipments became known as Models TV, TW, and TX (varying in power supply voltages), and were the first to provide effective intrafleet communication. Later, they were modernized through the incorporation of quartz-crystal frequency control and gave service over an extended period.<sup>35,37</sup>

#### Piezoelectric (Quartz) Crystal Frequency Control

Experience with existing methods of frequency control made evident that if the Navy were successfully to use the higher frequencies, new means of control would have to be devised. Accordingly, NRL initiated its investigations

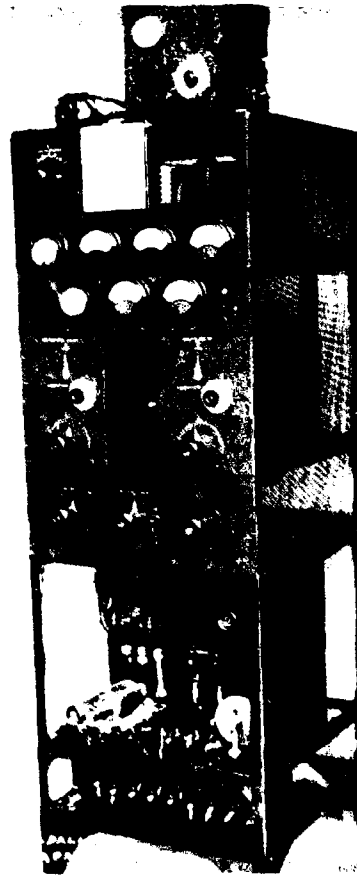

FIRST INTRAFLEET EQUIPMENT FOR THE NEWLY ADOPTED FREQUENCY BAND OF 2000 TO 3000 KHZ, THE MODEL TV (1923)

This equipment, developed by NRL, provided frequency stability through components of maximum rigidity and constancy and the use of relatively low coupling between master oscillator and amplifier circuits. The particular transmitter shown was installed on the USS DALLAS

of quartz crystal-controlled vacuum-tube oscillators (1924).<sup>38,39,40a,41</sup> That phase of the work concerned with the direct control of the frequency of transmitter output resulted in the development of a highly stable circuit with good output in which the crystal was connected between grid and cathode of a triode with an

inductively reactive, near-resonant output circuit.<sup>42</sup> The circuit limited the frequency of oscillation to a single crystal mode. **This quartz-crystal oscillator circuit developed by NRL, with frequency stability adequate for operational use over the high-frequency band, became the Navy standard crystal-controlled**

oscillator circuit (1924).<sup>43a</sup> It was used extensively for control of transmitter output. Since the mounting elements in contact with the crystal had some influence on its frequency, crystal holders were developed which minimized the "load" on the crystal while physically restraining it to avoid changes due to vibration. These became the Navy standard crystal holders for ships and aircraft and were used for many years.<sup>43b</sup> To obtain the highest possible degree of frequency stability with crystals, which were found to change slightly with temperature, precise temperature control was provided for the groups of crystals necessary to give the several frequency channels required in the equipment.<sup>43c,44</sup>

Studies of crystal structure relative to frequency stability and power output resulted in the determination of the best mechanical mode and the most effective "cuts" with respect to crystal axes.<sup>45-47</sup> Of all likely crystalline materials, alpha quartz, having a doubly refracting, asymmetric atomic structure, was found to have superior oscillator properties. **NRL discovered that if the quartz crystal were cut at the proper angle relative to its axes, a "zero frequency-temperature coefficient" could be obtained (1924).**<sup>48</sup> However, at that time, to take advantage of its high power output for transmitter control, the "X-cut," in which the surface of the crystal is normal to the X axis, was used. Its use in Navy equipment extended through a considerable period.

Since many crystals were required by the Navy, and since quantity production methods were unknown, NRL developed practical crystal-grinding and rapid frequency-adjusting techniques which expedited manufacture at reasonable cost. The Laboratory became the sole supplier of finished quartz crystals until June 1932, when this responsibility was transferred to the Optical Shop of the Washington Navy Yard. The Yard later was relieved of this task when commercial production became available. Some Navy activities still prepare special crystals.

During World War II existing means of production were found incapable of meeting the

tremendous demand for quartz crystals. To relieve this situation, NRL devised a tube counter-x-ray-spectrometer technique which provided an accurate, rapid, and reliable method of determining the optical axis of quartz adaptable to the production line. This development greatly accelerated fabrication, permitting the production goal to be attained and at substantially reduced cost (1942).<sup>49</sup>

### Crystal-Controlled Transmitters

The first crystal-controlled, high-frequency transmitter, developed by NRL early in 1924, was of relatively low power (about five watts). In increasing the power output, difficulty was encountered with self-oscillations generated in amplifiers, not experienced at the lower frequencies. These oscillations resulted from the increased effect at high frequencies of the coupling between output and input circuits due to the grid-anode capacity of the amplifier tubes (triodes) then available. A further difficulty resulting from this coupling was the loss of much of the power generated by the crystal oscillator, which, instead of performing its function of driving the input circuit of the first amplifier, was passed through the amplifiers and radiated by the antenna. In overcoming these difficulties the "balanced-amplifier" circuit was introduced, in which the voltage in the input circuit of the amplifier due to the grid-anode capacitive coupling was balanced by a voltage of opposite polarity induced in the input circuit by inductive coupling fed from the output circuit (1924). In addition, electromagnetic shielding of the critical parts of circuits was provided.<sup>49a,50</sup> These measures prevented amplifier self-oscillation and conserved crystal oscillator power, and also minimized undesirable radiation which resulted from keeping the oscillator running to insure stability during the "key-up" position of the normal "keyed" continuous-wave (CW) mode of operation.

High-frequency crystal-controlled transmitters incorporating the balanced-amplifier circuit were developed for various power output levels.

## RADIO COMMUNICATION

NRL's efforts resulted in the first high-power, high-frequency, crystal-controlled transmitter; a power output level of over 10 kW at 4100 kHz was attained on 3 Nov. 1924.<sup>40b,51,52</sup> This equipment was used extensively at 4200 kHz by the Navy Department for handling regular transoceanic and transcontinental communication traffic for a period of a year, beginning December 1924. Its successful operation over long distances and the high stability of its frequency helped greatly in

fostering Navy confidence in the operational utility of high frequencies. The Navy Department continued to use this and other higher frequency equipment provided by NRL in handling its communication traffic until the new facilities at the Navy's Radio Station, Arlington, Virginia, became available on 9 May 1927.

Another difficulty in developing crystal-controlled transmitters concerned the generation of output power above 6000 kHz, where the output of crystal oscillators declined rapidly.

30834 (345)

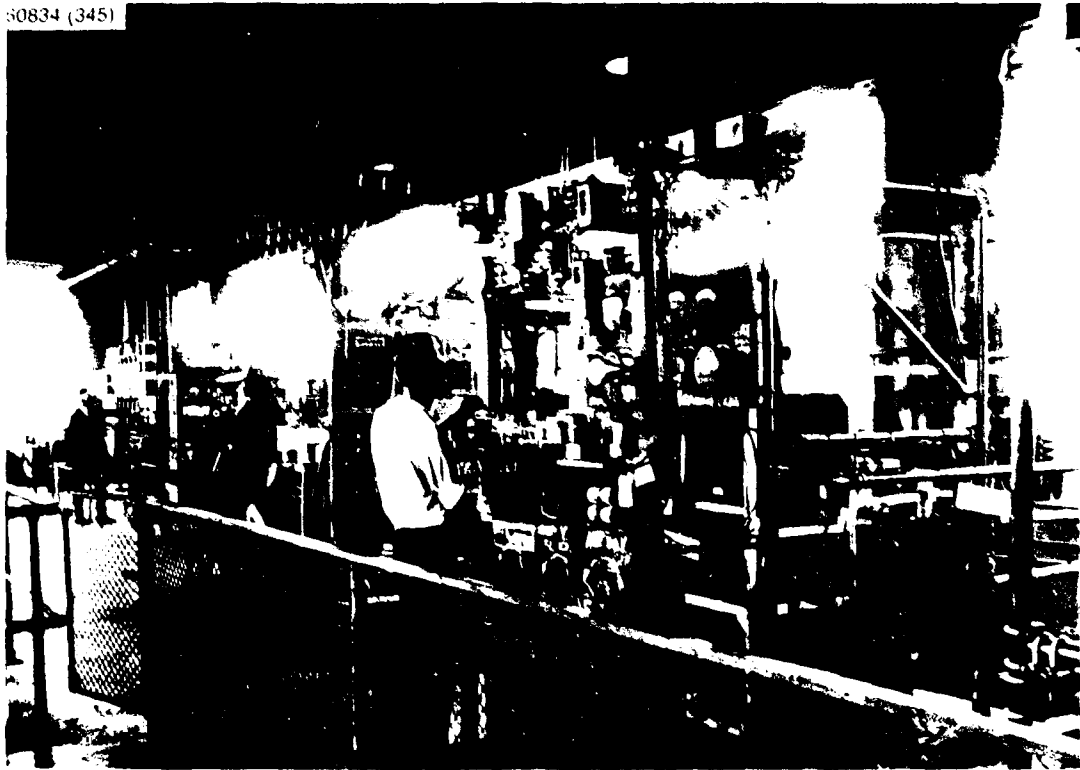

FIRST HIGH FREQUENCY, HIGH-POWER, CRYSTAL CONTROLLED TRANSMITTER

This equipment, developed by NRL, which provided 10 kW at 4200 kHz, was used by the Navy Department, under call letters NKE, to handle regular transoceanic and transcontinental communication traffic for a year, beginning in 1924. The transmitter was used to assess the operational utility of high frequencies. It played an important role in the Navy's eventual adoption of high frequencies. A high power 11,760 kHz transmitter is seen in the left background. The first proof of the existence of conducting layers in the ionosphere through the use of reflected radio pulses and the first determination of their height through measurement of the transit time of such pulses were accomplished with this transmitter (1925). This pulse transit time method of distance measurement was later used in radar. The author of this document is seen in the foreground.

## RADIO COMMUNICATION

To solve this problem, "doubling" and "tripling" amplifier circuits with means to suppress undesired harmonics were devised (1924).<sup>43e,53-55</sup>

### Shore Station High-Frequency, High-Power Transmitters

The remarkable results being obtained with high frequencies (1924) brought up the question of abandoning the Navy's many large and expensive arc transmitter installations. To obtain additional experience on which to base a decision, NRL was requested to provide a shore installation of a suitable high-power, high-frequency transmitter. At this time it also appeared

possible with high frequencies to obtain complete and continuous coverage of large ocean areas, such as the Atlantic, through simultaneous transmissions on several properly chosen frequencies, so that the Navy could broadcast messages to be received at the same time by its ships wherever they might be in the area. Coverage of the North Atlantic ocean area with high frequencies from shore was provided for the first time through NRL's development of a crystal-controlled transmission system, termed the Cornet Transmitter, which was installed at the Navy's Radio Station, Arlington, Virginia (NAA) for control by Naval Radio Central at the Navy Department (1926-1927).<sup>56-59</sup> The transmitter comprised four units,

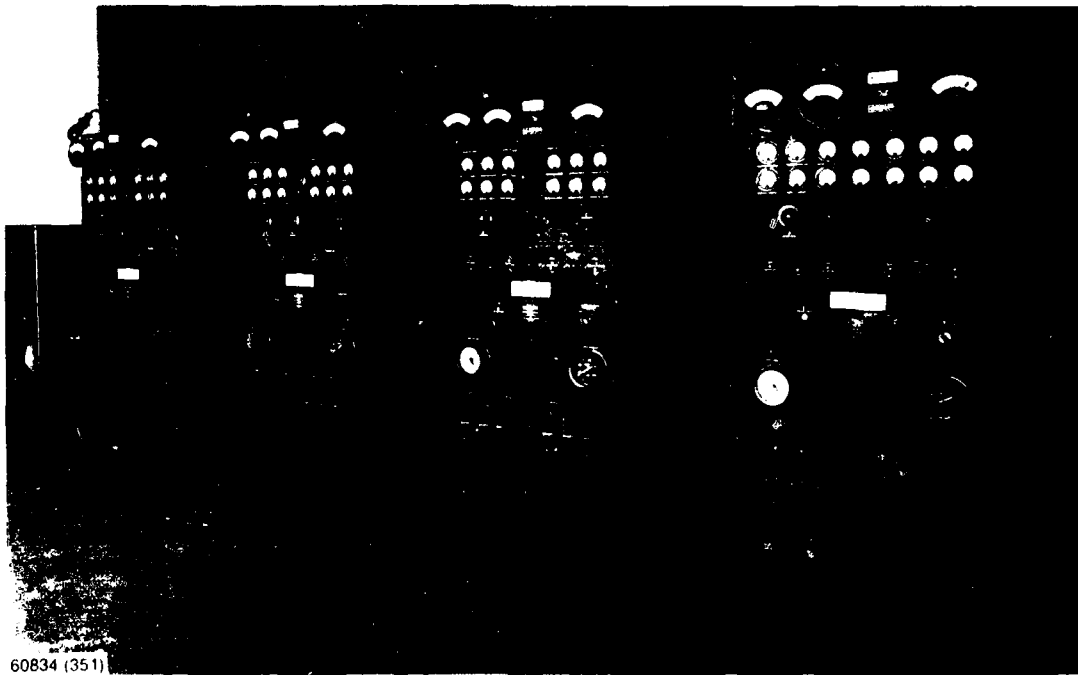

**THE "CORNET" HIGH-FREQUENCY, HIGH-POWER TRANSMITTER**

This transmitter, the Model XD, was installed at the Navy's radio station, Arlington, Virginia (NAA). It was controlled by Radio Central at the Navy Department and provided continuous coverage of the North Atlantic Ocean area through simultaneous broadcasts on four radio-frequency bands (units, left to right, operate at 4,000-4525, 8,000-9050, 12,000-13,500, and 16,000-18,100 kHz). The transmitter, developed by NRL (1926-1927), was the Navy's first high-power, high-frequency equipment suitable for regular operational use. It gave service over many years.

covering respectively the bands 4000 to 4525, 8000 to 9050, 12,000 to 13,650, and 16,000 to 18,100 kHz, which could be operated simultaneously or independently. The transmitter, also designated the Model XD, had a power output varying from 10 kW for the lowest frequency unit to 5 kW for the highest, a power level only 2 percent of that of the arc transmitter. This equipment gave satisfactory service for many years. The experience gained in its use was an important factor in the Navy's decision to abandon all of its arc installations.

The Navy was not able to interest commercial organizations in providing additional, urgently needed, high-power, high-frequency transmitters for its shore stations and requested the Laboratory to make them. Multichannel (4000 to 18,100 kHz) crystal-controlled transmitters of 5 kW output resulted. These equipments, designated Model XF, were installed at the Naval radio stations located at Mare Island, California (1927) and Darien, Panama Canal Zone (1928) and gave extended service.<sup>60-62</sup>

#### Ship High-Frequency Transmitters

The newly developed HF techniques were used in crystal-controlled transmitters, which, because of urgent demand, were made in quantities by the Laboratory (1925). These transmitters, developed by NRL, and designated Model XA, were the Fleet's first crystal-controlled high-frequency operational equipments (500 watts, 4000, 8000, 12,000 kHz bands). They were installed on ships such as the USS MEMPHIS, TEXAS, SEATTLE, CAMDEN, PITTSBURGH, PROCYON, ROCHESTER, TAMPA and WYOMING (1926-1928).<sup>63</sup> The USS MEMPHIS received the first equipment, which was tested on its trip to France during June and July 1926.<sup>64</sup> The Commanding Officer of the flagship, USS MEMPHIS, in reporting on the performance of the equipment to the Navy Department, stated that "...the new Model XA transmitter has given unusually good results and is practically the only means of communication that the MEMPHIS has. ...The



60834 (352)  
**THE FLEET'S FIRST CRYSTAL-CONTROLLED  
 HIGH-FREQUENCY TRANSMITTING  
 OPERATIONAL EQUIPMENT**

This equipment was designated the Model XA (500 watt, 4000, 8000, 12,000 kHz bands), a number were made by NRL and installed on ships to gain experience when operated by regular Navy personnel (1925).

other transmitters on the MEMPHIS are of practically no military value whatever and it is recommended that they be removed."<sup>65</sup>

At their request, the Coast Guard was furnished several Model XAs, their first HF equipments, which were used by them in the International Ice Patrol of the Atlantic during the 1926 season. The Coast Guard reported that with them their ships were, for the first time, "able to maintain direct communication with Washington," a performance beyond the capability of their lower frequency equipment and of importance to safety at sea.<sup>66</sup> Several equipments, modified for operation on alternating-current power supply, designated Model XB, were made for the Marine Corps (their first HF equipment) for communication with their foreign bases (1926).<sup>67</sup> At their request, the Signal Corps of the Army was furnished a Model XB, their first HF crystal-controlled communication equipment (1926), which they had duplicated in quantities and installed in their Army Communication Net, where a large amount of traffic was handled over a considerable period.<sup>68,69</sup>

The experience acquired in the use of the Model XA equipment aboard the different classes of ships convinced the Navy that high frequencies were capable of providing a reliable seaborne communication capability far superior in performance to that of the lower frequencies.

#### Ship High-Power, High Frequency Transmitters

In order to determine the power level appropriate for shipboard high-frequency installations, a 5-kW transmitter (Model XF-1), suitable for operation aboard ship, was developed and installed on the USS TEXAS (1929).<sup>69</sup> It was found that this high power level caused radio-frequency field intensities in the vicinity of the large guns so great that sparks could be drawn from them. The hazards involved in handling ammunition led to a decision to limit power to 1 kW. Furthermore, at this power level, the difficulties encountered in the use aboard ship of the water cooled tubes needed for the higher

power could be avoided through the use of available air-cooled tubes.

#### Submarine High-Frequency Transmitters

Radio communication from submarines had been unsatisfactory operationally until the late 1920's. The severely limited space aboard submarines forced the use of lower power and prevented the erection of antennas of sufficient size to radiate efficiently at the lower frequencies, so the performance of radio equipment on this class of ship was greatly inferior to that on larger ships. The low power and small antennas effective at high frequencies were attractive for such installations. To demonstrate the superiority of HF over the lower frequencies for submarine communication, NRL developed the Model XE crystal-controlled transmitter, the first submarine high-frequency equipment (1927-1928).<sup>70,71</sup> The Model XE included for the first time an important improvement in amplification made possible by the newly available screen-grid, four-element tube.<sup>72</sup> This tube contained an additional grid interposed between control grid and anode, which, held at the radio-frequency potential of the cathode, shielded the input and output circuits from each other. This shield prevented the coupling between these circuits which previously had caused trouble with self-oscillations. The General Electric Company provided early models of this tube, enabling the Laboratory to devise circuits which provided efficient amplification and greatly simplified HF transmitter construction and operation. The Model XE (2000 to 18,100 kHz) comprised a crystal-controlled oscillator (CW 1818 tube), an intermediate amplifier (two SE 3119, 75-watt tubes in parallel) and a power amplifier (one SE 3124, 750-watt tube). The transmitter was installed on the submarines V-1 and V-2 at San Francisco, and tests were carried out on a trip to Hawaii and return with good results (June 1928). At Hawaii communication was established, both day and night directly with Washington (NRL), a long-distance record for submarines. The forwarding endorsement of the



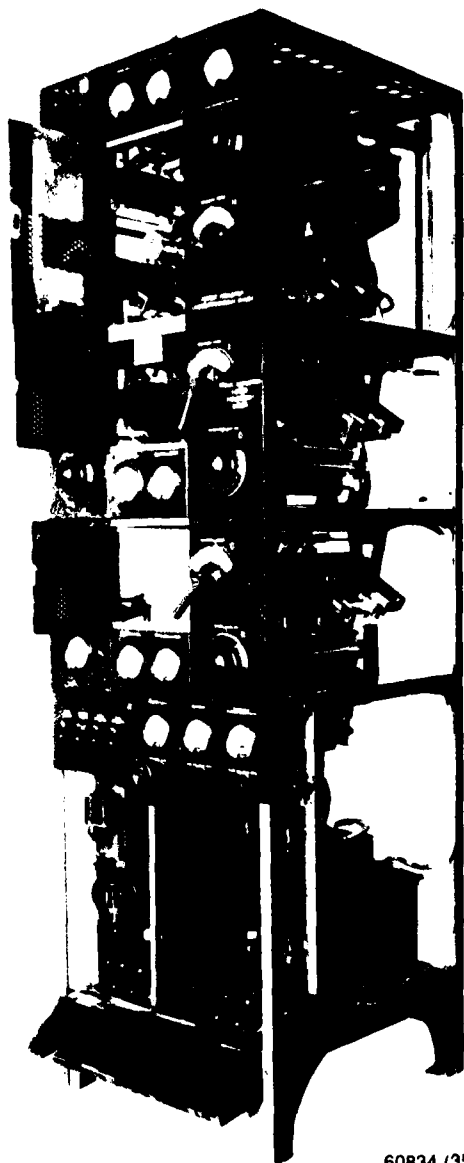

60834 (353)

#### THE FIRST SUBMARINE HIGH-FREQUENCY COMMUNICATION TRANSMITTER

This equipment, developed by NRL (Model XE, 2000 to 18,100 kHz), and installed on the V-1 and V-2 submarines, demonstrated the utility of high frequencies for submarine communication during Fleet trials in the Pacific Ocean (1928).

letter from the Commander Submarine Division, Battle Fleet, to the Navy Department reporting on the results obtained with the Model XE HF equipment stated, "The Commander-in-Chief, U.S. Fleet is pleased to forward subject report which is timely in that it demonstrates that high frequency equipment is essential to submarines for long distance daylight communication" (Aug. 1928).<sup>73</sup>

Although great difficulty was encountered during installation of the Model XE transmitter due to narrow passageways, the large V type submarines nevertheless had sufficient space to accommodate the equipment. To meet a demand for equipping the smaller and more numerous S type submarines, the Laboratory made a quantity of smaller but lower powered equipments designated the Model XK (March to May 1929). These comprised a crystal-controlled oscillator (CW 1818 tube), an intermediate amplifier (SE 3119, 75-watt tube), and a power amplifier (SE 3119, 75-watt tube) and covered a range of 4000 to 20,000 kHz. The equipments were installed on the submarines S-42, S-43, S-44, and S-46. During the patrol trials held by the Submarine Divisions of the Battle Fleet in November 1929, considerable propagation data were acquired with the XE and XK on ship-distances and performance at ranges out to 500 nautical miles on high-frequency transmission over sea water. Also, the minimum exposure of a submarine's periscope antenna above the surface of the sea, while otherwise running submerged, necessary for satisfactory communication with surface vessels was determined out to ranges of 500 nautical miles. About three feet was found to be adequate. Submerged-submarine communication under these circumstances with NRL's equipment was maintained out to 80 nautical miles. The Force Commander in his report pointed out the value of this submarine capability in wartime for submarines operating over wide patrol areas.<sup>74</sup>

The Navy, having relied upon medium frequencies for transmission from submarines, was

concerned whether high frequencies could perform all the necessary functions. Even though the space aboard its submarines was severely limited, it decided to equip them with both frequency bands combined into one equipment. However, when it sought quantity procurement of such equipment from major commercial companies, these organizations stated that they could not make equipment covering the frequency bands and provide other features specified to fit in the space available (1928). **To contend with the reluctance of commercial organizations to combine both LF and HF capabilities into one compact equipment, NRL developed a crystal-controlled transmitter (200 watt, 300 to 600, 2000 to 3000, 4000 to 18,100 kHz) which became the Model TAR equipment (1929).<sup>75</sup>** The transmitter was arranged in sections so it could easily go down a submarine hatch. Its design provided flexibility for use with loop, flat-top, and periscope antennas with quick-frequency-shift and safety features desirable for submarine operation. The satisfactory performance of this equipment was demonstrated aboard the Submarine S-21 assigned to the Laboratory (1930).

When the Laboratory's model was shown to representatives of commercial concerns, one of them agreed to produce the Model TAR equipments and supplied enough to equip 20 S type submarines (1930-1932). Subsequently, additional quantity procurement was obtained from other concerns which provided equipment of the same basic design, designated the Model TBG (1933) and the Model TBL (1935).

The submarine S-28, equipped with the Model TAR, while making passage with the vessels of submarine divisions 11 and 19 from San Diego to Lahaina, Hawaii was able to maintain solid, two-way communication with either of the submarines V-2 or V-3 located at San Diego. **The Commander of the Submarine Divisions, Battle Force, reported that with NRL's Model TAR equipment, two-way communication on HF could easily be maintained with other vessels of the divisions enroute out to 200 miles and more. He also stated that the ex-**

**perience "demonstrated the use and value of high frequency for communication with scouting or screening submarines in fleet areas" and that "it was feasible to maneuver the submarines in much the same way as if they had been in visual contact" (1930).<sup>76</sup>**

This and subsequent experience with high frequencies in submarine communication convinced the Navy that it could dispense with transmissions at medium frequencies. As a result, the space occupied by medium-frequency equipment, particularly the large, cumbersome "clearing-line" loop antenna, was made available for other important uses.

#### "Electron-Coupled" Oscillator-Controlled Transmitters

The number of crystals required to meet the Navy's needs for HF communication channels reached a point where access, storage, and supply became a problem. NRL's earlier investigations of master-oscillator circuits were therefore extended to obtain means of frequency control, continuously covering the high-frequency band, which would provide this flexibility, not possessed by the quartz-crystal oscillator, without serious compromise in frequency stability.<sup>77</sup> A circuit had been designed which could be quickly interchanged with the standard crystal holder (type SE-3716) (1930). While this circuit provided flexibility in frequency and continuity of operation in an emergency, it did not possess the desired precision in frequency. It was found that a circuit using a screen-grid tetrode, with the screen grid maintained at radio-frequency ground potential to isolate the oscillator from the output circuit, could be made to give acceptable stability.<sup>78</sup> In this circuit, the screen grid also acted as an anode, which, together with the control grid and cathode connected to a resonant circuit, formed the oscillator. The output circuit, always tuned to double frequency to minimize reaction on the oscillator, derived its energy from the double-frequency component of the electron stream drawn through the screen grid by the potential of the conventional anode. This action led

to the name "electron-coupled" oscillator. Stability of this oscillator was enhanced through the use of a resonant circuit of low inductance-to-capacitance ratio with highly stable tapped capacitances and a tapped rigid inductance, fine tuning being accomplished by the axial movement of a copper cylinder inside the inductance. The oscillator resonant-circuit components were well shielded and mounted in a compartment maintained at 60°C. A compensating capacitor was provided to minimize the effects of ambient-temperature changes on external components.

This oscillator (type 38160 tube) was incorporated in a transmitter comprising a frequency-doubling amplifier (type 38160 tube), an intermediate amplifier (type 38160 tube), and a power amplifier (type 38161 tube) and providing a power output of 500 watts over a frequency range of 2000 to 4525 kHz. The transmitter proved satisfactory in extensive tests and was demonstrated to commercial organizations in seeking procurement. The commercial product was procured by the Navy in considerable numbers and was designated the Model TBF (1933).<sup>79</sup> The frequency range of this type transmitter was subsequently extended to cover from 2000 to 18,100 kHz.

The "electron-coupled oscillator" type of transmitter developed at NRL provided for the first time frequency stability equivalent to that of the fixed-frequency crystal, but with continuous-frequency coverage. This type of transmitter became the forerunner of a series of transmitters which saw Naval service over a period of many years, extending through World War II.

#### High-Frequency Transmitter Development, 1930 to 1945

During this period NRL's efforts were directed to quick and positive frequency channel changing, higher frequency stability, increased efficiency, reduced harmonic radiation, greater reliability, and compactness.<sup>80</sup> The results obtained were incorporated into a series of models the Navy procured from commercial organizations. With

crystal-controlled transmitters, the objective of 0.01 percent in frequency accuracy was attained on 50 percent of the production during the early 1930's and on practically 100 percent by the end of World War II, a large percentage providing 0.005 percent accuracy at the latter time. However, most of the earlier production of electron-coupled-oscillator-controlled transmitters (all shipboard) gave a frequency accuracy of only 0.025 percent. By the end of the war, an accuracy of 0.015 percent was obtained on most of these transmitters.

During this period, 15 different models of shore station (15 W to 30 kW) and 15 models of shipboard (15 W to 1 kW) HF transmitters were procured by the Navy.<sup>81,82</sup> The shipboard transmitters were made in by far the greater number, procurement of some of the models during the war reaching very large quantities. For instance, the Model TBK went through 21 versions, the TBX, 19 versions, the TBL, 15 versions, and the TCS, 17 versions.<sup>83</sup> Each model and many of the versions involved reconsideration of specifications and the incorporation of such improvements as could be accomplished at the time. During the war period practically all changes in design were of minor nature, procurement being largely a matter of duplication of existing designs by competent manufacturers to produce the large number of equipments needed.

#### High-Frequency Receivers

The development of the high-frequency receiver, as a major component in HF communication systems, accompanied that of the transmitter. A series of experimental HF receivers, mainly of the "tuned-radio-frequency" type, were provided by the Laboratory for service use during the Navy's high-frequency trial period. Due to the interest generated, some of these receivers were quickly produced in quantities by NRL and placed in service by the Navy. The first of the series of experimental HF receivers developed by NRL (September 1924)<sup>84</sup> to find considerable Navy use was intended for installation in aircraft. Its performance was limited by the

## RADIO COMMUNICATION



THE FIRST HIGH-FREQUENCY RECEIVER

This receiver was furnished by NRI to the Fleet to assess the performance of high frequencies (2000-17,000 kHz) (1924). Dr. A. Hoyt Taylor is shown operating NRI's station (NKF) using one of these receivers (center) to acquire propagation data. Dr. Taylor was superintendent of NRI's original Radio Division from 1923 to 1945. During this period, the Division's staff grew from 14 to over 1000. Through the leadership, guidance, and inspiration of Dr. Taylor, the scope of the radio-electronic field was broadened extensively, and major scientific advances such as the development of high-frequency communication and the origination of radar were accomplished. These advances proved of inestimable value to the Navy, the military, and the nation, particularly during World War II.

plane's ignition interference. However, in ship and shore installations, where the interference level was relatively much lower, it gave attractive results. The Laboratory, with the help of a local contractor, produced 35 of these receivers, which were distributed to various classes of ships and to outlying radio shore stations as requested by the Bureau of Engineering (1924-1926).<sup>85</sup> Receivers of this type were furnished the Marine Corps and U.S. Coast Guard (1926). One was used in the dirigible USS SHENANDOAH on its historic west coast trip during October 1924. This receiver was of

the regenerative type employing an oscillating detector and two stages of audio amplification (three CW-1344"N" tubes, 2000 to 17,200 kHz).

Improved sensitivity and selectivity were obtained in a subsequent receiver which employed radio-frequency amplification for the first time at high frequencies (1925). The HF amplifier, introduced ahead of the oscillating detector, was "balanced" to obtain gain without self-oscillation as was discussed previously under "crystal-controlled transmitters." The balance circuit also served to prevent passage of energy from the oscillating detector through the amplifier

## RADIO COMMUNICATION

to the antenna, thus avoiding interference with other receivers on the same ship. An antenna "trap" (antenna coupling unit, type SE 4363) and capacitive coupling between the HF amplifier and detector provided selectivity to avoid interference from the lower frequency transmitters in close proximity on shipboard. The receiver used four CW 1344 N type tubes and covered a frequency range of 1000 to 20,000 kHz. Later, when the screen-grid tube (SE 3382) became available, its substitution for the triode in radio-frequency amplifiers resulted in increased gain and simpler operation. **This HF receiver, developed by NRL in 1925 and designated the Model RG, was procured in numbers approximating 1000 and was used throughout the Naval service.<sup>66</sup> The Model RG was the Navy's first "operational" HF receiver and its principal HF receiver for a decade. In 1940, the 50 U.S. destroyers sent to England for use**

**by the British during the war were equipped with Model RG receivers.**

### Superheterodyne High-Frequency Receivers

Since it was devised (1918), the superheterodyne method has been an attractive means of obtaining radio-frequency amplification in receivers covering a wide frequency band.<sup>67</sup> By heterodyning the incoming signal to a fixed frequency, advantage can be taken of the superior gain, selectivity, and simplicity possible when circuits are optimized to amplify a single frequency. In NRL's early work with this method, difficulties arising in the shipboard environment were encountered which were not experienced in the commercial radio broadcast field to which it had been applied. The many transmitters and receivers, necessarily in close proximity, produced severe reaction between fundamental and

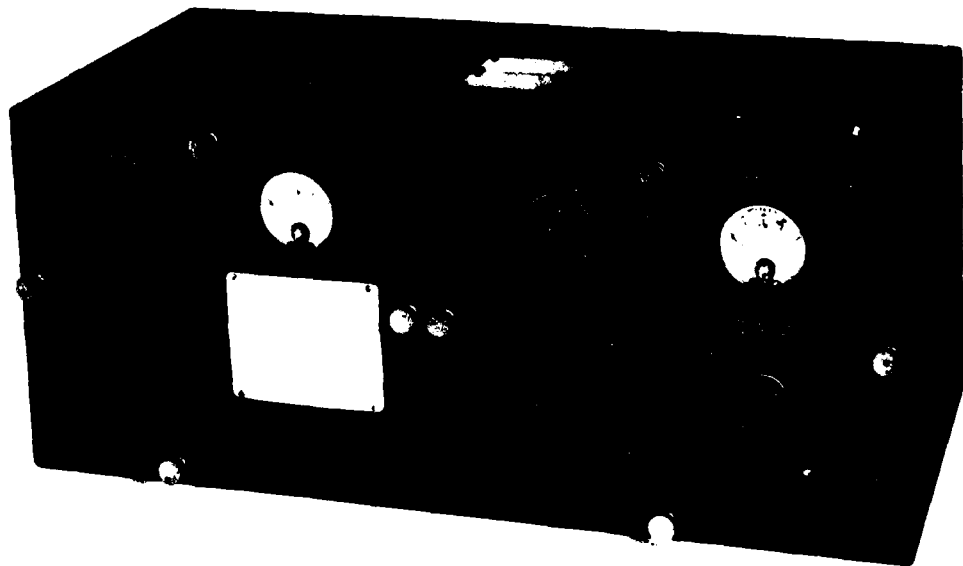

75449

### THE FIRST HIGH-FREQUENCY RECEIVER FOR REGULAR OPERATIONAL USE

This receiver (Model RG, 1000 to 20,000 kHz), developed by NRL (1925), was the first to reach the Fleet in large numbers. It was first to incorporate radio-frequency amplification. It became the Navy's principal receiver and remained so for over a decade continuing in service during World War II.

harmonic frequencies of the transmitter and the heterodyne oscillator, interfering with reception. Receiver response at the "image" as well as the signal frequency made the receiver vulnerable to incoming interference at the image frequency. Radiation from the heterodyne oscillator in one receiver caused interference with other receivers. The tuning of the receiver input circuit caused "drag" of the frequency of the heterodyne oscillator. The double heterodyning required for continuous-wave reception brought additional interference arising from the interaction of the two oscillators. Early models of these superheterodyne type receivers made by NRL brought these difficulties forcefully to attention when the receivers were installed on the USS CALIFORNIA (1924-1926).<sup>88-90</sup>

A substantial step in overcoming the difficulties experienced with the superheterodyne receiver was made by combining the Model RG receiver with a Model RE receiver (10 to 100 kHz), also developed by NRL, with the latter acting as a fixed-frequency amplifier at 15 kHz (1927). The excellent shielding of these receivers, the preselection of the Model RG, and the provision of suitable coupling circuits led to improved reception performance (1927).<sup>91</sup> A number of these receivers were put into operational service.

#### High-Frequency Receiver Development, 1930 to 1945

In its subsequent efforts, the Laboratory improved the selectivity and RF amplification of the tuned-radio-frequency type of receiver. The freedom of this type from the interference problems of the superheterodyne, due to "image" response and reactions from oscillator fundamental and harmonics, made it attractive for Naval use. Nevertheless, the superior selectivity and the large constant gain with stability over a wide frequency range possible with the fixed-frequency amplifier of the superheterodyne resulted in its predominance. It was due to NRL's continuing efforts that the performance of the superheterodyne receiver was improved to

such an extent that it became acceptable for shipboard operation. Attention was given to preselection, RF amplification before detection, cross-modulation in detection, heterodyne oscillator stability and isolation from antenna circuitry, fixed-frequency amplifier stability, adequate shielding, and simplification of operation.<sup>92</sup> The results obtained in the work were incorporated into a series of approximately 40 different receiver models (some of which went through many versions) produced by various commercial concerns.<sup>82b,93</sup> The first of this series, the Model RAB, 1000 to 30,000 kHz (1935), provided performance which in most respects was not exceeded through the war period.<sup>94</sup> However, its size and weight limited its installation to the larger ships and shore stations. Of the more compact and lighter models which followed, the Model RAL of the tuned-radio-frequency type and the Models RAO, RBB, RBC, and RBS, of the superheterodyne type, were procured in large numbers, particularly during the war period, and used throughout the Naval service.<sup>95</sup>

#### Navy Outfitted with High-Frequency Equipment

When the Navy became convinced of the operational value of high frequencies, it faced the problem of procuring transmitting and receiving equipment in sufficient quantity and variety to outfit its many ship and shore stations. Toward the end of the 1920's, commercial concerns began to show interest in providing the Navy with HF equipment, an interest probably stimulated by the declining profits experienced as a prelude to the Great Depression of the 1930's. To stimulate the latent interest of commercial organizations sufficiently to produce the HF equipment the Navy needed to equip its Fleet, the Bureau of Engineering arranged a meeting with representatives of likely producers. At this meeting, NRL reviewed the technical problems involved in HF equipment and the means it had devised to meet these problems (1929). Standards of equipment performance based on NRL's work

## RADIO COMMUNICATION

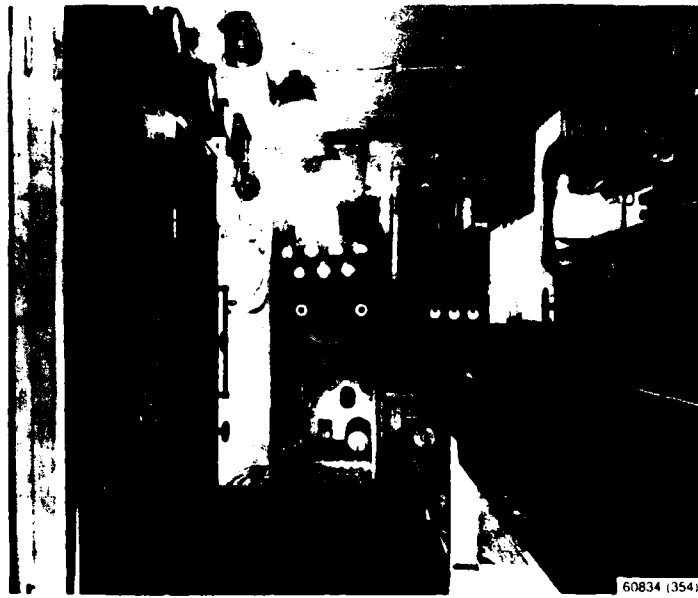

**TYPICAL RADIO COMMUNICATION INSTALLATION—DESTROYER  
USS DALLAS (1925)**

*In the upper photo, left to right, are the Model TL, 6-kW vacuum-tube transmitter, which operated from 200 to 600 kHz (1922), the Model TV interfleet transmitter, 2000 to 3000 kHz, developed by NRL (1925), and the Model CW-936, the Navy's first vacuum-tube transceiver, operating at 5 W from 195 to 1170 kHz, and used in World War I (1918). In the lower photo are Models RE, 10 to 100 kHz, and RE, 75 to 100 kHz, receivers, developed by NRL (1925).*

## RADIO COMMUNICATION

were set forth, e.g.,  $\pm 0.01$  percent in frequency accuracy. These standards were agreed to by the several commercial representatives.<sup>96</sup> These discussions were followed by a continuing NRL effort to provide contractors with information on technical aspects and environmental factors to be used in their designs. The Laboratory furnished the Bureau the technical information for its specifications, interpreted contractors' proposals, and maintained such surveillance over contractors' designs and equipment as was necessary to insure satisfactory service performance.

Prior to the beginning of the procurement of high-frequency equipment in the 1930 period, the effects of the environmental factors of temperature, humidity, vibration, shock, and ship roll and pitch on the performance of radio equipment had been given only superficial consideration. The serious effects of these factors on frequency stability at the higher frequencies and the emphasis placed on considerations of structural ruggedness to obtain reliability led the Laboratory into an extended effort to place these factors on a quantitative basis. Information was obtained on the range and combinations of temperature and humidity, and variations in ships' attitude experienced by the Fleet in worldwide operations. Observations were made of the vibration and shock, including that of gunfire, to be encountered aboard ship. Requirements to be met by manufacturers were established, and testing equipments simulating shipboard conditions were designed so that compliance with the requirements could be determined.

In carrying out this environmental program, NRL provided the nation's first large temperature-humidity-pressure chamber (20 x 20 x 10 ft high) which permitted electronic equipment to be subjected to precisely controlled combinations of temperature and humidity conditions experienced in service (1935).<sup>97</sup> The pressure-control feature of this chamber provided a means of determining the performance of airborne radio equipment (a subject to be dealt with later) at altitudes up

to 20,000 ft. NRL provided the first vibration, shock, and inclination testing equipment simulating shipboard operating conditions (1934).<sup>98</sup> The continuing effort with its series of improvements in test equipment and methods led to more accurate simulation of the service environment. The results of the program were of vital importance to the reliability not alone of high-frequency equipment, but also to that of a wide variety of other electronic equipment, including radar and sonar equipment. The effort paid off well in combat operations during World War II.

The extent of the impact of NRL's environmental efforts is indicated by the many thousands of these high-frequency equipments, both transmitters and receivers, principally for shipboard installation, which were obtained by the Navy from various manufacturers, with procurement greatly accelerated during the World War II period. The magnitude of this wartime buildup is evident from the increase in number of the Navy's ships from 2082 (7 Dec. 1941) to 37,981 (1 Dec. 1944).<sup>99</sup> Practically every ship carried at least one complete HF communication installation, and the larger ships were equipped with as many as 26 transmitters and 40 receivers.

These high-frequency equipments gradually took over the major portion of the Navy's radio-communication load from the lower frequencies. During the war they provided a means of communication which contributed importantly to the war's successful conclusion. Many of these equipments continued in active service throughout the Navy for many years.

### Aircraft High-Frequency Equipment

NRL developed the first aircraft high-frequency equipment, demonstrating its operation in a flight from Washington to Lakehurst, New Jersey and return on 25 Sept. 1924. During the flight, two-way communication was maintained between the aircraft (DH-4B) and NRL's station (NKF) on 3700 kHz out to a range of 70 nautical miles.<sup>100</sup> The aircraft transmitter was heard at points several



## RADIO COMMUNICATION

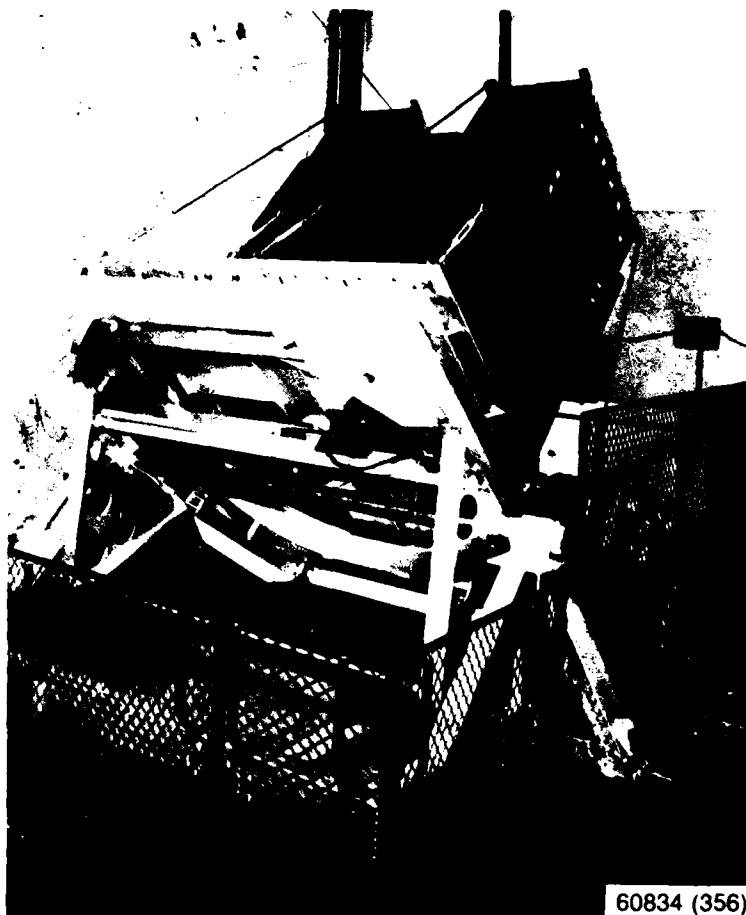

### THE FIRST NAVAL OPERATIONAL ENVIRONMENT SIMULATION EQUIPMENT

This NRL-developed equipment (1934) was first to provide vibration, shock, and inclination simulation of the Naval shipboard operational environment for determining the performance of electronic equipment. It was used in its work to continually upgrade the suitability and reliability of electronic equipment. The Model TBN high-frequency communication transmitter, based on NRL's developments, is shown mounted on the platform.

hundred miles distant, but the aircraft reception range was limited because of ignition interference. The aircraft transmitter was of the master oscillator-power amplifier type, with an output of 7-1/2 watts. **The NRL receiver was the first high-frequency receiver to be developed for aircraft or ship use and was later**

**reproduced in quantities as previously described in the section titled "High Frequency Receivers."** Because of vibration in the aircraft, the received signal on ground had a rough "beat note." This difficulty was avoided in a subsequent experimental equipment through the use of crystal control, which provided a constant beat note

## RADIO COMMUNICATION

(April 1925). A number of experimental equipments were provided the Fleet to obtain operational experience in aircraft.

Although the Navy had accepted high frequencies for its ship and shore communication circuits in 1925, the U.S. Fleet in 1927 was still uncertain of their utility for communication with scouting aircraft over long distances (out to 500 nautical miles). With respect to fighter planes, the Navy was even uncertain of the role radio would play in the principal aircraft function of

"spotting" out to a range of 25 nautical miles. In expressing its opinion of high frequencies, the Fleet stated "It will be a long time before we give up 315 kilocycles for long-distance scouts. ...the Fleet does not want any high-frequency apparatus installed in long-distance scouting planes. The Model SE 1385 ACW aircraft transmitter...is precisely what is wanted."<sup>101</sup> This transmitter (300 to 570 kHz) had been developed by an NRL staff member in pre-NRL days (1922). In taking its stand, the Fleet was

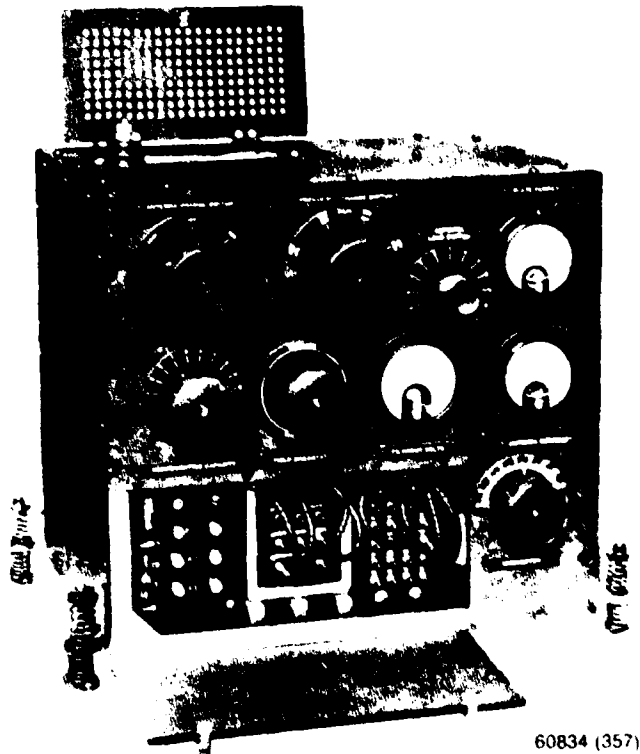

PATROL PLANE COMMUNICATION EQUIPMENT,  
TYPE SE 1385

This transmitter was the first radio communication equipment using electron tubes capable of providing effective communication over the long ranges required by Naval patrol aircraft (1922). The equipment was developed by an NRL staff member while the NRL facilities were under construction. Practically every patrol aircraft was provided with this equipment, which operated at 300 to 570 kHz, with 500 watt output. It gave reliable service for over two decades.

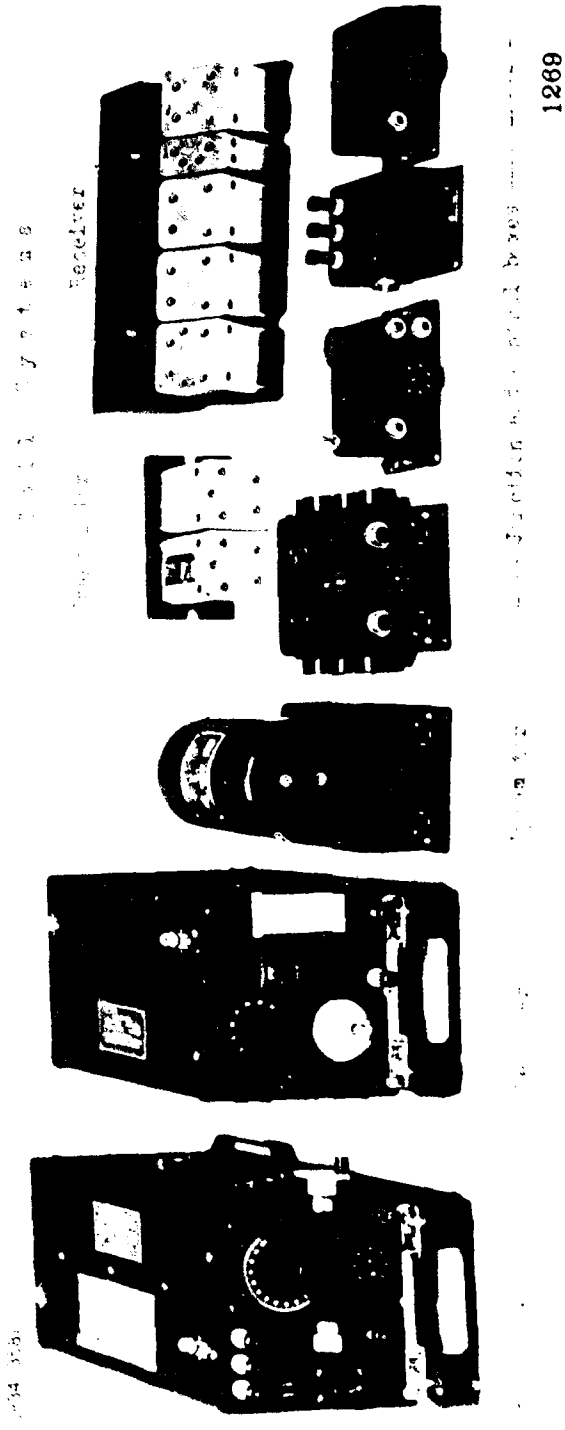

THE AIRCRAFT RADIO COMMUNICATION EQUIPMENT FIRST TO PROVIDE ACCEPTABLE, TWO-WAY, VOICE COMMUNICATION IN FLIGHT AT HIGH FREQUENCY (1931-1933)

NRJ cooperated with the contractor in the development of this equipment, known as the Model GF (transmitter), and Model RU (receiver). Very large numbers of these equipments were obtained and utilized before and during World War II, and they were used for a considerable time thereafter.

## RADIO COMMUNICATION

concerned with the need for frequency-channel shifting when using high frequencies, the fragility of crystals for frequency control, and the assumed greater weight of high-frequency equipment. The interference from aircraft ignition systems, greater at the higher frequencies and thought to require unacceptably heavy ignition-system shielding, was also an impediment.

NRL continued its pursuit of improved aircraft ignition shielding to reduce the interference with radio reception. A study of the sources of interference led to the development of adequate means of shielding engine ignition components, including a new type of spark plug (1927). The application of NRL's aircraft ignition shielding developments to Naval aircraft eliminated the interference problem and made high-frequency reception on aircraft practical.<sup>102-104</sup> In June 1929, at a conference arranged for the consideration of the ignition-interference problem and attended by representatives of the aircraft industry, the Laboratory presented the results of its work. Shortly thereafter, ignition shielding was applied generally to Naval aircraft. Later it was utilized in commercial aircraft. In reporting the results of tests on long-range, high-frequency communication made by the U.S. Fleet, Aircraft Scouting Force, its Commander, in his report, stated, "The marked improvement of receiving conditions in the planes is ascribed chiefly to ignition shielding..." (December 1931).<sup>105</sup> A requirement for ignition shielding was included in the 1932 edition of the General Specifications for the design and construction of airplanes for the Navy.

The Bureau of Engineering decided to explore the frequency range 3000 to 4000 kHz for short-range fighter and spotting aircraft communication and sponsored NRL's effort to provide suitable equipment (1926).<sup>106</sup> The first such equipments procured were the models MD (General Electric) and ME (Westinghouse) (1927-1929).<sup>107</sup> These were followed by the Model GF transmitter (5000 to 8000 kHz), accompanied by the Model RU receiver. (1931-1933).<sup>108</sup> The

Model GF/RU equipment was the first to provide acceptable two-way, aircraft voice communication, feasible because of the availability of effective ignition-system shielding. The Model GF/RU (Aircraft Radio Corporation) was procured in large numbers and used extensively, and continued in use through World War II.

Although of relatively low power (5 watts), the Model GF was also used for patrol aircraft which required coverage over long distances. The Models GH (Westinghouse) and GI (General Electric), also procured, provided greater power (100 watts, 4000 to 13,575 kHz). These equipments were followed by a series of models for patrol planes, the development of which paralleled that of shipboard high-frequency equipment. NRL maintained surveillance over these developments to insure acceptable service performance. The Navy has found the high-frequency band very useful for long-distance communication by its aircraft.

### Teleprinter-Facsimile

The first transmissions of teleprinter messages over a radio circuit were accomplished on 6 Sept. 1922 by NRL staff members just prior to moving to the present laboratory site. Transmissions (590 kHz) were made from aircraft in flight out to distances of 50 miles to ground and in the reverse direction, with acceptable results.<sup>109</sup> Instrumentation, particularly for reception, had been prepared to adapt the teleprinter ("teletypewriter," "teletype") to radio equipment. The instrumentation developed was utilized in early guided-missile control. During April 1923 the first trials of the teleprinter over Navy long-distance operational circuits, Annapolis—San Francisco—Pearl Harbor, were conducted using high-power, low-frequency transmission.<sup>110</sup> Subsequently, other experimental use was made of the teleprinter, but the error rates over long-haul circuits were not low enough to be operationally attractive prior to 1944.

## RADIO COMMUNICATION

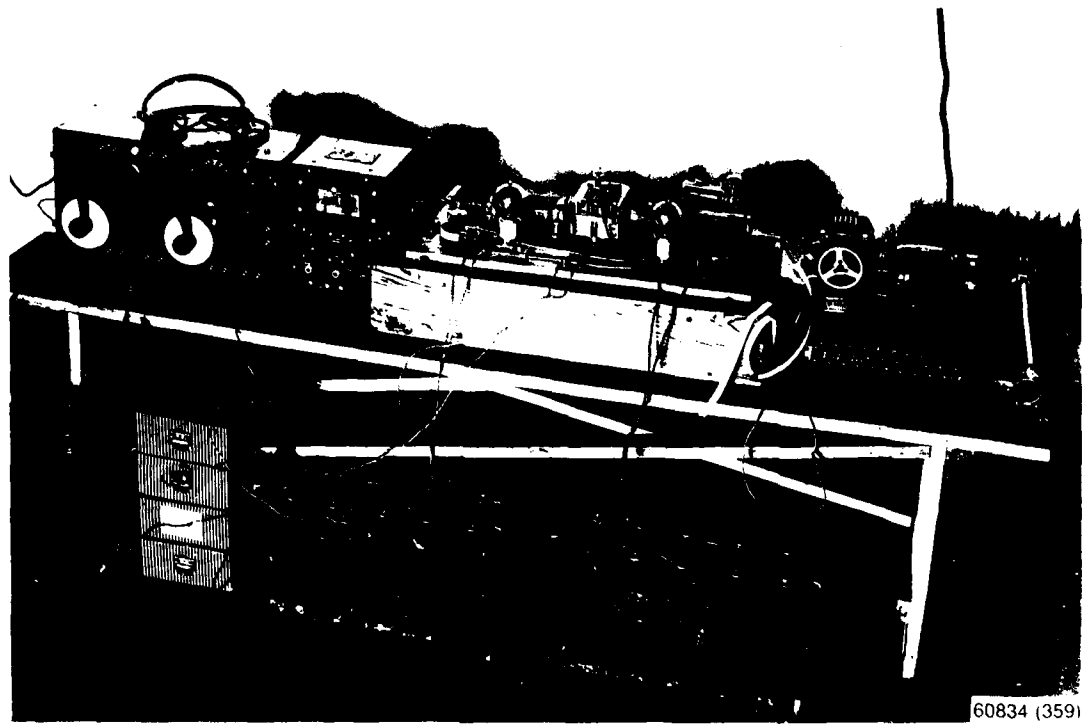

### FIRST RADIO TRANSMISSIONS OF PRINTED MESSAGES

Teletype printed messages were first transmitted over a radio circuit with this equipment (1922), with transmissions between an aircraft in flight and the laboratory at the Anacostia Naval Air Station. The equipment included circuits to adapt the teletype to the radio transmitter and receiver. The instrumentation developed by pre-NRL staff members was later adapted by NRL to the radio control of Naval craft.

NRL was first to develop a teleprinter system for use on radio circuits which provided operationally acceptable error rates (1944). NRL's system employed "Frequency-Shift-Keying" (FSK) in which the frequency was shifted 850 Hz between two states, "Mark" and "Space," with high precision. In view of the Fleet's urgent need, NRL's system was quickly put to use on Fleet radio circuits and extended as soon as possible to the entire Naval communication system. NRL's FSK-teleprinter system greatly increased the speed and accuracy of handling radio communication traffic, reduced the number of operators required, and simplified their training.<sup>111,112</sup> NRL's efforts resulted in "...Making the use of

teletypewriter practical" over radio circuits.<sup>113</sup> The major factor in the poor performance of previous teleprinter systems had been due to the action of the automatic volume control in receivers which caused a large rise in the level of the noise and actuated the teleprinter improperly during the "off" period of the "on" and "off" keying method previously used in continuous-wave operation. NRL's system avoided this by using a continuously transmitted signal, thus holding the received signal at constant level. Furthermore NRL provided for receivers a frequency-shift converter to convert the FSK signal for teleprinter operation, a visual tuning indicator to permit precise setting on the frequency channel, and a device for

## RADIO COMMUNICATION

automatically starting the teleprinter. Modification units were developed to adapt substantially all high-frequency transmitters in service and convert them to FSK. Contractors were guided in providing kits for field modification.

The first U.S. transmission of photographs over a radio circuit (facsimile) was accomplished in May 1922 by NRL staff members, cooperating with Mr. C. Francis Jenkins, a Washington, D.C., scientist. Transmissions made from the Naval Laboratory at Anacostia (Station NOF, 500 to 1,200 kHz, 500 watts) were received and recorded at Mr. Jenkins' laboratory, located in northwest Washington, D.C.

The unique optical components, provided by Mr. Jenkins, were rotating glass disks, the edges of which varied in thickness, forming prisms. At the transmitter, a light beam passed through the disks and the photographic plate and impinged on a selenium cell. The light beam was caused to scan the photograph horizontally by one pair of disks and vertically by a second pair. A similar optical system at the receiver, synchronized with the transmitting system, provided scanning of a photosensitive surface to reproduce the photograph. The signal produced by the selenium cell modulated the transmitter and, correspondingly, the light

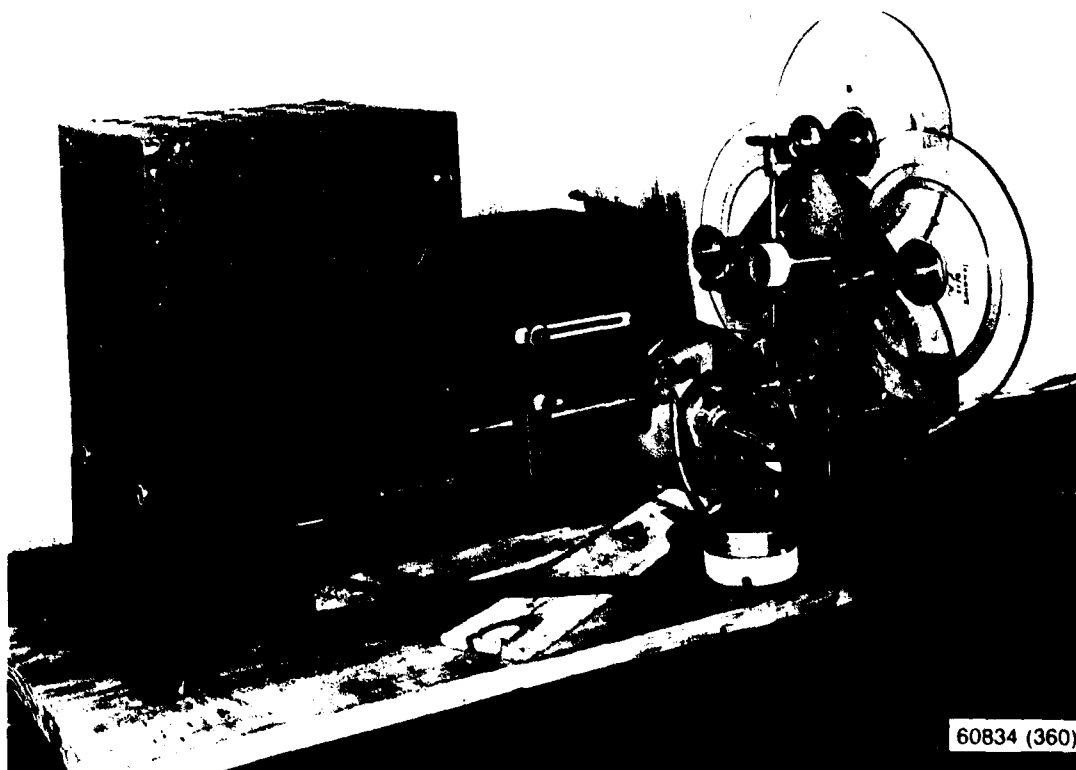

THE FIRST U.S. FIRST TRANSMISSION OF PHOTOGRAPHS OVER A RADIO CIRCUIT (FACSIMILE) (1922)

An official demonstration of radio transmission of photographs was given to the Chief of the Bureau of Engineering, RADM S. S. Robinson, on 12 Dec. 1922. This was accomplished by founder members of NRL, collaboratively with C. Francis Jenkins, with the optical components shown. Transmissions were made from the equipment (NOF) (500 to 1,200 MHz) located at the Anacostia Naval Air Station to a receiver across the city of Washington.

beam at the receiver, to reconstruct the image. On 12 Dec. 1922, this facsimile system was demonstrated to the Director of Naval Communications, RADM H. J. Ziegemeier, and the Chief of the Bureau of Engineering, RADM S. S. Robinson. On 2 Mar. 1923, photographs of President W. G. Harding and the Secretary of Commerce, Herbert C. Hoover, were transmitted from NOF to the Evening Bulletin Building, Philadelphia, Pennsylvania, the first U.S. long-distance facsimile radio transmission.<sup>114,118</sup> Later, after an experimental period in which NRL participated, the Navy equipped certain of its ship and shore stations with facsimile equipment and has continued to use it for the transmission of weather maps, photographs, line drawings, and other graphic material.

### Television

The first radio transmissions of visual images of moving objects were made in 1923 by NRL in cooperation with the Jenkins Laboratory in Washington, D.C.<sup>116-118</sup> The transmissions, on 550 kHz at 500 watts, were made from NRL's station NOF to the Jenkins Laboratory, where the moving images were displayed. On 13 June 1925, this "pre-television" system was demonstrated to the Secretary of the Navy, then the Honorable Curtis Wilbur; the Chief of the Bureau of Engineering, RADM S. D. Robinson; and the Director of NRL, then CAPT Paul Foley. Moving images of a model windmill and a dancing doll were displayed. Motion-picture films were also transmitted. The quality of the reproduced images was approximately 15 lines per inch. At the transmitter, the moving images were focused onto a ground-glass plate, which was scanned by a series of lenses mounted spirally on the surface of a rapidly rotating disk. The rotating lenses focused the picture elements, in turn, onto a photocell to provide the signal. At the receiver, a similar rotating-lens arrangement caused a light beam, modulated by the

signal, to scan a viewing screen to reproduce the images.

NRL participated in a number of early adaptations of television to serve Navy functions. One application was in the guidance to targets of assault drones used as guided missiles, described in Chapter 5 (see also Ref. 7c in Chapter 5). Another was concerned with the provision of an underwater search vehicle equipped with television for assessing underwater damage to ships and assisting deep-sea divers in salvage operations. The vehicle was remotely controlled from a surface ship (1947).<sup>119</sup>

NRL developed the first television submarine periscope buoy for sea-surface observations by submarines submerged at great depths (1952).<sup>120</sup> This buoy, proposed to the Joint Weapons Evaluation group in 1950, had the objective of extending the surface observations function of the usual periscope to much greater depths. A periscope-like optical system was mounted on the top of the buoy and extended to a television camera carried in the body of the buoy. Observations with the remotely controlled optical system could be made in azimuth by continuous rotation of it in either direction and in elevation from minus 10 degrees to plus 45 degrees. An erect image was maintained on the television screen by the introduction of a rotatable dove prism in the system. In scanning the field, 525 lines per frame interlaced and 30 frames per second were used. The buoy was demonstrated aboard the Laboratory's picket boat in the Chesapeake Bay in sea states of one to three. The system had attractive potential for special applications.

NRL developed a special television system to provide a means of locating and observing objects on the ocean floor from surface ships (1963).<sup>121</sup> This system was used for long periods of time in water as deep as 8400 feet with an installation on board the USNS GILLISS (AGOR-4).

NRL developed the first satisfactory television system for the observation, within a submarine, of the performance of outboard equipment (1964).<sup>122</sup>

## RADIO COMMUNICATION

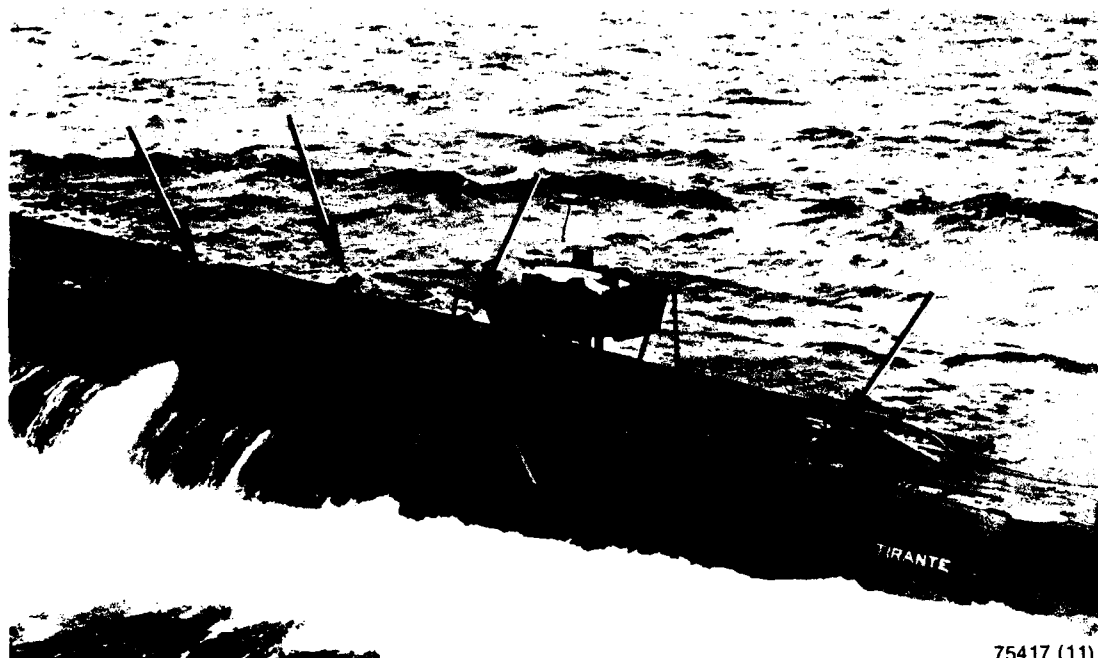

75417 (11)

### UNDERWATER TELEVISION SYSTEM

The television system shown here installed aboard the USS TIRANTE was developed by NRL in 1964. It permits observation of the performance of outboard equipment from within the submerged submarine while underway. Four television cameras can be seen on deck about the experimental submarine communication buoy structure (see arrows).

The system eliminates a considerable quantity of instrumentation otherwise required. The system was first used in determining the performance of NRL's towed radio-communication buoy, while under development, during its "nesting" operation in the deck of the submarine USS SEACAT (SS-399) while submerged (1964). It was also used for this purpose on the submarine USS TRUTTA (SS-421) during 1965. The system was most useful whenever it was necessary to observe nesting of such buoys.

### Communication Circuit Multiplexing

Satisfactory quality was obtained in the high-frequency band with facsimile when ionospheric conditions were good, but when conditions became unfavorable the quality was severely reduced. The irregularities of the ionosphere

caused the incident energy of a signal element to be refracted over several paths of varying length, with correspondingly different delay times. Some of the components of the original one-millisecond signal were delayed as much as four or more milliseconds.<sup>123</sup> To avoid interference, acceptance of a new signal at the receiver had to await the arrival of all components of a previous signal. The transmission time of a standard weather map then became one hour, as compared with the usual 20 minutes. To overcome this difficulty, NRL developed a multiplex system which was first to provide good quality reproduction of facsimile consistently under multipath conditions over high-frequency circuits (1948).<sup>124</sup> This multiplex system was also first to provide satisfactory accuracy in teleprinter operation at high speed under unfavorable ionospheric multipath conditions in the



## RADIO COMMUNICATION

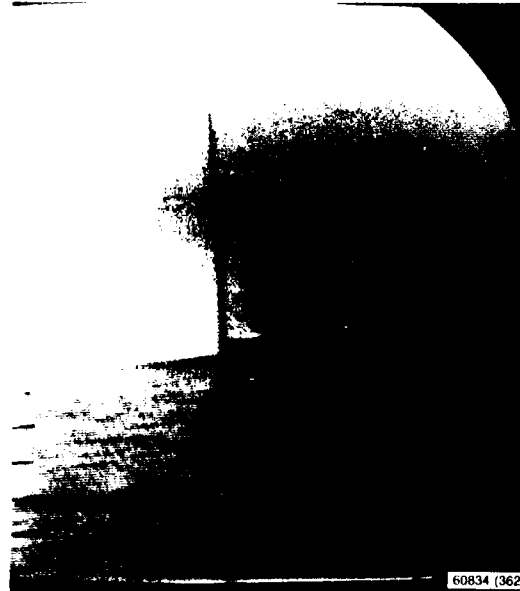
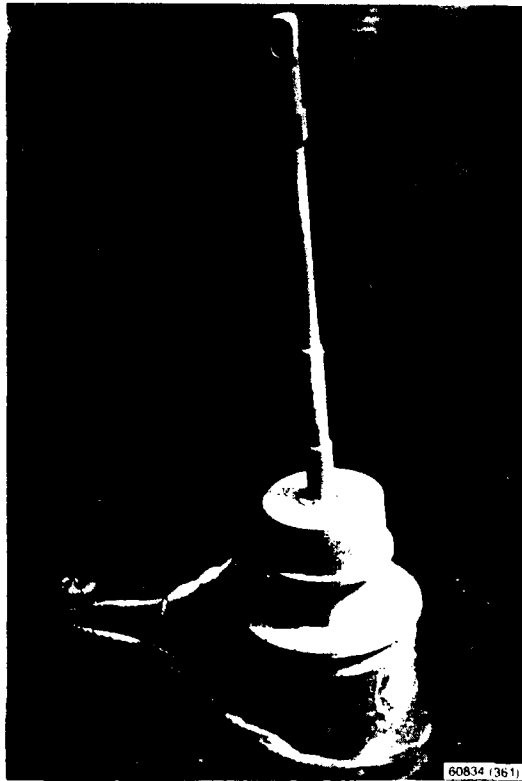

### THE FIRST TELEVISION SUBMARINE PERISCOPE BUOY FOR SEA-SURFACE OBSERVATIONS BY SUBMARINES SUBMERGED AT GREAT DEPTHS (1952)

This NRL-developed television system permitted observations in azimuth to 360 degrees and in elevation up to 45 degrees, with full control within the submarine. Picture quality was equal to that of U.S. commercial television standards.

high-frequency band. It has been used extensively in high-frequency teleprinter systems. In this system, the amplitude-modulated facsimile output was converted into quantized mark and space type signals of one millisecond duration. Sequential signal elements were commutated into eight properly spaced audio-frequency (2400 to 4500 cycles) channels in such a way that each channel carried one in eight of the sequential elements. Thus, the channel signal elements were permitted to be of eight-millisecond duration, adequate to contend with any ionospherically delayed signal component. Similar, synchronized, multiplexing devices performing these functions were provided for both

ends of the radio circuit. This system was given extended trials over high-frequency long-distance circuits such as that from Washington to San Francisco and was proven to give satisfactory facsimile performance under multipath conditions. This multiplexing system permitted the transmission of 7 by 7-3/8 inch facsimile copy in seven minutes.

### High-Frequency Single-Sideband System

To accompany the multiplex system just described, the first high-frequency, single-sideband system, providing a substantial

increase in communication capacity through radio-spectrum conservation with suitability for shipboard operation, was developed under NRL's leadership and guidance (1955).<sup>125,126</sup> By suppressing one of the two sidebands produced by the modulation, and also by suppressing the carrier, introducing it instead at the receiver, spectrum use can be reduced solely to that required by the original signal. Concentration of the available energy on one sideband provides greater effectiveness in its use (9 dB). NRL conducted a thorough investigation of the problems encountered in using single-sideband systems for ship-ship-shore communication and the advantages to be had in their employment. Several techniques were devised and included in an experimental system intended to utilize existing Navy continuous-wave transmitters and receivers (1946-1952).<sup>127,128</sup> Early single-sideband systems used means to perform the necessary functions of such complexity and requiring such exacting adjustment and highly skillful servicing that they were impractical for Navy use aboard ships. Furthermore, unacceptable signal distortion occurred unless the receiver was tuned precisely to the transmitter frequency. This limitation required the transmitter to be continuously active, a situation which could not be tolerated on shipboard. A major difficulty was the lack of adequate precision in the frequency control of transmitters and receivers. A precision of about one part in  $10^6$  was required, but such precision was not then available aboard ship.

NRL's work (to be described later) on highly precise frequency standards and on frequency synthesizers which could produce output frequencies of the required accuracy on a decade basis from a single crystal standard made single-sideband operation feasible. The highly precise frequency control also made available advantages of single-sideband transmission not otherwise possible, including low harmonic and intermodulation distortion due to the behavior of the ionospheric transmission medium, unlimited circuit netting, so important in task-force data and information exchange, and far better circuit reliability. In the develop-

ment and procurement of equipment incorporating the results of NRL's work, contractors were guided and extensive performance investigations were made to insure satisfactory service use (1955-1963). The efforts led to equipment capable of providing eight teleprinter channels utilizing the same spectrum bandwidth previously required by a single FSK teleprinter channel of the conventional double-sideband type. The equipment became identified as the Models AN/WRT-2 (transmitter), AN/WRR-2 (receiver), and AN/URC-32 (transceiver), thousands of which were obtained (1955-1968). At least two equipments were installed on smaller ships, with greater numbers on larger ships. The single-sideband system superseded the double-sideband type, and other military services adopted such equipment, including the NRL advances. Commercial communication systems have also greatly benefitted by NRL's work.

#### Communication Security

For many years, the Navy, to prevent the extraction of the intelligence in messages being transmitted over radio circuits, used a five-letter code with letters transposed in accordance with permutations established by complex "cipher" patterns. Later the "encryption" process was enhanced by the availability of electromechanical devices operated from a typewriter-like keyboard or a punched tape. The "key" of these devices could be changed at frequent intervals to reduce the probability of code breaking. The encryption process introduced considerable delay in transmission of messages, which became a heavy burden at the principal communication centers during World War II. As many as 100 especially qualified officers had to be assigned to such centers to contend with the traffic load.

#### Electronic Encryption System

An important advance in carrying out the encryption function was made when NRL

## RADIO COMMUNICATION

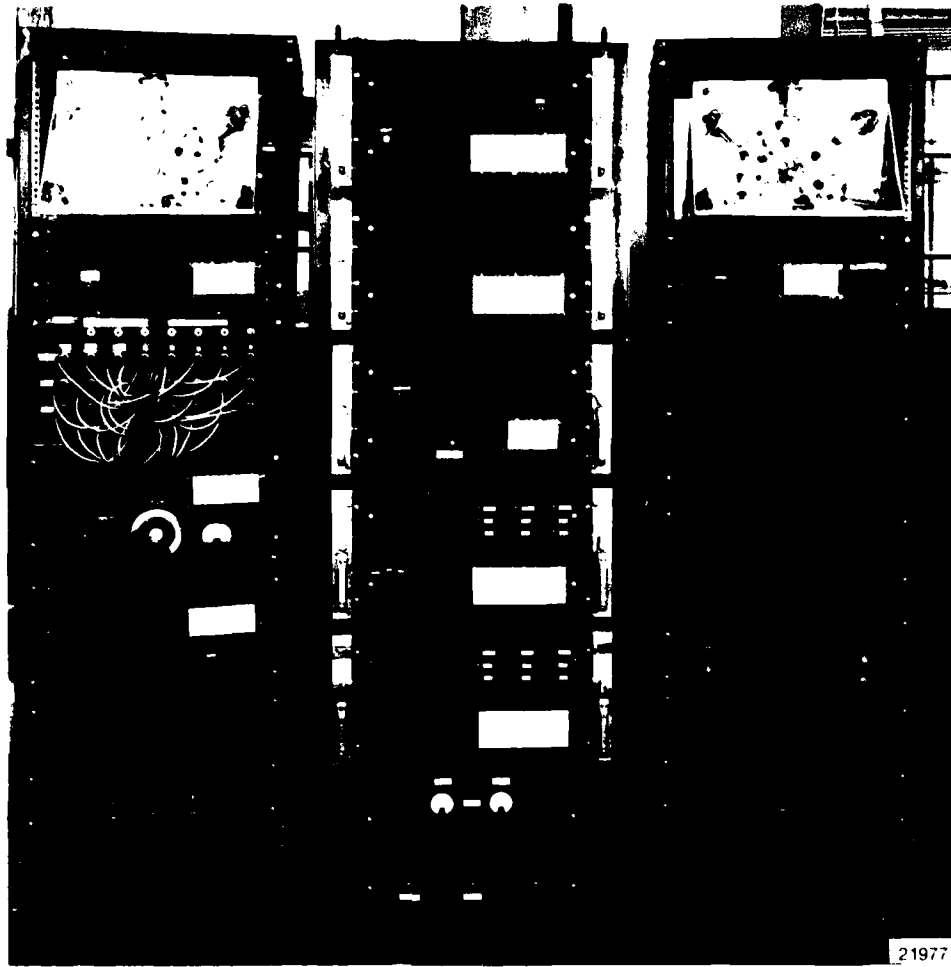

### "ON-LINE" ELECTRONIC COMMUNICATION ENCRYPTION SYSTEM

This system was first to employ a random code generator, the output of which is combined electronically with the telewriter or "quantized" facsimile signal to prevent the extraction of intelligence in messages transmitted over radio circuits. At the receiver, a similar synchronized code generator permits automatic decoding. The system replaced the earlier manual encryption system, which required as many as 100 specially trained officers at principal communication centers to contend with the traffic load during World War II. The basic system, developed by NRI (1947), although modified as improved components became available, was widely used by the several military services.

developed the first "on-line" electronic encryption system, which is generally basic to encryption systems (1947).<sup>123, 128</sup> The system was placed in operation on Navy transcontinental and transoceanic trunk circuits and gave satisfactory per-

formance (1953). As improved components became available, the basic system was broadly modified to meet the needs of the several military services. Instead of transposing the letters of the message, this system transposes, in random

fashion, the "mark" and "space" signal elements to be transmitted. The work was first directed to provide cover in transmitting facsimile material. The amplitude—modulated output obtained in scanning the facsimile material was "quantized" to produce a "mark" and "space" type signal. This was combined algebraically with the random output of a code generator to produce the encoded signal to be transmitted. The code generator employed a number of continuously rotating disks scanned photoelectrically. The disks had holes located near their edges placed in angular positions corresponding to the code key. As the disks rotated, light beams passed through the holes activating photo cells, the outputs of which were combined electronically. The code-generator output was the binary sum of the signals produced by the several disks. Additional disks with holes located in various angular positions were provided for changing the key. This method of generating the random signal was modified by employing binary digital "ring" circuits when suitable binary magnetic storage elements became available. The key could then be inserted electronically in the "ring" circuit. A similar code generator, synchronized with the generator at the transmitter, was used for decoding at the receiver.

Although intended at first to provide cover for facsimile transmission, this security system met an immediate need for adequate security on Navy teleprinter circuits. Since the teleprinter output was already quantized, it could readily be combined with the random output of the code generator. The code generator, designated the AFAX-500, was procured in quantities through contract. The generator, together with the multiplex system previously described, provided the Navy with secure, reliable, low-error-rate means of transmission over long-distance high-frequency circuits.

### Cipher Key Quality

The cipher keys of crypto generators, which comprise binary streams of digital elements,

must have adequate "randomness" to avoid the discerning of any pattern which might lead to code breaking. The Navy became concerned about the security of the punched-paper-tape cipher keys supplied by a central military organization, which it used to produce the random stream of elements (1950). The degree of randomness had been determined by visual inspection of the tapes, a method which did not appear adequate to uncover possible weaknesses. To provide a statistical basis for judging security quality, NRL developed the first statistical analyzer for determining the "randomness" of punched-tape cipher keys (1952). The use of this device uncovered many weak keys and brought about substantial improvement in the security of communication in the several military services which relied upon the keys.

The operational speed of the electromechanical counters used in the first analyzer limited the length of the cipher key that could be analyzed and the depth of the analyzing process. The speed was also inadequate to match the operational speed of the magnetic binary digital type crypto generator under development. As a further step, the Laboratory developed the first electronic real-time statistical analyzer, which made thorough and rapid determination of the randomness of security cipher keys practical (1957).<sup>129,130</sup> The performance of this key analyzer proved successful, and the details of its design were made available to other military organizations. This type of analyzer was widely accepted by the military services, and it materially contributed to the quality of their secure communications. This analyzer was based on modern statistical technology applied to modern electronic binary digital circuitry. A measure of the probability of randomness was obtained through autocorrelation, crosscorrelation, and automatizing the routine and repetitive parts of the statistical analysis of a time series.

### Electronic Station Call Sign Encryptor

The practice of assigning call signs to ship and shore stations for purpose of identity permits

## RADIO COMMUNICATION

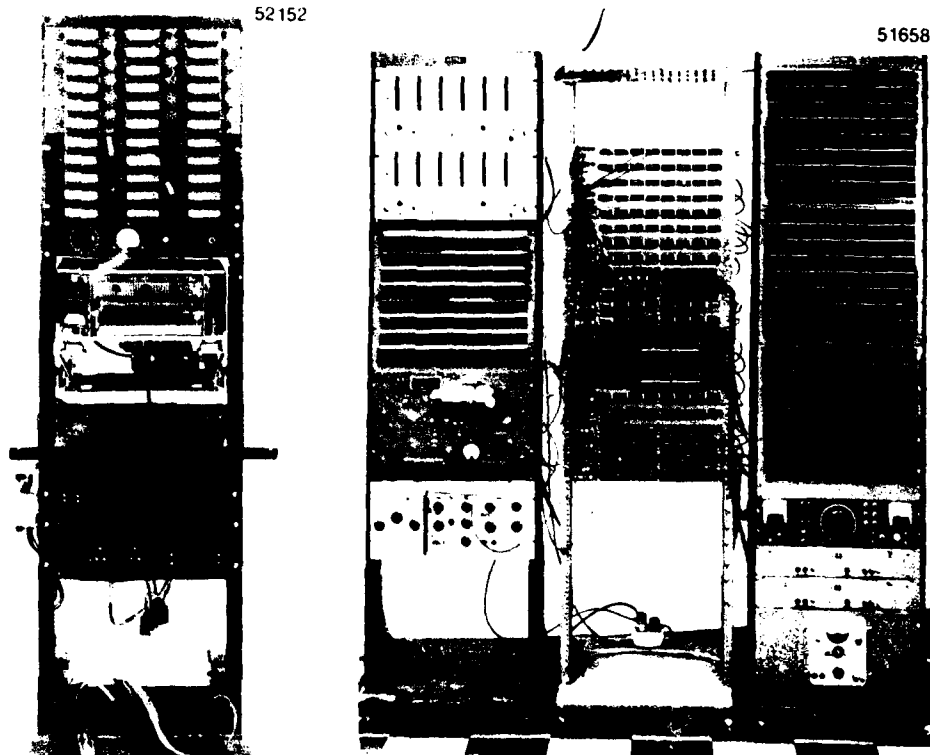

### REAL-TIME STATISTICAL CIPHER "KEY" ANALYZER

The analyzer, developed by NRL, was first to make thorough and rapid determination of the randomness of security cipher "keys" practical. For security of the intelligence in messages being transmitted over radio circuits, a high degree of randomness is essential. NRL's electro-mechanical model (1950) is shown on the left and its binary digital model (1957) on the right.

association of the density of communication traffic with the individual stations. Under certain circumstances such association is of military value to hostile forces. By changing the call signs of stations in a random way, uncertainty can be introduced to deceive the hostile interests. **To accomplish this, NRL developed the first electronic station call-sign encryptor, which included a novel matrix algebraic computer technique using a prime number as a radix for the alphanumeric series—letters plus numbers (1956).<sup>181</sup>** This device was used successfully by the Navy in regular operations over a period of several years at

its Washington, D.C. radio-communication terminal. It provided a 20-to-1 reduction in operational manpower as compared with that required by the mechanical devices previously used, and made call-sign encryption practical.

### Compromising Emanations

Communication systems, equipments, connecting lines, or cables handling classified matter may emit compromising emanations which can be exploited through clandestine means, thus

## RADIO COMMUNICATION

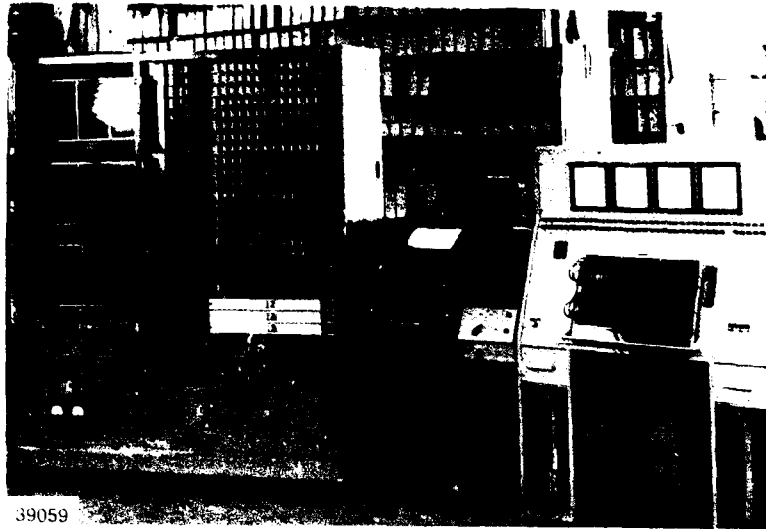

39059

### ELECTRONIC STATION CALL SIGN ENCRYPTOR

This encryptor was first to permit the random determination of radio-station call signs electronically, to introduce uncertainty of station identity and thus deceive hostile interests (NRL, 1956). This NRL-developed device was used successfully by the Navy in regular operations over a period of several years.

vitiating security. The emanations may be generated in electromagnetic, electric, magnetic, or acoustic form and, due to association with parts of systems handling "clear-text" classified matter, may contain variations representative of this matter. These emanations may bypass cryptographic devices and appear in detectable form in the outputs of systems or may be disseminated by diverse means beyond the security perimeter. **Investigations leading to the effective suppression of these emanations to avoid compromise is an activity of concern not alone to the Department of Defense but also other government departments and offices. NRL has been a pioneer in this field and has made many contributions to the various organizations.**

Another example of unique activity in this field is related to shielded cables, conduits, and ducts

used to pass classified matter. Emanations from these information carriers, even though of extremely low energy level, may be subject to surreptitious interception by various means. **NRL was first to develop adequate procedures to determine the electromagnetic leakage from shielded nonferrous cables and magnetic leakage from ferrous conduits and ducts. These procedures resulted in standards widely used by organizations concerned with secure communications (1965).<sup>132</sup>** The procedures for nonferrous cables cover the entire radio-frequency spectrum. Those for ferrous conduits and ducts provided accurate means of determining magnetic attenuation at lower frequencies.

The Laboratory has conducted many investigations of communication systems which have led to the correction of their security weaknesses. It has provided new techniques to advance the capabili-

## RADIO COMMUNICATION

ties of new security devices and to eliminate the weaknesses of existing delinquent devices. It has furnished critical technical information for procurement specifications for new security equipment and has provided guidance in the preparation of federal standards used by all government departments. The results obtained have had significant impact on the security of communication systems used throughout the world by the various government departments. NRL's specialized expertise, acquired over an extended period, brought wide recognition as an authority in this field.

### High-Frequency Antennas

The relatively small size of high-frequency antennas, as compared with the size required at the lower frequencies, was an important factor in meeting the need for greatly increased radio-communication capacity of Naval ships. A considerable number of high-frequency antennas, usually half-wave dipoles, could be accommodated aboard ship without interaction, whereas only very few lower frequency antennas could be installed in the limited space available. However, during World War II, the number of high-frequency circuits used for command functions increased to such an extent that antenna congestion on shipboard became a serious problem. The communication ships (Type AGC) serving command had so many antennas that a circuit adjustment of any one of them would so react upon the others as to make rapid changes in frequency impractical. To remedy this situation NRL sought to provide an antenna structure having broad frequency radiating characteristics, so that a single antenna could accommodate several transmitting or receiving equipments operating simultaneously. The problem was primarily one of transmission, since the laboratory had developed fairly effective means for multiple reception using an aperiodic antenna (1922-1927) which had continued in use throughout the Navy. However, no transmitting antenna

having efficient radiating characteristics over the high-frequency band without serious gaps was available. Through an investigation of various antenna structures, NRL found that two concentric cylindrical tubes, when properly arranged and proportioned, could provide a 3-to-1 frequency coverage with a voltage-standing-wave ratio not exceeding 3 to 1 (known as the sleeve antenna).<sup>133,134</sup> Although previously applied as a single antenna on the Guppy type submarine, the SS 350 (1948), the first extensive installation on the broadband sleeve antenna developed by NRL was made on the task fleet flagship USS NORTHAMPTON (1953).<sup>136</sup> Ten antennas (five transmitting, five receiving) of the new design replaced 50 of the earlier type and in three sizes provided continuous effective coverage of the high-frequency band. The new broadband antenna was subsequently applied to destroyers, aircraft carriers, cruisers, and other classes of ships with NRL providing the necessary technical information and guidance.<sup>136</sup> This antenna has also found extensive use at shore stations throughout the world. New applications are continually arising.

### Integration of Ship Superstructure in HF Antenna Systems

Large parts of the superstructure of ships, such as a smoke stack, adjacent to high-frequency antennas have marked adverse effect on their performance and cause gaps in azimuth coverage. NRL determined that by including large superstructure elements in the antenna system, with proper design, effective coverage from 2 to 6 MHz could be obtained. This lower part of the high frequency band requires the largest physical structure, so the use of existing structures not only conserves valuable deck space but also avoids azimuth blocking, thus turning a liability into an asset. The "conning tower" of the Guppy type submarine, USS 350, was included in its high frequency antenna system in the first application of this concept (1948). The inclusion of a

## RADIO COMMUNICATION

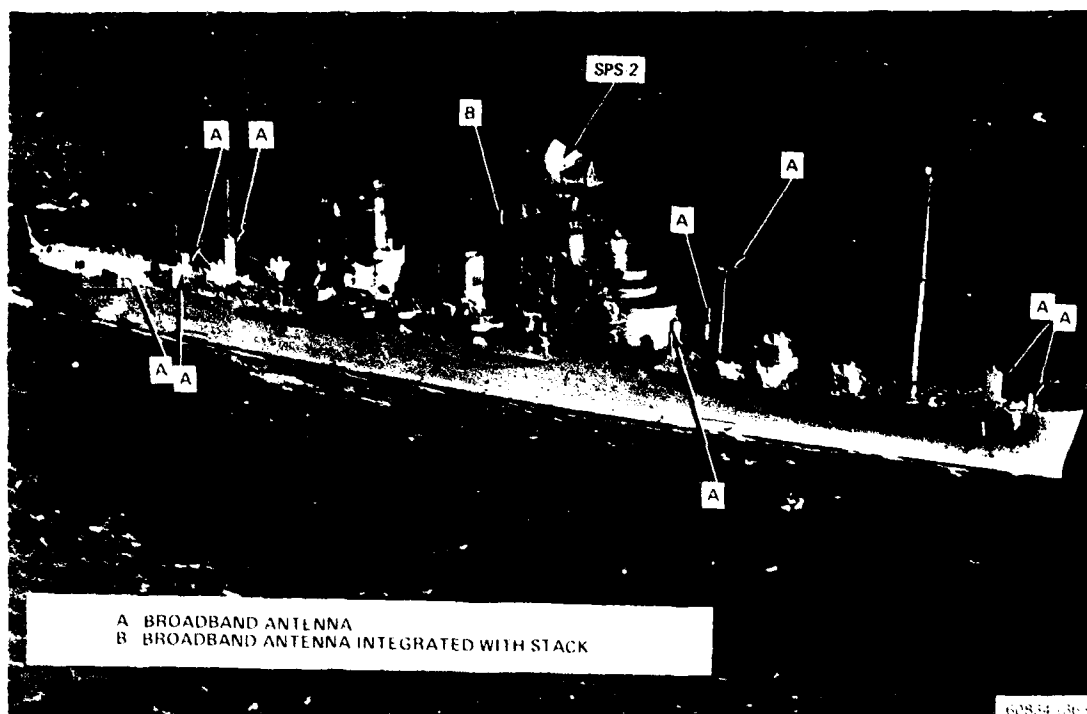

### HIGH FREQUENCY BROADBAND ANTENNA INSTALLATION ON THE USS NORTHAMPTON

This first extensive installation on a Navy ship comprised ten sleeve antennas (five transmitting, five receiving) developed by NRL (1953). These broadband antennas replaced 50 of the earlier narrowband types and provided continuous effective coverage of the high frequency band. The antennas are seen as vertically arranged cylindrical structures. The antenna of the world's most powerful radar at that time (AN SPS 2) is shown atop the center tower. NRL developed critical components of this radar. On the photo, the letter A indicates a broadband antenna. The letter B points out a broadband antenna integrated with the stack.

ship's stack as part of a high-frequency antenna system was first accomplished by NRL on the USS 693 Class of destroyers (1949).<sup>137</sup> Both forward and aft stacks of these ships were used as the sleeve sections of two of the antennas. The first installation on a cruiser class of vessel was on the USS NORTHAMPTON (1953).<sup>138</sup> Its application to other ships continues, utilizing such parts of the superstructure as gun turrets and deck houses.

### Conical Monopole Antenna

NRL developed the conical monopole antenna to meet the requirement for a high-frequency antenna of low height to minimize obstruction to aircraft in landing at Naval Air Stations (1957). Hundreds of these antennas were installed at Air Stations, both Navy and Air Force, throughout the world.



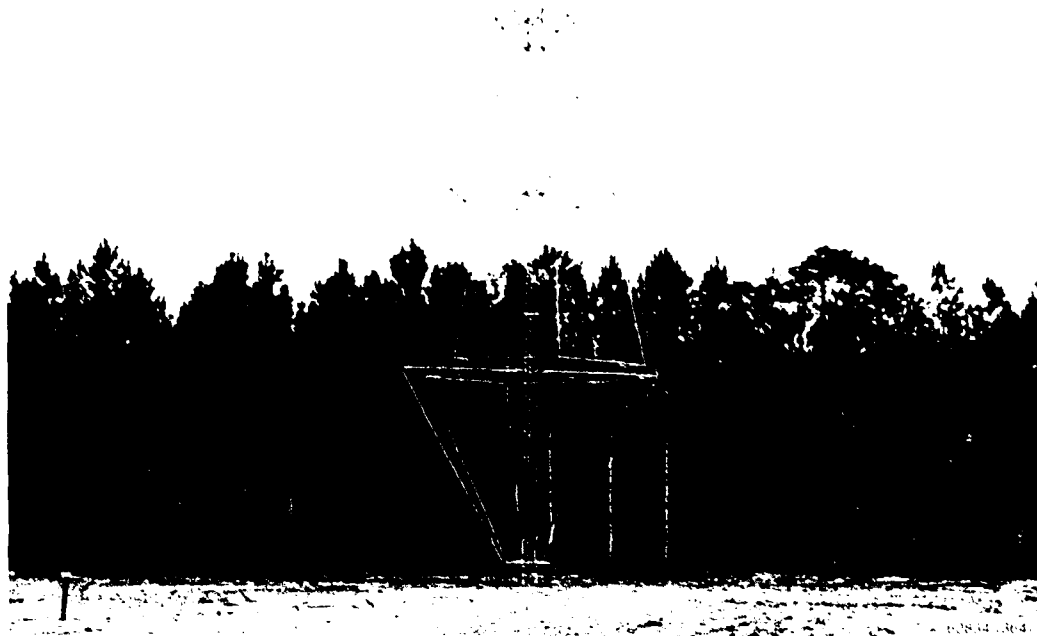

**THE "CONICAL MONOPOLE" HIGH-FREQUENCY BROADBAND ANTENNA**

This type of antenna was designed by NRI (1957) to minimize aircraft landing obstruction through low height design. The metallic support mast is grounded to allow the location of aircraft obstruction warning lights at its top, with power fed through the structure without the complication of an isolation transformer. Hundreds of these antennas have been installed throughout the world at air stations and communication stations of the several military services. Above is shown an installation at the Naval Air Station, Jacksonville, Florida, operating in the 2 to 8 MHz range.

This antenna comprises a number of radiating elements arranged around and connected to the top of a conducting support pole. The elements extend outward and downward to a point just below the level of the midpoint of the pole, and then downward and inward to a connecting ring about the base of the pole. Connecting cross-members extend from the midpoint of the pole outward to the radiating members to form an impedance transformer. This transformer provides an adequate impedance match for the shortened antenna at the lower end of its frequency band. The antenna is fed at a point between the ring and the pole. The antenna

provides a 3-to-1 frequency coverage with a voltage standing wave ratio not exceeding 3 to 1.<sup>189</sup> The design of the monopole antenna permits power to be fed through its grounded base and structure to aircraft obstruction warning lights at the top of the pole without the complication of a high frequency isolation transformer required with other antenna designs.

**Conical Monocone Antenna**

On some types of vessels the lower part of the sleeve antenna structure was found to be of such

## RADIO COMMUNICATION

size as to obstruct vision in docking. After further investigation, NRL developed the conical monocone antenna, which avoided the vision-obstruction difficulty (1959). The monocone antenna was first installed on the USS OBSERVATION ISLAND (1959). This

antenna received wide acceptance, and a great variety of new applications were found. This antenna comprised four sloping-wire radiating elements, supported and fed from the top of a central mast. An equal number of impedance-matching wires are disposed beneath the radiating elements.



### THE "CONICAL-MONOCONE" HIGH-FREQUENCY BROADBAND ANTENNA

This antenna was developed by NRL (1959) to minimize visual obstruction aboard ship caused by the structure of certain types of broadband antennas. A 48-to-1 scale model of the USS NORTHAMPTON is shown, with two sections of this type of antenna (upper 2 to 6 MHz, lower 6 to 8 MHz). It comprises four sloping-wire radiating elements for each frequency band, supported by a central mast. Three pyramidal sections are feasible for more complete coverage of the high-frequency band. This type of antenna has been applied to several classes of Naval vessels.

## RADIO COMMUNICATION

The antenna structure, when properly proportioned, provides coverage over a frequency range of 5 to 1 at any point in the high-frequency band, with a voltage standing-wave ratio not exceeding 3 to 1.<sup>140</sup> This antenna lends itself to the stacking of sections, so that with three sections, the lowest frequency section encompassing the other two, coverage of the entire high-frequency band (2-30 MHz) is feasible, and valuable deck space is conserved.

### High-Frequency Shipboard Antenna Radiation Characteristics

To preserve the broadband and azimuth radiation characteristics of antennas, their placement and that of other structural elements required aboard ship must be arranged to minimize interaction. During World War II, to improve antenna performance, the Laboratory made azimuth radiation pattern measurements of antenna installations on nearly 100 ships of various classes, including battleships, aircraft carriers, and communication ships (AGC class). These ships, just commissioned or overhauled, were sent to a point offshore at the Laboratory's Chesapeake Bay site to have the Laboratory assess the performance of their entire electronic systems before proceeding to their operational missions. The Laboratory also made such improvements as were possible in the time allocated. The antenna-pattern measurements were made by having the ships circle buoys anchored in the Bay, while instrumentation on shore made measurements, or by having a small craft carrying instrumentation circle the ship. The measurements disclosed many objectionable "nulls" in the patterns. The problem of making the necessary changes was found so involved that only limited adjustments of antennas could be made in the time available.

An NRL improvement in confirming shipboard installations utilizes a helicopter, with instrumentation suspended below and at sufficient distance to avoid field distortion. Ships can be circled quickly, and by making measurements at various altitudes, elevation patterns can be obtained. This method of

confirmation was first used on the USS NORTH-HAMPTON (1967).

To improve the shipboard antenna-design procedure, the Laboratory devised a model technique through which scaled models of antennas and ships were subjected to measurements to determine the best antenna placement configuration (1948). The Laboratory has used the model method to provide complete high-frequency antenna suits for many classes of Navy ships, including command ships, aircraft carriers, guided-missile ships (Type DLG), cruisers, mine sweepers, and support ships. Broad application was possible. The ship models included the various structural elements influencing antenna characteristics and were mounted on a flat metallic surface simulating the sea. Changes in models based on the measurements could be made quickly and easily, expediting the antenna placement design. At first, scale factors up to 120 to 1 were used. Later, to provide greater design accuracy the model size was increased so as to lower the scale factor to a maximum of 50 to 1. The arrangement resulting from the model work was confirmed by measurements on a full-scale installation aboard the particular ship for which it was designed.

The model technique has given excellent results, the performance of final shipboard installations corresponding quite closely to that of the models. It was first applied to the Guppy-type submarine (SS 350), in which the conning-tower structure was used as the sleeve section of a sleeve antenna (1948).<sup>141</sup> The structure was modelled with a scale factor of 24 to 1. A standing-wave ratio of better than 3 to 1 was obtained over a frequency range of 2.6 to 1 with the resulting antenna.

### High-Frequency Antenna Multiplexing

In using several transmitters and/or receivers simultaneously on a common broadband antenna, coupling circuits must be provided which will insure proper impedance match for the efficient transfer of energy and adequate isolation to

## RADIO COMMUNICATION



23131

### THE FIRST HIGH-FREQUENCY ANTENNA MODEL FACILITY

This facility was developed by NRL (1948) to accelerate the advance of antenna design. A 48-to-1 scale model of the USS NORTHAMPTON, with high-frequency sleeve antennas, is shown on a rotating platform in the center of an 18 by 18 foot ground screen. The antennas were driven from a generator below the platform, and the measurement probe was located in the structure to the extreme left on the screen. The measurement equipment was placed in the room below. This facility, located on the roof of NRL building 16, was the forerunner of a series of model facilities of increased capability. The model technique has been used in the development of antenna suits on many classes and types of Naval vessels.



70182

### NRL'S PRESENT HIGH-FREQUENCY ANTENNA MODEL FACILITY

This facility, developed by NRL (1967), is the largest in the United States. It is large enough to permit the use of models of adequate physical size and scale factor necessary for accurate measurements. It is the only facility adequately to determine the performance of wide-aperture antenna models. The facility comprises a 1000-foot-diameter ground screen, the center of which contains a turntable 15 feet in diameter. A 48-to-1 scale model of the type APD Command (or transport) ship is shown on the turntable. The turntable forms part of the roof of an underground building (34 x 34 x 9 feet high) which houses the measuring equipment and operating personnel. Measurement probes are located at appropriate points just above the ground screen. The screen is of such design and size as to minimize reflections from its edge, which would cause serious inaccuracies in measurements.

avoid interactions among equipments. Minimum channel spacing to allow the maximum number of communication channels and minimum energy loss in coupling networks are of importance.

#### Transmitter Multiplexing

The transmitter multiplexing problem is particularly critical, since high power in coupling circuit components is attended with the generation of heat, which may be difficult to dissipate, and high voltage, which may cause breakdown. Early work on this problem resulted in a filter technique which permitted the operation of three lower frequency transmitters on one antenna for the first time (1922).<sup>142</sup> This technique was first applied to the high-frequency band using the Models TU (200 to 400 kHz) and TAF (2 to 18.1 MHz) transmitters (1930).<sup>143</sup> It was demonstrated on the USS TEXAS with the Models TO (0.5 to 1.5 MHz) and TV (2 to 3 MHz) transmitters (1930) and applied later on the USS SARATOGA and USS DETROIT (1931).<sup>144</sup> The technique was

incorporated in the Model XZ antenna duplex coupling system and applied to other ships (1932).<sup>145</sup> The technique, however, required quite wide separation between frequency channels and had high efficiency only for the lower frequency transmitter. Because of complexity in making adjustments, it was limited in use to two transmitters on a common antenna in shipboard applications.

In later work, the Laboratory was first to devise a transmission line-series coupling technique by means of which transmitters were coupled at intervals along a concentric transmission line to its inner conductor through small openings in its outer conductor (1946).<sup>146</sup> Antenna multicouplers employing this technique became standard equipment in a variety of shipboard installations (AN/SRA-13, 14, 15, 16). For the high-frequency band, low-loss resonant circuits connected to the transmitter were arranged to couple to loops inserted in series with the inner conductor of the transmission line. With this technique, four high-frequency transmitters could be operated on a common antenna with a

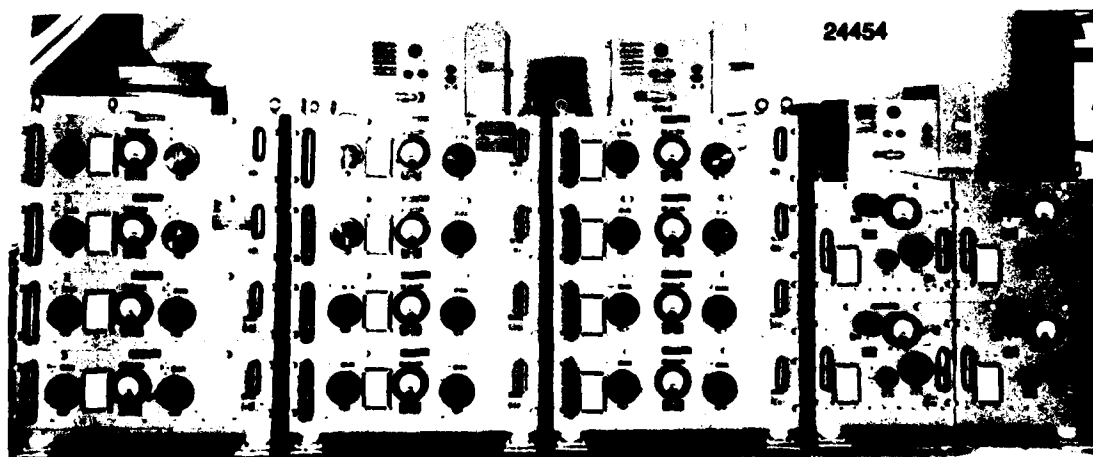

**HIGH-FREQUENCY TRANSMITTER MULTICOUPLERS**

These multicouplers incorporating an NRL-developed technique were first to permit the simultaneous operation of four transmitters on a common antenna (1959). They provided frequency channel isolation of 20 dB at 10 percent frequency separation. In 1964 they were modified by NRL to permit the operation of eight transmitters with 40 dB isolation at 5 percent frequency separation. Left to right are the Models AN/SRA-13, 14, 15, and 16.

## RADIO COMMUNICATION

frequency separation of 10 percent, an isolation of 20 dB, and a nominal power loss of 1 dB (1950).<sup>147</sup> This isolation was adequate to prevent interaction between transmitters. Multicouplers incorporating the transmission-line-coupling technique were first installed on the submarine USS IREX using three high-frequency transmitters (1950).<sup>148</sup> An extensive installation of multicouplers employing the technique was made on the USS NORTHAMPTON (1953).<sup>149</sup> These couplers permitted the use of four transmitters on each of five broadband antennas and gave coverage of the entire high-frequency band.

A serious difficulty was encountered in determining adjustments which would provide proper impedance match between the transmitters and the antenna. This problem was solved by devising a reflectometer which was inserted in each of the transmission lines connecting the transmitters to their respective coupling units (1947).<sup>150</sup> This reflectometer comprised a short wire placed parallel and close to the inner conductor of the transmission line. The wire was arranged so that the voltages caused in it due to inductive and capacitive couplings by the outward flowing energy were balanced. This device permitted sensing the reflected energy, which was of reversed phase with the inductive coupling but not with the capacitive coupling. A microammeter and diode connected to the short wire permitted observation of the amount of reflected energy and adjustment of impedance to reduce this energy to a minimum.

Voltage breakdown between the surfaces of variable air capacitors used to tune the resonant circuits of multicouplers was a further difficulty encountered in their development. The spacing of the surfaces could not be increased without increasing physical size beyond that permissible at the operating frequency. To overcome this difficulty NRL, with the cooperation of a contractor (Jennings Co.), developed a high-power, vacuum variable capacitor using a bellows mechanism to provide the variation of capacitance without disturbing the vacuum seal (1949). This structure permitted close spacing of surfaces with corresponding compactness and a capability

of withstanding high voltage. The surfaces of the capacitor were so contoured as to minimize losses. This vacuum type of variable capacitor was first used in the high-frequency multicoupler of the USS NORTHAMPTON installation (previously described) at a 1/2-kW power level. A capacitor of further improved design was included in the NRL-developed multicoupler AN/FRA-49 (V) which permitted operation, for the first time, at the 10-kW level in the 2 to 6 and 5 to 15 MHz bands. This type of multicoupler was first installed at the Naval Radio Station, Annapolis, Maryland, where three 10-kW transmitters were operated on one antenna (1956).<sup>151</sup> Subsequently, it was installed at other shore stations. A 10-kW multicoupler capability in the 10 to 30 MHz band was first attained by employing a coaxial transmission line type of resonator in combination with the new capacitor. This capability was first provided the communication ship USS ANNAPOLIS (1964).<sup>152</sup> The vacuum variable capacitor found wide use in various applications.

Doubling the number of transmitters which could be operated on a common antenna was made possible through NRL's development of a multicoupler with dual-mesh resonant circuitry and a combining network which provides impedance compensation (1959).<sup>153</sup> With this new multicoupler, eight transmitters could be accommodated on one antenna. The isolation between channels was also doubled to 40 dB, with a frequency separation of 5 percent. The insertion loss was nominally 2 dB. Previously developed multicouplers AN/SRA-13 and AN/SRA-14 (1/2 kW) were modified to include this new combining circuitry to obtain the eight-channel performance.<sup>154,155</sup> Initial installations of these were made on board the USS ESTES (AN/SRA-14) (1964) and the USS NORTHAMPTON (AN/SRA-13) (1965). Ten-kilowatt multicouplers resulting from this work (AN/SRA-35, 36, 37) were procured (Naval Gun Factory, Washington, D.C.) and first installed on the communications ships USS WRIGHT (CC-2) (1963). The AN/SRA-36, 37, and 38 multicouplers for 1-kW operation util-

ized the new circuitry, which was useful in multicoupler design.

### Receiver Multiplexing

Prior to 1923, radio reception aboard ship simultaneously with transmission was generally unsatisfactory due to the interference caused by spark and arc transmitters. The elimination of these types of transmitters was an important step in making simultaneous operation possible. Another important step was the Navy's decision, based on NRL reception work, to locate shipboard reception facilities forward and transmitting facilities aft, which provided considerable isolation of the two functions. Partial separation of these facilities was first accomplished on the battleship USS WYOMING, then the flagship of the scouting fleet (1923). A more comprehensive separation was next made on the battleship USS COLORADO. The arrangement was adopted and specified in the Navy's standard plans for ship installations (1923).<sup>166</sup>

Laboratory staff members prior to their transfer to NRL devised a "coupling tube-resistor network" system for receiver multiplexing with which up to eight receivers could be operated simultaneously on one aperiodic antenna without interaction (1922).<sup>167</sup> This system was installed on the USS WYOMING and successfully demonstrated by NRL during fleet maneuvers in the Caribbean Sea and in Pacific waters in the early part of 1923. In view of this demonstration the Navy issued standard plans for the installation of the system specifying eight receivers on the larger ships.<sup>168</sup> This receiver multiplexing system performed acceptably at the lower frequencies and also in the high-frequency band as the latter came into general Navy use. The system found extensive application throughout the service and continued to be used long after World War II.

In recent years the Navy's requirements for ship communication channels had greatly increased, necessitating the closer spacing of receiver channels with respect to each other and

also with respect to local transmitting channels. This, together with increased transmitter power level, made imperative much greater selectivity and linearity in multicouplers. While both transmitters and receivers can be satisfactorily operated simultaneously on the same antenna at low power, the high transmitter power used on shipboard makes the isolation of 20 dB and more, secured by proper spacing of transmitting and receiving antenna, of considerable value. However, in spite of this isolation, reliance must be placed heavily on the performance of multicouplers to avoid receiver intermodulation and injury to components which may result from the several hundred volts likely to be induced in the receiver system during transmission.

The first substantial step in advancing receiver multiplexing performance, over that of the early coupling tube-resistance network system, was the result of NRL's adaptation of its new multi-mesh resonant circuitry technique, previously developed for transmission. Its use in receiver multicouplers provided 40 dB isolation at 5 percent frequency spacing from an adjacent transmitter channel, and made possible accommodation of up to ten receivers on one antenna. NRL developed multicouplers including this technique which were designated the CU-1573 (2 to 6 MHz), CU-1574 (6 to 18 MHz), and CU-1575 (10 to 30 MHz) (1961).<sup>169</sup> First installations were made on shore at U.S. Naval Communication Station, Keflavik, Iceland (1961) and on the missile ship USS NEWPORT NEWS (1963).

The next important step for multicouplers was NRL's provision of a terminated transmission line-combining network technique which permitted up to 20 receivers to be used on a single antenna (1966).<sup>169</sup> Multicouplers utilizing this technique, such as the AN/SRA-38, 39, 40, 49, and 50, were obtained under formal procurement for wide Navy use (Pickard and Burns). A third step involved NRL's development of radio-frequency energy-level-sensing and fast-acting overload devices and their embodiment in multicoupler input circuits (1961).<sup>169,161</sup> These devices cause the receiver input circuits to be isolated when induced voltages from

**HIGH-FREQUENCY RECEIVER ANTENNA MULTICOUPLER**

This multicoupler, developed by NRL (1961), provided a substantial advancement in receiver multiplexing. Its use permits up to ten receivers to be accommodated on a common antenna, with 40 dB isolation at 5 percent frequency separation from adjacent transmitting channels (types CU-1573, 2 to 6 MHz; CU-1574, 6 to 18 MHz; CU-1575, 10 to 30 MHz). This multicoupler has been widely used in shore and shipboard installations.

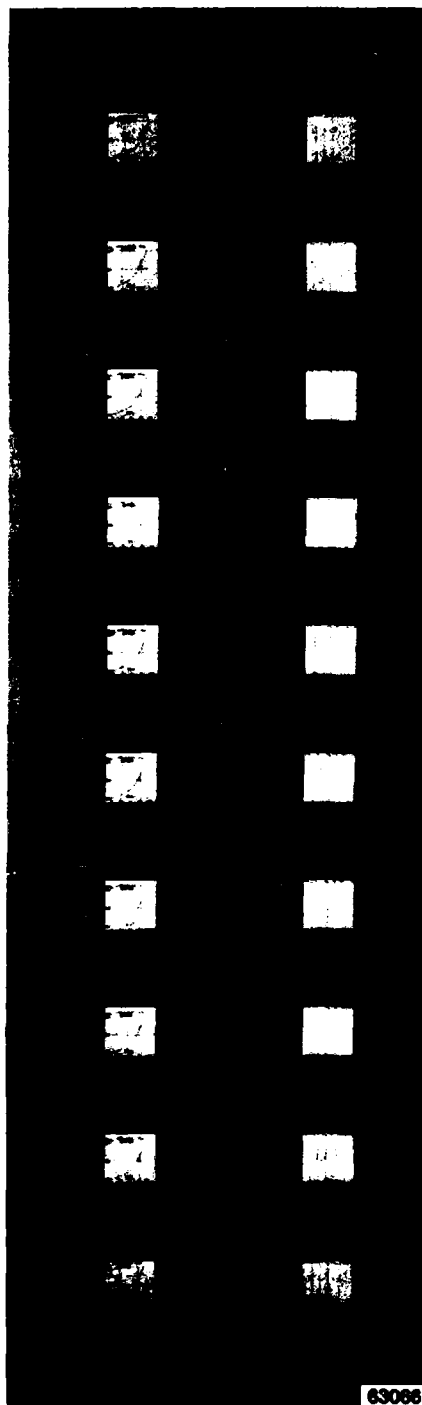

63066



transmitters reach a level of about one volt, thus protecting the receiver system against injury. The devices also provide automatic restoration of operation when the voltages are removed. Through these steps, in combination, NRL provided the first receiver multicoupler system to accommodate up to 20 receiver channels on one antenna having 40 dB isolation at 5-percent frequency spacing with overload protection (1964). The techniques devised were proven to be of value in receiver multicouplers.

High-Frequency Communication from Submerged Submarines

The high-frequency band has been the only means of long-distance communication used by submarines since NRL demonstrated its practicality for such use in 1928. Since the attenuation in seawater is very high at these frequencies, the submarine's antenna must be exposed above the surface of the sea for effective radiation. With the antenna extended above the periscope and supported from it, communication could be maintained while running at periscope depth with low probability of detection by an enemy.<sup>74</sup> However, in performing certain functions submarines must be able to communicate on high frequencies from greater depths. In dealing with the problem of communication from submarines in submerged positions, NRL was first to devise a towable communication buoy, releasable by a submarine while underway, carrying an antenna which was maintained in a vertical position just above the surface of the sea (1957). This device was further improved by NRL and was widely used. The tow cable was arranged to provide a means of transmitting the high-frequency energy between the antenna and the transmitting and receiving equipment located within the submarine. Early models of this communication buoy were procured in sufficient quantity to equip a squadron of submarines, the USS *BLENNY* receiving the first installation (1957). In tests at sea, satisfactory communications were established from ship to ship and ship to aircraft. The buoy displayed



**FIRST TOWABLE HIGH-FREQUENCY SUBMARINE COMMUNICATION BUOY**

This NRL-developed buoy was first to permit high-frequency communication from submarines while submerged at depths down to 110 feet and while running at speeds up to 8 knots. It also had UHF communication capability. The buoy is shown installed on the submarine *USS BLENNY* (1957).

desirable hydrodynamic properties while being towed at eight knots from a depth of 110 feet. It was found very difficult to spot the buoy visually from the air.

In the first trials, difficulties were experienced in releasing and retrieving the buoy due to the lack of a suitable winch-buoy nesting mechanism.<sup>102</sup> A winch-buoy assembly was designed which permitted the buoy to be streamed and retrieved satisfactorily from the submarine deck. A remote-control system including a buoy-depth indicator was provided which allowed the buoy to be placed in proper position relative to the sea surface from the radio room. The

## RADIO COMMUNICATION

system provided compensation for variations in sea state, changes in depth and speed of the submarine, and the maintenance of proper cable tension to avoid failure and loss of the buoy (1960).<sup>163</sup> This communication buoy system became known as the AN/BRA-10 (1962). Its operational effectiveness was strikingly demonstrated aboard the USS CAVELLA during the Cuban crisis (1962). In maintaining a sonar barrier at proper submersion depth, the submarines not equipped with the buoy had to sur-

face periodically to make their reports. This required relief by another submarine, to avoid a gap in the screen. The USS CAVELLA, equipped with the buoy, was able to maintain continuous surveillance, reporting whenever necessary.

Certain operational modes of submerged submarines require high-frequency communication from greater depths while underway at higher speeds. Substantially increasing the length of the tow cable would cause such loss in the transmission of power as to make it impractical to leave the transmitting and receiving equipment within the submarine. To obviate this difficulty, active transceiver components were designed of sufficiently small size, light weight, and flexibility as to make possible their inclusion in the body of the buoy. Remote controls operable from the radio room were provided for such functions as frequency channel selection, fine tuning, modulation selection, and transmit-receive switching.

To contend with higher speeds and greater depths, the displacement type buoy formerly used was replaced by a "dynamic winged" buoy designed with a high lift-to-drag ratio. Placing the transceiver components in the buoy permitted a reduction in the diameter of its tow cable, with correspondingly lower cable drag. A fairing of polyurethane filaments was arranged along the tow cable so that voids in the water stream are filled, further reducing the drag and also minimizing vibration and wake. The new buoy system was designated the AN/BRA-27. In trials on the submarines USS SEACAT, TRUTTA, and TIRANTE this buoy system proved to have excellent hydrodynamic performance when towed at the higher speeds from greater depths, maintaining satisfactory stability in a state 4 sea (1963-1967).<sup>164</sup> Later models were improved to reduce drag effects and proved their efficacy in service.



### IMPROVED TOWABLE HIGH-FREQUENCY COMMUNICATION BUOY SYSTEM

This buoy system (AN/BRA-10), developed by NRL (1960), permitted full control from the submarine's radio room while underway. It is shown installed on the USS CAVELLA, nested in its winch mechanism, from which it could readily be streamed, retrieved, and maintained at proper submergence depth. Its operational effectiveness was strikingly demonstrated aboard the USS CAVELLA during the Cuban crisis (1962). This buoy also had an IFF capability, a UHF communication capability, and a VLF reception capability.

### Transosonde System

Prior to 1952, vast ocean areas were without weather-data-collection facilities adequate to

## RADIO COMMUNICATION



### **"DYNAMIC-WINGED" TOWABLE HIGH-FREQUENCY SUBMARINE COMMUNICATION BUOY SYSTEM**

This "dynamic-winged" type buoy (AN/BRA-27) replaced the former displacement type. It could be towed at higher speeds and at greater submersion depths. It was first to have the transceiver components located in the buoy body, resulting in reduced radio-frequency loss and increased communication performance. Developed by NRL (1963-1967), a model is shown installed on the USS ATULE. This buoy also had a capability for IFF, for UHF communication, and for VLF reception.

## RADIO COMMUNICATION

provide reliable weather forecasts necessary for the determination of flight plans for the rapidly increasing aircraft activities over these areas. In forecasting, reliance had to be placed on the projection of data collected in adjoining areas and the historical knowledge of the development and movement of storm centers within these areas. The rapidly changing nature of weather patterns often rendered such forecasts unreliable and misleading. To improve the accuracy of weather forecasts, the Laboratory developed the "Transosonde" system (transoceanic sounding), in which a balloon-borne high-frequency transmitter provided signals for tracking the equipment in flight by a network of radio direction-finding stations, and means for the transmission of telemetered meteorological data from sensors on the flight equipment (1952). NRL's Transosonde system provided an important pioneering step in advancing means to deal with large-scale weather patterns. Worldwide interest in the use of the system prevails. In one effort, horizontal balloon flights, patterned on NRL's system, are currently being made in the region of the southern hemisphere by the National Center for Atmospheric Research at Boulder, Colorado, to collect data in the conduct of advanced meteorological investigations.<sup>165</sup>

In operations, with the Transosonde system, the equipment was floated across inaccessible ocean areas on a constant-pressure surface in the upper air currents, periodically reporting the data. Wind speed and direction were derived from the positioning data obtained by the tracking network. Other meteorological parameters were telemetered to the ground stations as code modulations of the radio signals. The feasibility of this system was first demonstrated in a series of ten transcontinental flights from Tillamook, Oregon (1952).<sup>166</sup> These flights, made at a 300-millibar constant-pressure level (approximately 30,000 feet), ranged up to 130 hours in duration and 7000 miles in distance. Experience with these flights and others,<sup>167</sup> with modifications of the equipment, served to guide NRL's development of a system which attained operational status

in 1957 when the Navy began launchings of Transosonde equipment from Japan.

This first operational system comprised a 39-foot-diameter polyethylene, tear-shaped, helium-filled balloon with a gondola attached immediately below containing a 50-watt, crystal-controlled, high-frequency radio transmitter, battery power supply, and meteorological equipment. The antenna was suspended vertically below the gondola with tuned wave traps spaced along the antenna to provide proper resonant lengths for each of the three transmitting channels. Transmissions were made every one to two hours for a period of about five minutes successively on three frequencies in the band 6 to 18 MHz, to give both day and night coverage at various distances. Flight altitude was maintained at  $30,000 \pm 1000$  feet through the use of air-pressure sensors which controlled the release of solid iron shot ballast from a bin in the gondola. The gondola was maintained within acceptable temperature range through suitable thermal insulation. The equipment weighed a total of approximately 600 pounds, with five cubic feet of instrumentation volume.

The Transosonde system went into operational status during the period June 1957 to May 1959, with a total of approximately 250 flights from Japan. Most of these flights were successful and passed over the Pacific Ocean and parts of the North American continent, some reaching the Arctic area. Up to 18 radio direction-finding stations located in the United States (two in Alaska, one in Hawaii) made the radio bearing observations and recorded the data. The data collected were utilized by both the Navy and the U.S. Weather Bureau in the preparation of weather maps regularly issued. The data collected over the period were subjected to extensive analysis and has served to provide a substantial gain in the understanding of large-scale upper-air circulation.<sup>168</sup>

To avoid the hazard which the weight and size of this Transosonde equipment might impose if collision with aircraft occurred, equipment flights were made at 30,000 feet, an altitude above the normal aircraft flight lanes at that

## RADIO COMMUNICATION

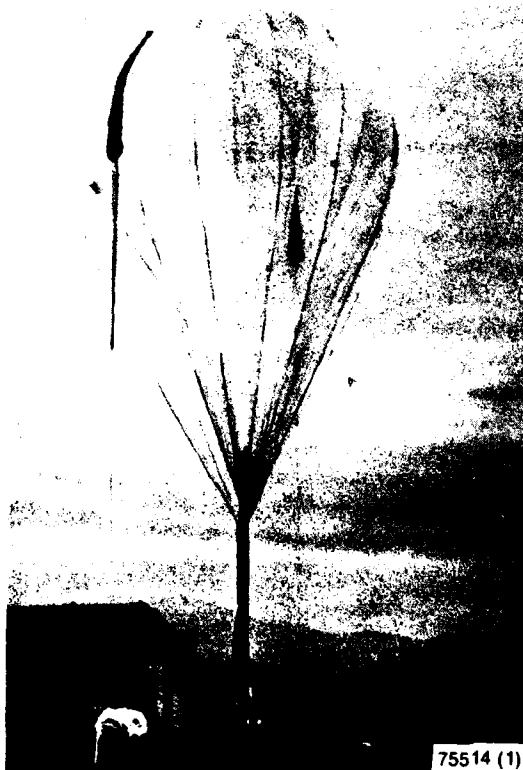

75514 (1)

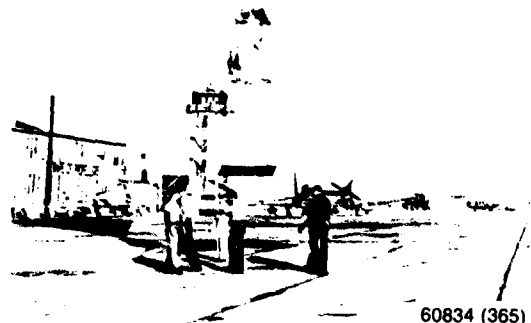

60834 (365)

### THE TRANSOSONDE SYSTEM

The Transosonde (trans-oceanic sounding) system was developed by NRL for high-altitude data gathering in those parts of the world otherwise relatively inaccessible to standard meteorological instrumentation, particularly over extensive ocean areas. The photograph at the left shows a launching from Tillamook, Oregon (1952), of an early Transosonde. The balloon carried meteorological sensing instruments and high-frequency radio transmitting equipment. The latter provided signals for tracking by a network of radio direction-finding stations and for the transmission of the meteorological data to these stations. A series of ten transcontinental flights at 30,000 feet altitude, ranging to 7000 miles, proved the system's feasibility. The Transosonde shown to the right is being launched from Fallon, Nevada, for the purpose of training Navy personnel in its use, preparatory to a series of launchings from Japan (1956). The equipment comprised a 39-foot-diameter polyethylene, helium-filled balloon with a gondola carrying a 50-watt, crystal-controlled, high-frequency transmitter, battery power supply, and meteorological sensing devices.

## RADIO COMMUNICATION

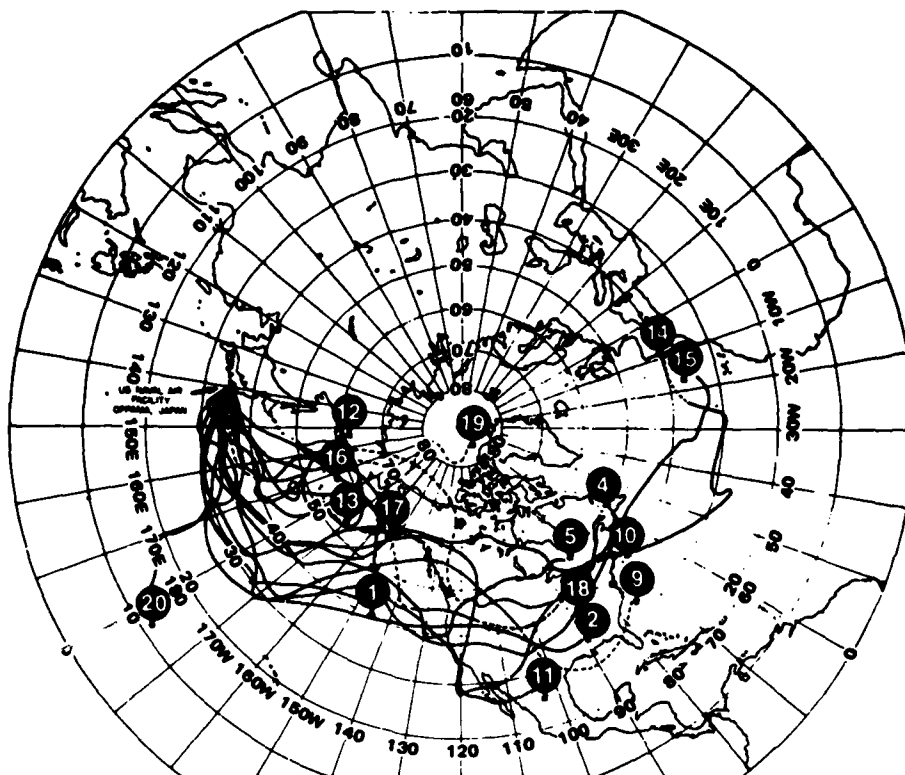

75514 (3)

### TRANSOSONDE SYSTEM-OPERATIONAL LAUNCHINGS

Several flight paths are shown here which typify the 250 flights launched from Japan during the period from June 1957 to May 1959.

time. The advent of jet aircraft flying at increasingly higher altitudes led to the development of equipment of greatly reduced weight and size which could be used in regular aircraft flight lanes without causing serious injury if hit.<sup>169</sup> The equipment evolved consisted of a spherical plastic balloon (12.5 feet diameter, weight about 20 pounds) and two thermally insulated, plastic-enclosed instrument packages (weight six pounds each) hung below the balloon, with considerable space between them. The radio transmitter provided an output of about 30 watts on two frequencies (approximately 6.7 and 15 MHz) for 50 transmission periods,

each of three minutes duration. Ambient pressure, ambient air temperature, and balloon super-pressure were monitored. The development of plastic material (Mylar), used for the balloon surface, having sufficient strength to withstand the stresses involved in the use of a fully pressurized container, permitted the maintenance of the proper flight altitude without the shot-ballast system required with the earlier open-appendix (nonpressurized) balloon. A series of 50 experimental flights with this lighter weight Transosonde equipment were carried out over the Atlantic Ocean, with launchings from Webster Field, Maryland. A high percentage of

## RADIO COMMUNICATION



### LIGHTWEIGHT TRANSOSONDE SYSTEM

Fifty experimental flights over the Atlantic were made with this system, comprising a 12.5-foot (20-pound) balloon and two instrument packages (6 pounds each). It was developed (NRL, 1959-1961) to avoid serious hazard should collision with an aircraft occur.

these flights were successful (1959-1961). To avoid invading airspace over the European continent, the flight duration was restricted to a maximum of 100 hours (four days). These flights demonstrated that when properly utilized, this equipment offers a low-cost, reliable means of meteorological data collection for extended periods over large areas of the world.

### COMMUNICATION IN THE VERY-HIGH AND ULTRA-HIGH FREQUENCY BANDS

#### Introduction

In exploring the utility of the frequencies above the high-frequency band (2 to 30 MHz)

for short-range communication, experiments at frequencies as high as 300 MHz using vacuum-tube transmitters and receivers were carried out by NRL staff members prior to moving to NRL's present site (1922).<sup>170</sup> The techniques then available for power generation, frequency control, modulation, and reception limited the performance of the system, which was not sufficiently attractive for Naval operational application. In continuing the exploratory work at NRL, the upper-frequency limits of the ionosphere were probed to determine the extent of its effectiveness in providing long-distance communication (1923-1936).<sup>11,171-173</sup> It was found that, while at times some energy was returned to earth at frequencies as high as 60 MHz, transmission generally became very erratic and difficult to

## RADIO COMMUNICATION

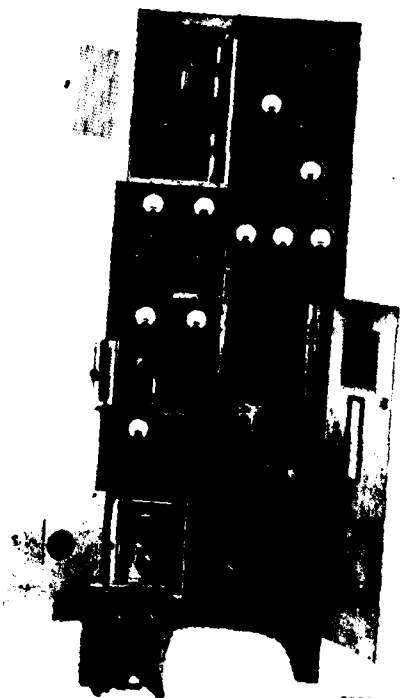

60834 (366)



### THE NAVY'S FIRST VERY-HIGH-FREQUENCY RADIO COMMUNICATION SYSTEM - THE MODELS XP-XJ (1929)

Operational use of this NRL-developed system on several battleships and aircraft carriers, and on a submarine, convinced the Navy of the utility of the VHF band for limited-range Fleet communication. The system covered a frequency range of 14 to 75 MHz. The Model XP transmitter is shown at the top, and the Model XJ-2 receiver is at the bottom. The receiver was the first to employ shielded grid tubes, which made possible excellent amplification at radio frequencies. The unit in the lower left corner of the transmitter is the temperature-control component, which contains eight quartz crystals for frequency control.



## RADIO COMMUNICATION

predict above 25 to 30 MHz. Observations made during a considerable portion of the 11-year sunspot cycle indicated that sunspot activity had at times marked influence on propagation, particularly in the band 20 to 40 MHz.

### Very-High-Frequency Band (VHF)

After the Navy adopted high frequencies, it surrendered to other interests eager to obtain them some of its lower frequency communication channels not so well adapted to shipboard installation because of the large amount of space that the equipment occupied. The higher frequencies appeared to offer many additional channels as needed. The Navy had become interested in knowing when it was safe to use these higher frequencies for limited-range communication, without fear of being intercepted by a distant enemy. NRL's results had indicated that if the return of energy from the ionosphere to earth during all phases of the sunspot cycle were to be avoided, it would be necessary to use frequencies above 60 MHz. On some occasions it had been possible to use very low power on 40 MHz for transcontinental transmissions. On the other hand, there were times when frequencies as low as 25 MHz were not transmitted beyond line-of-sight paths. To obtain additional propagation data, particularly over all seawater paths, and to provide the Navy with operational experience, NRL developed the Navy's first very-high-frequency (VHF) communication system (1929).<sup>173a, 174</sup> The operational use of this system convinced the Navy of the utility of the VHF band for limited-range communication in the Fleet.<sup>175</sup> This system comprised the Model XP transmitter, later XP-1, 2, 3 (500 watts, 14 to 75 MHz) and the Models XJ-1 and XJ-2 (4 to 50 MHz) and Model XV (42 to 100 MHz) receivers. The transmitter, designed for continuous-wave operation, was crystal controlled with three stages of amplification which were also used for frequency multiplication. The Model XJ receiver was first to employ "shielded-grid" vacuum tubes and first to provide substantial radio-frequency amplification above 8 MHz, as com-

pared with the previously used triode tubes with "balanced" circuitry, which gave relatively little gain. Even for the high-frequency band, it was the first receiver to provide circuit stability and freedom from circuit reaction, microphonics, and erratic control equal to that which had been attained in lower frequency receivers. The frequency range of reception was extended further upward with the development of a superregenerative receiver, designated the Model XV (1932). While these equipments were primarily intended to provide operational experience above the high-frequency band, the overlapping portion of the range was useful in acquiring additional propagation data in this band.

Major radio commercial manufacturers had been approached on the development of the Model XP, but they stated that they had so little experience in the field that they preferred not to undertake the work. Consequently, NRL constructed a number of transmitting and receiving equipments which were installed on the USS CALIFORNIA (Dec. 1929), TEXAS, PENNSYLVANIA, ARIZONA, DETROIT, and HOLLAND, and the aircraft carriers USS SARATOGA, WEST VIRGINIA, and LEXINGTON. Since it was desired to use voice communication with aircraft, the carriers were provided with voice modulation units.<sup>173b, 176</sup> These equipments were used on ship-ship and ship-shore circuits over a period including World War II and resulted in the collection of valuable propagation data. The results led to the quantity procurement of the VHF equipment known as the Model TBS, including both transmitter (40 watts, 60 to 80 MHz) and receiver (1938).<sup>177</sup> These equipments, installed on all the larger Navy ships and on many of the smaller ones, served as an outstanding intership communication system during World War II, doing its part in the carrying out of tasks such as amphibious landings and convoy duty.<sup>178</sup> The system remained in service for over a decade after the war.

The prospect of a large increase in the number of Naval fighter aircraft operating from carriers, the comparatively short range of operation of such craft, and the relatively high altitude at

## RADIO COMMUNICATION

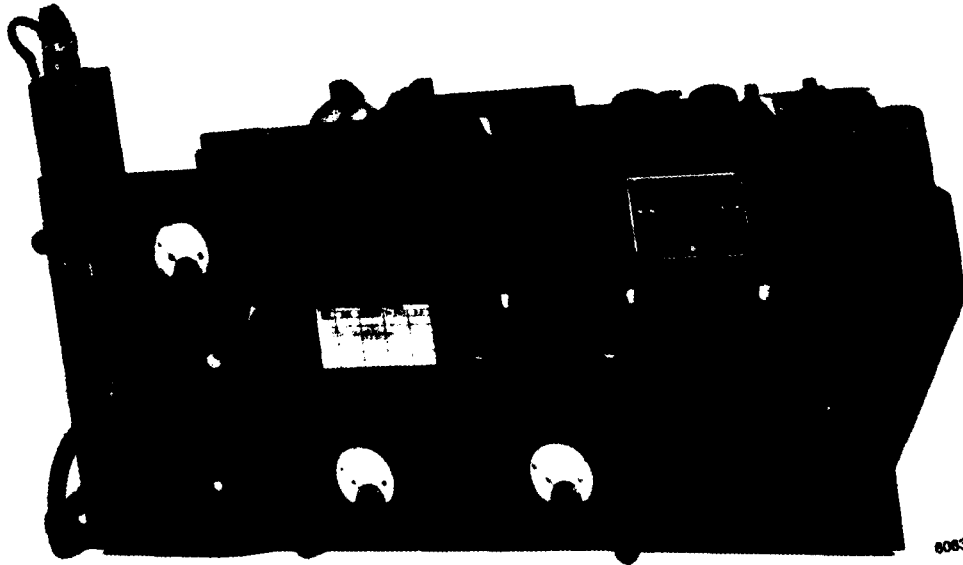

60834 (326)

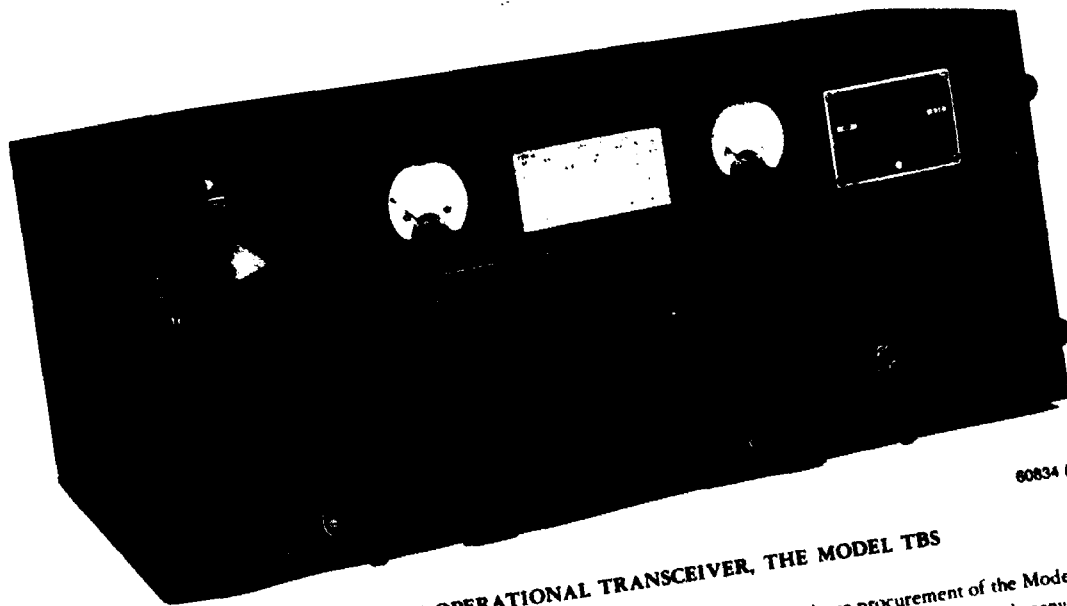

60834 (321)

### THE FIRST VHF OPERATIONAL TRANSCEIVER, THE MODEL TBS

The Fleet's operational success with the NRL-developed Model XP equipment led to large procurement of the Model TBS transceiver (60 to 80 MHz) (1938). These equipments, which were installed on all the larger Navy ships and many of the smaller ones, served as an outstanding tactical-communication system during World War II, and contributed importantly to the success of amphibious landing and convoy operations. The transmitter is shown above, the receiver below.

## RADIO COMMUNICATION

which they flew were strong points in favor of the use of the VHF band for air-ship and air-air communications. The higher flying speeds of new aircraft required the abandonment of the long trailing wire and the large fixed-wire antennas to reduce drag. The short antenna which radiated efficiently in the VHF band could be streamlined, materially increasing the speed and maneuverability of the aircraft. As a step toward realizing these advantages, NRL developed the Navy's first very-high-frequency (VHF) aircraft communication system, Model GL, 1 watt, 52 to 60 MHz (1931).<sup>172, 176, 179</sup> A preliminary model of the system (Model XT) was developed (1930) using modulated continuous waves which required keying. Aircraft pilots objected to the additional burden of keying, so the system was modified to include voice modulation. The Model GL equipment was also

the first aircraft-communication equipment to be powered by a generator driven directly by the aircraft engine, without the use of batteries as was formerly the case. The Model GL equipment was reproduced in quantity and sent to the Fleet for service use.

Naval aviation interests wished to proceed to still higher frequencies for airborne communications. NRL had succeeded in developing transmission, reception, and radiation techniques with suitable frequency control at frequencies up to 200 MHz.<sup>180</sup> As a result, the Laboratory provided technical information and guidance to contractors in procurement of the Model AN/ARC-1 transceiver for aircraft installation (ten watts, ten channels, 115 to 156 MHz).<sup>181, 182</sup> This equipment, the first of its kind, became available in May 1943 and was the principal equipment used by the Navy and other services for aircraft

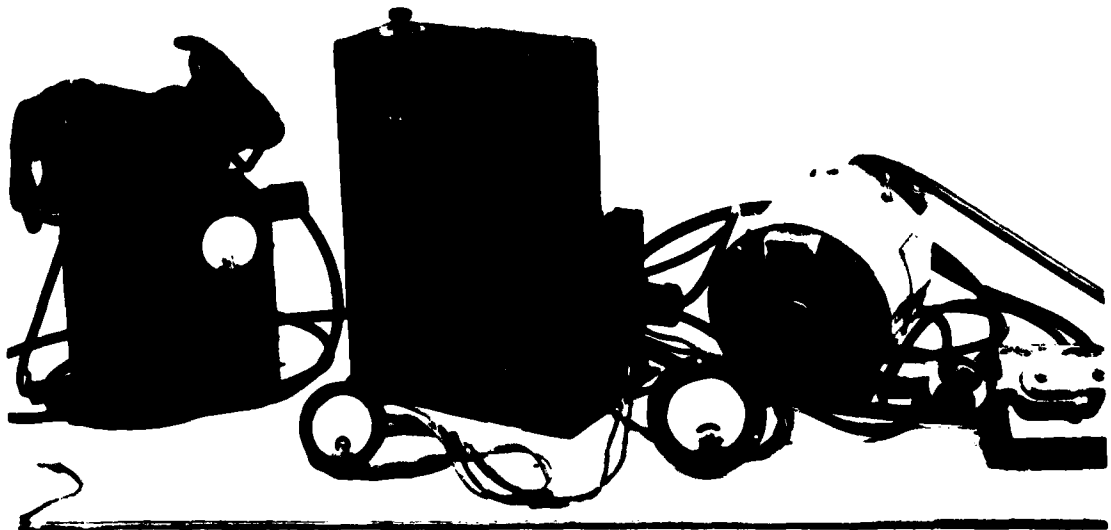

60834 (H-1)

**THE NAVY'S FIRST VERY-HIGH-FREQUENCY AIRCRAFT  
COMMUNICATION SYSTEM (1931)**

This system, developed by NRL, covered a frequency range of 52 to 60 MHz. It was designated the Model GL.

## RADIO COMMUNICATION

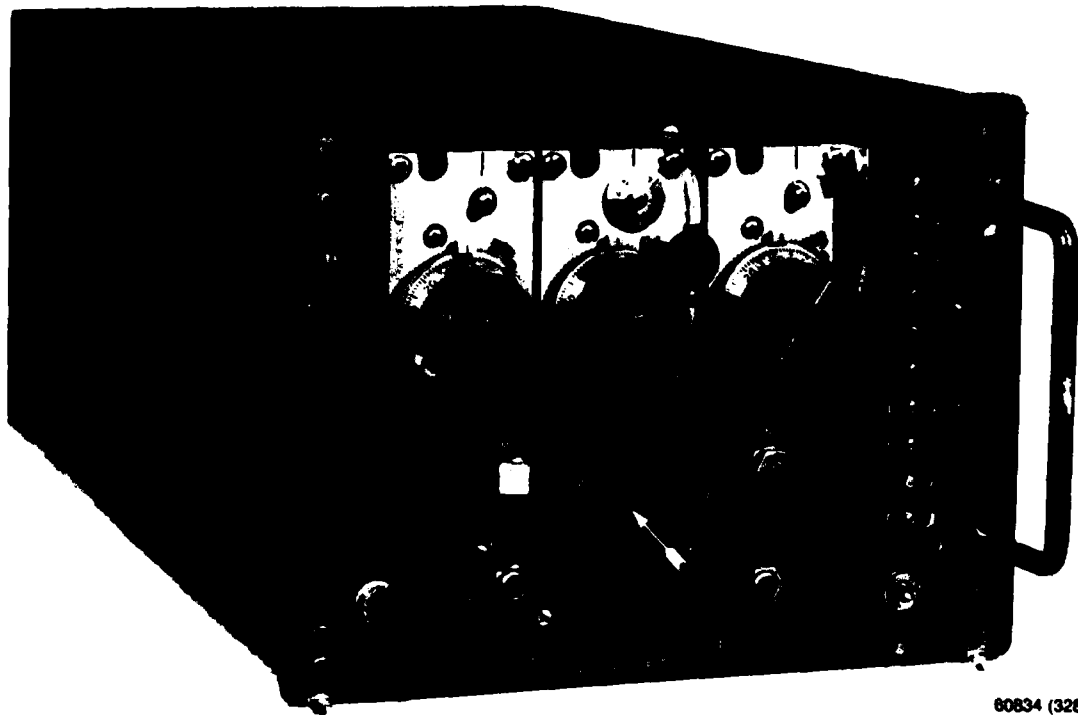

60834 (328)

**AIRCRAFT COMMUNICATION TRANSCEIVER, MODEL AN/ARC-1**

This transceiver was the principal airborne communication equipment used by the Navy and other military services during World War II. NRL participated in its development (1943). More than 70,000 of these equipments were produced by the end of the war.

communication during World War II. More than 70,000 equipments were produced by the end of the war. Many of these continued in use long after the war, until equipment in the ultra-high-frequency band became available in adequate quantities. For the ship and shore terminals of the system, the Laboratory developed the first VHF shipborne operational receiver, Model RCK, 115 to 156 MHz, superheterodyne (1943), of which 3000 were procured.<sup>183</sup> The Laboratory also guided contractors in the procurement of the transmitter, Model TDQ, 45 watts, 115 to 156 MHz (1943).<sup>184</sup> Certain portions of the very-high-frequency band were found to be very attractive for a variety of amphibious and short-range, land-based operations.

### The Ultra-High-Frequency Band (UHF)

#### Introduction

The allocation of frequency channels between 30 and 300 MHz was first considered by the nations of the world at the International Telecommunications Conference held in Cairo, Egypt in 1938, with representatives of seventy nations participating.<sup>185</sup> The channel requirements for aircraft and television were given particular attention. Television proponents were seeking channels in the VHF band already occupied by the Navy. The Navy, having equipped itself for tactical communications in this band, was in no position to relinquish it, particularly with war imminent. During the war,

## RADIO COMMUNICATION

in preparation for postwar planning, the Navy conducted a study of its requirements for amphibious operations (Project Overlord) and determined that it needed many more frequency channels than the VHF band could accommodate.

### UHF Equipment

NRL had continued its progression to the higher frequencies, devising means of power generation, frequency determination and control, amplification, and selectivity in what later

was to become the ultra-high-frequency band.<sup>186,188,189</sup> The energy-collection loss inherent in the shorter antenna which had to be used at UHF as compared to VHF had to be overcome by increased transmitter power and receiver sensitivity; nevertheless the inducement of many more channels at UHF was strong. NRL developed the Navy's first shipboard UHF communication system operating on frequencies as high as 500 MHz (15 watts) (1936). This system, was first installed on the USS LEARY for operational trials (1937). The system was installed on Naval aircraft for the

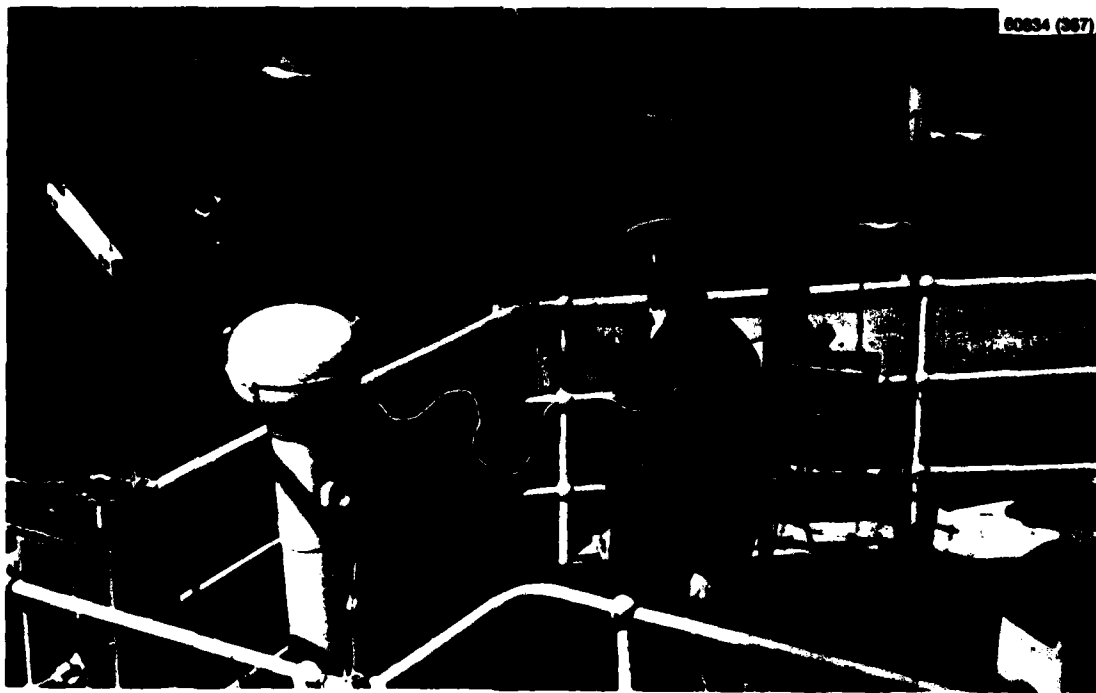

SHIP BRIDGE-TO-BRIDGE RADIO COMMUNICATION

During the Fleet's cruise in southern waters early in 1938, NRL conducted experiments to determine the feasibility of using VHF and SHF for bridge-to-bridge communication between Naval ships. NRL's 500-MHz communication equipment is shown just back of the ship's communication officer, LT Charles Horn (later ADM Horn), on the bridge of the battleship USS NEW YORK. At the extreme left is shown NRL's 100-MHz communication equipment. Results indicated that satisfactory communication could be obtained out to a range of about 25 percent beyond the horizon. The work was followed by development and production of communication equipment in the 200-MHz band.

## RADIO COMMUNICATION

first time, giving satisfactory communication over a range of 25 miles from plane to ground (1937). NRL's work demonstrated the feasibility of utilizing the UHF band for Naval communications. The UHF band received considerable emphasis by the United States and its allies as the principal frequency band for tactical communications. Efforts were then directed to a ship bridge-to-bridge system. The performance of this system was demonstrated over a circuit between NRL and the Navy Department building (Dec. 1937). Three 500-MHz equipments were produced and utilized in operational trials in the Fleet (early 1938). An airborne system was developed which provided communication between air and ground at ranges in excess of 100 miles (10 watts, 300 to 360 MHz) (1940).<sup>178d</sup>

In the Navy's consideration of the frequency limits to be established for a new, higher frequency communication band, NRL urged that channels around 200 MHz be reserved for search radar, since this frequency was very effective for long-distance aircraft detection. This consideration set the lower limit of the new frequency band. The Navy then decided upon the 225 to 400 MHz frequency range for the new UHF communication band and proceeded to obtain the concurrence of the Interdepartmental Radio Advisory Committee (IRAC) in allocating this band for tactical communications. The Navy's proposal was agreed to by IRAC, which included representatives of the Army and other departments of the government concerned (1944). Thus, the UHF band was established. In support of its interests the Army demanded a share of the band and was assigned every other frequency channel in the band. This assignment was shared subsequently with the Air Force when that service was established.

To meet the new requirements for Naval aircraft, NRL developed the first aircraft communication equipment providing a large number of quickly selectable, specific, and precise frequency channels covering the UHF band (1944).<sup>187</sup> Equipment of this kind was extensively used throughout the military establishment. NRL's equipment, known as the Model XCU

in early experimental form, later was designated the Model AN/ARC-19 (transceiver, 4 watts, 225 to 400 MHz). The communication channels (876, with a spacing of 200 kHz) were provided through the use of a unique frequency-control technique employing only seven crystals arranged in various combinations to control the output channel frequencies. This equipment was the forerunner of the Model AN/ARC-27, which provided 1750 channels spaced 100 kHz apart.<sup>188</sup> Coordination with the Air Force for its requirements, the advent of the Korean conflict, and production difficulties delayed the availability of the AN/ARC-27 until 1951, when it was produced to the extent of 125,000 equipments for the Navy and Air Force, and for foreign allies. A counterpart of this equipment, the Model AN/GRC-27, for ship and shore installations was also produced in considerable quantities (about 10,000 made). A considerable number of ARC-27 and GRC-27 equipments were procured and saw operational use for many years.

NRL developed the Navy's first shipboard communication receiver for the UHF band (Model XCS) (1944).<sup>189</sup> The Laboratory also provided technical information and guidance to the contractors in procurement of the receivers. Since the contractor for the transmitters was required to produce them in quantity in an extremely short time, NRL was afforded little opportunity to avoid the many deficiencies of the product which had to be corrected later. A considerable number of these equipments were procured by both the Navy and the Air Force. They were designated the Model RDZ (receiver, superheterodyne, ten channel, 225 to 400 MHz) and Model TDZ (transmitter, 30 watt, ten channel, 225 to 400 MHz). When using these equipments, in close proximity aboard ship in the numbers required for tactical communication circuits, considerable mutual interference was encountered. In an extensive investigation of the performance of the contractor's product on 100 primary Navy channels, involving some 40,000 measurements, NRL found that only a small fraction of the possible number of channels were clear of interference and suitable for ship-

## RADIO COMMUNICATION

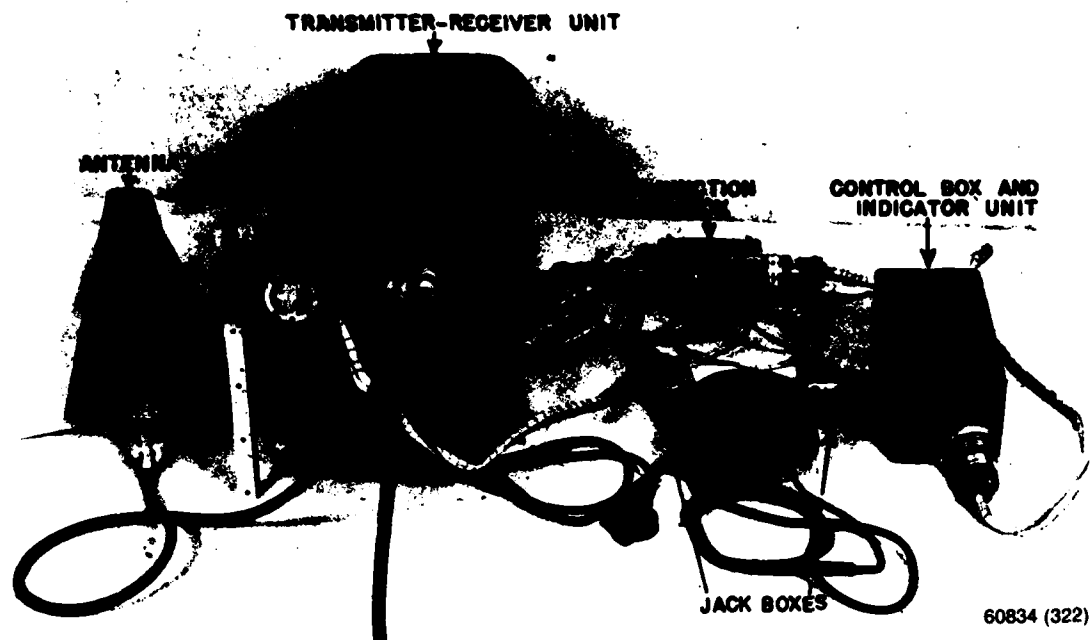

THE FIRST UHF AIRCRAFT COMMUNICATION EQUIPMENT PROVIDING A LARGE NUMBER OF QUICKLY SELECTABLE SPECIFIC AND PRECISE FREQUENCY CHANNELS (1944)

This NRL-developed equipment was designated the Model AN/ARC-19 (225-400 MHz) when procured.

board service.<sup>189</sup> The interference was due to spurious emissions of the TDZ transmitter and heterodyne oscillator of the RDZ receiver. In its prior experimental work, NRL had used third and fifth "overmode" crystals in the oscillators, thus reducing the number of frequency multiplications necessary to produce output channel frequencies to as low as twelve times. It had recommended that the contractors use these overmode crystals. The Army Air Force, in joining the procurement action to obtain equipment for its own needs, insisted that the contractors use fundamental-mode crystals. These required frequency multiplications as high as 64 times, greatly increasing the number of harmonic emissions and the number of spurious receiver responses resulting therefrom; nevertheless, the Air Force requirement prevailed.

NRL was able to make substantial improvement in transmitter performance by introducing filters in the power supply and control circuits and by adding a tube after the crystal oscillator to reduce the load on the crystal.<sup>190</sup> However, changes in the equipment to use the overmode crystals necessary for satisfactory performance were so extensive as to be inadvisable. The TDZ/RDZ equipments were used for many years on such clear channels as they could provide. To avoid the interference difficulty in subsequent procurements of UHF equipment, third and fifth overmode crystals were used, as had originally been recommended by the Laboratory.

To eliminate the "pulling" of the crystal-control frequency experienced when tuning earlier UHF equipment, NRL devised a

RADIO COMMUNICATION

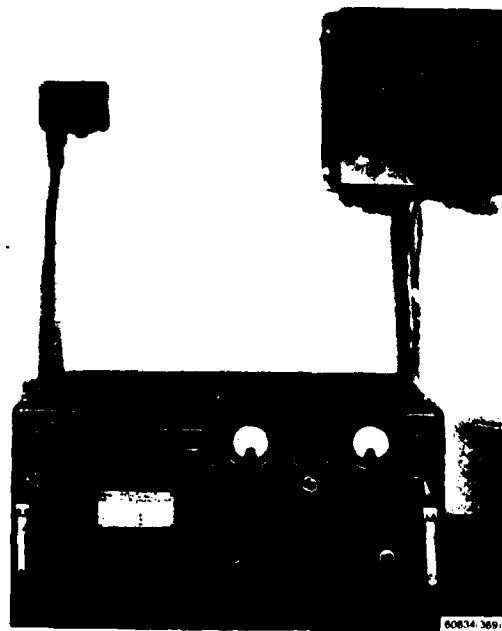
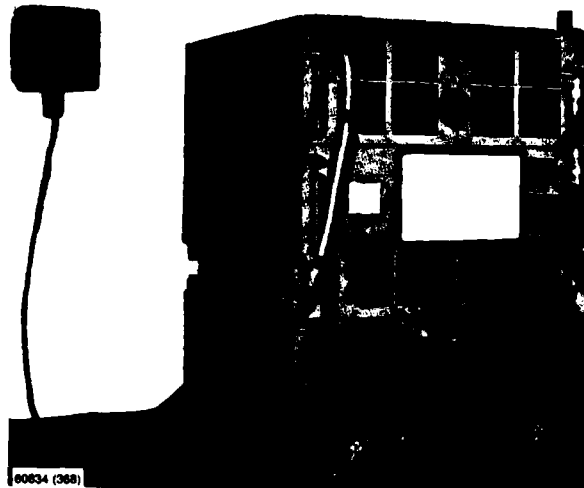

**THE FIRST SHIPBOARD UHF RADIO  
COMMUNICATION EQUIPMENT, THE MODELS  
TDZ-RDZ (1944)**

This equipment was procured in considerable quantity and was used in tactical communication circuits for many years. NRL developed the experimental model of the Model RDZ receiver (below) and conducted many investigations to make the Model TDZ transmitter (above) effective.



cathode-coupled crystal oscillator circuit which was widely used in modern Navy UHF communication equipment (1947).<sup>191</sup> Its use in the manufacture of crystals also makes certain that the channel frequency will be precise when used in operational equipment. The circuit uses third and fifth overmode crystals (originally type CR-9) and provides directly generated oscillations at frequencies up to 150 MHz. At resonant frequencies the crystal provides a low-impedance path between the cathodes of two oscillator tubes. The inductance of the crystal connecting leads is neutralized by a series inductance. The crystal holder and stray circuit capacitances are neutralized by an inductance in parallel with the crystal. This NRL crystal oscillator circuit and other NRL-devised techniques were used in the Model AN/TED UHF transmitter (over 3000 transmitters procured, beginning in 1947), in the Models AN/URR-13 (1950-1954) and AN/URR-35 (1960) UHF receivers (total procurement over 2000 receivers), and in the Models AN/URC-9 (procurement begun 1951), AN/SRC-20, 100 watts, combined with AN/URC-9 (procurement begun 1961), and AN/SRC-21, 20 watts (procurement begun 1962) UHF transceivers (total procurement over 2500 transceivers). Some of these models saw extensive service throughout the Navy, Air Force, and Army as communications components.

#### **Amplitude Modulation vs Frequency Modulation in UHF Communication Systems**

For many years the Navy had used amplitude modulation (AM) in its radio voice communication systems, which it considered superior to other modes of modulation for mobile service. Frequency modulation (FM) had been used by public radio broadcasting systems, particularly at the higher frequencies, and was considered to provide higher fidelity than amplitude modulation in reproducing music and song. Good results had also been obtained when used in land mobile communication systems with one fixed terminal

having a physically stable antenna, as compared with most Naval circuits, involving mobility of both terminals. When the UHF band was established for military tactical communications, and after the Navy's development of the TDZ/RDZ UHF equipment using amplitude modulation was underway, the British raised vigorous objection to the use of AM, claiming that frequency modulation was superior. Their concern was directed to the use of a common UHF communication system in future joint operations. To settle the matter, NRL conducted the first comprehensive investigation undertaken to determine the relative merits of amplitude modulation and frequency modulation in a UHF system as used in mobile Naval operations (1946-1947).<sup>192</sup> The results of the investigation proved the superiority of amplitude modulation. This type of modulation was adopted by the Navy for its UHF tactical-communication equipment.

Representatives of the British Admiralty Signal Establishment, the Royal Aircraft Establishment, and the Ministry of Supply participated in the investigation. A comprehensive theoretical study was conducted to establish criteria of ideal performance and to derive equations for computing theoretical limits. Data were taken in the Laboratory on systems using lossy lines and attenuators for simulated propagation paths. Data were also taken at sea using TDZ/RDZ equipment installations on the USS ADIRONDACK (E-AGC-15), the USS PEREGRINE and the USS LST 506, furnished by the Navy's operational development force. Data were also obtained using AN/ARC-13 UHF communication equipment installed in Navy type R4D-5 aircraft. The UHF communication equipments were modified to facilitate change between AM and FM modulation modes and to insure equivalency. Performance measurements and observations were made to determine single-signal range of communications. The effects of interfering signals on the same channel and on adjacent channels were studied, as well as the changes in performance resulting from radar

interference and noise caused by various electrical discharges in the vicinity of antennas. The influence of audio-frequency emphasis was investigated in laboratory measurements and also mathematically. Multipath propagation was considered. The effect of type of modulation on equipment design factors, such as size and weight, was examined.

The general conclusion reached was that for the highly mobile terminal conditions, typical of much of the Naval service, AM is preferable to FM. In brief, it was found that the AM signal occupied less of the radio spectrum, gave better weak-signal performance (fringe-area reception), greater freedom from co-channel and adjacent-channel capture effects, was much more tolerant of circuit misalignment and detuning, and easier to adjust and maintain. The FM system provided about 10 dB higher output signal-to-noise ratio on medium-input signals, was advantageous for "high-fidelity" or wideband low-distortion reproduction, required less transmitter power (but also more complex transmitter and receiver circuitry), and permitted closer adjacent-channel frequency spacing under conditions of strong-signal interference (but with greater signal-to-noise ratio depression effects). In general, FM is more appropriately considered for systems with both terminals geographically fixed.

At the conclusion of the investigation, the British concurred in the superiority of AM over FM in UHF voice communication systems, as used in mobile sea operations, and proceeded to use AM equipment in their Naval forces. Tactical voice communications using AM equipment was widely adopted by the Navy.

#### Communication Systems Planning

As an aid to future communication system planning, NRL was first to devise a technique of system analysis which enables an operational planner to determine from critical parameters the performance limits of proposed radio communication systems in practical operational terms (1952).<sup>198</sup> The technique is not limited to UHF; it can be applied to a wide

range of communication frequencies, different types of modulation, and various ship-air-shore terminal combinations. It provides the presentation of predicted performance in forms which permit determination of the effects of system variables. The influence of antenna height, antenna-pattern irregularities, transmitter power, receiver sensitivity, output signal merit rating, and other major factors can be assessed directly. The technique was first applied to the Model TDZ/RDZ UHF system in determining improvements to be made in equipment subsequently to be procured. The results obtained through the use of the new analysis technique were in good agreement with data obtained in actual field performance.

Radio-frequency spectrum planning was enhanced when NRL devised a technique for analyzing receiver capability for discrimination between desired and undesired signals using log-log selectivity curves associated with pertinent parameters (1955).<sup>194</sup> Through the use of log-log curves in a composite plot, the interrelations between major channel-frequency factors which must be considered can be presented in a way particularly effective for system planning purposes, not possible with the use of conventional curves. Thus, receiver intermodulation, crossmodulation, desensitization, weak-signal selectivity, receiver radiation, and spurious response limits, as well as transmitter intermodulation and limit of spurious radiation can all be readily appraised. Such determinations as system channel-frequency spacing and transmitter-receiver antenna proximity for tolerable levels of cross modulation are easily made.

#### UHF Antennas

In the VHF band, simple dipole antennas had sufficient frequency bandwidth to serve acceptably in Navy communication transmitter and receiver installations. However, in the UHF band, the much greater frequency range which had to be covered required the complexity of remote mechanical adjustment of the antenna,

## RADIO COMMUNICATION

unless it was inherently broadband. Furthermore, the multiplexing of several equipments on a common antenna made a broadband capability a necessity.

NRL developed the "biconical" antenna, the first UHF broadband antenna (225 to 400 MHz) to have radiation characteristics satisfactory for Naval installations (1942).<sup>196,198</sup>

The antenna comprised two opposing cones with skirts. Its dimensions were proportioned in accordance with an equation which was developed. Television interests had developed antenna structures which had reasonably flat frequency performance over a 20-percent bandwidth. In comparison, the new "biconical" antenna provided operation over a 56-percent



**THE NAVY'S FIRST UHF  
BROADBAND ANTENNA (1942)**

This antenna, developed by NRL, covered a frequency range of 225 to 400 MHz.

60834 (331)

bandwidth relative to midband frequency, with less than 9-percent reflection when fed by a standard transmission line. Widespread interest developed in this antenna. Information on its design was promptly given the several contractors engaged in providing the Navy with UHF equipment. To accelerate the availability of the antenna for Fleet use, NRL had 30 units constructed by a local contractor patterned after NRL's model.

#### Directive Antenna System

At UHF, the use of directive or beam antennas of a size which can be accommodated aboard ship can provide substantial improvement in communication system performance. A directive antenna system also offers greater security in communication from enemy interception, direction finding, and jamming. However, the directive antennas must be mutually aligned at the respective terminals and held in alignment regardless of the movements of the individual ships. **NRL developed the first automatic, mutually aligning, directive communication UHF antenna system (1949).**<sup>197</sup> This system was first demonstrated on the Naval Patrol Craft, USS E-PCS-1425 (1949). It was also installed on a destroyer, where considerable increase in range at UHF was obtained, giving beyond-the-horizon performance. A 26-dB system improvement was obtained.

#### UHF Antenna Multiplexing

The limited number of UHF antennas with satisfactory radiation performance which can be accommodated aboard ship and the large number of channels required on ships, such as command ships and carriers, for tactical communications, make imperative the operation of several transmitting or receiving equipments on a common antenna. **NRL was first to devise an antenna multicoupler system which provided satisfactory operation of up to six communication transmitters or receivers on a common antenna (1946).**<sup>198</sup> Multicouplers

of this type were used throughout the Fleet; modern carriers require multicoupler accommodation for over 30 UHF communication equipments. The system incorporated a newly devised transmission line-series coupling technique, previously referred to under "High-Frequency Antenna Multiplexing," although it was first applied at UHF. In this technique the equipments are coupled to the inner conductor of a concentric transmission line through a series of small openings along its outer conductor. The coupling element for each equipment is an adjustable quarter-wave rod placed parallel with the inner conductor of the line at each opening. In this system, with equipments separated by 6 percent in frequency, a 25-dB isolation was obtained with an insertion loss of 0.8 dB. The NRL antenna multicoupler was procured (as Model CU255/UR) in large numbers and installed on ships throughout the Fleet, some remaining in service for many years. This multicoupler was the forerunner of a series of models based on the same concept. A quick frequency shift was one improvement in this series of equipment.

#### Tropospheric Scatter Communication

In the early exploration of the VHF and UHF bands, it was observed that energy at these frequencies could be propagated to distances substantially beyond the optical horizon by means other than ionospheric refractions. A bending or refraction of the energy path in the lower atmospheric level appeared to be taking place. The associated phenomena came to be known as tropospheric scatter propagation. **NRL carried out the first investigation to determine the relative effects of temperature, water vapor, air pressure, and ionization gradients in the atmosphere in influencing bending of the energy path in the tropospheric-scatter mode of propagation (1935).**<sup>199</sup> The Laboratory concluded that the temperature gradient was principally responsible for the bending. Subsequently, other causes were proposed, but the subject still remains somewhat of a moot

RADIO COMMUNICATION



**THE FIRST UHF ANTENNA MULTICOUPLER SYSTEM  
PROVIDING SATISFACTORY OPERATION OF UP TO SIX  
COMMUNICATION TRANSMITTERS OR RECEIVERS ON A  
COMMON ANTENNA (1946)**

This system incorporated a transmission line-series coupling technique devised by NRL. It was designated the CU 255/UR.

75779 (2)

## RADIO COMMUNICATION

question.<sup>203</sup> Propagation was observed to distances as great as 168 miles as early as 1932.<sup>204</sup> One of the first radars (200 MHz), newly installed at Pearl Harbor aboard the USS YORKTOWN, displayed echoes from the coastal mountains of California at a range of 450 miles as the carrier was cruising to San Diego (1940).<sup>205</sup> Operators on ships equipped with CXAM radars were able to communicate over distances of 200 miles and more by keying the range-change buttons of the radars when the antennas were pointed at each other. NRL had observed that the very long propagation ranges were due to the presence of certain meteorological conditions which conserved the transmitted energy by confining it to low-altitude paths over the surface of the sea, later called "ducts." The nature of these ducts was investigated relative to proximate meteorological structures in both the Atlantic and Pacific Ocean areas (1945).<sup>206</sup> The ducts were found to be capable of supporting 200 to 500 MHz signals to ranges of 1000 miles with meteorological predictability. These and similar results gave promise of the value of this mode of propagation for Naval communications.

NRL conducted the first investigation of surface-to-surface tropospheric-scatter propagation over all seawater paths under various seasonal and meteorological conditions to determine its utility for Naval communications (1954-1969).<sup>207</sup> Data were first collected over a 130-mile path extending southward over water from the Laboratory's Chesapeake Bay site (1953-1954). Field strength was recorded on transmissions (200 kHz) from the Laboratory's site at selected points ashore and on board a Naval vessel. Similar data collection took place aboard the USS ACHERNAR (AKA-53) on transmissions from Round Hill Point, Massachusetts (385 MHz) and Situate, Massachusetts (220 MHz) over 400-mile paths extending from these points under summer conditions (July 1955). During this work NRL demonstrated ship-shore, two-way, voice communication with the tropospheric mode of propagation for the first time out to a distance of 250 miles (July 1955). Commercial telephone

circuits were set up between Round Hill Point and Washington, D.C., and conversations were held between NRL and USS ACHERNAR. The ship used a 17-foot steerable paraboloid (Model SK-3 radar) antenna centered 95 feet above the water level and a 150-watt (AN/TRC-24) transmitter. A 10-kW transmitter and a 28-foot paraboloid antenna were used at the Round Hill site. To determine the influence of winter conditions on tropospheric propagation, observations were made on transmissions (412 MHz) from the Round Hill site aboard the USS THUBAN (AKA-19) during February 1956. With the 17-foot paraboloid antenna aboard ship and a maximum transmitter power of 40 kW feeding a 60-foot paraboloid antenna at the Round Hill site, transmissions were detectable out to a distance of 630 nautical miles. Periodic transmission with voice and music modulation were received with excellent quality out to a distance of 300 miles (10 kW) and to 400 miles (40 kW). Further data were collected at a much higher frequency in an effort to determine if the antennas could be made much smaller and more compatible with shipboard installation. Transmissions (10 kW, 7760 MHz, X-band) were observed over a 45-nautical-mile path from Wallops Island, Virginia to Lewes, Delaware (1967) and over a 73-nautical-mile path to Dam Neck, Virginia (1968-1969). An 8-foot parabolic antenna was used at the transmitter and an omnidirectional antenna at the receiver.

The results of NRL's work indicated that with sufficient transmitter power (10 kW) and high-gain antennas, tropospheric scatter communication circuits can provide satisfactory operation out to a distance of about 200 miles over seawater paths. Naval installations which can accommodate the large antennas required are limited. The presence of "ducting," more prevalent in summer than in winter, provides considerable increase in the received signal strength. When ducting is absent, the attenuation over the path is approximately 0.18 dB per nautical mile. The received signal level is subject to fluctuations up to 13 dB at various rates and with a Rayleigh probability distribution.

## RADIO COMMUNICATION

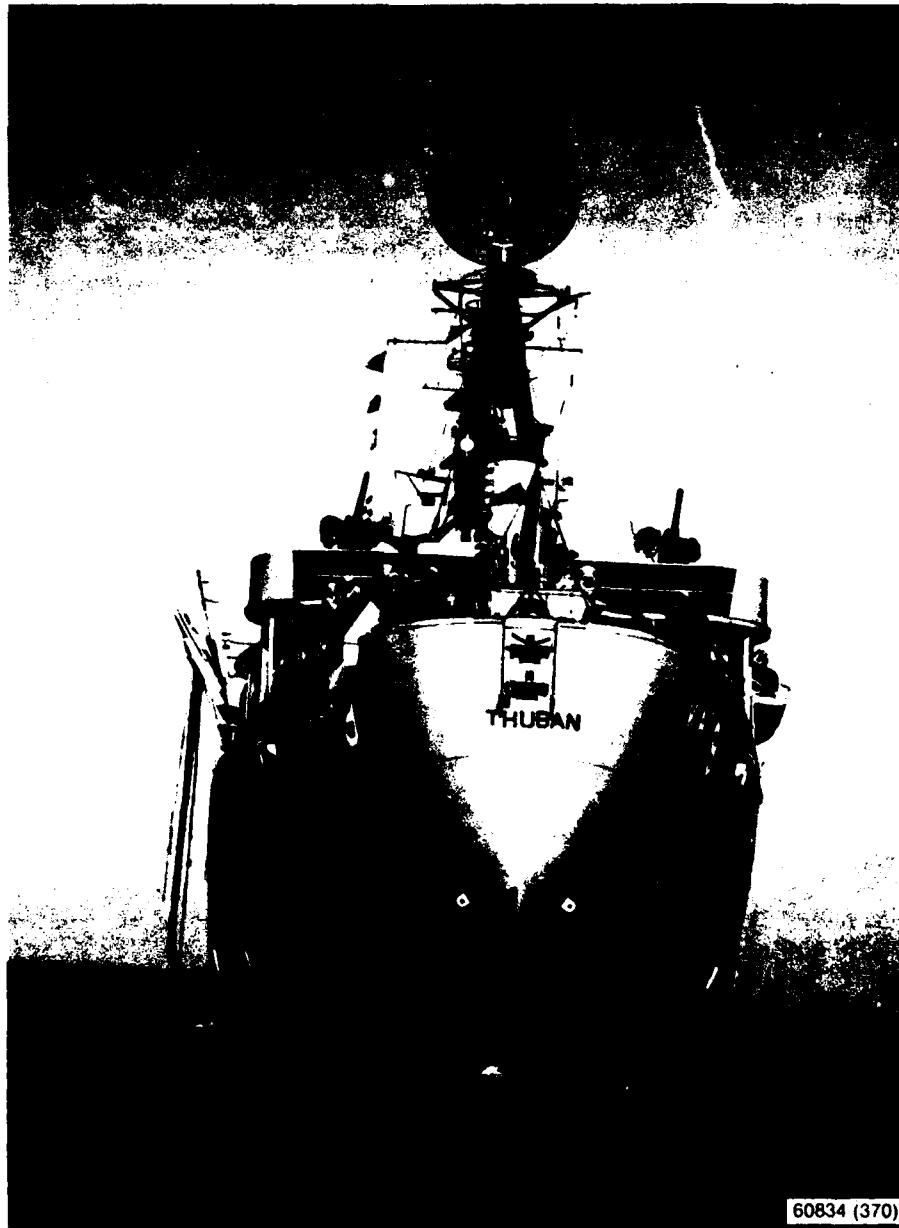

### THE FIRST SHIP-TO-SHORE TROPOSPHERIC COMMUNICATION

In the first demonstration of the feasibility of ship-to-shore tropospheric communication, NRL equipped two ships, the USS ACHERNAR and the USS THUBAN (shown above), with 17-foot parabolic antennas and instrumentation. In this work, the first ship-to-shore, two-way, voice communication using the tropospheric mode of propagation out to a distance of 250 miles was demonstrated (1955).

The difference in performance between a UHF system and an X-band system using smaller antennas was due essentially to the proportionately smaller amount of energy intercepted by the smaller area of the X-band antenna. The use of a vertical dipole receiving antenna, to obtain omnidirectional performance and thus avoid the need for antenna alignment, involves a similar loss. However, this loss can be partially offset by gain up to 13 dB obtainable with an antenna having a suitable vertical pattern. Rain was found to have greater adverse influence on propagation at the X-band frequency than at the UHF band. New terminal equipment with new modulation, diversity, and other techniques compensate for this loss and extend the utility of tropospheric scatter systems for Naval applications by permitting the use of smaller antennas.

The Navy has used tropospheric scatter circuits (UHF) very successfully for two-way communication between its National Emergency Command Post Afloat (NECPA) ships and coastal stations over distances of 50 to 200 nautical miles (1961-1969). A chain of shore stations provided continuous contact along the coast from Maine to Florida. NRL provided the ships involved in carrying out this function, the USS NORTHAMPTON and the USS WRIGHT, with multi-helix type, directive steerable antennas for the system.

#### Radio Buoys

The Laboratory has conceived and developed several types of radio buoys capable of transmission and reception to serve various Naval functions. The towable radio communication buoy, releasable and retrievable by submerged submarines, has already been mentioned. NRL has also provided it with a UHF transmission and reception capability for submerged "hunter-killer" ASW submarines for use in the coordination of Naval forces in attacking enemy submarines (1957).<sup>165</sup> The UHF feature was first demonstrated on the submarine USS BLENNY, with satisfactory communication established from ship to ship and ship to air (1957).

NRL developed the first sono-radio buoy for the protection of advanced bases, harbors, and ships at anchor against attack by enemy submarines (1941).<sup>173d,202</sup> The sono-radio buoy designated the Model JM was procured in large numbers and used very effectively during World War II and for special purposes thereafter. An installation of the Model JM was sighted in the Bosphorus as late as 1960. This sono-radio buoy development was the beginning of a series of models based on the original concept. Sono-radio buoys were generally employed throughout the Navy. NRL's early buoy was barrel shaped, normally anchored, and contained a battery-operated radio transmitter with a vertical antenna extending above. A hydrophone supported by the buoy picked up underwater sounds, which modulated the transmitter. The radio transmissions from a number of buoys were monitored at remote observation points (receiver Model REN). The buoy was modified to obtain better stability in very heavy seas through the design of a boat-type body.

NRL developed the first aircraft-launched ASW sono-radio buoy for detecting and attacking submerged enemy submarines (1943).<sup>173d,206</sup> This air-launched sono-radio buoy was the predecessor of a series of models. During World War II the procurement of this air-launched buoy reached 150,000 units. The success of the campaign against German submarines can be attributed to a considerable extent to its extensive use by the Navy and by the British. It was used effectively against Japanese submarines in the Pacific. It has also been used successfully in air-sea rescue work, being issued as primary equipment for life rafts. The initial buoy, considered expendable, was designated the Model AN/CRT. A parachute limited the rate of descent of the buoy, which, when it became seaborne, transmitted to the aircraft sounds picked up by its underwater hydrophone. Means were provided for correlating the rotation of the directional hydrophone with compass bearings so that the direction of the emitted sounds could be determined aboard the aircraft. Several buoys could be monitored aboard the aircraft to determine the point of attack (receiver Model AM/ARR-16). Provision was also made for



RADIO COMMUNICATION

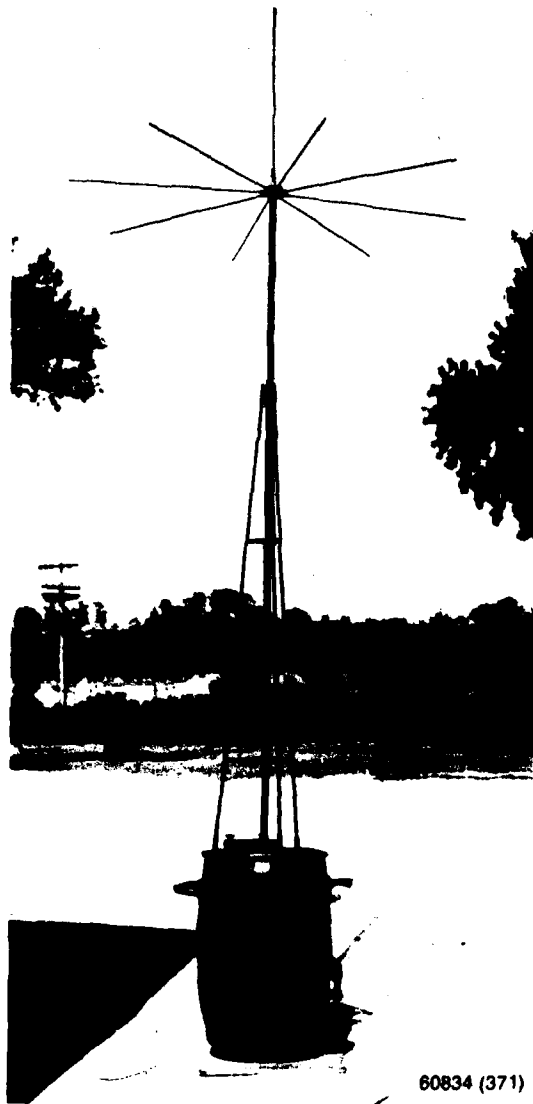

60834 (371)

**THE FIRST SONO-RADIO BUOY**

NRL developed this buoy for the protection of advanced bases, harbors, and ships at anchor against attack by enemy submarines (1941). It was designated the Model JM.

**RADAR  
BEACON  
ANTENNA**

**STANDARD  
ERSB  
ANTENNA**



60834 (334)

**THE FIRST AIRCRAFT-LAUNCHED  
ASW SONO-RADIO BUOY**

This buoy was developed by NRL for detecting submerged enemy submarines and aiding in their attack (1943). It was designated the Model AN/CRT.

## RADIO COMMUNICATION

determining the location of the buoy by airborne radar through the use of a beacon mounted on the buoy. Later, the frequency of the radio transmitter was changed to the upper part of the VHF band.

NRL developed the first submarine-rescue radio buoy releasable by a submerged submarine in distress to alert and guide rescue forces by means of radio transmissions (1947).<sup>207</sup> This submarine-rescue radio buoy was approved by the Navy's Operational Development, Test and Evaluation Force and saw wide general service. The search area is localized by

homing on the buoy transmissions with radio direction finders. The buoy comprises a battery-operated, crystal-controlled transmitter and an automatic keyer which upon surfacing continually repeats in international code the message "SOS SUB SUNK SOS" on the fixed emergency distress frequency. The original version, the Model XDM, was followed by Model T-347/SRT and Model T-616/SRT (1957). The buoy (three inches in diameter, 40 inches long) was launched from the submarine's signal-flare-ejector tube. The antenna was a tapered metal strip which was folded down during ejection

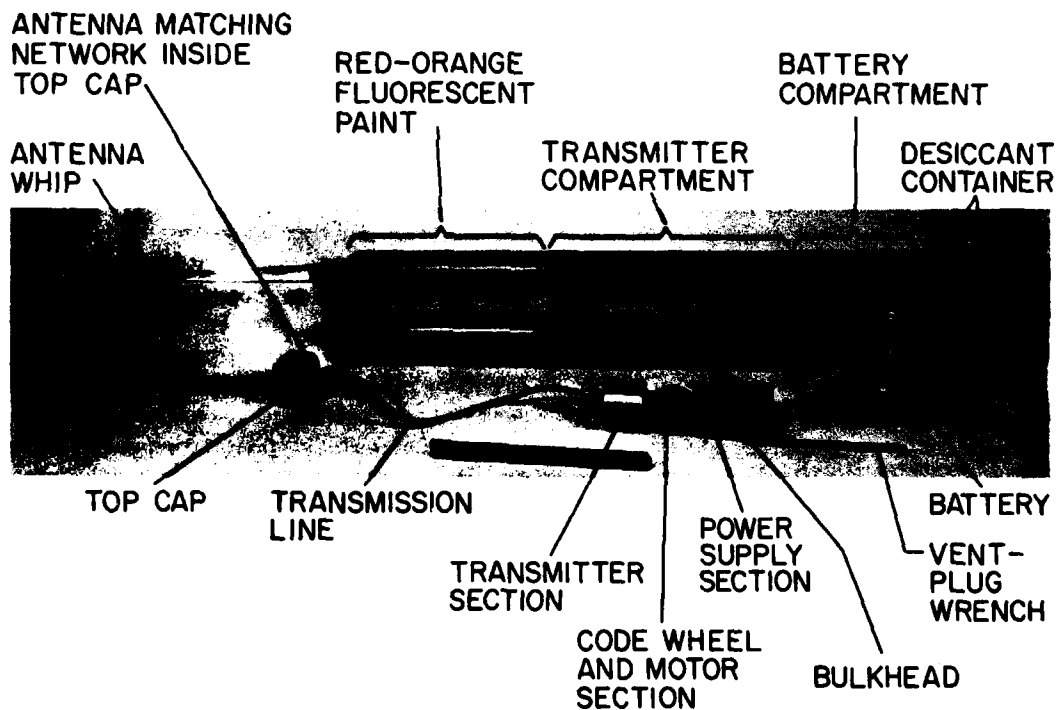

60834 (372)

### THE FIRST SUBMARINE-RESCUE BUOY

This buoy was developed by NRL to be released by submerged submarines in distress. Radio transmissions from the buoy alerted and guided rescue forces (1947).

and sprang erect as it reached the surface. The battery capacity was adequate to continue the message transmissions for 14 hours. The SOS signals can be received at ranges out to the horizon by surface vessels and to a distance of 90 miles by aircraft flying at an altitude of at least 10,000 feet.

## COMMUNICATION AT SUPER-HIGH FREQUENCIES

### Introduction

The frequencies above the UHF band at various times since the Laboratory's inception have been referred to as "micro-rays," "centimeter waves," "microwaves," "millimeter waves," and "super-high frequencies." While it was recognized early that transmission at these frequencies was limited in range to the line of sight, nevertheless, the possibility of confining the energy to a very tight beam with small directional antennas made them attractive for short-range communication, particularly from the viewpoint of security. They appeared to offer important operational advantages over the Navy's light-blinker system. NRL began its exploration of these frequencies in 1933, directing its attention to components. Particular attention was given to adequate transmitter power sources, which had always been a major impediment to progress to higher frequencies.<sup>208</sup> Magnetron tubes were constructed for oscillation in the range 7 to 40 centimeters (4285 to 750 MHz) and were used in experimental systems (1934-1937). Good-quality voice communication was obtained over short ranges (1934). A ten-centimeter, 3000-MHz system using 40-inch parabolic reflector antennas was developed and installed on the destroyer USS LEARY (DD 158), the first such equipment to be operated on a U.S. Navy vessel (1937). Ranges out to the horizon (NRL to Fort Washington, Maryland) were demonstrated.<sup>173a, 209</sup>

Up to this time the super-high-frequency development work had had both communication

and radar objectives. Progress in radar had by then aroused great Naval interest, and this work was given high priority, resulting in retardation of activity for the developmental activity in communication. Furthermore, components in the VHF band were much further advanced, and emphasis was given to developments in this band to provide for short-range communications in case war should occur.

### Millimeter Waves

Toward the end of World War II, to obtain an important security feature, attention was directed to the development of a communication system in the frequency band (5.4 mm, 55,500 MHz) where high absorption, due to the presence of oxygen in the atmosphere, would limit the range of propagation (1945). Also, when space is limited, the very small antennas required in this frequency band would make possible new operational applications. The Laboratory proceeded to devise circuit components such as power generators, wave guides, and resonant circuits which for this frequency band were at that time nonexistent. Transmitting, receiving, and measurement equipment was developed and used in propagation investigations (1945-1970).<sup>210</sup> Equipment was developed to the stage at which an operational system was made available and demonstrated (1958). Both shipboard and airborne aspects were given consideration. The high cost of the highly precise components used at that time was a deterrent to operational deployment. Subsequently, a major reduction in cost was possible when suitable solid-state and traveling-wave-tube components became available. Operational applications were then feasible and effective.

### Satellite Communication

It was fortunate that the super-high-frequency channels remained relatively unoccupied and that it became feasible to place satellites in

orbit at a time when the high-frequency band, which carries the great bulk of the long-distance communication load, had reached a state of near saturation, and when there was continued need to increase the longer range command and control communication capacity. Super-high frequencies, capable of penetrating the earth's atmosphere with negligible loss, used in high-altitude relay satellites could provide solid, long-distance coverage of large world areas notwithstanding their line-of-sight propagation limitation. Also, the use of these frequencies would make available a very large increase in the number of communication channels free of the ionospheric propagation complexities encountered in high-frequency-band transmissions. Furthermore, advantage could be taken of their very high data-rate capability for new modes of communication not previously possible over long distances.

Since its early days, the Laboratory has held a continuing interest in extraterrestrial radio phenomena. In connection with the conduct of its original high-frequency-propagation work, NRL was first to determine the frequency above which radio waves would penetrate the earth's atmosphere and propagate through outer space, making interplanetary radio communication possible (1926).<sup>11c</sup> The Laboratory was first to analyze the conditions for radio propagation on the planet Mars (1929).<sup>211</sup> Encouraged by the results of its experiments to determine the characteristics of the ionosphere with reflected high-frequency pulses (1925) and on "round-the-world" signals, which it observed to pass around the earth as many as three times, NRL made efforts to obtain radio echoes from the moon in 1927 and 1938.<sup>173/</sup> However, it was not until 1949 that the Laboratory was able positively to identify signals returned from the moon through the received clutter.

#### Early Satellite Communication

To study the characteristics of moon-reflected radio energy, NRL constructed the

world's largest parabolic antenna (1951), the size of which was not exceeded until the 250-foot Jodrell Bank, England, antenna became available (1957).<sup>212</sup> The reflector of the NRL antenna (area 1.1 acres) was formed in the earth's surface at the Laboratory's site at Stump Neck, Maryland, as an off-center section of a parabola of revolution having an elliptical aperture 220 by 263 feet respectively along the minor and major axes. A horn-type antenna feed mounted on a movable boom had steering capability which allowed the beam to be held on celestial targets for a period of about one hour. With the aid of this antenna and a transmitter providing one-megawatt, 198-MHz, 12-microsecond pulses, NRL was first to discover that radio energy reflected from the moon was sufficiently specular to support the transmission of data at a rate adequate for effective radio communication circuits (21 Oct. 1951).<sup>212</sup> To provide data on which to base the design of satellite-communication systems, determinations were made of the overall attenuation of the moon circuit, the scatter loss in reflection from the moon's surface, and the attenuation due to the gaseous content of the atmosphere and intervening space. In conducting experiments using the large antenna for both transmission and reception, NRL was first to transmit the human voice through outer space and return from the moon (24 July 1954).<sup>212</sup> A 100-watt, 220-MHz communication transmitter was used. NRL sponsored the development of the first 10-kW klystron amplifier covering the UHF band; with increased transmitter power, smaller antennas could be used. With the use of this amplifier and the large antenna for transmitting and four 17-foot Model SK radar parabolic antennas in an integrated assembly for a receiving antenna, NRL first demonstrated transcontinental satellite communication, from Washington, D.C. to San Diego, California, at 301 MHz with an FSK teleprinter (29 Nov. 1955).<sup>213</sup> The first official message to be transmitted via a satellite was sent over this circuit. Using the same equipment, but increasing the number



THE WORLD'S LARGEST PARABOLIC ANTENNA (1951)

With this antenna, NRL was first to discover that reflections from the moon could be used for communication (1951). NRL also used the antenna to transmit the first human voice signals over a satellite circuit (1954), and with it was first to demonstrate transcontinental and transoceanic communication by satellite (1955). The boom above the parabolic reflector which is formed in the ground holds the energy collector at the focal point. Steering the beam of the antenna was accomplished by moving the boom.

of radar antennas to eight for reception, NRL was first to demonstrate transoceanic satellite communication, from Washington, D.C. to Wahiawa, Oahu, Hawaii, 4350 nautical miles via great-circle path (23 Jan. 1956).<sup>213</sup> Messages were transmitted by teleprinter successfully over the circuit, including one from the Chief of Naval Operations (ADM A. A. Burke) to the Commander-in-Chief Pacific Fleet (VADM F. B. Stump). The system was designated "CMR" (Communication Moon Relay).

#### First Operational Satellite Communication System

Based on NRL's results, the Navy established the world's first operational satellite communication system, from Washington, D.C. to Oahu, Hawaii (1959).<sup>214</sup> This CMR system was publicly demonstrated on 28 Jan. 1960, with messages exchanged between the Chief of Naval Operations (ADM A. A. Burke) and the Commander-in-Chief, Pacific Fleet

## RADIO COMMUNICATION

VADM H. G. Hopwood). At this time pictures (facsimile) were transmitted for the first time over a satellite communication system (January 1960). With NRL's guidance of the contractor, 100-kW transmitter installations were provided at Annapolis, Maryland (445.1 MHz)

and Opana, Oahu (435.1 MHz), and receiver installations were setup at Cheltenham, Maryland and Wahiawa, Oahu. Eighty-four-foot-diameter steerable parabolic antennas were used for all these installations. The receiving installations incorporated an NRL-devised technique which

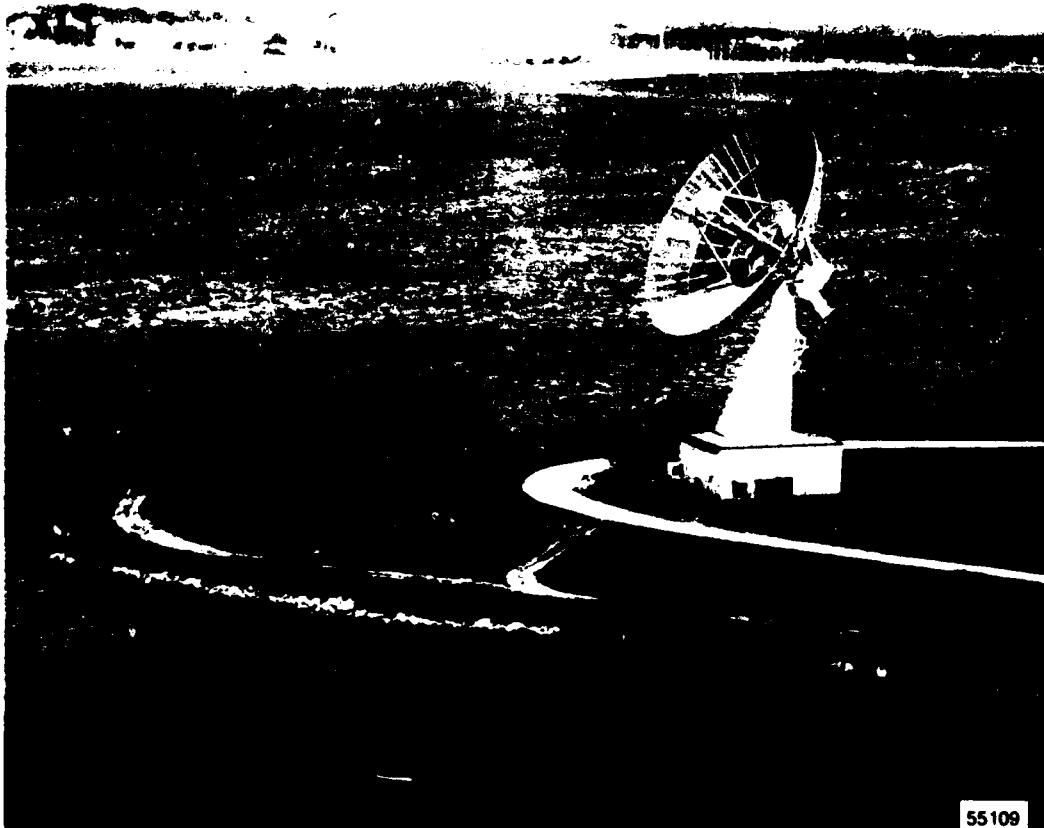

### THE WORLD'S FIRST OPERATIONAL SATELLITE COMMUNICATION SYSTEM (1959)

Based on NRL's work, the Navy established satellite communication terminals at its radio stations near Washington, D.C. and in Oahu, Hawaii. Shown here is the terminal at its Annapolis, Maryland, station.

## RADIO COMMUNICATION

compensated for the fading characteristics inherent in the moon circuit and made possibly highly reliable teleprinter operation. The system was capable of accommodating 16 teleprinter channels at the standard rate of 60 words per minute, but since 16-channel multiplexers were not available, only four teleprinter channels were used. This CMR system was intended to provide backup for high-frequency circuits in case of blackouts due to ionospheric disturbances and proved its worth in this respect when it was first used operationally on 27 Nov. 1959.

### Ship-Shore Satellite Communication System

It was considered that a ship-shore CMR satellite communication system could be provided through the use of smaller antennas made possible with the employment of super-high frequencies (microwaves). Furthermore, the use

of a large antenna on shore could compensate for the lesser performance of a smaller antenna, more compatible for shipboard installation. With short-pulse (two-microsecond) radar equipment, NRL was first to make radar contact with the moon at frequencies as high as 2860 MHz (24 Feb. 1957), with encouraging results with respect to communication.<sup>215</sup> The Laboratory's 50-foot antenna, for many years after its completion in 1951 the world's largest and most precise fully steerable parabolic antenna, was used in making the observations.<sup>216</sup> To obtain the continuous-wave power required for communication, NRL sponsored the development of the first 10-kW communication transmitter capable of operation at frequencies as high as 2400 MHz (1956). It also sponsored the development of a 60-foot, fully steerable parabolic antenna, the largest in the United States at the time, to obtain additional circuit gain (1956). Its design was used later in the 84-foot

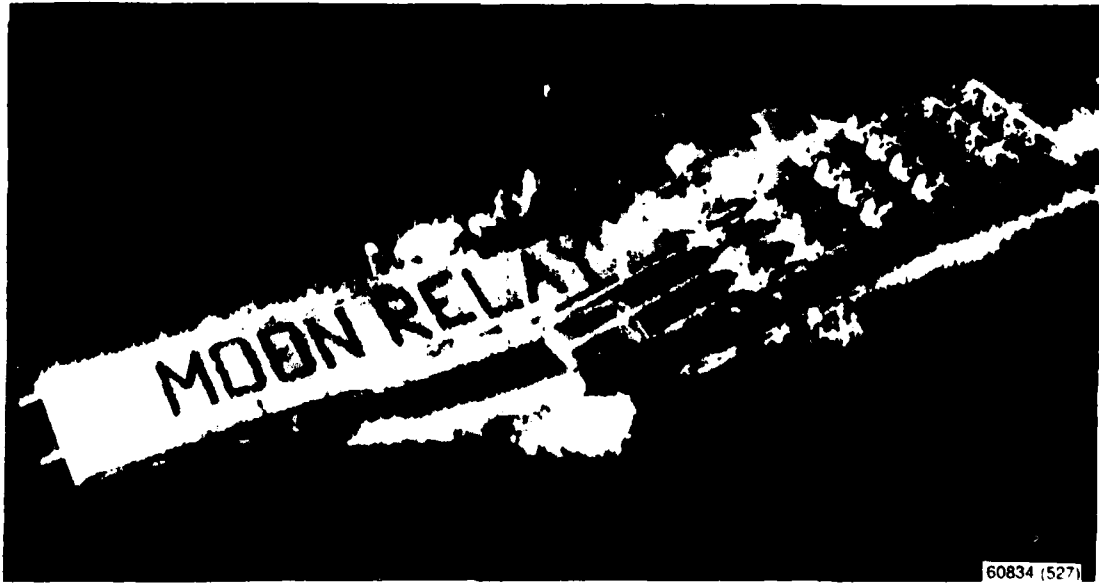

**FIRST PHOTOGRAPH TO BE TRANSMITTED OVER A COMMUNICATION SATELLITE SYSTEM (1960)**  
This picture of the aircraft carrier USS HANCOCK (CVA 19) with officers and men in positions spelling out MOON RELAY was transmitted from Hawaii to Washington, D.C., over the satellite system based on NRL's work (28 Jan. 1960).

## RADIO COMMUNICATION



**FIRST DETERMINATION OF COMMUNICATION QUALITY OF THE MOON  
CIRCUIT AT MICROWAVES (1957)**

Moon-relay communication and the first precise measurement of the distance to the moon were accomplished using the antenna shown here mounted on NRI's Administration building. The antenna, developed in 1950, was the first fully steerable microwave parabolic antenna having a diameter as large as 50 feet. It has been used principally as a radio telescope for radio astronomy research and has been successfully used up to 15,000 MHz. This research has led to many outstanding contributions in this field.



## RADIO COMMUNICATION

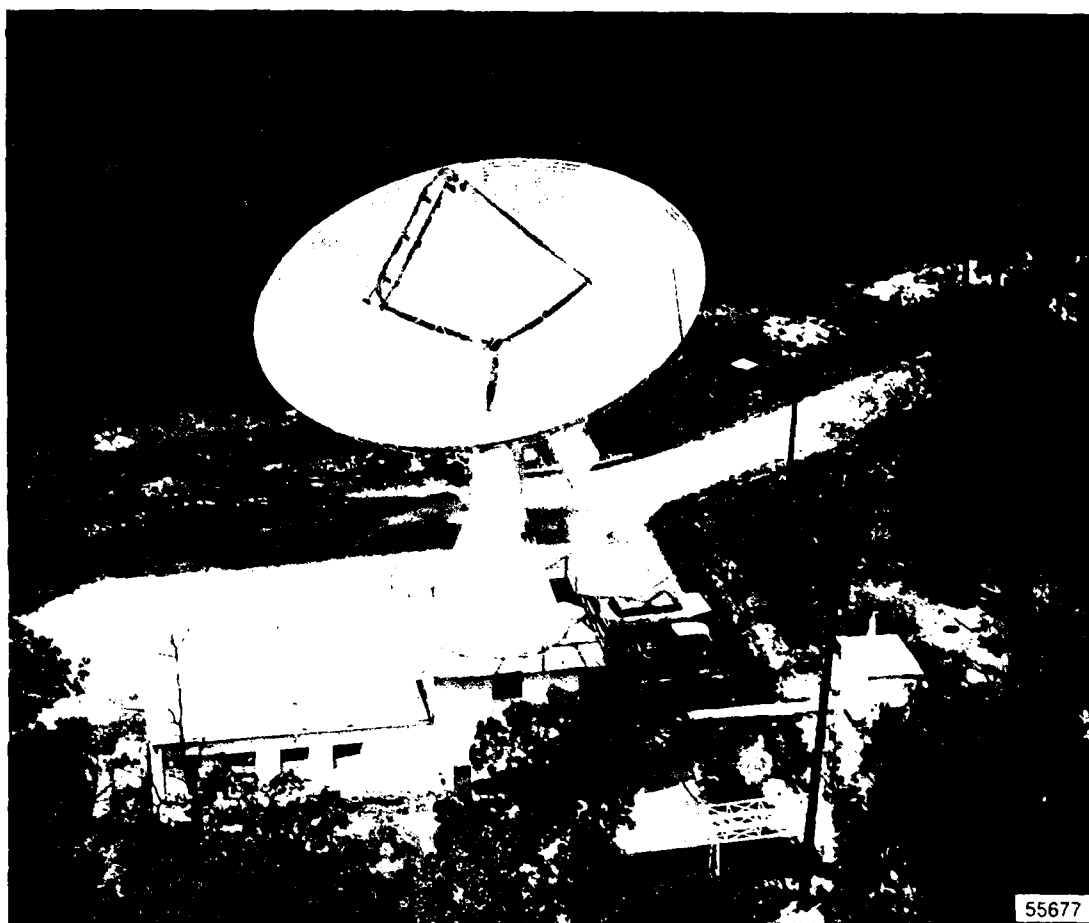

**NRL'S SATELLITE-RESEARCH FACILITY AT STUMP NECK, MARYLAND, THE LARGEST FULLY STEERABLE PARABOLIC ANTENNA IN THE U.S. (1956)**

Many original satellite experiments were carried out by NRL with this S-band facility, which has a 60 foot fully steerable parabolic antenna which became available in 1956. With it, NRL demonstrated the feasibility of ship-to-shore communication via satellite for the first time (1961-1962).

antenna of the Washington-Hawaii CMR system. Reception sensitivity at the super-high frequencies was seriously limited by the phase noise generated when the crystal oscillator standard frequency was multiplied the numerous times necessary to produce the heterodyning frequency. To overcome the limitation in receiver sensitivity imposed by frequency control oscillator noise, NRL devised a phase-locked, crystal-oscillator-filter technique

which for the first time made possible the high reception sensitivity required in satellite-communication systems operating at super-high frequencies.<sup>217</sup> The new system was installed at NRL's site at Stump Neck, Maryland. With it, NRL was first to transmit communication signals over the moon circuit on a frequency as high as 2290 MHz (11 Apr. 1957).<sup>218</sup> NRL cooperated with the National Aeronautics and Space Administration in observing the

## RADIO COMMUNICATION

performance of the ECHO I satellite, a 100-foot-diameter aluminum-coated plastic sphere launched 12 Aug. 1960. On this occasion, NRL transmitted communication signals over the circuit using the first man-made passive satellite to determine the feasibility of extending the operational time of the moon circuit.<sup>219</sup> In a demonstration of this satellite system, the Chief of Naval Research, from his office in Washington, conversed via NRL's Stump Neck installation with Federal Communications Commission members witnessing the demonstration at Holmdel, New Jersey (22 Sept. 1960). A picture of the Commissioners taken while at Holmdel was transmitted over the satellite circuit. At the request of the Post Office Department, NRL transmitted "space mail" in the form of a facsimile letter for the first time over a satellite communication circuit (10 Nov. 1960).<sup>220</sup> A special stamp was issued by the Department in commemoration of the advent of satellite communication. Two-bounce communication via the satellite was effected for the first time when an NRL message

to New Jersey was immediately relayed to California (14 Aug. 1960).

A shipboard CMR system was initiated by installing a 16-foot parabolic steerable antenna and receiving equipment on the USS OXFORD (GTR), with which NRL demonstrated the feasibility of shore-to-ship satellite communication for the first time with transmissions from its Stump Neck, Maryland facility (2290 MHz) (15 Dec. 1961).<sup>221</sup> Messages recognizing the achievement from the Chief of Naval Operations, ADM G.W. Anderson, and NRL's Director of Research were transmitted over the circuit. By adding a 1-kW transmitter to the USS OXFORD installation, NRL demonstrated two-way ship-shore satellite communication via the moon circuit for the first time while the ship was underway between Buenos Aires and Rio de Janeiro (30 Mar. 1962).<sup>221</sup> In response to a message transmitted from the ship, ADM Anderson noted the transmission as "another milestone," "the first message to be transmitted over a ship-to-shore moon relay communication

60834 (528)



FIRST "SPACE MAIL" (1960)

At the request of the Post Office Department, NRL transmitted "space mail" for the first time over a satellite communication system (10 Nov. 1960). This mail was in the form of a facsimile letter. The stamp shown here was issued by the Post Office in commemoration of the advent of satellite communication. The stamp shows the satellite ECHO I used by NRL in its earth-to-satellite-to-earth transmission of the first space mail.

## RADIO COMMUNICATION

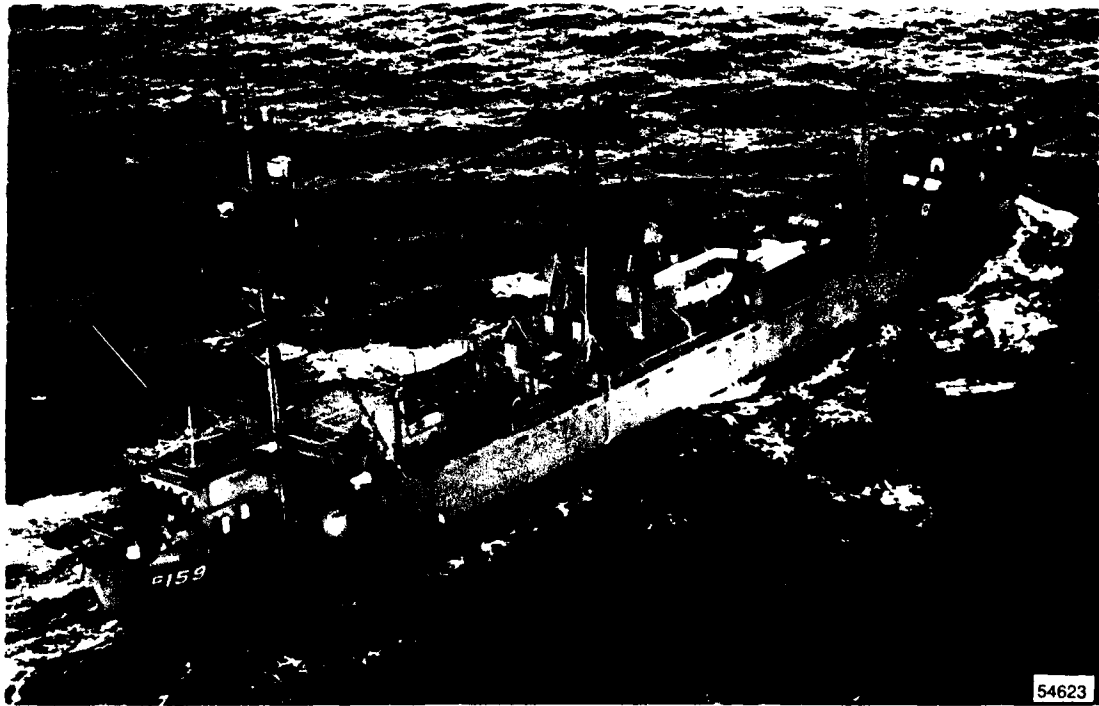

**THE FIRST SHIP TO BE EQUIPPED FOR SATELLITE COMMUNICATION, THE USS OXFORD**

This ship was equipped by NRL to demonstrate the feasibility of ship-to-shore satellite communication. One-way transmissions to the ship were accomplished in 1961, and two-way communications in 1962. This demonstration resulted in the Navy's establishing the first operational worldwide satellite communication system. The antenna can be seen on the stern of the ship (see heavy arrow).

circuit." To increase the system's capability, NRL provided multiplexing circuitry which permitted transmission and reception of two teletype channels simultaneously on a common antenna. This was first demonstrated in full two-way twinplex communication over the moon circuit between the USS OXFORD and the CMR installation at the Naval Radio Station, Cheltenham, Maryland, which had been modified for multiplex operation at the higher frequency (25 Feb. 1964).

NRL's results led to the Navy's establishing the first operational worldwide satellite communication system, with six ship and four shore station installations. (1964-1969). The Navy's lower frequency CMR point-to-point

system was disestablished, and its antennas were used in the shore installations of the new system, located at Cheltenham, Maryland; Wahiawa, Hawaii; Okinawa; and Oakhanger, England. The system went operational with the USS OXFORD on 25 Feb. 1964 and was designated "TRSSCOM" (Technical Research Ship Special Communications). Other ships added were the USS GEORGETOWN (1965), USS JAMESTOWN (1966), USS LIBERTY (1967), USS BELMONT (1968), and USS VALDEZ (1969). NRL provided considerable technical assistance in bringing about these installations. The system gave very satisfactory performance for the particular mission carried out by these ships. Considerable communication traffic was handled

from many parts of the world. However, due to financial retrenchment, the ships were placed in reserve status, with the system operations suspended (August-November, 1969).

#### **NRL Sugar Grove Satellite Communication Research Facility**

After investigating many possible sites in the United States with respect to adequate sky coverage, low radio noise level, and the impact meteorological and geophysical characteristics might have on the large antennas it planned to erect, the Laboratory selected a superior site near Sugar Grove, West Virginia (1955-1956). It formally acquired this site from the Forestry Service of the Department of Agriculture in June 1961. To preserve its low-noise quality, NRL brought about the establishment of the National Radio Quiet Zone, encompassing its Sugar Grove radio research site, the world's only area where local sources of radio emissions are controlled so as not to interfere with observations such as low-level emissions from distant sources in space (1958).<sup>222</sup> Control procedures, established through agreement with the Federal Communications Commission, require that all proposals for radio transmitting installations in the 12,000-square-mile zone be investigated by NRL for possible interference before they are authorized. Through a procedure with the Federal Aeronautics Administration, facilities for aircraft which might result in radio interference are also controlled. The zone includes the National Radio Astronomy Observatory, which takes advantage of the low radio noise level in making its radio-astronomy observations. For its initial installation at the Sugar Grove site, NRL developed the first directive antenna system to be automatically steered in accordance with prearranged recorded programs with the use of digital computer techniques, making possible the automatic acquisition and tracking of satellites having known orbits (1958).<sup>223</sup> This antenna, a 60-foot paraboloid capable of efficient operation at frequencies up to 4000 MHz, has been used for many types of observations, including those

required to maintain surveillance of the "quiet zone." In addition to providing initial experience in the digital steering of directive antennas, it has served in the solution of many problems associated with the design of larger antennas such as those concerning radio-frequency feed, pointing, and drive. The experience acquired has been utilized by NRL in its design and erection of a 150-foot-diameter antenna at the Sugar Grove site capable of efficient operation at frequencies up to 4000 MHz (1966).<sup>224</sup> Its novel design provides a large aperture with high surface and pointing precision at low cost. A similar 300-foot antenna has been designed by NRL for future research.<sup>225</sup>

#### **NRL Waldorf Satellite Communication Research Facility**

In anticipation of the use of frequencies above 4000 MHz for military satellite communication, NRL provided a new research center facility, called the NRL Waldorf Satellite Communication Facility, which has an effective capability at frequencies as high as 20,000 MHz. This facility has a capability superior to that of any facility presently available for performing satellite-communication experiments (1973). The outstanding characteristics of the NRL Waldorf equipment were recognized by NASA, when that agency requested the Office of Naval Research to procure an additional antenna of the type used at Waldorf for its own use. The installation of this equipment at NASA's Wallops Island site was completed in 1968. The NRL facility, completed in 1967, is located on a former Nike missile site at Waldorf, Maryland, acquired from the Army in 1962. It comprises a 60-foot, parabolic, cassegrainian antenna of the highest steering accuracy and flexibility and associated with appropriate equipment. A 25-kW transmitter, an advanced low-noise receiving system, and an antenna steering computer with on-line data processing and recording capability provide excellent instrumentation for satellite communication investigations.<sup>226</sup> In addition

## RADIO COMMUNICATION

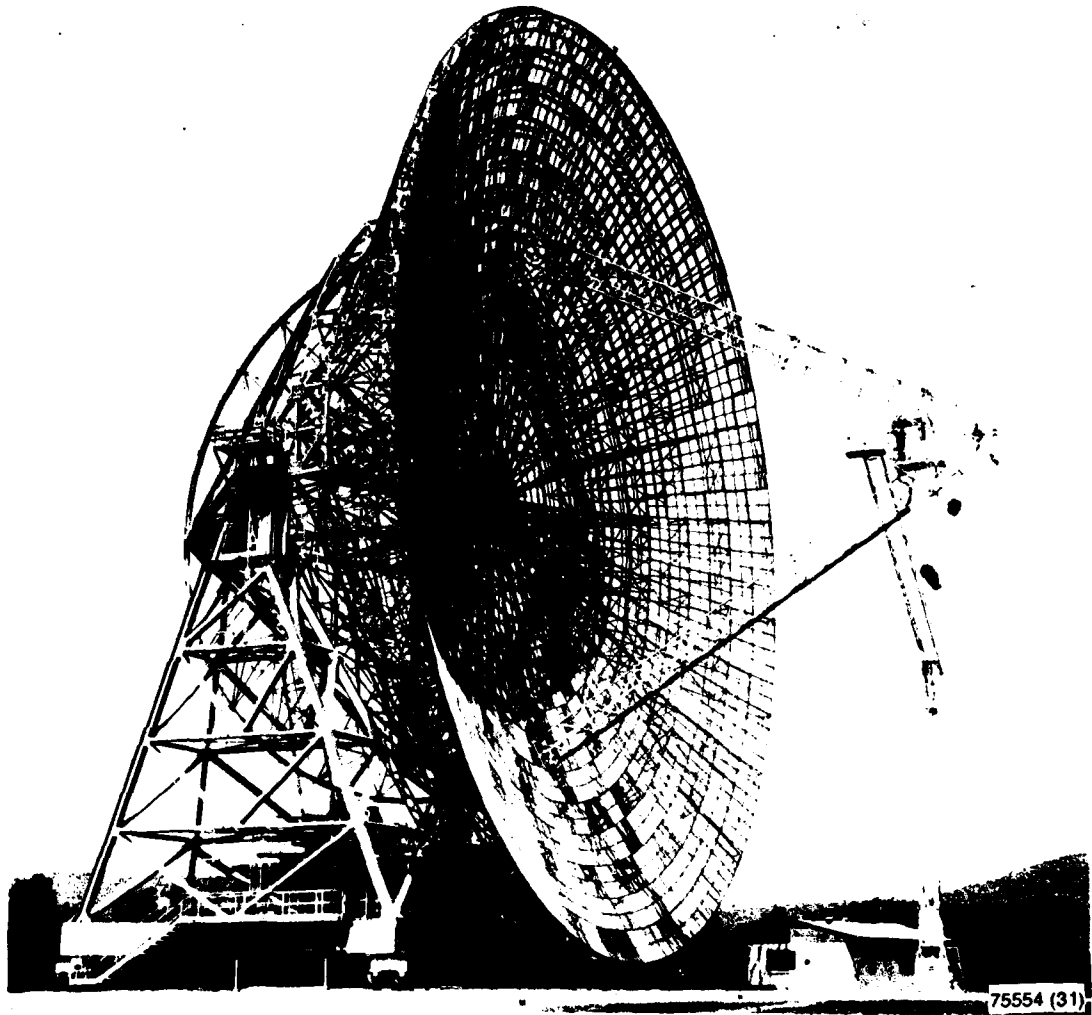

### NRL'S SUGAR GROVE, WEST VIRGINIA SITE

The antenna shown here is NRL's 150-foot parabolic reflector at Sugar Grove, West Virginia. This antenna is used for various space-research projects. It was designed by NRL (1966).

to maintaining close surveillance over the contractor for the antenna, the Laboratory provided the digital interface equipment, including consoles for computer control of the antenna system and the programs (software) for pointing the antenna at any celestial body or any satellite for which data is known, including corrections for atmospheric pointing errors. The Laboratory's

in-house effort has also provided the receiving, data processing, transmitter and receiver monitoring and safety equipment.

### Communication with Active Satellites

In addition to its moon-relay-system work, NRL proposed a research-and-development

## RADIO COMMUNICATION

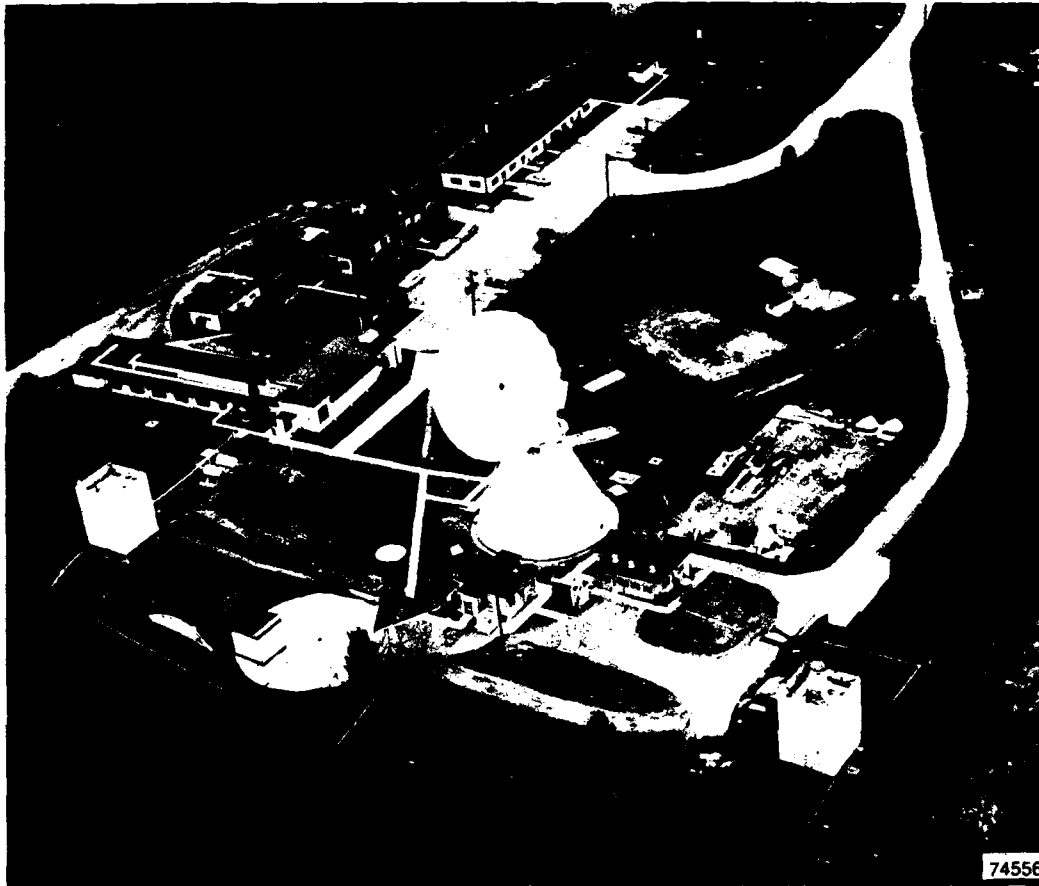

**NRL'S SATELLITE-COMMUNICATION RESEARCH FACILITY AT WALDORF, MARYLAND**

This research facility has a capability superior to any of its type (1973) and is effective at frequencies as high as 20,000 MHz. It comprises a 60-foot, parabolic, cassegrainian antenna of highest steering accuracy (center), a 25-kW transmitter (building in front of antenna), antenna control, computer control, data processing, receiving and modem equipment (buildings at extreme left), and laboratory work space (buildings in background).

program directed to active satellites which would serve as transponders in relaying communications over long distances (1957). This program was forwarded to the Navy Department to obtain sponsorship. NRL later developed the proposal in further detail, which included the availability of a ship adequately equipped for satellite-communication experiments, with which observations could be made in those parts of the world of particular Naval operational interest

(1959). This proposal was adopted by the Navy, issued by the Chief of Naval Operations as the Navy's Satellite Communication Plan, and transmitted to the Office of the Secretary of Defense. The cognizant office (Advanced Research Projects Agency) had under consideration the development of an active communication satellite system which would be used jointly by the several military services, and in 1960 set up a program to pursue this objective.<sup>227</sup> Due to difficulties in

## RADIO COMMUNICATION

matching satellite design with launching-vehicle capability, the program was modified by establishing a joint project with the National Aeronautics and Space Administration (NASA) to utilize their SYNCOM satellites then underway (1962). In furtherance of this project, the Army provided ground terminals located at Fort Dix, New Jersey, and Camp Roberts, California. As proposed by NRL, the Navy provided a ship, the USNS KINGSPORT (TAG-164), with experimental equipment, which became the world's first ship terminal equipped for operation with active communication satellites (1963).<sup>228</sup> When the SYNCOM I satellite was launched (14 Feb. 1963), the USNS KINGSPORT became the first ship to transmit and receive a voice message via an active satellite. When the SYNCOM II satellite was placed in its synchronous orbit over Madagascar (26 July 1963), the USNS KINGSPORT, stationed in the harbor at Lagos, Nigeria, passed the first telephone conversations via satellite between

heads of government (President J. F. Kennedy and Nigerian Prime Minister Sir A. T. Balewa, 23 Aug. 1963), inaugurating the space craft.<sup>229</sup> SYNCOM I utilized 7360 MHz for the uplink frequency and 1815 MHz for the downlink (2 watts). The communication with the USNS KINGSPORT took place as the satellite approached its synchronous orbit. Shortly thereafter, the satellite became inoperative.<sup>229</sup> After the early SYNCOM II trials, the ship was moved into the Mediterranean area for operational demonstrations with the U.S. Sixth Fleet via the satellite. The first demonstration of two-way voice communication from an aircraft in flight to a ship underway via satellite took place between a Navy aircraft off the Virginia coast and the USNS KINGSPORT located south of Morocco (2 Oct. 1963).<sup>230</sup> The ship proceeded to Guam and supported the launching of SYNCOM III when that satellite was placed in orbit over the International Date Line (19 Aug. 1964). NRL provided key technical information in

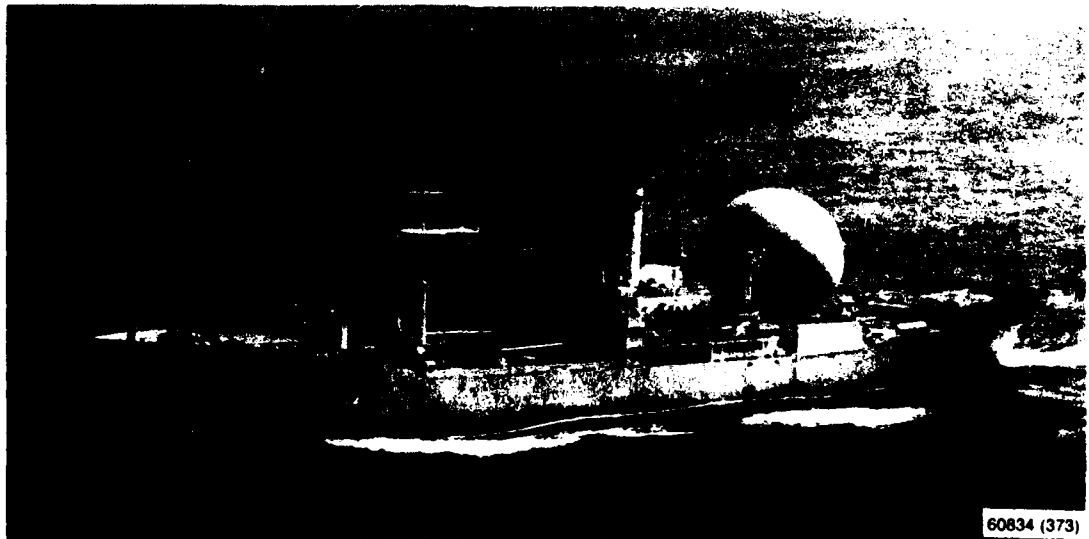

**FIRST SHIPBORNE ACTIVE SATELLITE COMMUNICATION TERMINAL**

The USS KINGSPORT (TAG-164) became the world's first ship terminal equipped for operation with active communication satellites (1963). It was the first ship to transmit a voice message via an active satellite (1963). NRL proposed this installation, which had the largest parabolic fully steerable antenna to be installed on a ship.

## RADIO COMMUNICATION

planning the communication capabilities and instrumentation for this ship, maintaining surveillance over its construction at contractors' plants and during trials aboard ship. The Laboratory was particularly concerned with the design of the ship's special antenna and its associated controls. This 30-foot, fully steerable parabolic antenna mounted in a radome and stabilized to compensate for ship motion, was the largest to be installed on a ship up to that time (1962). Its three-axis design provided effective tracking of satellites, particularly those passing immediately overhead. The ship's capability matched that of the entire system for simultaneous transmission and reception of voice, teleprinter, and facsimile.

The SYNCOM satellites were the first to be placed in a circular equatorial orbit, revolving nearly synchronously with the earth's rotation at an altitude of about 19,300 nautical miles. This orbit permitted them to be relatively stationary at a particular longitude and thus to be capable of providing continuous 24-hour communication service. Three such satellites, equally spaced about the equator, were planned to provide communication coverage of the globe (95 percent), with the exception of the extreme polar caps.

### The Defense Satellite Communication System

The responsibility for providing a Department of Defense Satellite Communication System (DSCS), which would be utilized jointly by the several military services, devolved upon the Defense Communication Agency (DCA) (1962).<sup>231,232</sup> After extended considerations a plan was adopted to launch a series of geostationary (near-synchronous) satellites to obtain operational experience. The system resulting therefrom was designated the Interim Defense Communication Satellite System (IDCSS, later called DSCS, Phase I). As the plan evolved, the Air Force became responsible for the development of the satellites, for placing them in orbit, and for the development of their airborne terminals. The Army became responsible for the

ground terminals, and the Navy for its shipboard terminals. The Laboratory worked closely with the Navy Department offices concerned and with DCA to provide a capability in the joint system adequate to serve Navy requirements.

### Satellite Characteristics

The Extraordinary Administrative Radio Conference, held at Geneva, Switzerland, in 1962, and attended by representatives of 70 nations including the United States, agreed to the frequency channel assignments for use by communication satellites.<sup>231</sup> An NRL staff member was the U.S. Navy representative on the executive committee of the International Radio Consultative Committee, the technical advisory body to this conference, and made certain that the Navy's interests were adequately considered. Furthermore, the Laboratory provided necessary technical information to support the Navy's position. The United States ratified the agreement of the conference in 1964, and accordingly the frequency channels in the 8000-MHz region were designated for the uplink and those in the 7000-MHz region for the downlink of the DSCS, Phase I satellites. In NRL's consideration of the technical characteristics proposed for these satellites, that of frequency bandwidth was of particular concern. The design originally proposed provided a very wide pass bandwidth for the satellite, suitable for operation with high-power ground terminals with large antennas, but not with the small antennas and the lower transmitter power which had to be used on ships. In addition to this lower transmitter capability to operate the satellite, the Navy terminal had to contend with lower signal-to-noise ratio received from the satellite due to the spreading of its transmitter power (5 watts) over the entire bandwidth. NRL succeeded in having the frequency bandwidth of the DSCS, Phase I satellites reduced so as to make ship terminal operation effective (from 40 MHz to 20 MHz) (1966). A total of 26 DSCS satellites were placed in geostationary equatorial orbits in four launchings with Titan III C vehicles during



## RADIO COMMUNICATION

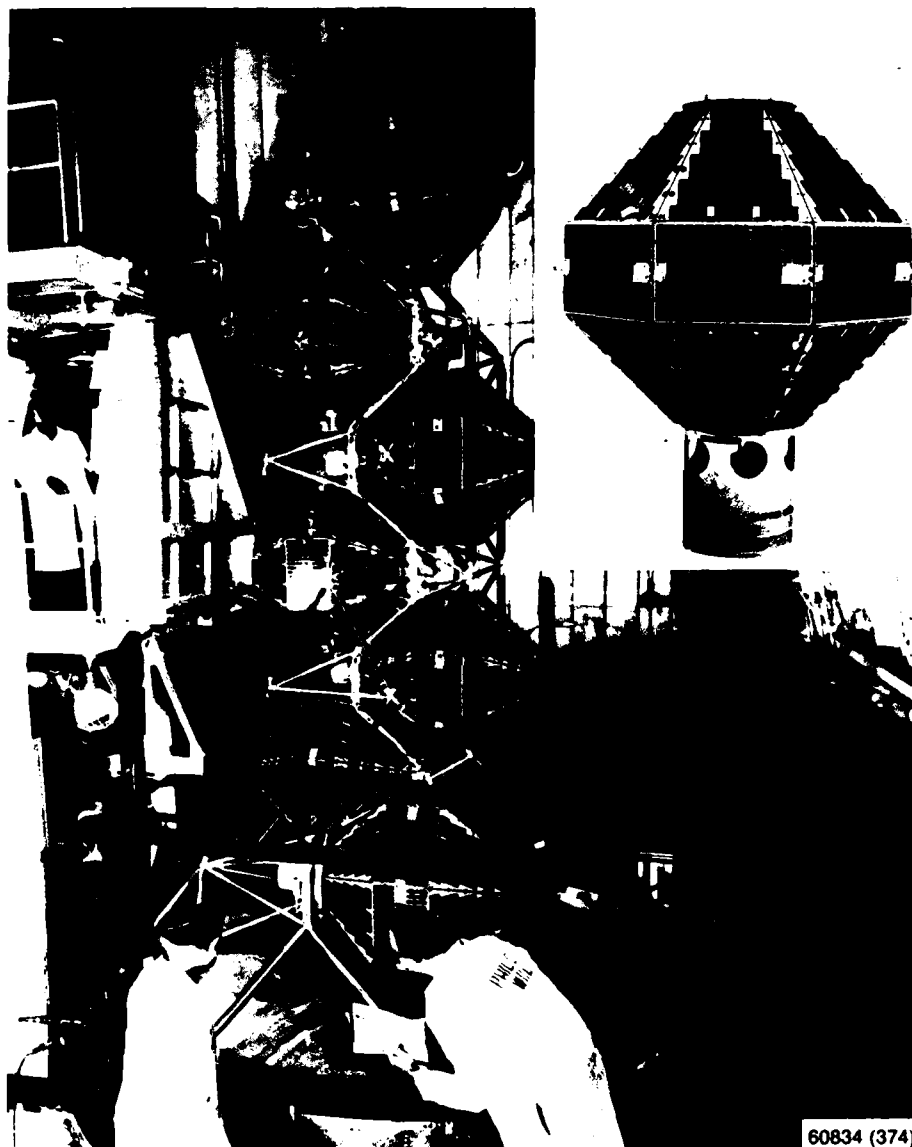

### DEPARTMENT OF DEFENSE SATELLITE COMMUNICATION SYSTEM (DSCS-1) SATELLITES

For this first operational system, 26 satellites were launched into geo-stationary equatorial orbits during the period from June 1966 to June 1968, and were disposed around the world to provide continuous coverage. NRL participated in determining the characteristics of these satellites to make certain that their performance was adequate to meet the Navy's operational requirements.

the period between 16 June 1966 and 13 June 1968.<sup>232</sup> In carrying out its investigations, NRL utilized practically every one of these satellites.

#### Target Photo Transmissions, Southeast Asia to Washington

NRL provided the Washington terminal for an urgent DCA-directed project (Compass Link) established for the transmission of target photographs of greatly superior quality from South Vietnam for use by high-level officials in Washington in authorizing attacks in Southeast Asia (1967). A unique circuit was established to cover the great distance using two DSCS satellites with a ground repeater located first on the west coast of the United States and later on Oahu, Hawaii to equalize the distances spanned. Using its Waldorf satellite-communication facility, NRL was successful in receiving the first two-satellite-hop transmissions, which were at the highest rate attained up to that time for encrypted digital data over a radio circuit. The transmissions resulted in photographic reproductions of highest quality, adequate for planning military actions. The military objective of the project was carried out successfully. NRL continued to provide this service during most of 1967 and for some time thereafter.

#### Navy Shipboard SATCOM Terminals

As the Navy Department proceeded with the procurement of satellite terminals for installation on its ships, the Laboratory participated in defining their technical features. One factor of particular importance was the size of the directive antenna, in view of the relatively low transmitting power of the DSCS, Phase I satellites. Since the communication capacity of the terminal was dependent upon antenna size, and since the superstructure space aboard ship was limited, a compromise was required. **NRL conducted an investigation, the results of which assured the Navy that directional antennas of acceptable**

size would provide substantial shipboard communication performance with active satellites (1964). To obtain the necessary data, NRL made measurements on SYNCOM II satellite transmissions received by an eight-foot-diameter parabolic antenna installation at its local site. Confirmatory measurements were made using SYNCOM III with a 60-foot antenna, which, with reduced transmitter power and received-signal attenuation, provided simulation of a six-foot-diameter antenna. The results showed that a six-foot-diameter antenna, which

60834 (375)

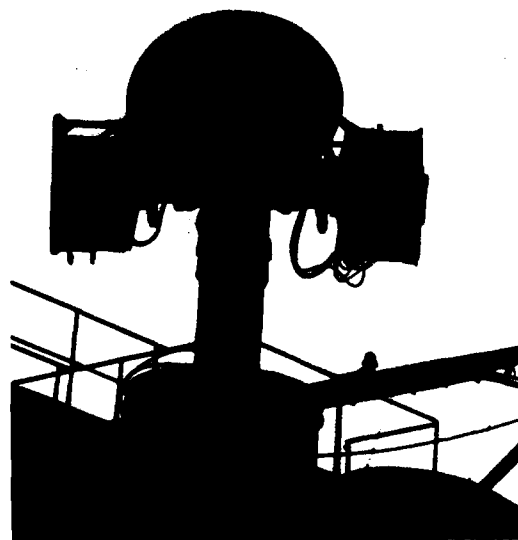

**SATELLITE COMMUNICATION TERMINAL,  
MODEL AN/SSC-2, INSTALLED ON THE USS  
CANBERRA (1965)**

This antenna had a 6-foot diameter. Results experienced with this antenna using SYNCOM II and SYNCOM III satellites confirmed the results of NRL's investigations that directional antennas of acceptable size would provide substantial shipboard performance with active satellites.

was specified for the Navy terminals, would assure substantial communication capacity. In its first procurement the Navy obtained two terminals (Model AN/SSC-2, 5 kW) with six-foot-diameter antennas, which were installed on the cruiser USS CANBERRA and the aircraft carrier USS MIDWAY. Experience with these equipments using SYNCOM II and SYNCOM III satellites further confirmed the feasibility of shipboard operation with antennas of this size (1965).<sup>233</sup> However, further terminal development work was required, since the operational frequencies for military communication satellites were somewhat altered, and since these experimental equipments lacked certain features necessary for Naval service. In a subsequent procurement, seven terminals (Model AN/SSC-3, 5 kW) were obtained, the first of which was installed on the guided-missile cruiser USS PROVIDENCE for trials during a major fleet exercise held in November 1966.<sup>234</sup> While some service was obtained from the AN/SSC-3 equipments, NRL's investigations of them in installations on the USS WRIGHT and at the Laboratory disclosed many serious deficiencies, both electronic and mechanical. These deficiencies included reception preamplification, antenna pointing, and inaccessibility of components relative to maintenance. They were of such import as to render the equipments unsuitable for normal operational service.<sup>235</sup> These deficiencies were thoroughly studied with the SSC-3 installation at NRL. The information obtained, together with that which could be secured from shipboard operations, was utilized in the development of improved equipment for general Naval use (AN/SSC-6).

#### Acquiring Satellites from Shipboard Terminals

Means must be provided on ships for pointing the tight beams of the parabolic antennas accurately from any position on the high seas so that the beacon signal emitted by the satellite for acquisition and tracking can be picked up.

Once the beacon signal is received, tracking is automatic. The transfer from one satellite to another must also be made expeditiously to avoid interruption to communication. NRL devised a satellite-acquisition procedure, based on tables generated by a computer program, which proved to be quick, simple, and effective for the Navy SATCOM shipboard terminals (1966).<sup>236</sup> The procedure was found usable with any near equatorial-synchronous satellite available. It replaced an acquisition method provided by the contractor for the SATCOM terminal which was found to be cumbersome and impractical, since it required extensive transmission of data to the ships. In using the NRL procedure with the DSCS-I satellites which drift eastward 30 degrees per day, information in addition to the tables must be supplied a ship only once a month. This NRL procedure was adopted by the British for their SATCOM terminals.

#### Navy Procurement of Shipboard Satellite Terminals

In addition to the work already cited, NRL conducted several investigations essential to satisfactory shipboard operation in preparation for the Navy's subsequent satellite procurement (Model AN/WSC-2). NRL devised a "flow-diagram" technique to facilitate the solution of SATCOM antenna-design problems concerning angular position, velocity, acceleration, and the externally applied forces and torques required for such motion in tracking satellites under the conditions of yaw, pitch, and roll experienced in various sea states (1970).<sup>237</sup> The results NRL has obtained in applying this technique to the solution of ship SATCOM stabilized-antenna problems, including the question of two-axis versus three-axis type structure, have been used in preparing specifications and evaluating proposed designs for the AN/WSC-2 terminals (1970).<sup>238</sup> The flow-diagram technique

RADIO COMMUNICATION

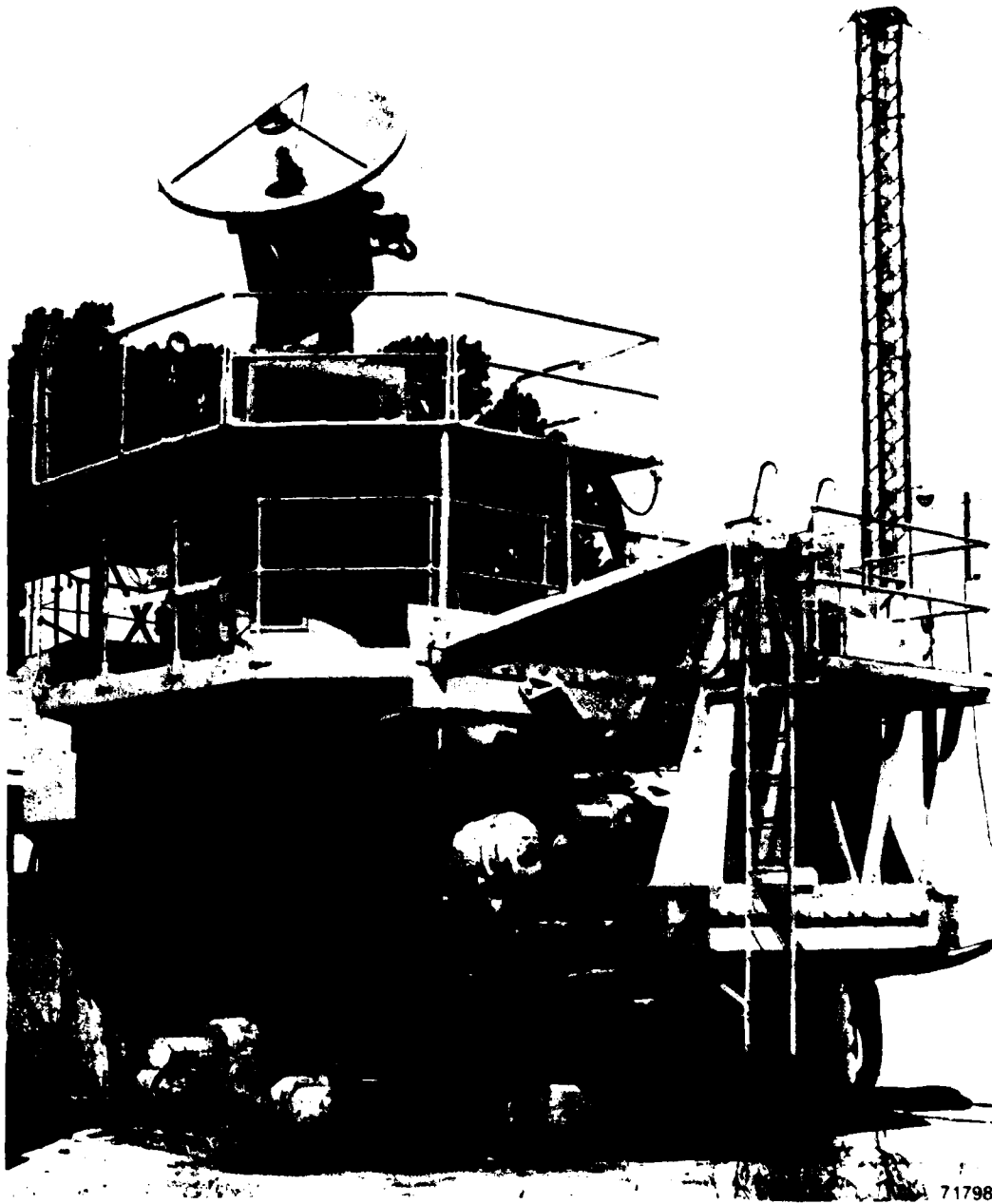

SATELLITE COMMUNICATION TERMINAL, MODEL AN/SSC-3, AS INSTALLED ON NRL'S ROLL AND PITCH PLATFORM FOR PERFORMANCE INVESTIGATIONS (1967)

The results of NRL's investigations of the many difficulties with these equipments have led to proposed modifications.

## RADIO COMMUNICATION

also has application to other time-varying coordinate systems such as weapons control, navigation, and guidance systems. NRL also devised a computer method for siting SATCOM antennas in installations on various classes of ships to avoid the geometric blockage caused by ship superstructure elements when tracking satellites, and to minimize difficulties with radiation-hazard areas (1970).<sup>239</sup> With this method, computer models of several ships were developed and used. Actual measurements taken aboard the USS WAINWRIGHT (DLG 28) have shown excellent agreement with coverages determined from the computer model of the same class ship (DLG 34). The need for more than one antenna installation aboard certain classes of ships to provide full hemispheric coverage and thus to avoid interruptions to communications was also assessed. In another investigation, NRL determined the vulnerability of SATCOM ship terminals to detection through interception by ships and aircraft (1965).<sup>240</sup> Improvements in antenna design which would minimize this vulnerability were also determined.

NRL investigated the effect of the relative motion of satellite repeaters in orbit and ship terminals subject to yaw, roll, and pitch, on SATCOM system performance (1969).<sup>241</sup> The results of NRL's investigation have been utilized in specifying requirements in the procurement of the AN/WSC-2 ship SATCOM terminals. It was determined that the change in transmission frequency experienced at the ship receiver due to this relative motion, i.e., Doppler, was of a magnitude sufficient to affect adversely signal acquisition and signal tracking. It was found that satisfactory operation could be obtained through Doppler compensation achieved by shifting the transmitter oscillator frequency and the receiver local oscillator frequency in opposite directions proportional to their respective frequencies. Reference to the frequency of the satellite beacon signal, provided for tracking the satellite from the ship terminal, permits making the

compensation automatic and in the correct amount.

Through a parametric analysis, using data obtained in experiments including those aboard the USS WRIGHT with the AN/SSC-3 terminals and the DSCS, Phase 1 satellites, NRL determined the communication circuit capacity relative to antenna size which could be expected from Navy shipboard SATCOM terminals (1966-1967).<sup>242</sup> The results obtained verified that communications adequate for Naval requirements could be obtained with parabolic antennas of a size compatible with several classes of Navy ships. This confirmed the choice of antenna size for the AN/WSC-2 SATCOM terminal. The effectiveness of modems (modulator-demodulator) is also a factor which must be considered in determining SATCOM system capacity. The very broad pass band possible with satellite repeaters operating at superhigh frequencies permits the use of unique modulation techniques for information transmission. The modem can be designed to produce a signal superimposed upon pseudonoise generated in accordance with a specific code, making the presence of the signal unresolvable on reception without proper decoding. In this "spread-spectrum" type modem, the signal and noise are spread over a certain portion of the frequency spectrum and communication-channel establishment, and separation is accomplished through the use of various codes. NRL's investigations of spread-spectrum modems (AN/URC-61 (X), AN/URC-55), procured under DCA-Army contract for use by the several military services, disclosed that they were not suitable for ship SATCOM system operation requiring communication-circuit netting configurations. In modifying the AN/URC-61 (X) modem, NRL developed multiplex carrier-suppressed pulse-duration modulation techniques which for the first time permitted satisfactory reception with low signal threshold, making possible shipboard SATCOM operation under adverse conditions (1966-1968).<sup>243</sup> This modulation technique was utilized in the Navy SATCOM terminals (AN/SSC-6), which followed. Up to four voice channels with

## RADIO COMMUNICATION

teleprinter order-wire or additional telewriter channels as alternates to voice channels are available with these techniques. NRL provided a modem using these techniques which has markedly increased the capacity and performance of a Navy satellite-communication circuit between Guantanamo Bay and Norfolk, Virginia (January 1970). Subsequently, NRL, with the aid of a contractor, also developed a modem incorporating new NRL-devised techniques that provided many more channels of high-quality voice, teletypewriter, and data transmission, with a high degree of reliability and flexibility. The new modem techniques have made possible simplicity and compactness in design, with ease of operation and maintenance at a fraction of the communication-channel cost as compared with earlier spread-spectrum modems.

### The Defense Satellite Communication System, Phase II

After the planning of the DSCS-I was well underway, efforts were initiated under the cognizance of DCA for an advanced system (DSCS-II) having greater communication capacity and flexibility. Since their beginning in 1965, NRL has participated in the Defense Communication Agency planning considerations to make certain that the performance of the new DSCS-II satellite repeaters was adequate to meet the Navy's foreseeable requirements and that the Navy SATCOM terminals (AN/WSC-2) were designed to take full advantage of the advanced characteristics of these repeaters as well as to operate satisfactorily with the DSCS-I satellite repeaters. The DSCS-II system provides worldwide national military communications for command control as a part of the Defense Communication System, linking together the U.S. forces dispersed around the globe and with the national command authorities in Washington, D.C.<sup>244</sup>

The results of NRL's investigations, previously described, were utilized in defining the

features of the DSCS-II system and the characteristics of its satellites of consequence to the Navy. An additional investigation of importance to system design was directed to determining the problems involved in "satellite multiple access" and their solution. The number of SATCOM terminals which simultaneously can use a satellite without mutual interference is limited principally by the power output of the satellite. In experiments to obtain data on this and other factors, NRL participated in a joint effort using its Waldorf, Maryland SATCOM Research Facility cooperatively with the USS WRIGHT, using its AN/SSC-3 terminal, the U.S. Army, using its Fort Dix and Fort Monmouth terminals, and the British, using their terminals at Christ Church, England, and Cyprus (November 1957—March 1968). The DSCS-I satellites were over the Atlantic Ocean. The data collected confirmed the results of prior analysis and showed that if a satellite repeater is to serve the maximum number of terminals simultaneously and without mutual interference, its output power must be controlled by a power balance of the several terminal transmitters so that each receiving terminal obtains power proportional to its receiving capability and data rate. Procedures were devised using pseudo-noise which through spread-spectrum modulation of the satellite permits the proper power balance to be achieved quickly and easily. During the investigation, the level of a jamming signal above the power-balance level of the satellite required to cause degradation of the repeater performance was also determined. The information obtained in the several investigations served to guide the development of the DSCS-II system and its satellites.

Prototypes of the DSCS-II satellites have been constructed with a total capability of 1300 duplex voice channels, or up to 100 megabits in data transmission, to serve the several military services and to be apportioned among them. The power output of the transmitter is enhanced by antenna gain from two alternate antennas—an earth-

coverage antenna (gain 17 dB), and a narrow-coverage antenna (gain 33 dB). The design of the satellites includes provision for maintaining them in fixed longitudinal positions which will simplify their acquisition by mobile terminals. The satellites were planned for a life of five years.

In preparation for developments beyond the DSCS-II system, NRL has studied the potentialities of radio frequencies in the range of 10,000 to 100,000 MHz, a part of the radio spectrum virtually unoccupied (1965-1968)<sup>240,245</sup> However, this is a region where oxygen and water vapor in the atmosphere introduce considerable attenuation into the signal path. Precipitation also causes energy loss due to scatter. Nevertheless, as these impediments are contended with, a tremendous number of satellite-communication channels are made available. The reduction of antenna size and increased communication capacity at these frequencies is normally of considerable importance in shipboard installations.

#### Tactical Satellite Communication System (TACSATCOM)

In 1965, concern arose regarding the capability of the DSCS to provide adequately for the "tactical" communication needs of the Army, Navy, and Air Force in addition to "strategic" communication needs, which are considered its principal function, and of particular interest to DCA. As a result, the Deputy Director of Defense authorized the military departments, with the guidance of the Director of Defense Research and Engineering, to initiate action to explore the use of satellite repeaters "to provide the fluid and flexible response normally associated with the expression 'tactical' communication" (October 1965). The Army, Navy, and Air Force were to proceed with their respective terminals. The Air Force was to provide the

satellites, designed and orbited to meet the joint requirements. The services, under the "guiding direction of the Joint Chiefs of Staff," were required to "initiate planning for future operational use of tactical satellite communications." A "TACSATCOM Executive Steering Group," with members representing the respective services, was established to conduct the resulting program as a joint effort.

The UHF band (225 to 400 MHz), assigned to the military for tactical communications, had been limited normally to short-range use due to cutoff of transmission at the horizon. Future disposition of ships, particularly for task-force operations, were planned to extend far beyond this distance. It was determined that a first objective in the program would be to assess the capability of the UHF band and of the large quantity of existing UHF equipment, installed throughout the Navy and the other services, to provide longer range coverage through the use of satellite repeaters. It was considered that antenna problems would be much less severe at UHF than at super-high frequencies. The greater energy capture of simple UHF antennas was a favorable factor and might allow the use of the fixed "blade" antenna with omnidirectional coverage on aircraft which do not require large communication capacity. The results of system studies and communication circuit trials with experimental satellites (LES 5 and 6) provided by the Air Force and experimental terminals provided by each service were encouraging (1967-1968).<sup>246</sup> However, NRL found that existing UHF transmitters and receivers had inadequate frequency stability and flexibility and that the receivers lacked sensitivity. Subsequently, new terminals were procured with single-channel capacity for airborne (AN/ARC-146, 1 kW) and mobile (AN/TRC-156, 20 W; 157, 1 kW; AN/ MSC-58, 100 W) functions. However, the ship terminals procured (ten Model AN/WSC-1, 1 kW) were designed to provide up to five voice or teleprinter channels, as recommended by NRL,

RADIO COMMUNICATION

60834 (376)

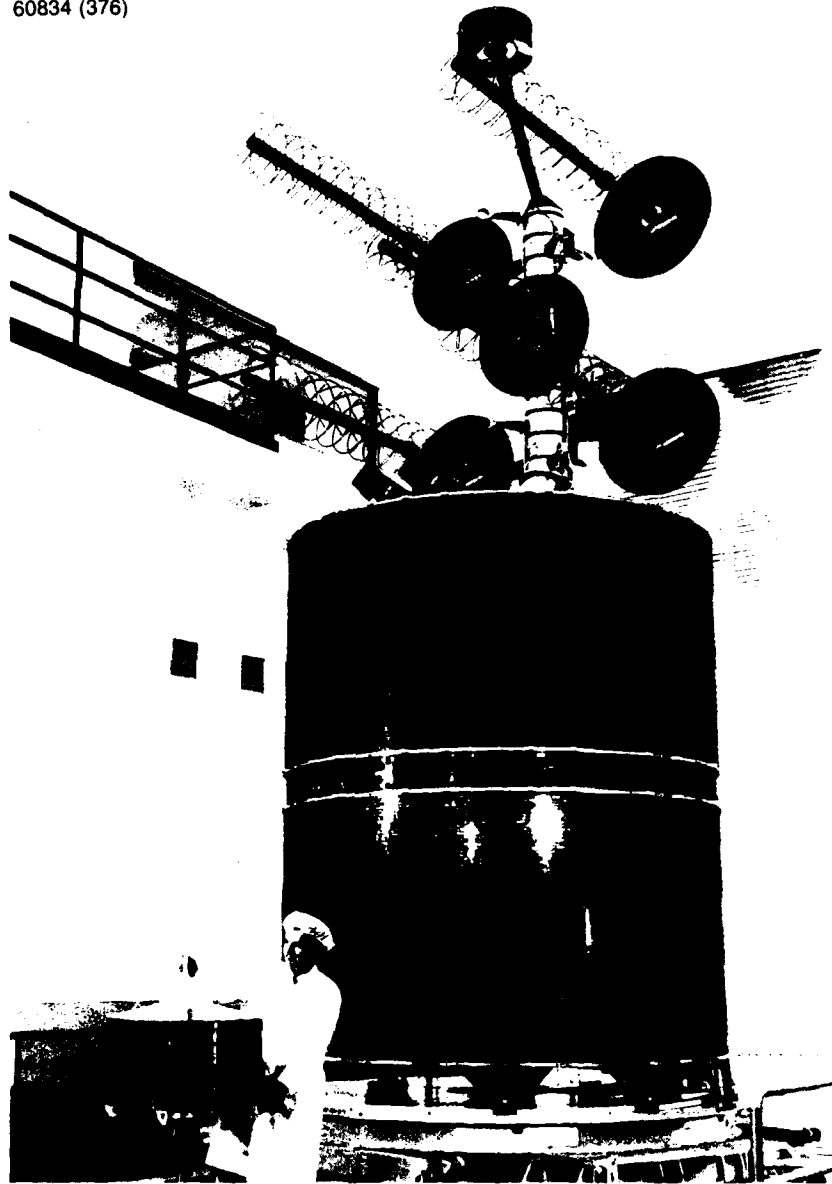

TACTICAL COMMUNICATION SATELLITE

TACSAT-1, launched 9 Feb. 1969 for military communications use, dwarfs the SYCNOM-1 model, the first Department of Defense satellite. Using satellite SYCNOM-1 the USNS KINGSPORT, with the installation originally proposed by NRL, became the first ship to transmit and receive a voice message via an active satellite (14 Feb. 1963).



so that larger communication capacity would be available to serve shipboard needs. TACSAT-I, a satellite of special design, was provided by the Air Force and launched 9 Feb. 1969.<sup>247</sup> The evaluation of the system which followed included tests of the several types of terminals with voice, teleprinter, and data transmission (1969-1970). The evaluation established the feasibility of using satellite repeaters to extend the range of ship-ship and ship-shore UHF communications to such ranges beyond the horizon as are included in the area of the earth covered by the satellite antenna beam. The evaluation also showed that aircraft could use the system successfully for limited communication capacity.

NRL participated in the TACSATCOM program from its beginning, with regard to those technical aspects of importance to the Navy. In proceeding with this program, NRL made contributions to the determination of the characteristics of the system and equipment, to studies for the adaptation of existing UHF equipment, drafting of specifications for new equipment, monitoring of contractors during its procurement, devising of evaluation plans, and to projection of the results obtained to determine the next phase of the program. Furthermore, since the cost of the previously developed satellite terminals would limit their installation in the Navy, the Laboratory developed a simplified terminal of low cost for small ships. Two such terminals were assembled and their performance through the TACSAT-I satellite satisfactorily demonstrated, to provide an example of how costs could be reduced in future procurements (December 1970).

## COMMUNICATION AT THE LOWER RADIO FREQUENCIES

### Introduction

The radio frequencies below the broadcast band have been designated "very-low frequencies (VLF)," 3 to 30 kHz; "low frequencies (LF),"

30 to 300 kHz; and "medium frequencies (MF)," 300 to 550 kHz. The Navy was early to appreciate the value of the very-low frequencies for long-distance communication from shore to its ships at sea. Very high power could be radiated from the huge antennas used at these very-low frequencies, which made worldwide coverage feasible. By the end of World War I the Navy had established a chain of high-power arc stations, giving coverage of much of the Atlantic and Pacific Oceans.<sup>248</sup> Since then, this chain has been augmented with additional stations to increase coverage and modernized as new developments, such as vacuum-tube transmitters, became available through the years to give the system greater performance (0.5 to 2 MW, 12 to 30 kHz).<sup>249</sup> The low and medium frequency bands carried the major portion of the communication traffic from the Navy's shore stations before the advent of high frequencies.

Prior to the development of the high-frequency band, the Navy relied principally upon frequencies in the range from 175 to 550 kHz for transmission from its ships. In this frequency range, antennas were small enough to be accommodated aboard ship and could provide acceptable radiation efficiency. But only a few such antennas could be installed on a ship and be free of serious interaction. As Naval radio-communication requirements increased and high-frequency-band developments were able to meet them, the lower frequency shipboard transmitting facilities were displaced. Since the 1950's, lower frequency transmitting facilities no longer have been provided for Naval vessels except for very-short-range transmissions in the medium-frequency band, using small antennas and for certain special installations. However, relinquishing these facilities resulted in the loss of a capability of solid communication coverage out to a range of 300 miles. This range capability is of importance in task-force operation, and provision of backup for communication is needed in case of the occurrence of high-frequency blackouts experienced in operations from time to time

With respect to reception, the Navy provided its ships with a capability of receiving the lower frequencies, particularly for Fleet broadcasts.

#### Radio-Wave Propagation at the Lower Frequencies

The propagation of radio waves over the surface of the earth at the lower frequencies received considerable attention during the period of the early development of radio communication, which took place principally in this frequency band. The Navy conducted investigations through which the first equation for radio-wave propagation, supported by experimental observations, was formulated (1911).<sup>250</sup> It became known as the Austin-Cohen formula. The accuracy of this equation and its frequency range (75 to 300 kHz) were improved (12 to 1000 kHz) through a long series of observations on long-distance, trans-Atlantic transmissions extending until 1931. As modified (1926),<sup>251</sup> the expression continued to have relevance.<sup>252</sup>

When the Laboratory began its work in 1923, its propagation effort was directed to the high-frequency band, then under exploration. The lower frequencies received only limited attention until later. In 1934 the Navy had experienced considerable difficulty in the handling of communication traffic on the lower frequencies between the radio stations of its Atlantic coastal chain and between these stations and ships at sea. The Laboratory was requested to investigate this situation and propose necessary changes. Using mobile field-intensity-measuring equipment, a survey of the coverage of these stations was conducted which included those at Boston, New London, New York, Washington, Norfolk, and Charleston, located at the respective Navy Yards and operating at 100 to 500 kHz (1934-1935). In addition to field strength, noise levels and noise-source locations were observed. The survey led to the relocation of some sites, the rearrangement of both transmitting and receiving equipment and antennas, the shielding of certain

components, and the addition of some new equipment. Adequate received signal levels resulted.<sup>253</sup> From time to time NRL was called upon to conduct similar surveys on which to base corrective action for difficulties arising in both shore and ship installations.

Early in World War II, Naval ships reported high daytime noise levels when in the vicinity of Newport, Rhode Island which interfered with reception of the 18-kHz transmissions from the high-power station at Annapolis, Maryland (NSS). Similar interference was reported with the reception of the 18-kHz transmissions from the Rocky Point, New York station by ships when in the vicinity of Norfolk, Virginia. In investigating the difficulty, the Laboratory noted that at the particular distance, approximately 325 miles, the signal level was abnormally low, and operators, while increasing signal amplification, had also increased the noise level. At night the signal level at both locations became abnormally high. Heretofore, it was generally held that VLF radio waves propagated, even to their greatest detectable distances, via a wave along the ground. This investigation demonstrated that the abnormally low daytime field strength at the distance indicated was produced by the destructive interference between the ground wave and the first reflected wave from the ionosphere. NRL's observation made in 1942 resulted in an early recognition of the "modal effect" in the propagation of very-low frequencies, later considered of importance.<sup>254</sup>

Severe high frequency blackouts had caused serious interruptions to communications between the Navy's ship operating in the Bering Sea and the Alaskan shore stations. NRL was requested to determine the utility of the lower frequencies as an alternate system for the arctic and subarctic regions. In conducting a survey of radio field strength, NRL established measuring equipments at Adak, Nome, Kodiak and Point Barrow. Observations were made of transmissions from a balloon-supported antenna aboard the USS BURTON ISLAND (100 and 150 kHz) operating

in the Bering Sea, and from stations located at San Diego, California (54 kHz); Pearl Harbor, Hawaii (16.68 and 19.8 kHz); Adak, Alaska (100 and 155 kHz); and Rugby, England (16.0 kHz) during 1951.<sup>266</sup> Although measurements of atmospheric noise level had been made by NRL in the Baffin Bay area during July and August 1946,<sup>266</sup> in view of the scarcity of noise data additional measurements were made at the sites stated (1951).<sup>267</sup> Additional work was done with the ice-breaker USS EDISTO operating in the North Atlantic in the Greenland and Iceland areas, using a 1000-foot-high balloon-supported antenna (1953 and 1955).<sup>268</sup> From the data obtained, it was established that one kilowatt of power radiated on 100 to 150 kHz from Naval vessels operating in arctic waters could provide reliable communication with shore stations with a range of 1500 miles.

#### Long-Wave Propagation Center

Since 1962 the Laboratory has been designated by the Navy to maintain the "Navy Long-Wave Propagation Center," which acts as a central agency in the acquisition, reduction, analysis, and promulgation of all available information pertaining to radio-wave propagation and atmospheric noise at the lower frequencies. This function is intended to advance the capability of the Navy's communication systems using these frequencies.<sup>269</sup> The Center develops means to enable highly reliable worldwide predictions of signal strength and atmospheric noise levels to be made under all possible conditions of transmitter and receiver locations, time and season, enemy countermeasures, and variations in propagation paths. In furtherance of a coordinated Navy program, all work in the field is monitored by the Center, and guidance is furnished other Navy laboratories and contractors engaged in the program.

#### Radio-Wave Propagation at the Very-Low Frequencies

NRL conducted the first thorough worldwide radio-wave propagation program to

**determine the capability of the Navy's chain of high-power, very-low-frequency stations to communication with its Polaris submarines, wherever they might be.** The importance of command communications to control the nation's undersea nuclear deterrent had focused attention on the coverage, continuity, and reliability of the Navy's transmission system. Any inadequacies disclosed by the investigation would be corrected to insure satisfactory performance. In carrying out the program for the Atlantic Ocean, Mediterranean, and Arabian Sea areas, the field strength of received signals and atmospheric noise levels were recorded at Hammerfest, Bodo, and Varhaug, Norway; Rome, Italy; Haifa, Israel; and Karachi, West Pakistan on transmissions from the Navy's stations at Annapolis, Maryland (NSS, 15.5 and 22.3 kHz); Jim Creek, Washington (NPG, 18.6 and 24.0 kHz); Lualualei, Oahu, Hawaii (NPM, 16.6 and 19.9 kHz); Summit, Panama Canal Zone (NBA, 18.0 kHz); and Cutler, Maine (NAA, 14.7 and 18.6 kHz) during the period from 1958 to 1963. The data collected were analyzed, correlated with various geophysical phenomena, and presented in the form of diurnal charts normalized to 1 kW of radiated power for the Navy's use. The statistical relationship of the field strength of the various transmissions, atmospheric noise, and the signal-to-noise ratios with the time of day and season of the year were also presented. Through an analysis of the data, it was recognized that greater attenuation was encountered in propagation over Greenland and the permafrost areas of the Arctic and sub-Arctic. Using NRL's specially equipped aircraft, additional data were collected in many flights over the North American Arctic and Greenland which confirmed this effect (1959-1966).

When the Navy's high-power, very-low-frequency station at Northwest Cape, Australia was completed in 1967, the Laboratory was responsible for the conduct of a similar propagation program to determine the improvement in coverage of the Western Pacific Ocean, Indian Ocean, and Southeast Asia areas afforded by this station. Field-strength and atmospheric-noise

## RADIO COMMUNICATION

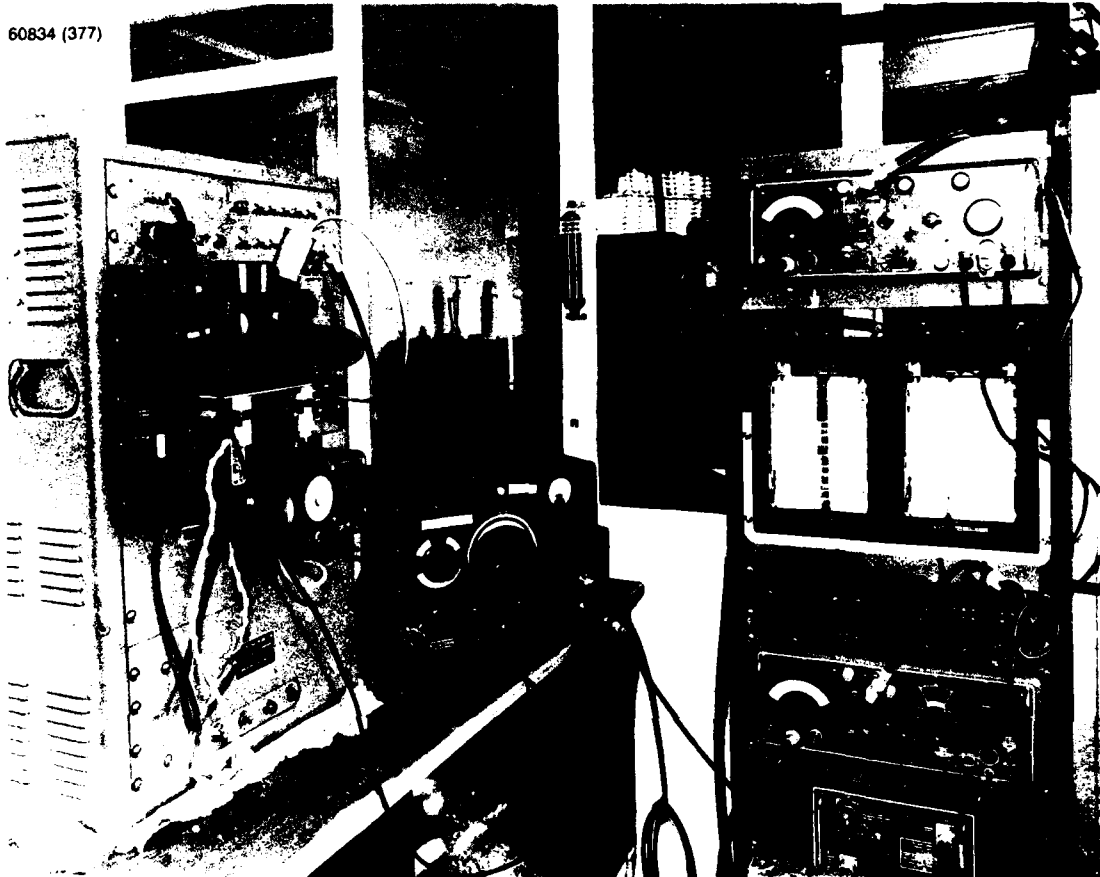

**NRL'S VLF PROPAGATION OBSERVATION STATION AT BODO, NORWAY (1958)**

This station is one of several established by NRL in the eastern Atlantic, Mediterranean, and Arabian Sea areas as part of a program to determine the capability of the Navy's chain of high-power, very-low-frequency radio stations.

measurements were made at observation points established at Tananarive, Malagasy Republic; Bahrain Island; and Choshi, Japan (1967-1970).<sup>260</sup> Cooperating organizations provided data taken at Alaska, Hawaii, Philippine Islands, and Guam. Based on the analysis of the data obtained and other criteria, NRL recommended 22.3 kHz as the best frequency for the new station. The Navy concurred and made the corresponding assignment.

Another phase of very-low-frequency propagation investigated concerned the diurnal variations of the resultant field at the antipodes of

Navy transmitting stations. This field comprises the several energy components traveling via the various global transmission paths and converging in the region of the antipode. NRL's WV-2 aircraft was provided with field-strength and phase-measuring equipment, and recordings were made of the resultant field in the vicinity of the antipode of the Navy's transmitter at Cutler, Maine (NAA, 14.7 kHz) cooperatively by NRL and members of other organizations (1962).<sup>261,262</sup> This antipode was located in the Indian Ocean, 800 miles SSW of Perth, Australia. Similarly, the resultant field at the antipode of the Navy's

## RADIO COMMUNICATION

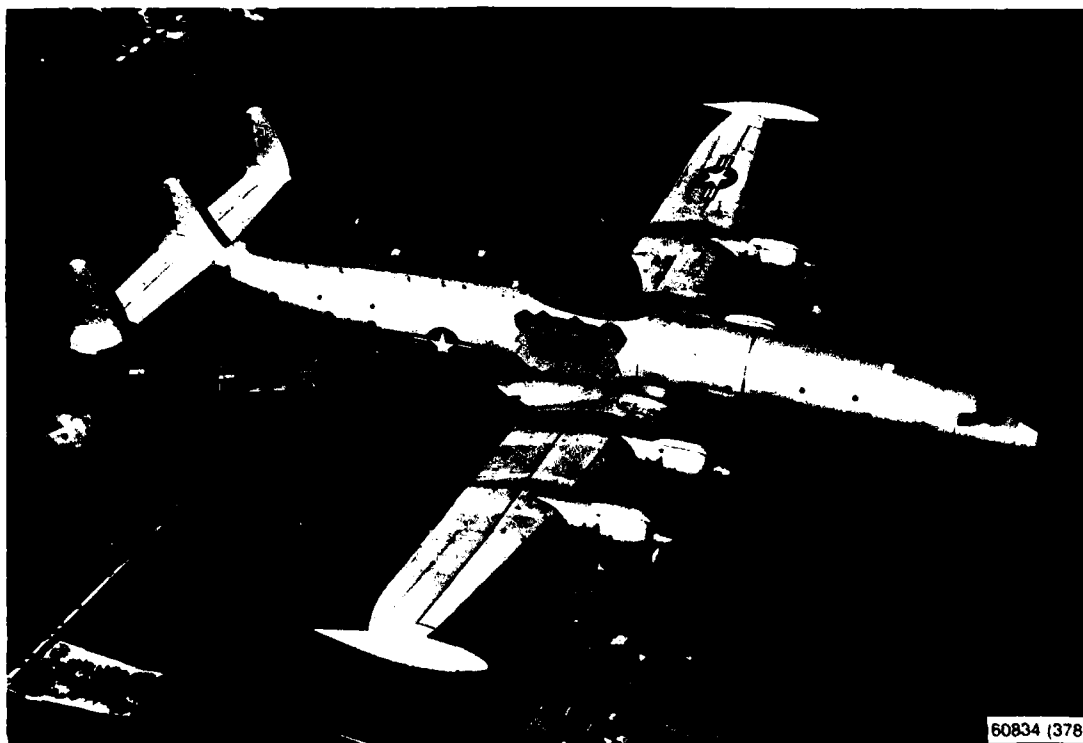

NRL'S WV-2 AIRCRAFT (1962)

The cutaway views show equipment especially developed by NRL for very-low-frequency propagation observations. Many flights over large global areas have been made in obtaining data.

transmitter at Lualualei, Hawaii (NPM, 19.8 kHz) was also investigated. Recordings were made with equipment installed both on the ground and in aircraft at the antipode in Botswana, Africa (1963).<sup>262</sup>

An analysis of the data disclosed that the differences in path characteristics for the several energy components due to diurnal changes and variations in attenuation rates for the various terrains caused a highly complex and variable pattern to be presented at the antipode. Nevertheless, the field strength is reinforced, and this results in improved communication capability in the region of the antipode.

**NRL was first to recognize that the earth's magnetic field had a substantial influence on**

**the nighttime attenuation rates of the very low frequencies propagated in the north-south (and reverse) direction. Observations which disclosed this effect were first made in Santiago, Chile on the transmissions of the Navy's stations at Cutler, Maine (NAA, 14.7 kHz), Annapolis, Maryland (NSS, 22.3 kHz), and at Summit, Panama Canal Zone (NBA, 18.0 kHz) (1963).<sup>263</sup> In 1969 the effect was established theoretically and generally accepted. Prior to this work only meager propagation data were available for north-south paths, and theoretical considerations had not disclosed such an effect.**

In determining the field strength provided at various distances, by the Navy's several very-low-frequency transmitters, the earth-ionosphere

## RADIO COMMUNICATION

interspace has been treated theoretically as a waveguide with its several modes of transmission. The theory provides a field-strength-versus-distance propagation curve with successive modal interference maxima and minima. To determine the accuracy of this concept, NRL made both daylight and nighttime field-strength observations on transmissions over seawater propagation paths aboard its aircraft flying between California, Guam, and Japan. Transmissions from Navy stations at Lualualei (NPM, 16.6, 19.6, 22.3, 24.0, and 26.1 kHz); Haiku, Hawaii (16.6 and 19.8 kHz); and Jim Creek (NPG, 18.6 kHz) were observed during May, June, and July 1965. Upon analysis the data

obtained for daylight seawater propagation paths out to 3.5 megameters showed good agreement with the theory. However, as expected, the nighttime data showed considerable irregularity. It had previously been considered by most investigators that the first-order mode was dominant at distances beyond two megameters. However, the results indicated that at least three orders were significant, even at distances exceeding three megameters.<sup>264</sup>

### Very-Low-Frequency Communication Coverage Prediction

NRL was responsible for the development of a computer program providing prediction

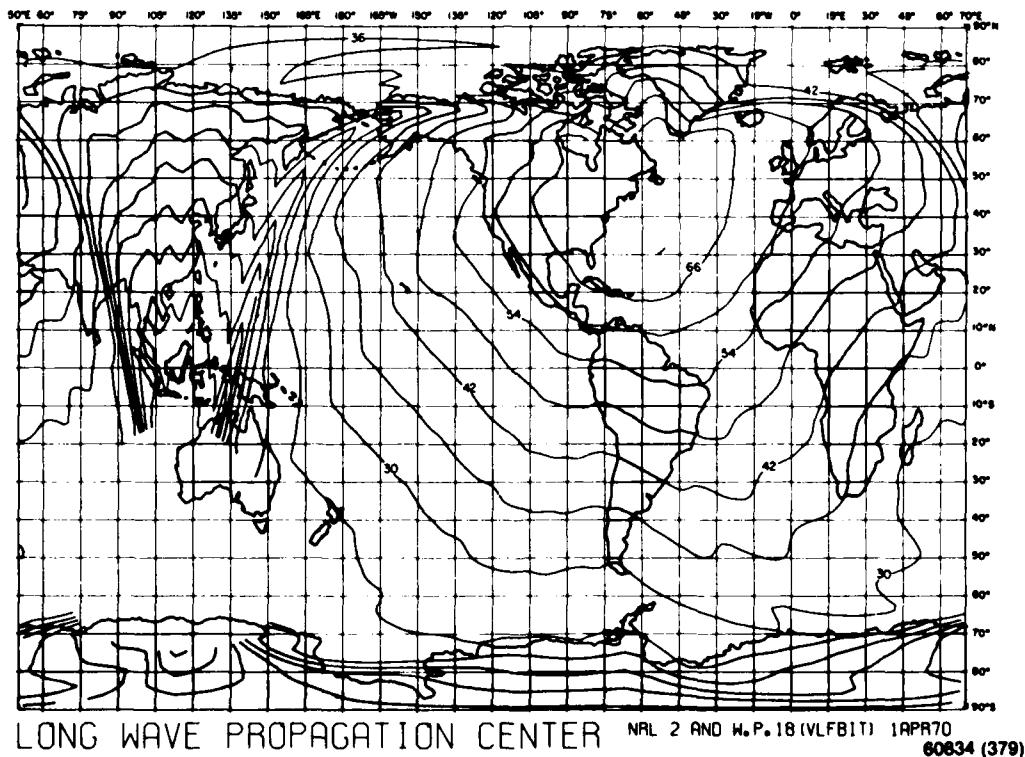

### VLF COMMUNICATION COVERAGE PREDICTION

NRL was first to develop a means of predicting the performance of the Navy's VLF communication system on a worldwide basis through the use of a computer program (1966-1970). The results are expressed on charts which show field-strength and signal-to-noise-ratio contours. A typical chart is shown above. This chart shows signal-level contours in decibels above one microvolt per meter for NAA, Cutler, Maine (17.8 kHz) for the month of July and a time availability of 99 percent.

of the performance of the Navy's very-low-frequency communication system on a worldwide basis (1966-1970). The Navy continued to use the information provided through this program to determine global transmitter and receiver site disposition, transmitter power levels, and the most effective transmitter frequency assignments for maximum transmission reliability. The information also formed the basis for various system improvements. This computer program incorporates propagation parameters determined by NRL and other organizations, a worldwide ground-conductivity map, and pertinent solar and magnetic factors. The program was updated as new information became available. For selected reception points, the computer output was automatically presented as worldwide coverage charts and as diurnal graphs, or in tabular form. Worldwide coverage prediction charts have been provided the Navy for its several very-low-frequency transmitting stations. The charts show field-strength and signal-to-noise-ratio contours on time-of-availability and probability bases for the seasons of the year. Other charts show contours of signal-to-jamming ratios, also on a worldwide basis.

#### Airborne VLF Transmission

The use of an airborne very-low-frequency transmitter with a long trailing-wire antenna has been considered as an alternate to the Navy's fixed ground transmitting stations (Project TACAMO). To determine the effectiveness of such an alternate, NRL measured the power radiated from such a transmitting system and the field strength versus distance produced under flight conditions (26.1 kHz). The vertical, effective radiated power (VERP) was found to vary markedly with the attitude of the antenna relative to the direction of the observation point, particularly while orbiting. In level flight the VERP was, as expected, affected considerably by the verticality of the antenna. System performance predictions of the communication coverage of the Atlantic Ocean and

Mediterranean Sea were made based on the information obtained (1966-1969). In this work, NRL was first to determine the radiated field from a VLF trailing-wire airborne antenna system as a continuous function of distance out to two megameters, and that under some situations the field strength had extremely large fades. Subsequently, NRL was first to develop a theoretical model which explained these fades and other unique characteristics of the TACAMO transmissions.

#### Communication with Submerged Submarines Via Satellites

Since only the very-low frequencies penetrate the sea sufficiently to make communication with submerged submarines practical, NRL considered the problems involved in a system in which satellites would be used to provide transmissions. The messages transmitted on VHF or UHF from ship and shore to satellites would be relayed by them to submerged submarines on VLF. Theoretical studies had indicated that the very-low frequencies would suffer some absorption loss in propagation through the ionosphere, but that sufficient energy should pass through to provide satisfactory communication to submarines. However, experimental data were not available to confirm the results.

The results of the Laboratory's investigation of the characteristics of atmospheric radio noise indicated that the propagation loss of VLF passing through the ionosphere would be of an acceptable level (1953-1958).<sup>265</sup> This noise is characterized by clicks, crashes, grinders, rumbles, rattles, and hisses (1953-1958). One type, possessing a quasimusical note usually descending in pitch known as "whistlers," was given special attention. Generated by disturbances such as lightning discharges, whistlers propagate via the magneto-ionic mode back and forth between the earth's northern and southern hemispheres, the change in pitch permitting identification of a particular whistler in successive passages. Recordings on earth showed as

## RADIO COMMUNICATION

many as 20 transits of the path between hemispheres by an identical whistler with a corresponding number of penetrations of the ionosphere, indicating remarkably little attenuation during penetration. During the International Geophysical Year (1957-1958) synoptic observations were made on atmospherics including whistlers at chains of observation points on both sides of the American continent, embracing the Arctic to the Antarctic.

To acquire experimental confirmation, NRL conducted the first investigation, Project LOFTI (Low Frequency Trans Ionospheric), to determine the capability of very low frequencies to penetrate the ionosphere and thus make possible radio communication transmissions from satellites to submerged sub-

marines (1961-1963).<sup>266</sup> Since a suitable radio-frequency power source was not readily available, the reverse path through the ionosphere, from earth to satellite, was examined. Two satellites were launched to obtain the data, LOFTI I on 21 Feb. 1961 from Cape Canaveral, Florida, having a duration of 36 days, and LOFTI II A, on 15 June 1963 from the Pacific Missile Range, Point Arguello, California, with a duration of 32 days. LOFTI I achieved an initial orbit with an apogee of 960 km, a perigee of 171 km, an apogee of 925 km, and an inclination angle of 69.88 degrees.

As the orbiting LOFTI I satellite passed within range, signals from the Navy's high-power transmitting station at Summit, Panama Canal Zone (NBA, 18.0 kHz) were received by the satellite.

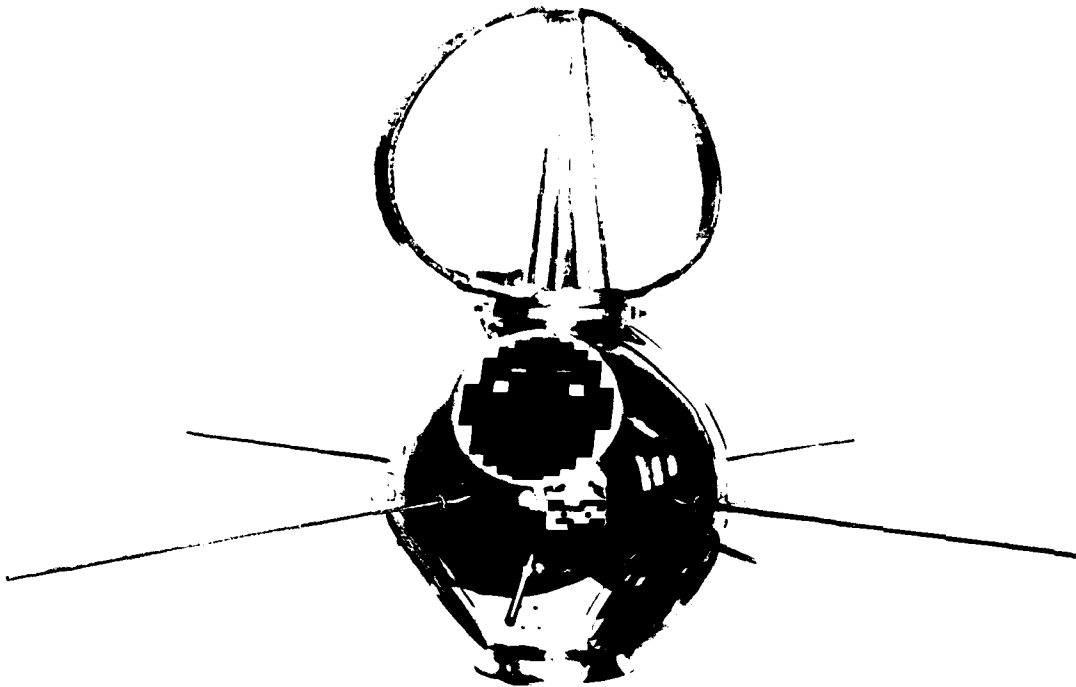

47224

**NRL'S LOFTI-I SATELLITE**

This NRL satellite was used to determine the feasibility of communication with submerged submarines from satellites on VLF (1961).



The received signals were quantized with respect to their strength, transmitted by the satellite as frequency modulated-amplitude modulated telemetry data via a 136-MHz link, and recorded at ten ground stations. These stations were located in North and South America, with one in Australia. Simultaneously, such "housekeeping" data as the satellite's skin, internal package, and solar-cell temperatures and its battery voltage were also transmitted. With LOFTI II, the received signals from four Navy transmitting stations were similarly treated by the satellite. These stations were NBA (10.2 and 18.0 kHz), and NPG/NLK (18.0 kHz), Jim Creek, Washington State; Haiku, Hawaii (10.2 kHz); and Forestport, New York (10.2 kHz). Telemetry data were recorded at Stump Neck, Maryland; Coco Solo, Panama; Barbers Point, Hawaii; Winkfield, England; Woomera, Australia; College, Alaska; Santiago, Chile; Mojave, California; and Fort Myers, Florida.

An analysis of the considerable amount of data taken with the LOFTI satellites indicated that energy radiated by the transmitters at very-low frequency penetrates the ionosphere in significant degree. Fifty percent of the time the magnetic-field intensity in the ionosphere is reduced less than 13 dB at night and less than 38 dB by day due to atmospheric attenuation, transition loss at the atmosphere-ionosphere interface, and attenuation due to absorption, plus spreading loss. The energy at 10 kHz suffered much less loss than did energy at 18 kHz. The LOFTI experiments have provided important results relative to assessing VLF transionospheric propagation. However, there remain uncertainties, such as the radiation of adequate VLF energy in the anisotropic medium encountered at desirable orbital attitudes which had to be resolved before a VLF transmitting system of predictable performance could be designed for Fleet use. The resolution of these uncertainties was pursued for some time.

With respect to radiating adequate power at the very-low frequencies from a satellite, the effects of the local electron density in the ionospheric environment upon the impedance characteristics of both electric dipole and loop

antennas was examined. The admittance of the electric dipole (two metal in-line tapes extending from the satellite, overall 40 feet) remained capacitive (10 to 18 kHz), but the apparent capacitance varied markedly as the satellite moved along its orbital path. The admittance of the loop was essentially unchanged by the environment.

#### Lower Frequency Antennas

NRL has determined the performance and characteristics of the very-low-frequency antennas of the high-power radio stations upon which the Navy relies for communication with its submarines, particularly when submerged. The results of the analysis of the data obtained have been used by the Navy in its decisions regarding the improvement of the performance of both the antennas and transmitters of these stations. The importance of high reliability in these communications and the limitations in the generation of very high power at low frequency make it necessary that the antenna systems radiate as efficiently as possible. Furthermore, the amount of power radiated and such factors as the effective height of the antenna must be known to permit prediction of the long-range coverage of the transmitting stations. The radiating capabilities are determined through the analysis of measurements of field strength at various bearings and precise distances from the antenna; these measurements must be made in comparatively large numbers to avoid undue influence on results caused by anomalies due to local terrain. Observations are made close enough to the antenna to avoid propagation effects, yet far enough away to be out of its induction field. Measurements must be made for each operating frequency, since radiation characteristics change with frequency. When three additional antenna towers were added to the existing six at the Navy's Radio Station at Annapolis, Maryland (NSS), NRL made measurements of the new performance (1940). NRL determined the radiating capabilities of the Navy's stations at Annapolis

(NSS, 15.5 kHz in 1961, 21.4 kHz in 1963); Jim Creek, Washington (NPG, 18.6 kHz in 1960, 1961, and 1962, 24.0 kHz in 1963); Summit, Panama Canal Zone (NBA, 10.2 and 18.0 kHz in 1963); Cutler, Maine (NAA, 14.7 and 18.6 kHz in 1963, 17.8 kHz in 1964); Lualualei, Hawaii (NPM, 19.8 kHz in 1963); Haiku, Hawaii (10.2 kHz in 1963); and Northwest Cape, Australia (NWC, 22.3 and 27.3 kHz in 1966).<sup>267</sup>

#### Submarine Trailing-Wire Antennas

Undersea trailing insulated wire antennas were used in early Navy communication experiments (1909)<sup>268</sup> and in experiments dealing with the remote control of torpedos from aircraft by radio (1920).<sup>269</sup> In the latter work, a 300-foot-long antenna trailing the submarine N-6 was supported at six-foot depth by surface floats placed at ten-foot spacings. In NRL's early work, the insulated antenna cable was threaded through a string of air-inflated rubber buoys spaced along its length (1931).<sup>270</sup> In later NRL experiments conducted with the submarines USS MEDREGAL AND USS SEA LION, "positive buoyancy" was provided by attaching an air-filled plastic tube directly to and along the length of the antenna cable (1947).<sup>271</sup> This arrangement greatly improved its trailing characteristics when a submarine was underway. In a further step, NRL developed a trailing-wire antenna having "positive buoyancy" due to the internal cable structure (1952).<sup>272-276</sup> The Navy's submarines were subsequently equipped with trailing-wire antennas using "positive buoyancy" cables. The positive buoyancy was provided by a layer of small plastic air-filled tubes, just inside the outer sheath of the cable, encircling the insulated covering of the wire. Thus, the antenna was held in proper attitude with respect to the sea surface, and yet it presented a smooth outer covering which in trailing avoided undesirable disturbance of the surface which might be seen as a wake or scar by enemy aircraft.

#### Lower Frequency Shipboard Antennas

Ship superstructure and the long lead-in "trunks" used in the large lower frequency

antenna installations on ships have marked influence on antenna-system characteristics which must be known for design of transmitters. In seeking antenna structures of minimum size and form best fitted to minimize superstructure influence, NRL carried on a theoretical and experimental program to determine such factors as capacitance, radiation resistance, energy-loss distribution, and effective height of such systems. The coupling between antennas, the characteristics of "trunks" and corona loss, and flashover in both antennas and "trunks" were investigated (1936-1942).<sup>277</sup> The results obtained were used by the Navy to upgrade its shipboard antenna installations. The results were also used in specifications for the procurement of transmitting equipment.

To contend with high-frequency blackouts experienced in the Arctic, the Laboratory devised a shipborne, 1000-foot-high zeppelin-type balloon-supported antenna so that the Navy's ships could maintain continuous communication with shore stations on the lower frequencies (first used on the USS BURTON ISLAND in 1951).<sup>268</sup> Further development of this antenna included a balloon-winch launch, retrieve, and control mechanism with which the 1000-foot-high antenna could be held essentially vertical in wind velocities up to 40 knots. This antenna system was demonstrated on the icebreaker, USS EDISTO, operating in the North Atlantic in the Greenland and Iceland areas (1953 and 1955). It was established that with a power of 1 kW radiated from the antenna on 100 to 150 kHz, reliable communication could be provided to Alaskan shore stations within a range of 1500 miles. Early consideration was given to the use of a helicopter to replace the balloon in supporting the antennas (1959). A 4000-foot-high, helicopter-supported antenna would provide effective radiation of power at the very-low frequencies for communication with submerged submarines. Such a helicopter-supported antenna was considered a possible alternate for the high-power shore transmitting stations, with somewhat less coverage capability due to the limit of the power available in mobile installations.

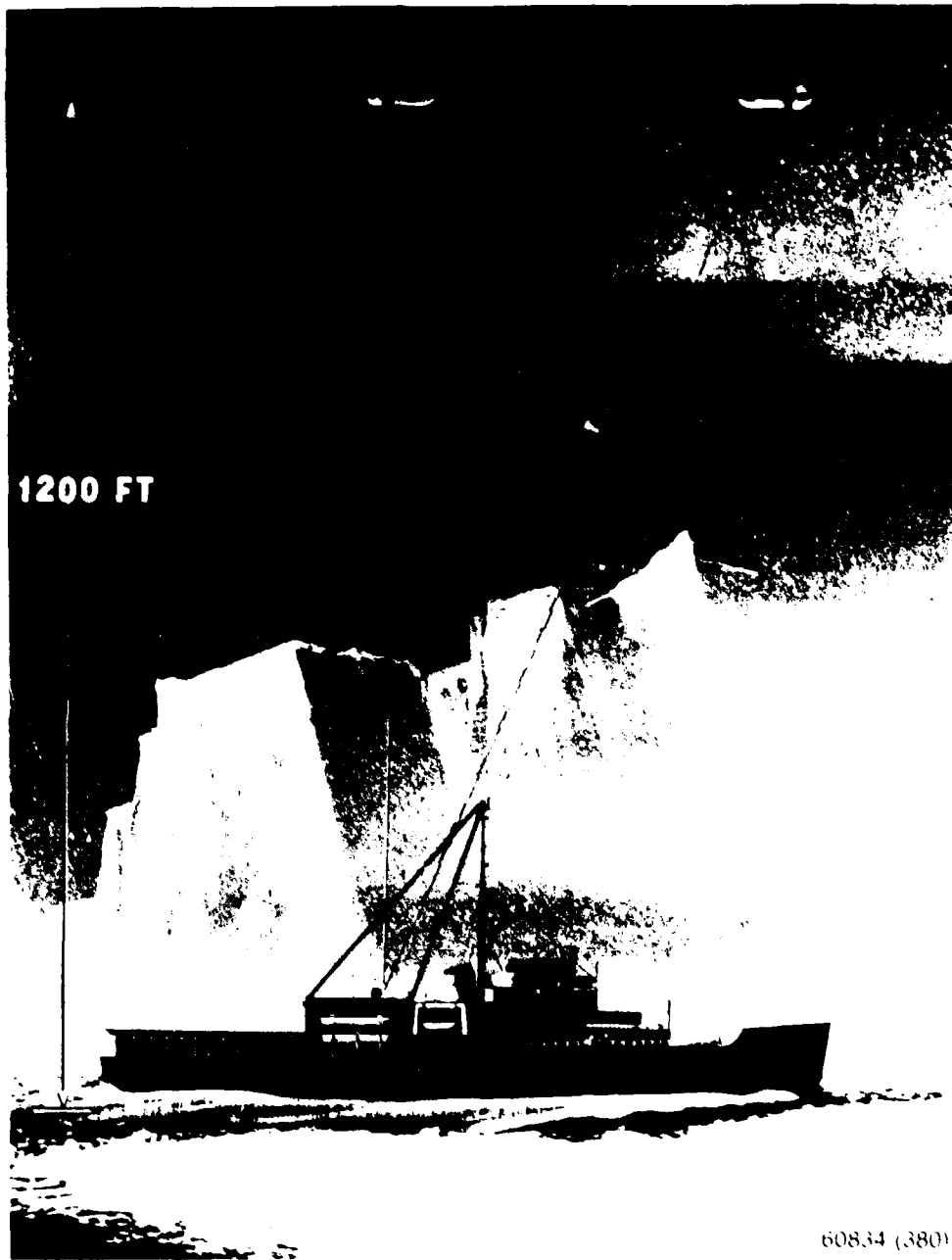

**NRI DEVELOPED SHIPBORNE BALLOON SUPPORTED ANTENNA**

This balloon system was capable of supporting a 1000 foot high antenna for communication at the lower frequencies during high frequency blackouts which occur in arctic areas. It was first used on the USS BURTON ISLAND, 1951.

### Very-Low-Frequency Transmission

The transition from the international Morse code keying transmission system to the automatic teleprinter system came about much later on the very-low-frequency circuits than on those in the high-frequency band. This was primarily due to the extremely low bandwidth characteristic of the huge shore-station antennas at the very-low frequencies, which imposed a limit on the speed of transmission (20 words per minute, continuous-wave, international Morse code keying) to about one-half that required for teleprinter operation at its lowest speed. In overcoming this limitation, NRL devised the first teleprinter system providing effective operation on the very-low frequencies (1951).<sup>278</sup> The performance of this system was demonstrated in operations using transmissions from the Navy's very-low-frequency station at Annapolis, Maryland (NSS, 15.5 kHz) over long-distance circuits to Iceland, England, Panama Canal Zone, and North Africa. This system was self-synchronizing and provided the encoding of a standard teleprinter signal into a four-level signal having one-half the keying rate of the original. The transmitter was shifted through the four frequency levels by the encoded signal which, as modified, could then be accommodated by the bandwidth of the antenna. At the receiver, a decoding device converted the received four-level signal back into its original form for operation of the teleprinter. A novel, stable, regenerative circuit provided a much higher degree of selectivity in the frequency-shift receiver than had previously been attained (25 Hz bandwidth). A specially designed discriminator permitted segregation of the signals on the four frequency levels, which were separated by a very small difference in frequency (4 Hz).

With the advent of the Polaris weapon system, grave concern arose regarding the reliability of command and control communications via the Navy's very-low-frequency transmitting system. In responding to this situation, NRL developed a very-low-frequency facsimile transmission

system which was first to provide reliable command and control communication from a single high-power transmitting station in the United States to continuously submerged submarines when operating in any critical world area (1959). Early in 1959, the submarine USS KATE used the system successfully on its trip to the North Pole. The submarine USS TRITON, in accomplishing the first circumnavigation of the globe, submerged, used the new system throughout the voyage with good results (February-May 1960). The system was installed on all Polaris submarines and provided highly reliable command-control communications during the critical period that followed. This system became known as "Bedrock." The Navy's existing transmitting system had to contend with high atmospheric noise levels prevalent at the very-low frequencies which produced low signal-to-noise ratios and seriously affected the reliability of communications in distant areas of operational importance, such as the Mediterranean Sea. In the system devised, the superior performance obtained under extremely low signal-to-noise-ratio conditions was achieved through the use of very narrow frequency bandwidth transmissions and the redundancy provided by facsimile type signalling. A facsimile-controlled exciter provided the small frequency shifting of the transmitter. The frequency-shift receiver utilized the novel techniques for high selectivity and discrimination previously devised for the very low frequency teleprinter system. Transmitter components were provided for installations at shore stations: NSS, Annapolis, Maryland; NAA, Cutler, Maine; NPM, Lualaba, Hawaii; NPG, Jim Creek, and NBA, Summit, Panama Canal Zone (1958-1964). Receiver components were supplied for submarines, the first installation being made on the USS SABLE FISH (January 1959). In the trials of the system made with this submarine in the Mediterranean Sea area, excellent submerged-reception results were obtained on transmissions from the station at Annapolis, Maryland. Similar results were experienced by the submarine USS BANG at

its station in the North Atlantic off Norway (February 1959).

NRL developed a frequency-shift keyer which for the first time permitted automatic operation of the Navy's very-low-frequency transmitters at a rate as high as 60 words per minute with a high degree of reliability for command-control communications to Polaris submarines (1963).<sup>279</sup> All the Navy's high-power stations were then equipped with these keyers. The system utilized two frequency levels for keying, with provision to avoid the large voltage and current transients previously experienced when the large quantity of oscillatory energy in the antenna system was abruptly changed in frequency. These transients had, at times, caused flashover of "horn-gaps" and other protective devices, followed by objectionable shutdown of transmitters due to overload. In certain instances, critical damage occurred, such as the burnout of antenna loading inductance cable, rendering the station inoperative for a considerable period. The transients were avoided by beginning each successive "mark" and "space" frequency shift at the zero-crossing points of the "mark" and "space" frequencies, when these points were coincident in phase, and by arranging the rate of change of frequency to be linear during the transition process. The transition period was of such length as to hold the sideband energy generated during transition within the frequency bandwidth of the antenna. Maximum utilization of the antenna bandwidth was obtained by very precisely maintaining the "mark" and "space" frequencies; this was possible with NRL-devised techniques. Full utilization of the antenna bandwidth and confinement of the sideband energy to within its limits are major factors in maximizing the rate of transmission. The system permitted changes in the transmitter frequency to be made quickly and easily. Frequency-shift keyers of this type were provided for the Navy's very-low-frequency stations at Cutler, Maine (NAA); Jim Creek, Washington (NPG); Lualualei, Hawaii (NPM); Northwest Cape, Australia (NWC); and Summit, Panama Canal Zone (NBA) (1966).

During 1970, Annapolis, Maryland (NSS) and Yosami, Japan (NDT) were equipped.

#### Communication Between Completely Submerged Submarines

In seeking to secure the advantages of being able to communicate via radio between wholly submerged submarines, the Navy conducted experiments in 1909<sup>288</sup> and 1918.<sup>280</sup> The limited ranges obtained were not of Naval operational interest. More extensive experiments were conducted off Provincetown, Massachusetts in 1920 with the submarines S-4 and S-5 and the tender USS BUSHNELL. With a 300-watt transmitter (975 meters, or 308 kHz) and a "clearing-line" loop antenna, the communication range from the submerged submarines to the tender was limited to 500 yards. From the results obtained, it was concluded that "with these limitations on power and wavelength, transmission from submarine to submarine, submerged, cannot be conducted over any appreciable distance."<sup>281</sup> Although the Navy's interest in the subject matter continued,<sup>282</sup> it was not until later years that the possibilities for such a communication system were thoroughly investigated.

In 1939 the Laboratory began a program to determine the communication range that could be obtained between wholly submerged submarines if higher power and lower radio frequencies, having less attenuation in seawater, were used. Theoretical considerations resulted in system predictions (1940)<sup>283</sup> which were verified by experiments at Fort Pond Bay, Long Island (1946).<sup>284</sup> In the experiments, the field intensity produced by transmissions with 3 kW at 100 kHz into a large, submerged loop (10 x 60 feet) were measured at a 10,000-yard range. From this work it was evident that the high attenuation of the seawater path made imperative the use of the air path between points immediately above submerged submarines if maximum range were to be obtained.

Due to the Navy's particular interest at the time, further experiments were conducted by NRL which for the first time demonstrated the feasibility of satisfactory communication

## RADIO COMMUNICATION

between completely submerged submarines over limited ranges (November 1947).<sup>271</sup> The experiments were conducted off Key West, Florida between the submarines USS MEDREGAL and USS SEA LEOPARD, using both insulated horizontal trailing wire and loop antennas. The USS MEDREGAL, with a 350-foot trailing-wire antenna, was used for transmitting (200 W, 169 kHz). The USS SEA LEOPARD, with a 104-foot trailing-wire antenna, was used for receiving (Model RAK receiver). A planing float attached to the trailing-wire antennas maintained the depth at roughly three-quarters

of a foot. Because of the Navy's special interest at the time, the range was held at 3000 yards, although greater distance could have been covered with the signal level available.

In the experiments, the performance of the trailing-wire antenna was found to be superior to that of the loop antenna. Thereupon, its characteristics, particularly those of input impedance and power dissipation, were treated both theoretically<sup>272</sup> and experimentally (1948-1951).<sup>273</sup> By this time, the use of Naval vessels proved a time-consuming way of obtaining necessary data. To accelerate the data-acquisition



THE FIRST VLF-LF SCALE-MODEL FACILITY

This facility was developed by NRL and was used to determine the performance of undersea radio communication systems (1951). NRL can be seen in the background.

RADIO COMMUNICATION

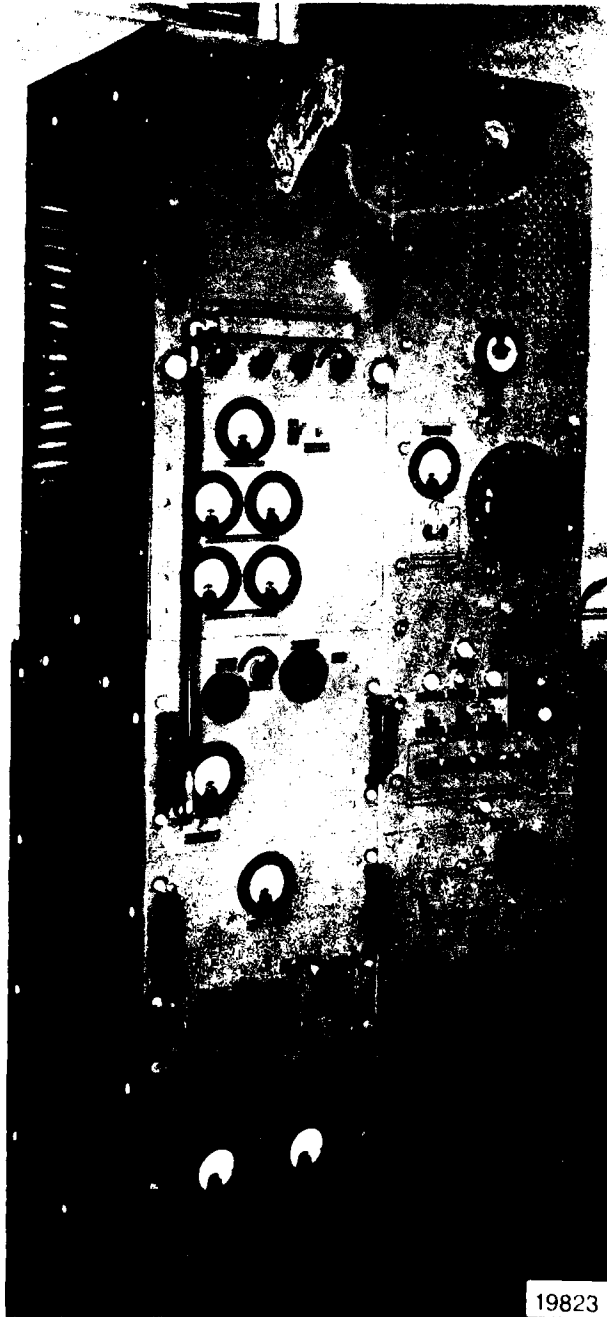

**RADIO TRANSMITTER USED BY NRL  
FOR THE FIRST TRANSMISSIONS  
BETWEEN COMPLETELY SUBMERGED  
SUBMARINES (1953)**

This transmitter operated in the 10 to 100 kHz frequency range and had a 10kW power output. It was constructed by NRL in two individual sections so it could be lowered through a submarine hatch.

19823

process, NRL developed the first VLF-LF scale-model facility for determining the performance of undersea radio-communication systems, locating it immediately to the south of the Laboratory (1951).<sup>274</sup> With this model facility, the characteristics of horizontal trailing-wire antenna systems were determined,<sup>275</sup> including such factors as the optimum ratio of wire diameter to overall cable diameter<sup>276</sup> and field radiation patterns in the air above the simulated sea. This facility comprised a horizontal wire screen, simulating the sea surface, in which were inserted two tanks containing an ammonium chloride solution simulating seawater. The two tanks were spaced a suitable distance apart to represent the air path between two submerged submarines. One tank contained the transmitting horizontal wire antenna under observation. The other tank held the antenna of a field-strength-measuring equipment, representing the receiver of another submarine. The ammonium chloride solution had sufficient concentration to permit scaling the conductivity factor of seawater twelve to one. The correspondingly smaller sizes and depths of antennas facilitated the observations which were made over a simulated frequency range corresponding to 10 to 500 kHz.

With the data obtained from the investigations, a system was assembled with which NRL demonstrated the feasibility of radio communication between two completely submerged submarines out to a range of 30 miles (July 1953). The demonstration was carried out with the submarines USS DOGFISH (transmitting) and USS HARDHEAD (receiving) in Long Island Sound, in the vicinity of New London, Connecticut, using horizontal trailing-wire antennas 100 to 500 feet in length for both installations. For the demonstration, the highest powered radio transmitter (10 kW, 10 to 100 kHz) ever to be installed on a submarine to that time was developed.

The conclusion drawn from the program was that an undersea radio communication system can achieve a range of 30 miles, provided that trailing wire antenna lengths of 200 feet or more

are employed, that the depth of antenna submergence not exceed five feet, and that an antenna power of 10 kW in a frequency band of 30 to 100 kHz is used.

#### Radio Reception by Submerged Submarines

The capability of the very-low frequencies to penetrate the surface of the sea and thus permit reception on board submerged submarines is of great importance today in the transmission of commands to make the nation's undersea nuclear deterrent effective. As early as 1909, the Navy conducted experiments in underwater reception aboard a vessel using an insulated straight-wire antenna submerged to four feet. Signals from the Navy's Norfolk, Virginia shore station were received out to a distance of 15 miles.<sup>286</sup> This range, limited by the insensitive crystal detector receiver then available, was not of interest to the Navy, and the experiments were abandoned. The feasibility of receiving very-low-frequency signals aboard a submerged submarine over long distances was first demonstrated during World War I (1918). Signals (29 to 30 kHz) from high-power European stations were received by a submarine off New London, Connecticut, with the top of its antenna submerged to depths as great as 21 feet.<sup>280</sup> The antenna, of the loop type, consisted of insulated cables connected to the hull at the bow and stern, carried over supports to the bridge, and thence through pressurized hull fittings to the equipment inside. The interest generated in the Navy by the results obtained quickly led to the installation of this loop antenna system on all submarines.<sup>286</sup> The "clearing lines," provided to ward off debris and prevent damage to the submarines in surfacing, were used to support the loop cables, which were spaced from the lines with insulators. Since these clearing-line loops were directive, submarines had to be oriented in the general direction of the station for effective reception. Small pancake loops, in sealed wooden containers, mounted inside the bridge wings were also used. Two such loops, disposed at right angles, provided 360-degree reception. However,



## RADIO COMMUNICATION

the signal strength obtained with these small loops was inadequate, and their structural defects made them unreliable. It was not until radio-frequency amplification of substantial gain became available that small-loop performance became acceptable.

The Laboratory was able to make considerable improvement in the clearing-line loop system through the development of loop cable and cable terminations having superior electrical and mechanical characteristics, both of which provided the reliability that use in the service required (1934).<sup>287</sup> As high frequencies came into general use during the 1930's, with the periscope antenna providing low probability of detection due to low visibility, the practice of submerged reception on the low frequencies and the employment of the clearing-line loop fell into disuse. Interest in submerged reception revived again as the possible involvement of the United States in World War II became apparent. However, the clearing-line loop could no longer be tolerated, since when the submarine surfaced, the probability of detection from aircraft, which had

become a serious threat, was greatly increased. It also was found to obstruct gunfire. The Laboratory was requested to provide a more suitable means of signal collection. **To obtain a better understanding of the communication problem, NRL conducted the first thorough theoretical analysis of the factors involved in submerged radio reception (1939).**<sup>288</sup> The refraction of the radio wave at the air-seawater interface, the propagation of radio waves in seawater, and the effects of the seawater environment upon the characteristics of a loop antenna were studied. The theoretical determination of the variation of the attenuation of radio waves in seawater with respect to frequency was made. Confirmation of results was obtained with respect to effects on loop inductance and losses in a seawater environment through the use of loops immersed in a tank of seawater. Further confirmation was obtained through observations made aboard the submarine USS-S-30 while submerged (1940). The strength of signals from various shore stations and the signal-to-noise ratio received by several types of antennas at

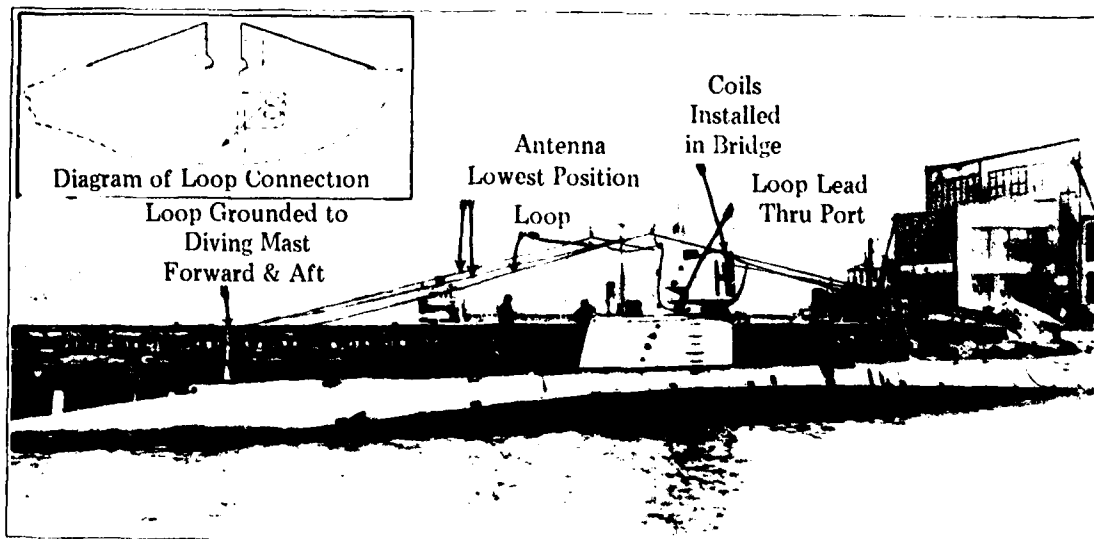

60834 (381)  
"CLEARING-LINE" LOOP ANTENNA USED IN EARLY INSTALLATIONS ON SUBMARINES FOR VLF RECEPTION WHEN SUBMERGED

various depths and for various frequencies were determined. In this work, **NRL was first to obtain experimental data on the attenuation of radio waves propagated through seawater and to determine its variation with frequency (1940).**<sup>289</sup> Observations aboard the submarine were made on transmissions from the Navy's stations at Annapolis, Maryland (NSS, 15.44, 17.8, 32.8 kHz) and Summit, Panama Canal Zone (NBA, 24.0 kHz). The noise created by the ship's electrical system was found to be the limiting factor in depth of reception. A small loop mounted on the deck proved superior to the clearing-line loop in receiving through this noise. It was also observed that radio bearings of good accuracy could be taken on transmitting stations with the small, rotatable loop while submerged, and that these bearings were the same as those taken above the sea's surface. A component of the radio energy in the air medium, in propagating downward into the sea, induces voltages in the horizontal sides of the loop, the resultant of which produces a figure-eight pattern as the loop is rotated. This pattern is similar to that produced when the loop is in the air medium, where the vertical sides are the collectors.

In making the small loop practical for underwater reception, **NRL devised a loop-receiver coupling technique which through proper impedance match provided for the first time maximum utilization of the energy picked up by the loop (1939).**<sup>290</sup> Three hundred fifty of these couplers were furnished, so that the system would be made available to the Navy's submarines. The system continued in service throughout World War II. The resulting 60-dB system gain gave the small loop an underwater reception capability superior to that of the large clearing-line loop as previously used without the new coupling technique (14 to 38 kHz). The coupling was accomplished with a special impedance transformer, the low-loss, very tightly coupled primary and secondary windings of which were mounted on a molybdenum permalloy dust core. With it the im-

pedance of the loop (Model DQ) was matched directly to the grid circuit of the first amplifier tube of the receiver (Model RAK). The loop could be rotated and advantage taken of its directional properties in avoiding interfering stations and in taking bearings. Observations aboard the submarine **USS SEA LION** at Pearl Harbor proved the system capable of providing satisfactory signals from the Navy's transmitter at Annapolis, Maryland (NSS) when the top of the loop was submerged 15 feet.

After World War II, the Navy's objective of higher submerged speeds for its submarines forced attention to streamlining the hull and its appurtenances. An antenna, much smaller than the existing air-core loops, in the form of a fixed structure which could be streamlined was needed. Omnidirectional performance was imperative to make certain the prompt reception of commands directed to submarine commanders, which might be missed with the use of a directional loop in "minimum" position. **NRL conducted a further study of the factors entering into the performance of undersea loop antennas of various types and concluded that a ferrite-core loop could provide a reception capability equal to air-core loops of nearly four times the area. Furthermore, NRL conceived a loop antenna system which for the first time provided omnidirectional undersea reception performance (1948).**<sup>290,291</sup> This system, with some modification, was widely accepted in the Fleet. The system comprised a ferrite core with two loop windings disposed physically at right angles and connected to a circuit which displaced the phase of the voltage of one loop winding 90 degrees with respect to the phase of the other. Combining these two voltages provided the omnidirectional reception characteristic. Provision was made for the use of each loop winding separately, should directional discrimination against an interfering signal be required. This loop antenna system, designated the **AT-317**, was installed on all submarines. It was mounted at the top of a retractable mast which extended to a considerable

RADIO COMMUNICATION

75596 (1)

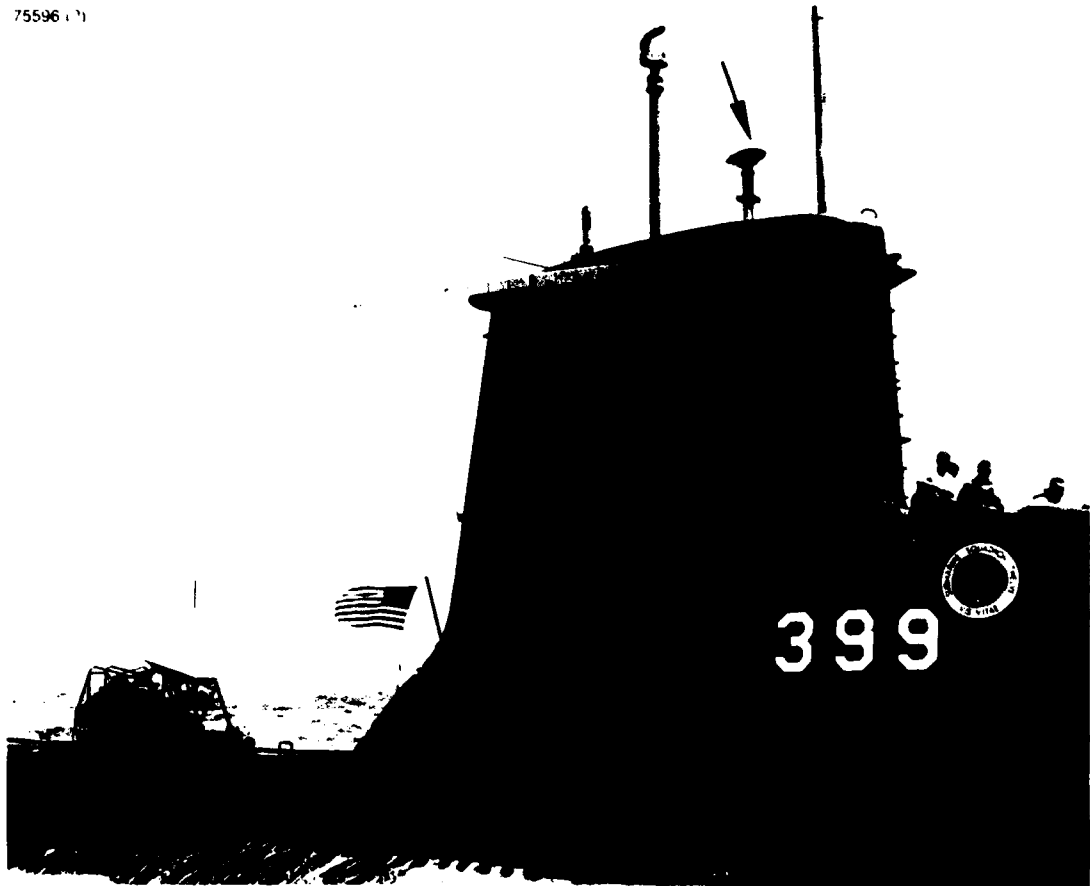

VLF LOOP ANTENNA INSTALLATION ABOARD SUBMARINE USS SEACAT

The NRL developed (1948) omnidirectional loop antenna is mounted on the mast to be seen second from right on top of the sail (see arrow). On deck at left is NRL's dynamic-lift buoy, also equipped with this type VLF loop.

## RADIO COMMUNICATION

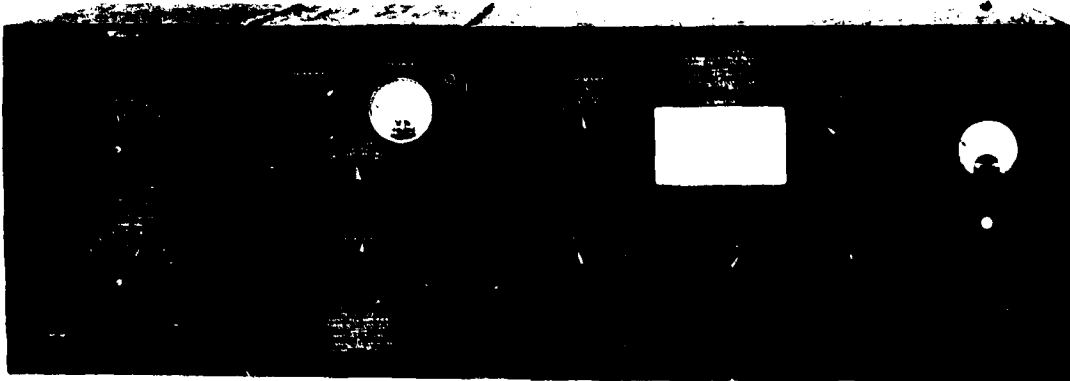

75372

### LOWER FREQUENCY RADIO RECEIVERS WITH MULTIPLEXING CAPABILITY

The first lower frequency radio receivers capable of multiplexing on a common antenna were developed by NRL, these were the Models RE and RF (1924). The Model RF is shown here.

height above the sail to permit reception at greater submarine depth.

While, prior to 1959, the immediate environmental aspects of reception of the very-low frequencies on a submerged submarine had been studied, no thorough analysis of the communication system as a whole had been made. Determinations of received signal level based upon the characteristics of all elements of the system could not be made with sufficient accuracy to satisfy the Navy's need. As a result of its efforts, NRL was first to develop a mathematical expression relating all of the various major parameters of a very-low-frequency communication system, which permitted reliable determination of the signal level received aboard a submerged submarine (1959). The results of this

work had considerable impact and brought about various improvements in Fleet systems. Taken into account were such factors as radiated power, propagation-attenuation loss, air-sea interface loss, depth-of-submergence loss, and loop-antenna collection capability in a seawater environment. The variations of these factors as functions of transmission frequency, seawater conductivity, and loop-antenna configuration were considered.

#### Lower Frequency Radio Receivers

At the time of the Laboratory's activation in 1923, the Navy had planned to provide its ships with multiplex reception facilities to minimize the number of antennas. In furtherance of this plan, NRL developed the first lower frequency

## RADIO COMMUNICATION

radio receivers which could be multiplexed on a common antenna (Models RE, 10 to 100 kHz, and RF, 75 to 1,000 kHz) (1924).<sup>292</sup> Hundreds of these receivers were procured and used universally throughout the Navy and by other government departments. They were installed on all classes of ships and continued in use through World War II. This was accomplished by using the multiplexing "coupling-tube" technique previously described, which permitted a large number of both lower and high frequency receivers to be used on a single antenna. The new lower frequency receivers possessed selectivity and shielding superior to previous receivers in this frequency range. They were of coordinated design, the radio and audio frequency amplifiers being part of an integral assembly instead of separate units connected to a tuner, as in earlier receivers. Certain units of common design were interchangeable.

The Navy required submarines to have a reception capability which included the very-low-frequency band through the high-frequency band. Three existing receivers would have been required to provide such coverage, but space limitations on submarines prevented their use. To contend with the space-limitation problem, NRL developed a "universal receiver" for submarines which was the first to encompass the wide frequency range from very-low frequencies through the high-frequency band in one compact unit (Model RO, 15 kHz to 25,000 kHz) (1928).<sup>298</sup> The Model RO receiver was installed on many submarines beginning in 1929. Its active service extended through World War II. It occupied only one-third the space of the three-receiver combination.

In 1931, the Japanese deliberately interfered with the Navy's very-low-frequency radio-communication circuits in the Pacific area. NRL was called upon to devise means of avoiding this interference. In accomplishing this, the Laboratory provided a "barrage" receiving system

using unilateral sense discrimination and sharp frequency selectivity to avoid the interference.<sup>294</sup> As one element of this system, NRL developed the first Navy receiver to be capable of operation on an alternating-current power supply (Model RAC, 12 to 80 kHz) (1931). All previous receivers had been designed for use on batteries, which required frequent attention and replacement. The Model RAC receiver, of the tuned-radio-frequency type, proved far superior in selectivity and general performance to existing receivers. It was included in the "barrage" receiving system provided to the various Navy radio stations handling communication traffic on the very-low frequencies in the Pacific area.

NRL's work on the Model RAC receiver resulted in new techniques, particularly with respect to operation on an alternating-current power supply, which greatly facilitated the development of a subsequent series of receivers, both low and high frequency, including the Models RAA, 10 to 1000 kHz (1936), RAK, 15 to 600 kHz (1939), RAL, 300 to 23,000 kHz (1939), and RBA, 15 to 600 kHz (1941).<sup>282,296</sup> These receivers were NRL concepts. They included the NRL multiplexing technique and circuitry, and the shielding needed to prevent radiation of local-oscillator energy which could cause detection by an enemy through interception. The Model RAA possessed exceptional selectivity, not exceeded for many years. It was the first receiver to use single-dial tuning. However, the great bulk and weight of this receiver made it unsuitable for installation on the smaller ships, which used the Models RAK and RAL. The Model RBA provided a substantial advance by way of greater stability and simplicity in operation, greater gain over the frequency range, improved output limiting, and lighter weight. These receivers were produced in large numbers and were used for general service through World War II and for many years thereafter.

An effort was made to obtain a "miniaturized" receiver with modular construction for the lower

## RADIO COMMUNICATION

frequencies; however, considerable difficulty was encountered in securing adequate performance due to the major reductions in size of components. NRL provided guidance of the contractor (RCA) in overcoming these difficulties (1950).<sup>296</sup> This receiver (Model AN/SRR-11, 14 to 600 kHz) was obtained in quite large numbers for general use.

In providing a lower frequency receiver to meet the special requirements for submarines, it was of importance that it be designed to give optimum performance with NRL's omnidirectional ferrite loop antenna for submerged reception. The Laboratory provided the manufacturer of the receiver with technical information and assistance necessary to secure satisfactory operation in service. In addition to the special cross-loop coupling circuitry, noise-cancelling means and provision for operation with various conventional types of antennas were included in the receiver. This receiver, the Model BRR-3 (1959), was widely used because of its superior performance in this type of operational role.

### REFERENCES

1. "Intra Fleet Equipment," NRSR, Apr. 1922, pp. 38-42
2. Bureau of Engineering letter to Commander-in-Chief, U.S. Fleet, 27 Mar. 1924; reproduced in NRSR, May 1924, pp. 3-12
3. Commander-in-Chief, U.S. Fleet, letter to Bureau of Engineering, 2 June 1924; reproduced in NRSR, Aug. 1924, pp. 3-9
4. Bureau of Engineering letter to Commander-in-Chief, U.S. Fleet, 3 July 1924; reproduced in NRSR, Aug. 1924, pp. 10-21
5. A. Hoyt Taylor, "Report of Progress on Reception and Transmission at High Frequencies," NRSR May 1924, pp. 92-98 June 1924, pp. 43-48 Oct., Nov. 1924, pp. 29-37
6. A. Hoyt Taylor, "Transmission Experiments at High Frequencies," NRSR, June 1924, pp. 37-41
7. A. Hoyt Taylor, "High-Frequency Investigations," 21 Apr. 1925; NRSR, April, May, June 1925
  - a. pp. 64-68
  - b. p. 68
8. A. Hoyt Taylor and E.O. Hulburt, "Theory of Propagation of Short Radio Waves over Long Distances," 25 June 1925; NRSR, July, Aug. 1925, pp. 23-25; also Science, 21 Aug. 1925
9. A. Hoyt Taylor and E.O. Hulburt, "Wave Propagation Phenomena at High Frequencies," NRSR, Sept. 1925, pp. 42-59
10. A. Hoyt Taylor, "An Investigation of Transmission on the Higher Radio Frequencies," IRE, Dec. 1925
  - a. pp. 677-683
  - b. p. 682
11. A. Hoyt Taylor and E.O. Hulburt, "The Propagation of Radio Waves over the Earth," Phys. Rev. Feb. 1926
  - a. pp. 189-215
  - b. pp. 193-194
  - c. 215
12. A. Hoyt Taylor, "Radio Communication with Short Waves," The Scientific Monthly, Apr. 1926, pp. 356-359
13. E.O. Hulburt, "The Kennelly-Heaviside Layer and Radio Wave Propagation," J. Franklin Inst., May 1926, pp. 597-634
14. A. Hoyt Taylor, "Relation Between The Height of the Kennelly-Heaviside Layer and High Frequency Radio Transmission Phenomena," IRE, Aug. 1926
  - a. pp. 521-540
  - b. pp. 528-539
15. E.O. Hulburt, "The Absorption of Radio Waves in the Upper Atmosphere," Phys. Rev., May 1927, pp. 706-716
16. A. Hoyt Taylor, "Variations in High-Frequency Ground Wave Ranges," IRE, Aug. 1927, pp. 707-708
17. G. Breit and M.A. Tuve, "A Test of the Existence of the Conducting Layer," Phys. Rev. Sept. 1926, pp. 554-575
18. O. Dahl and L.A. Gebhard, "Measurements of the Effective Heights of the Conducting Layer and the Disturbances of August 19, 1927," IRE, Mar. 1928, pp. 290-296
19. G. Breit, M.A. Tuve, and O. Dahl, "Effective Heights of the Kennelly-Heaviside Layer in December 1927, and January 1928," IRE, Sept. 1928, pp. 1236-1239
20. L.R. Hafsted and M.A. Tuve, "Further Studies of the Kennelly-Heaviside Layer by the Echo Method," IRE, Sept. 1929, pp. 1513-1522
21. E.O. Hulburt, "On Round-The-World Signals," IRE, Mar. 1928, pp. 287-289
22. A. Hoyt Taylor and L.C. Young, "Studies of High-Frequency Radio Wave Propagation," IRE, May 1928, pp. 561-578
23. A. Hoyt Taylor and L.C. Young, "Studies of Echo Signals," IRE, Sept. 1929, pp. 1491-1507
24. "Report of Shenandoah Flight," NRSR, Dec. 1924, pp. 38-55
25. A. Hoyt Taylor, "High-Frequency Studies—Progress Report," 16 Jan. 1925, NRSR, Mar. 1925, pp. 42-48
26. "Report on Fleet Exercises," Commander-in-Chief, U.S. Fleet letter to Navy Department, 14 Mar. 1923
27. Letter from Commander-in-Chief, U.S. Fleet (ADM R.E. Coontz) to Chief of Naval Operations, 16 Sept. 1925; NRSR, Feb. 1926
  - a. pp. 1-5
  - b. p. 4
28. Bureau of Engineering to Chief of Naval Operations First Endorsement, 5 Nov. 1925, of Commander-in-Chief, U.S. Fleet, letter of 16 Sept. 1925; NRSR, Feb. 1926, pp. 5-8
29. "Radio Telegraph Allocation of Frequencies," Bureau of Engineering letter to Chief of Naval Operations, 8 Mar. 1926; NRSR, Mar., Apr. 1926, pp. 5-31
30. S.C. Hooper, "Considerations Affecting the Licensing of High-Frequency Stations," IRE, Sept. 1928, pp. 1240-1251
31. "International Radiotelegraph Conference and General and Supplementary Regulations thereto," Government Printing Office, Washington, D.C., 1937
32. "High-Frequency Transmitters, Modified CW-936 Set," NRSR, Dec. 1925, Jan., Feb. 1926, p.22
33. "Constant Frequency Transmitting Circuits," NRL letter to Bureau of Engineering, 24 Aug. 1923; NRSR, Nov. 1923, pp. 26-30

## RADIO COMMUNICATION

34. "Variometer for Transmitters," NRL letter to Bureau of Engineering, 23 Aug. 1923; NRSR, Nov. 1923, pp. 43-45
35. "Intrafleet transmitter—Type 7(TV)," NRSR  
May 1924, pp. 10-92  
Oct., Nov. 1924, p. 5  
Dec. 1924, p. 3  
Apr., May, June 1925, p. 66
36. "Intrafleet Transmitter—Type 7(TV)," Bureau of Engineering, NRSR  
Project V-5E-26  
July, Aug. 1925, p. 8  
Oct., Nov. 1925, p. 32  
July, Aug., Sept. 1926, p. 29  
Project V-5E-27  
Feb., Mar., Apr. 1927, p. 2  
July, Aug. 1927, pp. 26-29  
Nov., Dec. 1927, Jan. 1928, p. 28
37. "Naval Radio Equipment," NRSR, July-Dec. 1931, p. 97
38. A. Hoyt Taylor, "Transmission Experiments at High Frequencies," NRSR  
May 1924, p. 98  
June 1924, p. 46
39. A. Hoyt Taylor, "Status of Quartz Crystal Oscillators in the United States Navy," 10 Feb. 1925, NRSR, Mar. 1925, pp. 53, 54
40. J.M. Miller, "Quartz Crystal Oscillators," NRSR, Apr., May, June 1925, pp. 53-64  
a. pp. 53-64      b. pp. 53, 62, 63
41. L.P. Wheeler, "An Analysis of a Piezo-Electric Oscillator Circuit," IRE, Apr. 1931, pp. 627-646
42. J.M. Miller, "Piezo-Electric Oscillation Generator," Patent 1,756,000, filed 10 Sept. 1925
43. A. Crossley, "Piezo Electric Crystal-Controlled Transmitters," IRE, Jan. 1927  
a. pp. 18, 19  
b. pp. 24-26  
c. pp. 25, 26  
d. pp. 27, 28  
e. p. 33  
f. pp. 33-35
44. "Crystal Temperature Control"  
A. Crossley, Patents 1,791,804, 1,884,585  
L.A. Gebhard, Patents 1,862,929, 1,893,666, 1,991,276
45. A. Crossley, "Modes of Vibration in Piezo Electric Crystals," IRE, Apr. 1928, pp. 416-423
46. L.H. Dawson, "Piezo-Electricity of Crystal Quartz," Phys. Rev., Apr. 1927, pp. 532-541; also see L.H. Dawson, Patent 1,866,454
47. L.H. Dawson, "Determination of the Optic Axis of Large Crystal Quartz," J. Opt. Soc. Am., Oct. 1926, pp. 517-554
48. NRSR, Oct., Nov. 1925, p. 54
49. "Development and Adaptation of the Tube Counter to the X-ray Diffraction Methods Used in Production of Quality Plates," citation in presenting the Navy Distinguished Civilian Service Award to H. Friedman, 19 Oct. 1944; NRL Civilian Personnel Office
50. J.M. Miller and L.A. Gebhard, "System for the Amplification of Alternating Currents," Patent 1,955,341, filed 2 Oct. 1925
51. NRSR, Mar. 1925, pp. 42-48
52. J.M. Clayton, "Navy Developments in Crystal-Controlled Transmitters," QST, Nov. 1925, pp. 41-44
53. R.B. Meyer, "Vacuum Tube Transmitter Employing Quartz Crystal Control, Balancing Between Stages and Frequency Doubling," 21 Sept. 1925, NRSR, Oct., Nov. 1925, pp. 60-67
54. E.L. White, "Analysis of the Phenomena of Frequency Doubling as Used in Tube Transmitters," NRSR, Dec. 1925, Jan., Feb. 1926, pp. 40-42
55. R.M. Page, "An Investigation of the Phenomena of Frequency-Multiplication as Used in Tube Transmitters," IRE, Sept. 1929, pp. 1649-1655
56. "Radio Problem—No. 10," NRSR, Oct., Nov. 1925, p. 58
57. "Arlington High Frequency Transmitter Project," NRSR, Dec. 1925, Jan., Feb. 1926, pp. 32-34
58. "Type 8S Set," NRSR, July, Aug., Sept. 1926, p. 32
59. "Cornet Set for Arlington," NRL Problem No. 38, NRSR, Nov., Dec. 1927, Jan. 1928, pp. 26, 42
60. "High-Frequency Transmitters for Shore Stations Using Frequencies in Excess of 4,000 kHz," NRSR, May, June 1926, pp. 40-43
61. "Construction and Operation of 5 kW H.F. Transmitter for Navy Yard, Mare Island," NRL, NRSR, Sept., Oct. 1927, pp. 24-44
62. "Four 5 kW, 4000-18, 100 kHz Transmitters," NRL Problem No. 33, NRSR, Nov., Dec. 1927, Jan. 1928, pp. 21, 38
63. Bureau of Engineering Project V-10E-26; NRSR  
Oct., Nov. 1925, p. 33  
Mar., Apr. 1926, p. 61  
Bureau of Engineering Project V-8E-27; NRSR  
Feb., Mar., Apr. 1927, pp. 2, 5-10  
May, June 1926, p. 10  
July, Aug. 1927, pp. 20-21  
Sept., Oct. 1927, pp. 4-6
64. A. Hoyt Taylor, "High Frequency Tests—USS MEMPHIS and USS PITTSBURGH," 14 Aug. 1926; NRSR, July, Aug., Sept. 1926, pp. 44-60
65. Letter from Commanding Officer, USS MEMPHIS to Bureau of Engineering, 5 Aug. 1926; copy in NRL File S67/52G, "Transmitters—Model XA" (1926-1928); NRL CRMO
66. Letters from Commandant, U.S. Coast Guard, 21 July 1926 and 10 Aug. 1926, forwarding report of Communications with International Ice Patrol; copy in NRL File S67/52G, "Transmitters—Model XA" (1926-1928); NRL CRMO
67. NRSR  
Apr., May, June 1925, p. 51  
Dec. 1925, Jan., Feb. 1926, pp. 42-58
68. NRSR, Oct., Nov. 1926, pp. 36-38
69. "5 kW High Frequency Transmitters for the CALIFORNIA and TEXAS," NRSR, Oct., Nov., Dec. 1929, pp. 38-39
70. "Bureau of Engineering Problem No. 21, NRL No. 32, Submarine Transmitters, 2000-18,100 kHz," NRSR, Nov., Dec. 1927, Jan. 1928, pp. 25, 36
71. A.M. Trogner, "Model XE Transmitter," NRSR, July, Aug., Sept. 1928, pp. 13-22
72. A.W. Hull and N.H. Williams, "Characteristics of Shielded-Grid Plotrons," Phys. Rev., Apr. 1926, pp. 432-438
73. Commander Submarine Division, Battle Fleet letter to Navy Department, 27 July 1928; Second Endorsement by Commander-in-Chief, U.S. Fleet, 10 Aug. 1928; copy in NRL File S67/52(J), Model XE—1926-1929; NRL CRMO
74. "Skip Distance and High Frequency Ranges Over Sea Water," NRSR, Oct., Nov., Dec. 1929, pp. 16-27
75. "Submarine Radio Equipment, Model TAR," Project V-7E-30, NRSR, July, Aug., Sept. 1929, pp. 46-47
76. NRSR, July-Dec. 1930, pp. 33-35
77. "Radio Transmitter Class 7," Radio Problem No. R171, NRL letter reports S67/71 (4471) of 14 Sept. 1931, S67/71 (4497) of 13 Oct. 1931, S67/71 (4512) of 30 Oct. 1931, S67/71 (4672) of 16 Apr. 1932, S67/71 (4967) of 6 June 1933; see NRL File

RADIO COMMUNICATION

- S67/52, "Radio Transmitters," 1931, File No. 6, National Archives; NRL CRMO
78. J.B. Dow, "A Recent Development in Vacuum Tube Oscillator Circuits," IRE, Dec. 1931, pp. 2095-2108
79. "TBF," Bulletin of Engineering Information No. 90, Jan. 1, 1934, pp. 52-61; Navy Department, Naval Ships System Command Technical Library
80. A. Hoyt Taylor, "The Trend of HF, High Power Transmitter Design," NRSR, July, Aug., Sept. 1928, pp. 23-32
81. NRSR, July-Dec. 1931, pp. 98-99
82. "Nomenclature Assigned to Naval Electronic Equipment," Nav Ships 900.123 (D), Handbook 7210, copy in NRL Document Room  
 a. pp. 741-750  
 b. pp. 669-690
83. O.C. Dresser, "Test of TBA 1A Transmitter Including Comparative Tests of TBA Transmitter," NRL Report 1002, Oct. 1933  
 •R.B. Meyer and O.C. Dresser, "Tests of Model TBF Transmitting Equipment, Serial Nos. 32, 34, 35," NRL Report 1040, Mar. 1934  
 •R.B. Meyer, "Test of the Model TBG Transmitting Equipment," NRL Report 1054, May 1934  
 •R.B. Meyer, O.C. Dresser, "Test of Model TBK Transmitting Equipment (Preliminary Model)," NRL Report 1087, Oct. 1934  
 •O.C. Dresser, R.B. Meyer, "Test of Model TBL Transmitting Equipment," NRL Report 1116, Jan. 1935  
 •R.B. Meyer, "Test of Model TBN 2 Radio Transmitting Equipment, submitted by Westinghouse Electric and Mfg. Co.," NRL Report 1186, Aug. 1935  
 •H.R. Johannessen, F.C. Kahler, and J.D. Wallace, "Modulator Unit for Model TBM 5 Transmitter as Used with Model TBK 9 Transmitter, submitted by Westinghouse," NRL Report 1648, Sept. 1940  
 •C.W. Christenson, J.D. Wallace, "Test of Collins Type 18M 5 Radio Equipment (Transmitter Portion) Navy Model TCH Equipment," NRL Report 1664, Oct. 1940  
 •E.M. Kavanaugh, M.L. Leppert, and C.B. Davis, "Test of Model TCS Transmitting Equipment, submitted by Collins Radio Corp.," NRL Report 1866, May 1942  
 •E.M. Kavanaugh, F.D. Hobart, and C.B. Davis, "Test of Model TDE Radio Transmitting Equipment, submitted by Westinghouse Electric & Mfg. Co.," NRL Report 1907, July 1942  
 •W.J. Rosch and M.L. Leppert, "Test of Model XTCK Radio Transmitting Equipment," NRL Report 2007, Mar. 1943  
 •"TBF Transmitter, Test of Preliminary Test Model," RE 171, 1 Nov. 1932; see NRL File S67/52, National Archives, NRL CRMO
84. NRSR  
 Oct., Nov., 1924, pp. 24-26  
 Mar. 1925, p. 46  
 Apr., May, June 1925, pp. 42-47
85. "Receivers Experimental HF, 1924-1926," NRL File S67/46 (D), NRL CRMO
86. "Model RG Receiver," NRSR  
 Project V 6E 26  
 July, Aug., 1925, p. 8  
 Oct., Nov. 1925, p. 32  
 Project V 6E 27  
 Feb., Mar., Apr. 1927, p. 2  
 Jan. 1933, pp. 168-170
87. E.H. Armstrong, "The Super Heterodyne Its Origin, Development and Some Recent Improvements," IRE, Oct. 1924, pp. 539-552
88. NRSR  
 Oct., Nov. 1924, p. 6  
 Dec. 1924, pp. 29-31
89. A. Hoyt Taylor, "Receivers," NRSR, Dec. 1926, Jan. 1927, pp. 51-52
90. A. Hoyt Taylor, "High Frequency Transmission and Reception," NRSR, Jan. June 1931, pp. 28-29
91. "Receivers Superheterodyne Model RE RG," 1924-1928, NRL File S67/46(E), NRL CRMO
92. "Receivers," NRSR  
 July-Dec. 1931, pp. 2-4  
 Dec. Jan. 1927, pp. 46-57
93. "A New Series of Standard Radio Receiving Equipments," NRSR, July 1941, pp. 23-29
94. J.H. Gough, "Test of Models RAA and RAB Receiving Equipments (Audio System)," NRL Report 1027, Feb. 1934  
 •W.B. Burgess, "Tests of Model RAA and RAB Receiving Equipment (RF and IF Amplifier and Detector Circuits of the Model RAB)," NRL Report 1030, Mar. 1934
95. E. Toth, F.C. Isely, and G.H. Burbage, "Test of Model XRBB and XRBC Radio Receiving Equipments," NRL Report 2479, Apr. 1945
96. "Summary of Piezo Electric Crystal Conference held by U.S. Navy Department, Dec. 3-4, 1929," IRE, Dec. 1930, pp. 2128-2135
97. "Temperature Controlled Test Room," NRL File S67/NR 14, Mar. Nov. 1938, NRL CRMO
98. J.C. Link and R.B. Meyer, "Test of Model TAJ 4 Transmitting Equipment," NRL Report 1068, Sept. 1934  
 •R.B. Meyer, and O.C. Dresser, "Test of Model TBF 1 Transmitting Equipment," NRL Report 1069, Sept. 1934  
 •R.B. Meyer and O.C. Dresser, "Test of Model TBK Transmitting Equipment (Preliminary Model)," NRL Report 1087, Oct. 1934  
 •O.C. Dresser, "Test of the Models TBA 1A Transmitting Equipment," NRL Report 1094, Nov. 1934  
 •J.C. Link, and R.B. Meyer, "Test of Model TAQ 4 Transmitting Equipment," NRL Report 1130, Mar. 1935  
 •R.B. Meyer, "Test of Model TBN 2 Radio Transmitting Equipment, submitted by Westinghouse Electric and Mfg. Co.," NRL Report 1186, Aug. 1935
99. J.B. Dow, "The Navy's Electronics Program and Some of its Past, Present and Future Problems," IRE, May 1945, pp. 291-299
100. NRSR  
 Oct., Nov. 1924, pp. 24-26  
 Apr., May, June 1925, pp. 42-47
101. "Aviation Radio," NRSR, July, Aug. 1927, pp. 1-15
102. A.H. Taylor, "H.F. Reception in Flight Without Ignition Disturbance," NRSR, July, Aug. 1925, pp. 20-23
103. "Aircraft Radio Study of Ignition Disturbances," NRSR, May, June 1927, pp. 13-37
104. NRL letter to Secretary of the Navy, 10 Oct. 1928, forwarding NRL achievements for 1928, for inclusion in the Secretary's annual report
105. Letter from Commander Aircraft, Scouting Force to Chief of the Bureau of Engineering A6-2 (3708), 9 Dec. 1931; reproduced in NRSR, July-Dec. 1931, pp. 27-32
106. NRSR, Problem Type 6R, July, Aug., Sept. 1926, pp. 40-41
107. NRSR, July, Dec. 1931, p. 96
108. M.H. Schrenk, "Tests of Preliminary Models GF-1 and RU-3 Aircraft Radio Equipment," NRL Report 1067 Sept. 1934  
 •"Fifty Years of Naval Avionics," Naval Aviation Electronics Digest, Aug. 1961, pp. 25, 26



RADIO COMMUNICATION

- Bureau of Aeronautics Material Division Report, Oct. Dec. 1932, p. 33
- 109 NRSR, Oct. 1922, pp. 28-29
- 110 NRSR, Problem 95 A, Apr. 1923, pp. 29-30
- 111 NRI letters to Bureau of Ships, NRI File S6752 (380), 11 July 1944, 22 July 1944, 2 Sept. 1944, 8 Nov. 1944, 25 Sept. 1945, Bureau of Ships letter to NRI 2318 (92SD), 27 Jan. 1945, Problem S1046R, NRI CRMO
- 112 C.W. Harrison, Jr. and J.E. Blower, "Electronics - Your Future," *Am. Soc. Naval Engineers*, Feb. 1950, pp. 99-137
- 113 G.B. Gibson, "Optimum Parameters for FSK Radio Teleprinter Systems in the Presence of Thermal Noise," NRI Report 3861, Sept. 1951
  - "History of Bureau of Ships During World War II," Naval Ships Systems Command Technical Library, VM 23 Un. 3, Vol. IV, p. 271
  - F.C. Kahler and G.B. Gibson, "Automatic Printing Systems," *Report of NRI Progress*, Apr. 1951, pp. 34, 35
  - G.B. Gibson, "Automatic Printing System," *Report of NRI Progress*, Aug. 1951, p. 32
  - F.C. Kahler and J.E. Martin, "Automatic Printing System," *Report of NRI Progress*, July 1952, p. 44
- 114 NRSR, May 1923, pp. 21-22
- 115 C.F. Jenkins, "Vision by Radio: Radio Photographs, Radio Photograms," National Capitol Press, Washington, D.C., 1928, Library of Congress EK660014
- 116 C.F. Jenkins, "Radio Vision," *IRE*, Nov. 1927, pp. 988-964
- 117 C.F. Jenkins, "Radio Movies, Radiovision, Television," National Capitol Press, Washington, D.C., 1929, Library of Congress TK663014
- 118 C.F. Jenkins, "The Drum Scanner in Radiomovies Receiver," *IRE*, Sept. 1929, pp. 1576-1583
- 119 "TV for Deep Sea Divers," *Popular Mechanics*, Sept. 1950, p. 79
- 120 D.H. Brunk and P.H. Haskins, "The Telescope Periscope Buoy," NRI Memo Rept 204, Nov. 1953
- 121 NRI Report of NRI Problem S0119, Sept. 1963, pp. 42, 43
- 122 NRI letter to BuShips, 5410 SOS HDX'dm, Ser. 01013, 16 Sept. 1964
  - H.H. Cabbage, NRI Technical Memorandum enclosure to NRI letter 5410 487A TPC'lb, 9 Sept. 1965, NRI Problem R0115, 21 Sept. 1965, NRI CRMO
- 123 B. Fisk, C.I. Spencer, "Frequency Shift Transmission of SPR Signals Over Local and Transoceanic Communication Links," NRI Report 3178, Sept. 1947
- 124 B. Fisk and C.I. Spencer, NRI Report 3512, Aug. 1949
- 125 B. Fisk and C.I. Spencer, "Synthesizer Stabilized Single Sideband System," *IRE*, Dec. 1956, pp. 1680-1685
- 126 C.I. Spencer, "Suitability Investigation of Bureau of Ships SSR Equipment," NRI Memo Rept 744, Sept. 1957
  - B. Fisk and C.I. Spencer, "SSB," *Signal*, Apr. 1960, pp. 72-74
  - B. Fisk and C.I. Spencer, "Frequency Stabilization of Point to Point SSB Circuits Advantageous," *Signal*, Apr. 1960, pp. 72, 73, 75
- 127 B. Fisk, C.I. Spencer, "A System Using Phase Modulation Transmission and Single Sideband Reception for Long Range Communication, Part I: Phase Modulator," NRI Report 3884, Oct. 1951
  - B. Fisk, C.I. Spencer, "A System Using Phase Modulation Transmission and Single Sideband Reception for Long Range Communication, Part II: Single Sideband Receiver," NRI Report 4007, July 1952
- 128 B. Fisk, "Terminal Systems," *Report of NRI Progress*, Jan. 1951, p. 7
- 129 H.M. Beck, "Time Dependent Probabilities," NRI Report 3915, Dec. 1951
- 130 H.M. Beck, M. Fischman, "The ASTRE - An Electronic Real Time Statistical Analyzer," NRI Report 4981, Aug. 1957
- 131 C.D. Heffner, "Analysis of Mark III Call Sign Cipher Machine," NRI Memo Rept 260, Feb. 1954
  - H.M. Beck, A.B. Cooke, and G.J. Hilwig, "Switching Systems," *Report of NRI Progress*, July 1961, pp. 35-38
- 132 Military Specifications, Cable, electrical, shielded pairs, MIL C 23437C (Ships), 6 June 1967
- 133 A.W. Walters, L.C. Huffman, "Experimental Determined Characteristics of Cylindrical Sleeve Antennas," NRI Report 3354, Sept. 1948
- 134 A.W. Walters, L.C. Huffman, "Vertical Patterns of Cylindrical Sleeve Antennas," NRI Report 3411, Feb. 1949
- 135 A.W. Walters, "Sleeve Antenna Considerations for Task Fleet Flagship (CLC 1)," NRI Report 3494, July 1949
  - M.I. Musselman, E.H. Flath, Jr., "Coupling Between High Frequency Sleeve Antennas for Task Fleet Flagship CLC 1," NRI Report 4061, Oct. 1952
  - T.J. Rauen, R.F. Schmidt, and M.I. Musselman, "Sleeve Antenna Radiation Patterns for the USS Northampton," NRI Report 4297, Jan. 1954
  - R. Fulper, Jr., "Impedance Characteristics of the High Frequency Broadband Antenna System on the USS Northampton, EC1C 1," NRI Report 4311, Mar. 1954
  - R. Fulper, Jr., W.G. Long, Jr., M.I. Leppert, M.I. Musselman, "The Communication Antenna System on the USS Northampton (EC1C 1)," NRI Report 4641, Feb. 1956
- 136 H.B. Janes, A.W. Walters, and I.R. White, "A Communication Antenna System for Class SS 487 Guppy Submarines," NRI Report 3524, Aug. 1949
  - H.B. Janes, A.W. Walters, and E.H. Flath, Jr., "Broad Band Sleeve Antenna Considerations for Class BB63, CA132, and CL106 Ships," NRI Report 3788, Jan. 1951
  - H.B. Janes, A.W. Walters, and E.H. Flath, Jr., "A Proposed Broadband High Frequency Antenna System for Destroyers of the DD927 Class," NRI Report 3804, Jan. 1951
  - H.B. Janes, A.W. Walters, and E.H. Flath, Jr., "Broadband High Frequency Antenna Considerations for the CLK 1 Type of Ship," NRI Report 3826, June 1951
- 137 A.W. Walters, "Broad Band Modified Sleeve Antennas for Destroyers," NRI Report 3431, Mar. 1949
  - A.W. Walters, H.B. Janes, "Broadband Communication Antennas for Destroyers of the USS 693 Class," NRI Report 3515, Aug. 1949
- 138 M.A. Griffith, "Improvement of the 2.6 Mc. Stack Antenna on the USS Northampton (EC1C 1)," NRI Report 4339, Apr. 1954
- 139 M.I. Leppert, "Supplement I: The Conical Monopole Antenna," NRI Memo Rept 871, Dec. 1959
  - M.I. Leppert, Patent No. 3,000,194
- 140 R.F. Schmidt, "Broadband High Frequency Antennas for US Observation Island (EAD 154)," NRI Report 5711, Nov. 1961
- 141 A.W. Walters, "Broad Band Antenna Considerations for One Type of Guppy Submarine (SS 450)," NRI Report 3410, Mar. 1949
- 142 "Multiple Transmissions with Same Antenna," NRSR, July 1922, pp. 4-6

RADIO COMMUNICATION

143. NRL letters to Bureau of Engineering, S67/66(A), 52(A), 19821, 18 Feb. 1930, and S67/66 (A 4216), 30 Oct. 1930, NRL CRMO
144. NRL letter to Bureau of Engineering, S67/66/4523, 11 Nov. 1931, NRL CRMO
145. NRL letter to Bureau of Engineering, S67/66/4975, 23 Jan. 1933, NRL CRMO
146. I. R. White, "Multiple Transmitter and Receiver Operation on a Single Antenna, (225 to 390 Mcs)," NRL Report 2992, Dec. 1946
147. I. R. White, "Theoretical Notes on a Method of Common Antenna Working in the High Frequency Band," NRL Report 3760, Nov. 1950
148. I. R. White, "Antenna and Multicoupler Experiments, USS Irex," NRL Report 3812, Mar. 1951
149. M. L. Leppert, "Design and Operational Characteristics of a 2.6 Mc Four Channel Antenna Multicoupler," NRL Report 4113, Mar. 1953
- C. W. Hobbs, W. A. Schmemman, "Four Unit Antenna Multicoupler Systems for 4 to 12 and 6 to 18 Megacycles," NRL Report 4280, Jan. 1954
- W. A. Schmemman, "A Four Unit Antenna Multicoupler System for 9 to 26 Megacycles," NRL Report 4295, Jan. 1954
150. O. Norgorden, "A Reflectometer for HF Band," NRL Report 3538, Sept. 1949
151. C. E. W. Hobbs and M. L. Leppert, "Antenna Multiplexing," Report of NRL Progress, June 1956, pp. 22, 23
152. C. E. Hobbs and H. D. Murray, "Antenna Multiplexing," Report of NRL Progress, Dec. 1962, p. 29
153. C. E. W. Hobbs, "Antenna Multiplexing," Report of NRL Progress, Feb. 1959, pp. 34, 35
- C. E. Hobbs, "Antenna Multiplexing (Shipboard Transmitter Multicouplers)," Report of NRL Progress, Dec. 1960, p. 41
154. C. E. Hobbs and H. D. Murray, "Antenna Multiplexing (Transmitting Antenna Circuitry)," Report of NRL Progress, Aug. 1963, pp. 28, 29
155. C. E. Hobbs and H. Murray, "Antenna Multiplexing (Antenna Circuitry - Transmitting)," Report of NRL Progress, Apr. 1965, p. 41
156. NRSR, Feb. 1923, pp. 16-27, reproducing Bureau of Engineering letter to Commander in Chief, U.S. Fleet, 2 Jan. 1923
157. NRSR, Oct. 1922, pp. 29-33
158. NRSR  
 Feb. 1923, p. 22  
 Mar. 1923, pp. 15-24  
 Aug. 1923, p. 58  
 Nov. 1923, pp. 1-10  
 Dec. 1923, pp. 18-20  
 May, 1924, p. 11  
 Aug. 1924, pp. 26-27
159. C. E. Hobbs, "Antenna Multiplexing (Passive Receiver Multicouplers)," Report of NRL Progress, Apr. 1961, p. 46
160. NRL letter to Naval Ships Systems Command, 5410 127, Ser. 1958, 9 Mar. 1966, NRL Problem R01 31, NRL CRMO
161. D. A. Venn and R. G. Hennessey, "Centralized Electronic Control HF Receiver Preselectors," NRL Report 7009, Feb. 1970
162. K. L. Leidy and H. D. Cabbage, "A Towable Electronic Communications Buoy," NRL Report 5075, Jan. 1958
163. K. L. Leidy and H. D. Cabbage, "A Submarine Communication Buoy System," NRL Report 5186, Jan. 1961
164. H. D. Cabbage, "Submarine Electronic Buoy (An Improved Submarine Communications Buoy), Report of NRL Progress, Mar. 1964, p. 11
165. "Balloons, Buoys, and Satellites," National Center for Atmospheric Research, Boulder, Colorado, Quarterly Review No. 25, November 1969
166. H. J. Mastenbrook, A. D. Anderson, and H. D. Cabbage, "The Transosonde System," Report of NRL Progress, Feb. 1954, pp. 1-9
167. A. D. Anderson, H. J. Mastenbrook, H. D. Cabbage, "The Transosonde - A New Meteorological Data Gathering System," NRL Report 4649, 3 Nov. 1955
168. H. J. Mastenbrook, "Utilization of Transosonde Data," NRL Report 5310, May 1959
- J. K. Angell, "Uses of Constant Level Balloons in Meteorology," Advances in Geophysics, Vol. 8, 1961, pp. 137-219
169. J. W. Allen and G. Welch, "The Lightweight Transosonde System," NRL Report 5921, 30 Jan. 1964
170. NRL letter from C.O., U.S. Naval Air Station, Anacostia, DC to Bureau of Engineering, 1323-A 48, 27 Sept. 1922, "Radio Telegraph - Experiments with Extremely Short Waves," in NRL File S67 431, "Transmission and Reception at Ultra High Frequencies," file in Federal Record Center, NRL CRMO
171. NRSR  
 Nov., Dec. 1927, Jan. 1928, pp. 52-56  
 Jan., Feb., Mar. 1929, pp. 46-53
172. A. Hoyt Taylor, "Radio and the Sun Spot Cycle," Navy Dept. Bulletin of Engineering and Information No. 100, July 1936, pp. 74-78
- I. C. Young and F. O. Hulbert, "Radio and the Sunspot Cycle," NRL Report 1259, Apr. 1936
173. A. Hoyt Taylor, "Radio Reminiscences - A Half Century," NRL Library 359 0072 1238 Ref  
 a. pp. 140, 141, 163, 164 (1960), pp. 242-245, 279-282 (1948)  
 b. p. 141 (1960), pp. 244, 245 (1948)  
 c. p. 155 (1960), pp. 266, 267 (1948)  
 d. p. 216 (1960), pp. 372, 373 (1948)  
 e. pp. 175-179 (1960), pp. 298-307 (1948)  
 f. p. 133 (1960), pp. 230-232 (1948)
174. NRSR  
 Oct., Nov., Dec. 1929, p. 34  
 July Dec. 1930, pp. 29-30  
 July Dec. 1931, pp. 96, 99  
 July 1932, pp. 2-7  
 • NRL Annual Reports, 30 July 1929, 24 June 1930, 24 June 1932, 3 July 1936, see NRL File A91, "Annual Reports 1924-1935", NRL CRMO
175. Bureau of Engineering letter to Commander in Chief, U.S. Fleet, 27 June 1932, "Investigation and Tests of Superfrequencies by Units of the Fleet with NRL Comments," reproduced in NRSR, Jan. 1933, pp. 8-28
176. L. A. Gebhard, "Superfrequencies for Aircraft Applications," NRL letter to Bureau of Engineering F42 172 LAG/VMH, 18 Apr. 1934, NRL CRMO
177. J. M. Coe, F. C. Kahler, "Test of Preliminary Model TBS, Transmitting Equipment, submitted by RCA," NRL Report 1508, Jan. 1939
- H. G. Lindner, S. A. Greenleaf, "Test on Model TBS Receiver, submitted by the RCA Mfg. Co.," NRL Report 1509, Jan. 1939
- Navy Dept. Bulletin No. 90, 1 Jan. 1934, pp. 52-61
- Navy Dept. Bulletin No. 102, 1 Jan. 1937, p. 42
178. C. W. Harrison and J. E. Blower, "Electronics - Your Future," Am. Soc. Naval Engineering, Feb. 1950, pp. 99-137
179. NRL letters to Bureau of Engineering, NRL CRMO

RADIO COMMUNICATION

- P16 4 (9), 19 Jan. 1932  
 F42 1/49 (4629), 11 Mar. 1932  
 F42 VF5B (1217), 19 June 1933, Battle Force (C.O. VF 5B)  
 letter to Bureau of Engineering
- 180 "Study of Superfrequencies for General Application," NRL Monthly Progress Reports to Bureau of Engineering, NRL File C-A9 4/ENS, Problem W3 2S (1935-1938)
- 181 D.L. Fye, R.O. Parker, "Airborne Radio Results of Tests on an AN/ARC 1 Modified Equipment," NRL Report 2605, Aug. 1945
- 182 "UHF Conversion Programs," U.S. Naval Aviation Electronics Digest, NAVAER 08 1 503, July 1953, pp. 3-7
- 183 T. McL. Davis and E. Toth, "Design of Communication Receivers for the Naval Service with Particular Consideration to the Very High Frequency and Ultra High Frequency Ranges," IRE, Feb. 1947, pp. 201-213
- 184 J.A. Edinborgh, "Model TDQ Transmitter," NRL Report 2468, Mar. 1945  
 •Bureau of Ships letter to NRL, CNXSS 29644 (926) Ser. No. 642, 25 Sept. 1943, NRL letter to Bureau of Ships, C 567:52 (380 JE), 19 Oct. 1943, NRL CRM0
- 185 S.C. Hooper, RADM, USN, "International Telecommunications Conferences," J. Am. Soc. Naval Engineers, May 1939, pp. 153-177
- 186 F.C. Isely, "Survey of Tuned Circuits for the 300 to 3000 Mc Frequency Range," NRL Report 2984, Sept. 1946  
 •M.F. Davis, F.C. Isely, "Development of Preselector Units Covering the Frequency Ranges 85 to 180 Mc, 175 to 355 Mc, and 350 to 700 Mc," NRL Report 2985, Nov. 1946  
 •J.D. Wallace, "Coverage of 60 to 80 Mc, 115 to 156 Mc, and 225 to 400 Mc Shipboard Communication Systems," NRL Memo Rept 126, Feb. 1953  
 •NRL letter to Bureau of Engineering S67:86, 9 June 1939, "Radio Investigation of Wave Propagation Over Sea Water at Frequencies of 100 to 400 MC" see NRL File S67:86, "Radio Wave Propagation 1931 No. 1, NRL CRM0
- 187 J.E. McGeogh, J.H. Dunn, and G.K. Jensen, "The AN/ARC 19 (XN 1) Airborne Multichannel Communications System, Its Development, Evaluation and a Proposal for an Improved System," NRL Report 3185, Oct. 1947
- 188 J.W. Alotz, "Test of Model CNHY (RDZ) Radio Receiving Equipment," NRL Report 2667, Oct. 1945
- 189 W.E.W. Howe, "Test of Model RDZ 1 Radio Receiving Equipment," NRL Report 2929, Aug. 1946  
 •A.W. Walters, "Interference Analysis of 100 Primary Communication Channels and Guard Channels 225-400 Mc. (TDZ RDR Equipment)," NRL Report 3050, May 1947  
 •A.W. Walters, "Interference Analysis of 100 Primary Communication Channels and Guard Channels 225-400 Mc. (MAR RDZ Equipments)," NRL Report 3051, May 1947  
 •A.W. Walters, "Analysis of Channel Interference on Communications Systems (225 to 400 Mc)," NRL Report 3059, Aug. 1947
- 190 W.C. Whitmer, E.I. Powell, "Development of an Improved Radio Frequency Filter System for Model RDZ/RDZ 1 Receiving Equipment," NRL Report 3127, May 1947  
 •R.S. Werner, "Improvement of Interference Characteristics of the Model TDZ Transmitter," NRL Report 3349, Aug. 1948  
 •R.P. Smith, "An Improved Crystal Controlled Preselector and IF Amplifier for 225-400 Mc. Reception," NRL Report 3366, Oct. 1948  
 •J. Awramik and J.M. Jewett, "Radio Channel Selection for Interference-Free Operation," Report of NRL Progress, July 1958, pp. 10-23
- 191 B.C. Hill, S.L. Kenyon, "Investigation of Oscillator Circuits for Use with CR 9/U Over-Mode Crystal Units," NRL Report 3158, Nov. 1947  
 •D.A. Venn, "Current Status of Quartz Crystal Units and Circuitry for Frequency Control," NRL Report 4140, Apr. 1953  
 •D.A. Venn, "Measuring VHF Impedance of Piezo Electric Crystals at Resonance," Tele Tech, Mar. 1950
- 192 D.R. Maxson, "Investigation and Study of the AM Reduction and Downward AM Characteristics of Three Forms of Ratio Type FM Detector," NRL Report 3190, Oct. 1947  
 •D.R. Maxson, "Development and Performance of Ratio Type FM Detector as Applied to the Model RDX Receiving Equipment," NRL Report 3194, Nov. 1947  
 •E. Toth, J.D. Wallace, "Comparison of AM and Narrow Band FM UHF Communication Systems, Final Summary Report and Appendix A," NRL Report 3230, June 1952  
 •R.M. Maiden, "Comparison of AM and Narrow Band FM UHF Communication Systems Appendix B Theoretical Considerations," NRL Report 3231, Mar. 1950  
 •W.E.W. Howe, A.R. Rumble, "Comparison of AM and Narrow Band FM UHF Communication Systems Appendix C Design and Performance Characteristics of Equipment Employed," NRL Report 3232, Mar. 1948  
 •H.R. Johannessen, W.E.W. Howe, "Comparison of AM and Narrow Band FM UHF Communication Systems Appendix D Laboratory Studies and Investigations," NRL Report 3233, Feb. 1949  
 •D. McClenon, "Comparison of AM and Narrow Band FM UHF Communication Systems Appendix E Shipboard Studies and Investigations," NRL Report 3234, Mar. 1948  
 •F.J. Hollweck, "Comparison of AM and Narrow Band FM UHF Communication Systems Appendix F Airborne Studies and Investigations," NRL Report 3235, June 1948  
 •R.S. Werner, "Improvement of Interference Characteristics of the Model TDZ Transmitter," NRL Report 3349, Aug. 1948  
 •R.P. Smith, "An Improved Crystal Controlled Preselector and IF Amplifier for 225-400 Mc. Reception," NRL Report 3366, Oct. 1948  
 •R.W. Zeek, "Investigation and Analysis of 'Capture Effect' in fm and am Communication Systems," NRL Report 3422, Feb. 1949  
 •W.E.W. Howe, R.W. Zeek, "Investigation of Nonlinear Receiving Circuits Under Two Signal Conditions," NRL Report 3460, Nov. 1949  
 •E. Toth, "AM and Narrow Band FM," Electronics, Part I, Feb. 1949, pp. 84-91, Part II, Mar. 1949, pp. 102-108
- 193 E. Toth, "Theoretical Range Capability of an Amplitude Modulated UHF Radio Telephone System," NRL Report 4321, Mar. 1954
- 194 E. Toth, "A Means for Analysis of Communication Equipment and System Performance Using Log Log Selectivity Curves," IRE Convention Record, Mar. 1956, pp. 28-35
- 195 W.E. Withrow, "Development of Broad Band Communication Antennas RSD 10 and RSD 10," NRL Report 2894, Aug. 1945  
 •NRL letter to Bureau of Ships, 24 Aug. 1942, "Radio Investigation of Broad Band Antennas," NRL File C 367:52, 367, NRL CRM0
- 196 E.M. Lonsdale, "Survey of Antenna Work of Radio Division at NRL," NRL Document 366-074, Apr. 1944, pp. 1-14
- 197 E.R. Longman, J. Awramik, Jr., "Directive Communication System with Mutually Aligning Antennas," NRL Report 3627, Feb. 1950

## RADIO COMMUNICATION

- D.D. Howard, "An Improved Directive Communication System," NRL Report 3931, Feb. 1952
- J. Awramik, Jr., W.M. Jewett, "A Means of Rapid Antenna Alignment for Directive Communication," NRL Report 4079, Dec. 1952
- W.M. Jewett, "Self Seeking Communication System," Report of NRL Progress 1953, p. 38
- Report of NRL Progress, Mar. 1928, p. 27
- 198. L.R. White, "Multiple Transmitter and Receiver Operation on a Single Antenna (225 to 390 Mc)," NRL Report 2992, Dec. 1946
- L.G. Robbins and O. Norgorden, "Notes on Development of Systems for Common Antenna Working (230-390 Mc)," NRL Report 3058, June 1947
- L.G. Robbins, "A Four Unit Common Antenna Working Coupler System for 230 to 390 Mc," NRL Report 3564, Nov. 1949
- L.G. Robbins, "Automatic Control of a VHF/UHF Common Antenna Working System," NRL Report 3570, Nov. 1949
- L.G. Robbins, "A Six Unit Common Antenna Working Coupler System for 230 to 390 Mc," NRL Report 3574, Nov. 1949
- 199. E.O. Hulburt, "The Ionosphere, Skip Distance of Radio Waves, and the Propagation of Microwaves," IRE, Dec. 1935, pp. 1492-1506
- 200. L.V. Blake, "Antennas," 1966. NRL Library 621.384135 B 636 Ref. pp. 42-43
- 201. IRE, Oct. 1955, special issue on Scatter Propagation
- 202. R.M. Page (NRL), "The Origin of Radar," NRL Library 621.3846.P 133, pp. 147-150
- 203. M. Katzin, "Preliminary Report on S and X Band Propagation in Low Ducts Formed in Oceanic Air," NRL Report 2493, Mar. 1945
- W.S. Ament, M. Katzin, "Signal Fluctuations in Long Range Overwater Propagation," NRL Report 3639, Mar. 1950
- "Elevated Duct Propagation in the Trade Winds," NRL Report 5602, June 1961
- W.S. Ament, W. Binnman, and W.W. Carter, "Microwave Propagation Measurements Over the Pacific Ocean, 1946," NRL Report 5687, Feb. 1962
- 204. H.E. Dinger, W.E. Garner, J.E. Raudenbush, "200 Mc Propagation Measurements Beyond the Radio Horizon," NRL Report 4449, Nov. 1954
- W.E. Garner, H.E. Dinger, "Over-Water Tropospheric Scatter Propagation Investigations - Summer Conditions," NRL Report 4795, Aug. 1956
- W.E. Garner, H.E. Dinger, "Over-Water Tropospheric Scatter Propagation Investigations Under Winter Conditions," NRL Report 4908, Mar. 1957
- J.E. Raudenbush, "Tropospheric Forward Scatter Over a Sea-water Path at X Band, Employing Directional and Omnidirectional Antennas," NRL Report 7184, Nov. 1970
- Roeder, B.F., RADM, "Naval Communications of the Future," Signal, May 1951, pp. 62, 63, 84
- 205. J.R. Kauke, "Modification of JM 1 Sono Buoy Equipment for Use in Torpedo Timing," NRL Report 2551, Aug. 1945
- R. Badessa, "Tests of Model REN Portable Sono Radio Buoy Receiver," NRL Report 2620, Aug. 1945
- F.J. Hollweck, "Development of Model CXB Boat Type Sono Radio Buoy," NRL Report 2685, Nov. 1945
- H.G. Bowen, VADM, "Ships, Machinery and Mossbacks," Princeton Univ. Press, Princeton, N.J., 1954, p. 163, NRL Library 621.88786 (Ref)
- 206. J.R. Kauke, "Type Approval Test of AN/ARR 16B Radio Sono Buoy Receiver," NRL Report 2584, Aug. 1945
- J.R. Williams, "Tests of AN/ARR-16B, Serial 0009 Radio Sono Buoy Receiver," NRL Report 2632, Oct. 1945
- J.M. Miles, "Test of Four Model AN/CRT 4 Directional Radio Sono Buoys," NRL Report 2639, Oct. 1945
- F.J. Hollweck, "Redesign of AN/CRT-1B Expendable Radio Sono Buoy," NRL Report 2844, May 1946
- J.M. Miles, "Radar Homing System for Expendable Radio Sono Buoy AN/CRT-1B," NRL Report 2991, Jan. 1946
- J.M. Miles, "Fifty Years of Naval Avionics," Part I, U.S. Naval Aviation Electronics, Aug. 1961, pp. 23-39
- 207. F.C. Kahler, "A Submarine Radio Rescue Buoy," NRL Report 3490, June 1949
- J. Awramik, "Submarine Rescue VHF/UHF Radio Transmitting Buoy Mechanical Design Considerations," NRL Report 5707, Dec. 1961
- J. Awramik, "Submarine Rescue VHF/UHF Radio Transmitting Buoy. Electrical and Radio Design Considerations," NRL Report 5820, Oct. 1962
- J. Awramik, "Operational Trial of Submarine Rescue Radio Transmitting Buoy T-616(XN)/SRT," NRL Memo. Rept. 1006, Dec. 1959
- E.F. Bryan, "Performing Optimization of the NRL Submarine Rescue Radio Transmitting Buoy," NRL Memo. Rept. 1059, June 1960
- "Submarine Emergency Radio Buoy," Report of NRL Progress, Mar. 1947, p. 32
- 208. "Radio-Progress on Ultra-Short Wave Transmitters," NRL letter to Bureau of Engineering S67/43 (5025), 15 Mar. 1933, see NRL File S67/52, "Radio Transmitters," 1933, Problem T3-1; NRL CRMO
- 209. W.J. Cahill, "Development of Micro-Ray Radio Apparatus for Use in Aircraft Altitude Meter Equipment," NRL Report 1111, Jan. 1935
- W.J. Cahill, "Present Day Technique for Radio Transmission and Reception in the Micro-Ray Frequency Band (300-3000 Mc.) with Suggested Applications for Naval Purposes," NRL Report 1149, Apr. 1935
- "Radio Micro Ray," Problem O-25, 1933-1938 Monthly reports, NRL File S67/35, NRL CRMO
- 210. H. Herman, R.J. Coates, "Millimeter Wave Research, Components for Millimeter Wavelength Range," NRL Report 3223, Jan. 1948
- R.J. Coates, S.F. Rogers, "The Electroforming of Millimeter Wavelength Wave Guide Components," NRL Report 3673, June 1950
- M. Schulkin, "Determination of Microwave Atmospheric Absorption Using Extraterrestrial Sources," NRL Report 3843, Oct. 1951
- R.G. Fellers, J.A. Vignali, "An Experimental 8.6 MM High-Resolution Radar," NRL Report 4662, Nov. 1955
- R.G. Fellers, J.A. Kaiser, "Millimeter Wavelength Components," NRL Report 4704, Mar. 1956
- R.J. Coates, "The Measurement of Atmospheric Attenuation at 4.3 MM Wavelength," NRL Report 4898, Apr. 1957
- K.M. Decker and J.A. Vignali, "A Secure Communication System," NRL Report 5194, Aug. 1958
- K.M. Decker and R.C. Dodson, "Propagation Measurements in the 5 Millimeter Region," NRL Report 5385, Oct. 1959
- K.M. Decker and J.A. Vignali, "A Comparison of Modulation Methods for the Ear-Shot System," NRL Report 5633, Aug. 1961
- J.A. Vignali and K.M. Decker, "The Application of Microwaves to Low Intercept Short Haul Communication," NRL Report 6187, Feb. 1965

## RADIO COMMUNICATION

- K.M. Decker and R.C. Dodson, "Propagation Measurements with the Earshot System," NRI Report 6301, Sept. 1965
- J.A. Vignali, "The Application of Diversity Techniques to Ship to Ship Communication," NRI Report 6629, Dec. 1967
- J.A. Vignali, K.M. Decker, and R.C. Dodson, "Overwater Line of Sight Fade Measurements at 37 GHz," NRI Report 6774, Dec. 1968
- J.A. Vignali, K.M. Decker, and R.C. Dodson, "Overwater Line of Sight Space Diversity Measurements at 37 GHz," NRI Report 6826, Apr. 1969
- J.A. Vignali, K.M. Decker, and R.C. Dodson, "Overwater Line of Sight Frequency Diversity Measurements at 37 GHz," NRI Report 6885, Apr. 1969
- J.A. Vignali, "Millimeter Waves and Amphibious Warfare Communications," NRI Report 6936, June 1969
- J.A. Vignali, "Millimeter Waves and Naval Airborne Communications," NRI Report 7165, Dec. 1970
- J.I. Ayoub, "EHF Naval Communications," NRI Report 7169, Oct. 1970
- K.M. Decker, "Millimeter Wave Propagation over an Aircraft Carrier Deck," NRI Report 7195, Jan. 1971
- R.C. Dodson, "Experimental Measurement of Space Diversity Improvement at 37 GHz," NRI Report 7199, Dec. 1970
- 211 F.O. Hulbert, "Ionization in the Atmosphere of Mars," IRE, Sept. 1929, pp. 1523-1527
- 212 J.H. Trexler, "Lunar Radio Echoes," IRE, Jan. 1958, pp. 286-292
- 213 B.F. Trotter, A.B. Youmans, "Communications Moon Relay (CMR)," NRI Report 4907, June 1957
- 214 J. Virden, RADM, USN, "Communication Requirements of our Navy," Signal, Dec. 1959, pp. 14, 16, 35, 36
- "U.S. Navy Communications Moon Relay (CMR) System," Naval Research Reviews, Mar. 1960, pp. 17-18
- C.A. Bass, I.H. Feher, W.E. Leavitt, and M.I. Musselman, "Communication by Moon Reflection," Signal, Apr. 1960, pp. 46, 47
- 215 B.S. Yapple, et al., "Radar Echoes from the Moon at a Wavelength of 10 CM," IRE, Jan. 1958, pp. 291-297
- 216 J.F. Sees, "Highly Directive Antennas Used in NRI's Radio Astronomy Program, Part I - The Fifty Foot Paraboloid," Report of NRI Progress, Jan. 1958, pp. 1-11
- 217 W.F. Leavitt, "Phase Locked Crystal Oscillator Filter Techniques," NRI Log Book, Register No. 2463, pp. 7, 8, 24 Aug. 1956, NRI CRM0
- 218 NRI Problem File S4R0118, Code S413B, memo to Code S400, 11 Apr. 1957
- 219 "Navy Communication With Echo," Naval Research Reviews, Sept. 1960, pp. 13-15
- J.P. Leiphart, W.E. Leavitt, and F. Toth, "Communications Satellite Investigations," Report of NRI Progress, Sept. 1960, pp. 48, 49
- 220 Electronic News, 14 Nov. 1960
- 221 I.H. Feher, V.W. Graham, W.F. Leavitt, and M.I. Musselman, "Satellite Communication Research - Communications by Moon Relay (CMR)," Report of NRI Progress, May 1962, pp. 36, 37
- "Moon Used to Transmit Shore to Ship Radio Messages," Naval Research Reviews, Feb. 1962, pp. 21-22
- 222 Federal Communications Commission Rules and Regulations, 27 Nov. 1958, Appendix (4), Vol. II, Part 5, Vol. III, Parts 73-74, Vol. IV, Part 81, Vol. V, Parts 87, 89, 91, and 93, Vol. VI, Part 99, Vol. VII, Parts 21 and 23
- 223 B. Wald, "Digital Computer Control of a Radio Telescope for Tracking the Sun, Moon and Planets," NRI Report 5128, Mar. 1958
- 224 "150 Foot Radio Telescope at Sugar Grove," Sky and Telescope, June 1965, p. 346
- 225 A.B. Youmans, "Design of 300 foot Research Antenna," Chapter II, in *Structure Technology for Large Radio and Radar Telescope Systems*, MIT Press, 1969
- 226 C.A. Bass and D.H. Townsend, "The NRI Microwave Space Research Facility - Design and Development of the 60 Ft X Band Antenna," NRI Report 6921, Aug. 1969
- C.A. Bass and C.J. Stillings, "The NRI Microwave Space Research Facility - Computer System Hardware for Data Acquisition and Control of the 60 Ft X Band Antenna," NRI Report 7103, June 1970
- C.A. Bass and D.H. Townsend, "The NRI Microwave Space Research Facility - Operating Procedures of the Computer Control System for the 60 Ft X Band Antenna," NRI Report 7110, June 1970
- C.A. Bass and T.F. Schmeskpeper, "The NRI Microwave Space Research Facility - Computer System Software for Control of the 60 Ft X Band Antenna," NRI Report 7188, Jan. 1971
- 227 B.I. Edelson, LCDR, USN, "The Advent Satellite Communications," Signal, July 1962, pp. 4-6
- 228 B.I. Edelson, LCDR, USN, J.J. Dougherty, CDR, USN, "Navy Satellite Communications," U.S. Naval Inst. Proc., July 1962, pp. 67-75
- I. Jaffee, "Communications in Space," Holt, Rinehart and Winston, New York, 1966, NRI Library 621 384156123
- 229 D.J. Woodward, CDR, J.I. Debold, CDR, "Kingsport Experience with the Syncoms," *Astronautics & Aeronautics*, Jan. 1965, pp. 30-32
- 230 B.F. Roeder, RADM, "Naval Communications of the Future," Signal, May 1964, pp. 62-63
- 231 F.D. Boyle, RADM, USN, "The Initial Defense Communications Satellite System," Signal, Nov. 1964, pp. 7-8
- 232 "TRW Space Log, Winter 1969-1970," pp. 104, 110, 114, 120
- W.F. Leavitt and J.P. Spritz, "Reception Via the Syncom II Communication Satellite Using an 8 foot Parabolic Antenna," NRI Memo Rept 1617, May 1965
- 233 R.H. Weeks, RADM, USN, "Naval Communications 1966," Signal, May 1966, pp. 29, 30, 46
- M.D. VanOrden, CAPT, USN, "Shipboard Terminal Development," Signal, July 1967, pp. 51, 52
- 234 M. Goldenthal and J.A. Boyd, "The Satellite Communication Revolution," Signal, Feb. 1966, pp. 6, 7
- H.E. Thornhill, CAPT, USN, "Navy Satellite Communications," Signal, Aug. 1967, pp. 14-16
- R.H. Weeks, RADM, USN, "Naval Communications in Southeast Asia Operations," Signal, Apr. 1968, pp. 17-15, 18, 19
- 235 W.F. Leavitt, "Simulation of Shipboard Operation of AN/SSC-3 Shipboard Satellite Communication Set," NRI Memo Rept 1924, Sept. 1968
- W.F. Leavitt, "Investigation of Tilted Subreflector on AN/SSC-3," NRI Memo Rept 1942, Oct. 1968
- C.A. Bass and C.J. Stillings, "Current Limit Motion Protection for the AN/SSC-3 Shipboard Satellite Communication Set," NRI Memo Rept 1958, Jan. 1969
- C.A. Bass and C.J. Stillings, "Stabilization Characteristics of the AN/SSC-3 Shipboard Satellite Communication Set," NRI Memo Rept 1995, Apr. 1969
- E.F. Kohler, "Design Changes to AN/SSC-3 Transmitter Klystron Power Supplies," NRI Memo Rept 2010, June 1969
- 236 I.S. Beauce, "Azimuth/Elevation Tables for Pointing at Near Equatorial Satellites," NRI Report 7145, Aug. 1970

RADIO COMMUNICATION

- 237 C A Bass, "A Flow Diagram Technique for Time Varying Coordinate Systems," NRI Report 7119, June 1970
- 238 D H Townsend, "Angular Velocities and Accelerations for Line of Sight Stabilized Shipboard Antennas," NRI Report 7249, Mar 1971
- 239 F F Schmeckpeper and C A Bass, "A Computer Method for Shipboard Siting of Antennas," NRI Report 7144, July 1970
- 240 J P Leiphart and F Troth, "Satellite Communication - Detectability of Shipboard Terminals," NRI Report 6413, Sept 1965
- 241 W E Leavitt and R A LeFandre, "Doppler Shift Considerations in Naval Satellite Communications Systems Employing Synchronous Satellites," NRI Report 7147, Dec 1970
- 242 NRI Radio Division, Scientific Program Statement, Jan 1968
- 243 J P Spraitz, "Error Rate Measurements on the AN/UCC 1 (XN 2) Telegraph Terminal," NRI Memo Rept 2195, Dec 1970
- 244 J P Walsh, COL, USAF, "R & D Objectives for the Future Defense Communication System," Signal, Sept 1968, pp 6-11  
 • G T Gould, MAJ GEN, USAF, "Computers and Communications in the Information Age," Signal, Feb 1971, pp 6-14
- 245 R A LeFandre, "Attenuation of Microwave Radiation for Paths Through the Atmosphere," NRI Report 6766, Nov 1968
- 246 H E Thornhill, CAPT, USN, "Navy Satellite Communications," Signal, Aug 1967, pp 14-16  
 • S I Gravelly, CAPT, USN, "Navy Participation and Plans in Satellite Communications," Signal, Aug 1969, pp 5-56
- 247 G T Gould, MAJ GEN, USAF, "Computers and Communications in the Information Age," Signal, Feb 1971, pp 6-14
- 248 Report of the Secretary of the Navy, Bureau of Steam Engineering, Section 1919, p 620, 1920, p 714, Navy Dept Library
- 249 NRSR  
 Oct, Nov, Dec 1929, pp 28-31  
 Jan 1933, pp 147-150
- 250 I W Austin, "Some Quantitative Experiments in Long Distance Radiotelegraphy," National Bureau of Standards Bulletin, Vol 7, 1911, p 315
- 251 I W Austin, "Preliminary Note on Proposed Changes in the Constants of the Austin-Cohen Transmission Formula," IRE, June 1926, pp 377-380
- 252 F A Kitchen, B G Pressey, and K W Tremellen, "A Review of Present Knowledge of the Ionospheric Propagation of Very Low, Low, and Medium Frequency Waves," Inst. Electrical Engineers, London, Part III, Mar 1953, pp 100-108
- 253 "Study of Point-to-Point Radio Circuits, Atlantic Coast Net," NRI Monthly Report of Progress of Radio and Sound Problems to the Bureau of Engineering, Oct 1934 to June 1936, Problem W11, authorized by Bureau of Engineering, letter A6 2 (10-4 W) 10 Oct 1934, NRI GRMO
- 254 H E Dinger, "Poor Reception of the Transmissions from the Annapolis High Power Radio Station in the Vicinity of Newport, Rhode Island," NRI Report 1916, Aug 1942  
 • H E Dinger, "Poor Reception of NSS Fox Schedule (19Kc) in the Vicinity of Norfolk, Va.," NRI Report 1945, Oct 1942
- 255 H E Dinger, W F Garner, and G E Leavitt, "Measurements of Some Low and Very Low Frequency Signal Intensities in the Alaskan Area," NRI Report 1921, Jan 1952
- 256 W M Raeth, "Some Observations of Atmospheric Noise and Propagation Factors in the Arctic Report on Project 'Nanook'," NRI Report 3023, Dec 1946
- 257 H E Dinger, W F Garner, and G E Leavitt, "Measurements of Some Low and Very Low Frequency Atmospheric Noise in the Alaskan Area," NRI Report 1958, Apr 1952
- 258 M I Leppert, F J Shanahan, D A Worsley, "Balloon Elevated Antennas," NRI Report 4490, Feb 1955  
 • D A Worsley and C A Good, "Balloon Supported Antennas for Arctic Communication," NRI Memo Rept 153, May 1953  
 • D A Worsley and C A Good, "Balloon Supported Antennas for Arctic Communications," Report of NRI Progress, July 1953, pp 1-7  
 • M I Leppert, F J Shanahan, and D A Worsley, "Communication Antennas (Emergency Antenna Lifting Devices)," Report of NRI Progress, Jan 1955, p 38  
 • D A Worsley, F J Shanahan, and M I Leppert, "Balloon Elevated Antennas," Report of NRI Progress, Apr 1955, pp 10-17
- 259 W F Garner, F J Rhoads, F J Elwood, and R I Schauer, "Field Strengths of Some VLF Transmissions and Atmospheric Noise Measured in European Areas, June, July, and August 1959," NRI Memo Rept 1126, Mar 1961  
 • W F Garner, F J Rhoads, F J Elwood, and R I Schauer, "Field Strengths of Some VLF Transmissions and Atmospheric Noise Measured in European and Asian Areas, Sept., Oct., and Nov 1959," NRI Memo Rept 1164, May 1961
- 260 C B Brookes and J F Raudenbush, "Field Strength Measurements for NWC, North West Cape, Australia, from September to December 1967," NRI Report 7148, September 1970
- 261 W F Garner, F J Rhoads, J F Bickel, and R W Plush, "Measured Amplitude and Phase of the Antipodal Fields of a VLF Transmitter," Paper presented at 1962 fall URSI meeting, Ottawa, Canada, Oct 1962  
 • W F Garner and F J Rhoads, "Antipodal Effects in VLF Wave Propagation," Report of NRI Progress, Aug 1962, pp 1-19
- 262 J E Rogerson, "Results of Airborne Field Measurements in the Antipodal Region of Radio Station NPM, Hawaii," NRI Report 6173, Apr 1966
- 263 W F Garner, F J Rhoads, and J E Rogerson, "North-South Directional Effects on VLF Propagation," paper presented at "Symposium on the Ionospheric Propagation of VLF Electromagnetic Waves," National Bureau of Standards, Boulder, Colorado, 12-14 Aug 1963
- 264 F J Rhoads and W F Garner, "An Investigation of the Modal Interference of VLF Radio Waves," NRI Report 6359, Oct 1965  
 • C B Brooks, Jr., J H McCabe, and F J Rhoads, "Theoretical VLF Multimode Propagation Predictions," NRI Report 6663, Dec 1967
- 265 H E Dinger, "Whistling Atmospherics," NRI Report 4825, Sept 1956  
 • H E Dinger, "Atmospheric Whistlers," Report of NRI Progress, Dec 1954, pp 1-6  
 • H E Dinger, "Electronics Interference," Report of NRI Progress, Sept 1956, p 41  
 • H E Dinger, "Electronics Interference (Musical Atmospheric Periodic Dawn Chorus)," Report of NRI Progress, June 1957, p 36  
 • "Musical Atmospheric," NRI Annual Report, 1958, pp 7-8
- 266 J P Leiphart, R W Zeek, I S Bearse, and E Toth, "Penetration of the Ionosphere by Very Low Frequency Radio Signals. Interim Results of the LOFTII Experiment," NRI Report 5721, Nov 1961  
 • W R Faust, "Electrodynamics in a Magnetoionic Environment," NRI Report 6163, Nov 1964  
 • W R Faust, "Effective Lengths of Antennas in Magnetoionic Media," NRI Report 6190, Feb 1965

RADIO COMMUNICATION

- R.W. Zeek, "Penetration of the Ionosphere by VLF Radio Waves. Reception of 10.2 and 18.0 KC/S Signals by the LOFTI IIA Satellite," NRL Report 6252, June 1965
- L.S. Bearce, R.E. Cushing, E.E. Kohler, J.P. Leiphart, C.E. Young, and R.W. Zeek, "Atlas of Lofti IIA Satellite Orbit Maps and Quick Look Data," NRL Report 6455, Oct. 1966
- E. Toth and J.P. Leiphart, "Progress Report on NRL Satellite Communication Research," NRL Report 6482, Nov. 1966
- C.E. Young, "Impedance of Lofti IIA Very Low Frequency Antennas in the Ionosphere," NRL Report 6712, June 1968
- I. Toth, "Transionospheric Radio Communication. Part 2. Feasibility of an ELF/VLF Satellite to Submarine Communication System," NRL Memo Rept. 1821, Oct. 1967
- J.P. Leiphart, "Guidelines for a VLF/ELF Transmitting Spacecraft Design Study," NRL Memo Rept. 1949, Dec. 1968
- J.P. Leiphart, R.W. Zeek, L.S. Bearce, and E. Toth, "Penetration of the Ionosphere by Very Low Frequency Radio Signals," IRE, Jan. 1962, pp. 6-17
- 267 W.E. Garner, J.E. Raudenbush, and C.B. Brookes, "Radiation Parameters of the VLF Transmitting Station, North West Cape, Australia," NRL Memo. Rept. 1783, June 1967
- W.E. Garner and E.J. Elwood, "VLF Wave Propagation," Report of NRL Progress, Apr. 1963, pp. 39-41
- W.E. Garner, J.E. Rogerson, and E.J. Elwood, "VLF Wave Propagation," Report of NRL Progress, July 1963, pp. 57-60
- W.E. Garner, J.E. Raudenbush, and E.J. Elwood, "VLF Wave Propagation," Report of NRL Progress, Aug. 1963, pp. 29-31
- J.E. Raudenbush, "VLF Wave Propagation (Transmission Pattern of the VLF System at the U.S. Navy Radio Station at Cutler, Maine)," Report of NRL Progress, Nov. 1963, pp. 28-31
- E.J. Elwood and J.E. Raudenbush, "VLF Wave Propagation," Report of NRL Progress, Dec. 1963, pp. 39-41
- J.E. Raudenbush and W.E. Garner, "VLF Wave Propagation," Report of NRL Progress, Aug. 1964, pp. 40-42
- J.F. Raudenbush, "VLF Wave Propagation (Antenna Characteristics of the VLF System at the U.S. Navy Radio Station at Cutler, Maine)," Report of NRL Progress, Jan. 1965, pp. 27-29
- 268 A Hoyt Taylor, "Short Wave Reception and Transmission on Ground Wires (Subterranean and Submarine)," IRE, Aug. 1919, pp. 337-362
- 269 NRSR Oct. 1919, pp. 23-26
- 270 NRL Log, R.A. Gordon, Mar. 1931
- 271 O. Norgorden, R.B. Quinn, "Radio Transmission Between Two Submerged Submarines," NRL Report 3308
- 272 E.H. Flath, Jr., O. Norgorden, "Expressions for Input Impedance and Power Dissipation in Lossy Concentric Lines," NRL Report 3436, Mar. 1949
- 273 M.L. Musselman, "Key West Experiments on Horizontal Wire Antennas," NRL Report 3841, Aug. 1951
- 274 C.B. Appleman, "Impedance of Submerged Horizontal Wire Antennas," NRL Report 3889, Dec. 1951
- 275 M.L. Musselman, "Reception with Submerged Horizontal Wire Antennas," NRL Report 4180, Sept. 1953
- 276 T.J. Rauen, "Submerged Horizontal Wire Transmitting Antennas," NRL Report 4250, Nov. 1953
- 277 O. Norgorden, J.M. Coe, and R.B. Meyer, "Concentrated Capacity and Inductance as Substitute for Horizontal Antennas on Board Ship," NRL Report 1331, Dec. 1936
- O. Norgorden, "A Mathematical Analysis of the Radiation Characteristics of Partially Shielded Antennas," NRL Report 1446, June 1938
- O. Norgorden, R.B. Meyer, "A Study of the Radiation Characteristics of Shipboard Antenna Systems," NRL Report 1448, June 1938
- O. Norgorden, "A Study of the Operating Characteristics of Shipboard Trunk and Antenna Systems at Intermediate Frequencies," NRL Report 1574, Nov. 1939
- O. Norgorden, "A Study of Shipboard Antenna Trunk Systems," NRL Report 1603, Mar. 1940
- O. Norgorden, "Radiation Characteristics of Vertical Antennas with Slanting Top Sections at Intermediate Frequencies," NRL Report 1638, Aug. 1940
- M.I. Leppert, O. Norgorden, "Measurements of Transmission Characteristics of Shipboard Antenna Systems," NRL Report 1652, Sept. 1940
- O. Norgorden, "Investigation of Antenna Systems of USS SEADRAGON, USS SEARAVEN, USS TAMBOR, USS TRIPE and USS MAYRANT," NRL Report 1658, Oct. 1940
- C.W. Christenson, O. Norgorden, "Notes on the Calculation of Capacity of Intermediate Frequency Antennas," NRL Report 1671, Dec. 1940
- C. Christenson, O. Norgorden, "Investigation of Self Supporting Telescopic Vertical Antenna for Use on Battleships 55 & 56," NRL Report 1707, Mar. 1941
- O. Norgorden, "Notes on the Analysis and Measurements of Intermediate Frequency Shipboard Antenna Systems," NRL Report 1734, May 1941
- C. Christenson, O. Norgorden, "A Study of the Coupling Between Two Conductors in a Common Trunk at the Intermediate Frequencies," NRL Report 1746, May 1941
- C. Christenson, O. Norgorden, "Investigation and Measurement of Radio Transmitting Antenna Systems on USS NORTH CAROLINA," NRL Report 1796, Nov. 1941
- I.G. Robbins, O. Norgorden, "Electrical Properties of Coaxial Transmission Lines for High Power Applications," NRL Report 1846, Mar. 1942
- C.W. Christenson, O. Norgorden, "Coupling Between Antennas at Intermediate Frequencies," NRL Report 1878, May 1942
- 278 C.C. Rae, "Terminal Systems," Report of NRL Progress, June 1951, p. 37
- C.C. Rae, "Terminal Systems (Very Low Frequency Teletype)," Report of NRL Progress, Dec. 1951, p. 40
- 279 R.R. Stone and T.H. Gee, "Incorporating FSK into VLF Transmissions," Frequency, July-Aug. 1964
- R.R. Stone, Jr., "Frequency Control of Navy VLF Station," Report of NRL Progress, Feb. 1967, pp. 8-16
- 280 J.A. Willoughby and P.D. Lowell, "Development of Loop Aerial for Submarine Radio Communication," Phys. Rev., Aug. 1919, pp. 193-194
- 281 NRSR, July 1920, pp. 27-35 and 54-55
- 282 NRSR, Problem No. 13, July, Aug. Sept. 1926, pp. 23-24
- 283 O. Norgorden, "The Submerged Reception of Radio Frequency Signals," NRL Report 1669, Dec. 1940
- 284 R.B. Quinn, O. Norgorden, "The Transmission of Radio Signals from a Submerged Antenna," NRL Report 3006, Nov. 1946
- 285 A. Hoyt Taylor, "Short Wave Reception and Transmission on Ground Wires (Subterranean and Submarine)," IRE, Aug. 1919, pp. 337, 338
- 286 S.S. Robison, "Manual of Radio Telegraphy and Telephony," 1919, U.S. Naval Inst., pp. 173-175, Navy Dept. Library
- 287 R.B. Owens, "Test for Submarine Loop Antenna Cable," NRL Report 1151, Apr. 1935

## RADIO COMMUNICATION

- R.C. Guthrie, "Routine Test of Submarine Loop Antenna Cable," NRL Report 1209, Oct. 1935
- R.B. Ownes, R.W. Armstrong, "Weathering Test of Submarine Antenna Cable," NRL Report 1326, Nov. 1936
- "Contributions of Radio Division to the Naval Service," Radio Division memo to Director NRL, 13 Aug. 1935; NRL CRMO
- 288. O. Norgorden, "The Submerged Reception of Radio Frequency Signals," NRL Report 1669, Dec. 1940
- 289. F.C. Isely, "Test of Underwater Reception of Low Frequency Radio Signals," NRL Report 1717, Apr. 1941
- 290. S.V. Fratianni, "Submerged VLF Reception. A Study of Various Loop Coupling Methods," NRL Report 2872, Dec. 1946
  - "The Submerged Reception of Radio Frequency Signals," Navy Radio and Sound Bulletin No. 6, 1 Apr. 1942, pp. 1-18; NRL Library 605.B85
- 291. S.V. Fratianni, "Theory and Design of Resonant Transformer-Coupled Loop-Antenna Input Systems for VLF Reception," NRL Report 3281, Apr. 1948
  - S.V. Fratianni, "The Equivalent Selectivity of Transformer-Coupled Loop-Antenna Input Circuits," NRL Report 3464, May 1949
  - E. Toth, S.V. Fratianni, "Underwater Loop Reception Phenomena and Techniques," NRL Report 3605, Jan. 1950
  - S.V. Fratianni, "VLF Omnidirectional Loop Receiving Adapter," NRL Memo. Rept. 188, July 1953
  - "Interim Report on Problem S1083, 1 R-C," NRL letter to Bureau of Ships, CSS/7 (1223:SVF), C-1220-38/46, 11 Mar. 1946 NRL File S67/46; NRL CRMO
  - E. Toth, "Omnidirectional Loop System," Patent 2,690,509, filed 5 Feb. 1951, issued 28 Sept. 1954
- 292. NRSR
  - July, Aug. 1925, pp. 5, 6
  - Mar., Apr. 1926, p. 59
  - July, Aug., Sept. 1926, pp. 38-40
  - Feb., Mar., Apr. 1927, p. 1
  - July, Aug. 1927, p. 22
- 293. NRSR
  - Jan., Feb., Mar. 1929, pp. 13, 14
  - July, Aug., Sept. 1929, p. 46
- S.A. Greenleaf, "Tests of Model RO-2 Receiver, Serial #7," NRL Report 1009, Dec. 1933
- 294. NRSR
  - July-Dec. 1931, pp. 3, 4
  - Jan.-Mar. 1932, p. 2
  - Jan. 1933, pp. 91, 92, 206, 213
  - NRL Annual Report, June 1932
- 295. J.H. Gough, "Test of Models RAA and RAB Receiving Equipments (Audio System)," NRL Report 1027, Feb. 1934
  - E.N. Dingley, Jr., "Test of Models RAA and RAB Receiving Equipments (RF and IF Amplifier and Detector Circuits of the Model RAA)," NRL Report 1028, Feb. 1934
  - W.B. Burgess, "Tests of Model RAA and RAB Receiving Equipment (RF and IF Amplifier and Detector Circuits of the Model RAB)," NRL Report 1030, Mar. 1934
  - E.N. Dingley, Jr., "Detector Characteristics," NRL Report 1034, Mar. 1934
  - E.N. Dingley, Jr., "Pre-Selector Circuits," NRL Report 1035, Mar. 1934
  - W.B. Burgess, S.A. Greenleaf, "Test of Models RAA and RAB Receiving Equipment. RF and IF Amplifier and Detector Circuits of Models RAA and RAB," NRL Report 1250, Mar. 1936
  - S.A. Greenleaf, "Test to Determine the Practicability of Substituting Type 38593 for Type 38180 Rectifier Tubes in Model RAL Receivers and Model OD Vacuum Tube Analyzer Equipments," NRL Report 1383, July 1937
  - Navy Department Bulletin of Engineering Information No. 116, July 1940, pp. 29-30
  - Navy Department Radio and Sound Bulletin, NRL Library 605.B75
    - July 1941, pp. 23-29
    - July 1942, pp. 1-12
    - July 1943, p. 22
- 296. D. McClenon and C.E. Young, "Investigation of Radio Receiving Set Model AN/SBR 11 (XN 1) Serial 1," NRL Memo. Rept. 544, Nov. 1955



## Chapter 4

### RADAR

#### ORIGIN OF RADAR

The development of radar by NRL came about through the continuing interest of NRL's staff in solving the problem of detecting and ranging on enemy forces by means of reflected radio energy and through a series of related technological and conceptual advances. As they occurred, these advances sustained NRL's hope in an ultimate solution of the problem, particularly with respect to aircraft, the capability of which was rapidly increasing.

#### FIRST OBJECT DETECTION BY RADIO

While exploring the higher radio frequencies for their communication potential, the Navy's research group which formed the nucleus of NRL's original radio division, prior to the availability of NRL's facilities, discovered that the presence of ships could be detected at ranges up to three miles through the use of reflected radio waves (1922).<sup>1</sup> The system used is the basis of what later became known as "continuous-wave" or "doppler" radar. Observations were made with a receiver located on Haines Point in Washington, D. C., on signals from a 5-meter (60 MHz) transmitter mounted on the top of a radio compass house at the Anacostia Naval Air Station. The transmission path, about one-half mile long, passed across the confluence of the Potomac and Anacostia rivers and the Washington Channel to the receiver. During the experiments, fluctuations in the intensity of the received signal of considerable extent were noted as a ship, the steamer DORCHESTER, a wooden vessel of no great size, passed through

the area about the transmission path. It was realized that these fluctuations, due to the combination and phasing of the direct and reflected waves, would permit the detection of enemy vessels in Naval warfare. Improvements were made in the system, including the use of wavelengths as short as one meter (300 MHz). As a result, ships passing up and down the Potomac River were detected when they were as far away as Alexandria, Virginia, a distance of three miles. The transmitter used a 50-watt tube (type CG-1144-A) driven from a 500-cycle power supply, which provided a good note in the ear-phones at the receiver. The receiver used an N tube detector and two stages of audio amplification. The transmitting and receiving antennas were both vertical.

The possibilities of using this new means for the detection of enemy vessels "irrespective of fog, darkness, or smoke screen," and the increased range which could be secured through the use of parabolic reflector antennas at both transmitter and receiver by concentrating the energy in a sharp beam, were brought to the attention of the Bureau of Engineering; however, interest in sponsoring further work was not effected. The lack of an urgent operational need and the pressure to provide radio-communication facilities adequate for the expanded fleet organization being planned at that time were impediments to this sponsorship.

#### DISTANCE MEASUREMENT WITH REFLECTED RADIO PULSES

The method of determining the distance of a target by measurement of the transit time

RADAR

UNCLASSIFIED

CLASSIFICATION CHANGED TO UNCLASSIFIED BY AUTHORITY OF OP-430/11/2002/2002-01-01 IN 11/2002/192 (DATE) *Thurston Lee Rodde* (NAME) Signature of Custodian

NAVY DEPARTMENT OFFICE OF THE CHIEF OF NAVAL OPERATIONS WASHINGTON

UNCLASSIFIED

*Three photo stats made by Comdr. Stinson for appearing in report of Radar 18 7/10/43*

From: Chief of Naval Operations  
To: Chief of Bureau of Ships  
Chief of Bureau of Aeronautics  
Chief of Bureau of Ordnance  
Director, Naval Research Laboratory  
Chairman, General Board  
Subject: Radio Detection and Ranging Equipment - Security Classification of and Approved Abbreviation for.

1. The type of radio equipment which has been developed under Special Project No. 1 and which has been referred to as "Radio Ranging Equipment", "Radio Detection Equipment", "Radio Echo Equipment", "Pulse Radio Equipment", etc., will hereafter be known as "Radio Detection and Ranging Equipment".

2. The detailed security classification of radio detection and ranging equipment is as follows:

- (a) ~~SECRET~~ - The design of the equipment (other than the parts included in subparagraph (b)), the purpose for which the equipment is designed, and the principles and methods of operation.
- (b) ~~SECRET~~ - Those features which obviously cannot be kept secret, such as the design and installation of the antenna unit with its power elevating and training apparatus, the power supply of the equipment, the inter-connecting cables, and other details which do not disclose the operation of the equipment classified in subparagraph (a).

4. The urgency of delivery of this document is such that it will not reach the addressees in time by the next available officer courier. The originator, therefore, authorizes the transmission of this document by registered mail within the continental limits of the United States.

H. R. STARK

60834 (382)

THIS PAGE IDENTIFICATION PRACTICABLE FROM 00000000000000000000

THE WORD "RADAR"

The word "radar" was coined from "radio detection and ranging," one of the titles used by NRL for this field of work, by LCDR F R Furth and LCDR S M Tucker, who shared in responsibility for the Navy's original procurement program. LCDR Furth (later RADM Furth) and LCDR Tucker (later RADM Tucker), while on duty at the Navy Department, devised the acronym and took action to put it into effect. The above letter, dated 19 Nov. 1940, signed by ADM H R Stark, then the Chief of Naval Operations, made the word official. Later, both LCDR Furth and LCDR Tucker, as Captains, became directors of NRL (CAPT Furth, 1949 to 1952; CAPT Tucker, 1955 to 1956). CAPT Furth became the Chief of Naval Research as ADM Furth (1954 to 1956). The word radar quickly came into general use, although the British retained the terms "radiolocation" and "RDF" for their work in this field until 1943, when "radar" was adopted through international agreement.

of reflected radio pulses over the path was first demonstrated in NRL's early investigations of the height, layer structure, and characteristics of the ionosphere, accomplished cooperatively with the Carnegie Institute in Washington (1925).<sup>2</sup> This pulse method later became the method of determining range in radar. In this ionospheric work, repetitive radio pulses were produced for the first time by the multi-vibrator technique, also used later in radar. The quiet interval between the pulses made possible the reception of the reflected energy without interference. A high-power, crystal-controlled transmitter which had been used for communication experiments was modified to provide 10-kW (peak), 200-microsecond pulses at 4.2 MHz for the transmissions.

The success of this pulse work stimulated NRL's consideration of aircraft detection and ranging by the pulse technique, but evidence of the probability of reflections of adequate intensity from aircraft was insufficient to generate in sponsors support for experimental work to resolve the question. At that time, difficulty in funding the Navy's immediate radio needs and the apparent lack of capability of aircraft to provide a serious threat were attending factors. Nevertheless, the pulse concept continued to receive consideration by NRL. The results of this original pulse work served to stimulate the British in the later initiation of their "RDF" (radio direction finder, their early term for radar) developments, as was disclosed by their representatives during the military technical information exchange meetings held with the United States in 1940.

#### FIRST DETECTION OF AIRCRAFT BY RADIO

While working on the problem of the landing of aircraft, NRL discovered that aircraft reflected sufficient radio energy to be detected at considerable distances (1930).<sup>3</sup> A system was being investigated with which an aircraft could "home" on a vertically directed

transmitting beam located at NRL (32.8 MHz) and determine when it was directly above the beam for landing. Radiations from the beam were being measured at a site about two miles north with directional measurement equipment. It was observed that whenever an aircraft penetrated sufficiently into the radio-frequency field of the beam, and when the relative distance of the aircraft was changing, fluctuations occurred in the indications of the measurement meter and in the signal received in headphones. It was also noted that the rate of the fluctuations varied with the speed of the aircraft. Aircraft could be detected several miles distant from the equipment. This system, in which "beats" were produced by interaction of the direct and aircraft reflected energy, was recognized as being basically the same as that used in 1922. However, it now gave promise of effective detection of aircraft. More suitable equipment was developed (60 MHz), resulting in a capability of detecting aircraft out to a distance of 50 miles.<sup>4</sup> A surveillance system was devised consisting of a network of spaced transmitters and receivers which could provide area detection and position of aircraft. However, these equipments had to be disposed over an extensive area, so the Navy considered the system unsuitable for use by Naval vessels. The system did have application to the defense of large land areas, and since this function was the responsibility of the Army, the results of NRL's work were forwarded to the Army for consideration for further development (1932).<sup>5</sup>

Early in February 1934, a demonstration of the continuous-wave aircraft-detection system was given to members of the Subcommittee on Naval Appropriations of the House of Representatives. This demonstration was arranged through the influence of one of its members (later Chairman), the Honorable James Scrugham (Nevada, later Senator Scrugham), who took great interest in NRL's detection work. Through his efforts a special appropriation (\$100,000 in FY 1935, and more subsequently) was received at a financially critical time, which enabled the Laboratory to continue its work on aircraft detection.<sup>6a</sup>

### ASSOCIATION OF TECHNIQUES FOR RADAR

A step leading immediately to radar was made when, as a result of an investigation, NRL developed an "anti-key-click" device which eliminated interference in radio reception aboard ship caused by clicks (transients) generated when high-frequency transmitters were keyed (1933). In recognizing the merits of this device, the Bureau of Engineering stated that the "...device makes possible materially decreased separation of adjacent Communication Channels...will greatly improve communication..." and "gives our Navy distinct advantage over foreign Navies in Communication efficiency."<sup>7,8,9</sup>

In carrying out its work on "key-click" interference elimination, NRL devised a means of visually observing the key clicks which provided for the first time a repetitive display of radio pulses and their time-displaced counterparts, with indication of displacement time on a cathode-ray tube. The associated transmitter and receiver were synchronized by a common oscillator, all elements being in close proximity (1933). These are concomitant aspects of a radar system! NRL's work brought to focus the several related previous steps and led to a decision to proceed with the development of a pulse-detection system, initiated on 14 March 1934, which resulted in the first radar. The common oscillator used in the key-click investigation provided the drive for circuits producing a circular trace on the cathode-ray-tube screen with pulses displayed as radially displaced "pips." The angle between the originating pulse pip and its counterpart represented the displacement time of the latter. The length and shape of the pulses could be observed directly.

### FIRST RADARS

Since the frequency of 60 MHz was used in the continuous-wave system, its use was continued in the first pulse system. A pulse

transmitter was constructed with two RK-20 tubes (nominal 50 watts CW, Raytheon) in "push-pull," accompanied by a multivibrator and pulse-forming circuits. Low-time-constant elements were designed so that pulses short enough to permit observation and resolution of aircraft at reasonably short range could be generated. Ten-microsecond pulses and a pulse spacing of 100 microseconds were obtained. With the tubes "grid-pulsed" at a 10,000-per-second rate, an average power output of eight watts (80 watts peak power with a 10 percent duty cycle) was secured. An anode voltage considerably higher than the rated value of the tubes was used to obtain this peak power. The system formed included this transmitter, a high-gain ( $7 \times 10^6$ ) experimental receiver, the circular-sweep cathode-ray tube, the synchronizing arrangement just described, and separate directional antennas (a horizontal dipole with parasitic reflector) for both transmitter and receiver, which were directed across the Potomac River. An interconnecting cable spanned the 250 feet between the transmitter and receiver (penthouses of NRL buildings 1 and 12) to provide synchronization. With this 60-MHz system, an aircraft was detected for the first time with radio pulses as it flew up and down the Potomac River; however, range resolution was limited by characteristics of the receiver (December 1934).<sup>100</sup> The receiver used was a modified communication receiver of the super-heterodyne type with a 10-MHz, four-stage intermediate-frequency amplifier. It was modified to further increase its bandwidth for short-pulse amplification and to eliminate "blocking" by the transmitted pulse; these modifications were successfully accomplished. However, the great amplitude of the transmitted pulse caused excessive "ringing" in the receiver, in spite of its wide-bandwidth circuits. The ringing extended the apparent width of the transmitted pulse and greatly reduced range resolution at short ranges.

In the next phase of the work, NRL developed a 28.6-MHz radar with which the first effective detection and accurate ranging with high range resolution at all ranges on

aircraft with radio pulses was accomplished, on 28 April 1936. The first echoes from aircraft (light, fabric-wing craft) were seen at ranges out to ten miles, but by 3 June 1936, after the transmitter anode voltage had been greatly increased, aircraft were observed out to 25 miles. On 26 June, the radar was demonstrated to the Chief of the Bureau of Engineering, RADM H.G. Bowen, the Chief of the Bureau of Aeronautics, RADM A. B. Cook, the Chief of the Bureau of Ordnance, RADM H. R. Stark, two other Admirals, and a group of lower ranking officers. On 1 July, a demonstration was given to the Chief of Naval Operations, ADM W. H. Standley. Demonstrations were also given to key members of the War Department and members of the Army Signal Corps Laboratories (4 June 1936).<sup>11a,12a,13,14</sup>

Since the performance of the earlier equipment was limited in range resolution by the characteristics of the receiver, special attention was given this aspect in the design of this component. Its design was aided by a prior mathematical analysis of multistage radio-frequency amplifiers. The receiver comprised a preselector heterodyne converter and two intermediate amplifiers (three stages at 35 MHz and one stage at 25 MHz), with a useful gain of  $2.5 \times 10^7$ . It responded to pulses of two to five microseconds. This receiver, which was free of feedback and ringing, was capable of withstanding, without blocking, the high input power imposed when closely associated with the pulse transmitter.<sup>10b</sup> The "acorn" type 954 pentode tube (RCA), recently available, providing improved performance at the higher frequencies, was used in the receiver. The output of the receiver was displayed on a cathode-ray-tube screen using a horizontal trace with a 25-mile logarithmic scale. A horizontal dipole with parasitic reflector was used for the receiving antenna. A new type of self-quenching, or "squegging," oscillator was used in the transmitter with a novel inductive storage-capacitive discharge keying circuit. The transmitter used a Gammatron type 354 tube (100 watts, CW, Heintz and

Kaufman) which had just become available and which provided six-microsecond pulses at a peak power of 7 kW and a pulse rate of 3720 per second. A 28.6-MHz horizontally polarized beam antenna (dipole elements stacked six vertically, eight horizontally with corresponding parasitic reflector) supported by two 200-foot towers, available following previous high-frequency-communication experiments, was used for transmission. The transmitter (located at the present site of NRL building 16) and the receiver (located on the penthouse roof of NRL building 12), separated by about 330 yards, were linked by a cable for synchronization by a common oscillator.

The large size of the 28.6-MHz transmitting antenna of the early radar made it impractical for installation aboard ship, so effort was directed to the higher frequencies, where smaller antennas could be effective. A major difficulty in the radar work had been the lack of vacuum tubes operating at the higher frequencies which would give adequate pulse power outputs and withstand the high anode voltage required (10 to 15 kV). It had been necessary to use existing tubes far beyond their rated capability. Operation at 50 MHz was explored, but soon given up in favor of 80 MHz, when it was found that the Gammatron type 354 tube would provide good power output at this frequency. A transmitter was constructed with two of these tubes in a push-pull arrangement with parallel-rod transmission lines for the oscillator circuits. A vertically polarized beam antenna (dipoles stacked six vertically, eight horizontally with corresponding parasitic reflector) was provided. The new 28.6-MHz receiver was modified for use at the 80-MHz frequency. **This 80-MHz equipment was first to use a multiple horizontal line display on the cathode-ray-tube screen for display of echo returns. This display was arranged with five lines, each representing ten miles of range, providing a total available display range of 50 miles. This system was first operated on 5 Nov. 1936, and by 24 Nov. 1936 aircraft out to a range of 38 miles were observed.** The equipment incorporated circuits which allowed one antenna

RADAR

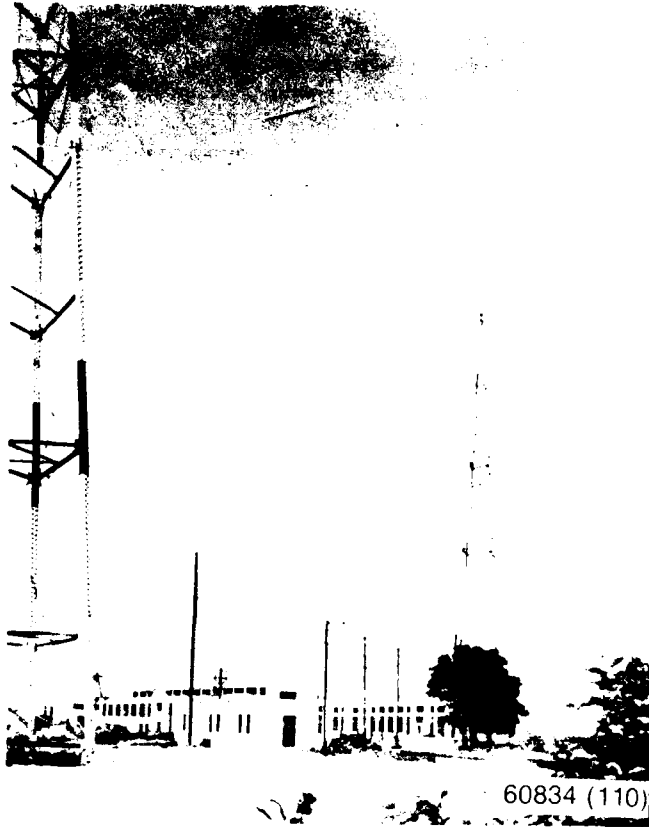

The first detection and high-resolution ranging on aircraft with radio pulses in the United States was accomplished by NRI with this radar on April 28, 1936. The radar used a beam antenna for transmitting (left) and a receiving antenna (below).

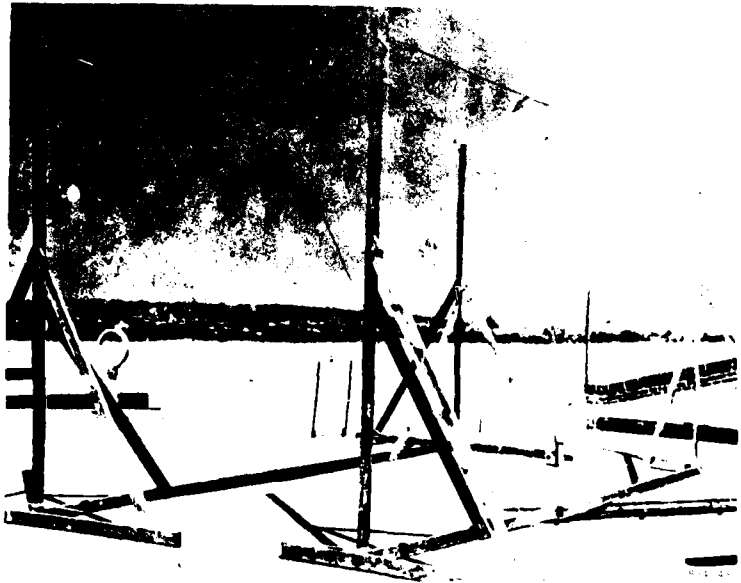

RADAR

In this demonstration, the transmitter operated at 28.6 MHz with 6-microsecond, 7-kilowatt pulses (right); the pulse received (below) used a cathode-ray tube display. Aircraft were observed to a range of 26-25 miles

During June and July 1936, this radar was demonstrated to the Chief of Naval Operations, the Chiefs of the Bureaus of Engineering, Aeronautics, and Ordnance, and to War Department and other officials

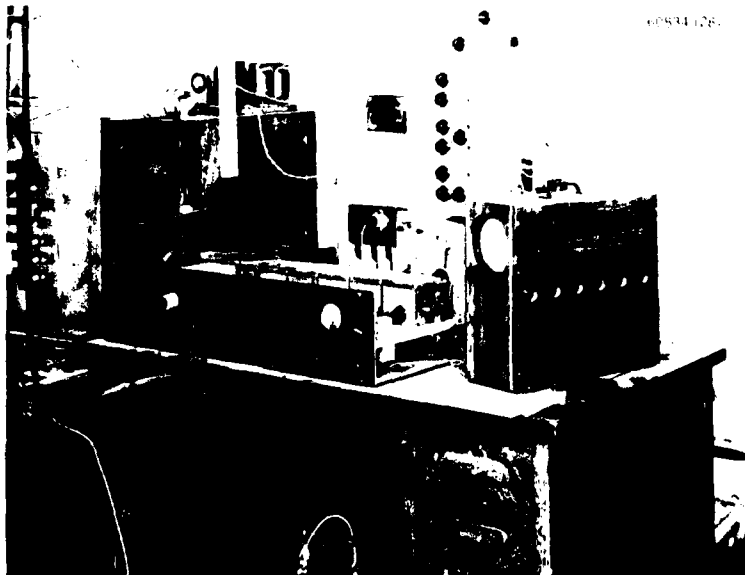
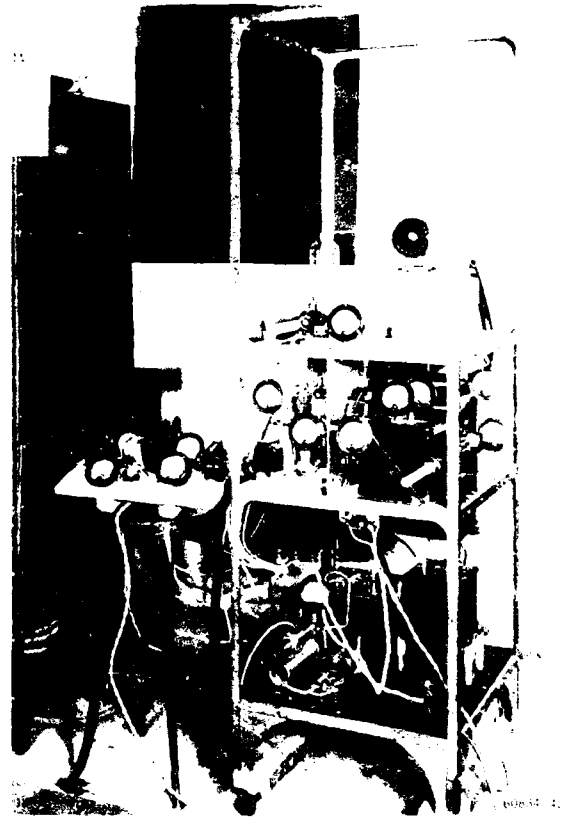

to serve for both transmission and reception, although this was first accomplished with 200-MHz equipment.

Many demonstrations were given with this radar, including one to the Commander-in-Chief, U.S. Fleet, ADM A. J. Hepburn (4 Dec. 1936), who urged RADM H. G. Bowen, the Chief of the Bureau of Engineering, to arrange for an early demonstration and practical test of radar in the Fleet. On 17 Feb. 1937, this radar was also demonstrated to the Chief of Naval Operations, ADM W. D. Leahy, and the Assistant Secretary of the Navy, the Honorable Charles Edison, both recently appointed. Demonstrations were also given to representatives of the Army Signal Corps Laboratories (November 1936), who were urged to use a frequency of about 100 MHz for their radar, for which high-power tubes were available. This became the frequency of their first long-range search radar, the Model SCR 270.<sup>19</sup> It was by means of this radar that the Japanese aircraft were observed when approaching Oahu, Hawaii, in their disastrous attack on Pearl Harbor in 1941—a warning which unfortunately was not heeded. On 13 July 1937, representatives of the Bell Telephone Laboratories were shown the 80-MHz equipment to interest them in engaging in radar work. In view of NRL's progress, they decided their contribution could best be made through improved vacuum tubes. However, later they were willing to undertake work on the early fire-control radars.<sup>11b,12b</sup>

#### 200-MHz RADAR

To further reduce the size of the antenna through the use of smaller dipole elements, the development of a 200-MHz radar was undertaken (8 May 1936). **This NRL equipment was the first radar capable of providing bearings and position of targets (bearing accuracy 2 degrees).** The antenna, of the Yagi type, was arranged so that it could be rotated in azimuth. The transmitter used two type 304 tubes (100 watt, CW, Western Electric) in a push-pull circuit. The receiver, a superheterodyne provided with a preselector and heterodyne con-

verter of concentric transmission-line design, responded to four-microsecond pulses. The first observations with this radar were made on 22 July 1936, and after adjustment aircraft could be observed out to a range of 12 miles.

#### RADAR ANTENNA DUPLEXER

A major step forward in radar was made by NRL with this 200-MHz equipment when, shortly after testing began, the first duplexing circuit, which permitted the use of a common antenna for both transmission and reception, was incorporated (July 1936).<sup>11c</sup> Duplexers are now used by all radars. This 200-MHz radar was also shown to the Chief of Naval Operations and the Assistant Secretary of the Navy during their visit to NRL on 17 Feb. 1937, to indicate the possibilities for size reduction relative to shipboard installations. This circuit comprised a parallel-rod transmission line, one end of which was coupled to the transmitter-tube anodes through capacitors with a shorting bar disposed one-quarter wavelength away. This section of the line was tapped to provide coupling for the antenna. The section beyond the bar was adjustable in length and tapped to provide coupling for the receiver. The introduction of duplexing reduced the antenna structure to one-half size, greatly aiding its practicality and acceptability, particularly aboard ships and aircraft.

The relative effectiveness of horizontal, vertical, and circular polarization of transmitted waves were first studied by NRL with this radar (August 1936). Early observations were also made on the variations in echo intensity due to changes in aircraft attitude.

#### FIRST SHIPBOARD RADAR

The NRL 200-MHz experimental equipment with duplexer became the first radar aboard ship when it was installed on the destroyer USS LEARY (DD 158). During a trip out into the Atlantic, ranges on aircraft out to 20 miles were experienced (April



## RADAR

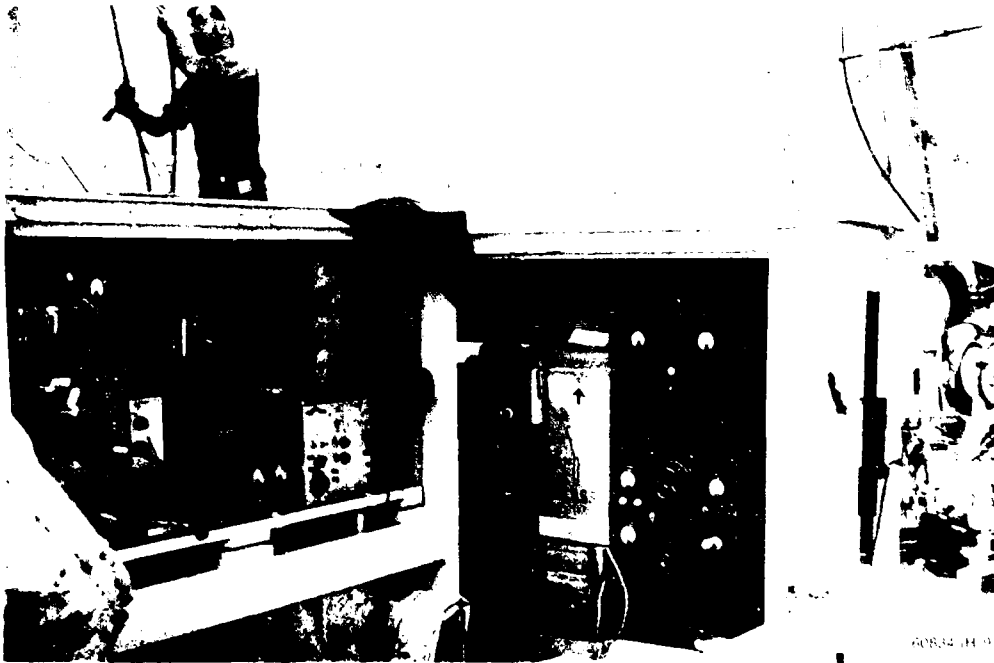
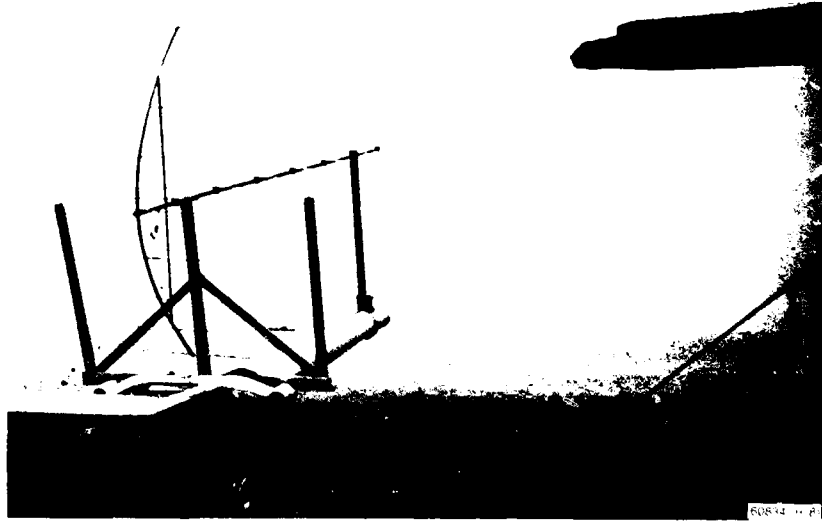

### THE FIRST SHIPBOARD RADAR

An experimental 200-MHz radar was installed on the destroyer USS LEARY, with its antenna mounted on the starboard 5-inch gun to permit training on objects. During a trip out into the Atlantic, aircraft were detected and followed out to a range of 20 miles (April 1937). Sea clutter was first observed with this radar. The antenna (duplexer) was first introduced during the early work on this radar (July 1936). One of the antennas used (Yagi) is shown in the upper photo mounted on the starboard 5-inch gun. The lower photo shows the receiver and indicator (left), and the transmitter and power supply (center).

## RADAR

1937). Sea clutter due to backscatter reflections from ocean waves was discovered on this trip.<sup>11d,12c</sup> The Yagi antenna was mounted on the starboard 5-inch gun for training. (For comparison, on a later trip a curtain type antenna was used.)

### HIGHER PULSE POWER WITH RECEIVER PROTECTION

It was realized that further progress in radar performance would require much higher transmitter power. A "ring" type oscillator was

devised by NRL employing six higher power tubes, then available (type 100TH, Eitel McCullough). This oscillator was capable of providing 15-kW pulses at 200 MHz.<sup>16,17</sup> However, this power level was found to cause injury to the receiver. To avoid injury to the radar receiver, NRL developed an improved duplexer which for the first time employed a "spark gap" in a helium-filled envelope for receiver protection during transmission (1937).<sup>11e,17,18</sup> This gaseous-discharge type of duplexer for switching between transmission and reception was incorporated in

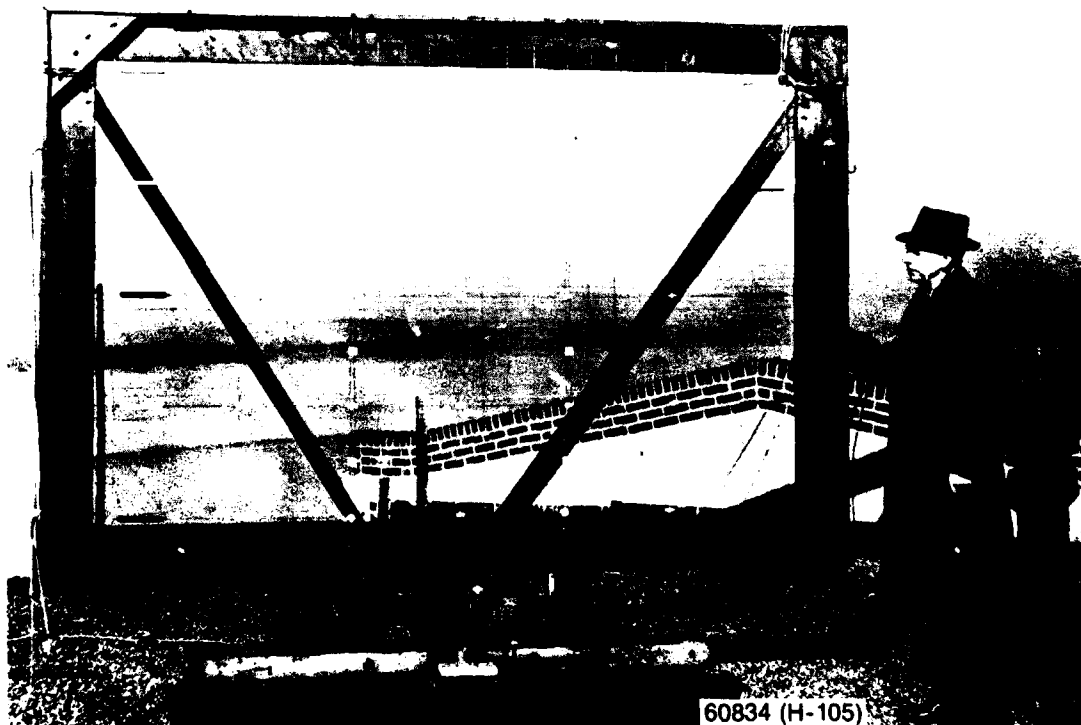

PLANAR ANTENNA USED WITH THE FIRST SHIPBOARD RADAR

This antenna was one of two used for performance comparison with the experimental 200-MHz radar installed on the USS LEARY (April 1937). Dr. Robert M. Page is seen examining his product. Dr. A. Hoyt Taylor, superintendent of NRL's Radio Division at that time and for many years thereafter, stated that Dr. Page "from the outset gave indications of possessing extraordinary ability and fertility of invention. These qualities resulted in his contributing more new ideas to the field of radar than any other one man." Dr. Page's abilities continued to be recognized as he subsequently rose to be the Director of Research of NRL during the period November 1957 to December 1966.

## RADAR

subsequent radars. The spark gap was introduced at a high impedance point in an arrangement of quarter-wave transmission lines. During transmission the gap broke down causing, through reflection, a low-impedance shunt across the terminals of the receiver with little loss in transmitter power. During reception the receiver was connected to the antenna with proper impedance match.

These improvements and others were included in an installation in which both the transmitter and antenna were mounted on the same rotating platform. This 200-MHz radar had the highest pulse power at any frequency attained

at that time. Strong echoes from airplanes at 40 miles were commonplace.<sup>10</sup> The radar "indicates the position of any airplane near or above the horizon at distances out to 60 miles. Bearing indications obtained can be repeated to within less than 30 minutes of arc." This radar was completed on 17 Feb. 1938, and demonstrations were given to many officials during 1938.

### THE FLEET'S FIRST RADAR— MODEL XAF

Considerable Naval operational interest had been aroused by the results the Laboratory

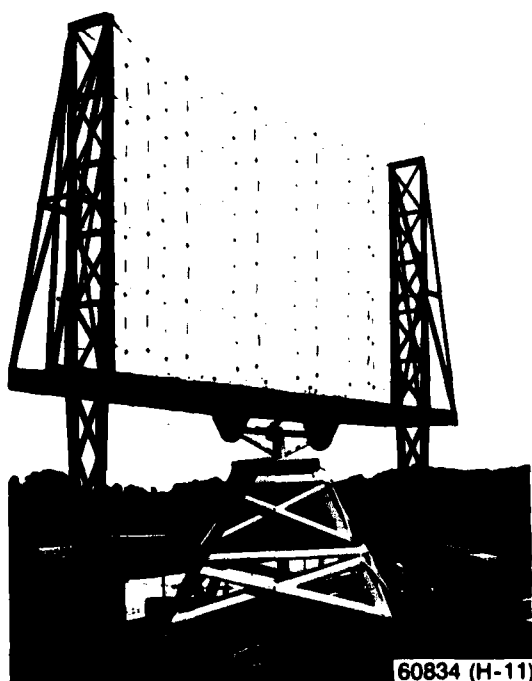

**THE RADAR WHICH WAS FIRST TO HAVE A PULSE POWER AS HIGH AS 15 KILOWATTS (200 MHz)**

This radar was also first to incorporate a duplexer of the gaseous-discharge type for switching between transmission and reception and for protection of the receiver against injury by the high power during transmission (completed February 1938). With this radar, an aircraft near or above the horizon could be observed out to a distance of 60 miles. It was demonstrated to many Navy and Army officials. The antenna is shown here installed on the roof of NRL Building 12. The antenna and the transmitter (located below the antenna, in the penthouse) were mounted integrally with a shaft which extended through the roof. The entire transmitter-receiver system was mounted on a turntable, which as it rotated also turned the antenna; thus permitting bearing as well as range determination on aircraft.

## RADAR

had obtained in its experimental work with radar. The Commander-in-Chief of the U.S. Fleet had requested that "Radio Detection and Ranging equipment" be provided the Fleet. In response, a conference was held to consider the matter in February 1938, at the Bureau of Engineering. The conference was attended by representatives of the Chief of Naval Operations and the Bureaus of Ordnance, Aeronautics, and Construction and Repair. The deliberations of

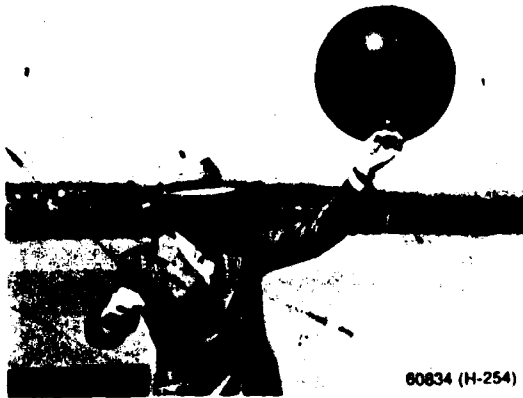

60834 (H-254)

### WEATHER DATA OBTAINED BY RADAR

The collection of weather data through radar tracking of balloon-borne reflectors was first accomplished by NRL (1938). Wind direction and velocity were determined out to a range of 30 miles. This method of obtaining weather data with radar is used worldwide today. L. C. Young is shown releasing one of the balloon-borne reflectors. Mr. Young contributed many important new ideas in radio-electronics during his long and fruitful Naval scientific career (1917-1967). He and Dr. A. Hoyt Taylor were first to detect the presence of ships with radio waves (1922). He was involved in the first detection of aircraft with radio waves (1930). While working on the problem of eliminating key-clicks in high-frequency transmitters, observing the very short pulses generated, he became convinced of the feasibility of using reflected radio pulses to detect and range on aircraft. His persistence in convincing the Superintendent of the Radio Division, Dr. A. Hoyt Taylor, of the high probability of success led to the beginning of radar work. It was through his guidance and collaboration with Dr. R. M. Page in carrying out the work that radar became a reality.

this conference resulted in a decision to install a seagoing model of radar on board a major ship at the earliest possible date.<sup>20</sup> In implementing this decision, the Bureau of Engineering allocated \$25,000 to the Laboratory to provide the equipment; this work was accomplished without cost over-run.

Beginning in March 1938, NRL developed the first radar to be used in Fleet exercises. This radar, designated the Model XAF and installed on the USS NEW YORK in December 1938, demonstrated conclusively to the Navy the capability and importance of radar in Naval operations at sea during Fleet exercises held in Caribbean waters in February and March 1939. In his report on the results of the Fleet exercises, the Commander of the Atlantic Squadron, ADM A. W. Johnson, recommended that the Navy proceed immediately with extensive installation of such equipment in the Fleet and stated, "The XAF equipment is one of the most important military developments since the advent of radio itself. Its value as a defensive instrument of war and as an instrument for the avoidance of collisions at sea justifies the Navy's unlimited development of the equipment."<sup>21</sup> The demonstration resulted in the initiation of what became an extensive radar procurement program which has continued to the present day. In these exercises, involving approximately 80 ships, the Model XAF well proved its capability for air and surface detection, navigation, spotting the fall of shot, and the tracking of projectiles in flight.<sup>22</sup> Aircraft were detected out to a range of 100 nautical miles; surface ships out to 15 nautical miles; 14-inch shells in flight and fall-of-shot splashes at 7 nautical miles; navigational buoys at 4 nautical miles; mountains at 70 nautical miles; and birds in flight at 5-1/2 nautical miles. The equipment incorporated the latest NRL techniques, plus appurtenances necessary for shipboard operation, and provided 200-MHz, 15-kW, 5-microsecond pulses. The installation of its rather large planar 17 by 17 foot antenna (20.5 by 23.5 feet overall) caused considerable consternation,

## RADAR

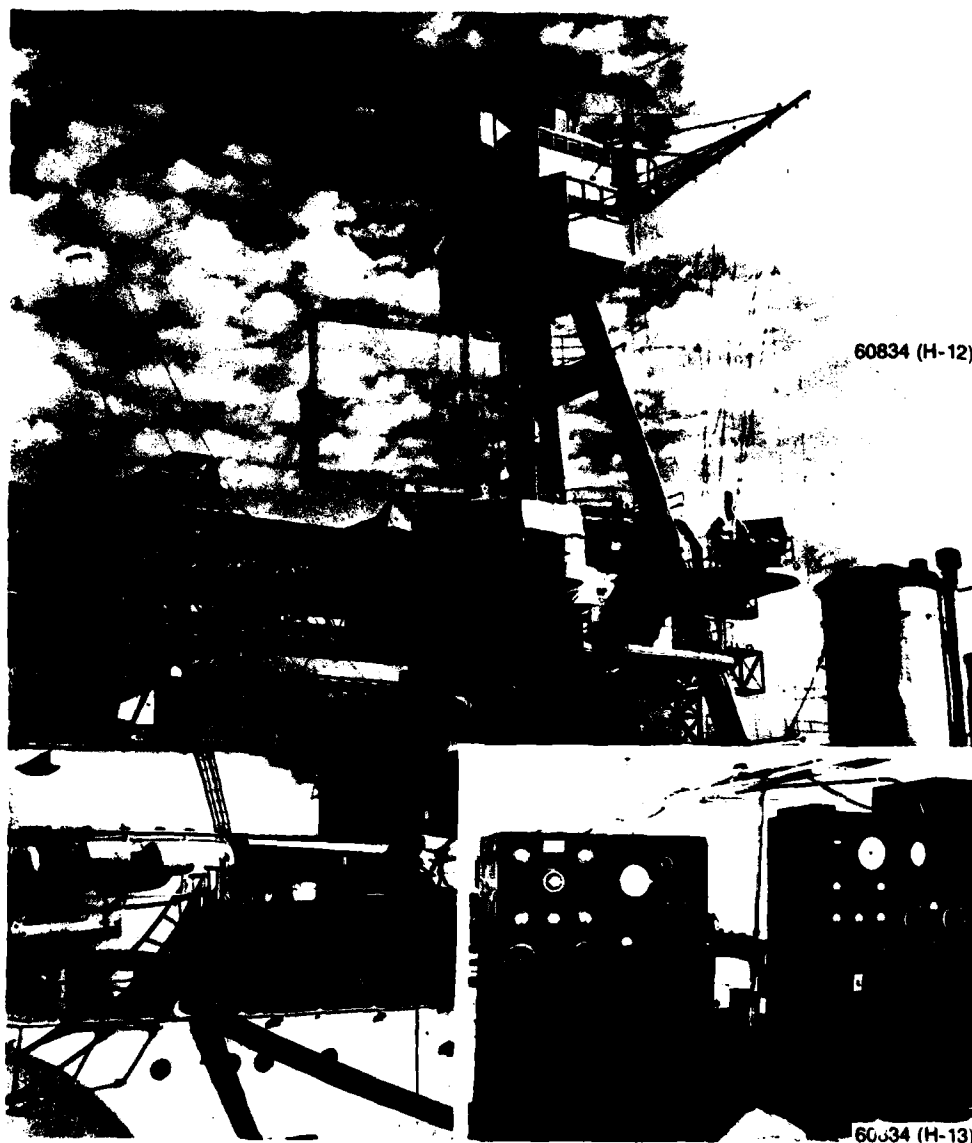

### FIRST RADAR USED IN FLEET OPERATIONS

The Model XAF radar, developed by NRL (1938) and installed on the battleship USS NEW YORK, demonstrated the capability and importance of radar in operations at sea during the Fleet exercises held in Caribbean waters early in 1939. In recommending that the Navy proceed with extensive installations of such equipment in the Fleet, the Commander of the Atlantic Squadron stated, "The XAF equipment is one of the most important military developments since the advent of radio itself. Its value as a defensive instrument of war and as an instrument for the avoidance of collisions at sea justifies the Navy's unlimited development of the equipment." The equipment comprised the antenna (above) and the transceiver (on left in insert). The Model CXAM radar (on right in insert), closely patterned after the XAF, was the radar with which the Navy entered World War II (20 procured, RCA).

RADAR



FULL POWER AND SENSITIVITY OVER WATER  
IN ECARDS



PEAKS RISE ON SECOND LINE



SECOND TIME AROUND ECHO  
5000 FT FORMATION AT 65 MI. (MUT.)



PEAKS RISE ON SECOND LINE  
AIRPLANE ON FIRST LINE AT 15 MI.



CLOSE FORMATION 80 MI COLUMN  
& SAILS 1000 YARDS AHEAD



PEAKS RISE WITH PEAKS AT 60 MI.

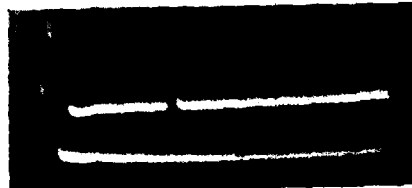

SAME FORMATION AT 1000 YARDS  
TELRS AT 1000 YARDS  
RAF TRAINED ON FORMATION



HIGHER INT. PEAKS ON FIRST LINE  
PEAKS RISE ON SECOND LINE

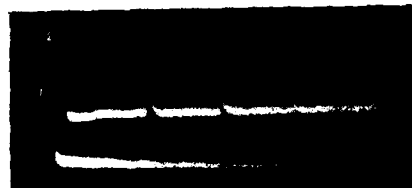

SAME FORMATION AT 5000 YARDS  
TELRS AT 1000 YARDS  
RAF TRAINED ON TELRS



SAME AT GREATER RANGE  
ONE PEAK SHOWING SECOND TIME AROUND

60834 (383)

MODEL XAF RADAR SIGNAL RETURNS

The Model XAF radar "scope" photos shown here are records of observations made with equipment installed on the USS NEW YORK during the Atlantic Fleet exercises in southern waters held in February 1939. Target range increases from left to right on the upper line and continues right to left on the lower line. Total range for one time around is 50 miles.

which disappeared when the military value of the equipment was proven.

### SEARCH RADARS FOR WORLD WAR II

The success of the Model XAF gave rise to widespread interest in radar in the Navy. NRL's Model XAF served as a prototype for the beginning of a long line of radars. Its transmission frequency (200 MHz) proved to be an excellent choice for long-range aircraft search. The frequency range employed served the aircraft search function well for many years. Upon the receipt of the Fleet reports in May 1938, the Office of the Chief of Naval Operations held a conference, with representation from the several cognizant Bureaus and NRL, to consider the initiation of radar procurement. In view of the exigencies of the international situation at that time, emphasis was placed on obtaining "Chinese copies" of the Model XAF.<sup>23</sup> A contract was given to RCA to produce this equipment under NRL guidance. Twenty of these radars, designate Model CXAM, were produced. Installations were made on the battleships USS CALIFORNIA, TEXAS, PENNSYLVANIA, WEST VIRGINIA, NORTH CAROLINA, and WASHINGTON, on the aircraft carriers USS YORKTOWN, LEXINGTON, SARATOGA, RANGER, ENTERPRISE, and WASP, on the heavy cruisers USS NORTHHAMPTON, PENSACOLA, CHESTER, CHICAGO, and AUGUSTA, on the light cruisers ALBEMARLE and CINCINNATI, and on the seaplane tender USS CURTIS. The installation of nearly all of these radars was completed by the beginning of U.S. entry into World War II.<sup>24</sup> The Model CXAM radar had an excellent reputation, and every one that did not go down in action received an honorable discharge after long and dependable service. In regard to NRL's original development of radar and subsequent follow-through, Fleet Admiral Ernest J. King, Commander in Chief, United States Fleet, and Chief of Naval Operations, in his final report on the war to the Secretary of the Navy, citing NRL's

achievements, stated "Because of this, at the outset of the war, our Navy alone has on its ships a search radar specifically designed for shipboard use. We had already incorporated in these radars the technical development of using a single antenna for transmission and reception. Radars of this type contributed to the victories of the Coral Sea, Midway, and Guadalcanal" (1945).<sup>25</sup>

By the end of 1941 radar had become a proved naval weapon. In the meantime, the Navy had been eager to obtain increased aircraft detection range with reduction in antenna size, especially for installations on the smaller ships. In furtherance of these objectives NRL developed the Model XAR radar, which provided a twenty-fold increase in available transmitter power and an 11-dB gain in receiver sensitivity. The receiver was the first to have an antijam capability (1941-1942).<sup>26</sup> The XAR radar served as a prototype for the Models SA, SC-1, and SK radars (200 MHz). The last, with a larger antenna, was the Fleet's first radar to provide a detection range of 150 miles on average size aircraft.<sup>27</sup> The transmitter power level (330 kW at 200 MHz) was obtained through use of a new oscillator with a tube specially designed for pulse operation at the Laboratory's request (Type 327-A by Eitel-McCullough). The increase in receiver sensitivity was due principally to a new low-noise tube called Lighthouse, provided NRL by the General Electric Company. The performance of the Model XAR was demonstrated in an installation on the destroyer USS SEMMES (July 1941). These operational radars, produced under NRL's guidance, were the first to be installed on Navy ships in quite large numbers (1942-1945). Four hundred of the Model SC-1 were obtained. The Models SA (RCA) and SC-1 (General Electric Co.), with a 15 by 4 foot high planar array antenna, were installed on the smaller ships (destroyers). The Model SK (General Electric Co.), with a 15 by 15 foot planar type antenna, later a 15-foot-diameter paraboloid, was placed on the larger ships. During

RADAR

60834 (H-384)

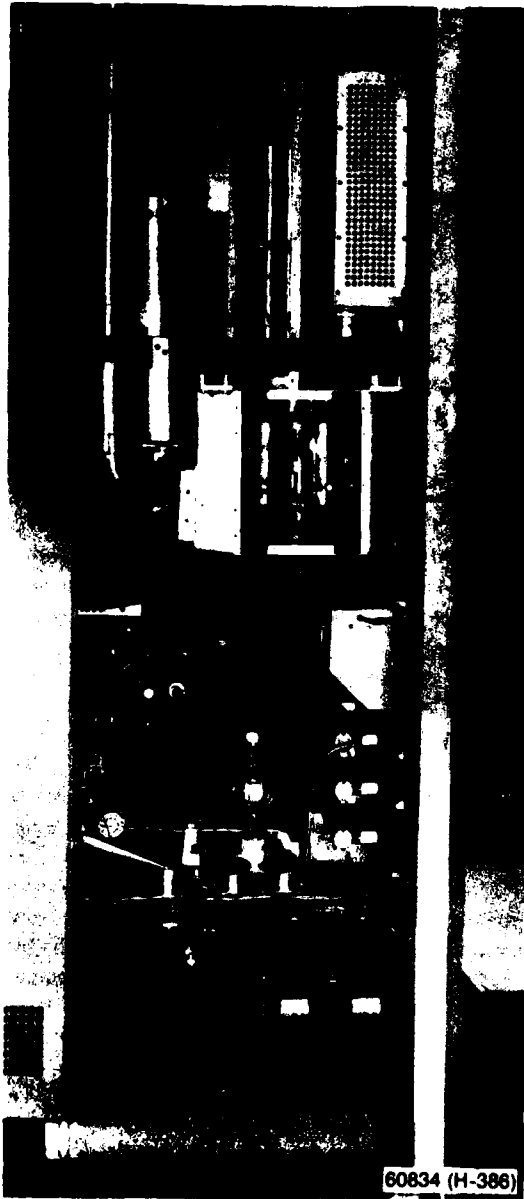
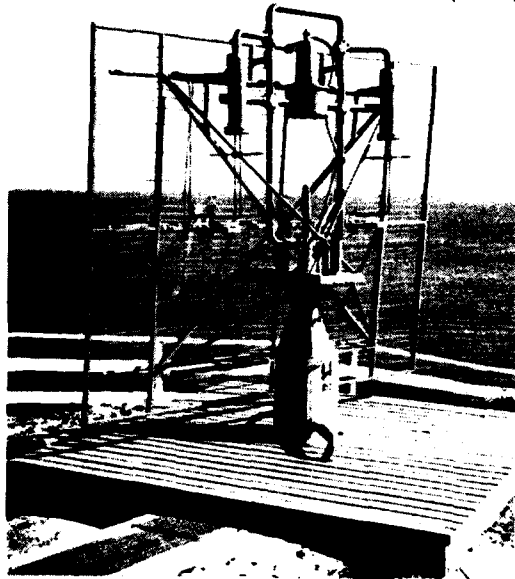

60834 (H-386)

60834 (H-385)

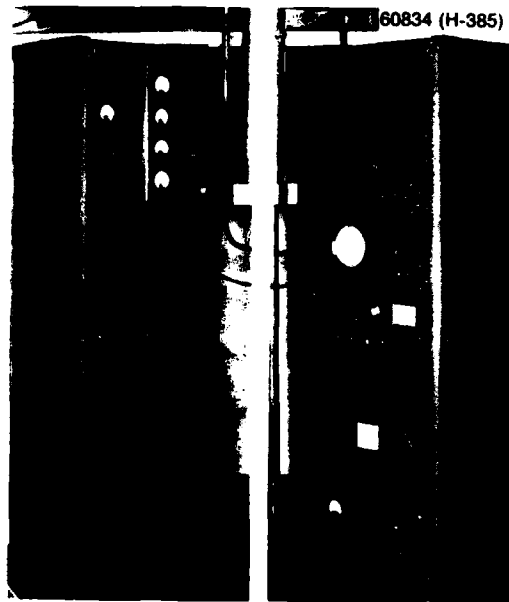

THE MODEL XAR RADAR

This NRL-developed radar provided a twenty-fold increase in available transmitter power and an 11-dB gain in receiver sensitivity (1941, 1942). The receiver was the first to have an antijam capability. The radar served as a prototype for large-scale procurement of search radars. The antenna is shown at the upper right, the transceiver at the lower right, and the interior details of the transmitter on the left.



## RADAR

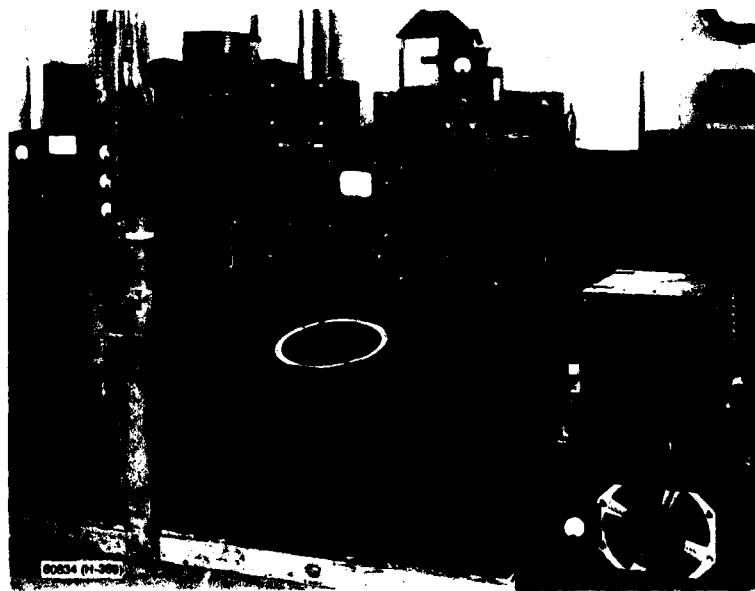
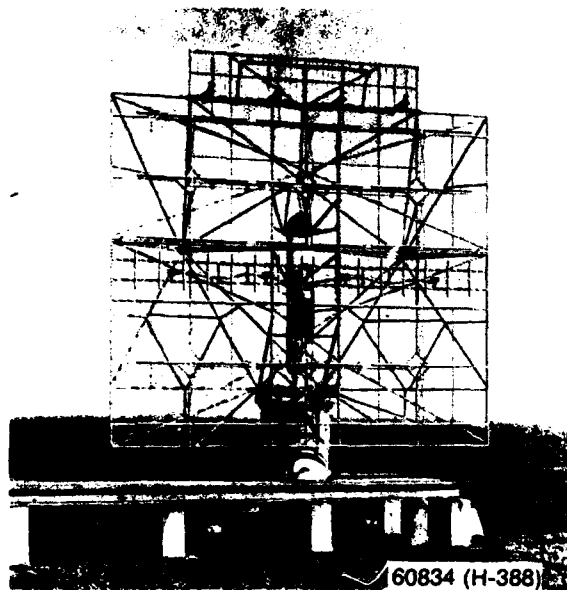

### THE FIRST SEARCH RADARS PROCURED IN LARGE NUMBERS TO OUTFIT THE FLEET, THE MODELS SC AND SK

The design of these radars was based on a prototype developed by NRL during 1941 and 1942, the Model XAR radar. They used the same transceiver (lower), with a smaller antenna for the Model SC (upper left), and a larger antenna for the Model SK (upper right). The Model SK was the Fleet's first radar to provide a detection range of 150 miles on average-size aircraft. The IFF antennas can be seen as vertical dipoles at the top of the antennas.

## RADAR

the war these equipments became widely used in convoy work in the Atlantic, their installation being eagerly sought by skippers to allow full-speed operation in bad weather and for general navigation. They saw extensive service in the Pacific, particularly for air surveillance of enemy aircraft.

To provide greater aircraft detection range through higher power, NRL developed the first one-megawatt pulse transmitter (200 MHz) (December 1941).<sup>29</sup> This was a 12-tube ring-type oscillator using the type 327-A tube employed in the Model XAR radar. Subsequently, the Navy desired to "standardize" its radar equipment and requested NRL to proceed with the development of a series of higher power radars operating at successively higher frequencies.

In proceeding with the first of the series, NRL developed the Model XBF search radar for shipboard operation (500 kW, 200 MHz; 1943).<sup>30</sup> This equipment became the prototype for the first of a series of radars designated the Model SR, which became available to the Fleet in 1944, in plenty of time to give a good account of itself in battle in the Pacific during the latter part of the war. Three hundred of the Model SR radars were procured.

In proceeding to operation at higher frequencies to reduce antenna size, NRL in 1938 developed a 450-MHz radar system; however, this system lacked sufficient transmitter pulse power to give acceptable aircraft detection range. By the summer of 1941, through sponsorship of tube developments, an adequate power level was attained. Thereafter, NRL developed the Model XBF-1 radar (600 kW, 400 to 425 MHz), which initiated the utilization of successively higher frequencies for "operational" radars with smaller antennas. The Model XBF-1 served as a prototype for the Model SR-1 radar (1944).<sup>30</sup> Before many Model SR-1 radars were obtained, the operating frequency was changed to 600 MHz and the designation altered to the Model SR-2. Over 200 were produced, beginning in July 1945. The Model SR-3 was a step to still higher frequency

(1250 to 1350 MHz); however, only 27 were procured, since its antenna proved too large for the smaller ships for which the radar was intended (December 1945). Redesignated as a lightweight system, the radar became the Model SR-6 (1250 to 1350 MHz), of which 60 were obtained, beginning July 1946. The Model SR-3 and SR-6 radar antennas had been designed for high-angle observation to contend with Kamikazi attack by Japanese aircraft. NRL redesigned the antenna system to provide improved long-range search performance, and the equipment was then designated the Model AN/SPS-6 radar, of which over 200 were procured beginning in 1950. The Models SR-3 and SR-6 were backfitted with the new antenna.

### SUBMARINE SEARCH RADAR

NRL developed the first submarine radar, to provide protection against enemy search and attack aircraft (1940-1941).<sup>30, 124, 26, 31</sup> This radar became quite popular with submarine skippers and was installed in submarines as fast as the rate of production allowed. Over 400 were produced. The radar was still in use at the end of the war. NRL's model, designated the Model XAS, was installed on the submarine USS GAR in June 1941, where its capability was successfully demonstrated. It was the prototype for the Model SD radar when procured (140 kW pulse, 114 MHz) (1941). The antenna of the radar was mounted on a retractable mast so it could be quickly lowered to avoid approaching aircraft. Since the antenna was omnidirectional, warning was given of aircraft approaching from any direction. Aircraft could be detected by the radar out to a range of 20 miles, at that time considered adequate to allow the submarine to submerge. The availability of target identification (IFF) was limited during the early stages of the war, so there was danger, not alone from enemy aircraft, but also from our own. During the war the Japanese developed an aircraft intercept receiver which enabled them to home on our submarines using the Model SD transmissions, causing the loss of some of

them. To counter this difficulty, NRL developed a keying technique so that a "quick look" could be taken without excessive hazard.

#### **SUPER-HIGH FREQUENCY (MICROWAVE) SEARCH RADARS**

During NRL's early development of radar, it was apparent that shipboard and airborne installation limitations would require operation at super-high frequencies if full utilization of the potentialities of radar were to be attained. However, that perennial impediment to the use of higher and higher frequencies, the generation of high transmitter power, had to be overcome. These frequencies would make available tighter antenna beams, resulting in sharper definition in the display of objects, with smaller antennas of higher power gain. In seeking an adequate transmitter power source at these frequencies, NRL developed magnetron tubes giving power levels up to 50 watts (7 to 40 centimeters, 4285 to 750 MHz) (1936).<sup>32</sup> The Laboratory was successful in devising means for pulsing the magnetron. NRL developed equipment employing one of these magnetrons which was first to detect and range at a frequency as high as 3000 MHz (10 centimeters, S band) on ships passing NRL on the Potomac River (1936).<sup>6c,33</sup> In this work, NRL employed modulated continuous waves, the phase difference between the energy received relative to that transmitted at the modulation frequency (30 kHz) providing the range. Two 24-inch-diameter parabolic antennas were used, one for transmission, and the other for reception. With a similar equipment, NRL was first to detect and range at frequencies as high as 1200 MHz on aircraft. Buildings and steel towers were also observed. This equipment utilized two 40-inch-diameter parabolic antennas. The range was limited to about four miles. Observations were also made on targets with this equipment installed on the destroyer USS LEARY (1937). The observational range capability of these equipments was so limited as to be of little operational utility. Much higher transmitter power was

needed, and its lack continued to be an impediment to effective radar performance at the super-high frequencies until September 1940. At this time, meetings were held with members of the British Mission under Sir Henry T. Tizard which resulted in an interchange of technical information in furtherance of the war effort. The British received information on NRL's radar duplexer, and in exchange the United States was given information on the British multicavity magnetron capable of producing 10-kW pulses of short duration at 3000 MHz. In 1940, the Radiation Laboratory came into being under the newly established National Defense Research Committee and proceeded to engage in radar work based on the British magnetron development. The Radiation Laboratory and NRL cooperated in providing necessary technical information and guidance to a Navy contractor (Raytheon) to produce the first effective S-band shipboard radar available in quantities, the Model SG, which utilized the multicavity type magnetron (50kW, 1.3 to 2 microsecond pulse, 3000 MHz).<sup>34</sup> This radar saw extensive wartime service, principally in the Pacific theater. Nearly 1000 Model SG radars were produced during the war (1942-1943). Many remained in service over a period of nearly two decades. The Model SG, primarily a surface search radar, was designed for installation on destroyers and larger ships. It provided greatly improved surface coverage out to horizon distances as compared with lower frequency radars, and gave better performance against surface targets and low-flying aircraft. As a navigation aid at short range, it was also superior to the lower frequency radars, making possible the sighting of buoys and shore lines in passing through narrow channels under bad weather conditions or darkness.

NRL also participated in the development of a series of S-band radars procured during the war, having characteristics necessary to serve the special needs of several classes of Navy ships. This series included the Models SE, SF, SH, SJ, SL, SM, SN, SO, SP, SQ, and SV.<sup>35</sup> NRL contributions included tunability of magnetrons,

## RADAR

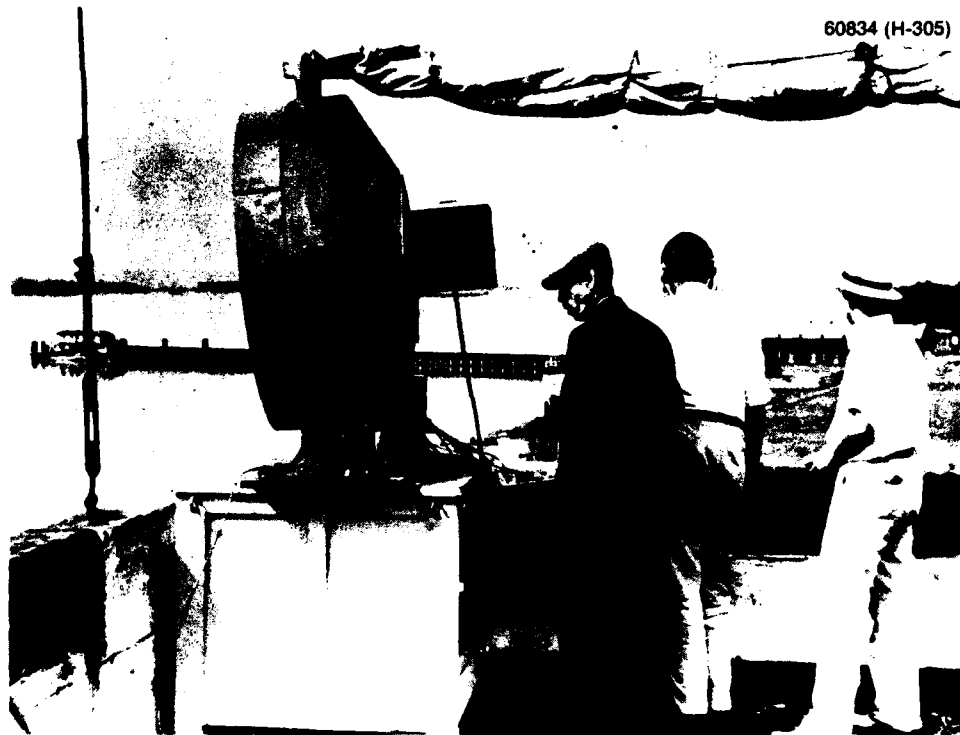

**FIRST DETECTION AND RANGING ON AIRCRAFT AT FREQUENCIES AS HIGH AS 1200 MHZ (1937).**

This system used a magnetron operating on modulated continuous waves, the phase difference between the modulation frequency transmitted and that received providing the range. Two 40-inch-diameter parabolic antennas were used, one for transmitting and the other for receiving. Only one of the antennas is shown in this photograph, as it was when installed on top of NRL Building 1. Observations on targets were also made with the equipment installed on the destroyer USS LEARY. With similar equipment employing two 24-inch parabolic antennas, detection and ranging on ships passing NRL on the Potomac River was accomplished for the first time at a frequency as high as 3000 MHz (1936). Shown left to right are Dr. A. Hoyt Taylor, Dr. C. E. Cleeton, and Dr. J. P. Hagen. Later, Dr. Hagen became Director of the Vanguard satellite project.

modulators, the pulse transformer, switching tubes, diode detectors, system arrangements, and influence on design to insure reliability.<sup>36</sup> The Models SF (1655 procured) and SO were light-weight radars for the smaller vessels such as PT boats and minesweepers. NRL contributed to the development of the Model SO shipboard radar, which involved the largest procurement of any shipborne radar (6300). It took part in landings in Norway and in all amphibious landings in the Pacific which used radar aids,

from the campaign in the Marshalls to Okinawa. For submarines, the Model SJ (170 procured) followed the lower frequency Model SD and provided, in addition, target position through a rotating antenna, necessary in torpedo control. With this radar our submarines were able to make night torpedo attacks of deadly effectiveness and also to make use of wolfpack techniques. The SV radar (165 procured), initiated by NRL, provided for submarines an air-search capability in addition to surface search

## RADAR

60834 (H-214)



**THE FIRST OPERATIONAL MICROWAVE RADAR, THE MODEL SG (1942)**

The Model SG radar, in the development of which NRL participated, is shown on a platform at NRL's Chesapeake Bay site. This model radar was extensively used during the latter part of World War II and remained in service during a period of nearly two decades. Only the antenna of the radar is shown.

and permitted these functions to be conducted while submerged (1945). The Model SL (1209 procured) was used on small ships. The Models SN (776 procured) and SQ (710 procured) were for landing craft and for portable emergency use. The Models SM (49 procured, 1943) and SP (200 procured, 1944), 700 kW, 1 to 5 microsecond pulse, were the first fighter aircraft direction and general search radars with three-dimensional coverage. Of the 49 procured of the Model SM, 26 were received by the British. The Model SU radar, operating at higher frequencies, was the first X-band (9000 MHz, 50 kW, 1/4 to 1 microsecond) surface search shipborne radar (896 procured, 1944). Its development was initiated as a result of the Japanese acquiring a capability to intercept S-band signals. Its performance was limited by the lower power available at the high frequency. The S-band radars were found to give

surface-search performance superior to the lower frequency radars at ranges out to the horizon. They saw widespread service during the war, some remaining in service for a decade and a half after its termination.

### POSTWAR SHIPBOARD SEARCH RADARS

During the latter part of the war it had become possible to generate high transmitter pulse power at the higher frequencies. This development made it feasible to raise the frequency of Naval primary air-search radars from the 200-MHz to the 1300-MHz region, to secure the advantage of better resolution of closely spaced targets provided by the sharper antenna beams available. In 1945, NRL made a study to determine the optimum frequency for shipboard radars, giving consideration to the several system parameters involved.<sup>37</sup> It concluded the maximum performance centered broadly in the 1300-MHz region. The results of the NRL study of the optimum frequency for shipboard radar provided the basis for proceeding with the development of the world's most powerful radar. This radar for the first time provided three-dimensional capability for the interception of enemy aircraft and missiles encompassing 300 miles in range and 100,000 feet in altitude (Model AN/SPS-2, 7 megawatts, 1300 MHz, 1946-1954).<sup>38</sup> NRL provided critical components for this radar, including the first stacked-beam antenna system and an electronic computer-display system for target height determination. The AN/SPS-2 radar was installed on the USS NORTHAMPTON, a modified cruiser, which had been especially designed as a Command Ship (CC-1) to provide high command with all the facilities and accommodations necessary to carry out its functions. Later, the ship became the Navy's first National Emergency Command Post Afloat, intended to provide facilities for the President of the United States in the event of nuclear attack. The Air Force procured (General Electric Co.) about 30 of these radars modified for ground

## RADAR

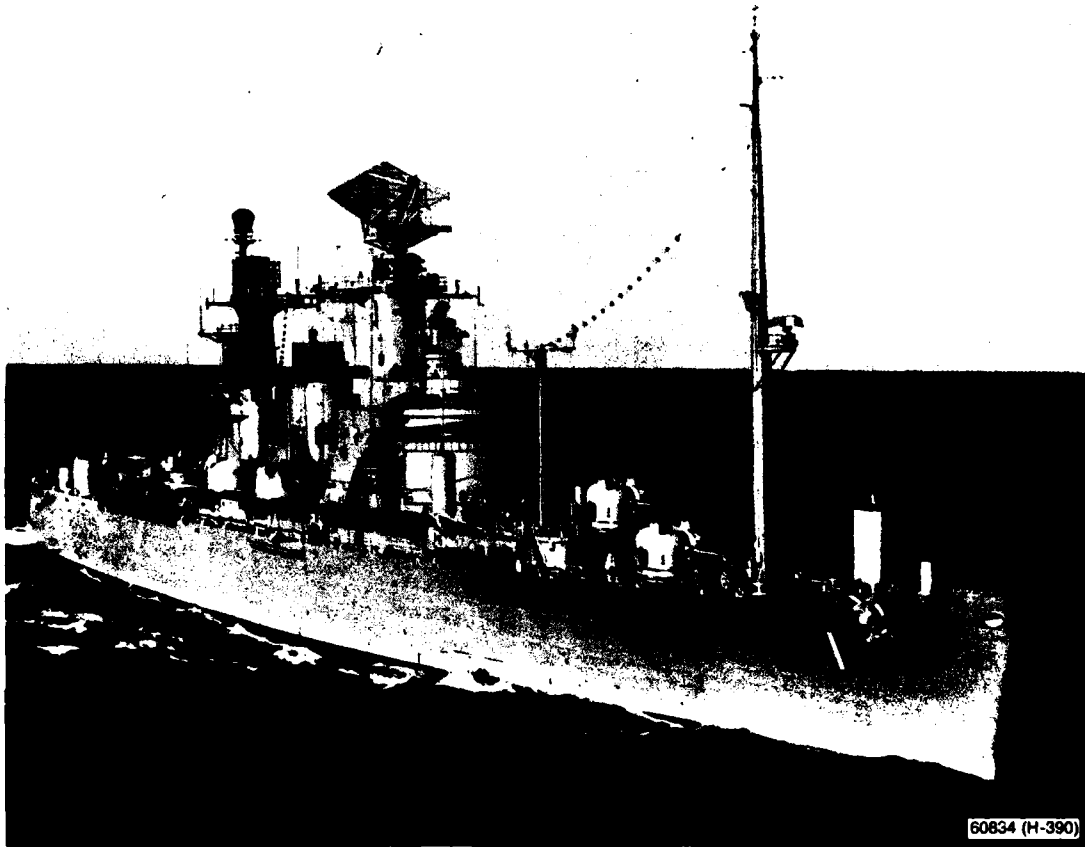

### THE WORLD'S MOST POWERFUL RADAR, THE MODEL SPS-2 (1953)

The antenna of this radar is seen atop the center tower of the *USS NORTHAMPTON (CLC-1)*, the Navy's first ship especially designed to provide facilities for high command. NRL provided critical components for this radar.

installation and designated the Model AN/FPS-7. These radars were widely accepted and saw service in the Continental Air Defense System. The stacked-beam type of antenna system has been used in a series of radars procured by the Navy, Marine Corps, and Air Force. The Navy found radars in the 1300-MHz band to be eminently useful and used equipment of this kind for many years.

In the development of the AN/SPS-2 radar, NRL worked cooperatively with the contractor (General Electric Co.). The antenna comprised seven vertically stacked beams arranged to be utilized individually for reception and collec-

tively for transmission. Comparison by the computer of the intensity of the signals received on the individual beams provided the altitude information. Position information was obtained through a "peak selector" which accepted the strongest signal produced by any one of the several beams for display and utilization.

### LOWER FREQUENCY RADARS

After the war, commercial interests brought great pressure on the Federal Communications

Commission for the assignment of the frequency channels in the 200-MHz and 400-MHz bands, principally for television. The Laboratory made strong recommendations that the Navy retain these bands, since experience had proven their ability to provide good aircraft detection over long ranges, with equipment of low cost. This capability is of consequence relative to the many installations on smaller ships. Furthermore, echo returns from aircraft were relatively stronger at the lower than at the higher frequencies. Notwithstanding the Laboratory's recommendations, the Navy relinquished these lower bands; it was thought that the bands of 1300 MHz and higher would provide adequately for requirements, and with smaller antennas. During 1949 and 1950, Fleet investigations indicated that at times the 1300-MHz radars failed to detect aircraft targets at high altitude, whereas the 200-MHz radars functioned satisfactorily. It appeared that the presence of certain meteorological conditions caused "trapping," or confinement, of the transmitted and reflected energy to lower altitudes at the higher frequency but not at the lower. A presidential Science Advisory Committee considered the frequency-assignment problem and recommended a diversity of frequency assignments for radar. These and other considerations resulted in the Navy's reacquisition of the 200-MHz and 400-MHz frequency bands for radar (1956).

To further the utilization of the lower frequencies, particularly for low-cost installations on smaller ships, NRL carried out basic studies which resulted in the development of the AN/SPS-17 radar (1950-1956).<sup>39</sup> This radar (200 MHz, 1.5 megawatts) proved capable of detecting small jet-fighter aircraft with high reliability at essentially horizon ranges and in excess of 200 miles for aircraft at sufficient altitude. NRL's work resulted in large-scale procurement of a series of radars based upon its design. This series of radars was used on a variety of ship classes, with the larger antennas used on the heavier

classes of ships. The first procurement of 22 radars was from the General Electric Co. The performance of the AN/SPS-17 was favored by the high transmitter power, low incidence of sea clutter, and increased energy reflected from aircraft at the lower frequencies. NRL furnished critical components of advanced design for this radar, including an antenna duplexer, low-noise receiver, modulator, and performance monitor. The radar proved reliable in operation and relatively low in cost. It was followed by a series of radars of the same general design, including the AN/SPS-29 (1958, 89 procured), AN/SPS-37 (1960, 46 procured), and the AN/SPS-43 (1961, 49 procured). Another version of the AN/SPS-17 was developed which operated in the 400-MHz band. This was followed by the AN/SPS-31, a developmental model, and the AN/SPS-40 series of radars, of which a large number were procured.

#### MICROWAVE SEARCH-FIGHTER AIRCRAFT DIRECTION RADAR

The Model SM and SP radars were limited in their fighter-direction capability, since only one aircraft at a time could be observed. This limitation required switching back and forth between our own and enemy aircraft to bring about interception. For three-dimensional information, these radars used a conical scanning arrangement which, while providing both azimuth and elevation data simultaneously, permitted observation only over a small solid angle (2 degrees). At the end of the War, NRL participated in the development of the Model SX radar which for the first time provided an aircraft-interception capacity limited only by the number of intercept operator displays that could be accommodated aboard ship. This radar (S band, 1000 kW, 1-microsecond pulse width), with some modification in subsequent models, was used extensively in the Fleet.

## RADAR



22751

### MODEL SX RADAR

This radar was first to provide an aircraft interception capability limited only by the number of intercept operator displays that could be accommodated aboard ship. NRL participated in its development (1945). The antenna system comprises the element on the left for early warning and the element on the right for height finding. The central structure behind and above the antenna elements contains the transceivers for both elements, which operate on separate frequencies. The transceiver structure rotates with the antenna elements, thus avoiding the loss in rotary radio-frequency joints.



Forty five were procured (1945).<sup>36,40</sup> With some action-phase displacement, one intercept operator could easily handle two interceptions simultaneously. This radar was really a combination of two radar systems—one for search, the other for height-finding. The latter mechanically scanned rapidly in elevation up to an angle of 11 degrees, making available a display of targets in elevation continuously as the antenna structure rotated. The tight antenna beam available at S band made possible far superior height-finding accuracy at low elevation angles, as compared with that provided by the lower frequency radars, the broader beams of which could not avoid the low-angle returns reflected from the surface of the sea. However, due to the limited observational area provided by the conical scan of the Model SM and SP radars, an operator was likely to fix on a low-angle target image reflected from the sea, rather than the true image, and thus miss an interception. This possibility was avoided in the Model SX height-finding system, since false echoes were easy to spot on its range-height display, which simultaneously showed all echoes at any particular azimuth angle. The advent of the AN/SPA-8 series of plan-position indicators, with their correlated range-height displays, made feasible the use of other search radars available aboard ship. The search portion of the Model SX radar could therefore be eliminated. This elimination resulted in the Model AN/SPS-8 radar (101 procured) (1952). To obtain greater range, the cut paraboloid antenna was increased in size to 12 feet in height by 15 feet in diameter, and the transmitter pulse power was raised to 2500 kW. The high-power klystron tube had become available, and by its use operational difficulties of the magnetron were avoided, including that of maintaining highly precise frequency control. With these modifications the radar was designated the AN/SPS-30 (57 procured, 1955).

#### RADAR INFORMATION DISPLAYS

During the Fleet exercises in early 1939, when NRL first demonstrated with the Model XAF, the impact radar could have on Naval

operations, it was observed that its use would be greatly facilitated by employing displays which would present a polar-coordinate map in terms of range and bearing of all objects "visible" to the radar system. In the Model XAF, the echo returns were displayed as vertical deflections of a horizontal line sweep on the screen of a cathode-ray tube (type A presentation). This method of display, providing only a fleeting indication of the ships and aircraft participating in the exercise as the radar rotated, obviously was not conducive to the ready comprehension of their relative disposition, as would be the case with a map-like display. To provide a polar-coordinate map-like display of targets, NRL originated the radar plan-position indicator, or PPI (1939-1940).<sup>41</sup> The PPI, today, is universally used by the military and commercial interests of the world for the display of radar information for such functions as air and surface detection, navigation, aircraft traffic control, air intercept, and object identification. NRL devised both the magnetic (rotating and fixed coil) and electrostatic deflection types of PPI. In various forms, it provides an antenna-centered visual display painted on the screen of a cathode-ray tube, as the antenna rotates, through the radial scanning of its electron beam as it varies in intensity in response to the pulse echoes returned from objects. During the 1939 Fleet exercises, it was also noted that the display of radar information at remote points aboard ship would be of great assistance in carrying out such functions as gunfire control target designation. This need led to the development of the remote radar repeater indicator. In developing the PPI, NRL introduced:

1. Means to generate the radial scan of the electron beam from center to edge of the display, and means to synchronize the rotation of the scan with rotation of the antenna<sup>42</sup>
2. Sector scan, picture offset with area expansion, and multiple range scales for more detail and flexibility in observation<sup>43</sup>
3. Display of beacon responses to indicate position for navigation and transponder markers adjacent to echoes to identify friend from foe<sup>44</sup>

## RADAR

4. Remote indicators for the conduct of the several operational functions at remote locations with radar information.<sup>46</sup>

NRL's PPI was first utilized by incorporation in the experimental model of the SG radar, which was installed and demonstrated on the destroyer USS SEMMES in April 1941. The Model SG became the Fleet's first radar to be equipped with the NRL-developed PPI type of presentation. Later in 1941, NRL developed a PPI for use with the Model SC radars.<sup>46</sup> Utilizing the results, the Bureau of Ships proceeded to backfit the PPI to the Model SC and SK radars. The need in combat for several radars aboard ships concerned with command brought about the close association of these radars in one location and the evolution of the "Combat Information Center" (CIC). Since the PPI's of the early radars were incorporated into their transceivers, a compact arrangement of several interfered with the effective utilization of the data presented. This difficulty led to the separation of the indicator from the rest of the radar transceiver. Thus, the PPI's could then be conveniently assembled in the CIC and the rest of the radar transceiver located elsewhere (see also Chapter 10, "Electronic Systems Integration"). The Bureau of Ships proceeded to procure a series of separate PPI's, with NRL participation in the development. This series included the Models VC, VD, VE, VF, VG, VH, VJ, VK, VL, VM, VN, and VP, and the AN/SPA series.<sup>35,47</sup> The Model VD was the Fleet's first satisfactory remote PPI. It was of the mechanical rotating magnetic-deflection type, with four fixed range scales. This display, known for its operational simplicity, was extensively used (2396 procured, 1942-1944). The Model VE was used as an integral part of the radar transceiver, or as a remote PPI (980 procured, 1945). The Model VF provided an auxiliary rectangular display of range versus azimuth angle (B presentation) for increased accuracy in fire control (350 procured, 1945). The Model VG was the first projection PPI (911 procured, 1945). It utilized a four-inch-diameter dark-trace cathode-ray tube, the image of which was projected to a

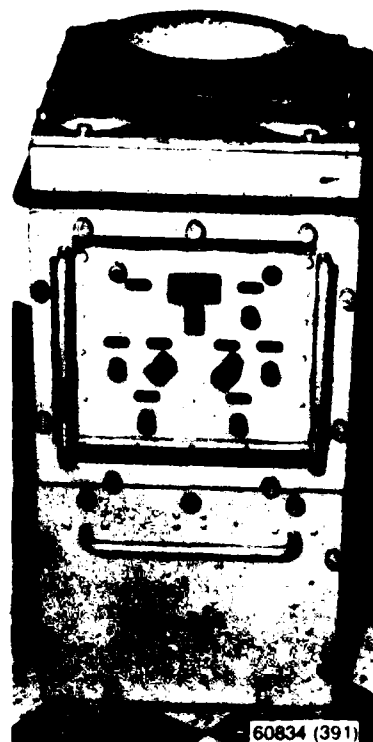

**THE RADAR INDICATOR  
FIRST TO RECEIVE EXTENSIVE  
NAVAL USE**

This general-purpose plan-position indicator (PPI), designated the Model VD, was the first to be procured and installed on ships in large numbers (1943). It incorporated many of the features originated by NRL

two-foot diameter on a screen. The Model VK, procured in large numbers, was the first PPI to have a deflection system with a fixed yoke instead of a rotating coil (1949). The Model VL, also procured in large numbers, was the first remote range-height indicator (1946). The Model AN/SPA-4 was the first PPI to provide high-precision range and azimuth information for such purposes as mine and buoy placement and helicopter control (3634 procured, 1942-1965). It found extensive service use for many years.

The Model AN/SPA-8 series was first to have a continuously variable range scale (4 to 200 miles), the first to provide off-centering of the display to any point on the screen, the first to have a wandering cursor, and the first indicator adequately to display airborne early-warning radar (AEW) information aboard ship (large procurement, 1951). The Models AN/SPA-9, 33, 34, and 59 were similar in design to the Model AN/SPA-8 (about 1000 produced, 1953-1960). The Model AN/SPA-25 was the first solid-state PPI. Its small size was conducive to general use. Nearly 2000 were procured, and they remained in service for a long time. The Model AN/SPA-66, also a solid-state indicator replacing the Model SPA-8 series, was in extensive use (large procurement, 1965).

#### FIRE-MISSILE CONTROL RADAR

In September 1933, the Laboratory brought to the attention of the Navy's Bureau of Ordnance the possibilities for the control of gunfire indicated by the results of its work at the higher radio frequencies.<sup>48</sup> It pointed out that a "beam" transmitter and receiver would be able "to detect and track an unseen ship or airplane," "take ranges on any objects," "take bearings on a ship or airplane by means of radio echo," and "give an indication of the rate of change of range to any object." "The accuracy would not be reduced in hazy weather or at night," as was the case with optical fire-control systems. At that time, NRL had under development electron tubes and circuits which, when available, would be able to operate at a high enough frequency to provide sharp beams with antennas of a size acceptable for shipboard installations for such use.<sup>49, 50, 51</sup> However, sponsorship for the application of the NRL techniques to gunfire control was not immediately obtained. NRL's demonstrations of radar during 1936 and the performance of the Model XAF radar aboard the USS NEW YORK in early 1939, which showed its ability to spot shots accurately and to track projectiles in

flight, aroused increasing interest in its exploitation for gunfire control.<sup>50</sup> It had been standard Navy practice with existing optical range finders, after the best estimate of range had been obtained, to fire one salvo beyond the target and one salvo short of the target, observing the two sets of splashes where the shells hit the water relative to the target, and then try to hit the target with the third salvo. With radar it was possible to obtain direct hits with high accuracy on the first salvo. After completion of the trials of the Model XAF, NRL studied the Navy's optical-mechanical gun directors and decided that the greatest improvement in performance quickly obtainable would be through the application of radar to their "ranging" function (May 1939). The Laboratory was then sponsored in proceeding with the development of "a combined detector and range-finder for main or secondary gun batteries."<sup>49</sup> To provide the increased accuracy in range indication needed in gunfire control, NRL was first to develop a high-precision range-determination radar technique using an additional pulse inserted in the cathode-ray-tube display, adjustable so that its position could be made to coincide with that of the echo pulse (1941).<sup>28a, 50</sup> The precisely known delay time of the additional pulse provided the range. NRL also developed the first automatic electronic following technique, so that signals could be made available to the computer for automatic gun control (1941).<sup>28a, 50, 51, 52</sup> These techniques were immediately applied to forthcoming radars. With the automatic following technique, ranges could be held automatically within  $\pm 10$  yards. Automatic operation was first applied to range control in the Model CXAZ (Mark 5) experimental fire-control radar (1942). The Model CXBF (Mark 6) experimental fire-control radar became the first to have fully automatic tracking (1942). NRL's automatic following technique was incorporated into the Army's Model SCR 584 radar, which was successfully used by the British in the defense of Britain against the German "buzz bombs."

## RADAR

To expedite the availability of radar in the Fleet, NRL in July 1937, at the request of the Bureau of Engineering, disclosed all the technical details of its radar work to representatives of the Bell Telephone Laboratories in the hope that they and their affiliate, the Western Electric Company, might undertake the production of radar equipment.<sup>49,53</sup> In view of their lack of experience in this field they were reluctant to engage in equipment production, and instead proposed to proceed with the development of electron tubes which would provide higher powered pulses at higher frequencies. In April 1940, their techniques were sufficiently advanced to place them in a position to accept a Navy contract to produce surface fire-control equipment.<sup>49,54</sup> The Western Electric Company and NRL cooperated closely in developing the "range only" equipment, the first of which was designated the Model CXAS and later the Model FA (also called Mark 1; 700 MHz, 25 kW pulse).<sup>49</sup> The first equipment was delivered to the Navy in December 1940 and installed on the USS WICHITA during July 1941. Production of ten began in June 1941. The Model FC, also called Mark 3 (700 MHz, 40 kW pulse), followed (1941), and included means to provide the azimuth bearing of the target namely "train," through the use of an antenna "sequential lobing" technique. This technique included two antenna beams placed side by side and displaced by a small angle. The azimuth bearing was provided by sequentially switching between the two beams and training the antenna until the signals received on the two beams were equal in magnitude. The first Model FC was installed on the USS PHILADELPHIA in October 1941 (125 procured). Subsequently, the sequential lobing feature was extended to provide elevation-angle determination for antiaircraft purposes in the Model FD radar, also called Mark 4 (700 MHz, 40 kW pulse, 375 procured, 1941).<sup>51,55</sup> This elevation "lobing" feature gave difficulty with lower angle targets, since in its use an operator tended to track the "image" of the aircraft reflected from the surface of the sea instead of the aircraft itself. A beam antenna, "nodding"

and continuously scanning in elevation, attached mechanically to the radar antenna, was added to avoid the difficulty (Mark 22). The first Model FD radar was installed on the USS ROE in September 1941. The Model FD was followed by the Model FM (Mark 12), also with a sequential lobing antenna for "train" and "nodding" for elevation (700 MHz, 250 kW pulse, 700 procured, 1943).<sup>56</sup> The first radar to scan continuously in azimuth, the Model FH (Mark 8), was developed for main and secondary battery fire control against surface targets (3000 MHz, 100 kW pulse, 179 procured, 1942).<sup>57</sup> This radar's antenna comprised a group of polystyrene rods arranged three high by 14 wide, to provide a beam 2 degrees in azimuth and 6 degrees in elevation. Motor-driven, continuously variable waveguide phase shifters provided scanning through 30 degrees in azimuth. The Mark 8 was followed by the Mark 13 radar, the horizontal scanning of which was accomplished with a nodding type of antenna which provided a twofold improvement in azimuth angle accuracy (8800 MHz, 107 procured, 1945).

These several radars were used with the different models of directors and computers to provide control of the fire of the various sizes of guns aboard ship, including the 5-inch, 16-inch, and antiaircraft guns. For the launching of torpedoes by our submarines against enemy shipping, NRL developed the first radar to utilize a periscope as a waveguide, topped by a reflector to provide precise range data while submerged, the Model ST (8800 MHz, 85 kW, 0.5 microsecond pulse, 400 procured, 1944).<sup>58</sup> The antenna arrangement with its small reflector, shaped to minimize the silhouette, permitted radar-guided torpedo launching while the submarine was submerged.

These several kinds of fire-control radars saw important service during World War II. A large number of them continued in service many years thereafter. The battleship USS NEW JERSEY carried a Mark 13 fire-control radar during its 1968-1969 bombardment in

RADAR

60834 (382)

**EARLY GUNFIRE-CONTROL RADAR,  
MODEL FD (MARK 4)**

NRL participated in the development of this radar. The transceiver is shown below. Two antennas mounted on Mark 37 optical directors are shown above. The antenna on the left has mounted on its right an elliptically shaped "nodding" antenna, the Mark 22, used to avoid inaccuracies in height measurement due to sea-surface reflections experienced with the main antenna.

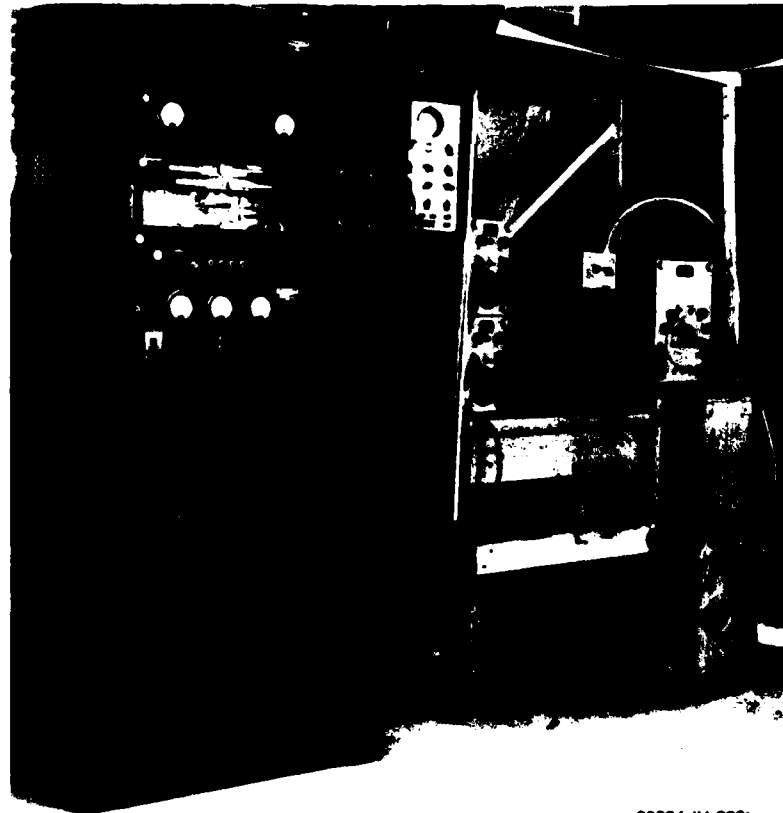
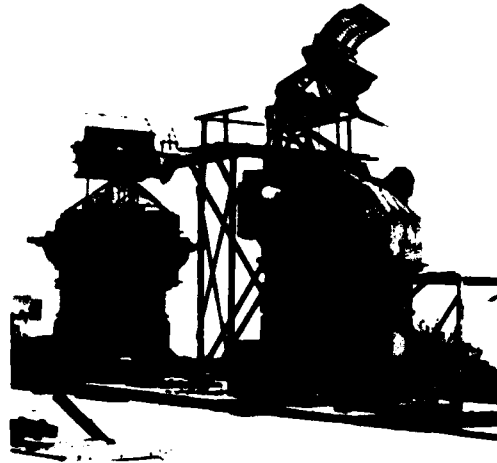

60834 (H-393)

Vietnam with its 16-inch guns in support of our military forces, over 20 years after this model radar first became available!

### CONICAL-SCAN RADAR

The development of conical-scan radar, in which NRL participated, considerably advanced our capability to defend our ships against attacking enemy aircraft (1942).<sup>50</sup> This type of radar uses an antenna beam, offset from the axis of a parabolic reflector, which describes a conical path as it rotates about the axis of the reflector. As the beam rotates, the received signal is produced continuously for processing and display. At the time of availability of the conical-scan radar, it became possible to generate sufficient transmitter pulse power at the higher frequencies to provide effective aircraft ranges with the use of reflectors small enough to be compatible with the maneuverability required of anti-aircraft gun directors. The tighter antenna beams resulting enhanced the angular accuracy. The early conical-scan radars used a rotating-dipole type of antenna which, as the beam rotated, caused continuous change in polarization of the transmitted pulse emissions. Since the reflection characteristics also varied with polarization of the incident energy, the return echo was adversely affected. The attending modulation was a major factor in distorting the return signal. To avoid this difficulty, the reflector's waveguide feed was arranged to "nutate," rather than to rotate, so that the polarization of the transmitted pulses remained unchanged as the beam rotated in azimuth. Because of the congestion of channel assignments in the S band, and the practicality of the correspondingly smaller parabolic reflectors at the higher frequencies, conical-scan radars were placed principally in the X-band region. The relative simplicity and low cost of the conical-scan radars resulted in their widespread use. The first conical-scan radar available to the Fleet was the Mark 9, also the Model FJ, (3,000

MHz, 30 kW pulse, 30 procured, 1942).<sup>50</sup> This was followed by the Mark 10, or Model FL (3000 MHz, 30 kW pulse, 406 procured, 1942 to 1943) and the Mark 25 (9000 MHz, 70 kW pulse, 420 procured, 1946). Subsequently, a series of conical-scan anti-aircraft gun-fire-control radars was developed, which included the Marks 28, 29, 34, 35, 37, and 39, and the AN/SPG-48, 50, and 53.<sup>50, 51</sup> Procurements of these radars totaled in the thousands. Considerable use has been made of conical scan in airborne radars, including the Models AN/APS-25, 28, 67, AN/APG-25, 26, 51, AN/APQ-35, 36, 41, 42, 43, 47, 50, 59, 72, 100.<sup>52</sup>

Conical-scan radar was first applied to the guidance of missiles by NRL in its development of the Lark missile, the first beamrider missile (1947). A Model SP radar was modified so that a conical-scan antenna beam provided this missile with data to guide itself along the course to the target, established by directing the radar beam. To provide greater portability in determining the performance of the Lark at remote Navy missile test sites, NRL modified the Model SP-1M radar similarly. An additional modification made it suitable for use in NRL's development of the Skylark missile-guidance system, the first to have "automatic command-guidance" (1948). "Conical-scan-on-receiver-only," an arrangement used by NRL as early as 1943, was first employed in the Model MPQ-50 radar and then in the Model AN/SPG-51 radar, used for guidance of the Tartar missile (1951). This arrangement has the advantage of avoiding interception of the scanning information, but at the expense of additional transmitter power to compensate for the lower antenna gain on transmission.

### MONOPULSE RADAR (SIMULTANEOUS LOBING)

In conducting investigations to increase the angular accuracy of the sequential-lobing and conical-scan types of fire-control radars,

## RADAR

NRL found that the pulse-to-pulse changes in target-reflection characteristics and the long period required in the comparison process to obtain the angle data were major factors in limiting the accuracy.<sup>62</sup> NRL had devised an electronic sequential switching technique which gave increased angular accuracy by allowing switching at high speed, as compared with mechanical switching, and also avoided the mechanical troubles inherent in the latter (1943).<sup>63</sup> However, in both systems, paired trains of echo pulses, successively received on the

repective sides of the axis of the antenna reflector, had to be compared to obtain the angular error required for training and pointing. Furthermore, in both systems, during the comparison process the effective antenna beamwidth is broadened considerably, and full advantage cannot be taken of its angular discrimination capability.

To overcome the angular limitations of existing radars, NRL developed the first monopulse radar, in which angular determinations are made simultaneously on each individual received pulse. This new type



**FIRST MONOPULSE RADAR**

The experimental monopulse radar shown here was developed by NRL. It was the first radar of its type to provide effective operational performance. D. D. Howard (left), in charge of the project, and his assistant, M. C. Licitra, are shown.

## RADAR

of radar provided a tenfold improvement in angular accuracy over that previously attainable in the training and pointing of fire and missile control radars at the longer ranges (1943).<sup>64</sup> The monopulse technique was first applied to the Nike-Ajax missile system, the first U.S. Continental Air Defense System. The radar of this system was patterned after NRL's experimental model (1946). Subsequently, monopulse radar became the standard radar for U.S. missile ranges. Monopulse radar was used extensively in a variety of Navy systems. The first monopulse radar to be devel-

oped for Fleet operational use, the Mark 49, later designated the Model AN/SPG-49 (1948), was intended for gunfire control but instead was used for the guidance of the Navy's Talos missile aboard the Navy's guided-missile ship, the USS GALVESTON (CLG-3) (1957). The AN/SPQ-5 monopulse radar, which was developed about the same time (1950), was used to provide guidance for the Terrier missile aboard the Navy's first operational guided-missile ship, the USS BOSTON (CAG-1, now CA-69), followed by an installation aboard the USS CANBERRA (CAG-2, now CA-70). A succession of

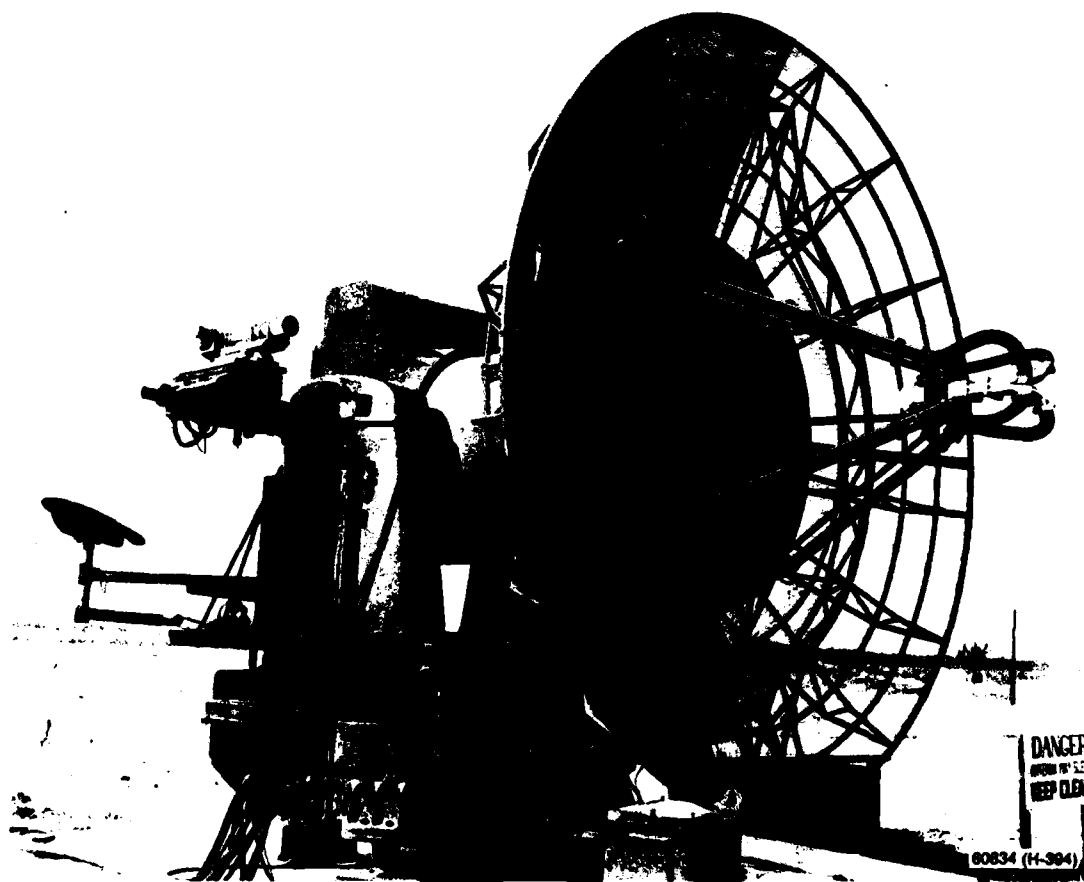

**THE FIRST RADAR DESIGNED ESPECIALLY FOR MISSILE RANGES, THE AN/FPS-16- (XN-1)**

This radar, developed jointly by NRL and RCA, the contractor (1956), was installed at Cape Canaveral and used in guiding the launchings of the first U.S. satellites placed in orbit, the Explorer I, on 31 Jan. 1958, and the Vanguard on 17 May 1958.



## RADAR

monopulse radars for tracking and guidance of Navy guided missiles ensued, including the Model AN/SPG-55 (1956), used for the Terrier missile, the AN/SPG-56 (1960) for the Talos missile, and the AN/SPG-59 (1959) for the Typhon and Super-Talos missiles. Many monopulse radars were in active service for many years, particularly the AN/SPG-49 and AN/SPQ-5.

In the monopulse reception system, a four-horn antenna feed assembly delivers the echo returns to a hybrid network, which simultaneously compares the outputs of the horns and provides difference signals for indication of angular error in training and pointing and summation signals for range tracking. In transmission all four horns are used jointly, or an additional centrally located horn is employed. NRL, in seeking the maximum potential of the new system, continued development of the monopulse system through an extended period, with particular attention to the improvement of components and the reduction of tracking angle noise.<sup>65</sup>

### AIRBORNE RADAR

Prior to the entry of the United States into the war and in anticipation of having to contend with the German submarine menace, NRL developed the first American airborne radar, the Model ASB (1941).<sup>6d, 28b, 66</sup> This radar saw extensive use during the war, not alone by the U.S. Navy and Army Air Forces, but also by the British. It was installed almost universally in the U.S. Naval aircraft and became known as the "workhorse radar of Naval aviation." Over 26,000 equipments were procured, the largest procurement of any model radar (1942-1944, RCA, Bendix, and Westinghouse Electric Companies). Besides its search and navigational functions, it was found effective in dropping bombs and launching torpedoes, and in homing aircraft back to bases.

The Model ASB was the first radar to be used in carrier-based aircraft. The first United States night-fighter aircraft (F4U, Vought) were equipped with it. This radar, installed in PBY

long-range patrol seaplanes, was used principally by the British to hunt down and bomb German submarines in the Atlantic. Radar tremendously widened the area which could be covered by patrol planes in sea surveillance and forced enemy submarines below the surface of the ocean. This deprived them of the freedom they needed to cruise on the surface, which was necessary to charge batteries and obtain fresh air, and placed them in a precarious situation. The Model ASB radar was used in the first raid on Truk Island (February 1944), which represented the beginning of the major organized U.S. retaliation for the Japanese attack on Pearl Harbor. This radar, installed in the TBF carrier-based torpedo aircraft, was used effectively in attacking and destroying Japanese ship convoys in the Pacific. It was also effective against Japanese aircraft and was instrumental in helping to destroy a number of them. A considerable number of Model ASB radars were still in active aircraft service at the close of the war. They were ultimately replaced by radars operating at the higher frequencies.

NRL's radar, labeled the Model XAT in experimental form, was designated the Model ASB when procured (515 MHz, 200 kW, 2-microsecond pulse). In developing the radar, NRL converted a 500-MHz pulse-type altimeter it had completed and provided components more suitable for the air-search function. These included an antenna system with duplexer and two directional antennas mounted on opposite sides of the aircraft, which could be directed either abeam the plane for searching a wide path (50 miles) for targets, or forward, with the beams partially overlapping for homing in attack. The transceiver was arranged to be switched rapidly between the two antennas. The received echoes were displayed on a cathode-ray tube as pips, opposite each other on the sides of a vertical line. In attacking targets, the aircraft was turned, right and left, until the pips were equal in size, which indicated that the aircraft was headed directly toward the source of the echo. The position of the pips on the line indicated the range of the object.

RADAR

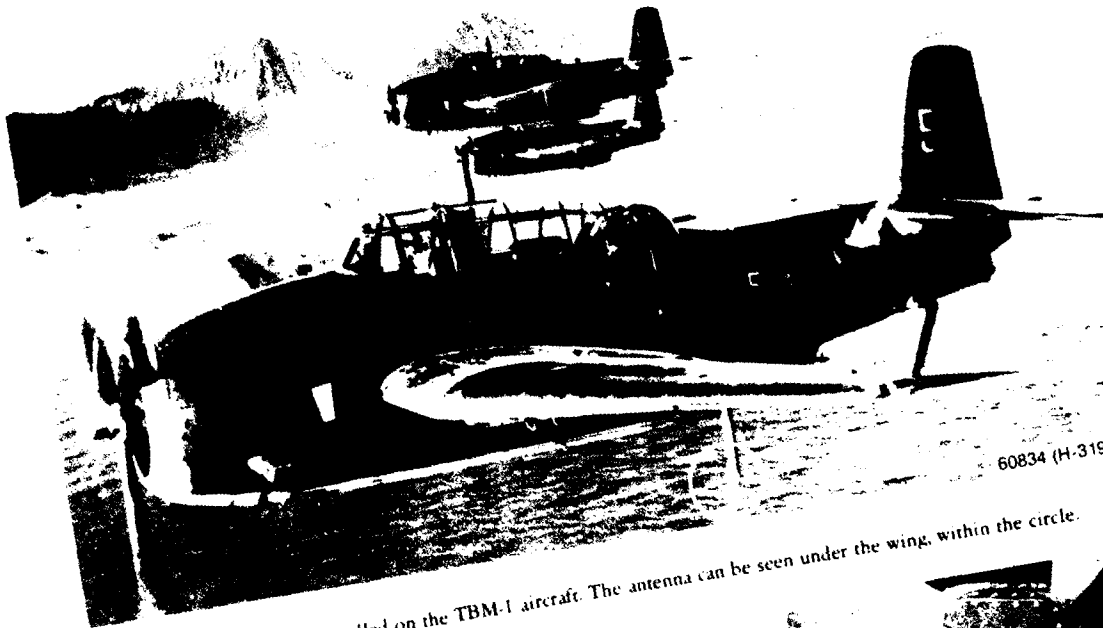

60834 (H-319)

Model ASB radar installed on the TBM-1 aircraft. The antenna can be seen under the wing, within the circle.

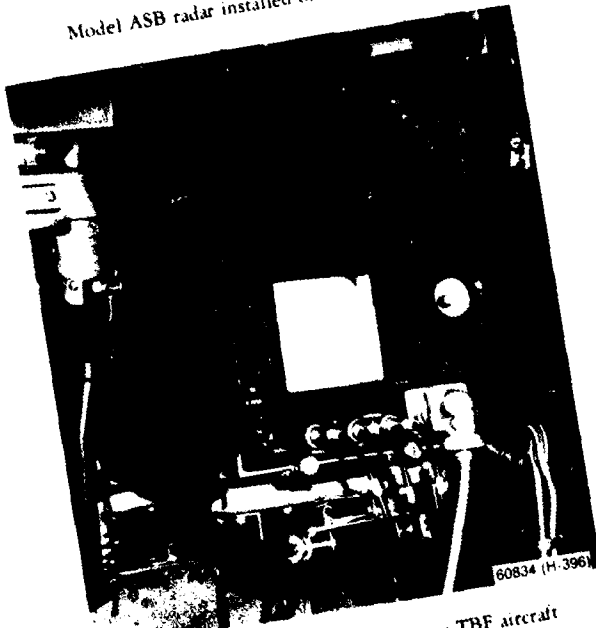

60834 (H-396)

Model ASB radar as installed in type TBF aircraft

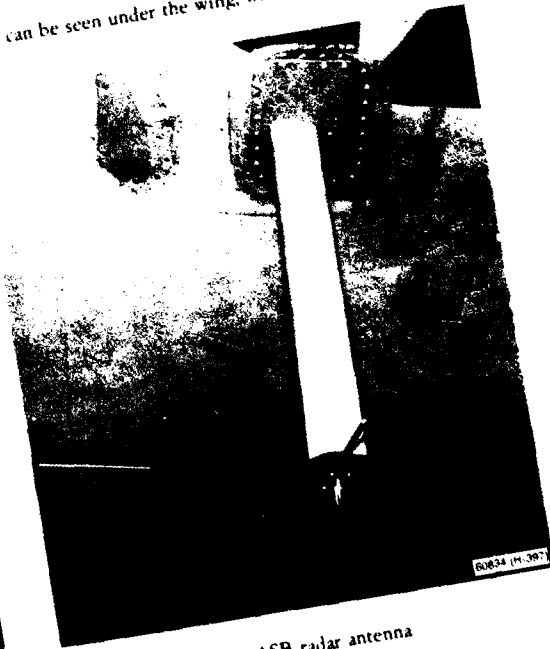

60834 (H-397)

Model ASB radar antenna

**THE FIRST U.S. AIRBORNE RADAR, THE MODEL ASB (1941)**

This radar, developed by NRL, was extensively and effectively used during World War II. Over 26,000 equipments were produced, the largest procurement of any model radar.

## RADAR

Before the Model ASB production equipment was released, NRL modified the Model ASV airborne radar (176 MHz), given to the United States by the British. This radar had a large, cumbersome antenna system which substantially reduced the speed of aircraft. At that time the British were forced to use separate transmitting and receiving antennas for both beams, since they did not have the duplexer which NRL already had developed. NRL modified the British radar, incorporated the duplexer, and made it more acceptable for airborne operations. It was then designated the Model ASE, and hundreds were produced on a crash basis. However, the Model ASB radar, operating at higher frequency with a much smaller antenna system and having considerably less weight, was found far superior to the Model ASE in both performance and operational acceptability. At the time of NRL's development of the Model ASB radar, a contract was placed with a commercial concern for a radar designated the Model ASA (400 MHz). Two experimental models of this radar were made, but in trials gave poor performance. The radar was not put into production, but was abandoned in favor of NRL's Model ASB.

### AIRBORNE MICROWAVE RADAR

After the Model SG microwave shipborne radar development had been initiated, the Navy, with the aid of the Radiation Laboratory and NRL, sponsored a series of airborne radar developments with commercial organizations based on the British multicavity magnetron and NRL's duplexer and display concepts.<sup>6d,28c,66,67</sup> The promise of better performance and much more compact and lighter equipment with the use of frequencies considerably higher than that of NRL's Model ASB radar was particularly attractive in increasing the combat capability of aircraft. In the series, the Model ASG S-Band radar (Philco) was of particular significance, and the first to become available in quantity. When the Army Air Force became interested in this radar, it was redesignated the Model

AN/APS-2 (Philco). During late 1942 the Navy installed this radar on K-type airships to track down submarines. It was also installed on Navy PB4Y-2 patrol aircraft. The PB4Y-2, then under development, became the first aircraft designed to provide special accommodations for radar. The radar, with its map-type PPI presentation, provided observation of ships up to 60 miles away and submarines at shorter distances. It helped to sink thousands of tons of enemy shipping. Over 5000 of these radars, with various modifications, had been produced by the end of the war.

Much greater equipment compactness was achieved when multicavity magnetrons became available at X band. With smaller size available due to the threefold increase in frequency, the antenna and associated components could be mounted in a streamlined nacelle hung under wings, on wing tips, or at midwing of small aircraft. Other parts, such as the indicator and modulator, could be accommodated within the fuselage. The Model ASD radar (Sperry), later designated the AN/APS-3 (Philco), was the first to have this type of configuration. It could detect ships up to 300 miles away with its 150 degrees of azimuth forward vision.<sup>68</sup> It could detect a submarine reliably at a range of 15 miles, and a medium-sized bomber at eight miles. This radar, available in 1943, proved valuable for aiming bombs and torpedoes as well as for search, homing, and navigation. The radar was installed in types TBF and PV-1 aircraft and was used for aircraft interception (AI) and rudimentary gun direction against enemy aircraft. Squadrons based in the Aleutians were able to fly through fog to the Kurile Islands and to blind bomb Japanese shore installations with aid of this radar.

A lightweight version of the X-band Model AN/APS-3 more suitable for carrier-based aircraft installation, known as the Model ASH (later the AN/APS-4), was produced (Western Electric, 1944).<sup>69</sup> This equipment also took the form of a streamlined nacelle that could be installed on aircraft in the several wing positions. The radar was first installed on type SB2C planes,

## RADAR

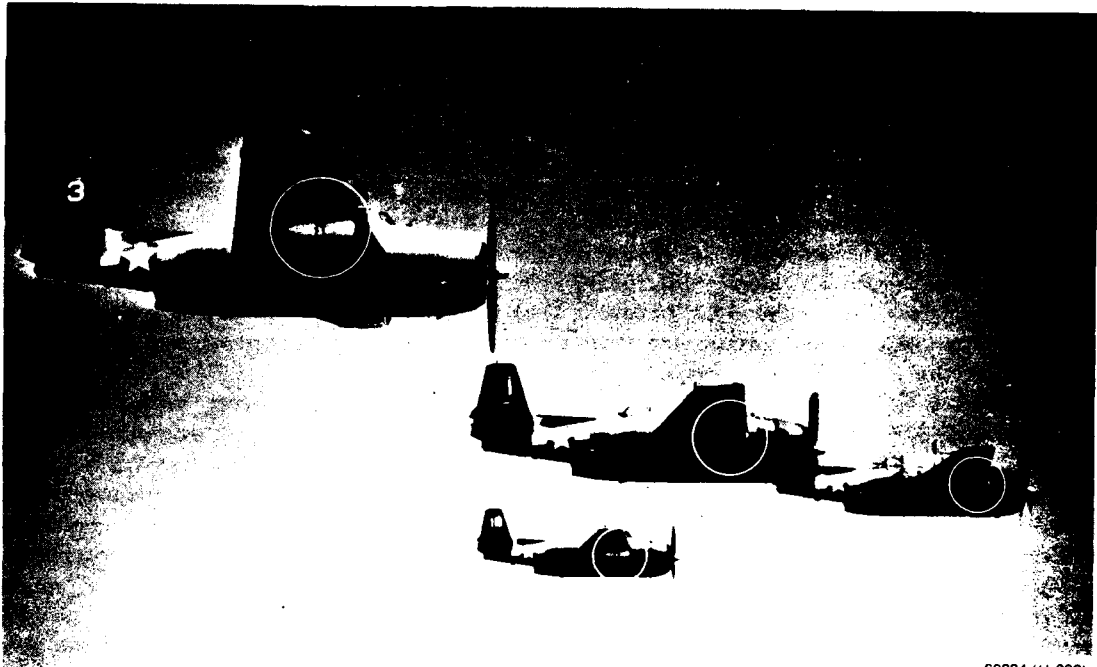

60834 (H-398)

### X-BAND AIRBORNE RADARS

Model AN/APS-4 airborne radars are seen mounted under the wings of the type TBM torpedo bomber aircraft. This radar was the first to utilize a streamlined nacelle. NRL participated in its development (1944). More than 1200 installations were made during World War II.

and by April 1945 more than 1200 installations were completed on such aircraft as type TBM torpedo bombers, type F6F night fighters, and type SC-1 Seahawks. Many thousands of these radars were installed during the latter part of the war. This radar helped to find enemy shipping and to dive bomb or launch torpedoes in destroying it. It also helped in navigation through storms and homing on beacons at great distances.

A highly specialized type of radar was needed for night-fighter aircraft. The first such equipment was the Model AIA (Sperry), which was redesigned as the Model AN/APS-6 (Westinghouse). This equipment was capable of detecting and tracking enemy aircraft in a large cone of space up to six miles ahead of the fighter, and then directing the pilot to a close-in range, where it functioned as a blind gunsight. Its presentation on search was spiral, but it was

conical for gunlaying. Its frequency was X band, with 40-kW pulses as short as 1/4 microsecond. Many hundreds of this model radar were installed in fighters such as the type F6F-5N. Its peak of usefulness was reached in the last phases of the war in the Pacific, when it made an important contribution to overcoming enemy aircraft. The APS-6 was the only AI radar possessed by the services during the war years that was small enough for single-engine aircraft.

### POSTWAR AIRBORNE RADAR

After the war, NRL continued to provide technical consulting support to the Bureau of Aeronautics for advancing airborne radar capability. The wartime activities of the Radiation Laboratory had then been terminated. Toward

the end of the war, it had been planned to combine the best features of the AN/APS-4 and AN/APS-6 radars to provide both a search and an intercept capability in one equipment for night fighting. Subsequently, this radar, designated the AN/APS-19 (X band), was developed in a size small enough to fit into the type F8F aircraft then given acceptance as a first-line fighter (1946).<sup>70</sup> The radar's scope presentation had several selectable scans, which gave it greater flexibility and coverage for both search and gun-aiming functions than had previously been available. However, it was still necessary to steer the plane manually to align the fixed guns with the target. Automatic airborne gun-laying was first achieved with the X-band Model AN/APQ-35 radar, used in the type F3D-1 aircraft with 20-millimeter guns (1946).<sup>71</sup> This aircraft was the Navy's answer at that time to the problem of providing the services with a satisfactory "all-weather" fighter; previous aircraft were deficient due principally to unavoidable compromises made in converting the available day-fighter aircraft. The AN/APQ-35 was really three radars combined: the AN/APS-21 for search and intercept, the AN/APG-26 for gunlaying, and the AN/APS-28 for tail-warning. To provide search, track, and gun-aiming capability for jet-fighter aircraft (F2H-3N and F3H), the Model AN/APQ-41 radar was developed (1951).<sup>72</sup> It was capable of locking on and tracking a selected target of the B-29 aircraft type at a range of about 30 miles. It could track targets with a maximum relative target speed of 900 knots.

#### AIRBORNE WEAPON SYSTEMS- GUIDED MISSILE RADAR

Up to this time the interceptor-fighter aircraft, its radar, weapons, and appurtenances had not been considered from the combined systems viewpoint. Instead, the system components had been designed and arranged independently without due consideration of their mutual compatibility and the effects of their characteristics upon the mission, threat, and tactics

involved. **NRL was first to determine a methodology by means of which the parameters of the airframe, radar, missile, and other critical adaptable components of airborne weapon systems can be adjusted to meet the requirements of the mission, threat, tactics, and environment to provide an integral system having maximum combat effectiveness.** The results of NRL's work have been applied generally to modern interceptor aircraft.<sup>73</sup> **NRL first applied this combined systems technique to the type F4D aircraft and its AN/APQ-50 radar (Westinghouse, 1953).** This radar was redesigned by NRL to meet the system criteria. The radar had a stabilized antenna for its search function and a computer for the direction of guns and rockets, with adaptations for use with guided missiles. The AN/APQ-50 radar also featured a single package, a design now followed universally in interceptor radars. NRL's system treatment was also applied to the type F3H interceptor aircraft and its AN/APQ-51 radar (Sperry, 1953). This radar was provided for the guidance of the Sparrow I missile, the first air-to-air guided missile, which was then about to become operationally available. It had been planned to use the AN/APQ-36 radar for the guidance of the missile, since this radar had a semiautomatic all-weather capability. However, it required a two-seat aircraft to accommodate it. The AN/APQ-51, designed as a single compact package, was more suitable for use in a single-seat interceptor.

**NRL's weapon-system technique has been applied to a succession of interceptor aircraft weapon systems using guided missiles, including the Sparrow II, Sparrow III, and Sidewinder missiles.** The types of aircraft and radars involved include the F8U-1 with the AN/APS-67 radar (1956), the F4H-1 with the AN/APQ-72 radar (1957), the F8U-2NE with the AN/APQ-83 radar (1960), the F8E with the AN/APQ-94 radar (1961), the F4J with the AN/APG-59 radar (1968), and the F8J the AN/APQ-124 radar (1968). The system, including the type F4J aircraft and the AN/APG-49 radar, has been designated the AN/AWG-10 aircraft weapon system.

## RADAR



### THE AIRBORNE WEAPON SYSTEM FIRST TO UTILIZE INTEGRAL SYSTEM METHODOLOGY IN ITS DESIGN TO PROVIDE MAXIMUM COMBAT EFFECTIVENESS

This methodology, devised by NRL, was applied by NRL (1953) in its AN/APQ-50 radar, shown here mounted on an F4D Skyray, to meet the system criteria. NRL's methodology has been applied to a series of interceptor aircraft using guided missiles, including the Sparrow II, Sparrow III, and Sidewinder.

This system, and the others enumerated back to and including type F4H-1 aircraft with the AN/APQ-72 (1957), were used extensively in the Navy. The NRL system technique was used in the design of the AN/AWG-9 weapon system for the type F-111 interceptor. This aircraft has been superseded by the new type F-14, now underway, which will use the Phoenix missile. The AN/AWG-9 is the first airborne interceptor weapon system to employ digital techniques in its fire-control computer to achieve greater computation accuracy in weapon guidance. It is also the first to have an airborne planar slotted array antenna to provide a sharper beam.

The U.S. Air Force has adopted the NRL composite-systems technique in the design of its interceptor aircraft systems. With

minor modifications, it has utilized the Navy's system, employing the type F4H-1 aircraft with the AN/APQ-72 radar and the Sparrow III missile. This aircraft was relabeled the type F4C, and the radar, the Model AN/APQ-100 (1963). More F4C interceptors are now used in service by the Air Force than any other type aircraft. The Air Force has continued to apply NRL's composite-systems technique to its later interceptor-aircraft designs.

### AIRBORNE EARLY WARNING RADAR (AEW)

AEW radar, devised during the war to meet an urgent need arising in the Pacific area, has

RADAR



**THE NAVY'S LATEST AIRBORNE WEAPON  
SYSTEM, CAPABLE OF ENGAGING  
SUPERIOR NUMBERS OF ADVERSARIES  
IN ITS ROLE AS FLEET DEFENSE INTER-  
CEPTOR AND AIR-SUPERIORITY FIGHTER—  
THE AN/AWG-9 (1973)**

This system is based on the NRL-developed methodology which requires the characteristics of the airframe, radar, missile, and other critical components of weapon systems to be adjusted to those of the mission, threat, tactics, and environment, to provide maximum combat effectiveness. The Navy type F-14 fighter aircraft is shown with the Phoenix long-range missile. The radar is seen in the nose of the aircraft.

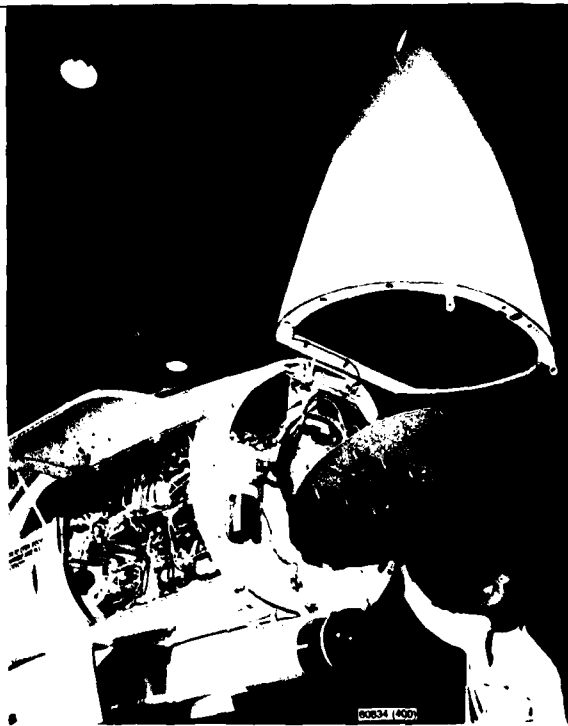

## RADAR

since grown in stature to become a major component of Naval aviation, with a vital role in air defense. Shipborne radar had been found deficient in detecting low-flying Japanese aircraft making Kamikazi attacks. Airborne radar, with its greater line-of-sight range when operating at high altitude in forward locations, and with transmission of the radar video data back to surface ships charged with command, was recognized as a solution of the problem. NRL had developed an airborne radar equipped to transmit the video data to remote craft for display using components of its Model ASB airborne radar (1943).<sup>74</sup> This system comprised the Model AN/APS-18 airborne radar-link transmitter and the AN/ARR-9 link receiver-display. Thirty of these equipments were produced. This system concept was utilized in the Model AN/APS-20 AEW radar-link system

(S band, one megawatt, 1944).<sup>75</sup> The antenna of this radar was carried in a bulbous radome below the fuselage of the aircraft, to minimize interference with radiation by the plane's structure. Detection ranges out to 65 miles were obtained on single low-flying aircraft, and out to 200 miles on surface ships. By the end of the war 27 installations of this system had been made in type TBM-3W carrier-based aircraft, but none reached combat service. After the war many additional installations were made in other types of aircraft.

Upon the closing of the Radiation Laboratory at the termination of the war, NRL, as requested by the Navy Department, continued to provide technical guidance to contractors in advancing the capabilities of AEW radar. Higher transmitter power was provided in a "B" modification of the Model AN/APS-20 radar

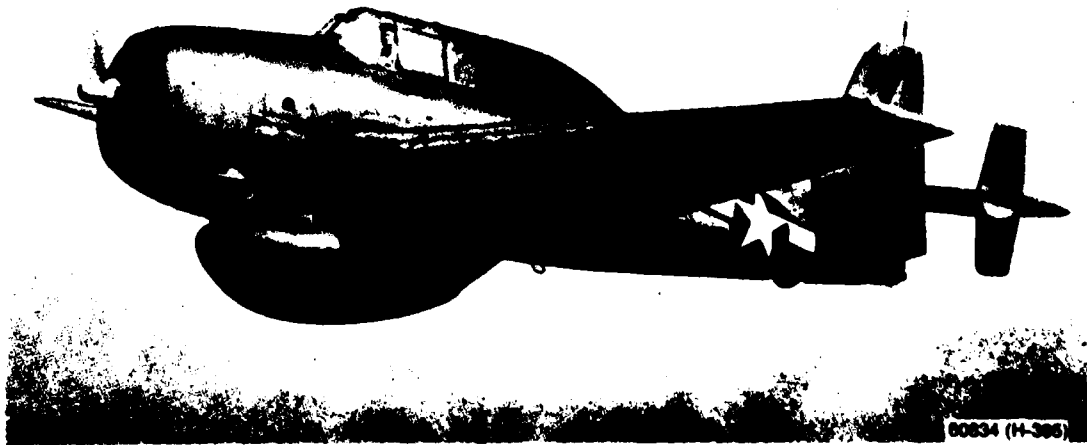

**THE TYPE TBM AIRCRAFT WITH AEW RADAR UTILIZING NRL'S SYSTEM CONCEPT,  
THE MODEL AN/APS-20 (1944)**

This radar was used operationally for many years. The bulbous radome below the fuselage of the aircraft carries the antenna of the radar.



(S band, two megawatts). A limited airborne fighter-direction capability for air-intercept control was provided by installing the Model AN/APS-20B radar in the type PB-1W land-based aircraft, which had sufficient space to accommodate a small combat information center (CIC). Additional modifications of the Model AN/APS-20E radar has seen a great deal of service. The Model AN/APS-20E radar was used as a basis for proceeding with advanced models of S-band AEW radars. It was modified by the provision of a tunable magnetron transmitter and a combined search and height-finding capability. The new model, designated the AN/APS-82, was the first AEW radar to use the monopulse technique for accurate angle determination (S band, one megawatt, 1975).<sup>77</sup> A further modification involved the use of a klystron transmitter with a master oscillator to provide the frequency control necessary to alleviate difficulties with mutual interference between radars operating in relatively close proximity, as required in certain AEW aircraft operational situations. This equipment became the Model AN/APS-87 radar (S band, 1.4 megawatt, 1957).<sup>78</sup> This model was not produced in large quantity. However, the Model AN/APS-82 radar was procured in considerable numbers for installation in type E1B AEW aircraft and was used extensively.

#### UHF-AEW RADAR

The capability of microwave radar was severely limited by sea-clutter returns, which were considerably less in the UHF region. NRL had taken advantage of this lower sea-clutter factor in its development of the Model AN/APS-17 UHF shipborne radar. Success led to a project to provide a UHF-AEW radar. To contend with the adverse influence of sea clutter, NRL developed critical components of an experimental UHF-AEW radar (425 MHz)

including the antenna, duplexer, and low-noise receiver, which were installed, together with other components, in the type ZPG-2 airship by the Lincoln Laboratory (MIT), which provided the transmitter (1955).<sup>79</sup> The success obtained with this radar in flights over Atlantic Ocean areas led to the development of a series of UHF-AEW radars which has continued to the present day. The first of these, the Model AN/APS-70 UHF-AEW radar (425 MHz, two megawatts), was developed for installation in the type ZPG-3W airship, the largest nonrigid ship ever built, and the type WV-2 land-based aircraft (1957).<sup>80</sup> NRL provided the design for the antenna of this radar, which although large (40 feet wide by 6 feet high), could be fitted into the craft. In tests over Atlantic Ocean areas, the Model AN/APS-70 radar provided an aircraft detection range improvement up to 40 percent greater than existing microwave radars. The Navy procured only a limited number of these radars, which were used for AEW experimental purposes. However, the U.S. Air Force obtained considerable numbers of them for use with the AEW aircraft.

About this time, the Navy decided against the further use of the unwieldy airship and large land-based aircraft as AEW platforms in favor of carrier-based aircraft. NRL made several contributions to the UHF radar for the new AEW aircraft. The practice of mounting antennas below the fuselage in blister-type radomes, used previously for microwave radar, when followed at UHF, resulted in serious distortion of antenna patterns and intolerable coverage gaps due to reflections from wing surfaces. An antenna-radome combination which rotated as an integral unit mounted above the fuselage in a saucer-shaped structure provided a satisfactory solution to the problem. NRL developed a UHF horizontal, end-fire array antenna enclosed in a rotodome (24 feet across and 2.5 feet high), which as produced by a contractor was the antenna for the Model AN/APS-96 radar used in the first carrier-based UHF-AEW aircraft, the type W2F-1, Hawkeye, later

## RADAR

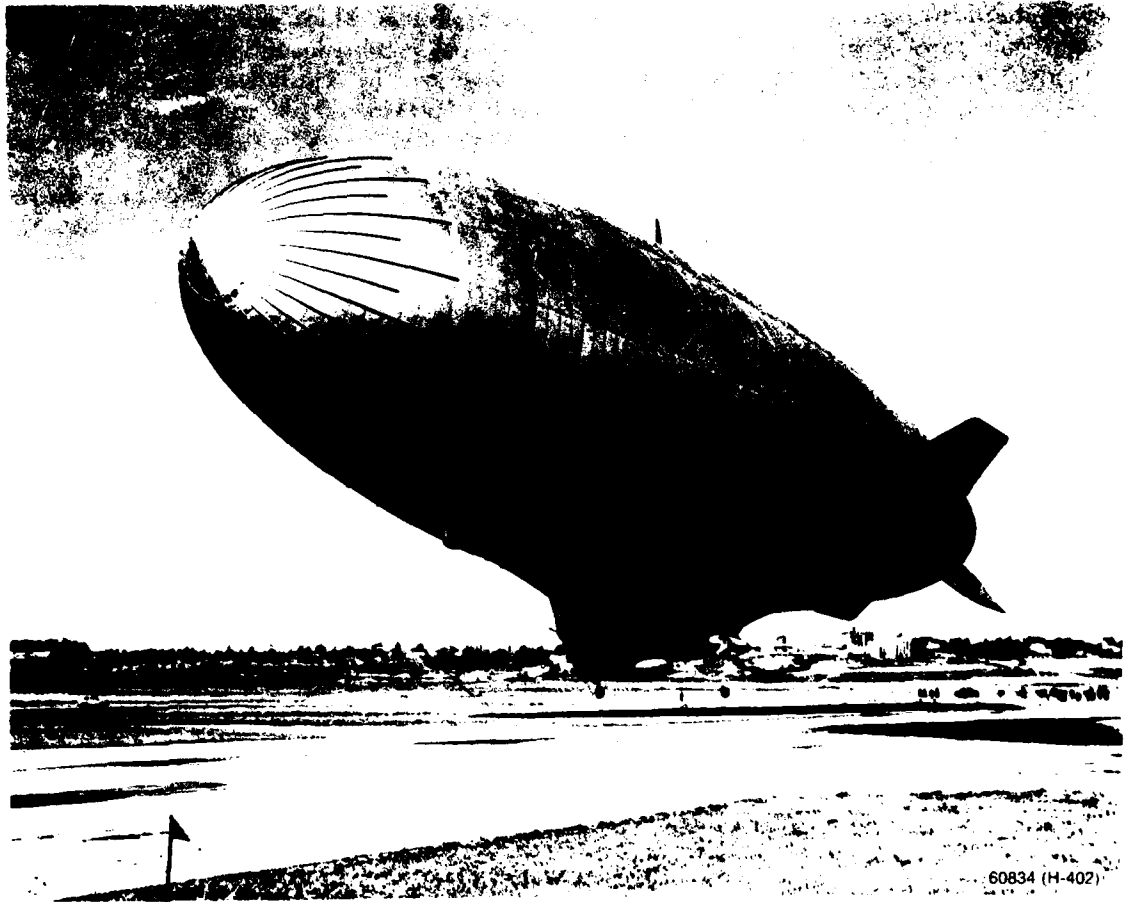

THE FIRST AIRSHIP ESPECIALLY CONFIGURED FOR  
UHF (425 MHz) AEW OPERATIONS, THE ZPG-2, (1955)

Success obtained in flights over the Atlantic Ocean areas with this installation led to the development of a series of UHF AEW radars. NRL developed critical components for the radar, including the antenna, duplexer, and low-noise receiver.

designated type E2A (1960).<sup>81</sup> This AEW aircraft was in extensive use throughout the Navy. Its rotodome antenna structure presents a most striking appearance. It provides aerodynamic "lift" with low "drag" and a UHF radar antenna beam of high gain and negligible distortion.

The Navy planned to incorporate into the Model AN/APS-96 radar height finding of sufficient accuracy to provide an efficient fighter-

direction capability against enemy aircraft, particularly high-speed aircraft. Existing auxiliary height finders and several attempts to include height finding in the AN/APS-70 radar were inadequate in either accuracy or target capacity. NRL investigated the capability of various proposed methods of height finding and determined that only one showed promise to meet requirements. Subsequently, **NRL was first to develop and to demonstrate instantaneous**

## RADAR

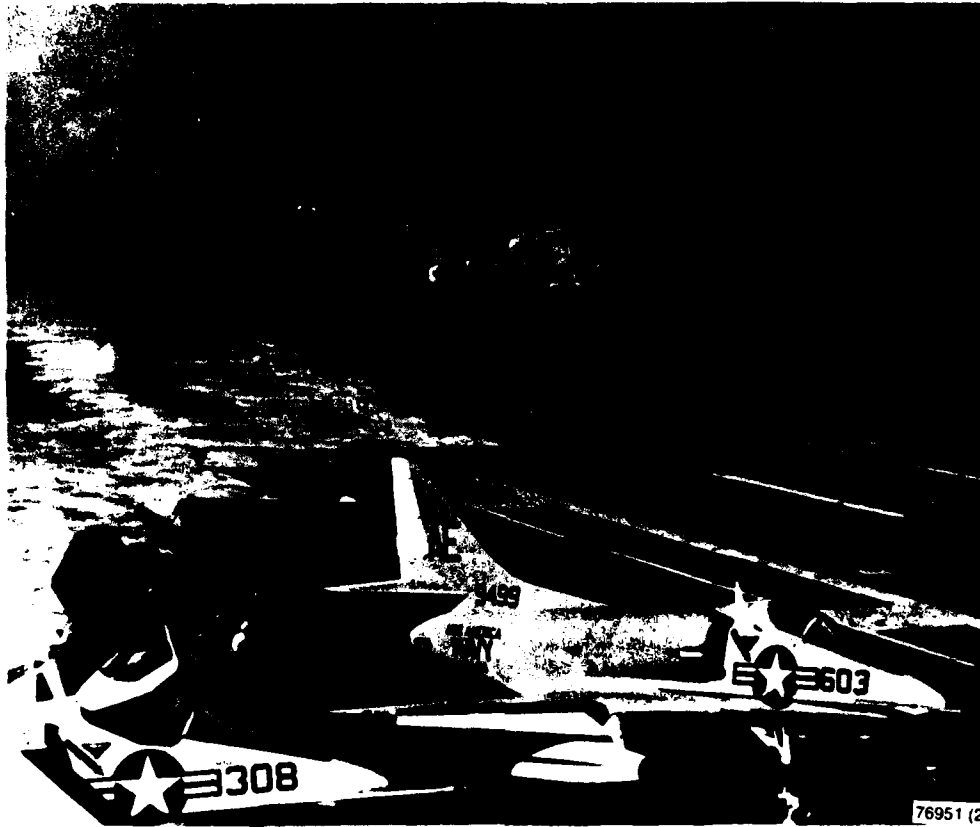

THE FIRST UHF AEW AIRCRAFT LANDING ON THE CARRIER USS AMERICA - THE HAWKEYE (1966)

The design of the rotodome antenna atop this E2A aircraft (formerly designated the W2F-1) resulted from NRL's development. NRL also contributed to its AN/APS-96 radar. Besides its AEW function, it provides an airborne CIC capability in intercept control of task-force defense fighters intercepting attacking aircraft.

height finding, adequate in both accuracy and target capacity, for fighter-direction by aircraft through the use of the time difference in arrival of the target echo at the radar, via the direct and the surface-reflected paths (April 1960).<sup>82</sup> This "time-difference" method was first utilized in the AN/APS-96 radar and was found to be of benefit to many subsequent Navy AEW radars. While NRL's demonstration was carried out over ocean areas, the method was shown later to have potential for use over land areas where very high levels of clutter exist (September 1963). Automatic

following for both height-finding and search functions was provided for this radar. It was arranged so that the data could be fed into the Navy's Airborne Tactical Data System (ATDS).

Another NRL contribution to the AN/APS-96 AEW radar related to moving-target indication (MTI). MTI, intended to permit observation of moving targets through clutter, was then not considered satisfactory for airborne UHF operation. Effective clutter cancellation, a major function in MTI, is dependent upon high transmitter frequency stability. This requires a master-oscillator power-amplifier type of transmitter.

## RADAR

Although the klystron-type tube was available as a final amplifier, its very large size at UHF prohibited its use in aircraft. NRL developed a UHF master-oscillator power amplifier transmitter having one-megawatt pulse output from a single final amplifier tetrode tube with high-frequency stability which made satisfactory MTI operation over ocean areas feasible in UHF radar for AEW aircraft (1957). NRL provided guidance to a contractor (RCA) for the development of the tetrode-type tube which was used in the transmitter, as modified, for the AN/APS-96 AEW radar.

Very high levels of clutter are encountered in observing aircraft targets passing through areas adjacent to or over land, as is required in certain operational situations. These levels are very much higher than those experienced over the sea, and are extremely high over high building concentrations. The Model AN/APS-96 AEW radar was seriously limited in dealing adequately with these very high clutter levels. NRL, through extensive flights with its aircraft over the various types of terrain which might have to be traversed, obtained clutter-level data to serve as a basis for the development of improved clutter cancellation in MTI systems for forthcoming AEW radar. The data were used in designing the MTI system for the AN/APS-111 radar for use in the type E2B-AEW aircraft; this system became the next in the series of UHF-AEW radars (1963).<sup>63</sup> NRL headed the Navy's team, comprising representatives from several Naval organizations, for the performance evaluation of this radar. The Model AN/APS-111 radar was not produced in quantity but served as a prototype for the Model AN/APS-120 radar, which was used in the type E2-C AEW aircraft.

### AIRBORNE SEA SURVEILLANCE RADAR

In the early wartime conduct of antisubmarine warfare (ASW), NRL's Model ASB airborne radar was effective in detecting submarines which were forced to surface from time to time to charge batteries and obtain fresh air. How-

ever, the advent of the snorkel-type submarine, with its drastically reduced exposed surface and the resulting weaker radar echoes, made detection much more difficult. The use of the AN/APS-20 AEW radar, operating at higher frequency in the microwave band, provided stronger echoes but at the expense of more sea clutter. Nevertheless, the higher transmitter power and sharper beam available at microwave frequencies provided higher power concentration at the target, resulting in a net gain in detection capability. Considerable use was made of frequencies in this region in radar for the detection of submarines.

Since the war, NRL has been the principal source of data on the characteristics of sea clutter, the primary factor in limiting radar in detecting submarines.<sup>64</sup> The data have been utilized in the design of improved ASW radars, including the AN/APS-44 (1953), AN/APS-38 (1955), AN/APS-80 (1959), and AN/APS-116.<sup>65</sup> To obtain the data, NRL has carried on a series of investigations using its aircraft equipped with multifrequency radar, obtaining data on sea clutter as a function of frequency, polarization, pulse width, elevation angle, sea state, and sea surface aspect with respect to wind direction. NRL was first to demonstrate the increased capability of detecting submarine snorkel and periscope targets in various sea states by virtue of the large reduction in the amplitude of sea clutter resulting from the use of radar with extremely short pulses (1950).<sup>66</sup>

The AEW type aircraft has continued to be used for sea surveillance. However, ASW aircraft have been developed equipped for both surveillance and attack functions. The ASW type aircraft is based on the integrated-system concept, employing several means of detection, including radar and other equipment required in effecting attacks on enemy submarines.

### OVER-THE-HORIZON (OTH) HIGH-FREQUENCY RADAR

NRL's conception of extending the range of radar beyond line-of-sight distances using two-

## RADAR

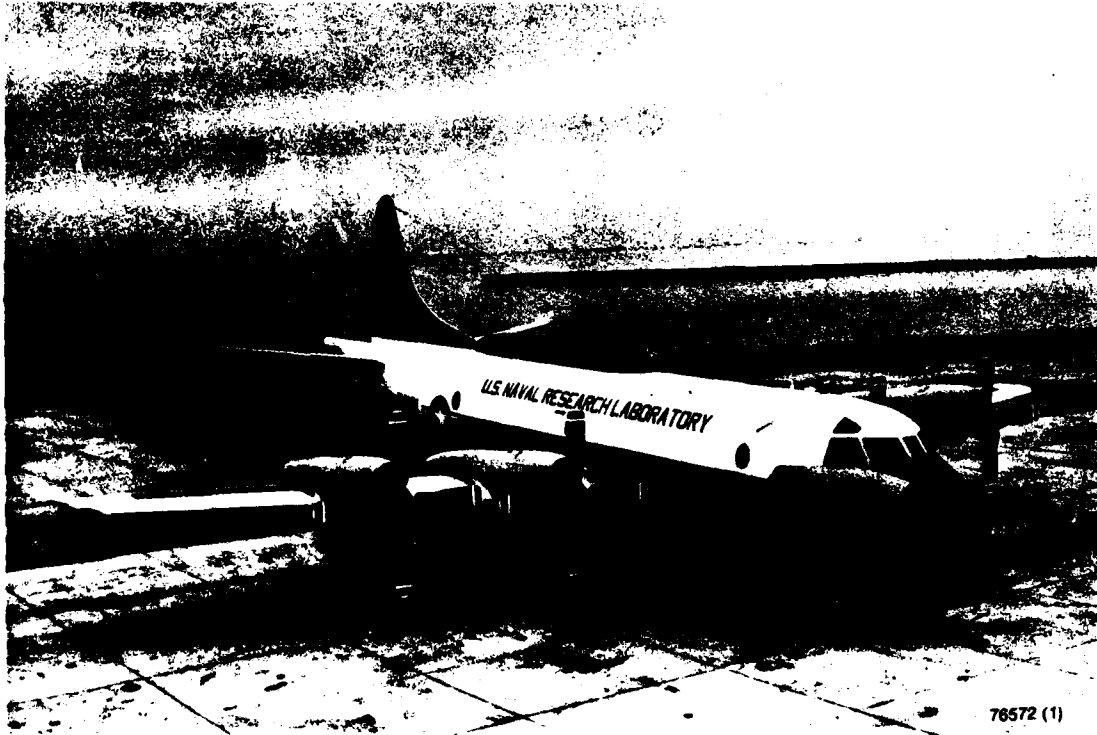

76572 (1)

### NRL'S TYPE P3A ASW AIRCRAFT, USED TO OBTAIN SEA-CLUTTER DATA

Since World War II, NRL has been the principal source of data on the characteristics of sea clutter, the primary factor in limiting ASW radar in the detection of submarines. The Model AN/APS-80 radar, installed in the nose of the type P3A ASW aircraft, is one of a series of such ASW radars based on design factors determined by use of NRL's sea-clutter data (1959).

way ionospheric refraction hinged on pioneering work it accomplished in 1926.<sup>87</sup> At that time, during research on "round-the-world" pulsed signals on 20 MHz, "splashbacks" from earth prominences were observed from the first, second, and third earth-surface reflection zones. In considering these splashback echoes, currently termed "backscatter," it was speculated that there were possibilities of detecting and ranging on targets of interest through the backscatter at the respective distances via the ionosphere.<sup>88</sup> However, it was realized that new techniques would have to be devised to deal with the combination of target signals and backscatter if an effective radar were to be provided.

<sup>87</sup>See Chapter 3 for photo recordings of backscatter.

Prior to and during World War II, priority was given to development of the required compact radars for ship and airborne operation, making imperative the use of meterwave and microwave frequencies. Inherently, this frequency range limited their operation to line-of-sight ranges. Furthermore, the very large beam antennas necessary for operation in the high-frequency band would not then be tolerated for Naval use.

During the late 1940's, NRL foresaw the need for detecting moving targets, including aircraft and missiles, at distances and altitudes which placed targets beyond line-of-sight distances. The Laboratory proceeded with a program to solve the problems involved, the most important of which was the devising of means to separate target returns from the backscatter.

## RADAR

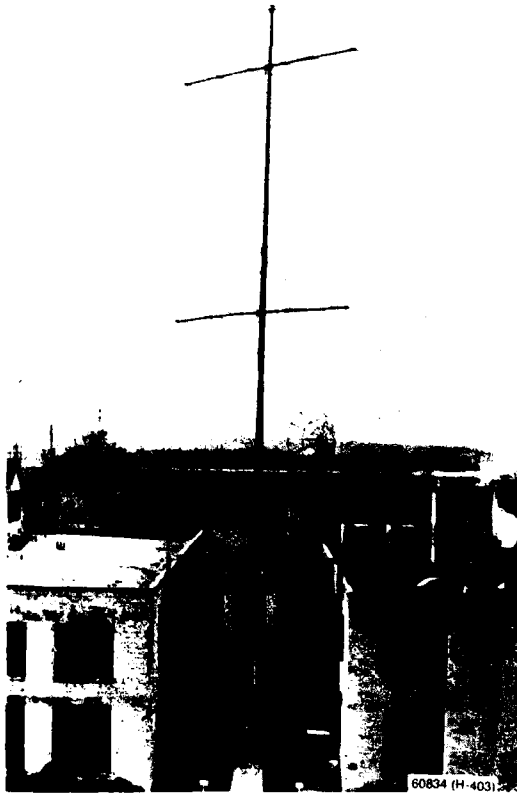

### FIRST OVER-THE-HORIZON RADAR (1954)

This radar, developed by NRL (1954) and known as "Music," was the first to detect both atomic explosions at distances out to 1700 nautical miles and missile launchings at distances out to 650 miles (1957-1958). Shown above is the radar's 26.6-MHz stacked-beam Yagi steerable antenna. Another 13.5-MHz Yagi beam antenna (not shown) was mounted on the top of the roof house on the left. Below is shown the receiving, signal-processing, and display equipment. The transmitter (2 kW average, 50 kW peak) was located in an adjoining room. The antennas and transmitter were also used in a later development, known as "Madre," employing for the first time magnetic storage and time compression for data-processing gain (fall 1958).



## RADAR

Accordingly, considerable effort was placed on determination of the frequency spectral distribution of the backscatter, which fortunately was found to be confined to a few cycles off the carrier frequency, sharply falling in intensity below the noise level at the higher frequencies. From this background information, it was evident that a combination of advanced signal processing and high ratio of average to peak pulse transmitter power, which had become available, would make possible the detection of signals from aircraft at

least in the 1000 to 2000 nautical mile range. At this juncture, it was further realized that an ability to detect aircraft at long ranges would also provide superior detection of targets of special interest. NRL, by making use of backscatter and hum filters in combination with electronic storage tubes, active doppler tracking filters, cross-correlation, and bandwidth narrowing, devised and demonstrated the first successful over-the-horizon high-frequency pulse doppler radar (1954). With this radar, NRL was

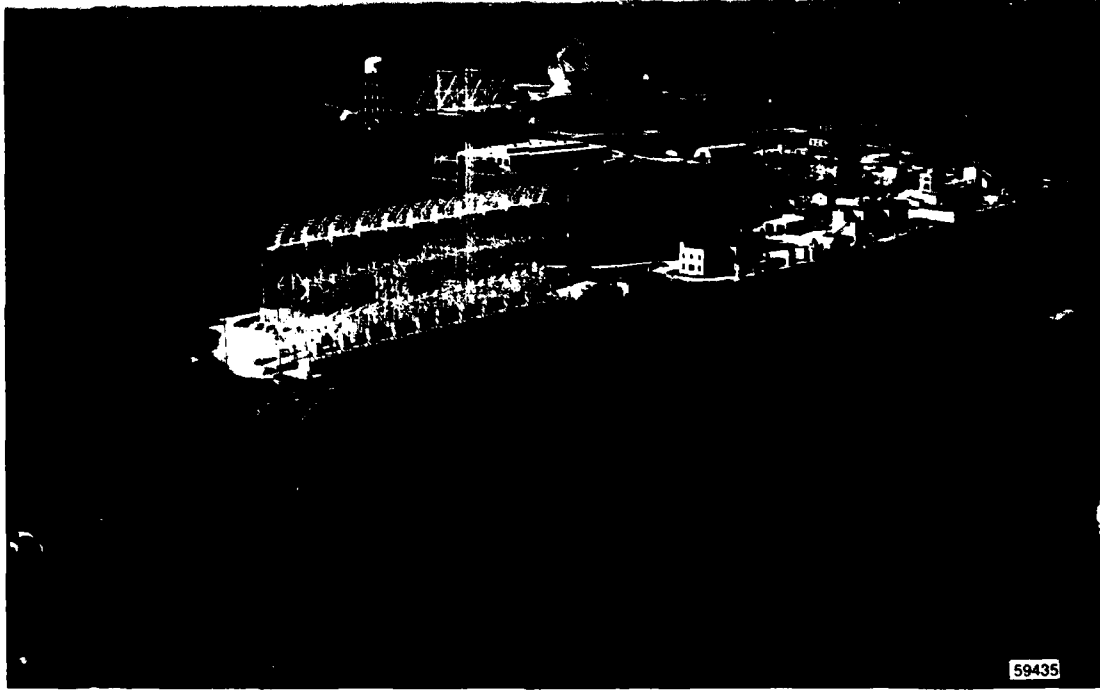

**FIRST OVER-THE-HORIZON RADAR CAPABLE OF DETECTING BOTH AIRCRAFT AND MISSILE TARGETS AT RANGES OUT TO OVER 2000 MILES OVER LAND AND SEA WATER (1961)**

Over-the-horizon radar is currently in use for the defense of the United States. This NRL-developed radar, called High Power Madre, was also first to detect low-velocity targets at ranges out to 1000 miles (1967). The radar's large fixed antenna (300 feet wide, 140 feet high) is shown in the foreground. A smaller, steerable, two-element corner reflector antenna is shown immediately to the rear. The adjacent building houses the transmitter (100 kW average, 5 MW peak), and the receiving, data-processing, and display equipment. The radar is located at NRL's Chesapeake Bay site (view looking northwest). This site, obtained in 1941, was selected and subsequently developed primarily for radar research, although other types of research, particularly for electronic countermeasures and radio communication, have been conducted there. One of the features of the site is a cliff overlooking the bay, the height of which is in the range of the heights of typical shipboard radar installations. In the background, a 150-foot-diameter parabolic steerable antenna used for general radar research can be seen.

## RADAR

first to detect missile launchings at ranges as much as 600 nautical miles and atomic explosions at distances as great as 1700 nautical miles (1957-1958). Due to the transmitter power limitations, its aircraft-detection capability was limited to within line-of-sight distances, or out to 180 nautical miles for this function. This radar was designated "Music," for "multiple storage, integration, correlation." Initially, active filters would tend to cause lock-on to the strongest target in the range gate. Subsequently, the use of a bank of reed filters permitted the display of multiple aircraft targets and the frequency spread of the backscatter as well, if desired.

In 1954 NRL devised a signal-processing mechanism using magnetic storage and time compression for processing gain. A signal processor was constructed with a sweeping filter based on these principles. NRL developed a low-power, over-the-horizon radar using this new signal processor which for the first time displayed, in real time, multiple targets, the spectral spread of the backscatter, and the spectral spread of missile launchings, all as a function of range (fall 1958). This radar was called "Madre," for "magnetic drum radar equipment."

During the period 1956 to 1958, efforts were made to proceed with a high-power (100 kW average, 5 MW peak) version of the Madre radar. This radar would include both velocity and acceleration signal processing and particularly increased dynamic range of signal processors and the radar receiver, as well as high purity of the transmitted signal. However, financial impediments delayed its availability until 1961. NRL then developed a high-power Madre radar with which it was first to demonstrate over-the-horizon performance, including detecting multiple aircraft targets and missile launchings. With this radar, NRL was also first to demonstrate the detection of aircraft and missile targets at ranges out to 2650 nautical miles over both land and sea (1961). Increased dynamic range obviated the necessity for combing out the backscatter, a feature which provided the first detection of low-

velocity targets (1967). President Lyndon Johnson, speaking in Sacramento, California, on 17 Sept. 1968, classed this development as "a major increase" in the United States capability to detect hostile missile launchings against the free world. Over-the-horizon radar, he said, makes it possible to spot enemy missiles from anywhere on earth seconds after they leave the ground.<sup>88</sup> Over-the-horizon radar is currently in use for the defense of the United States.

## REFERENCES

1. NARL letter from C.O., U.S. Naval Air Station, Anacostia, D.C. to Bureau of Engineering, 1323-A-48, 27 Sept. 1922; "Radio Telegraph—Experiments with Extremely Short Waves," NRL File S67/43-X1, "Transmissions and Reception at Ultra High Frequencies," file in Federal Record Center, NRL CRMO
2. G. Breit and M.A. Tuve, "A Test of the Existence of the Conducting Layers," *Phys. Rev.*, Vol. 28, Sept. 1926, pp. 554-575  
•O. Dahl and L.A. Gebhard, "Measurements of the Effective Heights of the Conducting Layer and the Disturbances of August 19, 1927," *IRE*, Mar. 1928, pp. 290-296  
•G. Breit, M.A. Tuve, and O. Dahl, "Effective Heights of the Kennelly-Heaviside Layer in December 1927, and January 1928," *IRE*, Sept. 1928, pp. 1236-1239  
•L.R. Hafsted and M.A. Tuve, "Further Studies of the Kennelly-Heaviside Layer by the Echo Method," *IRE*, Vol. 17, No. 9, Sept. 1929, pp. 1513-1522
3. "Radio-echo Signals from Moving Objects," NRL letter to Bureau of Engineering, C-F42-1/67 (F-4222), 5 Nov. 1930; NRL CRMO
4. "Detection of Enemy Vessels and Aircraft by Radio," Bureau of Engineering problem W5 2S, 21 Jan. 1931, NRL File S67/76, C-S67/36 (6-10-W9), 6 Dec. 1936; NRL CRMO
5. "Radio Use of Echo Signals to Detect Moving Objects," Secretary of the Navy letter to Secretary of War, Eng. C-F42-1/43 (1-4-W8), 9 Jan. 1932, NRL File C-S67-5 Radar #1; NRL CRMO
6. A. Hoyt Taylor, "Radio Reminiscences: A Half Century," NRL Library No. 359.00\*2 T238 Ref  
a. pp. 173, 1960; pp. 294-296, 1948  
b. pp. 213, 214, 1960; pp. 365-369, 1948  
c. pp. 176-180, 1960; pp. 299-307, 1948  
d. pp. 214, 215, 1960; pp. 367-371, 1948
7. "Investigate Duplex Operation Key Clicks," Bureau of Engineering letter to NRL, S67/52 (9-22-W8), 27 Sept. 1933, Problem T9-2, in NRL File S67/52, "Radio Transmitters," NRL CRMO
8. L.C. Young and R.B. Meyer, "Tests of Anti-Click Keying Unit," NRL Report 1135, Mar. 1935
9. "Radio Transmitting Equipment, Anti-Click Keying Unit," Bureau of Engineering letter to NRL, S67/52 (9-22-W8), in NRL File S67/52, "Radio Transmitters No. 9," NRL CRMO
10. R.M. Page, Log III, NRL Register 171; NRL CRMO  
a. pp. 79-97  
b. pp. 110-151
11. R.M. Page, Log IV, NRL Register 346; NRL CRMO  
a. pp. 1-22



## RADAR

- b. pp. 28-60  
 c. pp. 34-37  
 d. pp. 21-39  
 e. pp. 59-65
12. R.C. Guthrie, Log 15 Apr. 1935 to 22 June 1940, NRL Register 170; NRL CRMO
    - a. pp. 19-33
    - b. 46-53
    - c. pp. 34-35
    - d. pp. 139, 140
  13. "Radio Use of Radio to Detect Enemy Vessels and Aircraft," NRL Monthly Report C A 4/ENS (W5 2S), on Bureau of Engineering Problem W5 2S, NRL File S67/76, 6 Apr. and 5, 29 May 1936; NRL CRMO
  14. "Radio Use of Radio to Detect Enemy Vessels and Aircraft," NRL letter to Bureau of Engineering, C S67/36, 11 June 1936, copy in NRL File S67/5, "Radio Detection of Moving Objects No. 1 (6-36 to 6-39)," NRL File S67 5(36), No. 7 (10 41 to 11 41); NRL CRMO
  15. H.A. Zahl, "In Case You Have Forgotten," Signal, Oct. 1970, pp. 39-44
  16. A.A. Varela, Log 1, 1936-1938, NRL Register 156, NRL CRMO
    - R.M. Page, M.F. Distad, and L.V. Blake, Patents 2,493,775
  17. R.M. Page and L.C. Young, Patent 2,512,673
  18. R.M. Page and L.C. Young, Patent 2,688,746
  19. NRL letter to Bureau of Engineering, S S67/36, Aug. 1938, Problem W5 2S, NRL File S S67/36, No. 1 (6/36 6/39), NRL CRMO
  20. Bureau of Engineering memorandum, 28 Feb. 1938, on conference held 24 Feb. 1938, on Problem W5 2S, copy in NRL File S S67 5 No. 1, Radio Detection of Moving Objects (1936-1939), NRL CRMO
  21. Commander Atlantic Squadron letter to Chief of the Bureau of Engineering, S67/FF 3 S (S 68), 4 Apr. 1939, copy in NRL File S 67/5, "Radio Detection of Moving Objects, 1936 to 1939," NRL CRMO
  22. R.M. Page report to Commander, Atlantic Squadron, via Commanding Officer, USS NEW YORK, 3 Apr. 1939, copy in NRL File S S67 5, "Radio Detection of Moving Objects, 1936 to 1939," NRL CRMO
  23. Chief of Naval Operations memorandum OP 20 E AB, 8 May 1938, on conference held 1 May, 1938, on Special Project No. 1, NAFI, copy in NRL File S S67 5 No. 1, "Radio Detection of Moving Objects (1936-1939)," NRL CRMO
  24. C.W. Harrison and J.E. Blower, "Electronics Your Future," American Society of Naval Engineering, Feb. 1950, pp. 99-137
  25. "U.S. Navy at War," Final Official Report to SecNav by Fleet ADM E.J. King, Proc. Naval Inst., Jan. 1946, pp. 129-175
  26. "Detection of Moving Objects," NRL File S S67 5, App. Sept. 1941, jackets 5 and 6, NRL CRMO
  27. R.M. Page, R.B. Myer, T. McL. Davis, "Test of Model SC 1 Radar Equipment, submitted by General Electric Co.," NRL Report 1937, Oct. 1942
    - R.C. Guthrie, R.M. Myer, T. McL. Davis, "Tests of Model SC 2 Radar Equipment, submitted by General Electric Co.," NRL Report 2225, Jan. 1944
    - C.F. Althouse, R.A. Herring, Jr., "SK 2 Performance Test," NRL Report 2484, Mar. 1945
    - K.S. Kelleher, "Modifications of R/SK and R/SC Antennas," NRL Report 2660, Sept. 1945
  28. R.M. Page, "The Origin of Radar," Doubleday & Co., Inc., New York, 1962, NRL Library 621 3846.P133
    - a. pp. 158-162
    - b. pp. 171-172
  29. W.R. Faust, J.E. Gall, and D.M. Lowe, "XBF Search Radar Equipment," NRL Report 2429, Jan. 1945
  30. T.H. Chambers, "Investigation of Anti Jam Receivers for Search Radar," NRL Report 2392, Nov. 1944
    - A.A. Varela, T.H. Chambers, H.W. Lance, "Development of XBF 1 L Band Radar Equipment," NRL Report 2559, June 1945
  31. A.A. Varela, Log 3, NRL Register 158, July 1940 to Aug. 1941, NRL CRMO
  32. "Radio Progress on Ultra-Short Wave Transmitters," NRL letter to Bureau of Engineering, S67/43 (5025), 15 Mar. 1933, see NRL File S67/52, "Radio Transmitters," 1933, No. 7, Problem T31, NRL CRMO
  33. W.J. Cahill, "Development of Micro Ray Radio Apparatus for Use in Aircraft Altimeter Equipment," NRL Report 1111, Jan. 1935
    - W.J. Cahill, "Present Day Technique for Radio Transmission and Reception in the Micro Ray Frequency Band; 300-3000 Mc/s with Suggested Applications for Naval Purposes," NRL Report 1149, Apr. 1935
    - "Radio Micro Ray," Problem O 2S, Monthly Reports, 1933-1938, NRL File S67/35, NRL CRMO
  34. R.W. Wright and M.H. Johnson, "Removal of Mast Reflections by Harp in the SC Installation Aboard Destroyers," NRL Report 3036, Dec. 1944
    - Problems XI, N41RS, and S1409, NRL File C S67 5, 1943-1947, NRL CRMO
    - NRL File S67 7
  35. C.B. Upp, "U.S. Navy Radar Systems Survey, Second Edition," NRL Report 4128, Apr. 1953
  36. J.P. Hagen, R.B. Meyer, T. McL. Davis, "Test of the Model NBR (SN) Radar, submitted by General Electric Co.," NRL Report 2064, Dec. 1943
    - J.P. Hagen, R.B. Meyer, T. McL. Davis, "Tests of the SO Radar Equipment, submitted by Raytheon Manufacturing Co.," NRL Report 2073, May 1944
    - J.P. Hagen, R.B. Meyer, T. McL. Davis, "Tests of the Model SF Radar, submitted by The Submarine Signal Co.," NRL Report 2093, July 1943
    - J.P. Hagen, R.B. Meyer, T. McL. Davis, "Tests of the Model SF Radar Serial No. 1, submitted by Western Electric Co.," NRL Report 2094, July 1943
    - J.P. Hagen, R.B. Meyer, T. McL. Davis, "Tests of SH Radar Equipment, submitted by Western Electric Co.," NRL Report 2144, Aug. 1943
    - J.P. Hagen, R.B. Meyer, T. McL. Davis, "Systems Tests of the SI Radar, submitted by Western Electric Co.," NRL Report 2160, Jan. 1944
    - J. Peake, H.H. Judson, "Analysis of Radar Model SP Receiver and Indicator Equipment," NRL Report 2714, Jan. 1946
    - H. Davenport, C. Mayer, and F. Haddock, "An Experimental X-Band Radar Antenna for Submarine Periscope," NRL Report 3045, Jan. 1947
  37. A.A. Varela, "Proposed Very Long Radar with Height Finding," NRL Report 2759, Feb. 1946
  38. H.W. Lance, G.D.M. Peeler, C.R. Randall, "Video Mixing and Minimum Detectable Signal in the SPS 2 Radar," NRL Report 3123, Sept. 1947
    - A.A. Varela, "Interim Report on the An SPS 2 (XDQ) Radar System," NRL Report 3313, July 1948

## RADAR

- R.J. Adams, K.S. Kelleher, C.R. Lundquist. "Preliminary Design of the AN/SPS 2 (XDQ) Antenna," NRL Report 3412, Feb. 1949
- T.H. Chambers. "The High-Accuracy Logarithmic Receiver for AN/SPS-2," NRL Report 3848, Aug. 1951
- R.J. Adams, J.R. Shoemaker. "Design of the AN/SPS-2 Antenna," NRI Report 3855, Oct. 1951
- R.E. Ellis. "A Proposed Timing Control and Monitor System for the AN/SPS 2 Radar," NRL Report 3885, Nov. 1951
- E.E. Heriman. "The Elevation Angle Computer for the AN/SPS-2 Radar," NRL Report 3896, Nov. 1951
- A.L. Franta, W.H. Emerson. "High Power Waveguide Loads Utilizing Harp Material," NRL Report 3911, Dec. 1951
- T.H. Chambers. "A New Receiver Computer for Stacked-Beam Height Finding Radars," NRL Report 3925, Jan. 1952
- R.E. Ellis. "Longer Delays from Fused Quartz Delay Lines by Multiple Passage Techniques," NRL Report 3943, Mar. 1952
- A.A. Varela, W.S. Alderson, and R.E. Ellis. "The Operator Factor in the Detection of Radar Signals," NRL Report 4268, Dec. 1953
- R.M. Brown. "L Band Search Antenna for Large Ships," NRL Report 4413, Aug. 1954
- J.W. Titus. "Wind Induced Torques Measured on a Large Antenna," NRL Report 5549, Dec. 1960
- O.D. Sledge. "A Stacked Beam Antenna Using a Bifocal Reflector," NRL Report 5574, Feb. 1961
- 39 W.F. Mann, W.S. Alderson. "A Low-Frequency Radar of Modern Design," NRL Report 3815, May 1951
- I.R. Shoemaker, C.R. Randall. "200- and 435-Mc Antennas for the AN/SPS-17 Radar," NRI Report 4323, Apr. 1954
- I.V. Blake, D.J. Carlson. "A Study of 220- and 425-Megacycle Shipboard Radar for Long-Range Detector," NRI Report 4840, Nov. 1956
- 40 "Fighter Direction Goes High Hat," BuShips Electron, Dec. 1945 pp. 14-20
  - NRL letter reports to Bureau of Ships, R 3930, 33/48 and 61/48, 25 June 1948, R 3930, 26/49, 19 May 1949, NRL CRMO
- 41 "Report of Progress Problem W5 25," NRL letter to Bureau of Engineering, S 567/36, ser. 135, 26 Feb. 1940, copy in NRL File S 567/36, No. 2 (7/39-9/40), NRI CRMO
  - R.M. Page. Patent 2,770,939
- 42 R.M. Page. Patents 2,559,657; 2,629,866; 2,677,127
- 43 R.M. Page. Patents 2,452,598; 2,556,211; 2,610,319
- 44 R.M. Page. Patents 3,143,733; 3,296,615
- 45 R.M. Page. Patent 2,702,899
- 46 G.E. Pray. "Development of Type RA-46125 Experimental Models of Superfrequency Radio Receivers for Single and Double Modulation (A Part of Model XAP Equipment)," NRL Report 1737, May 1941
  - J.J. Fleming, M.S. McVay. "The Plan Position Indicator," NRL Report 1948, Nov. 1942
- 47 C.C. Mezger, E.N. Munzer. "Test on Experimental Unit Projection Plan Position Indicator Repeater, Model VG 2 Serial No. X2, Type GG 55AFL," NRL Report 2547, June 1945
  - A.C. Grosvenor. NRL letter reports to Bureau of Ships, 5110; 89 of 28 Sept. 1963; 55 of 16 Apr. 1964; 245 of 10 Nov. 1966; 19 of 4 Feb. 1966; 178 of 18 May 1967; 338 of 6 Oct. 1967; 165 of 18 July 1968; 121 of 2 July 1969; NRL CRMO
- 48 NRL letter to Bureau of Ordnance, C.F. 42 2 & C.571 8, 13 Sept. 1933, NRL CRMO
- 49 "Resume of Radio Echo Ranging and Development," Oct. 1940, NRL File 567/5, Problem W5 25; National Archive, NRI CRMO
- 50 R.M. Page. "Precision Range Indicating System," Patent 2,556,212
- R.M. Page. "Radio Locator System," Patent 2,929,356
- 51 A.H. Schooley. "Tests of the Bell Laboratories and Arma Corp. Automatic Radar Equipment Used in Conjunction with a Mark 37 Director, Mark 1, Model 2 Computer and a Mark 4 Radar System," NRL Report 1955, Nov. 1942
- 52. NRL Progress Report to Bureau of Ships for July-Aug. 1941, S 567/36/A6, 30 Sept. 1941; copy in NRL File S-567-5, jacket 5; NRL CRMO
  - R.M. Page. Patent 2,948,893
- 53. NRL Consulting Services Reports, 13 July 1937, 5 Nov. 1937, 30 Mar. 1939, 18 May 1939, 26 May 1939, 29 June 1939, NRL CRMO
- 54. NRL Consulting Services Report, 23 July 1940, NRL CRMO
- 55. R.J. Adams. "Study of the Radiation Patterns of the CW66 AAF Antenna (Modified FD Radar Equipment)," NRL Report 2201, Nov. 1943
  - C.B. Cunningham, L. Schlesinger. "Installation and Operation of Mark 4 Mod. 1 Serial 285 Radar Equipment on the USS MURPHY, DD603," NRL Report 2291, May 1944
- 56. T.H. Chambers. "Development of Mk 12 A J Receiver," NRL Report 2507, Nov. 1945
  - C.F. White. "Automatic Radar Equipment Mk 12 Mod. 2, Gun Director Mk 37, Computer Mk 1 System Operation with and without Manually Controller Computer Equalizer," NRL Report 2657, Oct. 1945
  - L.W. Sessions, A.J. Stecca. "The Development and Testing of Pulse Doppler Aural Range Devices for Radar Equipments Mark 4 and Mark 12," NRL Report 2898, Dec. 1945
- 57. J.P. Hagen, R.B. Meyer, T. McL. Davis. "Tests of the Mark 8 Radar Equipment, submitted by Western Electric Co.," NRL Report 2224, no date
  - A.C. Grosvenor. "Modification of Radar Mk. 8 Precision Sweep and Change of Bearing Lines, Final Report," NRL Report 2461, Feb. 1945
- 58. H. Davenport, C. Mayer, F. Haddock. "An Experimental X Band Radar Antenna for Submarine Periscope," NRL Report 3045, Feb. 1947
- 59. R.M. Page. Patent 2,628,350
- 60. J.P. Hagen, R.B. Meyer, and T. McL. Davis. "Tests of the Mark 9 Radar Equipment, submitted by Western Electric Co.," NRL Report 2116, July 1943
- 61. M.S. McVay. "Test of Tracking Accuracy of Gun Director Mk 37 with Radars Mk 28 Mod 0 and Mk 22 Mod 0," NRL Report 2550, June 1945
  - L.R. Dobler, J.R. Shoemaker. "A Lobing Mark 32 Array for Fire Control Radars Mark 28 Mod. 0 and Mod. 3," NRL Report 2791, Apr. 1946
  - B.H. Stafford, T.W. Chapelle, P.B. Coggins, V.C. Gallagher. "Tracking Performance of the Automatic Radar Equipment Mark 25 Mod. 2 (Experimental Model) with the Gun Director Mark 37 and Computer Mark 1," NRL Report 2819, May 1946
  - C.H. Shaw, P. Waterman. "A Joint Report on the Development of Gun Fire Control System Mark 61 Mod. 0-2," NRL Report 3022, Apr. 1947
  - R.M. Page, I.B. Trevor, Jr. "Shipborne Radar Fire Control from the System Viewpoint," NRL Report 3091, May 1947
  - C.F. White, I.J. Neilon. "Radar Mk 25 Low Angle Tracking Improvement by Error Signal Limiting, Servo Bandwidth Reduction, and Computer Modification," NRL Report 4329, Apr. 1954
  - A Study of the System Vulnerability of the Radar Mark 12 to Electronic Jamming," NRI Report RA 3A 222 A, Dec. 1944, NRL Document 406,759
  - O.F. Tom, Jr., P.J. Allen. "An Electronically Lobed Tracking and

## RADAR

- Guiding Radar," NRL Report 3116, June 1947
- J.H. Dunn and D.D. Howard, "Phenomena of Scintillation Noise in Radar Tracking System," IRE, May 1959, pp. 856-863
  - 64. J.B. Trevor, Jr., A.E. Hastings, "Analysis and Specifications of Simultaneous Lobing System Tab," NRL Report 2554, July 1945
    - H.L. Gerwin, "Design and Development of Antennas and R.F. Components for Simultaneous Lobing Radar," NRL Report 3042, Jan. 1947
    - R.M. Page, "Monopulse Radar," IRE National Convention Rec. ord. Vol. III, Part 8, 1955, pp. 132-134
    - J.H. Dunn and D.D. Howard, "Precision Tracking with Monopulse Radar," Electronics, 22 Apr. 1960
    - R.M. Page, Patent 2,929,056
  - 65. H.L. Gerwin, A.E. Hastings, "Further Design and Development of Components for Simultaneous Lobing Radar TAB," NRL Report 3221, Jan. 1948
    - E. Quigley, H.J. Riblet, T.S. Saad, "Compact Simultaneous Lobing Circuits," NRL Report 3341, Nov. 1948
    - A.E. Hastings, "Methods of Obtaining Amplitude-Frequency Spectra," NRL Report 3466, May 1949
    - A.M. King, "Analog Signal Simulator for Monopulse Radars," NRL Report 3565, Apr. 1949
    - R.J. Mackey, Jr., "An Improved Range Error Detection System for MK 50 Simultaneous Lobing Radar," NRL Report 3579, Dec. 1949
    - D.D. Howard, B.L. Lewis, "Tracking Radar External Range Noise Measurements and Analysis," NRL Report 4602, Aug. 1955
    - A.J. Stecca, N.V. O'Neal, "Target Noise Simulator Closed-Loop Tracking," NRL Report 4770, July 1956
    - B.L. Lewis, A.J. Stecca, D.D. Howard, "The Effect of an Automatic Gain Control on the Tracking Performance of a Monopulse Radar," NRL Report 4796, July 1956
    - B.L. Lewis, D.D. Howard, "Radar Tracking Noise in Theory and Practice," NRL Report 4830, Nov. 1956
    - D.D. Howard, "Radar Tracking Noise Reduction by Diversity Techniques," NRL Report 5049, Dec. 1957
    - D.D. Howard, "Radar Target Angular Scintillation in Tracking and Guidance Systems Based on Echo Signal Phase Front Distortion," NRL Report 5430, Dec. 1959
    - D.D. Howard, "A New Broadband, Efficient, and Versatile Feed for the Monopulse Tracking Radar," NRL Report 5559, Dec. 1960
  - 66. "Airborne Radar," NRL File S F42 5, May 1941-Dec. 1942; NRL CRMO
    - "50 Years of Naval Avionics," U.S. Naval Aviation Electronics Digest, Aug. 1961, pp. 23-39
  - 67. A.C. Grosvenor, F.D. Schaller, "Systems Test of the Models ASG and XASG Radar Equipments, submitted by Philco Co.," NRL Report 2045, Apr. 1943
    - I.W. Fuller and M.L. Burnett, "Interim Report of Type Tests of AN/ASG-10," NRL Report 2609, Aug. 1945
    - I.W. Fuller and M.L. Burnett, "Type Test of AN/ASC-10 Toss Bombing Device, Final Report," NRL Report 2694, Nov. 1945
    - I.W. Fuller, M.L. Burnett, "Additional Report on Vibration Test of AN/ASG-10 Toss-Bombing Device," NRL Report 2837, May 1946
  - 68. I.W. Fuller, M.L. Burnett, "Final Report on Type Test of TD-4/APS-3 Target Discriminator," NRL Report 2867, June 1945
  - 69. C.B. Barnes, "Type and Systems Test of AN/APS-4A," NRL Report 2959, Sept. 1946
  - 70. M.L. Burnett, I.W. Fuller, "Interim Report on Type Test, AN/APS 19," NRL Report 2997, Oct. 1946
    - "New Search Intercept Radar," U.S. Navy Airborne Electronics Digest, Aug. 1946, pp. 3-5
  - 71. "All-Weather Fighter, An Aircraft Designed Around Radar," U.S. Naval Aviation Electronics Digest, Sept. 1949, pp. 28-33
  - 72. "AN/APQ-41 Fire Control Radar for Jets," U.S. Naval Aviation Electronics Digest, Mar. 1952, pp. 24-31
  - 73. J. Ryon, C. Loughmiller, M. Schmookler, R. Lister, I. Bellavin, "Parametric Design Requirement Study for an Advanced F4H-1 Weapons System," NRL Report 5812, June 1962
    - R. Lister, D. Eckel, C. Loughmiller, "A Study of the Second-Launch Capability of the Advanced F4H Weapon System," NRL Report 6027, May 1964
    - P. Waterman, C.M. Loughmiller, J.C. Ryon, I.N. Bellavin, and R.L. Lister, "Design and Development Program for F4H-1 and F8U-3 Weapon Systems," and "Summary of Navy Study Program for F4H-1 and F8U-3 Weapon Systems," NRL Memo. Rept. 754, Vols. I through XV (Vols. V and VI never issued) publication starting Nov. 1957
    - C.M. Loughmiller, M. Schmookler, and R.L. Lister, "Navy Air-to-Air Missile Study Trends in High Speed, High Altitude Attacks," NRL Memo. Rept. 1289, Feb. 1962
    - R. Aberg, C. Francis, J. Ryon, I. Bellavin, and C. Loughmiller, "Navy Air-to-Air Missile Study Fire Control Requirements," NRL Memo Rept. 1372, Oct. 1962
    - C. Loughmiller, R. Lister, and J. Ryon, "Probability of Occurrence of Target Aspect Angle for F4H-1 Weapons System," NRL Memo Rept. 1508, Mar. 1964
    - C. Loughmiller and R. Lister, "Effects of Target Maneuvers on Sparrow 1116b Launch Envelopes," NRL Memo. Rept. 1518, Feb. 1964
  - 74. E.H. Krause, "Achievements of NRL During Period July 1941 to June 1945," NRL Memorandum to Superintendent, Radio Division, 18 June 1945; NRL File S-S67/33, NRL CRMO
  - 75. C.B. Barnes, I.W. Fuller, "Interim Report on Type Test of AN/APS 20A," NRL Report 2809, Apr. 1946
    - C.B. Barnes, I.W. Fuller, "Interim Report on Type Test of AN/APS-20A," NRL Report 2957, Aug. 1946
    - "Radar Range Increased by AEW," U.S. Navy Airborne Electronics Digest, Nov. 1945, pp. 3-16
    - "Cadillac II--The Flying CIC," U.S. Navy Airborne Electronics Digest, Apr. 1946, pp. 3-6
    - "Altitude Insertion for AN/APN-16," U.S. Navy Airborne Electronics Digest, Aug. 1947, p. 24
    - "Airborne CIC, High Flying Nerve Center for Fleet Tactics," U.S. Naval Aviation Electronics Digest, Sept. 1949, pp. 3-7
    - "AN/APX-6 Airborne IFF Equipment," U.S. Naval Aviation Electronics Digest, Sept. 1950, pp. 6-8
    - "AN/APS-20B--High Power and Exceptional Sensitivity are Features of New Multipurpose Radar," U.S. Naval Aviation Electronics Digest, Sept. 1953, pp. 3-14
    - "Status Report on AEW," U.S. Naval Aviation Electronics Digest, Sept. 1957, pp. 3-7
  - 76. C.T. Curtis, "Off Frequency Beacon Receiver Attachment for APS-20 Radar," NRL Report 3121, June 1947
  - 77. "Status Report on AEW from the Chief of Naval Operations," U.S. Naval Aviation Electronics Digest, Sept. 1957, pp. 3-7
    - "Landbased AEW Aircraft Systems, WV 2, WV 3, WV 2E," U.S. Naval Aviation Electronics Digest, Sept. 1957, pp. 8-16
    - "AD 5W, WF 2, W2F 1 Carrier Based AEW Aircraft Systems," U.S. Naval Aviation Electronics Digest, Sept. 1957, pp. 17-26
    - "ZPG 2W, ZPG 2W (Modified), ZPG 3W Lighter Than Air AEW Systems," U.S. Naval Aviation Electronics Digest, Sept. 1957, pp. 27-36
    - "AN/APS 82 and AN/APS 87, Possible Replacements for the

## RADAR

- AN/APS-20E." U.S. Naval Aviation Electronics Digest, Oct. 1957, pp. 11-17
- "WF-2 Tracer, A New Carrier-Based AEW/AIC Aircraft." U.S. Naval Aviation Electronics Digest, Mar. 1960, pp. 4-29
78. "AN/APS-70, UHF Radar for AEW Features AMTI," U.S. Naval Aviation Electronics Digest, Oct. 1957, pp. 3-8
- AN/APS-62, Height Finding Radar for Blimps," U.S. Naval Aviation Electronics Digest, Oct. 1957, pp. 9, 10
  - "AN/APS-82 and AN/APS-87, Possible Replacements for the AN/APS-20E." U.S. Naval Aviation Electronics Digest, Oct. 1957, pp. 11-17
79. A.L. Franta, R.A. Herring, Jr., J.R. Shoemaker, "An Experimental UHF Radar for AEW," NRL Report 4505, Mar. 1955
- A.M. Knopp, R.L. Eilbert, and G.W. Herman, "Performance of an Experimental 220-Mc Radar on an Airship," Report of NRL Progress, Dec. 1959, pp. 1-9
80. "Status Report on AEW from the Chief of Naval Operations," U.S. Naval Aviation Electronics Digest, Sept. 1957, pp. 3-7
- "AN/APS-70, UHF Radar for AEW Features AMTI," U.S. Naval Aviation Electronics Digest, Oct. 1957, pp. 3-17
81. F.L. Hennessey, B.D. Wright, "Antennas for W2F-1 Rotodome Aircraft," NRL Report 5493, Aug. 1960
- R.L. Jennings, "AN/APS-96 Search Radar, Part I General Introduction," U.S. Naval Aviation Electronics Digest, Aug. 1964, pp. 3-14
  - R.L. Jennings, "AN/APS-96 Search Radar, PART II Pulse Compression and Matched Filter Theory," U.S. Naval Aviation Electronics Digest, Nov. 1964, pp. 27-36
  - R.L. Jennings, "AN/APS-96 Search Radar, PART III AMTI Theory," U.S. Naval Aviation Electronics Digest, Nov. 1964, pp. 49-62
82. I.V. Blake, "A Proposed Method of Height-Finding with VHF and UHF Airborne Radar," NRL Report 4549, June 1955
- T.H. Chambers, "A Frequency-Modulated Height-Finding Radar Operating on the Interference Principle," NRL Report 4738, Apr. 1956
  - L.G. McCracken, "Height-Finding Radars Based on the Image Principle. Part I--Lobe-Counting Method on the Basis of a Flat-Earth Model," NRL Report 4756, no date
  - L.G. McCracken, "Height-Finding Radars Based on the Image Principle. PART II: Lobe-Counting Method on the Basis of a Spherical-Earth Model," NRL Report 5062, Jan. 1958
  - L.G. McCracken, "Height-Finding Radars Based on the Image Principle. PART III The Frequency-Modulation Method," NRL Report 5063, Jan. 1958
  - A.L. Franta, J.N. Libby, A.E. Leef, O.F. Borchardt, "Airborne Height-Finding by the Frequency-Modulation Method," NRL Report 5415, Dec. 1959
  - J.M. Goodman, "Analysis of Matched-Filter Radar Multipath Returns at 435 MC," NRL Report 5767, Apr. 1962
  - W.A. Douglas, D.F. Hemenway, and A.E. Leef, "Design and Initial Flight Tests of the NRL Matched Filter Radar," NRL Memo. Rept. 1108, Dec. 1960
83. "Jane's All the World's Aircraft," 1967-1968, p. 265, NRL library 629.13.J2.
84. E.F. McClain, W.R. Ferris, "Reflectivity of Sea Surface for Doppler Radar," NRL Report 3418, Feb. 1949
- "Annual Technical Report, Fiscal Year 1948," NRL Report 3420, 1948
- C.O. Olson, "The Investigation of High-Resolution Radar Phenomena, Part I Short-Pulse Transmitter," NRL Report 3501, July 1949
  - N.L. Davis, "An Investigation of High-Resolution Radar Phenomena, Part II, High-Speed Oscilloscopy," NRL Report 3568, Nov. 1949
  - J.R. Conlon, "High-Resolution Radar. PART II Sea Clutter Measurements," NRL Report 4951, Aug. 1957
  - G.F. Myers, "High-Resolution Radar. PART III Sea Clutter," NRL Report 4952, July 1957
  - G.F. Myers, "High-Resolution Radar: Part IV Sea Clutter Analysis," NRL Report 5191, Oct. 1958
  - W.S. Ament, J.A. Burkett, F.C. MacDonald, D.L. Ringwalt, "Characteristics of Radar Sea Clutter: Observations at 220MC," NRL Report 5218, Nov. 1958
  - J.C. Daley, J.T. Ransone, J.A. Burkett, and J.R. Duncan, "Sea-Clutter Measurements on Four Frequencies," NRL Report 6806, Nov. 1968
  - J.C. Daley, J.T. Ransone, J.A. Burkett, and J.R. Duncan, "Upwind-Downwind-Crosswind Sea-Clutter Measurements," NRL Report 6881, Apr. 1969
  - G.R. Valenzuela and M.B. Laing, "Study of Doppler Spectra of Radar Sea-Echo," NRL Report 6934, Nov. 1969
  - J.C. Daley, W.T. Davis, and N.R. Mills, "Radar Sea Return in High Sea States," NRL Report 7142, Sept. 1970
  - M.B. Laing, "The Upwind/Downwind Dependence of the Doppler Spectra of Radar Sea Echo," NRL Report 7229, Jan. 1971
  - J.C. Daley, J.T. Ransone, and J.A. Burkett, "Radar Sea Return - JOSS I," NRL Report 7268, May 1971
  - J.W. Wright, "Back Scatter from Capillary Waves with Application to Sea Clutter," IEEE Trans., Propagation and Antennas, Nov. 1966, pp. 749-754
  - J.W. Wright, "A New Model for Sea Clutter," IEEE Trans., Propagation and Antennas, Mar. 1968, pp. 217-223
85. "AN/APS 44A Megawatt Search Radar," U.S. Naval Aviation Electronics Digest, Oct. 1953, pp. 16-22
- "AN/APS 38A, New Radar for ASW," U.S. Naval Aviation Electronics Digest, Jan. 1955, pp. 27-34
  - "The New PSM Improvement Program Features Integrated ASW System," U.S. Naval Aviation Electronics Digest, May 1959, pp. 4-19
  - U.S. Naval Aviation Electronics Digest, Sept. 1959; entire issue
    - "Status Report on Patrol ASW Aircraft"
    - "AN/APS 80 Radar, Replaces AN/APS-44 for ASW in P5M"
    - "AN/APA 125A, Indicator Group for AN/APS-80 in P5M"
    - "Navigational Computer Group AN/ASA-13A"
    - "Display Plotting Board Group OA-1768/ASA-13, Provides Automatic Ground Track Plotting"
- "AN/APS 88 Radar for ASW in S2F-3," U.S. Naval Aviation Electronics Digest, Apr. 1960, pp. 4-7
  - "S2F-3, Updated Carrier ASW Airplane," U.S. Naval Aviation Electronics Digest, July 1960, pp. 13-16
  - "The New P2V ASW System Concept," U.S. Naval Aviation Electronics Digest, Jan. 1961; entire issue
  - "P3V-1 Orion," U.S. Naval Aviation Electronics Digest, Mar. 1962, pp. 17-49
  - "AN/ASN-361NS, Inertial Navigation System in the E-2A," U.S. Naval Aviation Electronics Digest, July 1964, pp. 3-16

## RADAR

- "Low-Noise Microwave Receivers," U.S. Naval Aviation Electronics Digest, July 1964, pp. 17-26
- 86. C.O. Olson, "The Investigation of High-Resolution Radar Phenomena, Part I—Short-Pulse Transmitter," NRL Report 3501, July 1949
- 87. A. Hoyt Taylor and E.O. Hulburt, "Wave Propagation at High Frequencies," NRSR, 1 Sept. 1925, pp. 42-58
  - E.O. Hulburt, "On Round-The-World Signals," IRE, Mar. 1928, pp. 287-289
  - A. Hoyt Taylor and L.C. Young, "Studies of High-Frequency Radio Wave Propagation," IRE, May 1928, pp. 561-578
  - A. Hoyt Taylor and L.C. Young, "Studies of Echo Signals," IRE, Vol. 17, No. 9, Sept. 1929, pp. 1491-1507
- 88. "Beams that Add Precious Minutes," Business Week, 9 Mar. 1966, pp. 70-76

## Chapter 5

### RADIO REMOTE CONTROL—MISSILE GUIDANCE

#### INTRODUCTION

Prior to World War I, experiments on remote control by radio had been carried out by several investigators in this country, notably Nikola Tesla (1898), Professor Harry Shoemaker (1905), and John Hays Hammond, Jr. (beginning 1910), seeking to demonstrate the practicality of application, particularly to torpedoes. The Navy had considered the Hammond system, and in order to determine its vulnerability to countermeasures jamming engaged in a cooperative test of the system with Hammond. The USS DOLPHIN was provided with equipment to jam the radio-control circuit of a surface weapon carrier. In the test the USS DOLPHIN was unable to jam the carrier control circuit until within 250 feet of the carrier (1914). The government considered the project ready for development as a service weapon. Congress provided funds, and the President appointed a Board with representatives from the Army and the Navy to oversee the project (1916).<sup>1</sup> After extended consideration, the Board was not convinced of the utility of the system as demonstrated. Subsequently, additional legislation transferred responsibility for the project to the War Department, and when this department withdrew from the project the responsibility devolved upon the Navy (1921).

In 1919, the Navy on its own accord conducted an experiment to determine whether radio-frequency energy could penetrate the sea to a submerged trailing-wire antenna and provide a signal sufficient to actuate a torpedo control mechanism. An F-5-L seaplane from an altitude of 1700 feet was used to transmit signals to the submarine N-6, submerged, simulating the torpedo. To radiate effectively from the seaplane

at the low radio frequency used, a researcher who later became an NRL staff member devised a huge trailing-wire loop antenna that could be reeled out after the plane was airborne. The receiving antenna was a 300-foot insulated wire supported on floats from the submarine at a depth of six feet. The signal strength received in the submarine (SE-1420 receiver, two-stage audio amplifier) from the aircraft transmitter (type SE-1130, 85 watts, 188 kHz) at a distance of five miles was found to be several times that required to operate the control equipment. From the propagation standpoint, it was concluded that the feasibility of radio control of torpedoes was proven.<sup>2</sup> Work continued on the project, and a successful run with an unarmed torpedo at a depth of six feet was made, with the controlling station about three miles distant, using 10 kW for transmission (150 to 200 kHz) for control and a 150-foot trailing-wire antenna for reception on the torpedo. In final tests, the requirement of a 9000-yard run at a depth of 12 feet was met (1925). The project was terminated in 1932, with the government acquiring the Hammond patent rights.

After World War I, bitter controversy arose concerning the vulnerability of the Navy's capital ships to bombing by aircraft, with claims made that one bomb could sink a battleship. In preparing for tests to settle the matter, the Navy designated the old battleship USS IOWA as a target ship and the battleship USS OHIO as a control ship. The ships were equipped so that the USS OHIO could control the USS IOWA remotely by radio, with the latter unmanned. In testing the system, over 100 radio signals transmitted from the USS OHIO functioned properly to maneuver the USS IOWA from a distance of

## RADIO REMOTE CONTROL - MISSILE GUIDANCE

8000 yards. On the day of the attack, 88 radio-control signals were transmitted, all of which functioned. Attacking aircraft were able to make but two direct hits on the forecastle of the USS IOWA, causing exceedingly little damage (1921).<sup>3a,4</sup> Doomsday for battleships had not yet arrived! Eventually the battleship USS IOWA, while being maneuvered under radio control, was sunk in Panama Bay at long range by fire from the 14-inch guns of the battleship USS MISSISSIPPI. A representative from NRL witnessed the operation from the USS CALIFORNIA, 1000 yards from the USS IOWA (1923). To improve the capability of remote control by radio, NRL devised a system which

was successfully used to maneuver the target ships, the destroyer USS STODDERT (1925-1928), and the battleship USS UTAH (1932-1933).<sup>3b,5</sup> The steering and throttle controls were operated through the employment of selector switches based on the teletype mechanism using the Baudot code, resulting from NRL's early work on the remote radio control of aircraft.

### FIRST FLIGHT OF A RADIO-CONTROLLED PILOTLESS AIRCRAFT

The Navy's interest in the development of a "flying bomb" resulted in a project to provide

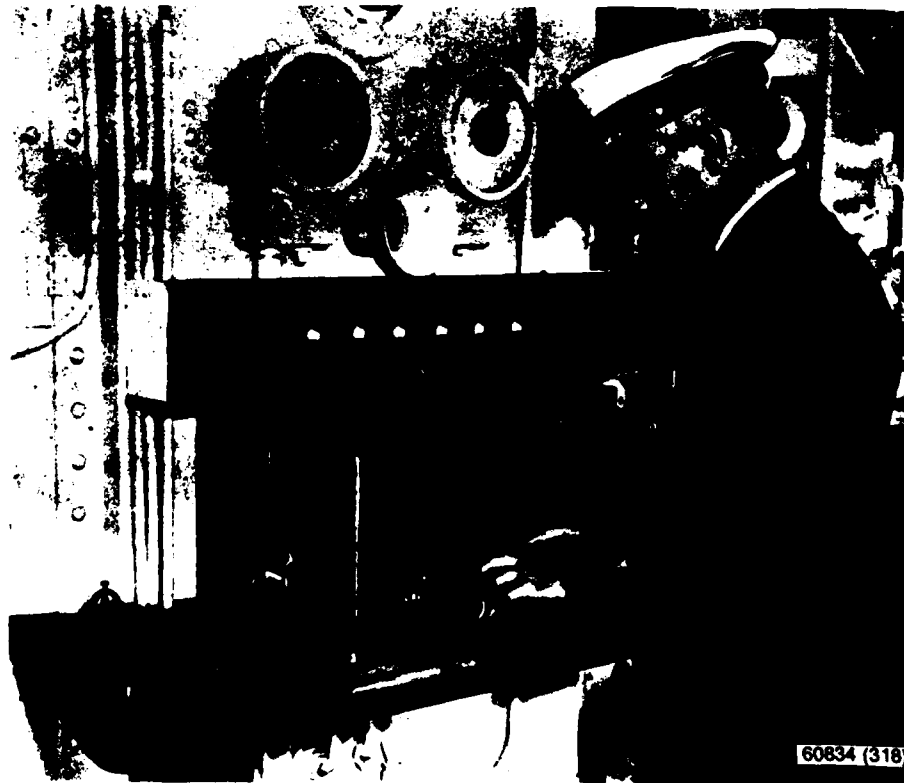

RADIO REMOTE CONTROL OF SHIPS

LT J. B. Dow (later a Commodore) is shown operating the radio equipment based on NRL's developments for remote control of ships (1932). The equipment was used to maneuver remotely the battleship USS STODDERT.

## RADIO REMOTE CONTROL—MISSILE GUIDANCE

a radio remote-control system for such a weapon sponsored by the Bureau of Engineering, in cooperation with the Bureau of Ordnance. This work was begun by researchers who later became NRL staff members (1922). The previously mentioned selector-switch control device permitted only a single operation at a time, which, while satisfactory for the control of the target ships *USS STODDERT* and *USS UTAH*, was not suitable for aircraft control, which required several functions to be controlled at one time. To permit several operations to be controlled simultaneously, NRL devised a selective relay using a tuned electromagnetically driven reed with a small, tuned steel wire attached, the end of which formed the contact. The loose mechanical coupling between the reed and the wire provided high mechanical selectivity at audio frequencies. NRL also devised a control switch

with a vertical handle, similar to the control stick of an aircraft, which could operate selective relays simultaneously to provide for the several controls necessary to the flight of aircraft. These devices were first applied to a three-wheel cart system, christened the "electric dog," which could be seen at intervals wandering about on NRL's driveways. Using these devices, NRL developed the remote radio-control system for the first pilotless flight of an aircraft remotely controlled by radio, precursor of the radio guided missile (September 1924).<sup>6,7a</sup> The aircraft, a Navy type N-9 plane equipped with pontoon landing gear, was remotely controlled by radio from the ground in its takeoff from the Potomac River near Dahlgren, Virginia, guided on a triangular course, put into glides and climbs, and then landed on the river. The aircraft had actually been flown

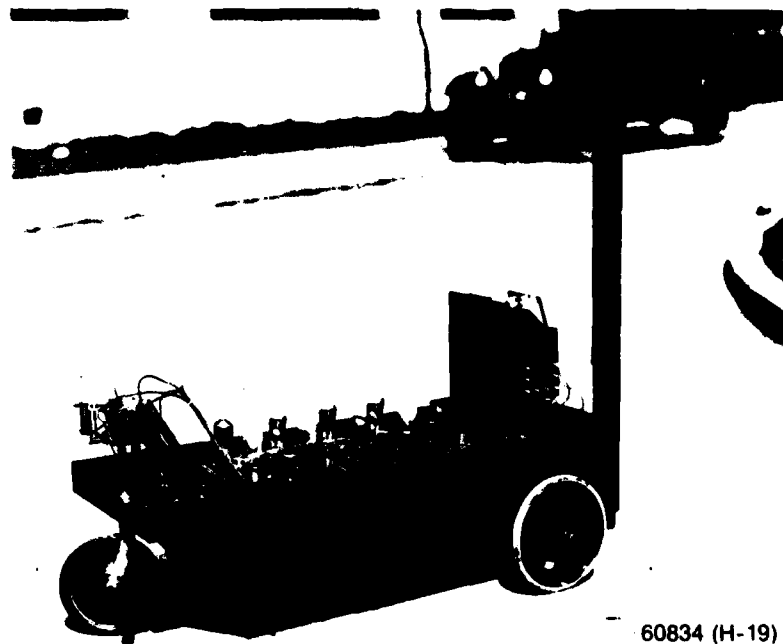

60834 (H-19)

THE NRL "ELECTRIC DOG"

The "Electric Dog" could be seen at times moving along NRL's roads, remotely controlled by a radio system devised by NRL (1923). This device was one step in the development of the radio remote-control system for the first pilotless flight of an aircraft.



RADIO REMOTE CONTROL—MISSILE GUIDANCE

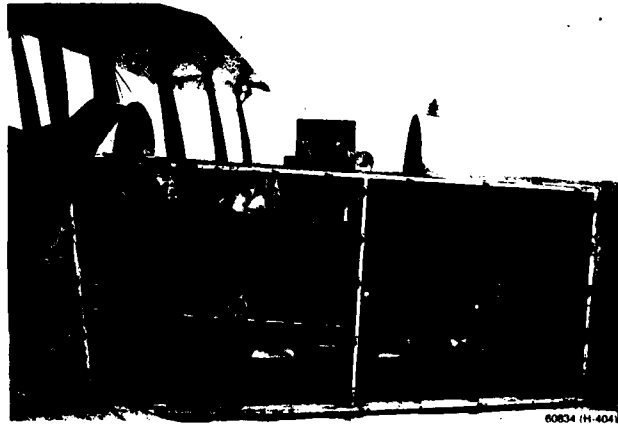
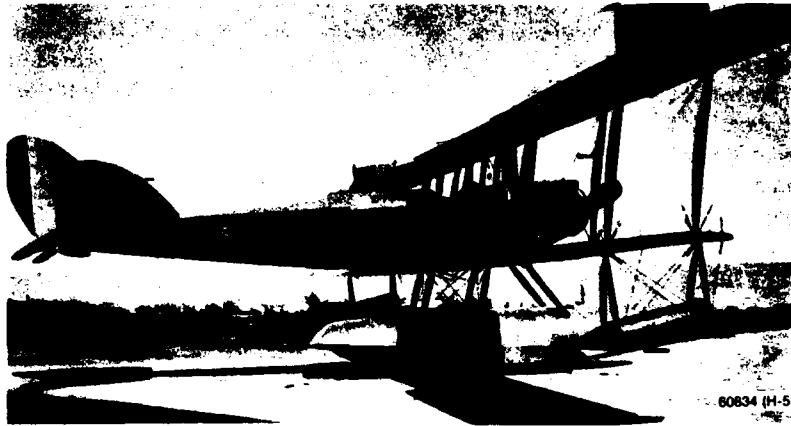

60834 (H-405)



THE FIRST FLIGHT OF A PILOTLESS AIRCRAFT

This aircraft (top photo), an N-9 float plane (No. 2602), was used in the first radio-controlled flight experiments near Dahlgren, Virginia (1924). NRL developed the radio remote-control system for these experiments. The radio-control equipment is shown in the middle photo. The lower photo shows the ground-operated control panel, with control stick and relays.

successfully under remote radio control during the summer of 1923, but with a pilot aboard to be available in case of failure. It is of interest that the "control stick" used for steering the German radio-controlled missiles released from aircraft during World War II was practically identical with that devised by NRL for this project.

### RADIO REMOTE CONTROL OF TRANSMITTERS

To permit time-signal coverage of the Caribbean Sea by transmissions from the Navy's radio station at Key West, Florida, NRL staff members, prior to establishment of the Laboratory and their transfer here, provided remote radio-control equipment which caused the Key West station to repeat the time signals from the Navy's station at Annapolis, Maryland (1922).<sup>8</sup> For the control by the Navy Department of the first high-power, high-frequency transmitter, NRL provided a radio remote-control system as a link from the Washington Navy Yard to the transmitter, which was located at NRL (1924-1925).<sup>9</sup> At that time wire lines for control were not available from the yard to the Laboratory, and the link allowed the use of NRL's transmitter as soon as it became available. In 1933, the Laboratory was requested by the Bureau of Engineering to demonstrate the feasibility of the radio control of the several radio transmitters at the Annapolis, Maryland, radio station from "Radio Control," located at the Navy Department in Washington, D.C. This assignment was accomplished, and at the same time the determination of propagation factors was made over the circuit within a range of 30 to 100 MHz. The Navy's first operational transmitter remote radio-control system capable of the control of five transmitters at the Annapolis Station resulted (1934).<sup>10</sup>

### RADIO-CONTROLLED DRONES

For many years the Navy had used target sleeves towed by aircraft to provide targets for the training of antiaircraft gun operators. As the

performance of aircraft advanced, permitting greater maneuverability and the use of evasive tactics, the Navy became increasingly aware of the need for more realistic target-practice facilities than the uniformly moving sleeves. In May 1936, the Chief of Naval Operations requested the Bureau of Aeronautics and the Bureau of Engineering to proceed with the development of unmanned radio-controlled aircraft to serve as targets, later given the name "drones" by NRL.<sup>3c,11</sup> This work brought about a cooperative project, with LCDR D. S. Fahrney (later RADM Fahrney) as officer-in-charge, in which the Naval Aircraft Factory at Philadelphia was assigned responsibility for the aircraft and NRL the responsibility for the radio-control system (1936).

In carrying out its part of the drone program, NRL devised the first radio remote-control system, including the electromechanical airfoil controls, with reliability adequate for satisfactory operation of the several flight functions necessary in the remote control of aircraft in flight. A simulated drone including this system was demonstrated by NRL to the Assistant Secretary of the Navy, then the Honorable Charles Edison, and many high-ranking Naval officers on 17 Feb. 1937. During the demonstration, the drone was controlled by radio from a type TU-2 mother plane at distances out to 25 miles (19 Nov., 1937).<sup>3d,7,12</sup> For the system, NRL developed a new reed-type filter to provide the necessary selectivity for segregating the transmitted audio-frequency modulated signals independently to control the flight functions such as aileron, elevator, throttle, and autopilot controls. In the new filter, the reed, driven magnetically by the signals at its resonant frequency, served to vary the magnetic flux through a coupled coil and thus provide the energy to actuate the control relay. This technique avoided the difficulties encountered in the earlier filter, which used a vibrating contactor. This system was further improved later, in view of its vulnerability to jamming, through the use of the proper number of closely spaced supersonic-frequency channels

superimposed on the carrier frequency, with electronic filters for segregation of the signals at the receiver.

NRL's radio-guidance system was used in the first flight of an unmanned remotely controlled target drone, made on 19 Nov. 1937.<sup>34,7,12</sup> The flight was made at Cape May, New Jersey, by a type N2C2 training plane remotely controlled from either the ground or a mother aircraft. The drone's throttle was opened by control from the ground, and the plane took off. When it reached an altitude of 200 feet, the controls were turned over to the mother plane, a type TG-2 aircraft, which controlled the drone successfully for a period of ten minutes. Two type N2C2 Navy trainer aircraft modified to use tricycle landing gear had been provided for the initial test flights and were equipped with radio control. The successful performance of these radio-guided drones, involving 187 flying hours during 1937, with few changes and few failures resulted in the provision of 12 type N2C2 aircraft equipped as drones. The conversion of other types of aircraft to drones followed, including the TG-2, O2U, and F4B types. The type BT airplane was equipped to serve as a mother plane for the drones. A mobile vehicle was designed to provide for guidance control at shore bases and aboard ship.

NRL's radio remote-control system provided the guidance for the first drone to be used as a maneuverable aerial target in this country, which was fired upon by the anti-aircraft guns of the aircraft carrier USS RANGER (CV-4) on 24 Aug. 1938.<sup>13</sup> Although well trained, the gun crew failed to score a single hit on either of the two runs over the ship by the N2C2 drone. Similar results were experienced with the USS UTAH, formerly the battleship BB-31, during nine dive-bombing practice attacks in September 1937; 1500 rounds of ammunition were expended.

The rapid increase in the use of drones quickly revealed the inadequacy of our anti-aircraft defense against maneuvered targets and led to more rapid improvement of our fire-control systems. Recognition of the importance of

the radio-guided drone to the Fleet was given by Admiral Bloch, then Commander-in-Chief, U.S. Fleet, who stated, "the firings against radio-controlled target airplanes have proved of inestimable value in testing the efficiency of the anti-aircraft defense of the Fleet and in determining the procedures which should be used to make anti-aircraft fire most effective" (1939).<sup>14</sup> In a letter to NRL, via the Bureau of Engineering, the Chief of Naval Operations, then ADM W.D. Leahy, also stated "The practicability of using radio-controlled airplanes in connection with Fleet activities has been conclusively demonstrated. Much of the equipment was developed at the Naval Research Laboratory," (1939).<sup>15</sup>

A Drone Service Group was organized as Utility Squadron Three, and firing practice was actively undertaken by the USS PORTLAND in the San Diego area (1939). A Utility Squadron was formed on the East Coast to furnish drone service to the Atlantic Fleet (1941). For their consideration in the use of drones, the Navy gave the Army an N2C2 drone and TG-2 control plane (1939). It was found that the supply of drones from the conversion of older aircraft could not keep up with the wartime demand for realistic aerial targets, so a small commercial airplane, the Culver Cadet, was utilized. These were procured for Navy use at the rate of 20 per month and were designated the TDC-1 and TDC-2 drones (1942). By 1943, the rate was increased to 60 per month. The rate was further increased by 20 drones per month to meet the request of the British to supply requirements for the Royal Navy (1943). To provide drones which would match the performance of the higher speed aircraft then available, the Chief of Naval Operations was requested to assign 36 type F6F-3 and 360 type F6F-5 planes for conversion to drones (1944). The Commander in Chief, U.S. Fleet, requested that 100 war-weary F6F planes be made available as drones in order to carry out simulated "Japanese suicide" attacks against combatant firing ships of the Fleet (1945).

The radio-guided drone, used extensively during World War II for gunnery training and

## RADIO REMOTE CONTROL—MISSILE GUIDANCE

evaluation of effectiveness of defense against enemy aircraft attack, also played a significant part in the development of the proximity fuze during the latter part of 1942 and early 1943 by providing a realistic flying target to prove the effectiveness of this fuze. It also found special uses after the war. One of these was its use to collect data from the air on nuclear explosions during the Bikini tests in the Pacific, telemetering this to safe observation points aboard ship (1946). The drone's utilization and development has continued, with considerable current interest in its operational capabilities with respect to both converted older aircraft and new designs for special purposes.

### ASSAULT DRONES

The attacks on the USS RANGER and the USS UTAH by N2C-2 drones, remotely controlled by NRL's radio command guidance system previously described, provided the world's first successful demonstration of the potentiality of guided missiles in the air-to-air and surface-to-surface categories (1938).<sup>7b,16</sup> The demonstration, accomplished through radio control from both aircraft and surface ship under direct visual observation, brought about the realization that, with further development, a new and powerful weapon of war could be made available. This preceded by over two years the first successful radio-guided missile effort in Germany, its "glide bomb" (December 1940). Following the demonstration, effort was directed to improve the assault function of the drone. NRL was designated by the Bureau of Aeronautics to provide an interference-free radio guidance system to avoid enemy countermeasures (1940).<sup>17</sup> Television was introduced to permit control beyond direct visual range and thus provide greater safety from injury at the control point during detonation and through enemy gunfire.

Using television for remote target observation and NRL's radio-command guidance system, the feasibility of remotely controlled launching of torpedoes from assault aircraft

was first successfully demonstrated (August 1941).<sup>7c</sup> The television and radio guidance equipment was installed in a type TG-2 torpedo plane used as a drone. Approximately 50 simulated torpedo attack runs were made with the assault drone under radio control, using the television equipment to sight and effect collision track on the target. All runs except three were satisfactory. Control was established at ranges out to six miles. Later, a torpedo was launched against a destroyer by a type TG-2 equipped as an assault drone under radio control. The torpedo, remotely controlled at a range of six miles, passed directly under the full length of the target (April 1942).<sup>7d</sup>

The first complete simulation of a guided missile was demonstrated using an unmanned type BG-1 aircraft equipped as an assault drone with NRL's radio-command guidance system and remote observation by television. The drone, which was under control by a plane 11 miles distant, crashed through a towed battle raft off Leveley, Virginia (12 April 1942).<sup>7e</sup> A Navy board of representatives from the interested Navy bureaus and the Office of the Chief of Naval Operations which witnessed the demonstration reported that the capabilities of the assault drone as a weapon had been proven. It was considered that this demonstration marked a profound step forward in the art of warfare and that guided missiles of great potency would subsequently evolve. The demonstration was followed by the consideration of plans for extensive further development directed to a large guided-missile procurement program.

To provide operations under all conditions of visibility, not possible with television, NRL was requested by the Bureau of Aeronautics to develop an assault drone guidance system using radar to replace television (1941).<sup>7,18</sup> Accordingly, NRL was first to develop and demonstrate a radio missile command-guidance system in which target information from a radar on an assault drone was relayed via radio link to a remote-control plane. By using this information the operator directed

RADIO REMOTE CONTROL - MISSILE GUIDANCE

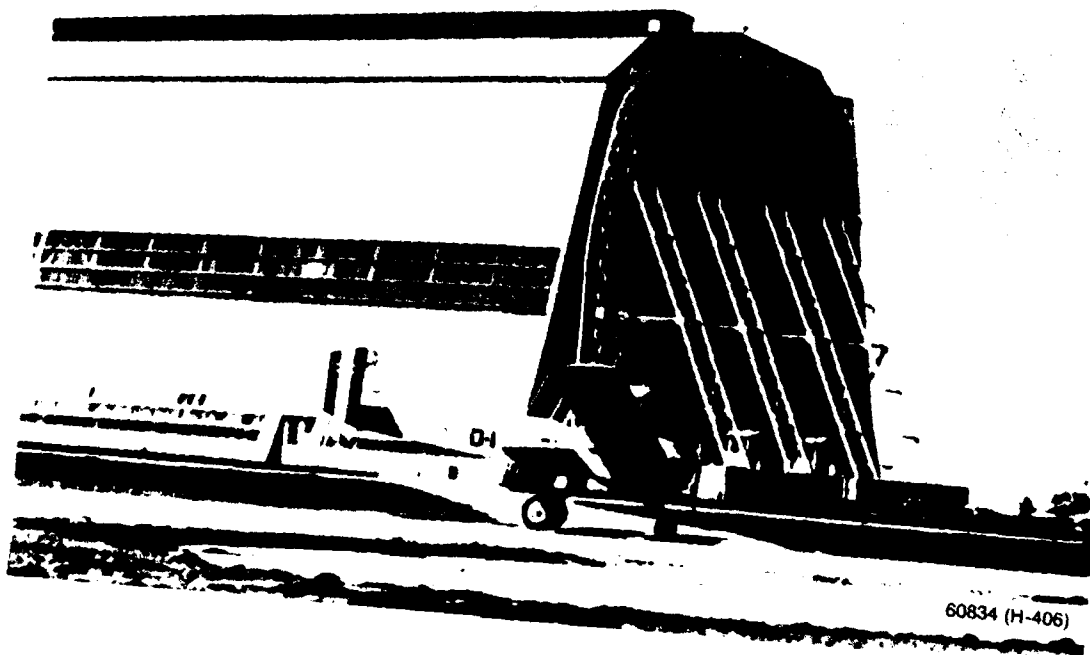

FLIGHT OF AN UNMANNED REMOTELY  
CONTROLLED TARGET DRONE

The first flight of an unmanned target drone was made 19 Nov. 1937 at Cape May, New Jersey. NRL's radio remote-control system was used in guiding the drone both from the ground and from another plane. An unmanned type N2C-2 aircraft, relabeled D-1 (Drone-1), is shown in the upper photo running for take-off, 3 May 1938. The lower photo shows the mother aircraft remotely controlling the drone, after both are airborne.



RADIO REMOTE CONTROL - MISSILE GUIDANCE



60834 (H-408)

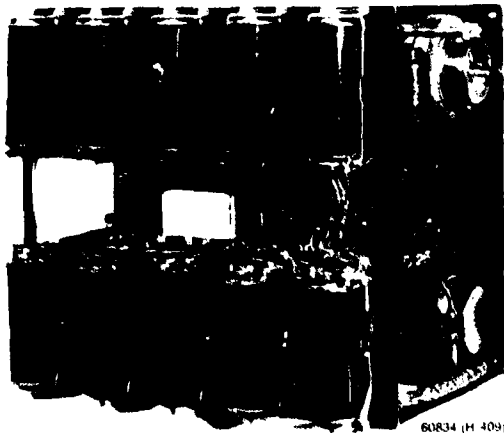

60834 (H-408)

AIRCRAFT MODIFIED FOR USE AS DRONE

The upper photo shows a close up of an N2C-2 modified for use in radio-controlled flight experiments. The remote-control equipment used in controlling the aircraft is shown in the lower photo (1937).

the drone by radio control to collision with the target (June 1943).<sup>19</sup> In developing this system NRL's Model ASB airborne radar, suitably modified, was installed in the drone. The system was demonstrated in flights against ships moving in the Chesapeake Bay and against a lighthouse located in the bay, offshore from NRL's Chesapeake Bay site. A total of 16 hits were made in ten runs against ships and eleven against the lighthouse. This system was designated the Model AN/APS-18 airborne radar-link transmitter and the AN/ARR-9 link receiver-display. Thirty of each of these equipments were produced.

#### COMBAT USE OF GUIDED MISSILES DURING WORLD WAR II

In proceeding with advanced development and large-scale procurement for operational use, it was considered that the first employment of radio-guided missiles should be widespread and in sufficient quantity to catch the enemy unprepared, so as to provide opportunity for repeated attacks before the enemy could develop countermeasures. During 1943 plans were under consideration at high official Navy level for production of assault drones in numbers as high as 5000, produced at the rate of 250 per month. Official approval was given to proceed with 2000 drones. The assembly and training of operational groups was also initiated. Later, the advisability of proceeding with this large number of assault drones was challenged, on the basis of its disruption of the production of conventional aircraft and the need for obtaining further proof of operational capability. Commanders in the Pacific expressed reluctance to use what they considered an inadequately proven weapon which might interfere with operations which had been found successful. It was felt that the character of the war had changed, becoming one of rapid forward motion in which conventional weapons were serving adequately. During 1944 official Navy policy was altered, and large-scale drone production plans were cut back to es-

entially an experimental effort.<sup>20</sup> Nevertheless, assault drones saw some action during the war. The first combat use of an assault drone as a guided missile was made against a target in Helgoland, in the European theater, with a Navy type PB4Y-1 patrol plane as the drone, loaded with 25,000 pounds of torpex. The missile was successfully guided and exploded on target by remote-control equipment procured as patterned on NRL's radio command-guidance system, with television for remote target observation (September 3, 1944).<sup>21</sup> The drone and the type PV-1 control plane were flown from England, maintaining a spacing of eight to ten miles. At a predetermined position near the target, the pilot of the drone switched to remote control and bailed out of the drone for a safe landing. The final run to the target was then made under remote control. LT Joseph P. Kennedy, brother of President Kennedy, lost his life in a prior attempt to carry out this operation when the drone exploded prematurely in mid-air from an unknown cause (12 Aug. 1944).

In the South Pacific area, numerous strikes with assault drones were made against bypassed Japanese strong points in the Bougainville and Rabaul areas of the North Solomon Islands. Forty-six drones, converted type TDR aircraft, and guided by control planes, were used in attacks made from bases on Stirling and Green Islands during late September and October 1944. In these attacks the drones were stripped for completely unmanned, or "nolo," flights. Thirty-seven drones reached the target area and launched attacks. Some of these were brought down by antiaircraft fire, and the television of others failed. Twenty-nine drones were successful in executing their attacks.<sup>22</sup>

#### RADIO-GUIDED BOMBS

The application of radio to control the direction of flight of bombs launched from aircraft to improve on target accuracy had been given consideration early in World War II, but no such guided bomb had been used by combat forces

## RADIO REMOTE CONTROL—MISSILE GUIDANCE

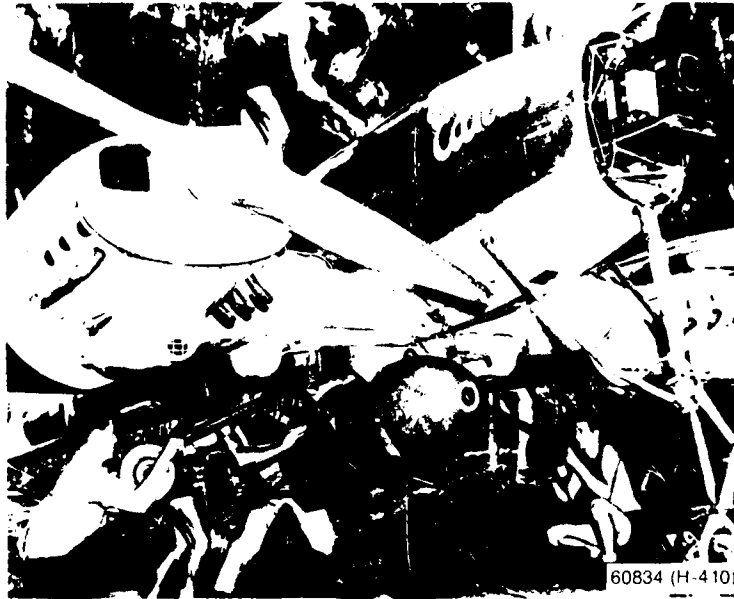

**TYPE TDR ASSAULT DRONE BEING LOADED WITH BOMBS**

A considerable number of these unmanned assault drones were launched against Japanese targets in the fall of 1944.

until 1943. The appearance of the German HS-293, air-surface, glide bomb in late August 1943 aroused operational interest in the Allied Forces to use such weapon. As a result, the Azon high-angle bomb, controllable in azimuth only, was developed.<sup>77</sup> The tail of this bomb contained the control mechanism, replacing the tail of the standard 1000-pound bomb. Razon, a bomb controllable in two axes for greater accuracy, was developed later.<sup>78</sup> The radio receiving equipment of these bombs was a critical element, since it had to be housed in the small tail assembly, yet be sufficiently selective to avoid jamming by the enemy. NRL was responsible for the complete development of the radio remote-control units for the Azon, Razon, Gorgon, and Gargoyle guided bombs (1943-1944).<sup>20</sup> The Azon radio-guided bomb was first used in Italy (April 1944). Spectacular results with it were obtained in May 1944, when its use effectively blocked all rail traffic through the Brenner Pass between Italy and

Austria. Other successful results followed, with the availability of over 13,000 Azons. The equipment included the AN/ARW-17 FM receiver (30 to 42 MHz) for evaluation programs in the United States and the AN/ARW-37 FM receiver (50 to 65 MHz) for use in combat. These receivers went into large-scale production. Although the superior on-target accuracy of the Razon guided bomb had been proven, the termination of hostilities brought about an abrupt halt to its further utilization. The Gorgon and Gargoyle guided missiles were Navy programs which will be treated subsequently.

### POSTWAR RADIO GUIDED MISSILES

NRL's extensive experience in the radio-control field resulted in its acquiring a general consulting role and its involvement in many radio-guided-missile development projects. During the war, to advance the assault-drone concept, the Bureau of Aeronautics sponsored a series of guided-missile projects, including the



RADIO REMOTE CONTROL—MISSILE GUIDANCE

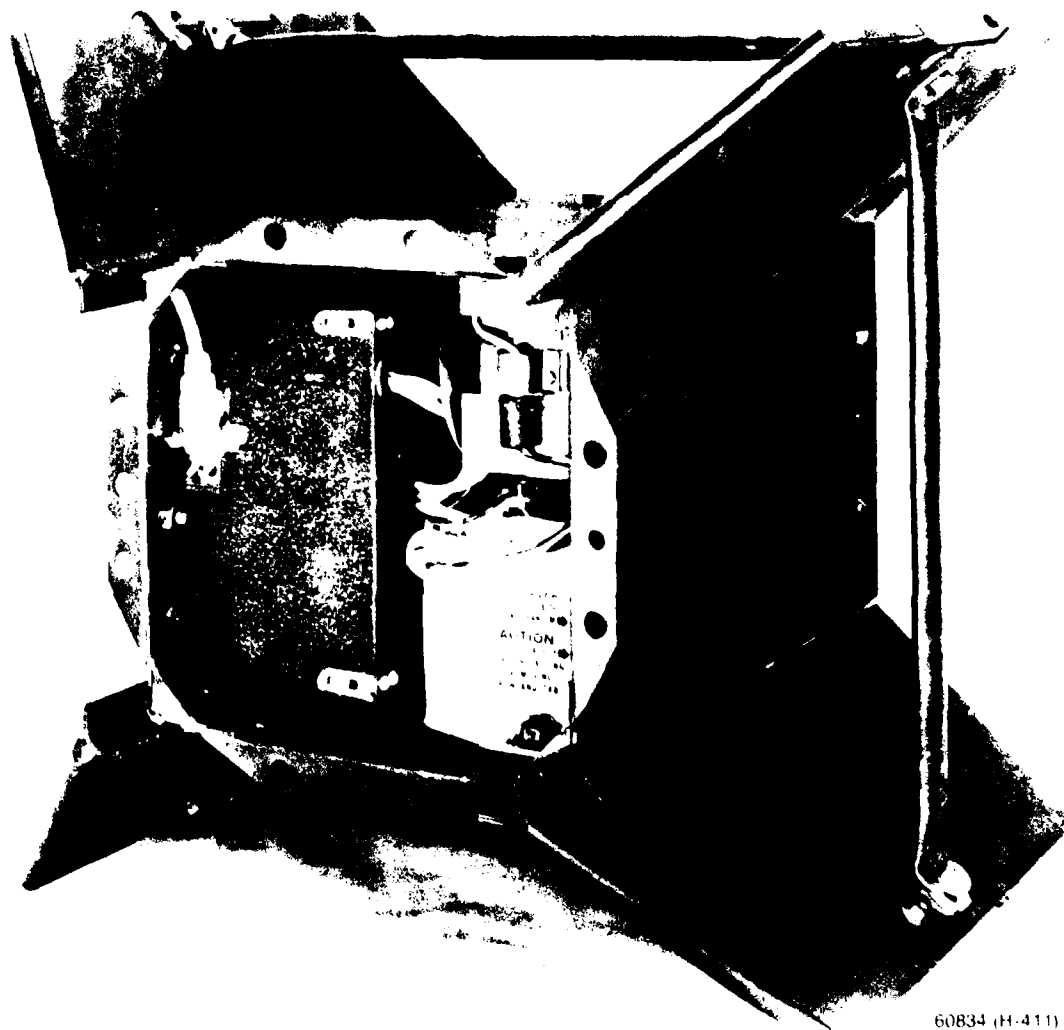

60834 (H-411)

**CONTROL SYSTEM FOR THE FIRST U.S. RADIO-GUIDED BOMB — THE AZON (1944)**

NRL developed the radio remote-control system for this bomb. This photograph shows the bomb terminal unit, which could be quickly attached to conventional bombs as a replacement for their tail assemblies.

## RADIO REMOTE CONTROL—MISSILE GUIDANCE

Glomb, Gorgon, Little Joe, Gargoyle, Loon, and Lark.<sup>71</sup> The Bureau of Ordnance sponsored the Pelican, Bat and Kingfisher missiles.<sup>7m</sup> Most of these projects were carried into the postwar period. The Glomb (glider bomb) was a towed glider, radio controlled through television observation after launching from the control plane (1941). This missile was an attempt to obtain increased explosive-carrying capacity at low cost. The Pelican was a glide-bomb carrying a passive homing device to home on ship targets illuminated by the radar of the launching aircraft (1942). Nearly a thousand units suitable for service use were produced by late 1944.

### BAT MISSILE

The Bat, developed for use against enemy shipping and land targets, was also an air-launched

glide bomb (1944).<sup>21</sup> It utilized guidance principles applied to S band by the Radiation Laboratory and incorporated the radar in the missile. The advantage of the great increase in echo strength as the missile approached the target and the ability of the launching plane to leave the target area as soon as the missile was launched led to the choice of the Bat over the Pelican. The Bat was the first missile which could pick up its target with its own radar system and home automatically on the target. It was the first automatic radar homing missile to achieve actual combat use. Three thousand Bats were produced. With the use of the Bat, patrol squadrons in the Pacific war theater early in 1945 were able to destroy some enemy ships under very adverse conditions. The Bat was retired from service at the end of 1948.

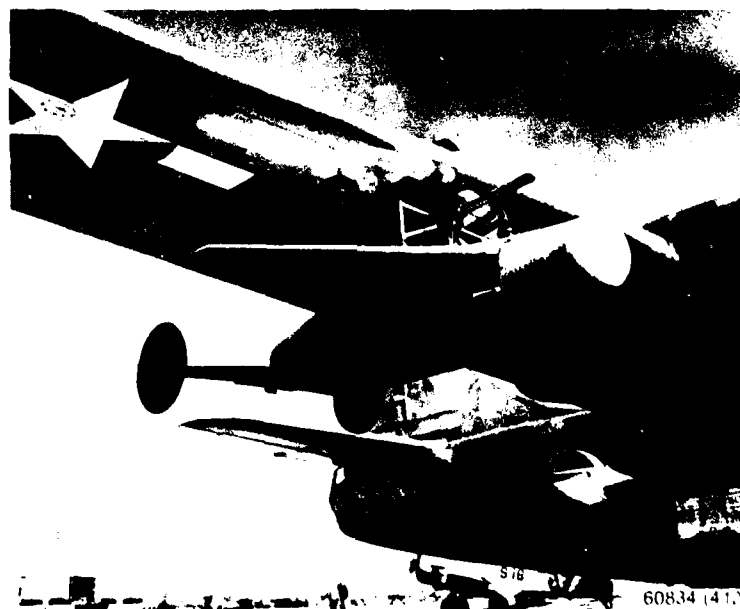

**BAT MISSILE, AIR-LAUNCHED GLIDE BOMB,  
ON A SEAPLANE (1944)**

This bomb was used against enemy shipping and land targets. It used guidance principles applied to S band. The Bat was the first automatic homing missile to achieve actual combat use, three thousand were produced.

### GORGON MISSILE

The concept of an "aerial torpedo" led to the Gorgon, which evolved into a jet-powered, winged missile controlled remotely by radio, with terminal target-seeking equipment. It was intended to be capable of being launched from aircraft against enemy aircraft and light surface craft. The project was concerned with the development of various components of such missile systems, particularly several types of propulsion. Under the project, the first liquid-rocket winged-missile flight in this country was accomplished (March 1945). The first successful free flight of a vehicle powered with a subsonic ram jet (continuous duct) was also accomplished (November 1947). While the project did not produce a missile for combat use, it led to other specific missile projects and provided a basis for the post war guided-missile development program that followed.

### GARGOYLE MISSILE

In 1943, the success of the German HS-293 glide bomb and the X-1 high-angle bomb, directed visually through radio control against allied ships, caused the initiation of a Navy crash program to provide a similar air-to-surface weapon, designated Gargoyle (October 1943). This was a rocket-propelled, 1600-pound, armor-piercing bomb with a low wing configuration, radio controlled through visual direction with the aid of a flare in the tail. NRL provided the radio control receiving equipment for the Gargoyle missile. A quantity of these missiles were produced, and satisfactory tests of their performance were made. However, the termination of hostilities in 1945 brought about the end of the development of this missile.

### LARK AND SKYLARK GUIDED MISSILES

At the time of inception of the Japanese Kamikazi aircraft attacks, the Bureaus of Aeronautics and Ordnance, with NRL's cooperation,

were developing plans for a radio-guided missile to counter enemy bomber aircraft which could have the speed and altitude performance then thought possible. Such a weapon was urgently needed, but when it was realized that considerable time would be required to develop the missile an interim approach having less capability was given priority. This became the Little Joe, surface-to-air missile. It had a tail-first configuration, with cruciform wing and tail surfaces. It used a standard solid-powder rocket power plant. Its guidance was through visual observation, with remote radio control. Tests proved the radio-control system satisfactory, but the war ended before development of the weapon could be completed.

Concurrently with development of Little Joe, work continued on an advanced missile. Intended as a ship-to-air, rocket-propelled, guided missile, it was designated the Lark (October 1944). After the war, the objective established for the Lark's capability was to counter an enemy bomber aircraft capable of attaining a speed of 0.85 mach

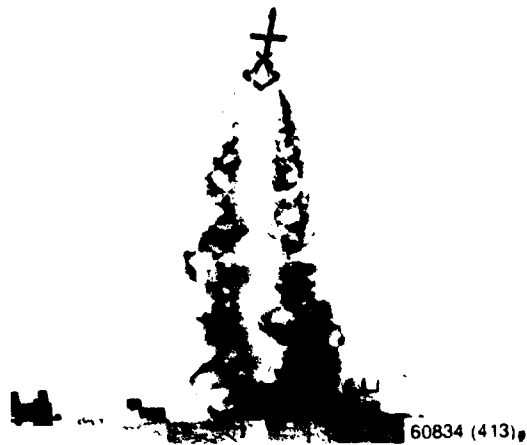

LARK GUIDED MISSILE

The Lark missile was the first surface-to-air guided missile and was the forerunner of missiles using beam-rider guidance now in active service (1948). NRL developed the guidance system. Shown is the launching of the missile from Point Mugu, California.

## RADIO REMOTE CONTROL—MISSILE GUIDANCE

and 40,000-foot altitude, and to be effective at ranges out to 90,000 yards. NRL was sponsored by the Navy to proceed with the development of an adequate radio guidance system for this missile, with Convair as contractor for general development and production of the missile. NRL proposed to use a system in which the missile would seek to position itself in the center of a radar beam, using intelligence provided it by the beam—termed the “beam-rider” system (1945).<sup>22</sup> The missile could be guided to the target by directing the radar beam. The conically scanned beam of the radar, with pulse-repetition rate varying as the beam rotated, provided the orientation reference for the missile. With this system several missiles could be guided independently to the target at the same time. In accomplishing the development of the Lark missile guidance system, NRL was first to demonstrate the feasibility of completely automatic “beam-

rider” guidance of a guided missile (July 1947).<sup>7n,23,24</sup> The Lark became the first guided missile to employ a beam-rider guidance system. The Lark was the first surface-to-air guided missile (1948), and the forerunner of missiles using beam-rider guidance in active service, such as the Navy’s Talos surface-to-air missile. The Terrier-I surface-to-air and Sparrow-I air-to-air missiles also used beam-rider guidance. The Sparrow-I missile was the first air-to-air guided missile to intercept and destroy a moving air target, an F6F drone aircraft (Dec. 3, 1952).<sup>7o</sup> The Sparrow-II and Sparrow-III missiles are refinements of the Sparrow-I, utilizing many of its components.<sup>25</sup>

In the demonstration, a type SNB aircraft, equipped with an NRL-developed missile receiver coupled to the aircraft autopilot, was automatically guided as it flew out a radar

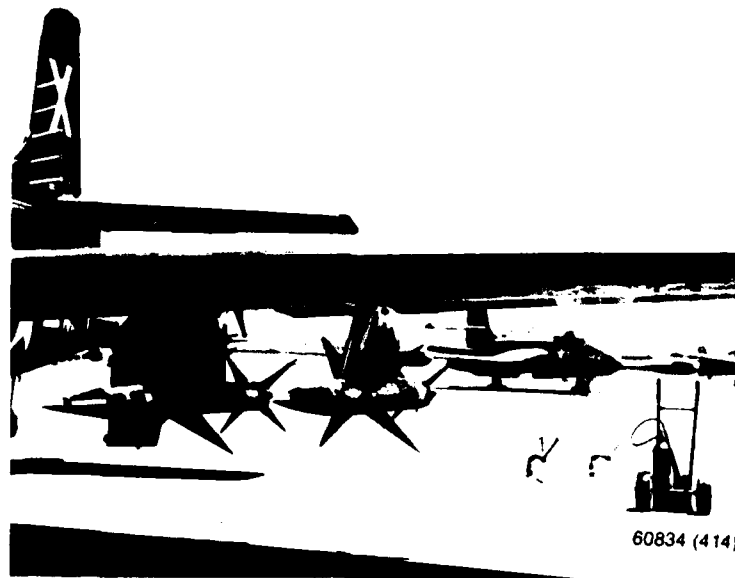

**SPARROW I AIR-TO-AIR GUIDED MISSILE ON WING  
OF TYPE F3D AIRCRAFT**

This missile used NRL's beam-rider guidance system. The Sparrow I missile was the first air-to-air guided missile to intercept and destroy a moving air target (1952).

## RADIO REMOTE CONTROL—MISSILE GUIDANCE

beam to a distance of 90,000 yards at an elevation angle of less than three degrees. NRL modified a Model SP search radar to provide a conically scanned beam, the space-position of which was related to the pulse-repetition rate. The radar was located at the Laboratory's Chesapeake Bay site. The capability of the system to guide the aircraft was successfully shown by displacing the beam in both elevation and train, to simulate tracking of a moving target. The aircraft automatically maintained the course established by the moving beam with accuracy equal to that of good free-space tracking with spot-scope-operated fire-control radar. In developing the guidance system for the Lark missile, NRL, in addition to the special radar features, devised a missile receiving system which translated the orientation data in the radar beam to signals which provided proportional control of the control surfaces of the missile airframe (Model AN/APW-4).<sup>7n,23,24</sup> It also developed a beacon transmitter to be carried in the missile to enhance its echo response in reception by the radar (AN/DPN-3).<sup>26</sup> In early flights of the Lark, with an evaluation system set up at the Naval Ordnance Test Station, Inyokern, California, the performance of the beam-rider guidance system proved successful. A large number of Lark missiles were utilized in investigating the performance of the several system aspects represented in the missile.

Although the Lark project bore the name of a specific missile, much of the technology developed by NRL found its way into other guided-missile systems that followed.<sup>27</sup> The Lark radar, with additional NRL improvements, became the prototype for the Models AN/SPQ-2 (shipborne) and AN/MPQ-5 (mobile) missile-guiding radars procured commercially (1950). These were the first "operational" radars to have a capability for missile guidance. The AN/SPQ-2 was installed on the USS NORTON SOUND for its early guided-missile activities. Both the AN/SPQ-2 and AN/MPQ-5 were installed at Cape Canaveral, when its missile test range facility was first

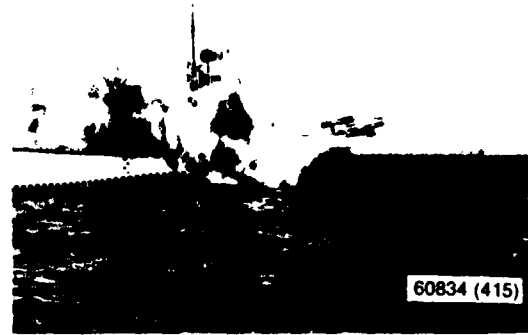

LARK MISSILE BEING LAUNCHED FROM THE SUBMARINE USS CARBONERO (1948)

Although the Lark program bore the name of a specific missile, much of the technology developed by NRL under this program found its way into other guided-missile systems that followed.

established. The AN/MPQ-5 was used at various missile test sites, including those of the Army. The telemetry and data-recording instrumentation developed by NRL for determining the flight performance of the Lark missile provided both a tenfold increase in data accuracy and a tenfold reduction in data processing time over previously available equipment. The novel techniques incorporated into this instrumentation have been used extensively in subsequent missile-flight-assessment equipment, such as that installed at the National Test Ranges.

In 1948, NRL developed the radio-guidance system for the Skylark missile, the first guided missile automatically to accomplish an interception of a moving air target—an F6F drone equipped with a beacon (13 Jan. 1950).<sup>7n,23</sup> The Skylark was also the first surface-to-air missile to be employed operationally by a vessel of the U.S. Navy, the USS NORTON SOUND (1950). Many successful launchings were accomplished from this vessel during 1950. The guidance system developed by NRL for the Skylark missile was the first in which position data on the target and missile, acquired by automatic tracking by the radar,

## RADIO REMOTE CONTROL—MISSILE GUIDANCE



THE SKYLARK BEING LAUNCHED BY THE USS NORTON SOUND (1950)

The Skylark was the first missile automatically to accomplish an interception of an airborne target, an F6F drone (1950). The Skylark's guidance, developed by NRL, was first automatically to track, compute, generate, and transmit commands to direct the missile on a course to the target. Its guidance system was of the command type instead of the beam-rider type used by the Lark. The USS NORTON SOUND, the first of a series of guided-missile ships, launched many missiles of both types in operational trials. The Skylark was the first missile to be launched by this ship.

was processed by a computer to generate and transmit to the missile, automatically, commands to direct itself on a course to the target (1948).<sup>7p.25,28</sup> To provide adequate accuracy in final target approach for the Skylark, NRL also developed a semiactive missile target seeker in which the energy of the guidance radar reflected by the illuminated target was utilized by the missile to direct itself to collision with the target (AN/DPN-7) (1948).<sup>29</sup> By September 1948, the first demonstration, in actual flight, of the Skylark missile-guidance system had been given, including both the command-guidance and missile target-seeker features. A large number of Skylark missiles were procured and launched in assessing the performance and utility of the system. The U.S. Army obtained a considerable number of the Skylark missiles for use in training guided-missile operating crews.

To generate signals for automatically controlling the steering mechanism of the Skylark missile target seeker, a conical scanning device located in the nose of the missile was employed to scan the transmitted energy reflected by the target. The Skylark surface-to-air missile had general airframe and weapon characteristics similar to the Lark, except that its guidance system was of the command type.

### KINGFISHER GUIDED MISSILE

The Kingfisher missile program was directed to provide a winged torpedo for attacking enemy submarines. This missile, airborne after launch, entered the sea near the target and made the final approach through the use of an acoustic homing device. Several versions of the missile were considered. NRL developed the command-guidance system for the Kingfisher E ship-launched airborne submarine attack missile

## RADIO REMOTE CONTROL—MISSILE GUIDANCE

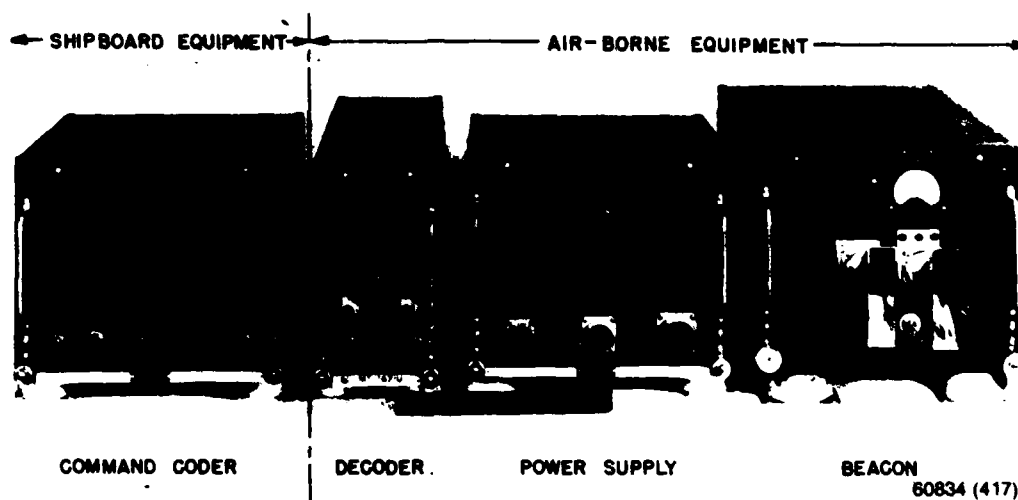

RADIO COMMAND-GUIDANCE SYSTEM FOR THE KINGFISHER  
"E" RADIO GUIDED MISSILE

This system was developed by NRL (1947). The missile was launched by a ship and proceeded airborne under radio command-guidance, entering the sea near the enemy submarine target.

and guided the contractor in its production (1947).<sup>30</sup> Demonstrations of the system in many flights, using type SNB aircraft to simulate the airframe, proved the system successful. This system, similar to NRL's Skylark missile-guidance system, employed a command pulse-coding device with the Mark 25 fire-control radar installed aboard ship and a missile-borne receiver, decoder, and beacon equipment (AN/DPW-2). Five discrete radar pulse-repetition rates were used for the control channels, to actuate the missile-control functions. A computer using position data obtained from the radar supplied the command link with necessary corrections to keep the missile on course. NRL developed the command-guidance system for another version of the airborne torpedo type missile, the Kingfisher G. In this version, the missile was launched from its shipping crate as positioned on the ship's deck (1950).<sup>31</sup> The G version also used the Mark 25 radar for target-position data and a computer to provide guidance commands to the missile.

### BULLPUP GUIDED MISSILE

Bullpup, a short-range, supersonic, guided missile, was designed for use by aircraft in close support of ground troops for interdiction and for use against small tactical targets ashore and afloat. It was an answer to a requirement evidenced during the Korean War. The missile was designed to be launched during a dive and guided to the target by visual observation and commands transmitted via radio link to the missile. It was carried below the fuselage and wings of types FJ-4B and A4D-2N aircraft. The command link, of the noise-correlation type, was rendered inoperative in the presence of radio interference caused by many sources. Concern regarding the effectiveness of similar enemy jamming led to an investigation conducted by NRL involving many flights at its Chesapeake Bay site (1958).<sup>32</sup> The results obtained brought about correction of the difficulty and acceptable performance of the missile. The Bullpup missile was procured in large quantities and saw service

## RADIO REMOTE CONTROL—MISSILE GUIDANCE

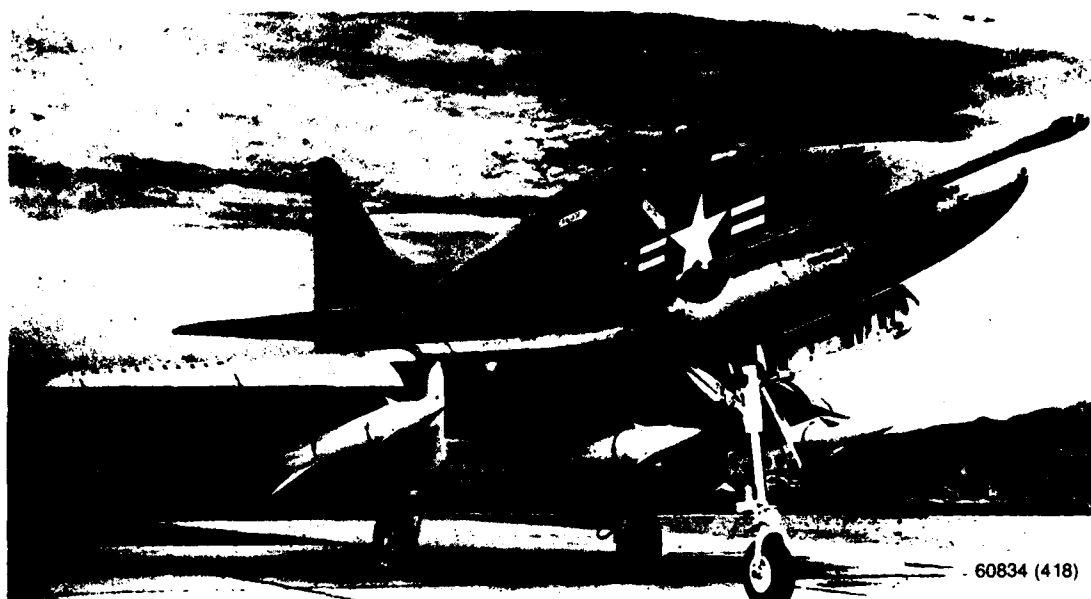

### THREE BULLPUP MISSILES MOUNTED ON AN A4D-2N SKYHAWK AIRCRAFT

Through its solution of a problem which rendered this missile inoperative in the presence of radio interference caused by many sources, NRL made this missile operationally effective. (1958)

for a considerable period, including use in Vietnam.

### LOON SHIP-TO-SURFACE GUIDED MISSILE

The havoc created in England in 1944 with the advent of the German robot "buzz-bomb" (V-1) was responsible for the development of a similar weapon, the JB-2, sponsored by the U.S. Army. The Navy was interested in launching large numbers of these missiles against Japan from aircraft carriers a hundred miles offshore and directing them by radio control to large industrial targets. This missile had no means of adjustment of its flight pattern after launch. NRL was requested to investigate the weapon and determine its suitability for the application of radio control. NRL reported favorably on its characteristics and provided the weapon with a radio-control system, so it could be guided by a shipboard or airborne radar.<sup>32</sup> This became

the Loon project, directed to provide a ship surface-to-surface missile (April 1945). Models of the Loon did not become available until after the war. However, the Loon, with the guidance system developed by NRL, provided the first successful demonstration of a surface-to-surface guided missile and the first guided missile to be launched from a submarine (USS CUSK), precursor of the Navy's Polaris submarine missile system (7 Mar. 1947).<sup>79,34</sup> NRL's contributions to the Loon included means of tracking the missile by radar, steering it to the target by radio remote control, and diving it by remote control into the target area.<sup>20</sup> Specific equipments were developed for the project, such as, the AN/ARW-17 and AN/ARW-37 FM radio-control receivers, the AN/APW-33 and AN/APN-41 radar beacons, remote controls for the automatic flight systems, and telemetering links. The radio telemetry system developed by NRL for the Loon was the



## RADIO REMOTE CONTROL—MISSILE GUIDANCE

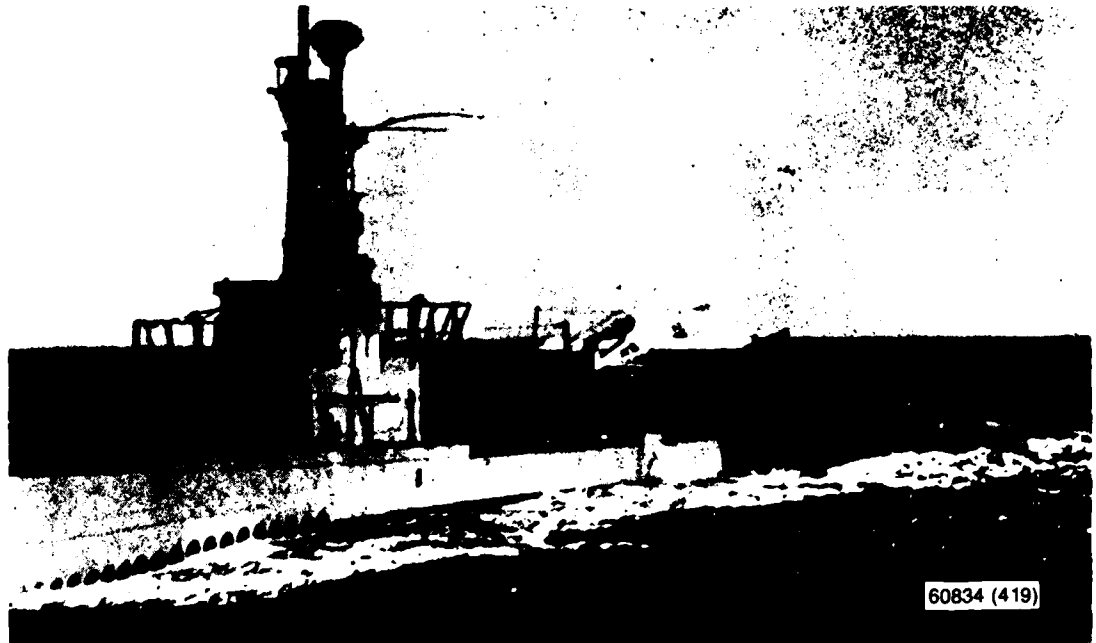

### LOON SHIP-TO-SURFACE GUIDED MISSILE, PRECURSOR OF THE NAVY'S POLARIS SUBMARINE MISSILE SYSTEM

The Loon, with its guidance system developed by NRL, provided the first successful demonstration of a surface-to-surface guided missile and the first guided missile to be launched from a submarine, the USS CUSK (7 March 1947).

first to be used in a guided missile. It transmitted back to the launch site internal conditions of the missile, such as position of its control surfaces, stabilizer status, and gyrocompass indications. During the demonstration, the Loon successfully gained its flying altitude and answered both right and left turn signals given by the ship, which was located off Point Mugu, California. In response to a signal, the Loon at 60 miles went into a dive. In another run, the ship was able to control the Loon out to 75 miles. It finally crashed at a range of 95 miles. The USS NORTON SOUND (AV-11), a seaplane tender, converted especially to provide for guided missile operations, was the first vessel, other than a submarine, to launch a guided missile when it launched a Loon on 26 Jan. 1949. Thus, the USS NORTON SOUND became the forerunner of the Navy's

succession of operational guided-missile surface ships beginning with the USS BOSTON (CAG-1, now CA-69) (1950).

### REGULUS ASSAULT GUIDED MISSILE

With the success of the Loon missile and the availability of the atomic bomb, the Navy proceeded with the development of a long-range assault missile intended to carry a nuclear warhead and be directed against important enemy shore targets. Designated the Regulus (1947), it was to be launched from ships, including submarines, and to have a range of 500 miles and a speed of 0.85 mach while carrying a 3000-pound payload.<sup>7r.35</sup> It was turbojet powered, with aerodynamic supporting surfaces. Guidance of the missile was accomplished by the accompanying aircraft, which would position the missile over the target and detonate its warhead by

## RADIO REMOTE CONTROL-MISSILE GUIDANCE

command. The Navy was concerned about the electronic countermeasures an enemy might direct against this missile. To replace an unsecure system and avoid such countermeasures, NRL developed, for the Regulus missile, the first command-guidance system which provided security in the transmission of guidance commands to the missile to prevent detection and the application of jamming and deception by an enemy (AN/APW-19) (1950).<sup>36</sup> The security feature of the system was based on unique flash pulse-signal arrangements. About a thousand Regulus missiles were procured, the first becoming available in 1952. The first extensive field trials of electronic countermeasures which might be applied by an enemy were carried out with these missiles. The missiles were also used as targets to determine the capability of other types of guided missiles

The vulnerability of the Regulus missile and its guiding aircraft to enemy attack led to consideration of a ballistic-type missile, which when developed, became the Polaris type missile. The Regulus missile program was terminated when the Polaris missile became operational.

NRL's secure guidance system was used extensively by the Army in its combat reconnaissance drones (AN/USD-1A). The Air Force used it in its type Q2C reconnaissance drone, which had parachute recovery. The Navy also used this drone for many years.

### POLARIS MISSILE

The advent of the atomic bomb, the impact of which brought the war to a sudden close, was

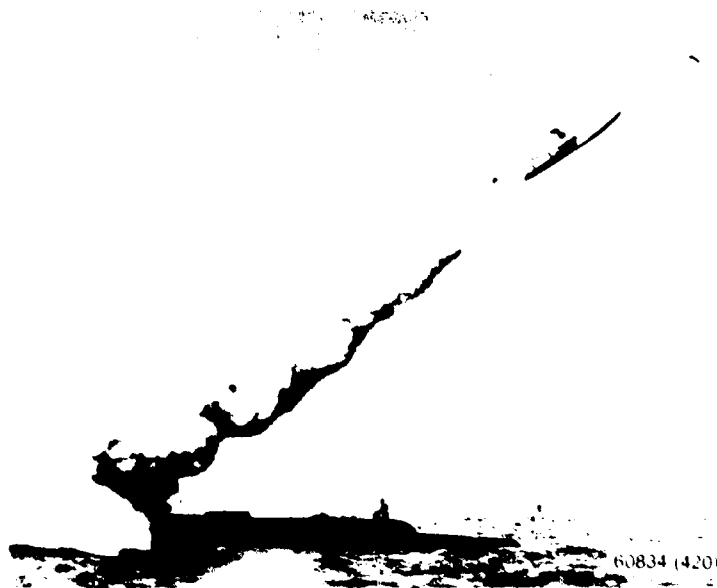

**REGULUS MISSILE BEING LAUNCHED FROM A SUBMARINE**

NRL developed for the Regulus missile the first command-guidance system which provided security in the transmission of guidance commands to the missile (1950). This system, the AN/APW-19, was designed to prevent detection and the application of jamming and deception by an enemy. The system was used by all three military services.

followed by technological advances which reduced the size of the nuclear warhead so that it became feasible to adapt it to an intermediate-range ballistic missile (IRBM). This, together with advances in inertial guidance, provided the basis for the Department of Defense to direct the Army and Navy to proceed jointly with the development of an IRBM, which was named the Jupiter (1955). The Navy, realizing the important strategic advantages of a mobile sea-based nuclear deterrent, with its unique defensive features when submerged, immediately established a Special Projects Office to conduct the development of a "ship-launched weapon system." In a meeting with Army and Navy representatives held at NRL, agreement was reached on the "Terms of Reference for the Army-Navy Development of IRBM Land-based and Sea-based Weapon System," with the Army having principal responsibility for the development of the missile and the Navy responsibility for the development of the submarine platform (2 Dec. 1955).<sup>37</sup> This agreement was approved by the Department of Defense. The Navy was faced with a serious disadvantage in proceeding with a sea-based version of this missile system, since only liquid rocket propellants were then available, and their lethality and space requirements involved the solution of very difficult problems in their use aboard ship, particularly in submarines. The Special Projects Office aggressively prosecuted the problem of obtaining a solid propellant, and its success in accomplishing this made feasible the development of the submarine-launched "Fleet Ballistic Missile" (FBM), which was named the Polaris. Many other difficult technical problems were foreseen in attaining this objective, and the Navy's Special Projects Office, as soon as it was established, requested the assistance of the Laboratory in their solution. NRL responded by entering extensively into the Navy's conceptual planning for the development of the missile and its submarine environment. Technical support was provided by various areas of the Laboratory as the problems encountered were identified.<sup>38</sup> Only those contributions

associated with electronics are reviewed here. Many studies were conducted to determine the effectiveness of ideas proposed to advance the performance of the missile system. Considerable effort was directed toward providing facilities for the communication of commands to submerged submarines to control missile firing. The results of this work are reviewed in Chapter 3, Radio Communication.

An Army-Navy conference on the guidance system for the Jupiter missile resulted in an agreement for a collaborative effort in its development, with the Navy's responsibility assigned to NRL (February 1956).<sup>37</sup> The guidance system decided upon at that time was of the radio-inertial type, in which commands via radio to the missile corrected the trajectory established by the inertial device in the missile when necessary, as determined by radar observations. Subsequently, improvements in the accuracy of accelerometers and gyros made it possible to dispense with the radio updating of the trajectory and permitted the use of a preprogrammed inertial system for the Polaris missile. This system required guidance orders to be inserted in a "memory guidance capsule," located in the missile. The guidance orders were carried out during the period between the firing of the solid-state propellant and its cutoff, leaving the missile to follow the established ballistic path in its flight to the target. The guidance orders, continuously updated, were generated by a digital computer from several input data sources and transmitted to the memory guidance capsule. Serious difficulties encountered by the contractor in the development of this guidance data system were resolved through NRL's assistance.

The inertial-guidance system had to be provided with the geographic position of the submarine, and this position had to be periodically updated when the missile was in standby condition, since the inertial device could project the position accurately for only a limited time. The geographic position data was provided the computer through other navigational means. Also,

RADIO REMOTE CONTROL - MISSILE GUIDANCE

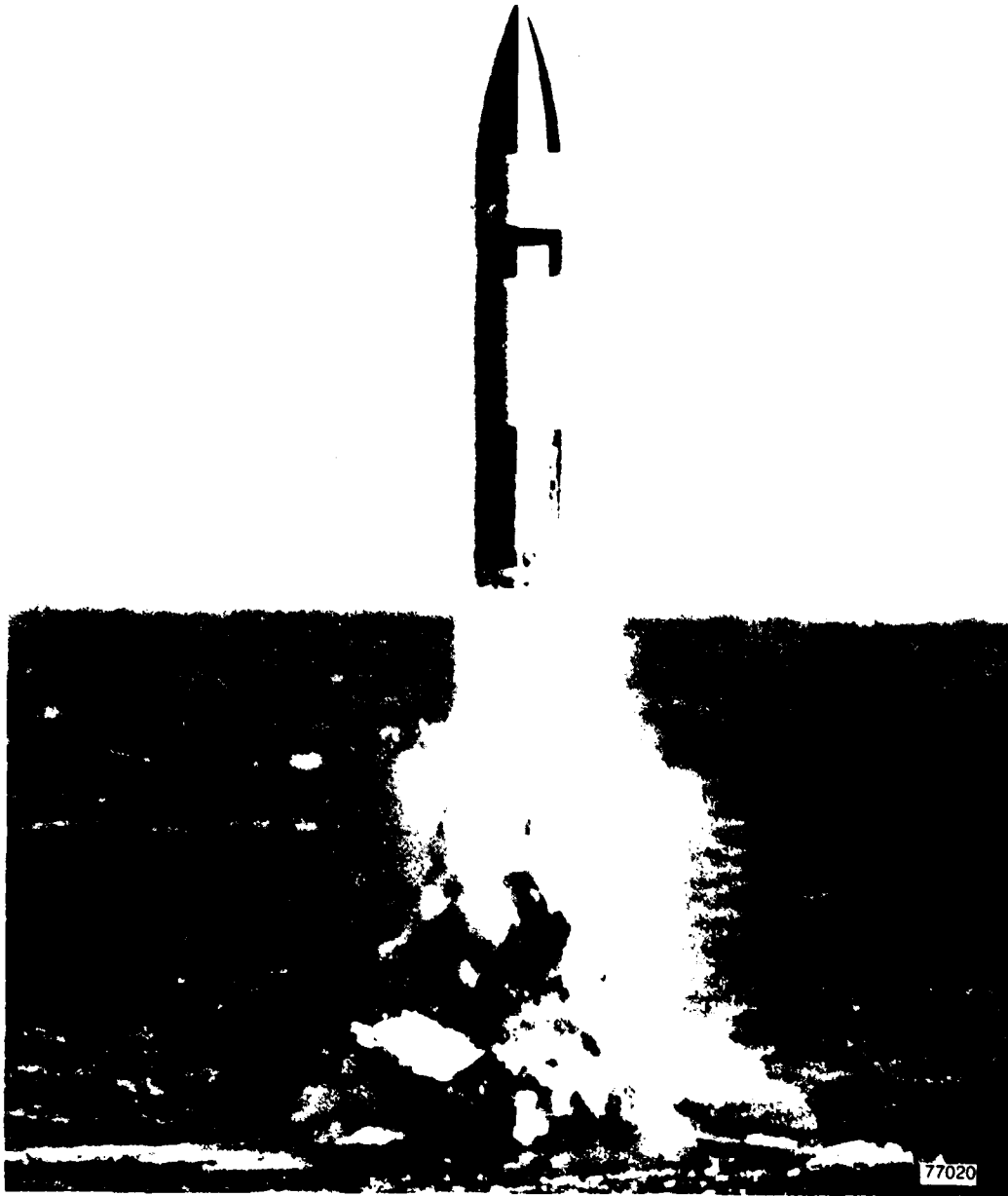

THE POLARIS MISSILE BEING LAUNCHED BY A SUBMARINE

NRL participated extensively in the conceptual planning and development of the Polaris missile. In addition, the Laboratory was responsible for insuring that the instrumentation for the National Missile Test Ranges would have adequate precision and reliability to determine the performance of the missile (1955). This work resulted in the first high-precision missile-range instrumentation radar, which incorporated the NRL-originated monopulse technique.

some aspects of the guidance system required accurate time information. NRL's contributions in these areas are reviewed in this document in Chapter 7, Radio Navigation, and Chapter 9, Precise Radio Frequency, Time, and Time Interval.

The performance of the Polaris missile system, particularly its capability to maintain the missile in a specified trajectory in its flight and to hit the target, had to be accurately assessed. This required high-precision means of observing the position of the missile during its flight, telemetry in the missile to transmit the status of its internal conditions, and missile destruct control facilities should safety require such action. The Department of Defense had designated the Navy as the procurement agency for Tri-Service Instrumentation Radar for its missile ranges. The Navy assigned to the Laboratory the responsibility for insuring that the instrumentation procured for the national missile ranges would have adequate precision and reliability (1955).<sup>39,40</sup> This required the incorporation of advanced features, such as the NRL-developed monopulse technique in tracking radars, with adequate attention to the provision of digital data-processing means. This responsibility was discharged through the surveillance and guidance of contractors and through a Tri-Service Radar Instrumentation Technical Group, of which NRL held the chairmanship. Through this arrangement the first high-precision missile-range instrumentation radar incorporating the NRL-originated monopulse technique was produced, the Model AN/FPS-16 (mobile version AN/MPS-25) (1956).<sup>40</sup> The first radar of this type, the Model AN/FPS-16 (XN-1), was installed at Cape Canaveral to support both the Vanguard satellite program, for which NRL was responsible, and the Polaris missile requirements, with respect to trajectory measurements and range safety control (1957). It immediately proved its worth and became the primary instrument for range safety for all launches from the missile range. This type radar was followed by the model AN/

FPQ-6 (transportable version, AN/TPQ-18) radar, with additional features to enhance precision and overall performance (1961). The first radar of this type was installed on Antigua Island in support of the Polaris program (1961). The national missile ranges, including the Eastern Test Range (formerly the Atlantic Missile Range) at Cape Canaveral, the Western Test Range (formerly the Pacific Missile Range) at Vandenberg Air Force Base, California, and the White Sands Missile Range, New Mexico, were equipped with a sufficient number of these radars and associated equipment to provide them with a capability adequately to deal with the launchings of various types of missiles, satellites, and space vehicles. Some of these radars were also installed at the missile and space tracking stations at Woomera, Australia, and Alberporth, Scotland. Others were installed aboard down-range ships of the Eastern Test Range and those of the National Aeronautics and Space Administration. The various radars were used extensively by the Navy; the Model AN/FPS-16 in particular was considered a range-instrumentation radar of outstanding performance. In carrying out its responsibilities, NRL made observations necessary to determine the accuracy and suitability of the test-range instrumentation.<sup>41</sup> The installations at the Eastern Test Range were of special concern, since this was the principal range used in the evaluation of the flight performance of the Polaris missile. The accuracy of the real-time data pertaining to the velocity vector during flight, point of impact in the ocean, miss distance from designated target point, and similar factors was critical to the success of this missile.

The Polaris missile was first launched from a ship at sea, the USS OBSERVATION ISLAND, on 27 Aug. 1959. The first launch of the missile by a submerged submarine, the USS GEORGE WASHINGTON, occurred on 20 July 1960. The Polaris missile went operational with the USS GEORGE WASHINGTON, carrying 16 of the missiles on 22 Nov. 1960, the beginning of a long series of such nuclear-missile submarines.

**NRL'S GENERAL CONTRIBUTIONS  
TO GUIDED MISSILES**

NRL has carried on a program of basic investigations of importance to the design of guided-missile systems which has continued over many years.<sup>27,42</sup> This program has included studies of kinematics, dynamic stability, airframe-autopilot-control response characteristics, noise dispersion, analysis of frequencies contained in trajectories of interest, and servo-bandwidth requirements. While these studies were directly related to the guidance aspect, they also had an impact on airframe and flight-control-surface design. The results of NRL's diagnostic studies of flame plasmas have had an important bearing on the problem of the propagation of electromagnetic waves through missile-propellant flames and gases. They have led to new missile propellants having constituents which minimize propagation losses and increase the missile control-circuit reliability. This plasma work has enabled NRL to solve problems encountered in telemetry data transmissions between missile and surface equipment, during both launch and reentry periods, in carrying out the assessment of Polaris missile flight performance.<sup>42</sup> The results have also benefited radio communication and radio control systems for space vehicles. The propellant used in the lunar Surveyor space vehicle was proved by NRL to have characteristics which would assure satisfactory functioning of the vehicle's radar which controlled the rate of its descent to the moon's surface (1963). The instrumentation at the John F. Kennedy Space Center, used for its propellant investigations, is based on NRL's work. Such instrumentation has found worldwide use. The results of NRL's extensive pioneering work in missile guidance have contributed importantly to the capability of the guided missiles now in active service or projected, including such surface-to-air missiles as the Terrier, Talos, and Tartar, and air-to-air missiles such as Sparrow and the Phoenix. NRL has continued to play a key technical role in advancing the Navy's guided-missile capability.

**REFERENCES**

1. J.H. Hammond and E.S. Purington, "A History of Some Foundations of Modern Radio-Electronic Technology," Proc. IRE, Sept. 1957, pp 1191-1208
2. NRSR, Oct. 1919, pp. 23-26
3. A. Hoyt Taylor, "Radio Reminiscences: A Half Century," NRL Library 359.0072.T238 Ref.
  - a. pp. 83 and 99, 1960 edition, pp. 171, 172, 1948 edition
  - b. pp. 96, 99, and 126, 1960 edition, pp. 172 and 218, 1948 edition
  - c. p. 96, 1960 edition, p. 165, 1948 edition
  - d. pp. 217, 218, 1960 edition, pp. 374, 375, 1948 edition
4. NRSR
  - Sept. 1920, p. 55
  - Nov. 1920, pp. 13-15
  - Aug. 1921, pp. 37-40
  - May-June 1922, pp. 14, 15
5. A. Hoyt Taylor, "The Teletype Radio Control System: Preliminary Instructions for Type SE 3 Selector Switch and Key Board," Radio Division, NRL Document 306, 407, July 1951
6. C.B. Mirick, "A Wild Goose Chase," Proc. U.S. Naval Inst., 1946, pp. 947-949
  - NRSR
    - Apr. 1923, pp. 12-17
    - June 1923, p. 18
7. D.S. Fahrney, RADM, "The History of Pilotless Aircraft and Guided Missiles," Bureau of Aeronautics File: Federal Record Center N59-318, NRL Document 483,831
  - a. Chapter IV, pp. 152-180
  - b. Chapter VII, pp. 305-308
  - c. Chapter VII, pp. 328-329
  - d. Chapter VII, p. 344
  - e. Chapter VII, pp. 347-348
  - f. Chapter VII, pp. 362
  - g. Chapter VII, pp. 370-376
  - h. Chapter VIII, pp. 377-400
  - i. Chapter VIII, pp. 405-416
  - j. Chapter VIII, pp. 417-420
  - k. Chapter XI, pp. 822-847
  - l. Chapter XI, pp. 848-855
  - m. Chapter IX, pp. 434-566
  - n. Chapter X, pp. 623-711
  - o. Chapter IX, pp. 566-622
  - p. Chapter XV, p. 1150
  - q. Chapter IX, pp. 598-622
  - r. Chapter IX, pp. 538-566
  - s. Chapter XV, pp. 1155-1189
8. NRSR, Jan. 1922, pp. 9-14
9. NRSR, Mar. 1925, pp. 42-43
10. Bureau of Engineering letter to NRL, NR 23,567, 18 Sept. 1933
11. Chief of Naval Operations letter to the Chiefs of the Bureaus of Aeronautics and Engineering, 1 May 1936
12. NRL letters to Bureau of Engineering, 9 Nov. 1936 and 2 Feb. 1938
13. Report, Commanding Officer, USS RANGER, 29 Aug. 1938, Bureau of Aeronautics (NAVAIR) files
14. Commander-in-Chief report to Chief of Naval Operations, F31-10 0409, File F31-10431, Vol. 3, 22 Mar. 1939
15. Chief of Naval Operations letter to Director, NRL via the Bureau of Engineering, 5 May 1939, File OP-22-B5(SC) QT F421, Serial 4093, NRL CRMO

## RADIO REMOTE CONTROL - MISSILE GUIDANCE

16. J.T. Burke, "Kingfisher 'E' Command Control System, NRI Report 3331, Aug. 1948.
17. Bureau of Aeronautics letter to Chief of Naval Operations, 30 Oct. 1940, File 117 (Controls).
18. Bureau of Aeronautics letter to NRI, 1 Aug. 1944, NRI File FSI 145129.
19. NRI letter to Bureau of Ships, 7 July 1943, File 77, Ser. 1480, Radar Installations.
20. C.H. Smith, Jr., M.W. Rosen, and C.H. Hoepfner, "The AN ARW-1 Receiver, NRI Report 3171, Dec. 1944.
  - H. Krause, NRI memorandum to Superintendent, Radio Division, on Achievements of NRI during period July 1944 to June 1945, 18 June 1945, NRI File 886-35.
21. "The Bat: Electronic Kamikaze Guides Navy Glide Bomb to Target," U.S. Navy Airborne Electronics Digest, Nov. 1946, pp. 3-8.
  - Bat Program, Report on ASM-N-7 Modification, U.S. Naval Aviation Electronics Digest, Oct. 1948, pp. 6-8.
  - Guided Missile Attacks, Operational Use of an Airborne Weapon, U.S. Naval Aviation Electronics Digest, Feb. 1949, pp. 14-15.
22. NRI letter to Bureau of Aeronautics, Ser. 117, 17 Mar. 1945, NRI File 131143, Vol. 10.
23. A.S. Locke, "Lark Wasp Guided Missile Seminar," NRI Report 3070, Jan. 1947.
  - A.S. Locke, "Lark Wasp Guided Missile Seminar," NRI Report 3075, Feb. 1947.
  - W.C. Hodgson, "NRI Lark Wasp Guidance Program," NRI Report 3078, Apr. 1947.
  - A.S. Locke, "Lark Wasp Guided Missile Seminar," NRI Report 3094, Mar. 1947.
  - A.S. Locke, "Lark Wasp Guided Missile Seminar," NRI Report 3108, Apr. 1947.
  - A.S. Locke, "Lark Wasp Guided Missiles Seminar," NRI Report 3135, May 1947.
  - A.S. Locke, "Lark Wasp Guided Missile Seminar," NRI Report 3144, June 1947.
  - A.S. Locke, "Lark Wasp Guided Missile Seminar," NRI Report 3188, July 1947.
  - A.S. Locke, "Guided Missile Seminar, September 1947," NRI Report 3318, July 1948.
  - R.F. Gaylord, C.H. Dodge, G.H. Franck, H. Kehm, W.N. Shaddix, E.O. Snyder, B.H. Stafford, C.W. Stoops, R.B. Wagner, "Airborne Phase of the Naval Research Laboratory Beam Riding Missile Control Program," NRI Report 3816, Aug. 1951.
  - *Pilotless Aircraft, Part XI, Lark Telemetry*, Outline of a Typical EM Subcarrier System, U.S. Navy Airborne Electronics Digest, Mar. 1948, pp. 15-19.
  - *Beam Rider, Radar Guidance for the Lark*, U.S. Navy Airborne Electronics Digest, June 1948, pp. 3-6.
  - *Project Hurricane, Rapid Data Reduction System Under Development*, U.S. Naval Aviation Electronics Digest, Feb. 1949, pp. 7-10.
24. Annual Technical Report, Fiscal Year 1948, NRI Report 3120, 1948, pp. 50-52.
25. Navy Airborne Electronics Digest, Sept. 1954, pp. 3-11.
26. C.R. Ahern, "Development of the Radar Beacon AN DPN-3.
27. "Lark SP-1M Radar Equipment, NRI Prototype for ANA-MPQS and ANA SPQ-7 Radars," NRI Report 3586, Feb. 1950.
  - P.T. Stone, "Linear Frequency Discriminator Design Utilizing Parallel Networks," NRI Report 4111, June 1953.
  - NRI Annual Technical Report, Fiscal Year 1948, NRI Report 3120.
28. A.S. Locke, "Lark Wasp Guided Missiles Seminar," NRI Report 3135, May 1947.
  - A.F. Stecca, M.G. Kaufman, "Some Characteristics of a Proposed Conical Scan Radar Homing Equipment for the SkyLark Missile," NRI Report 3240, Sept. 1947.
  - P. Waterman, C.F. Key, Jr., C.H. Dodge, "Proposed Constant True Bearing Homing System for SkyLark," NRI Report 3280, Apr. 1948.
  - Lark SP-1M Radar Equipment, NRI Prototype for ANA-MPQS and ANA SPQ-7 Radar, NRI Report 3586, Feb. 1950.
  - *Project Hornet*, Report of NRI Progress, Dec. 1949, p. 30.
  - *Project Hornet*, Report of NRI Progress, Jan. 1950, pp. 44, 45 (two separate Problem Notes).
29. H. Gordon, Jr., "Development of the Radar Seeker AN DPN-3XN-1," NRI Report 3107, July 1947.
30. J.T. Burke, "Kingfisher 'E' Command Control System," NRI Report 3331, Aug. 1948.
  - NRI Annual Technical Report, Fiscal Year 1948, NRI Report 3120, p. 51.
31. J.P. Kirwan, J.T. Burke, G.F. Wall, "ASM-N-7 Orbite Guidance System," NRI Report 3158, Nov. 1947.
32. "ASM-N-7 Bullpup Guided Missile Weapon System," U.S. Naval Aviation Electronics Digest, June 1958, pp. 35-40.
  - AN ARW-1 Radio Control Set, A/D-2N and H-1B Command Guidance for Bullpup, U.S. Naval Aviation Electronics Digest, June 1958, pp. 41-45.
  - "FY 1964 Improvements in Navy Readiness Condition," U.S. Naval Aviation Electronics Digest, Dec. 1962, pp. 30-33.
33. NRI letter to DCSO (AIR), Serial 4559, 29 Dec. 1944, NRI File 13114, Vol. 6.
34. M.W. Rosen, M.F. Kuder, E.N. Pettitt, "Development of Remote Control for the H-1 Flying Bomb," NRI Report 3616, Oct. 1948.
  - *Pilotless Aircraft, Part I, Future Weapons Forecast*, U.S. Navy Airborne Electronics Digest, May 1947, p. 6.
  - *Coaxial Cables*, U.S. Navy Airborne Electronics Digest, Jan. 1947, pp. 17-18.
  - *Loon Report*, U.S. Navy Airborne Electronics Digest, Aug. 1948, pp. 3-7.
  - *Project Derby, Loon Submarine Tests Prove a Success*, U.S. Naval Aviation Electronics Digest, Nov. 1948, pp. 3-9.
35. "Status Report on Guided Missiles," U.S. Naval Aviation Electronics Digest, Sept. 1954, pp. 3-6.
  - *Regulus I Surface to Surface Weapon System*, U.S. Naval Aviation Electronics Digest, Sept. 1954, pp. 17-24.
36. J.P. Kirwan, R.E. Blake, J.B. Burdick, "NRI High Security Command Guidance Equipment," NRI Report 4170, Mar. 1953.
37. W.J. Raborn, RADM, Navy Fleet Ballistic Missile Director's Office, letter to Joint Army-Navy Executive Committee, 16 Mar. 1956.
  - Flood and Gallagher, "The Industry's Role in the Polaris Program," Serial, Feb. 1961, pp. 10-26.
38. W.W. Balwanz, P.T. Stone, "The Plasmas of Missile Flight: Analysis of Polaris AX Signal Absorption," NRI Report 5646, July 1964.
  - P. Waterman, W. Hodgson, E. Calhoun, W. Shaddix, D. Barclay, "Planning for Advanced Sea-Based Deterrent Systems," NRI Report 5810, July 1962.
  - H.H. Dunn, D.D. Howard, "NRI Services Provided in the De-

RADIO REMOTE CONTROL MISSILE GUIDANCE

- velopment of Tri-Service Missile Range Radar Instrumentation, NRL Report 5845, Oct. 1962
- P. Waterman, C. Dodge, "The Use of the Ocean as a Defensive Weapon," NRL Report 5870, Nov. 1962
- R. A. Meussner, L. E. Richards, A "Pest Problem" in the Oxidation of Aluminum and Aluminum-Tin Alloys," NRL Report 6115, Apr. 1964
- C. E. Holland, "Field-Effect Transistors Synthesize S-Type Negative Resistance," NRL Report 6146, Sept. 1964
39. J. H. Dunn, D. D. Howard, "NRL Services Provided in the Development of Tri-Service Missile Range Radar Instrumentation," NRL Report 5845, Oct. 1962
40. H. Neilon, "Tracking Performance of the C Band Version of the Radar AN/FPS 16(XN) 1," NRL Memo Rept 601, June 1956
41. C. F. White and J. P. Kirwan, "An Appraisal of the AN/SPG 49 Radar Relative to Polaris Instrumentation Requirements," NRL Memo Rept 988, Nov. 1959
42. W. W. Balwanz, P. T. Stone, "The Plasmas of Missile Flight - Analysis of Polaris A2N Signal Absorption," NRL Report 5636, July 1961



## Chapter 6

### RADIO IDENTIFICATION

#### Identification Friend or Foe—IFF

#### INTRODUCTION

In 1934, when NRL began its efforts to provide a means of target identification, the problem of avoiding the destruction of friendly ships in warfare had been one of long standing, with its solution impeded by many difficulties. Neither the Army nor the Navy had a device which would adequately identify targets on the ground or the sea, or in the air, particularly in overcast weather and at night. The rapid rise in the capability and utility of aircraft introduced an acute problem in identifying friendly planes returning to carriers under conditions of poor visibility. Procedural expedients for identification were resorted to, such as requiring returning aircraft to approach carriers within a specified sector, where they were to remain until a visual challenge by searchlight was satisfied through the recognition of certain agreed-upon maneuvers by the aircraft. NRL had felt that a satisfactory solution of the problem could be obtained through the use of radio means, and during its early work on microwaves brought their advantages in this regard to the attention of the Navy Department (1935).<sup>1</sup> Subsequently, the Laboratory was sponsored by the Bureaus of Engineering and Aeronautics to provide a suitable radio-identification system. NRL's initiative resulted in the beginning of a program, continuing to the present day, in which NRL pioneered the development of a succession of new and improved radio-identification systems for the several military services of the United States and its allies. Today, NRL still holds a prominent position in the advancement of IFF Systems.

#### FIRST IFF SYSTEM

As an initial step in a continuing program, NRL developed the first radio recognition (IFF) system in the United States (Model XAE) (1937).<sup>2</sup> This system provided air-to-surface coded transmissions from an aircraft, received for identification aboard ship, with transmissions back to aircraft for verification. Trials of the air-to-ship portion of this IFF system conducted by the aircraft carrier USS RANGER (CV 4) in 1938 were followed by the addition of the ship-to-air portion and the beginning of production (General Electric Co.) for operational use in January 1939. When in the presence of friendly ships, the pilot turned on this equipment to avoid gunfire attack. The omnidirectional coded transmissions from the aircraft were controlled by a contactor operated by a rotating disk, the edge of which was notched in accordance with the code. To improve security, the code disk could be changed quickly to others with different identifying codes, following an agreed-upon time plan. A beam antenna which could be aligned with the aircraft was used aboard ship for both reception and return transmission. The ship's transmissions caused a light to flash on the aircraft, which could be seen by the ship. The 500-MHz carrier used was modulated at 30 kHz, to give an additional measure of security.

While developing the Navy's first operational radar, the Model XAF, NRL devised an IFF system comprising a rotating beam antenna, the elements of which were keyed so as to cause the antenna to reradiate in accordance with an identifying code (1938). Identifying emissions

RADIO IDENTIFICATION

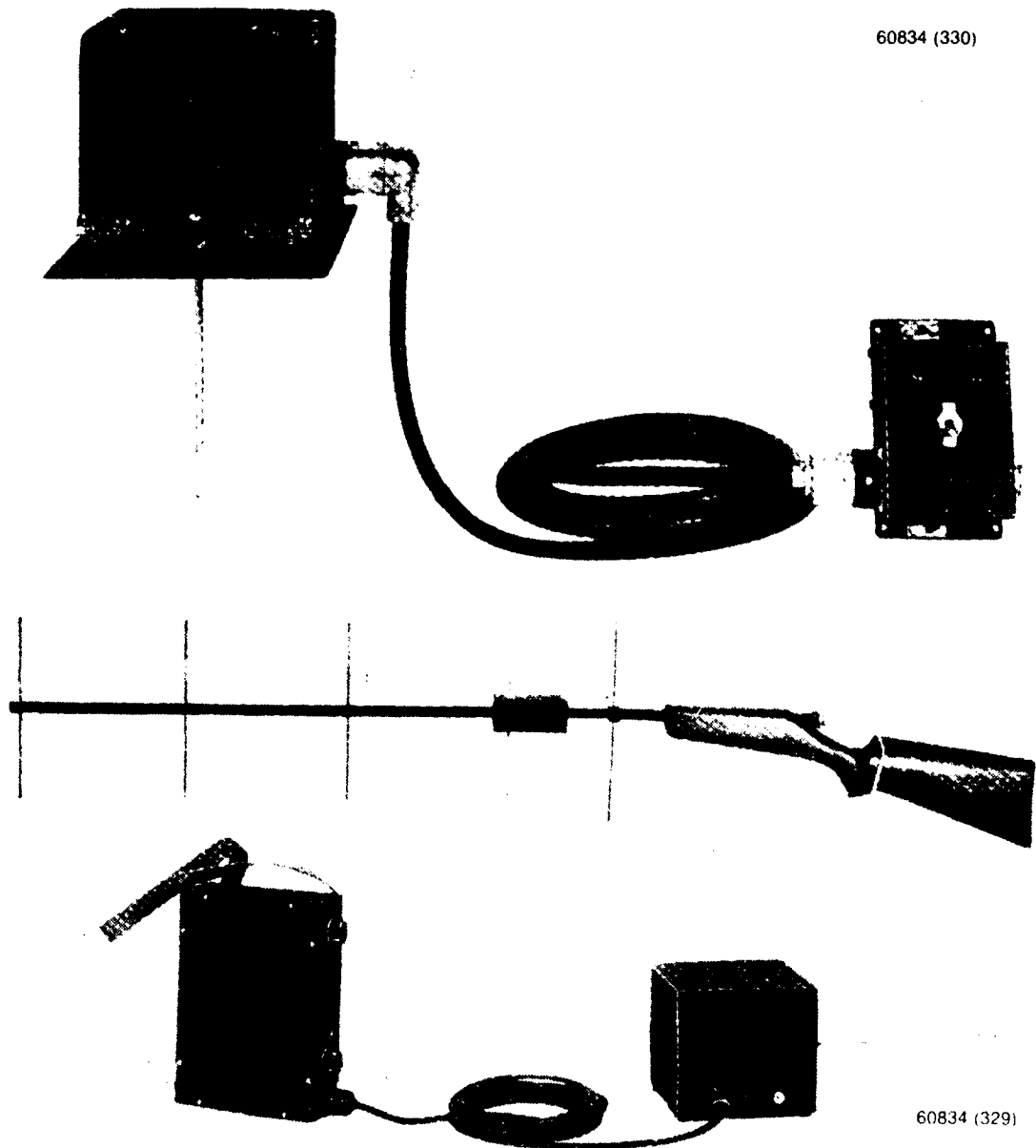

**THE FIRST RADIO RECOGNITION IFF SYSTEM IN THE UNITED STATES  
THE MODEL XAE (1937)**

This airborne equipment, developed by NRL, is shown at the top; the shipborne equipment is shown below. When in the vicinity of friendly ships, the aircraft equipment transmitted a series of coded signals. Aboard ship, the Yagi antenna - gun shaped equipment was pointed at the aircraft, to flash.

could be observed at an illuminating radar when the antenna of the device, which rotated, pointed in the direction of the radar. Such a system was provided and its performance demonstrated by NRL during the trials of the Model XAF radar aboard the battleship USS NEW YORK, when the fleet exercises were held in early 1939.<sup>3</sup> The equipment was mounted on a destroyer and proved adequate to identify this ship among many other ships engaged in the exercises.

#### PULSE IFF

In proceeding with the development of pulse techniques for radar, NRL also sought their use for IFF. Through its efforts, NRL devised the first IFF system in the United States in which radar pulses received by a target ship or aircraft were repeated back to the radar and displayed as a pulse associated with the echo pulse on the scope (A-type presentation) (1939).<sup>3,4</sup> As part of this system, NRL developed the first U.S. pulse transponder, basic to pulse IFF systems and pulse beacon systems (1939).<sup>5</sup> In challenging, the pulse rate of the radar was changed to correspond to the frequency of a pulse filter in the pulse repeater. Thus, the repeater was active only when challenged. The transponder comprised a receiver and a super-regenerative oscillator, bias-blocked in the absence of a signal and triggered off by an interrogating pulse from the challenging source. This transponder was used later in the Model ABK transponder and in transponder beacons such as the AN/APN-7. They were used with "interrogator-responder" equipments Models BJ, BK, BL, and BN. When the British disclosed their IFF work to the United States in 1941, it was realized that they had independently developed and used this transponder in their Mark I and Mark II IFF systems.

#### IFF WITH CRYPTOGRAPHIC SECURITY

To advance the security in target identification, NRL devised an IFF system which was first to incorporate binary digital techniques

to provide cryptographic security in the automatic challenge and reply functions (1940).<sup>6</sup> This was the first use of binary digital techniques in an electronic system. These techniques received important and widespread application in electronic computers and communication systems. NRL's binary digital techniques were adopted later by the leading electronic computer manufacturers. The digital system was arranged with three pulse groups, each totalling 32 bits. A correct number count on the first group led to the second and then to the third group, which, if the count were correct, actuated the response to the challenge. A similar process was used at the challenge point to verify the reply transmission. In a later arrangement, more pulse groups were added. The challenge and reply in this system were automatic and practically instantaneous. A directive antenna was used in challenging to isolate, as far as possible, the challenged target. Other antennas were omnidirectional. A radar-type duplexer was used on the transponder to permit operation on a single antenna. This system was successfully demonstrated in two-way operations between the Laboratory and Fort Washington, Maryland (May 1940).

#### WORLD WAR II-IFF

In 1940, with war imminent, it became urgent to fit the Navy's ships and aircraft with the best IFF system that could quickly be made available. In meeting this need, NRL developed the first IFF system of the combined military forces of the United States (1940).<sup>7</sup> This IFF system was the first to use separate frequency channels, independent of radar channels, for challenge and reply (470 and 493.5 MHz) (1940).<sup>8</sup> It made possible universal use of the system with radars of any frequency and also avoided difficulties which limited the performance of the original transponder. This IFF system was designated the Models ABA (airborne) and BI (shipborne). Other shipborne versions were the Models BA, BE, BF, BG, and BH. For this system NRL selected the features it had found most

## RADIO IDENTIFICATION

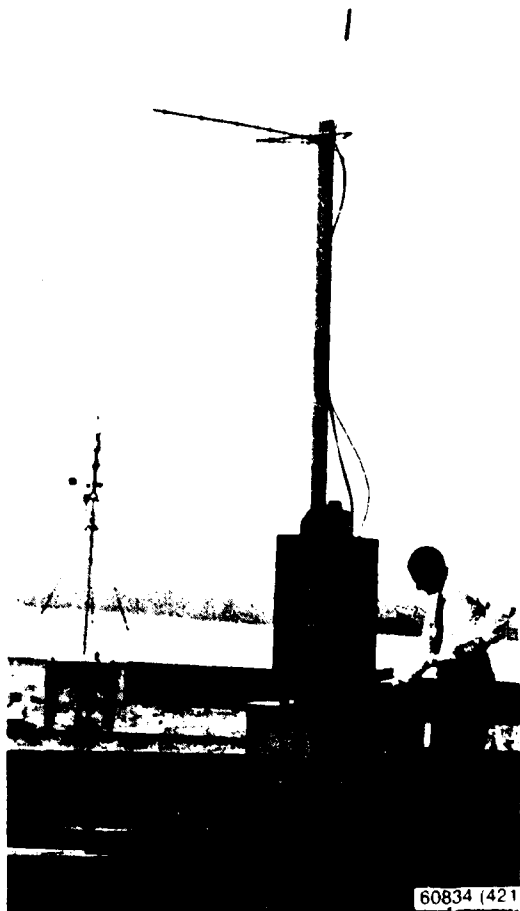

practical and adaptable in its previous research. The triggering of the original transponder caused by local echoes and feedback in transmitting and receiving on the same frequency had imposed limits on its sensitivity and correspondingly on its range. With separate frequency channels, higher transmitter power and sensitivity could be used, with greatly increased operational range and reliability. In making another feature available for the system, **NRL was first to provide means of displaying an IFF response associated with the target echo in a PPI presentation, which permitted for the first time ready target isolation in azimuth as well as range (1940).<sup>9</sup>**

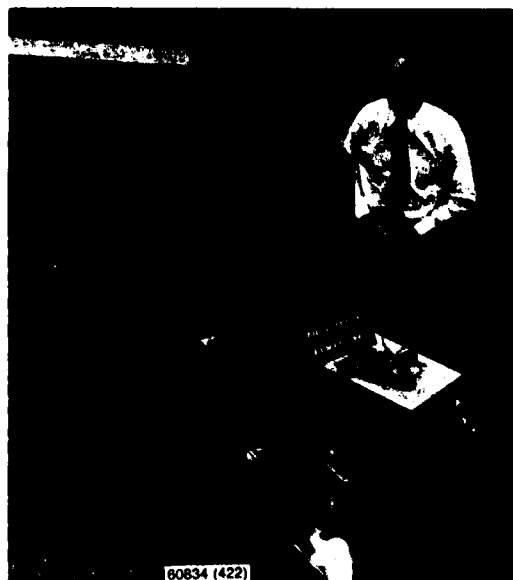

**FIRST PULSE IFF SYSTEM (1939)**

This system, developed by NRL, was also first to incorporate binary digital techniques to provide cryptographic security in the automatic challenge and reply functions. Dr. C. E. Cleeton, shown operating the equipment, later became technical head of the "Combined Research Group," located at and under the jurisdiction of NRL. The group was composed of American and British scientists, which furthered the development of IFF during the war. Dr. Cleeton was also NRL's Associate Director of Research for Electronics, 1963 to 1969.

To obtain this type of display, the pulse rate of the IFF system was synchronized with that of the radar. NRL's binary digital security feature was not included in this system, since the digital circuitry at that time required the use of many vacuum tubes, which made it too bulky for installation in aircraft. Its use had to await the arrival of the compact solid-state type of digital circuitry which did not become available until many years later. Instead, for security, supersonic modulation, keyed for code identity, was imposed upon the transmitted carrier, with a corresponding filter to select the coded information upon reception. In the procurement of this IFF system

## RADIO IDENTIFICATION

equipment in quantity, NRL provided guidance to the contractor (General Electric Co.) and evaluated the product to insure satisfactory operational use. The Army, having no suitable IFF device, joined with the Navy in this procurement. Models of the equipment became available early in 1941; over 3000 were produced. These were used by the Army and the Navy in determining the operational effectiveness of the system. They were also used operationally toward the end of the war in the Pacific theater. During the interim between the availability of the equipments and their use in the Pacific, the system was held in reserve, pending the possible compromise of another system, the Mark III, which came into being as a result of contact with the British. NRL's system was finally designated the Mark IV.

### MARK III IFF SYSTEM

When the policy of interchanging technical information between the United Kingdom and the United States was established in the fall of 1940, in furtherance of the war effort, information was obtained on an IFF system the British had been using known as the Mark II. This system employed a transponder, of the type NRL had devised, which responded to each pulse of a radar when tuned to its frequency. This transponder swept every six seconds through the frequency band occupied by the radars then in use, responding to each radar in turn. At the radar the transponder's response was presented on the horizontal line of a cathode-ray tube as an increase in amplitude and width of the radar echo pulse. Two degrees of widening of the pulse served as a means of coding the response. It was proposed that the United States adopt this IFF system. NRL objected to this on the basis that the British system transponders emitted IFF signals due to circuit instability and triggering by noise, whether challenged or not; that it radiated pulses at a high rate when excited by non-radar CW or modulated CW signals, rendering the system incapable of responding to a challenge; that such a system would soon become saturated and in-

operative under critical combat conditions, since radars were then increasing rapidly in number; and that with large numbers of radars distributed over a wide frequency region, the system would become very complex. The British had realized the existence of these difficulties and had considered the use of an IFF frequency band independent of the radar frequencies, such as NRL had provided in its Model ABA-BI system. The British were concerned that NRL's IFF system would quickly be compromised, since its operational frequencies were so close to the frequency of the German Wurzburg Radars (550 MHz) as to invite attention and adverse action.

As a result of discussions an IFF system, known as the Mark III, was adopted for joint use by the United Kingdom and the United States (1942).<sup>10</sup> Although a frequency independent of the radar frequencies was used in this system, due to difficulty in maintaining the IFF equipment precisely on a single frequency it was arranged to sweep through the frequency band 157 to 187 MHz every 2-1/2 seconds. The inherent lack of synchronization between this sweep rate and the radar antenna rotation rate made it impractical to use the PPI display for azimuth correlation of IFF response with the radar echo. However, since IFF antennas were mounted on radar antenna reflector structures to obtain directional characteristics, it was possible to provide correlation in both azimuth and range by stopping the rotation of the antenna and pointing it in the direction of the target echo. This process, however, was very slow. The United States proceeded with large-scale procurement of the Mark III IFF equipment to supply both its needs and that of its allies. The equipment included the airborne models ABK and AN/APX-1 (transponders) and the shipborne models BL, BM, BN, BO (interrogator-responder). NRL provided the necessary guidance of contractors and the evaluation of their products. NRL also had the responsibility of adapting this system to the various Navy radars and to provide such improvements as were feasible to add to the system during the war. The Mark III IFF system continued in use throughout the wartime

## RADIO IDENTIFICATION

period. Many thousands of these IFF equipments were produced. The system was installed on practically every aircraft and ship of the U.S. forces. It was used extensively, particularly during operations in the Pacific.

### MARK V IFF SYSTEM

It was recognized that the Mark III IFF system had many deficiencies and that further effort had to be made if operational requirements were to be satisfied. The wartime Radar Committee of the Combined Communications Board under the Combined Chiefs of Staff, after considering the additional IFF operational requirements, recommended that a new system be developed to replace the deficient Mark III system and, in recognition of NRL's experience in IFF, that this be done by the Naval Research Laboratory (September 1942). Accordingly, based on official approval, the Combined Research Group was established at NRL to undertake the development (October 1942). This group, under NRL scientific leadership, comprised British, Canadian, and United States scientists and engineers representing the Armies, Navies, and Air Forces of the three countries and the United States NDRC Radiation Laboratory. Until its disestablishment after the war in June 1946, the Combined Research Group was engaged in the development of the Mark V IFF/UNB (United Nations Beaconry) system.<sup>11</sup>

The Mark V IFF system incorporated the important NRL-originated features of using separate frequencies for challenge and reply, independent of radar frequencies and PPI presentation, with IFF replies associated with radar echoes. These features greatly reduced the time required for identification of a target, since the rotating radar antenna did not need to be stopped during the recognition process. Furthermore, transmitter and receiver frequency separation in the transponder permitted the use of high-gain receivers, resulting in considerable increase in transponder operational range. A higher frequency band (950 to 1150 MHz) was chosen for IFF operation, with

the approval of the Frequency Allocation Board. This change permitted sharper antenna beams for interrogation transmissions, with better isolation of targets in azimuth. This frequency band was divided into twelve channels, quickly changeable, to provide means for avoiding possible enemy jamming.

In interrogation, trains of paired pulses were transmitted to which transponders would not reply unless the pulses of each pair had specific length (one microsecond) and spacing. Three modes of operation, with three different pulse spacings, were provided—Mode I for general identification of friend from foe, with three-microsecond spacing; Mode II for specifically identifying one particular friendly target among many friendlies, with five-microsecond spacing; and Mode III for flight-leader identification, with eight-microsecond spacing. Transponders replied by transmitting a one-microsecond pulse for Modes I and III, and a pair of one-microsecond pulses spaced eight microseconds for Mode II. To provide additional security, the length of the reply pulses was extended to 2.5 microseconds, keyed in accordance with characters of the international Morse code—a short-duration extension being a dot, and a longer duration extension a dash. Selectable three-letter code groups could be transmitted automatically or by a hand key operated by the aircraft pilot, permitting the addition of code letters or the use of a predetermined identification code. This keyed type of transmission was known as the "slow code." Transponder replies were displayed on the PPI as a series of delayed pips associated with the corresponding target radar echo, the pips being elongated radially in transmitting the letter code groups. The first Mark V system equipments, the Models AN/APX-6 (airborne) and AN/CPX-2 (shipborne), became available in August 1944. The system was subjected to considerable evaluation by operational Fleet forces. However, the war was over before the system could be put into operational use. Toward the end of the war a Mark VI system, a simplified version of the Mark V, was considered for early use, but it was abandoned at the end of the war.

## RADIO IDENTIFICATION

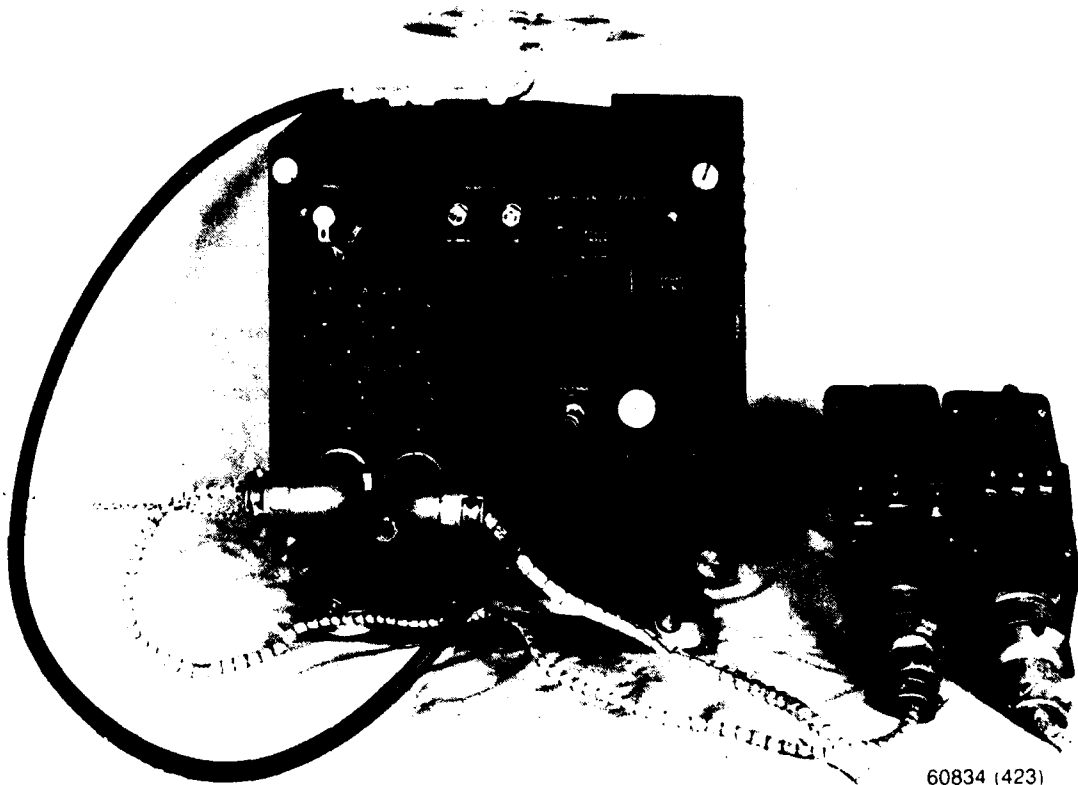

60834 (423)

### MARK V IFF SYSTEM TRANSPONDER - THE AN/APX-6

This IFF system, developed by the Combined Research Group at NRL during World War II under NRL technical leadership, incorporated the NRL-originated features of separate frequencies for challenge and reply, independent of radar frequencies, and IFF responses associated with radar echoes in PPI presentations.

### MARK X IFF SYSTEM

After the war the Combined Research Group was disbanded, and NRL established a group with its own personnel to conduct a program which would advance IFF system capability. The security features of the Mark V IFF system were considered seriously inadequate, since an enemy

could equip his forces with transponders which, through his intercept of our transmissions to give him the "code of the day," could enable him to deceive us through giving a friendly response. Furthermore, he might interrogate our transponders for positive identification of our craft. Thus, a primary objective of the NRL program was the provision of adequate security. However, at that

## RADIO IDENTIFICATION

time, high-speed jet aircraft were rapidly becoming available, and by 1948 it became urgent to provide improved means of tracking such craft. The weak radar echoes from this type of aircraft had to be reinforced through the use of a transponder or beacon, and means provided to supply the position and identity information required for interception, navigation, and air traffic control. It was decided to adapt the Mark V system to serve this purpose.<sup>12</sup> The "slow-code" security feature of this system was dropped, in view of its inadequacy and the possible availability of a superior security system as a result of NRL's efforts. Pressure for the assignment of frequency channels from sponsors of other electronic systems resulted in relinquishment of the 950 to 1150 MHz band, with the exception of two channels, 1030 and 1090 MHz, used respectively for interrogation and response. The NRL features of separate frequency channels, independent of radar channels, for interrogation and reply and display of IFF response on the PPI were retained. This modified system was designated the Mark X, the "X" at first being interpreted as the "unknown future IFF system" and later as the numeral "ten." NRL provided guidance of the contractor in its production (Hazeltine Electronics Co.) (1949). During the early 1950's many thousands of the Mark X system equipments were procured by the Navy for installation on its own aircraft and ships and for use by the Air Force.

### MARK X (SIF) IFF SYSTEM

During the interim, NRL had continued its efforts toward a high-security IFF system. About 1950, U.S. Air Force representatives became interested in NRL's work and began a long period of cooperation to obtain such a system. Likewise, representatives of the Federal Aviation Administration sought NRL's assistance in connection with its air-traffic-control problem. Continuing discussions, with the various responsible organizations and offices participating, made evident that a system with common elements for use by both civilian and military aircraft was feasible

and also advantageous. The result was an agreement between the Federal Aviation Administration and the Department of Defense on such a common system for Air Traffic Control. To accommodate the broadened requirements, particularly that of contending with large numbers of aircraft, the reply codes of the Mark X system were modified. The codes for all operational modes were standardized by arranging two bracket pulses with 20.3-microsecond spacing to be transmitted with each reply, with provision for a total of 8192 codes on each of a total of four modes (A, B, C and D). The mode C was introduced to provide altitude information necessary for both military and civil air traffic control. The modified Mark X system, with its expanded "selective identification feature" (SIF), was designated the Mark X (SIF) system. The designation Mark XI was reserved for this system but never utilized. NRL contributed to the development of the modified circuitry of both the interrogator and transponder of the Mark X (SIF) system and to the guidance of the contractors selected to produce the equipment in quantity (1951).<sup>12,13</sup> The Mark X (SIF) IFF system became operationally available in 1959 and was installed in most military aircraft, remaining in service for many years. As modified for civil air traffic control, it has continued in use by the aviation agencies of the United States and foreign countries. Under civil usage it became known as the "Air Traffic Control Radar Beacon System" (ATCRBS).

### MARK XII IFF SYSTEM

In seeking a high-security IFF system, NRL first made a study of the various operational aspects attending such a system and the technical approaches which might offer a satisfactory solution of the problem.<sup>12</sup> It was apparent that the solution of the problem was to provide means of asking the question "Are you a friend?" and making possible the reply in so many ways that the probability of an enemy "guessing" the correct interrogation and response would be



## RADIO IDENTIFICATION

extremely low, particularly in the time he might have available to do it. By 1951 NRI had developed an experimental binary digital security system meeting these requirements, but using a rather large number of vacuum tubes. By 1952 solid-state devices (transistors) had become available, and NRI employed them in a model of a secure system of more practical size. As solid-state devices were improved, NRI was able to provide a system having reliability adequate for operational use. A seminar held by NRI in 1955 at which NRI disclosed its results was followed in 1956 by the formation of an ad hoc group on IFF by the Navy, Air Force, and Army to pursue commercial production of the system. **The basic principles formulated by NRI and the series of developments it carried out resulted in the Mark XII IFF system (1960).**<sup>12</sup>

**This IFF system was the first to provide security through the incorporation of cryptographic encipherment adequate to deter an enemy from successfully using the system or applying countermeasures against it. This Mark XII system was subsequently used by the several U.S. military services.**

### PULSE BEACONS

Although NRI's development of the first U.S. pulse transponder in 1939 was directed to the identification of targets for IFF, its value as a navigational beacon was soon appreciated and utilized. Beginning in 1941, NRI provided experimental models, critical technical information, and guidance of contractors in the procurement of a succession of navigational pulse

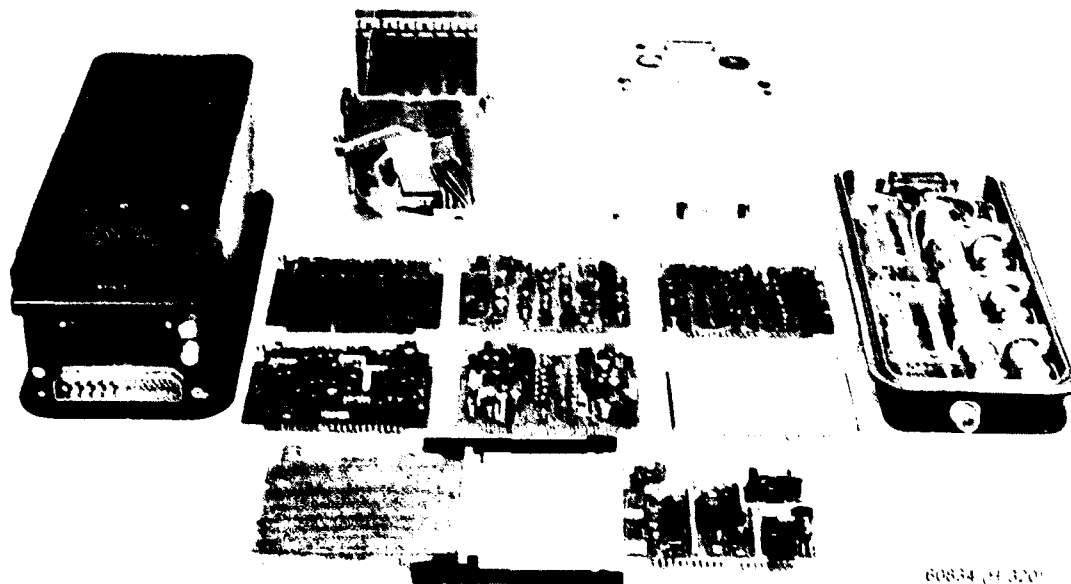

### THE MARK XII IFF TRANSPONDER

This transponder, conceived and developed by NRI under Bureau of Naval Weapons supervision, represented the latest in design and performance (1960). This system resulted from the basic principles formulated by NRI and from the series of developments the Laboratory carried out. This IFF system was the first to provide security through the incorporation of cryptographic encipherment adequate to deter an enemy from successfully applying countermeasures. The Mark XII was fully compatible with all Department of Defense directives and requirements.

## RADIO IDENTIFICATION

beacons.<sup>14</sup> The model YH was the first procured in quantity. This beacon was installed along the west coast of the United States, making possible aircraft navigation from southern California to the tip of the Aleutians by relying on the beacon installations and airborne radars alone. These beacon installations gave valuable service to the U.S. armed forces in taking back the fog-bound Aleutians from the Japanese. These beacons were also used by aircraft operating in the Atlantic and Mediterranean areas, and in the southern Pacific zone. The Model YJ beacons were developed for use with NRL's Model ASB airborne radar and replaced the Model YH in service. A version of this beacon, the Model YJ-2 was installed aboard carriers for use in returning aircraft to their respective carriers. A later model, the AN CPN-6 beacon, besides being installed on all carriers, was used as the basis for precision bombing of Germany, in addition to its general navigational use by the Navy and Army, and by the British. Shore-bombardment beacons for use in pin-pointing naval gunfire, when used with naval fire-control radars, were extensively developed by NRL, commencing with the Model AN APN-13. These were used effectively in assault landings in the Pacific.

NRL's pulse-beacon technique has been utilized in various types of electronic systems, as indicated under other titles in this document. It found wide employment in a variety of U.S. and allied systems. The pulse-beacon technique is also the basis of the distance-measuring equipment (DME) used extensively today in civil aircraft navigation. The beacon technique is also used in the tracking of space vehicles.

### REFERENCES

1. W. F. Cahill, Present Day Technique for Radio Transmission and Reception in the Micro Ray Frequency Band (300-3000 Mc) with Suggested Applications for Naval Purposes, NRL Report 1149, Apr. 1935.
2. A. Hoyt Taylor, Radio Reminiscences, A Half Century, pp. 180-181, 1960 edition, pp. 307-310, 1948 edition, NRL Library 359.072 T:38 Ref.
  - Radio Recognition Transmitter and Receiver, NRL Job Order S-V 5071, 31 Aug. 1937, NRL CRM O.
3. L. R. Philpott, Log No. 1, 1936 to 1941, NRL Register No. 333, NRL CRM O.
4. Commander Atlantic Squadron letter to Chief of the Bureau of Engineering S67 FF 3-5 (S.68), 4 Apr. 1939, copy in NRL File S-675, "Radio Detection of Moving Objects, 1936 to 1939, NRL CRM O."
  - NRL letters to Bureau of Engineering, 26 Feb. 1930, and 13 May 1931, NRL File S-67-5/36, No. 2, July 1939-Sept. 1940, NRL CRM O.
5. NRL letter to Bureau of Ships, S 567 36; Ser. 266, 13 May 1941, NRL CRM O.
6. R. M. Page, U.S. Patent 3,113,733.
  - Recommendation of Presidential Award for Dr. Robert M. Page, 13 Sept. 1959, NRL Document 217,301.
7. E. H. Krause and M. W. Rosen, Jr., Ship to Ship Pulse Recognition System, NRL Report 1794, Oct. 1941.
  - E. C. Cleeton, U.S. Patent 2,536,035, filed Dec. 1939.
  - Radio Recognition Signals, NRL File SO S67 33, NRL CRM O.
  - E. C. Cleeton, logs for 1938 through 1941, NRL Registers 179, 336, and 1085, NRL CRM O.
8. Radio Detection of Moving Objects, NRL File S 67 5, 1936-1941, NRL CRM O.
  - Radio Recognition, NRL File S 567 33, 1941-1944, NRL CRM O.
9. R. M. Page, U.S. Patent 3,296,015.
10. R. M. Page, U.S. Patents 3,143,733 and 3,296,015.
11. A. Hoyt Taylor, Radio Reminiscences, A Half Century, pp. 248-249, 1960 edition, pp. 311-314, 1948 edition, NRL Library 359.072 T:38 Ref.
  - Brown, R. H., Mark V USB IFF System Design, NRL CRG 97, Oct. 1945, NRL Document 299,096.
  - A. D. Hammes, R. E. Adams, A Directional Mk 3 IFF Antenna for Use with Mk 4 Radar, NRL Report 2761, Apr. 1944.
  - P. A. Lantz, R. E. Adams, A Comparison of Two Proposed Mk III G IFF Antennas for Use with Model SM Radar, NRL Report 2337, Aug. 1943.
  - E. R. Dobler, R. E. Adams, A Lobe Switching Mark III IFF Antenna for Mark IV Radar Equipment, NRL Report 2349, Jan. 1945.
  - E. R. Dobler, E. E. Money, R. E. Adams, Development of Mark III IFF Antenna for Mark XII Radar Equipment, NRL Report 2350, Sept. 1944.
  - NRL File S 567 5, No. 6, July-Sept. 1944, NRL CRM O.
12. E. C. Cleeton, History of the Combined Research Group in Radio Recognition, NRL File S 567 33, 1941-1944, NRL CRM O.
  - Brown, R. H., Mark V USB IFF System Design, NRL CRG 97, Oct. 1945, NRL Document 299,096.
  - Paull, S., Abstract of Information on Methods, Techniques, Components, Equipments, and Results of Work Done at CRG, NRL, NRL CRG 105, July 1946, NRL Document 297,652.
  - C. A. Hansen, IFF: What Happened - What Next, Naval Aviation Electronics Digest, Sept. 1949, pp. 8-13.
13. E. C. Cleeton, The Ability of IFF Mark X to Assist in the Recognition of Hostile Craft, NRL Report 3513, Sept. 1949.
  - H. M. Suske, A Study of Mark X IFF and Loran, NRL Report 3057, Mar. 1958.
  - AN APN-6 Airborne IFF Equipment, U.S. Naval Aviation Electronics Digest, Sept. 1950, pp. 6-8.
  - AN APN-6 Airborne IFF Intercom Transponder Test Procedures, U.S. Naval Aviation Electronics Digest, Jan. 1952, pp. 3-4.

## RADIO IDENTIFICATION

- C.A. Arons, IFF Selective Identification Feature, U.S. Naval Aviation Electronics Digest, Mar. 1956, pp. 5-6
- 13. The AIMS Program - New and Improved Equipments and Techniques for IFF, U.S. Naval Aviation Electronics Digest, Apr. 1958, pp. 8-11
- 14. C.H. Smith, Jr., M.W. Rosen, and C.H. Hoepfner, The AN ARW-1 Receiver, NRI Report 2471, Dec. 1944
- E.H. Krause, NRI Memorandum to Superintendent, Radio Division, on Achievements of NRI during the period from July 1941 to June 1945, 18 June 1945, NRI File S So 7-33, NRI CRMV

## Chapter 7

### RADIO NAVIGATION

#### RADIO DIRECTION FINDERS— "RADIO COMPASS"

Through its early sponsorship of the development of the radio direction finder, the U.S. Navy, in 1923, asserted it had acquired "much more experience with this device than any other organization or country in the world."<sup>1</sup> The first radio direction finder to be installed on a Navy ship was tested on the collier USS *LEBANON* in 1906.<sup>2</sup> The performance of this equipment, developed by the Stone Radio & Telegraph Co., did not meet Navy expectations. Its fixed-azimuth antenna required that the ship be oriented to determine the bearing by observing the point of maximum signal, an inaccurate and cumbersome procedure. Electron-tube amplification was not yet available, so signal strength was limited to that produced by a crystal detector (diode), which was inadequate for useful operational ranges. Little was known about bearing deviation resulting from reradiation from ship superstructure, and its compensation. Several types of direction finders were procured and tested on the USS *WYOMING* (1914) and on the USS *PENNSYLVANIA* and USS *BIRMINGHAM* (1916).<sup>3a</sup> These also proved unsatisfactory for some of the same reasons, even though good electron tubes had then become available.

In 1916, the Navy Department arranged to have a direction finder, developed by Dr. F.A. Kolster, adapted for shipboard installation by the Philadelphia Navy Yard.<sup>4</sup> This equipment (Model SE 74) comprised a single rotating loop with electron-tube detector and two stages of audio amplification. The use of the "minimum" method of bearing determination, with greatly increased sharpness of bearing, was made possible

through the Navy's addition of a "compensating" capacitor in this equipment (Model SE 75) (1916). This capacitor permitted equalizing the loop-to-ground capacity of each side of the loop, thus removing the residual signal due to the loop's "vertical antenna effect," and providing clear nulls when the loop was in minimum signal position. The ambiguous bearings of the simple loop direction finder, due to its "figure-eight" azimuth pattern, were eliminated by the Navy through combining the output of a vertical antenna with that of the loop to form a cardioid pattern (Model SE 995, 300 to 2300 kHz).<sup>5</sup> Further improvement resulted from an assembly of components, with the exception of the loop, in a receiver having three stages of audio amplification (SE 1440) (1918).<sup>6</sup> This receiver with a modified loop became the Model DA direction finder (250 to 600 kHz). To verify the results previously obtained in comparing the several types of direction finders which led to the choice of the rotating-loop type, comparison was again made with the fixed crossed-loop ("Bellini-Tosi") type in its latest form. The rotating-loop type proved to have superior sensitivity, sharpness of directional indication, and simplicity in operation (1920).<sup>7</sup> It continued to be the Navy's choice.

By the end of 1916, twenty of the Model SE 75 direction finders were installed on battleships and cruisers. These were calibrated to provide bearing corrections for deviations caused by ship superstructure. Structural elements had been bonded to ship hulls and guns, and other movable equipments were placed in positions to minimize variations in deviations while taking bearings. Only limited use was made of these direction finders, due to lack of understanding and incentive in their operation. This attitude

## RADIO NAVIGATION

changed radically in World War I, when the success of the German submarine campaign brought about the desperate allied shipping situation in the Atlantic. All destroyers available were fitted with the Model SE 995 direction finder and utilized in locating enemy submarines, in affecting concentrations for hunter-killer operations, and in assembling and escorting convoys in thick weather. An installation of these direction finders at the U.S. Naval Base at Brest, France, permitted surveillance of the German submarines concentrated in the Bay of Biscay. The extensive, uninhibited use of radio communication by the German submarines, unaware of the Navy's direction finders, made it possible to divert allied convoys to avoid them.<sup>3b</sup> This procedure was highly successful. By early 1918, the German submarine service was completely demoralized and ineffective.

### THE NAVY'S COASTAL RADIO DIRECTION FINDER SYSTEM

The serious allied shipping losses experienced early in the war led to action to reduce vulnerability to the German submarine menace by expediting the entry of ships into United States ports, particularly during bad weather. To provide navigational guidance to the ships, the Navy installed a number of temporary direction-finder stations, located between Maine and Cape Hatteras. During 1918, the Navy began the installation of a chain of permanent direction-finder stations along the Atlantic coast, part of which became operational at the end of the war, giving assistance to Navy and troop ships returning from overseas. The direction finders were arranged in groups comprising a "master" and two "slave" stations. Bearings were plotted at the master to provide position fixes. These were transmitted to ships through the use of an associated radio transmitting station remotely controlled from the master station. A frequency of 375 kHz was assigned as a standard for direction-finder operation.<sup>4</sup> By 1923 a total of 46 direction finder stations were installed along the Atlantic, Gulf, and Pacific coasts, and were providing position

information to over 5000 ships a month. Operational ranges for bearings out to 100 miles were normally obtained. As new developments, such as effective radio-frequency amplification, became available the system's performance was upgraded to provide greater range and bearing accuracy capability. This Navy shore direction-finder system became "indispensable to the Navy and the shipping of the world" (1923).<sup>1</sup> The system continued to provide navigational information to shipping until early in World War II, when other navigational systems became available. Parts of the system had been used for the surveillance of the communication transmissions of potential enemies, and this function was continued.

### RADIO DIRECTION-FINDER DEVELOPMENT (SHORE)

NRL personnel, prior to moving to the Laboratory in 1923, had made contributions to the solution of the Navy's direction-finder problems with respect to wave propagation as related to bearing accuracy, loop antenna and receiver design, installation site-selection factors, and bearing deviation correction. This work was continued when activities were moved to NRL and dealt with shore, ship, and aircraft aspects. **With the aid of an experimental direction-finder facility installed near the Laboratory's site, NRL developed a direction finder far superior to any then existing - Model XM, 75 to 1000 kHz (1928). A bearing precision of 0.1 degree was obtained with this equipment, which featured automatic compensation of loop "antenna effect" with precisely opposite minima and unshiftable bearings. A number of these direction finders were produced and installed in the Navy's coastal direction-finder chain to upgrade its performance.** This was followed by the procurement of a series of direction finders for shore-station operation incorporating NRL's improvements, the most significant of which were the Models DK (1930), DM (1931), DP (1934-1942), DAF (1942), DAH (1942-1944), and DAP (1942). These equipments covered a

## RADIO NAVIGATION

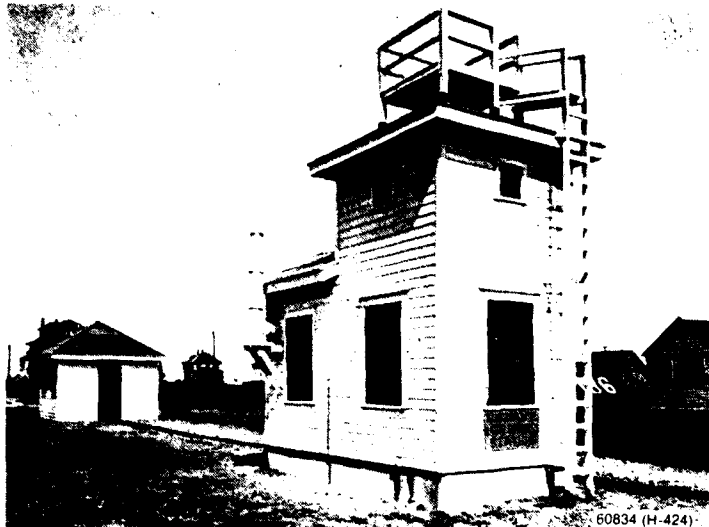

**RADIO DIRECTION FINDER STATION, CAPE MAY,  
NEW JERSEY, 1921**

This station was typical of the Navy's medium-frequency coastal radio direction-finder system, established between 1918 and 1923 with a total of 46 stations along the Atlantic, Gulf, and Pacific coasts. Later, the system was extended to include South America and portions of the Pacific Ocean. It became "indispensable to the Navy and world shipping" and continued in service during World War II for navigation and enemy emission intercept. The loop was mounted in the top of the structure. NRI made many contributions to increase the effectiveness of this system.

RADIO NAVIGATION

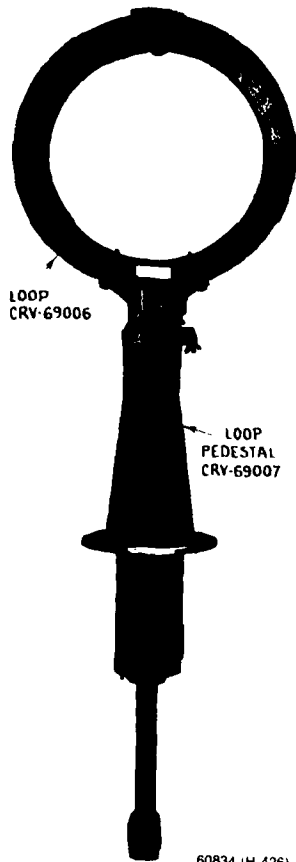

LOOP  
CRV-69006

LOOP  
PEDESTAL  
CRV-69007

60834 (H-426)

THE MODEL DP RADIO DIRECTION FINDER  
FOR BOTH SHIP AND SHORE INSTALLATIONS  
(100 TO 1500 kHz)

When used aboard ship, the rotating loop structure was mounted on the keel line and removed as far as possible from conducting objects to minimize bearing deviations. NRL played an important role (1934) in the development of this and many other direction finders. Loop direction finders in this frequency band were used for many years.

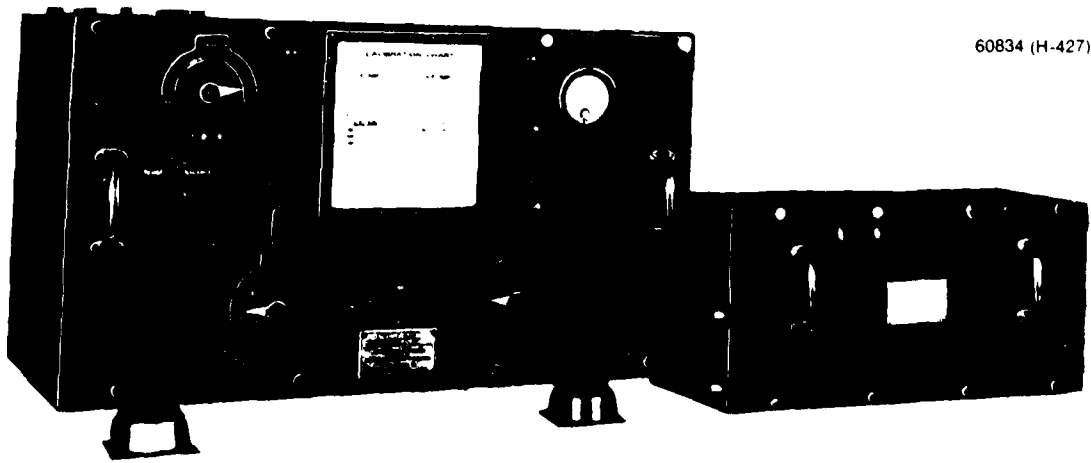

60834 (H-427)

RECEIVER UNIT, CRV-46038, 46039

POWER UNIT, CRV-20026

nominal range of 100 to 1500 kHz and incorporated new techniques as these became available. These equipments were obtained in considerable quantities and installed in the coastal chain, which was extended to include South America and portions of the Pacific ocean. In their procurement, except for the Model DK, NRL provided technical information resulting from its research work for specifications and surveillance of the manufacturers to insure satisfactory service operation.<sup>9</sup>

#### RADIO DIRECTION-FINDER DEVELOPMENT (SHIP)

The Model DA direction finder was followed by the Model DB (45 to 600 kHz), intended for extensive installation on battleships and cruisers (1922). In 1926, the Navy became concerned about the poor performance of the Model DB on its battleships, particularly with respect to bearings taken on spotting-aircraft transmissions intended to be used to place salvos on the battle line of enemy ships. A board was appointed under the Commander Battleship Divisions, Battle Fleet, to consider the problem. NRL provided technical support for this board. The ensuing investigations of Model DB installations on the USS PENNSYLVANIA and the USS MARYLAND disclosed that deviations as large as 20 degrees existed, even though the loops had been installed in favorable positions in the foretop or mainmast. However, this position did provide freedom from variation in bearing deviation due to movement of guns and other structural elements on deck. **NRL determined that the deviation experienced in shipboard direction-finder installations could be greatly reduced by providing a closed loop about the direction finder through connecting the after stack and the mainmast with a cable and arranging the large antennas to be open-circuited while taking bearings. This technique later was generally applied. The improvement in bearing accuracy obtained was considered adequate to place a line of fire on some part of an enemy column.<sup>10</sup> All the Navy's battleships were provided with direction finders.**

The Navy's direction finders, until 1928, had been constructed in-house, the loop by its Philadelphia Navy Yard and the receiver by its Washington Navy Yard. At that time, the Navy began procurement of its direction finders from commercial organizations, obtaining a large quantity of the Model DK and DL equipments for both ship and shore installations. Numerous complaints of their unworkability led to their recall from service. NRL had not been brought into the matter of procurement of these direction finders, but when requested verified their poor performance, which was found to be due to improper design. In the meantime, **NRL had developed a direction finder which was the first equipment to provide unilateral and bilateral characteristics with a high degree of sensitivity and stability (1930). Accordingly, NRL redesigned the Models DK and DL equipments, and, following NRL's design, the Washington Navy Yard modified all that had been purchased. When reinstalled, these modified equipments proved "superior to any direction finder apparatus now in service" (1933).<sup>11</sup> Considerable financial savings resulted from this modification.** This was of importance at that time, during the depression of the 1930's, since funds were then difficult to obtain. These direction finders continued in service during World War II. After the Model DK and DL, the Navy procured a series of direction finders from commercial concerns, with NRL providing the necessary technical support and surveillance.<sup>9,12</sup> The most significant of these were the Models DM (1931), DN (1942), DAE (1942-1943), DAK (1942-1944), and DAP (1942), nominally covering the range from 100 to 1500 kHz. These equipments were installed on all classes of Navy vessels, including submarines. They were gradually removed from service after World War II and were replaced by other navigational systems.

#### AIRCRAFT DIRECTION FINDERS

During World War I, the need for large-scale sea surveillance to locate enemy submarines



## RADIO NAVIGATION

brought about the development of the large Navy "Flying Boat" (types H-16, F-5-L) and a requirement for navigation by radio for use on long-distance patrols. Rotating-loop type direction finders were developed and installed in the tail structures, which were large enough to accommodate loops of considerable size.<sup>13</sup> While the fabric covering of the tail structures permitted the direction finders to function, their accuracy and operational range were limited by the severe interference due to the high-level emissions from ignition systems, difficulty in making oral signal observations through the intense acoustic noise, and large bearing deviations caused by the proximity of tail-bracing wires about the loops. Direction finders in aircraft were of little use until after the war, when these difficulties were overcome. Staff members of NRL, prior to their assembly at the Laboratory, had been engaged in the development and improvement of these direction-finder systems, an effort which was continued at NRL. Through experiment it was established that while such steps as the isolation of the radio receiver from the ignition system with respect to the power supply provided considerable reduction in interference, only complete shielding of the aircraft ignition system would eliminate the interference.<sup>14</sup> Adequate shielding permitted the use of newly available radio-frequency amplification to raise the signal level. The introduction of closed loops about the direction-finder loop provided compensation for bearing deviation. Through the use of the "maximum" instead of the "minimum" method of bearing determination, full advantage could be taken of the signal strength. These measures, in combination, first made the use of direction finders in aircraft operationally practical. The results were applied, as far as was possible, to the NC-4 Flying Boat, the first aircraft to make a trans-Atlantic flight (1919).<sup>13,14,15</sup> During the flight, to lighten the craft the separate battery supplying the radio receivers was discarded, and the receivers were supplied from the ignition battery. This arrangement greatly increased ignition noise, reducing the range of the direction finder. Enroute from the Azores to Portugal the NC-4's magnetic compass failed, and the plane went badly off

course. Fortunately, one of the destroyers supporting the flight was close enough (50 miles) so that by boosting its transmitter power to the limit, direction-finder bearings were taken, and the plane was brought back on course. Otherwise, the historic flight might not have been completed. **The effectiveness of the direction-finder improvements was demonstrated subsequently by pre-NRL staff members relative to the feasibility of the homing of aircraft on aircraft carriers, which were soon to become available.** A type F-5-L seaplane, properly equipped, was flown in a direct course from Norfolk, Virginia to the battleship USS OHIO, 100 miles at sea. On its return trip to Washington, D.C., bearings were taken by the seaplane on the USS OHIO transmissions (507 meters or 592 kHz), at a distance of 190 miles (1920).<sup>15,16</sup> When the metal-hull seaplane came into use in 1925 (type PN-9), the direction-finder loop was relocated on the top of the hull.<sup>17</sup> The loop was rearranged inside a doughnut-shaped shielded housing, which provided acceptable aerodynamic performance for planes of that day. This arrangement also disposed of the "antenna effect," greatly simplifying operation. Various types of direction finders were investigated, to determine the features most suitable for aircraft use. NRL in cooperation with several manufacturers developed a series of aircraft direction finders with these features including the Models DU, DV, and DW (1938), covering the frequency band 200 to 1500 kHz.<sup>18</sup> A Model DZ (experimental designation CXS), covering an additional range of 15 to 70 kHz, for obtaining bearings over long distances, was also developed (1939).<sup>19</sup> The difficulty with "night effect" at these low frequencies was avoided by selecting transmissions from stations at proper distances for taking bearings.<sup>20</sup> A feature of this series was the use of very-low-impedance loops, which avoided the loss incurred in the condensation of water vapor on the earlier high-impedance loops. These direction finders were installed in type PBY and PDM patrol seaplanes and were used extensively during World War II, until other systems of navigation became available.

## RADIO NAVIGATION

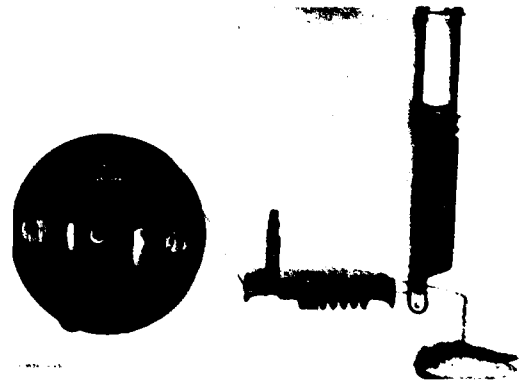
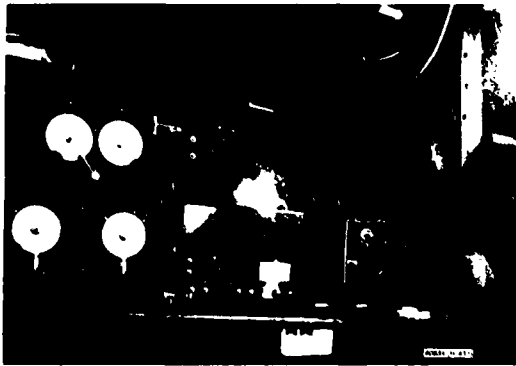
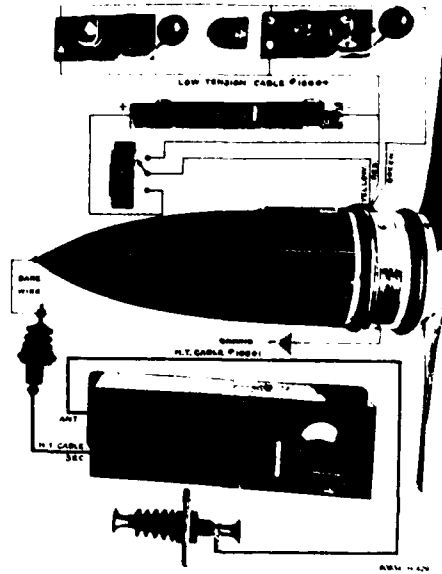

**THE NAVY'S NC-4 SEAPLANE, FIRST AIRCRAFT TO FLY ACROSS THE ATLANTIC OCEAN (1919)**

Scientists who later became part of the original NRI staff were responsible for the radio installation aboard this aircraft. The NC-4's magnetic compass failed during the flight. Had it not been for radio direction finder bearings taken on transmissions from a supporting destroyer, the flight would not have been successful. The NC-4 is shown in the upper left photo in the harbor at Lisbon, Portugal. The aircraft's radio communication installation included the Model SF 1310, 500 watt spark transmitter (upper right), a receiver - communication and direction finder installation (lower left), and an antenna system (lower right). The direction finder loop antenna was of the type shown on page 270.

## RADIO NAVIGATION

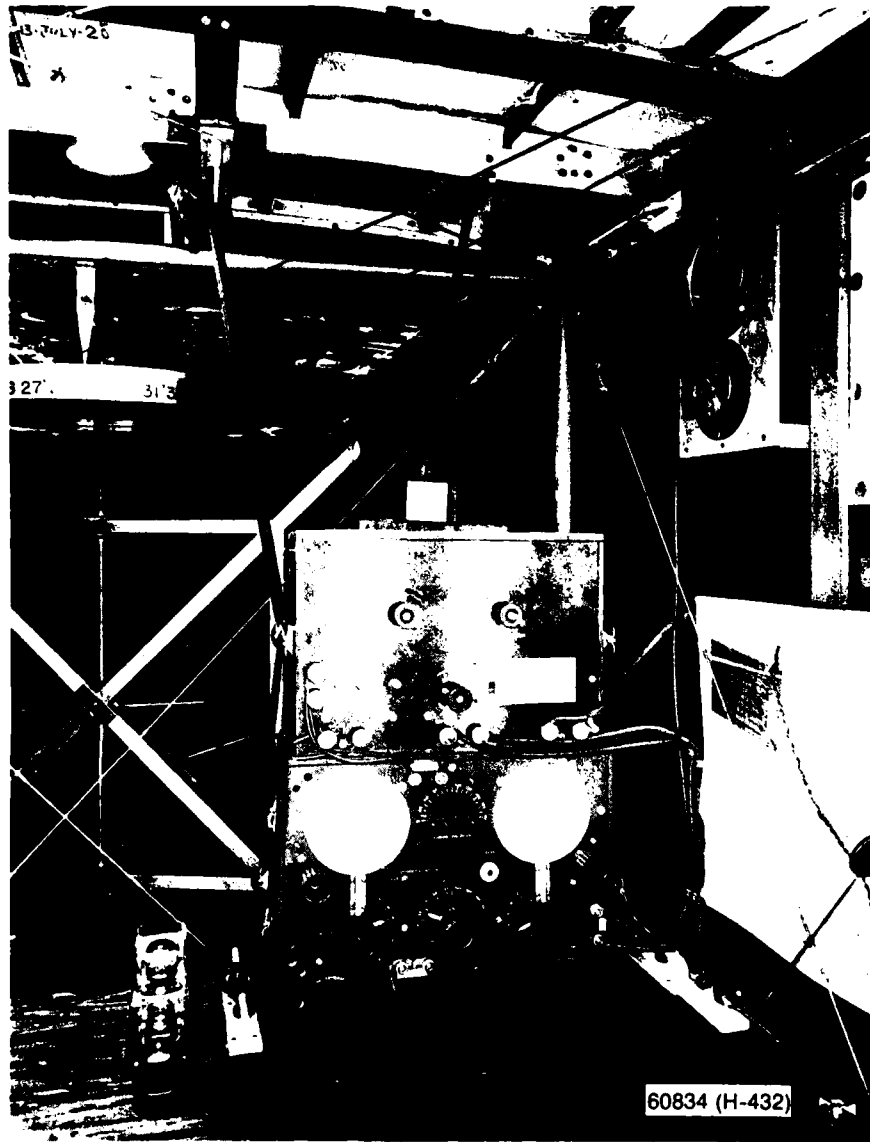

### FIRST DEMONSTRATION OF THE FEASIBILITY OF LONG-RANGE RADIO HOMING OF AIRCRAFT ON AIRCRAFT CARRIERS (1920)

A scientist who later became a member of NRI's staff directed an adequately equipped F-5-L seaplane 100 miles directly to the battleship USS OHIO, at sea in a location unknown to the aircraft's crew members. Bearings were taken on the return trip at a distance of 190 miles. The aircraft equipment comprised the receiver, with radio audio amplification (foreground), and the rotating loop (background). A major element in the success achieved was due to the complete shielding of the plane's engine ignition system. This flight was therefore the first demonstration of accomplishment in both direction-finder performance and interference reduction.

## RADIO NAVIGATION

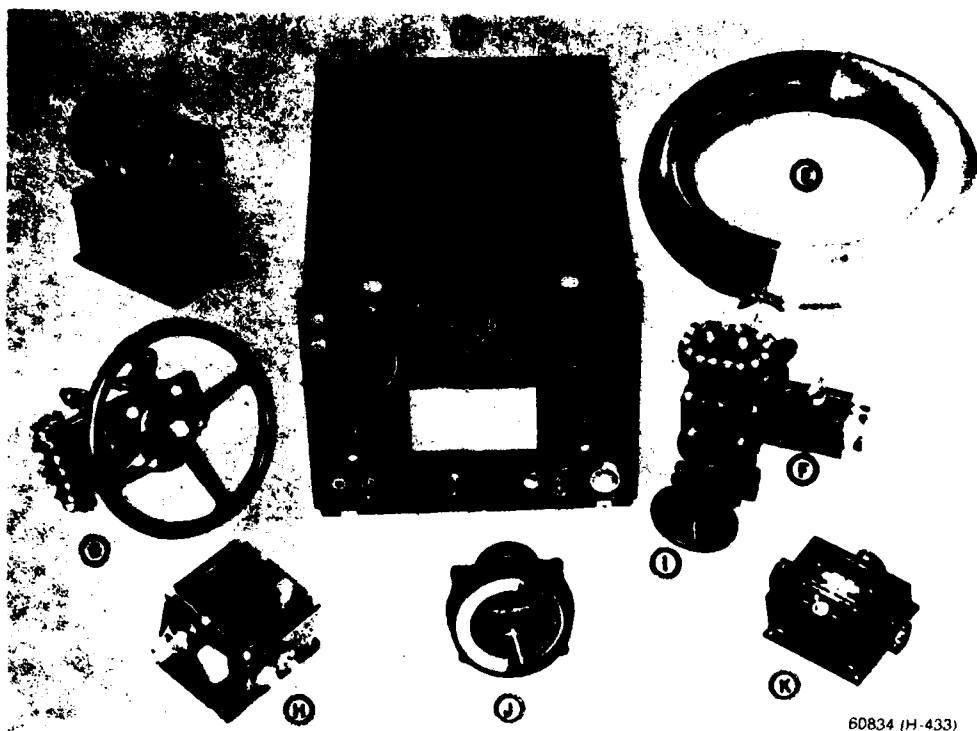

60834 (H-433)

FIRST AIRBORNE RADIO DIRECTION FINDER FOR LONG-RANGE BEARINGS  
ON VLF—THE MODEL DZ (1939)

NRL discovered that the large bearing errors due to the "night effect" at VLF could be avoided by selecting the transmissions from stations at proper distances. This discovery resulted in the development of the Model DZ direction finder (15 to 1500 kHz). This direction finder was installed in type PBV and PDM patrol seaplanes, and it was used extensively during World War II in long-range patrols. The loop antenna is shown at E, and the receiver is at A.

The development of direction finders operating at the higher frequencies is treated in Chapter 8, titled "Electronic Countermeasures." When direction finders at these frequencies became effective, the pulse techniques resulting from radar were applied to navigational systems such as Loran, with better navigational accuracy. Thus, the high-frequency direction finder became principally an instrument for determining the position of the source of enemy radio emissions.

### AIRCRAFT HOMING SYSTEM

When aircraft carriers first became available, the USS LANGLEY (CV-1) in 1922, the USS

LEXINGTON (CV-2) and USS SARATOGA (CV-3) in 1928, there was need for a suitable means of navigating carrier-based planes to and from carriers and air facilities ashore.<sup>21</sup> Single-seat fighter aircraft were equipped with direction finders with fixed loops mounted in pilot head-rests or wound around fuselages. This arrangement required objectionable swinging of the planes to obtain bearings. Larger carrier-based planes were equipped with externally mounted rotatable loops, remotely operable by specialists accompanying the pilot. As the performance of aircraft increased, these loops, in the air stream, adversely affected speed and maneuverability. Other means had to be devised. In dealing with

## RADIO NAVIGATION

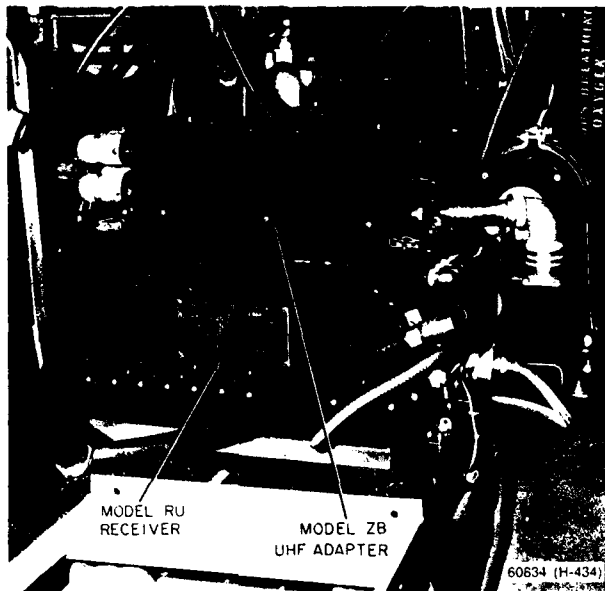

### THE PRIMARY AIRCRAFT-TO-CARRIER RADIO HOMING SYSTEM USED BY ALL CARRIERS AND THEIR AIRCRAFT DURING WORLD WAR II THE MODELS YE-ZB

The experimental model shown here, developed by NRL (1937), comprised the shipboard equipment, the Model YE (lower) and the airborne equipment (upper). For installation aboard ship, the antenna was mounted as high in the superstructure as possible, and the transmitter was placed below decks. The airborne equipment, shown mounted in a type TBF-1 aircraft, comprised the Model ZB UHF adapter and the Model RU high-frequency receiver, which was also used for communication.

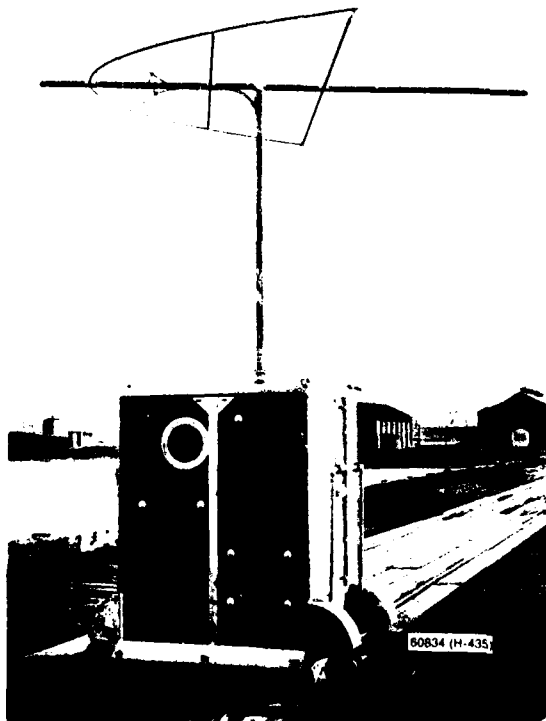

## RADIO NAVIGATION

this problem, NRL developed an aircraft radio homing system which was installed on all the Navy's aircraft carriers and their aircraft, and which provided the primary means for aircraft to navigate back to their carriers during World War II (Models YE-YG/ZB) (1937).<sup>15c,22</sup> NRL's experimental model was installed on the carrier USS SARATOGA, flagship of the Commander Aircraft Battle Force, then ADM E.J. King (May 1938). After witnessing its performance, ADM King, in a letter to the Navy Department dated 29 Aug.

1938, stated "The acceptability of the principle of a rotating superfrequency beacon for homing to aircraft carriers at sea or landing fields ashore has been fully demonstrated." He made the recommendation, "Adopt the (Model YE) system for primary means of homing carrier aircraft."<sup>23</sup> As a result the system was installed on all aircraft carriers and extensively used during the war in the Pacific.<sup>24</sup>

The system had an operational range out to 275 miles, dependent upon the altitude of the

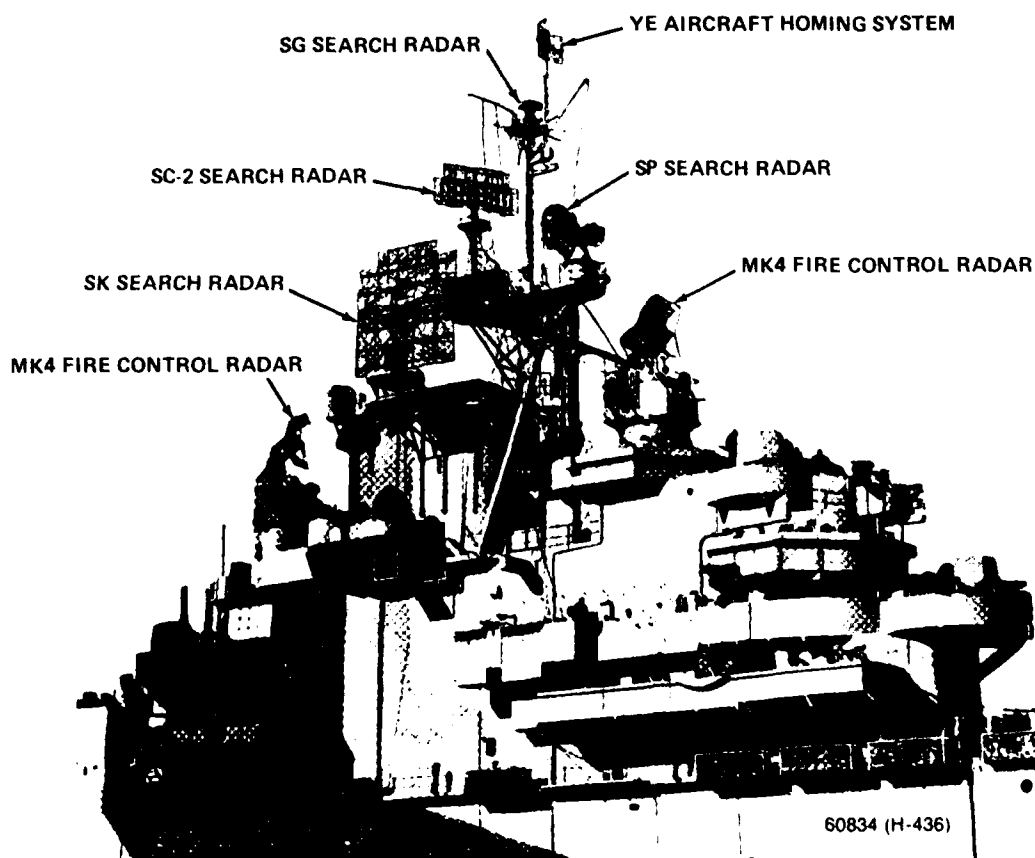

CARRIER INSTALLATION OF MODEL YE AIRCRAFT HOMING EQUIPMENT

Among the many electronic equipments installed aboard carriers, the Model YE aircraft homing equipment was given top priority, in view of its importance to the safety of carrier aircraft and crews. The installation shown was aboard the USS MAKASSA STRAIT, CVE 91.

aircraft. It was selected after consideration of alternates. However, its development was delayed, since transmitting vacuum tubes producing adequate power at a frequency high enough to provide equipment of a size acceptable for aircraft and shipboard installations did not become available until 1936.

The system included a rotating beam antenna, mounted on the carrier, which transmitted coded signals indentifying twelve equal sectors as the antenna rotated through 360 degrees (Models YF-YG). The signals (246 MHz, modulated by 540 to 830 kHz) were received on the aircraft on its standard Model RU communication receiver through the use of a frequency converter (Model ZB). The strongest signal indicated the particular sector occupied. Only a small, simple antenna was required on the aircraft. A compact, lightweight, combined homing and communication equipment resulted. The Model YG was a portable, lower powered version installed on some of the smaller carriers.<sup>25</sup>

The homing system had a dual frequency which confused the Japanese Admirals, who realized that our planes were successful in returning to their carriers but did not understand how this was accomplished. In one of the reported incidents occurring during one of the battles in the Marianas, where in the waning hours of daylight our planes followed up the stricken enemy nearly to the limit their fuel would permit, most of the planes and their pilots were saved by homing back to their carriers in the dark with this equipment.<sup>26</sup> The many glowing reports received from combat units and individual pilots whose lives were saved under trying circumstances attested to the importance and value of this NRL development. The British also eventually adopted this system for their carrier aircraft. The system continued in use until it was replaced by the Tacan system in 1960.

#### AMPHIBIOUS LANDING SYSTEM

Using certain components developed for the aircraft homing system, NRL devised an am-

phibious landing navigation system, Model YL-YN (1942).<sup>26</sup> During the war this system provided a means for guiding landing craft to particular points on beaches under conditions of darkness or general low visibility. The Model YL equipment, installed on a transport or other vessel from which landing operations were directed, laid down two narrow beams (0.6 degree) horizontally displaced by a small angle. The letters A (dot-dash) and N (dash-dot), interlaced, were transmitted (25 watts) by the respective beams. The landing craft, using the airborne homing receiving system, Model RU-ZB, could determine from the relative strength of the A and N signals whether it was to the right or left of the course. At "on course," the A and N signals merged to give a continuous signal. The Model YN equipment was a battery-operated transmitting buoy which was planted at the contemplated beach landing point, or at a suitable distance off shore. With the aid of the Model YN signal, received on the Model YL equipment, the shipboard operator could direct the Model YL beams accurately to the landing point. The Model YN was equipped with a timer set to begin transmission at the proper time. Since the carrier (246 MHz) of the Model YL equipment was modulated at frequencies in the range 540 to 830 kHz, up to 30 courses could be laid down in an area without mutual interference, to expedite landings. A number of Model YL-YN equipments were procured during World War II, the first was installed and satisfactorily demonstrated on the USS HARRY LEE (AP 17) (1942).

#### AIRCRAFT NAVIGATORS

(Altitude, Ground Speed, Drift)

The Navy, for many years, had used the barometric type of altimeter for determining the height of its aircraft above ground, although it lacked the accuracy necessary for certain air navigation functions, particularly in bombing. It also had no satisfactory means of determining ground speed and drift of aircraft due to wind, required for accurate dead reckoning. NRL, in 1932, was requested by the Navy Department to devise a satisfactory method of providing for

## RADIO NAVIGATION

### AMPHIBIOUS LANDING RADIO NAVIGATION SYSTEM (1942)

This NRI developed system provided a means for guiding landing craft to selected points on beaches under conditions of darkness or general low visibility. The Model YI shipboard equipment (upper right) transmitted an "on course" beam sensed by the landing craft receiver. The Model YN equipment (lower) was a beacon planted at the desired landing point, either on shore or just offshore. The YI shipboard receiver used the YN signal to direct its transmitted beam accurately to the desired landing point. Sequential operation allowed up to 50 independent courses to be laid down to expedite landings.

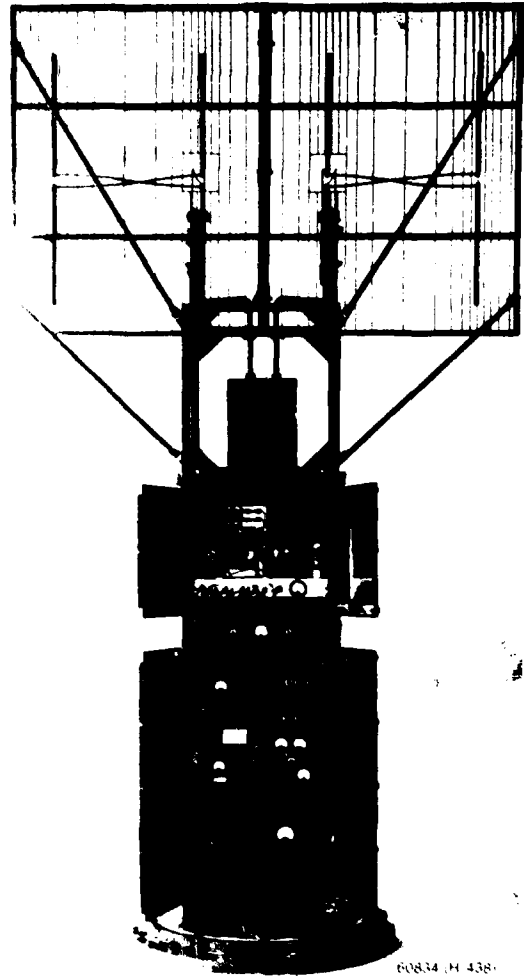

60834 (H 438)





these functions. NRL experimented with an acoustic beam method in which altitude was obtained by measuring the time interval between projection of acoustic pulses vertically downward and reception of the echoes returned from the ground surface. Ground speed and drift were determined by measuring the Doppler difference in frequency between the beamed energy projected downward at an angle of 30 degrees with the vertical and the received, reflected energy. When a system based on these principles was installed on the dirigible USS AKRON, it was found that air turbulence prevented reception of echoes when the speed exceeded 20 miles per hour (1933). This observation led to a decision to attain the objective with the use of radio waves at super-high frequencies, which at that time were being investigated for use in communication and object detection (radar), as previously described.<sup>27</sup> Experiments were conducted at 3000 MHz with parabolic-reflector antennas, but it was not until suitable electron tubes with adequate power output became available at lower frequencies and the radar pulsing techniques were devised that acceptable altitude measurements could be made.

As a phase of its early pulse-radar program, and in view of its importance to aircraft navigation, NRL developed an altimeter using radio pulses for accurate indication of the actual height of aircraft above the earth's surface (1939).<sup>15c,28</sup> This altimeter was put into production and installed in Naval aircraft. Since its operational frequency of 500 MHz was high enough to permit the use of relatively small antennas, NRL quickly modified the design of the altimeter to provide the first U.S. airborne radar, which has already been described. In NRL's altimeter, the transmitted echo returned from ground was displayed as a radially displaced "pip" of a circular sweep on a cathode ray tube, the same type of display used in the first radar. The angle between the pips corresponding to the transmitted and reflected pulses represented the altitude. This altimeter was the beginning of a series of aircraft pulse altimeters, thousands of which have been used by the Navy, Air Force, and Army, some models of re-

cent or origin are the AN/APN-141 (1960), the AN/APN-171 (1968), for rotary-wing aircraft, and the AN/APN-194 (1970) for fixed-wing aircraft.

#### AUTOMATIC AIRCRAFT NAVIGATOR

NRL's 1934 experiments on 3000 MHz demonstrated the feasibility of using the Doppler principle with a ground-projected radio beam to provide ground speed and drift for aircraft navigation. Nevertheless, many years elapsed before suitable components were devised, and before the bulk and weight of the equipment could be reduced to provide operation acceptable for Navy aircraft. Improved electron tubes operating at higher power and frequency, circuits of greater frequency stability, increased receiver sensitivity, better knowledge of sea returns, and new means of computation were needed to realize the objective. NRL's efforts continued through World War II, benefiting by the new techniques and components devised, particularly those for radar.<sup>29</sup> Considerable data on sea returns were acquired to make certain that satisfactory operation over the sea as well as land was feasible.<sup>30</sup> However, it was not until after the war that the objective was attained. At that time air navigators still had to depend upon a combination of star fixes, Loran fixes, visual fixes, indicated air speed, drift-sight information, and such knowledge of wind as might be available. Part of this information lacked accuracy or was unavailable, and part depended on visibility not always present. An important advance in air navigation was ushered in when NRL developed the first automatic aircraft navigator (1949).<sup>31</sup> This equipment was procured and installed in Navy aircraft and was designated the Model AN/APN-67.<sup>32</sup> It was the forerunner of a succession of automatic aircraft navigators employing the same basic principles and the unique techniques developed by NRL. The system utilized two radio beams directed downward from the aircraft, to its right and left, respectively. The signals returned by reflection from the sea or ground surface, when compared with the original signal,

## RADIO NAVIGATION

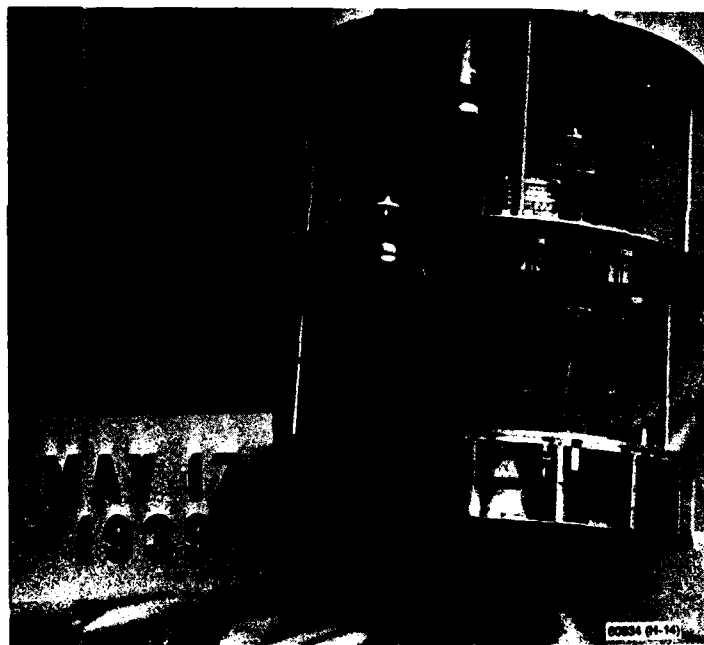

### THE NAVY'S FIRST RADIO PULSE ALTIMETER (1939)

This radio pulse altimeter was developed by NRL to replace the generally inaccurate barometric altimeter. The instrument was designed to give an accurate indication of the actual height of an aircraft above the terrain, rather than an approximation based on air pressure. It was put into production and was installed on Naval aircraft. The altimeter had ranges between 1000 and 20,000 feet, with a pulse length of 0.17 microsecond. Shown here are the cathode-ray-tube indicator, with circular range sweep (upper right photo), the transceiver (lower photo), and the antennas below the fuselage of the aircraft (upper left). Since its operating frequency of 500 MHz was high enough to permit the use of small antennas, NRL quickly modified the altimeter to provide the first U.S. airborne radar, the Model ASB (1941).

## RADIO NAVIGATION

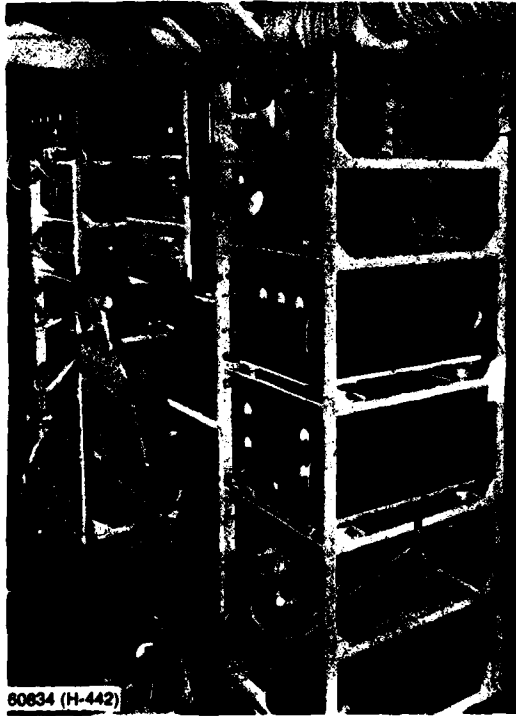
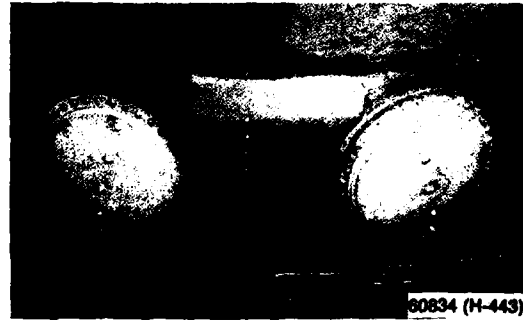
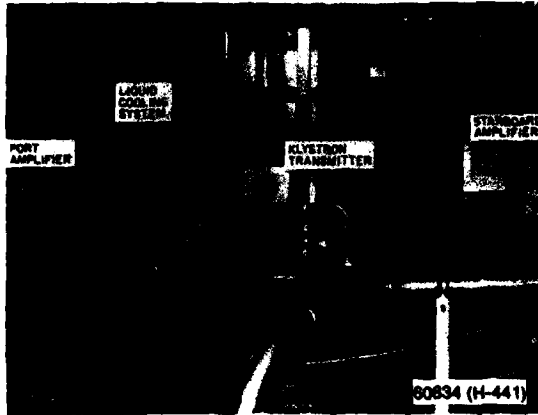

### THE FIRST AUTOMATIC RADIO DOPPLER AIRCRAFT NAVIGATOR (1949)

This NRL-developed automatic aircraft navigator was the first of a series of models. Many of the later models were in active service in all U.S. military services for both fixed-wing aircraft and helicopters. Commercial aircraft and British military aircraft use automatic navigators based on the original NRL concept. The transceiver of the equipment is shown at upper left, the antenna mounted below the fuselage is at upper right, and the operator's console is at lower left.

produce two doppler frequencies. The sum and difference of these yield the true ground-track velocity and drift angle. With the insertion of initial latitude and longitude, a computer makes the necessary computations to provide an accurate display of the current position of the aircraft at any moment. When the information is applied to

the aircraft's automatic pilot, it makes corrections for drift and enables the desired course automatically to be maintained with a high degree of precision. The series of aircraft navigators which followed the AN/APN-67 have benefited by the results of NRL's subsequent work.<sup>33</sup> This series includes the Models AN/APN-122, 2000

procured (1958); the AN/APN-153, 4500 procured (1963); the AN/APN-187, for ASW aircraft (1968); the AN/APN-190, for attack aircraft (1967); and the AN/APN-200 (1971). The last four were in active operation for many years by both the Navy and the Air Force. These models were obtained for fixed-wing aircraft. Others intended for helicopter installation have also been procured in large numbers. Commercial and British aircraft use similar automatic doppler navigators.

### CARRIER AIRCRAFT TRAFFIC AND LANDING CONTROL

Since the Navy's early experience with carrier aircraft operations on the USS LANGLEY in 1922, it became increasingly evident that many difficult traffic and landing-control problems, involved in dealing with large numbers of aircraft in the highly restricted carrier air spaces, had to be solved before an operationally satisfactory all-weather navigational system could be achieved. Of particular concern were the difficulties in operating under conditions of poor visibility due to fog, rain, and darkness. These difficulties were vividly highlighted in carrier aircraft strikes in the Pacific during World War II. Although radar and other navigational aides had then become available, they were not adequate at the short approach ranges to prevent aircraft returning to their carriers from being lost when visibility was low. Furthermore, injuries occurred to planes and pilots in contacting carrier decks during landings, since the judgement of the pilot and available aids were not always adequate to contend with the combination of proper glide path, high landing velocity, and the rolling and pitching of flight decks, particularly in bad weather. To improve this situation, NRL developed a radar carrier-controlled approach system, through which the first landings of aircraft on a carrier in complete darkness were accomplished. The practicality of the NRL system was first demonstrated on the carrier USS SOLOMONS, CVE-67 (1945).<sup>34</sup> As a result, the Bureau of Ships installed the system on the carriers USS VALLEY FORGE (CV-45) (1947) and the

USS PHILIPPINE SEA (CV-47) (1948).<sup>35</sup> The special components for these installations were furnished by NRL. The Bureau also initiated contracts for additional installations, including one of the USS ORISKANY (CV-34). In the demonstrations on the USS SOLOMONS, the NRL system was used to control aircraft on 141 approaches. Fifty-seven of these were made with the pilot in a hooded cockpit, 19 were made at night, and 15 were made with the carrier and escorts totally darkened until the aircraft was less than 200 yards astern of the carrier, in landing position. In a final demonstration, under conditions previously considered impossible, on a night when no horizon was visible, in rain, with seas roughened by 43 knots of wind and all ships completely blacked out, an F6F plane was landed on the carrier, repeatedly and successfully. The unique features of the radar system (X band) included an antenna mounted on the after edge and slightly below the top of the flight deck. This antenna provided a beam, broad in elevation but sharp in azimuth, which horizontally scanned the area astern the carrier. Another feature of the system was an indicator which clearly displayed echoes from the approaching plane as it entered the glide path. This indicator gave the Landing Signal Officer (LSO) the position data required to keep the aircraft accurately approaching the carrier, and the timing data needed to determine when the aircraft would pass over the end of the flight deck; at that moment, the LSO's "cut" signal would drop the aircraft precisely onto the carrier's arresting gear. The plane was first picked up by search radar and identified by CIC, and the pilot was guided by voice communication into the sector scanned by the new radar system.

To further advance the Navy's carrier-aircraft traffic and landing capability, NRL carried out a study of operational requirements and the relative potentialities of homing, radar, communication links, radio direction finders, and dead reckoning to satisfy these requirements (1947).<sup>36</sup> Following the study, NRL developed the Data Relay Navigation (DARN) system, which was first automatically to control the flight of an

aircraft over the traffic path about a carrier and entry into and flight down the landing glide path (1950).<sup>38</sup> NRL's DARN system was also first to employ a digital data link between carrier and aircraft for the transmission of data to control such flight of an aircraft and monitoring of it by the pilot. The system included a precision radar to locate the aircraft and to determine its altitude and position relative to the carrier deck during the approach phase, and a tracking radar to provide the glide-path data in landing. An electronic computer aboard the carrier calculated the course direction information, which was transmitted via digital data link to the aircraft. In the aircraft, another computer processed the received data, together with locally derived altitude, and put it into proper form to permit automatic control of flight through the autopilot. A visual display of the data provided the pilot with monitoring and override capability. NRL assembled an experimental system at its Chesapeake Bay site under conditions simulating those of the carrier environment and conducted a series of flight tests to determine the accuracy that can be obtained in automatically controlling an aircraft to follow a specific flight path (1950).<sup>39</sup> These flights proved that automatic control of carrier aircraft, particularly during the critical flight phase of entry into and down the glide path, was fully practical.

During the final phase of carrier-aircraft landing, considerable difficulty had been experienced by pilots in properly judging the attitude of the carrier deck and making compensatory flight adjustments, to avoid serious injury to pilot and aircraft at the instant of contact. To permit design of the automatic control feature for this phase of flight, NRL developed instrumentation and conducted measurements on several ships which made available the first precise data on the characteristics of carrier-deck motions. Analysis of the data obtained permitted circuitry to be devised which provided prediction of deck motion to effect, through compensation, the smooth landing of aircraft automatically.<sup>39</sup> The results of this and NRL's earlier work were incorporated into carrier landing equipment procured jointly by the Bu-

reau of Ships and the Bureau of Aeronautics from a contractor under NRL's guidance (Model AN/SPN-10, which later became Model AN/SPM-42). With this allweather carrier landing system (AWCLS), patterned after NRL's system, the first fully automatic landing of an aircraft on a carrier to "touch down" was made by an F3D jet on the USS ANTIETAM at sea off the coast of Pensacola, Florida on 20 Aug. 1957.<sup>40</sup> Nearly 100 fully automatic landings were made during that week. In subsequent installations the AWCLS has been proven operationally practical and safe by a variety of aircraft, from fighters to bombers, that have performed over 10,000 fully automatic landings on carriers and at airports. The AWCLS (Model AN/SPN-42) was first installed for operational evaluation on the USS FORRESTAL in 1967. The first "production" equipment was installed on the USS KENNEDY in 1969. The system was installed on several large carriers. About 1500 Navy aircraft have been equipped with the airborne components of the system.

#### PULSE NAVIGATIONAL SYSTEMS

Experience during the trials of the first "operational" radar (Model XAF) on the USS NEW YORK in 1939 indicated that radar would be of great value for navigational purposes. In its early use in the Fleet, this observation was confirmed, and navigation became one of the important functions of radar, as has been previously indicated. The availability of the radar pulse technique encouraged the conception of other pulse navigation systems, one of particular importance being Loran (Long Range Navigation), proposed by the Radiation Laboratory of the National Defense Research Committee (1940).<sup>41</sup> This system permits ships and aircraft to determine their positions through time differences between pulses received from several shore transmitting stations. Two forms of this system are in general use today, Loran A ( $1.85 \pm 0.1$  MHz) and Loran C (100 kHz). Loran A

## RADIO NAVIGATION



A jet aircraft approaches the deck of the USS ANTIETAM and is located by radar.



Its altitude and position in relation to the carrier deck are determined, and course corrections are made to put it in the proper position for landing.



The information is transmitted to a device in the plane which automatically makes the required adjustments in course.

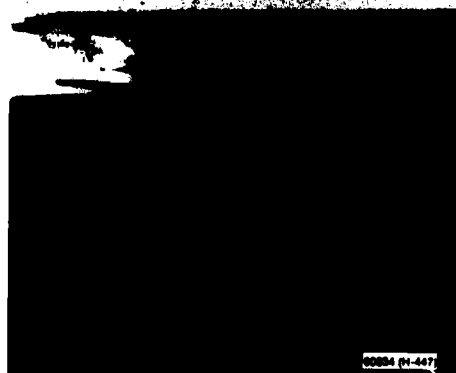

The plane touches down and the landing is successfully completed.

### ALL-WEATHER AUTOMATIC CARRIER AIRCRAFT LANDING SYSTEM

The first completely automatic carrier landing of an aircraft to touchdown (Model F3D jet) was made aboard a carrier (USS ANTIETAM) using an all-weather system (Model AN SPN-10) based on NRL's developments (1957).

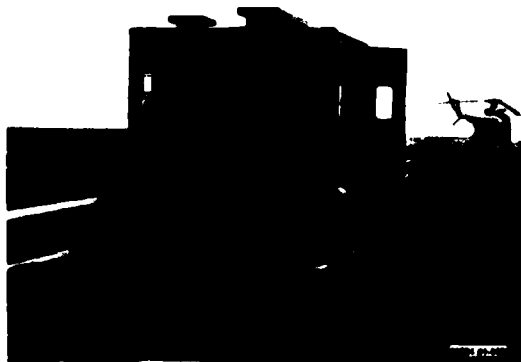

The Model AN SPN-10 shipboard equipment.

## RADIO NAVIGATION

provides coverage out to 1000 miles in daytime and 1200 miles at night. The relatively simple reception equipment required by the system is conducive to widespread use. Loran C gives somewhat greater coverage and greater accuracy, due to cycle matching, but the system is more complex. The Navy sponsored the procurement of equipment to establish a chain of Loran A transmitting stations (Model TDP transmitter) to provide coverage of the North Atlantic, the Aleutians, and central and southwest Pacific areas, (1943-1945). The U.S. Coast Guard, then part of the Navy, was given responsibility for the operation of these stations (1943). The Navy also procured receivers for installation in its ships and

aircraft (ship models DAS series, AN/SPN-40; airborne models AN/APN series). NRL provided technical support for the Navy in the procurement and improvement of these transmitting and receiving Loran navigation equipments to insure satisfactory service operation.<sup>42</sup> The Laboratory installed a Loran station at its Chesapeake Bay site to conduct investigations. These were concerned with such aspects as system performance, pulse shaping to minimize sideband emissions and maximize signal-to-noise ratio, pulse timing control oscillator stability to provide greatest precision of station synchronization and position accuracy (Models C-1, UE timers), equalization of station pulse responses in

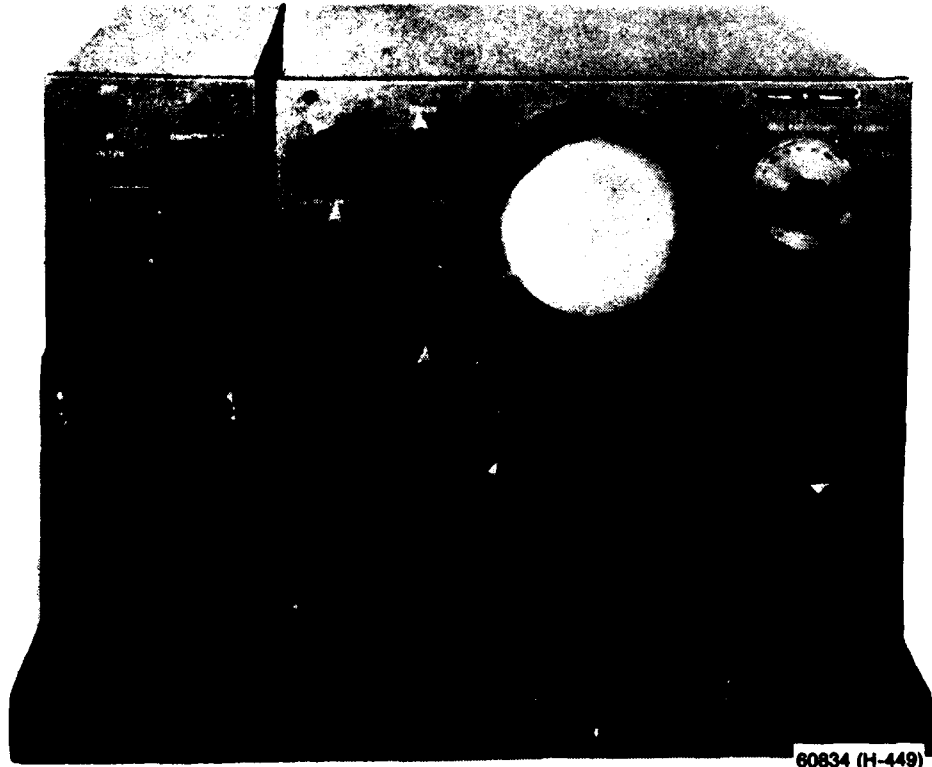

## LORAN NAVIGATION

NRL made technical contributions to the Navy's procurement and improvement of Loran navigation transmitters and receivers to insure their satisfactory operation and widespread use (1943-1945). The Model DAS receiver-indicator is shown here.

reception to prevent receiver blocking, and cycle matching to secure higher precision in position determination.

When the special navigational requirement for submerged reception aboard Polaris submarines arose, the Navy sponsored the establishment of the Loran C system (1957-1967).<sup>43</sup> The submerged-reception capability of this system is due to its frequency (100 kHz), which is low enough to permit the transmitted emissions to penetrate the surface of the sea. Transmitting stations were established, covering generally the same areas as those covered by the Loran A system, with the additional coverage of the Mediterranean Sea. These stations are also operated by the U.S. Coast Guard. When the Navy procured receivers for its ships, NRL provided the necessary technical information for the specifications (Models AN/WPN-4-5, AN/SPN-40). NRL conducted investigations to determine the pulse requirements of the system and its operational performance with respect to reception in submerged submarines.<sup>44</sup> The Laboratory also devised means of substantially increasing the accuracy of position determination under adverse signal-to-noise-ratio conditions.<sup>45</sup> Originally all the Navy's Polaris submarines were equipped with Loran C reception capability.

#### OMEGA - VLF WORLDWIDE, ALL-WEATHER, RADIO NAVIGATION SYSTEM

A Naval Navigation Facilities Advisory Committee was established in 1947 in the Office of the Chief of Naval Operations, with representation from the several Naval organizations concerned, including NRL, to determine the future Naval requirements for all types of electronic aids to navigation. Among the various aids considered, the committee formulated the "military characteristics for a long-range navigation system."<sup>46</sup> In 1948, a Long Range Navigation Aids Analysis Group was established as a subsidiary of this committee, under the auspices of the Office of Naval

Research, with membership from cognizant organizations, including a representative from NRL. This group studied all existing and proposed long-range navigation systems. In its report it gave recognition and support to NRL's work, then being directed to a navigational system using the lower radio frequencies, which gave promise of providing coverage over long distances and reception by submarines when submerged.<sup>47</sup> This system (Radux, proposed by J.A. Pierce of Harvard University under sponsorship of the Office of Naval Research) employed several remotely located stations, sharing time in sequential transmissions on a common carrier frequency. Position at the receiver location was obtained through measuring the phase differences between the synchronized audio-frequency modulation on the low-frequency carriers of the respective stations. Latitude and longitude were obtained by reference to a chart displaying the resulting family of hyperbolic lines of position. In 1947, the Bureau of Ships had sponsored NRL's study of phase stability in the propagation of the lower frequencies and the development of reception techniques for long-range navigation, which in 1948 were directed to the proposed system. In 1950 this Bureau also sponsored the Naval Electronics Laboratory (NEL), San Diego, California, in its establishment of experimental transmitting stations located at Chollas Heights, California; Bainbridge Island, Washington; and Haiku, Oahu, Hawaii. NRL developed the reception equipment, including the first electronic timer and synchronizer to segregate the transmissions of the several stations for their phase comparison at the receiver. The transmissions were of different length to permit this isolation. NRL also developed the first precise means of determining the lines of position from the phase differences between these transmissions.<sup>48</sup> The phase of the modulation of each incoming signal was successively compared with that of a stable local oscillator, and the phase differences were stored. The lines of position were obtained from the phase differences of the stored values. In carrying out a program cooperative with NEL, NRL provided six reception equipments, and these, with others



obtained from contractors, were used in determining the performance of the system through observations at various points on the east and west coasts of the United States and in Oahu, Hawaii. The relative efficacy of several carrier frequencies was determined in the range 24 to 104 kHz, as well as several modulation frequencies (principally 200 Hz) with respect to phase stability, amplitude variations in propagation, and influence on position accuracy and system reliability. NRL also made atmospheric-noise measurements to ascertain the signal level required for acceptable indication of position. It also established that the use of a loop antenna in various orientations for reception aboard submerged submarines caused no adverse effect on position accuracy.<sup>49</sup> The results of the work on this modulated-carrier system during the period 1950 to 1956 indicated that it was capable of providing navigational fixes with average errors of less than five miles at distances out to 3000 miles.

In carrying out the cooperative propagation effort, it was observed that the VLF carrier possessed high phase stability, and that if VLF carrier phase differences were used instead of those of the modulation frequency, position accuracy of one mile could be achieved. However, the use of the VLF carrier instead of the modulation frequency (200 Hz) for position indication reduced the navigational lane width from 404 to eight nautical miles and introduced a lane-identification problem. The use of the lowest possible carrier frequency would provide the widest lane and most favorable propagation characteristics, but would also increase the difficulty of radiating adequate power from antennas of acceptable size. As a compromise, a carrier frequency of 10.2 kHz was assigned as the primary frequency. With eight strategically located transmitting stations radiating a power of 10 kW at this frequency, navigational coverage of the entire earth would be obtained. These considerations became the basis for the Omega worldwide, all-weather, radio-navigation system (1956).<sup>50</sup> For experimental investigations of the Omega system, available large VLF antennas were used, and transmitters (10.2 kHz) were installed at Haiku, Oahu, Hawaii;

Forestport, New York; Summit, Panama Canal Zone; and with the cooperation of the British, at Criggion, Wales (1958-1960). In 1966 the Wales transmitter was transferred to Aldra, Norway, and the Summit transmitter was taken to the island of Trinidad. Based on NRL's earlier developments, receiving equipment was obtained for observing the performance of the system at both shore points and aboard ship. The first Omega receivers utilized the signal switching-synchronizing and line-of-position determining techniques incorporated in the earlier navigation receivers developed by NRL, as adapted for use with VLF carrier phase differences (AN/URN-18 and AN/WRN-2) (1959).<sup>51</sup> The lane counters were automatically actuated. A number of these receivers were produced and installed on ships and ashore, NRL providing the necessary technical information for specification and guidance of contractors and maintaining surveillance of the resulting product (1958-1960). These receivers were followed by the Models AN/BRN-4 and AN/SRN-12, which were produced in considerable numbers, incorporating modifications found desirable for operational use. NRL acted in a similar role in their procurement (1968).

In continuing its navigational-system investigations relative to Omega under Bureau of Ships sponsorship,\* NRL made widespread propagation observations on transmissions from the several stations that had been established.<sup>52</sup> These were made to determine the diurnal and seasonal variations in phase stability and field strength of the VLF carriers at points in the Arctic, temperate, and tropical regions. During the period from 1956 to 1972, longer term observations were made at the Laboratory's local site (continuously), at Iceland (1966 for one year), and Bermuda (1966 for one year). With NRL-installed propagation-measurement equipment, data were obtained through the cooperation of Norway at Bodø (1962 for 1-1/2 years), of England at Lasham (1963 for 2 years), and of France at Toulon (1966 for 1-1/2 years).

\*The Naval Electronics Systems Command after reorganization of the Navy Department on 1 May 1966.

## RADIO NAVIGATION

### EXPERIMENTAL OMEGA NAVIGATION RECEIVER

This receiver, developed by NRL in 1959, provided the critical circuitry for the first commercially produced Omega receivers. It was made without regard for size, since it was desirable that circuit changes could be made readily in the experimental stage of system development. An electronic synchronizer and mechanical servo system were incorporated.



## RADIO NAVIGATION

The Laboratory equipped a van to serve as a mobile propagation monitor and with it collected propagation data at points en route west to Nevada (1961), north to New York State (1961), and south to Florida (1964). The Laboratory fitted its aircraft (EC-121K) with propagation-measurement equipment and made short-term observations at ground sites in Greenland, Iceland, Norway, Peru, Chile, Argentina, Brazil, and Puerto Rico in 1961; Hawaii, Tahiti, Fiji, New Zealand, Australia, Singapore, Hong Kong, Japan, Wake, and Alaska in 1963; and the Azores in 1967 and 1968. At these sites the accuracy of geographic position was determined by reference to survey markers or the best geographic information available. The analysis of the data collected was directed to the impact on VLF carrier stability caused by changes in the propagation path between the

transmitter and receiver when illuminated by solar radiation, an aspect of prime importance to the system. Considerable phase shift was found to occur due to variations in length of the propagation path resulting from changes in ionospheric reflecting-layer height, corresponding to changes in ionization. However, the analysis also revealed that the changes were so uniform, diurnally and seasonally, as to permit prediction and the application of compensation which provides geographic position accuracy of one mile in daytime and two miles at night. With respect to transmitter-power requirements, analysis of the data indicated that when allowance was made for the differences in actual power radiated by the experimental transmitters (100 watts by Forestport to 3 kW by Haiku), the 10-kW radiated power level previously estimated would provide satisfactory

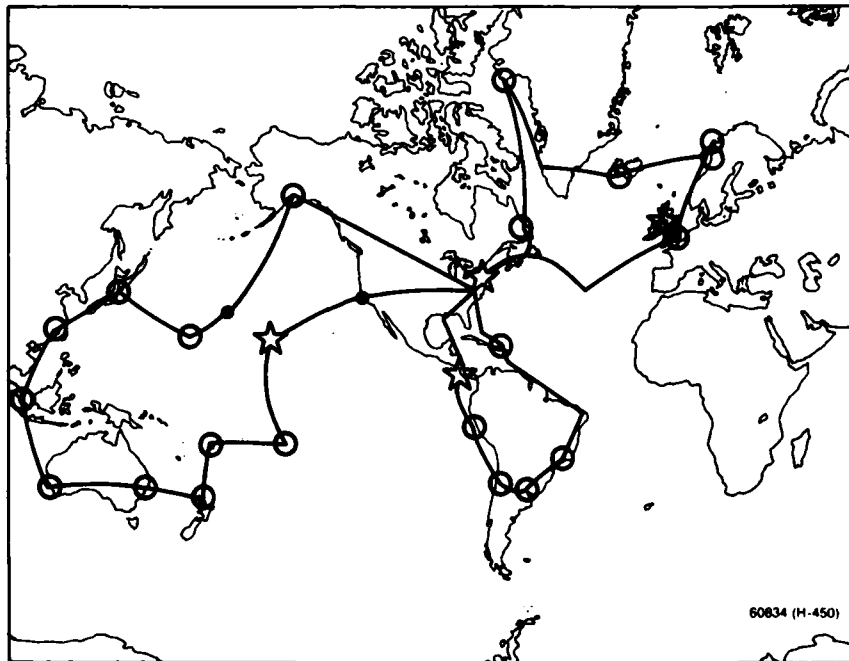

NRL OMEGA PROPAGATION STUDIES

Omega propagation investigations were made by NRL during 1961, 1962, and 1963, both in the air over the flight paths shown, and at ground sites indicated by the circles. Longer term measurements were made at the ground sites. The four sites indicated by stars (Hawaii, Panama, New York, and England) are the locations of the transmitting stations.

## RADIO NAVIGATION

reception out to 5000 nautical miles. The considerations indicated that eight properly placed transmitting stations would provide excellent navigational coverage of the entire world.

### LANE IDENTIFICATION

The Omega system requires the maintenance of a lane count from the point of origin which, once established, is automatically kept up by the receiver. While if lost the lane count can be recovered in several ways, to insure recovery an auxiliary frequency, 13.6 kHz, was introduced into the transmission sequence. Reference to the difference between the 13.6 and 10.2 kHz frequencies, or 3.4 kHz, increases the lane width from 8 to 24 nautical miles. To permit simultaneous reception of the two transmitted frequencies, NRL developed an adapter for the existing receivers (AN/URN-18, AN/URN-2) (1964), involving a technique which was incorporated into the later receiver, the AN/BRN-4 (1968).<sup>58</sup> The phase velocities of the two transmitting frequencies are not the same, and application of correction factors is required to insure accuracy in lane identification. These factors were determined theoretically and compared with values obtained in extended measurements on transmissions of the several stations made at NRL's local site and its sites in Florida, Bermuda, and Iceland (1966-1968).<sup>54</sup> Additional comparison measurements were made during flights of NRL's aircraft (EC-121K), appropriately instrumented, to Newfoundland, Iceland, and Azores, Bermuda, and also to Hawaii (1965).<sup>55</sup> Analysis of the data obtained showed that the calculated differences in velocity of propagation of the two frequencies were accurate enough to provide satisfactory lane identification. The correction factors were furnished to navigators in the form of simple tables.

### AIRBORNE OMEGA

In 1959, NRL proposed that Omega be utilized by aircraft for navigation and initiated a program

to develop equipment which would provide for the special functions peculiar to airborne operation.<sup>56</sup> This program was subsequently sponsored by the Navy Department, with NRL having sole in-house developmental responsibility.<sup>57</sup> Operation in aircraft had to contend with substantial phase changes in the received VLF carriers, caused by the movement of the craft at relatively high velocity; this effect is not of concern in ship installations. These phase changes vary with changes in the speed of the aircraft and its heading with respect to the direction of the transmitting stations. Since the availability of new phase-difference data had to await the completion of the sequential transmitting cycle, undesired error (lag) existed in the position as indicated. In overcoming the difficulty, NRL developed the first aircraft Omega navigation reception equipment (Mark I) (1961).<sup>58</sup> Through many flights with this equipment, NRL established the practicality of the Omega system for use by aircraft. This equipment was the first to provide, automatically, a continuous graphic flight history of an entire flight in a long-range radio-navigation system (recording of position versus time). It was also the first solid-state Omega reception equipment. It included continuous modification of the stored values of the VLF carrier phase differences at rates determined by air speed and heading, relative to the directions of the transmitting stations, so as to provide indication of correct instantaneous position of the aircraft. During 1961 and 1962, the performance of this Mark I equipment was assessed during many flights, totalling over 100,000 miles. Data were obtained during the previously mentioned flights to the Arctic, to Europe and South America, from New Orleans via Panama to Ecuador, and from the Bahamas to Washington, D.C., areas for which Omega charts were available (1961). Continuous airborne tracking was obtained which included maintenance of lane count, except during a hail storm, when the signal-to-noise ratio dropped severely.<sup>59</sup> The potential

<sup>54</sup>By the Bureau of Ships, Aeronautics, and Weapons, until the reorganization of the Navy Department of 1 May 1966, then by the Naval Electronics Systems Command.

## RADIO NAVIGATION

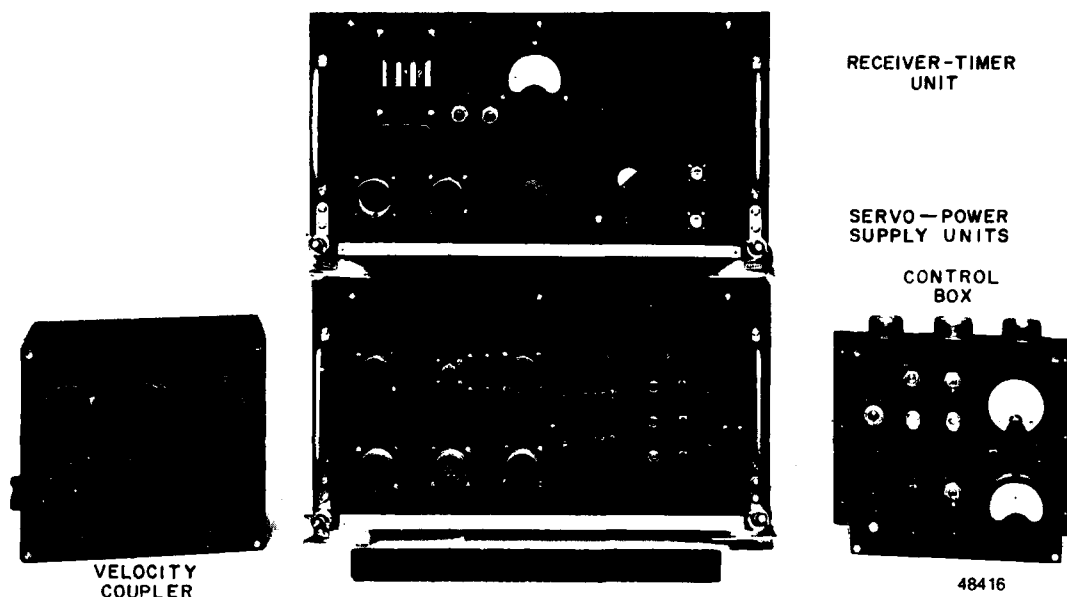

### THE FIRST AIRCRAFT OMEGA RECEIVER - THE MARK I

This receiver, developed by NRL in 1961, was the first to demonstrate that the use of the Omega navigational system by aircraft was practical. It was also the first to provide automatically, a continuous graphic flight history of an entire flight in a long-range radio navigation system. The instrument gave excellent navigational performance in continuous use during NRL's long flights in the arctic, temperate, and tropical zones.

accuracy of the Mark I aircraft system was determined by repetitive flights over a local triangular course of 225 miles total length (1962). The fix deviations fell within a range of  $\pm 0.4$  mile to  $\pm 1$  mile. Demonstrations of the capability of the airborne system were given over the triangular course to representatives of the Navy Department, U.S. Coast Guard, Federal Aviation Administration, and the Air Force. To obtain additional performance data with the Mark I equipment over wide areas, particularly with respect to improvements made in noise rejection and sensitivity, six flights were made in 1962 to South Dakota (May), New Foundland and Labrador (June), Bermuda (August), Alaska (September), and Azores-England-Italy-Iceland-Labrador (October and November).<sup>60</sup> While in these flights the equipment proved generally effective and reliable, it was found that it lacked ability to contend with intense precipitation static and that automation of the velocity-heading corrections was

necessary. Nevertheless, the Mark I equipment demonstrated that the use of the Omega navigational system by aircraft was practical. The first operational use of the Omega navigational system was in NRL's participation in the search for the remains of the submarine USS THRESHER (SSN-593), lost in the North Atlantic on 10 Apr. 1963. NRL's Mark I Omega equipment aboard the oceanographic ship USNS GILLIS (AGOR-4) during the period April through September 1963 proved effective in tracking, particularly at night when other radio-navigation systems failed.

In 1963 NRL completed its development of the Mark II aircraft Omega equipment, which provided for the first time automatic velocity-heading compensation for the lag in received position data, and thus correct instantaneous position indication.<sup>61</sup> Dead-reckoning, automatically activated during periods of high noise level or loss of signal to prevent discontinuities in position indication, was also a

## RADIO NAVIGATION

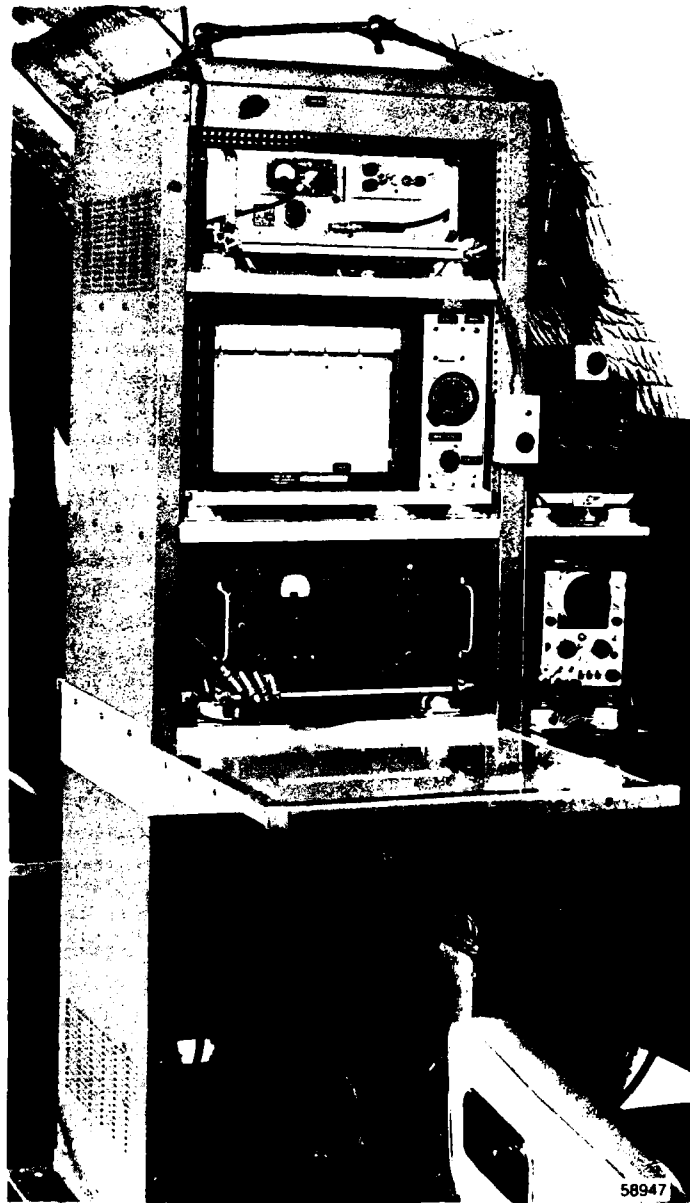

**THE MARK II NRL OMEGA AIRCRAFT RECEIVER**

This receiver, developed by NRL in 1963, is shown here mounted in a supporting rack in NRL's C-54 aircraft. It provided for the first time automatic velocity-heading compensation for lag in received position data. It incorporated a computer which provided information on wind drift. The unit immediately above the receiver provided phase-position recordings. The top unit was a precision frequency standard for reference in obtaining phase differences between transmitting stations.

unique feature. Many demonstrations of the performance of the Mark II equipment were given to military and civilian personnel of the Navy, Air Force, Army, Coast Guard, and Federal Aviation Administration, and also to representatives of foreign countries. To reduce the interference caused by precipitation static, the magnetic instead of the electric component of the propagated wave was utilized through the employment of an electrostatically shielded, ferrite, cross-loop antenna which was provided with circuits to avoid phase distortion. Hard-limiting input circuits were used to reduce detector blocking caused by high-level impulses of atmospheric noise. Circular coordinates were employed for the first time in a long-range radio navigation system, to secure their advantages of double lane width, better lane geometry, and simplicity in design and operation, as compared to hyperbolic coordinates. The use of circular coordinates required reference oscillators of very high precision, which were made available through NRL's work in this field. The effectiveness of these features was ascertained in over 250,000 miles of flying with the Mark II equipment in various types of aircraft (types C-54, EC-121, KC-135 fixed wing, and a helicopter) and at altitudes up to 35,000 feet. During the period 1964 through 1968, flights were made to areas in the Arctic, South America, Europe, and the Pacific as far west as Wake and the Fiji Islands. During these flights the automatic velocity-heading compensation operated successfully within the power-range limits of the experimental transmitting stations. The features provided for the reduction of precipitation static and atmospheric noise were found adequate. The use of circular coordinates proved so successful that they were adopted later for inclusion in standard operational equipment.

In 1968 the first functional prototype airborne Omega receiving equipment embodying a digital electronic computer, the Mark III, was developed by NRL.<sup>62</sup> The computer processes the incoming information, makes the velocity-heading and dead-reckoning computations, and provides position in latitude and longitude, distance and bearing to destination, and

steering information. Its output is suitable for coupling to the autopilot. The Mark III uses a 11-1/3-kHz carrier frequency introduced into the transmitting sequence in addition to the 10.2-kHz primary frequency. The difference frequency, 1133-1/3 Hz, provides lanes 144 nautical miles wide, with circular coordinates. The Mark III may easily be converted to use the 13.6-kHz carrier frequency. The features of the Mark III were completely assessed in extensive flights, both local and long range, as had been done with previous models (1968-1970). Its satisfactory operation was thoroughly demonstrated to representatives of interested United States and foreign agencies. In NRL flights to England and Spain, particularly vivid demonstrations of its capability to contend with intense precipitation static were witnessed. Between Newfoundland and England, and on the flight from Spain to the Azores, Loran A, Loran C, and communication signals were obliterated by the effects of severe rain and icing conditions for approximately three consecutive hours on the former and 20 minutes on the latter. The Mark III equipment, however, tracked consistently through both periods. Based on NRL's Mark III, Omega airborne navigational equipment (Model AN/APN-99) for operational use was procured. Other military and commercial activities expressed much interest in it.

#### DIFFERENTIAL OMEGA

Considerable improvement in position accuracy can be obtained from the Omega system over limited remote areas if propagation-variation data obtained by a monitor in the area is transmitted to users in the area for correcting observed positions. Using this method in a ship-aircraft rendezvous operation by NRL's USNS MIZAR and C-54 aircraft, rendezvous was accomplished within 500 yards (1965).<sup>63</sup> Fixed monitors were established at NRL's local and Chesapeake Bay sites and at the Coast Guard Engineering Center at Wildwood, New Jersey. Data were obtained by a mobile monitor placed at Fort Eustis, Virginia and Cape Hatteras, North Carolina and at the

## RADIO NAVIGATION

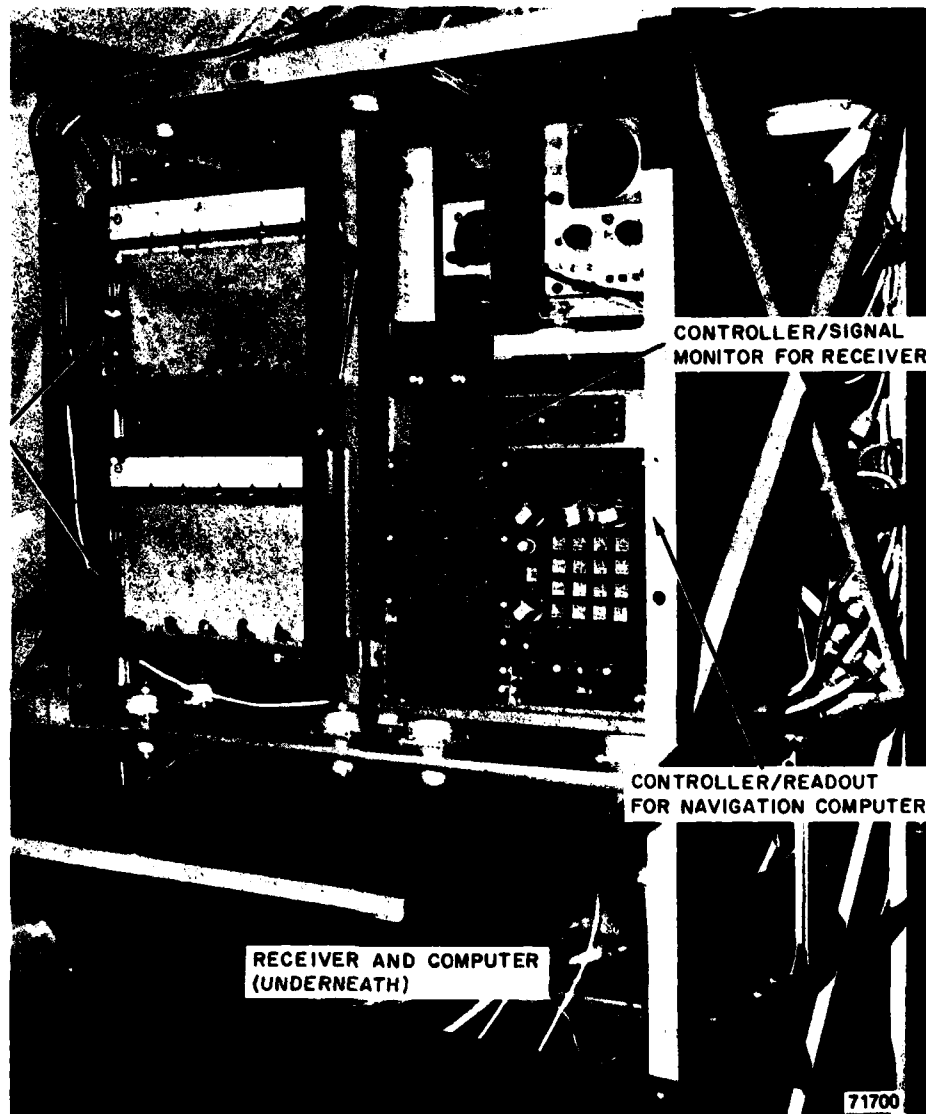

### NRL'S MARK III MODEL AIRCRAFT OMEGA NAVIGATION RECEIVING EQUIPMENT

The Mark III Omega, developed by NRL (1968) and shown here mounted in NRL's C-54 aircraft, was first automatically to provide position in latitude and longitude, distance and bearing to destination, steering information, and autopilot operating capability. It included a digital computer provided by a contractor. Many demonstrations of the equipment were given to representatives of military and civilian United States and foreign agencies. The equipment served as a prototype for procurement in quantity of the Model AN/ARN-99 receiver for airborne operational use. A simplified, low-cost model was procured in quantity for shipboard use, the Model AN/SRN.



## RADIO NAVIGATION

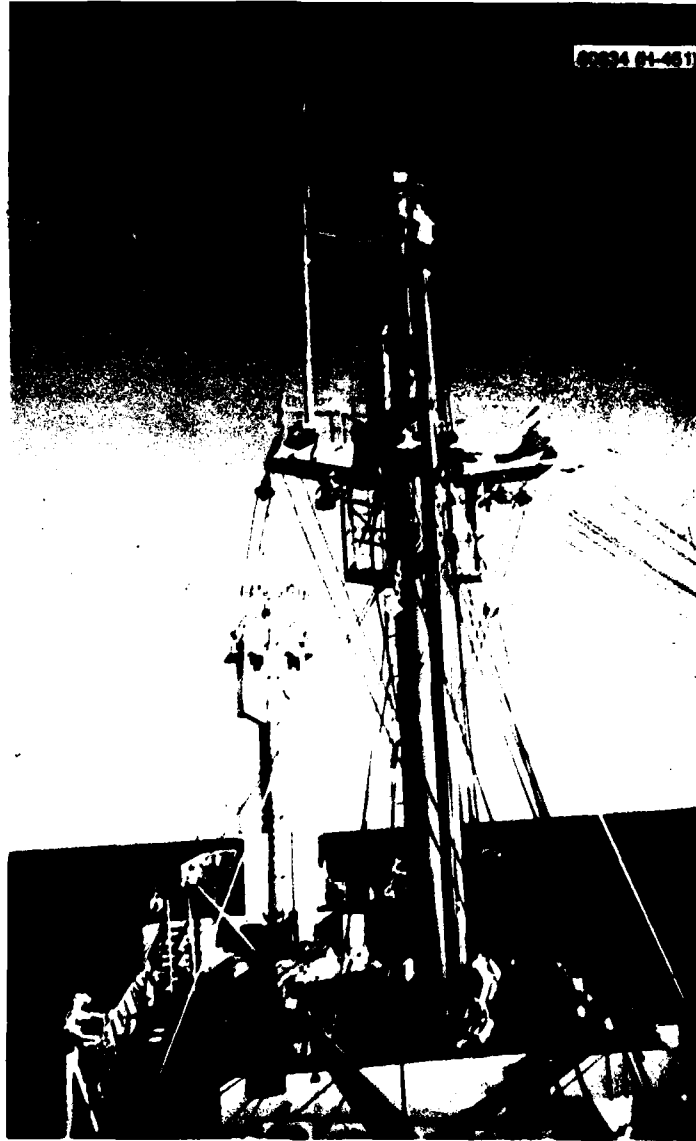

### RENDEZVOUS ACCURACY OF OMEGA

The accuracy of the Omega system is considerably higher when it is used to effect a rendezvous at a certain position, since each receiver is subject to the same propagation-data variations. NRL's C-54 aircraft was able to rendezvous at an agreed-upon position with the USNS MIZAR without visual aid and with an average error of 210 yards in five trials during day, night, and transition periods (January 1965). NRL's aircraft is shown here above the MIZAR at the end of one of the trials.

## RADIO NAVIGATION

Naval Air Station, Oceana, Virginia. Analysis of the data showed that a position accuracy of 350 yards could be obtained with this differential method (1966-1970).<sup>64</sup>

### OMEGA SYSTEM IMPLEMENTATION

The Omega system was declared operational in 1968, but was limited to the four existing transmitting stations. One hundred forty reception equipments have been procured and installed on Naval ships. Full implementation of the system was approved by the Secretary of Defense. A total of eight strategically located transmitting stations radiating a power of 10 kW can provide worldwide coverage, with position accuracy of

one mile in daytime and two miles at night. The other military services found important uses for the system, which also found widespread use by our allies and by commercial and civilian shipping and aviation.

### HIGH-PRECISION RADIO NAVIGATION SYSTEMS

The Navy's operational experience during World War II brought to light navigational deficiencies in harbor-entrance, minelaying, mine-sweeping, amphibious-landing, ground-position location, and underwater-search functions requiring a degree of precision accuracy higher than could be provided by systems in operation. The

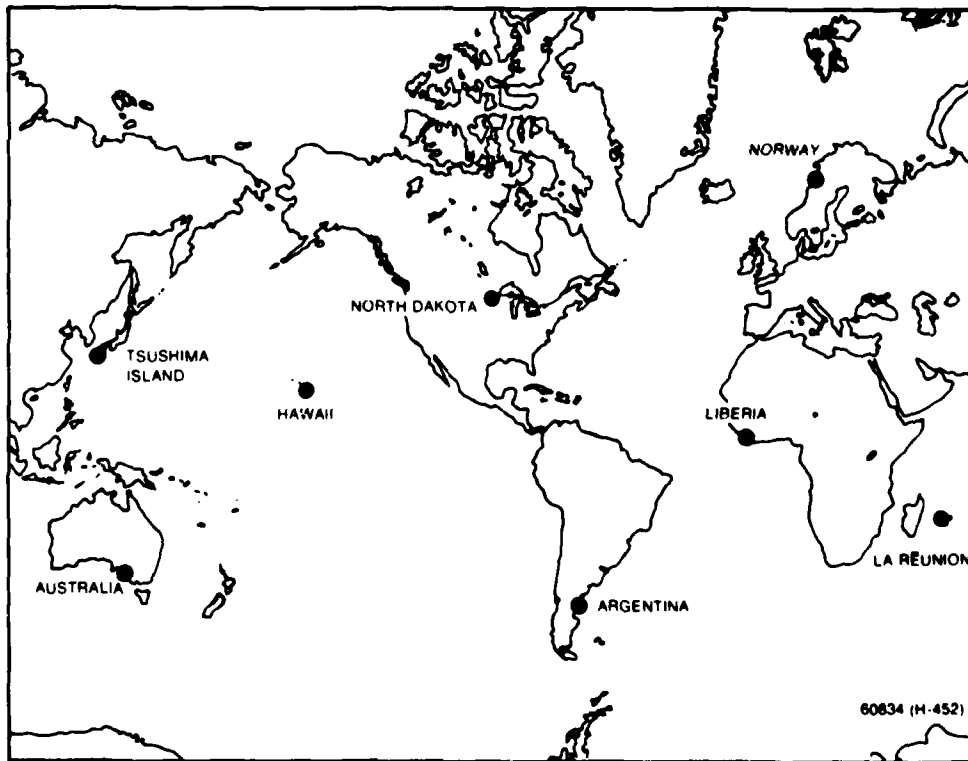

PROPOSED LOCATIONS FOR EIGHT OMEGA STATIONS TO PROVIDE WORLDWIDE COVERAGE (1974).

## RADIO NAVIGATION

requirements included continuous operation with reliability and position accuracy as high as ten yards at ten miles. NRL investigated several navigational systems to determine the promise they gave to meet the requirements. One of these was the Decca navigation system, developed by the British during World War II and installed in England and along the western coast of Europe. Decca is a hyperbolic, continuous-wave, phase-comparison system utilizing synchronized transmitters arranged in groups comprising a master and two or three slave transmitters separated by 40 to 80 nautical miles. Lane ambiguity is resolved by the comparison of several transmitted frequencies having integral relationships. NRL determined the performance of the Decca system with a special installation in the Norfolk, Virginia area comprising a master and two slave transmitters, with 40-nautical-mile separation.<sup>66</sup> With receiving equipments installed on the USS JAMES M. GILLIS (AMCU-13), a minesweeper (MSB-12), and a helicopter, position observations were made in the Chesapeake Bay area out to a range of 100 miles (August-October 1954). Analysis of the data obtained indicated that under low-noise-level conditions an accuracy of 50 feet at distances out to 40 nautical miles was possible. However, at night serious position errors were encountered due to interference with the ground wave by the sky wave; this effect is unavoidable in a continuous-wave system.

NRL explored the possibility of obtaining higher position accuracy through the use of short baselines in a Loran A type system and a technique in which cycle matching within the pulse provided high accuracy in pulse-time-difference measurement.<sup>66</sup> Such a system, designated Loran B, was established in the Norfolk, Virginia area with a master and two slave transmitters separated from the master by 35 and 70 nautical miles respectively (1800 to 2000 kHz). With receiving equipment installed aboard the USS NOTABLE (MSO-460) and NRL's ship the USS ROCKVILLE (EPCER-851), NRL made extensive observations on the performance of the system in the lower Chesapeake Bay (July-September 1959). The results showed that although a ten-

fold improvement in accuracy was obtained with the use of the cycle-matching technique, dispersion effects in wave propagation, particularly at night, produced uncertainty in cycle identification, rendering the value of the system questionable. Its complexity is another objection to its operational use.

NRL also investigated the performance of the Lorac, Rana, Prefix, Letts, and LCCS systems, all of the continuous-wave, hyperbolic, phase-comparison type (1952-1956).<sup>67</sup> Lorac, used in seismic surveys, was installed at Bermuda for NRL's observations (2 MHz). Rana, a French system, which used four frequencies in the 1600-kHz region, was made available for NRL's observations in France. Prefix, observed by NRL in the Hampton, Virginia area, used three frequencies (200 to 550 kHz) for lane identification and position within the lane. Letts, a light-weight system obtained by the Marine Corps for the ground positioning of troops, was observed in the Quantico, Virginia area (400 to 535 kHz). LCCS, a landing craft control system identical in theory of operation to Letts, operated in the same frequency band. All of these systems were found to be lacking in position-fix accuracy, diurnal stability, reliability, and/or operational practicality. The radar-marker beacon system provided an outstanding means of obtaining position fixes of high precision.

## REFERENCES

1. "Radio Telegraph, Radio Compass and Sound," Bureau of Engineering letter to Bureau of Navigation, 26 June 1923, reproduced in NRSR, Sept., Oct. 1923, pp. 33-42
2. Report, Secretary of the Navy, 30 June 1907, p. 46
3. S.C. Hooper, RADM, USN, "Navy History—Radio, Radar and Sonar Recordings," Office of Naval History, Washington, D.C.
  - a. Recording 31R77
  - b. Recording 32R78
4. R.S. Griffin, ADM, "History of the Bureau of Engineering, Navy Department During the World War," Navy Dept. Office of Naval Records Library, Publication No. 5, 1922; NRL Library 359. 0072T2381 (Ref)  
\*F.A. Kolster and F.W. Dunmore, "The Radio Direction-Finder and Its Applications," Scientific Papers of the Bureau of Standards, Vol. 17, 1922, p. 529
5. "U.S. Navy Radio Direction Finders," 1940, NRL Document 475,800

## RADIO NAVIGATION

6. NRSR, 16 Aug. 1919, p. 47
7. NRSR, 1 July 1920, pp. 76-90
8. NRSR, June 1924, p. 49
9. J.H. Gough, G.A. Lyle, "Test of Loop Structure Assembly of the Model DQ Radio Direction Finder Equipment," NRL Report 1141, Mar. 1935
  - J.H. Gough, W.B. Burgess, "Test of Models DP-4, DP-5, DP-6 and DQ-1, Radio D.F. Equipment," NRL Report 1347, Apr. 1937
  - R.H. Worrall, "Test of Model DR Direction Finder Equipment," NRL Report 1353, Apr. 1937
  - S.A. Greenleaf, "Tests on Model DK Direction Finder Receiver to Determine Signal-Noise Characteristics and Make Recommendations as to Any Corrective Action Required on Model DK Receivers in the Service," NRL Report 1386, Aug. 1937
  - M.K. Goldstein, "The Medium Frequency Adcock Direction Finder and a Resistance Goniometer," NRL Report 1564, Oct. 1939
  - R.A. Gordon, M.H. Schrenk, "Observation of Night Effects on Model CXS Radio Direction Finder Below 100 Kcs," NRL Report 1575, Nov. 1939
  - M.K. Goldstein, "Calibration Analyses of First Naval District Shore D/F Stations," NRL Report 1606, Apr. 1940
  - M.K. Goldstein, "Specifications for Minimum Direction Finder Site Requirements," NRL Report 1938, Sept. 1942
  - L.S. Schwartz, "Factors Affecting Choice of Transmisson Frequencies for Line-of-Sight Systems," NRL Report 3005, Oct. 1946
  - NRL Problems D1-1, D1-2, D1-6, D1-7, D2-2, D3-4, D3-5; NRL CRMO
10. NRSR
  - Dec. 1926-Jan. 1927, pp. 1-26
  - July, Aug. 1927, pp. 15-18
11. S.A. Greenleaf, "Tests on Model DK Direction Finder Receiver to Determine Signal-Noise Characteristics and Make Recommendations as to Any Corrective Action Required on Model DK Receivers in the Service," NRL Report 1386, Aug. 1937
  - NRSR
    - July-Dec. 1931, p. 101
    - July 1932, pp. 26-31
    - Jan. 1933, p. 150
12. R.A. Gordon, "Test of Model DW Radio Direction Finder Equipment, submitted by the Bendix Radio Corp.," NRL Report 1487, Oct. 1938
  - M.K. Goldstein, A. Brodzinsky, "Operational Performance of Special Radio Facilities Aboard Air-Rescue Boat C-36163," NRL Report 2367, Sept. 1944
  - A.G. Thompson, "Model DBD Medium Frequency Direction Finder Equipment for Small Craft," NRL Report 2754, Apr. 1946
13. T. Johnson, Jr., "Naval Aircraft Radio," Part II, IRE, Apr. 1920, pp. 119-127
14. NRSR
  - 1 Dec. 1919, pp. 29-30
  - "Elimination of Induction on Board Aircraft," Radio Research Problem No. 3, 1 Feb. 1920, pp. 43-44
15. A. Hoyt Taylor, "Radio Reminiscences: A Half Century," NRL Library 359.0072.T238 (Ref)
  - a. pp. 74-76 (1960); pp. 126-131 (1948)
  - b. pp. 76-77 (1960); pp. 129-133 (1948)
  - c. pp. 170-171 (1960); pp. 289-292 (1948)
  - d. pp. 215-216 (1960); pp. 369-371 (1948)
  - e. pp. 180, 215 (1960); pp. 307, 370 (1948)
- H.C. Rodd, ENS, USN, "Across the Ocean on the NC-4," Wireless Age, Nov. 1919
- R.A. Lavender, LCDR, USN, "Radio Equipment on NC Seaplanes," U.S. Naval Inst. Proc., Sept. 1920, pp. 1601-1607
16. NRSR, 1 Aug. 1920, pp. 50-53
17. M.C. Hanson, "Aircraft Radio Installations," IRE, July 1928, pp. 921-965
18. R.A. Gordon, "Test of Model DV Direction Finder Equipment, Serial #5, submitted by Bendix Radio Corp.," NRL Report 1475, Sept. 1938
  - R.A. Gordon, "Test of Model DW Radio Direction Finder Equipment, submitted by the Bendix Radio Corp.," NRL Report 1487, Oct. 1938
  - R.A. Gordon, "Test of Model DU Direction Finder Equipment, submitted by Bendix Radio Corp.," NRL Report 1502, Dec. 1938
  - R.A. Gordon, "Test of Preliminary Model XDU-1 Radio Direction Finder Equipment, submitted by Bendix Radio Corp.," NRL Report 1628, June 1940
19. R.A. Gordon, K.M. Soukaras, "Test of Model XDZ Radio Direction Finder Equipment," NRL Report 1613, May 1940
20. R.A. Gordon, M.H. Schrenk, "Observation of Night Effects on Model CXS Radio Direction Finder Below 100 Kcs," NRL Report 1575, Nov. 1939
21. P.M. Craig, "Lexington and Saratoga—The New Beginning," U.S. Naval Inst. Proc., Dec. 1969, pp. 84-92
22. "Homing Devices for Aircraft," NRL File F42-1/25, 1935-1938
23. "Aircraft Homing Devices," NRL File F42-1/69H, National Archives; NRL CRMO
24. R.A. Gordon, "Test of Model ZB Homing Adapter, submitted by Graybar Electric Co.," NRL Report 1687, Jan. 1941
  - H.R. Johannessen, J.D. Wallace, "Tests of Directive Characteristics of Antenna Array of Model YE Homing Equipment," NRL Report 1755, June 1941
  - J.D. Foley, H.R. Johannessen, R.B. Meyer, "Test of Model YE Homing Transmitting Equipment, submitted by RCA," NRL Report 1772, Aug. 1941
  - T.W. Hopkinson, H.R. Johannessen, "Notes on the Modification of the Models YE and YG Homing Beacon Equipments for Increased Security," NRL Report 2316, July 1944
  - C.B. Okonski, H.R. Johannessen, "Type Test of Model YE-1 Homing Beacon Equipment, Serial 53," NRL Report 2425, Feb. 1945
25. S.M. Rice, M.F. Hodges, M.L. Leppert, and H.R. Johannessen, "Test of Model YG Homing Beacon Equipment, submitted by RCA Mfg. Co.," NRL Report 1976, Jan. 1943
  - G.A. Helwig, L.G. Robbins, "Test of Model YG-1 Homing Beacon Equipment, submitted by Stewart-Warner Corp.," NRL Report 2193, Jan. 1944
  - R.W. Haward, T.W. Hopkinson, H.R. Johannessen, "Test of Maintenance of True Bearing Attachment for Model YG Homing Beacon Equipment, submitted by RCA," NRL Report 2194, Dec. 1943
26. L.G. Robbins and O. Norgorden, "Test of XBC Radio Beacon Equipment," NRL Report 1985, Jan. 1943
  - W.A. White, O. Norgorden, "Notes of the General Design of Model XBZ (YN) Radio Transmitting Equipment," NRL Report 2196, Nov. 1943
  - O. Norgorden, "Improved Antenna for Model YL (XBC) Radio Beacon Equipment," NRL Report 2253, Mar. 1944
27. W.J. Cahill, "Development of Micro-Ray Radio Apparatus for Use in Aircraft Altdrift Meter Equipment," NRL Report 1111, Jan. 1935

## RADIO NAVIGATION

28. "Aldrift Meter Investigations," 1936-1938, NRL File 867-71  
 \*Aircraft Instruments (Altimeter)," 1927-1943, NRL Files F31-1 (3)
29. C.L. Estes, J.E. Gibson, "Flight Tests of a Ground Speed Indicator," NRL Report 2552, June 1945  
 \*C.L. Estes and E.F. McClain, "Flight Tests of a Ground Speed Indicator over Measured Runs," NRL Report 3239, Feb. 1948
30. E.O. Hulbert, "The Doppler Frequency Change in Radiation Reflected from the Waves of the Sea," NRL Report 2422, Dec. 1944  
 \*E.F. McClain and W.R. Ferris, "Reflectivity of Sea Surface for Doppler Radar," NRL Report 3418, Feb. 1949  
 \*C.R. Grant, B.S. Yaplee, "The Reflectivity of the Sea and Land at Centimeter and Millimeter Wavelengths," NRL Report 4787, July 1956  
 \*C.R. Grant and B.S. Yaplee, "Flight Tests of an 8.6-MM Doppler Navigator Radar," NRL Report 4923, May 1957  
 \*C.R. Grant, H.H. Corbett, and J.E. Kenney, "Performance Tests of a Doppler Navigator," NRL Report 5447, Feb. 1960
31. E.F. McClain, R.C. Giles, D.L. Dewey, W.R. Ferris, "The AN/APN-67 Automatic Navigator," NRL Report 4051, Oct. 1952  
 \*C.R. Grant, E.F. McClain, W.R. Ferris, "Flight Tests of the AN/APN-67 Automatic Navigator Using Space Duplexing," NRL Report 4503, Feb. 1955
32. W.R. Ferris and E.F. McClain, "The AN/APN-67: A Means of Automatic Navigation for Aircraft, Report of NRL Progress, Dec. 1949, pp. 1-7
33. C.R. Grant and B.S. Yaplee, "Flight Tests of an 8.6-MM Doppler Navigator Radar," NRL Report 4923, May 1957  
 \*C.R. Grant, H.H. Corbett, and J.E. Kenney, "Performance Tests of a Doppler Navigator," NRL Report 5447, Feb. 1960
34. "Carrier Control Approach," BuShips Electron, Oct. 1945, pp. 16, 17 (NAVSHIPS 900,100)  
 \*Report of NRL Progress, Monthly Progress Report, May, June 1946, p. 11  
 \*Report of NRL Progress, Monthly Progress Report, Sept., Oct. 1946, p. 13  
 \*R.E. White, "A Carrier Controlled Approach System for Aircraft," NRL Progress Report, Feb. 1947, pp. 10-13
35. "Annual Technical Report, Fiscal Year 1948," NRL Report 3420, 1948  
 \*"Carrier Controlled Approach System," Report of NRL Progress, Sept. 1947, p. 40  
 \*A.D. Tadde, "Carrier Controlled Approach," BuShips Electron, Apr. 1950, pp. 24-27 (NAVSHIPS 900,100)
36. A. Brodzinsky, M.S. Friedland, H.W. Chitty, "Analysis of Some Carrier All-Weather Flying Problems," NRL Report 3291, June 1948
37. A.B. Winick, I.M. Saffitz, "Video Mapping for the Data Relay Navigation System," NRL Report 3317, July 1948  
 \*A. Brodzinsky, "Recommended Research Program for Carrier All Weather Flying," NRL Report 3458, Apr. 1949  
 \*K.L. Huntley, D.R. Heinmiller, "Experimental Video Link Transmitter at 1000 Mc for the Data Relay Navigation System," NRL Report 3551, Oct. 1949  
 \*H.W. Chitty, R.E. Brescia, M.F. Williams, "Radar Relay Data Compression System," NRL Report 4045, Sept. 1952  
 \*H.W. Chitty, A.F. Thornhill, M.F. Williams, "Monitoring Indicator for AN/SPA-13 Air Traffic Control Computers," NRL Report 4577, Sept. 1955
- \*R.J. Lamplin, M.F. Williams, "A Point-Light-Source Projection Display for Air Traffic Control," NRL Report 5092, Feb. 1958  
 \*M.F. Williams, A.F. Thornhill, "An Air Traffic Control Color Display," NRL Report 5146, June 1958  
 \*M.S. Friedland, "Data Relay Navigation," Report of NRL Progress, Nov. 1947, pp. 1-5  
 \*M.K. Goldstein, "Data Relay Navigation System," Report of NRL Progress, Mar. 1948, p. 29  
 \*A. Brodzinsky, "Analysis of Suitable Systems of Naval Aviation," Report of NRL Progress, Aug. 1948, p. 47  
 \*A. Brodzinsky, "Data Relay Navigation," Report of NRL Progress, June 1949, p. 39
38. J.D. Albright, J.J. Conlon, "Simulator for Data Relay Navigation-Carrier Controlled Approach (DARN-CCA) System," NRL Report 3692, July 1950  
 \*H.W. Chitty, M.F. Williams, "Results of Flight Tests on Components of the Data Relay Navigation System," NRL Report 3754, Nov. 1950  
 \*K.L. Huntley, J.B. Reynolds, Jr., "Instrumentation and Preliminary Tests of the Automatic Carrier Controlled Approach System," NRL Report 3806, May 1951  
 \*J.T. Burke, D.R. Heinmiller, E.D. Messer, "The Simulated Pattern Generator," NRL Report 4149, Apr. 1953  
 \*A. Brodzinsky, M.F. Williams, "A Pictorial Cockpit Display for Air Traffic Control," NRL Report 4287, Feb. 1954
39. J.B. Reynolds, Jr., I.M. Saffitz, "Analysis of the Automatic Carrier Controlled Approach System," NRL Report 3687, May 1950  
 \*I.M. Saffitz, J.B. Reynolds, Jr., N. Vafiades, J. Perlman, "Instrumentation and Measurement of Aircraft Carrier Deck Motion," NRL Report 3996, June 1952  
 \*H.W. Chitty, R.E. Brescia, M.F. Williams, "Radar Relay Data Compression System," NRL Report 4045, Sept. 1952  
 \*A. Brodzinsky, J.B. Reynolds, Jr., J.J. Conlon, I.M. Saffitz, "Amplitude Spectrum Analysis of Aircraft Carrier Deck Motion," NRL Report 4381, June 1954
40. "Night Carrier Landings: Report of the Carrier Landing Study Group," NRL Memo. Rept. 1455, Nov. 1963  
 \*H.W. Chitty, P.J. LaRochelle, and R.R. Zirm, "NRL Contributions to an Automatic Approach and Landing System," Report of NRL Progress, Nov. 1957, pp. 1-9  
 \*J. Blair, "The All-Weather Carrier Landing System," U.S. Naval Aviation Weapons Systems Digest, June 1968, pp. 3-10
41. J.A. Pierce, A.A. McKenzie, and R.H. Woodward, "Loran: Long Range Navigation," MIT Radiation Laboratory Series, Vol. 4, McGraw-Hill, 1948
42. J.W. Brogden, "Analysis of Model UM Switching Equipment," NRL Report 2765, Feb. 1946  
 \*M.V. Hoover, "Considerations in the Design of 2 Mc Loran Transmitters Intended to Reduce Side-Bands and Permit Cycle-Matching Operation," NRL Report 2781, Mar. 1946  
 \*M.V. Hoover, "Investigation of the REL Model 575-BC Loran Transmitter, submitted by Radio Engineering Labs., Inc.," NRL Report 2285, May 1944  
 \*E.R. Rosen, "Test of Model TBP-1 Loran Transmitting Equipment," NRL Report 2862, June 1946  
 \*J.W. Brogden and H.D. Cabbage, "Field Reduction of Bandwidth of Loran Receivers and the Effect on Operation," NRL Report 2889, June 1946  
 \*A.E. Craig, J.W. Brogden, "Field Method of Amplitude Balance Changes of Loran Receivers and the Effect on Operation," NRL Report 3024, Oct. 1946.

- A.W. Coven, "Pulse Shape in the Loran System," NRL Report 3099, June 1947
- J.W. Brogden, H.D. Cabbage, B.H. Weston, "Cycle Matching for Standard Loran," NRL Report 3150, July 1947
- A.W. Coven, J.W. Brogden, "An Investigation and Analysis of the Radiation Spectrum of the Model TDP-1 Loran Transmitter," NRL Report 3269, Mar. 1948
- W.J. Romer, "Performance of Automatic Loran Receiving Set AN/SPN-16 (XN-1)," NRL Memo. Rept. 212, Sept. 1953
- A.E. Craig, "Attenuation of Loran Band Pass Filter," NRL Memo. Rept. 575, Mar. 1956
- 43 W.O. Henry, "Some Developments in Loran," J. Geophys. Rev. Feb. 1960, pp. 506-513
- 44 J.W. Brogden, "Test of Model C 27/UPN Low Frequency Converter for Loran," NRL Report 2699, Nov. 1945
- J.W. Brogden, H.D. Cabbage, B.H. Weston, "Analysis of Low Frequency Pulses," NRL Report 3288, Mar. 1948
- J.W. Brogden, "Underwater Reception of Loran C," NRL Memo. Rept. 1156, Mar. 1961
- A.N. Duckworth, "Manual Pulse Matching on Loran C Receivers," NRL Memo. Rept. 1539, June 1964
- 45 W.D. Meyers, "Performance of the AN/SPN 40 Loran Receiving Set. Improvement of," Technical Memorandum 5460-116A, 8 Oct. 1970
- 46 A.W. Coven, J.W. Brogden, "Radux Investigations," NRL Report 4135, Apr. 1953
- 47 "Long Range Navigation," Office of Naval Research, NAVEXOS P-645, July 1949, NRL Document No. 39707
- 48 J.W. Brogden, R.J. Ertman, "Investigation of Coherent Detection for Radux," NRL Report 4335, Apr. 1954
- J.W. Brogden, R.J. Ertman, A.E. Craig, NRL Report 4520, July 1955
- J.W. Brogden and R.J. Ertman, "Investigation and Modification of Sperry Radux Equipment Unit Number 3, NRL Memo. Rept. 187, July 1953
- R.J. Ertman, J.W. Brogden, and A.E. Craig, "Techniques and Circuitry for the NRL Experimental Radux Common Frequency Monitor Equipment," NRL Memo. Rept. 418, Jan. 1955
- R.J. Ertman, "Investigation of Multifrequency Radux Receiver," NRL Memo. Rept. 435, Mar. 1955
- R.J. Ertman, "Investigation of Common-Frequency Radux Receiver Indicator R-23X," NRL Memo. Rept. 511, Aug. 1955
- R.J. Ertman and A.E. Craig, "Investigation of Gain Control Techniques for Radux Navigator's Receivers," NRL Memo. Rept. 583, Apr. 1956
- 49 R.J. Ertman, "Investigation of Underwater Radio Reception as Applied to Radux," NRL Report 4406, Sept. 1954
- 50 J.W. Brogden, A.W. Coven, and M.F. Williams, "The Omega Navigation System," Frequency, Mar.-Apr. 1963, pp. 24-34
- 51 J.J. Over, "An Electronic Timer and Synchronizer for an Omega Navigation Receiver," NRL Memo. Rept. 1014, Dec. 1959
- W.D. Meyers, "Interim Report No. 1 on Shipboard Omega Receiver," NRL Memo. Rept. 1336, July 1962
- W.D. Meyers, "Lane Counter for the Tracor 599R Omega Receiver," NRL Memo. Rept. 2036, Sept. 1969
- J.W. Brogden, "Evaluation of the Omega AN/BRN 4 Navigation Receiver," NRL Test and Evaluation Report 107, Feb. 1970
- 52 L.A. Fletcher, "Omega Propagation Characteristics in the Arctic Temperate and Subarctic Regions," NRL Report 1324, May 1962
- L.A. Fletcher, "Interim Report Number 1 on Omega Station at Bodø, Norway," NRL Memo. Rept. 1000, Dec. 1960
- L.A. Fletcher, "Interim Report Number 2 on Omega Station at Lasham, England," NRL Memo. Rept. 1000, Dec. 1960
- W.D. Meyers, "Measuring Field Intensity of Omega Navigation System," NRL Memo. Rept. 2120, Apr. 1970
- 53 W.D. Meyers, "Omega Multi-Frequency Adapter for Types AN/URN-18 (XN-1) and AN/WRN-2 (XN-1)," NRL Instruction Book No. 43, Nov. 1965
- 54 J.W. Brogden and A.N. Duckworth, "Dispersion of Frequencies in the Omega Navigation System," NRL Memo. Rept. 1661, Nov. 1965
- J.W. Brogden and K.O.L. Luken, "Lane Identification in the Omega System," NRL Memo. Rept. 1803, July 1967
- J.W. Brogden and K. Luken, "Interim Report Number 2. Lane Identification in the Omega System," NRL Memo. Rept. 1876, May 1968
- 55 J.W. Brogden and A.N. Duckworth, "Dispersion of Frequencies in the Omega Navigation System," NRL Memo. Rept. 1661, Nov. 1965
- 56 "Air Navigation, Omega Receiver RF Navigation Equipment Techniques," NRL Problem R04-13
- 57 NRL Problem R04-13 related to Bureau of Aeronautics Problem NRI AX 45002, NA 445005, and Bureau of Ships Problem SS 161 001 6161
- 58 A.F. Thornhill, "Interim Report Number 1 on Airborne Omega Receiver," NRL Memo. Rept. 959, July 1959
- A.F. Thornhill, "Interim Report Number 2 on Airborne Omega Receiver," NRL Memo. Rept. 1029, Feb. 1960
- R.J. Lampkin and A.F. Thornhill, "Interim Report Number 3 on Airborne Omega Receiver," NRL Memo. Rept. 1118, Nov. 1960
- R.J. Lampkin, T.E. Leonard, and A.F. Thornhill, "Interim Report Number 4 on Airborne Omega Receiver," NRL Memo. Rept. 1102, June 1961
- E.L. Klein, "Interim Report Number 5 on Airborne Omega Receiver," NRL Memo. Rept. 1268, Feb. 1962
- 59 A.F. Thornhill and M.F. Williams, "Interim Report Number 6. Long Range Flight Tests of the Omega Aircraft Receiver," NRL Memo. Rept. 1325, May 1962
- 60 A.F. Thornhill and M.F. Williams, "Interim Report Number 7. Flight Tests of the Omega Aircraft Receiver," NRL Memo. Rept. 1392, Jan. 1963
- 61 R.H. Smith, A.F. Thornhill, and M.F. Williams, "Interim Report Number 8. Flight Tests of the Omega Aircraft Receiver," NRL Memo. Rept. 1543, June 1964
- E.L. Kline, A.F. Thornhill, and M.F. Williams, "Summary of the Flight Performance of the NRL Mark I and Mark II Omega Aircraft Receivers," NRL Memo. Rept. 1683, Feb. 1966
- R.A. Eisenberg and M.F. Williams, "Interim Report on Precipitation Effects on Omega Aircraft Receivers," NRL Memo. Rept. 1810, Aug. 1967
- 62 R.L. Eisenberg and M.F. Williams, "The Flight Performance of the NRL Mark III Omega Aircraft Navigation Set," NRL Report 7004, Oct. 1969
- R.L. Eisenberg, "Precipitation Effects on Omega Aircraft Receivers," NRL Report 7055, May 1970
- R.L. Eisenberg, E.L. Kline, and A.F. Thornhill, "NRL Mark III Aircraft Omega Receiver," NRL Memo. Rept. 1886, May 1968

## RADIO NAVIGATION

63. E.L. Kline, A.F. Thornhill, and M.F. Williams, "Summary of the Flight Performance of the NRL Mark I and Mark II Omega Aircraft Receivers," NRL Memo. Rept. 1683, Feb. 1966
64. K. Luken, J.W. Brogden, and W.D. Meyers, "Accuracy Studies of the Differential Omega Technique," NRL Report 7102, June 1970
  - J.W. Brogden and K.O.L. Luken, "Differential Omega," NRL Memo. Rept. 1716, Aug. 1966
  - W.D. Meyers, "Instrumentation of the NRL Differential Omega Study of April 1969," NRL Memo. Rept. 2057, Oct. 1969
65. J.W. Brogden and W.J. Romer, "Investigation of the Decca Navigation System," NRL Memo. Rept. 464, May 1955
66. J.W. Brogden, H.D. Cabbage, and B.H. Weston, "Cycle Matching for Standard Loran," NRL Report 3150, July 1947
  - J.W. Brogden, "High Precision Loran," NRL Memo. Rept. 554, Jan. 1956
  - J.J. Over, "A Study of the 'Loran B' Medium-Range High-Precision Navigation System," NRL Memo Rept. 1036, Mar. 1960
  - W.O. Henry, "Some Developments in Loran," J. Geophys. Res. Feb. 1960, pp. 506-513
67. W.J. Romer, "Performance Analysis of Loran Type A Hyperbolic Phase Comparison Navigation System," NRL Memo. Rept. 184, June 1953
  - J.W. Brogden and W.J. Romer, "Investigation of Prefix Receiver-Indicator," NRL Memo. Rept. 533, Oct. 1955

## Chapter 8

# ELECTRONIC COUNTERMEASURES

### INTRODUCTION

An aspect of warfare which has continued through the years is that the development of a weapon is soon followed by a countermeasure for it, and after that the development of a countermeasure takes place by way of an improved or a new weapon. This aspect of warfare has held true in the field of radio-electronics. Electronic countermeasures is a dynamic matter which, to be effective, must receive continual attention as electronic developments evolve. The situation the Germans faced with their radars during World War II must be avoided. The Germans fixed the designs of a few types of radars and abandoned further development in order to produce their radars quickly in large quantities. As a result, they soon became fatally vulnerable to allied electronic countermeasures.

As treated in this document, "electronic countermeasures" is considered to include means of intercepting enemy electronic emissions, determining the location of the source of these emissions, determining the capability of an enemy's electronic systems, the development and use of jamming means to counter the enemy's effective electronic systems. This subject does not include the improvement of the capability of electronic systems to deal with some countermeasure devised by an enemy for use against our systems. Such counter-countermeasure activity is considered to fall more properly within the scope of those subjects concerned with the further general improvement of our own several electronic systems. This continuing

competition between the devising and use of countermeasures and the improvement and use of our own electronic systems to deal with these countermeasures is itself in the nature of warfare, "electronic warfare."

The Navy was early to realize the importance of electronic countermeasures, and it took action to bring about its first strategic use during the 1903 summer maneuvers of its North Atlantic Fleet.<sup>1</sup> The Fleet was divided into two forces, an attacking force and a defending force. The objective of the attacking force was to capture and hold a portion of the Maine coast, which was to be defended. By 1903 a considerable number of radio-communication installations of the Navy's first such equipment had been completed on Navy ships. Some of these ships were assigned to both the attacking and defending forces. The attacking force was instructed to jam the radio transmissions of the defending force upon receiving a certain code word. The jamming was not effective. However, the defending force found the new radio-communication facility very useful during the maneuvers in winning the contest.

The Navy also soon appreciated the value of the radio direction finder in locating an enemy's forces by determining the directions of its transmissions. The Navy first installed a radio direction finder on the collier USS *Albatross* (YAG-1) to determine its performance and capability of the direction finder was better concerning the results of the tests. The Secretary of the Navy, the Chief of Naval Equipment stated, "The results of the tests indicate that a development of the system



## ELECTRONIC COUNTERMEASURES

have a far-reaching effect on the safety of vessels at sea, and will possibly play an important part in Naval warfare by making it feasible to locate the direction of an enemy's fleet."

### ELECTRONIC COUNTERMEASURES DURING WORLD WAR I

During World War I, United States destroyers, equipped with radio direction finders (Model 995), were utilized in locating enemy submarines, in effecting concentrations for hunter-killer operations, and in assembling and escorting convoys in thick weather. Direction finders at the U.S. Naval Base at Brest, France, were effectively used to divert allied convoys to avoid the German submarines concentrated in the Bay of Biscay. The German submarines unwittingly cooperated by their unrestrained use of radio communication.<sup>3</sup> By early 1918, the German Submarine Service was completely demoralized and ineffective.

During the war, Germany broadcast on 23.8 kHz from its only high-power VLF station (POZ), located at Nauen, its version of the progress of the war and propaganda to influence the German population in the United States. These broadcasts were copied by the Navy's receiving network, centered at Belmar, New Jersey, to uncover any concealed information. At times the transmissions stopped for 20 minutes, and it was noted that transmissions were continued at twice the frequency, or 47.6 kHz, quite feasible with their alternator type transmitter. These transmissions were found to be in code, obviously directed to their submarines at sea. The transmissions were copied, and the information was sent to Washington for decoding and use.<sup>4a</sup>

### NRL'S EARLY ELECTRONIC COUNTERMEASURES DEVELOPMENTS

In 1929, after its high-frequency-band communication developments were well underway, NRL devoted effort to problems concerning

"avoiding enemy detection and detecting enemy transmissions" and "creation of interference for the enemy."<sup>5</sup> The Navy had experienced persistent interference from Japanese high-power stations in the Pacific (see also Chapter 3). To avoid this interference, NRL devised special receiver circuitry.

To provide means of jamming enemy transmissions, NRL modified existing communication transmitters to sweep through a given frequency band occupied by the enemy and thus create a jamming signal. It was considered that conventional communication equipment as modified could serve the need, in case hostilities should be initiated in the future.

NRL had also been engaged in the development of remote control for guided missiles, as previously described in Chapter 5. In this work NRL realized that since the control signals were of short duration, they would be difficult to detect by existing means should an enemy use similar techniques for its guided missiles. Therefore, NRL developed the first intercept, continuously frequency scanning, countermeasures radio receiver with visual frequency display to indicate the existence of enemy guided-missile control signals and their frequency (1929).<sup>4b</sup> To demonstrate the system, a Model SE-2952 receiver was modified so that its tuning capacitor rotated continuously (240 to 650 kHz). The shaft carried a slotted disk with a neon tube mounted behind. The signals activated the neon tube, and the frequency could be read from a dial as the shaft rotated.

### WORLD WAR II ELECTRONIC COUNTERMEASURES

At the beginning of World War II, it became evident that both the Germans and the Japanese had developed radar and that means would have to be devised to counter this new implement of warfare. NRL made major contributions in this respect during the war in developing means of interception, enemy signal-source location, jamming, and deception.

## ELECTRONIC COUNTERMEASURES

In addition to the developments it carried out, NRL assembled the various radar countermeasure systems available and brought their capabilities to the attention of Navy high command, so that these systems could be integrated into plans as the war developed. In August 1943, NRL gave an extensive demonstration of countermeasure systems at its Chesapeake Bay site to the Commander-in-Chief and Chief of Naval Operations ADM E. J. King and a group of high-ranking Naval Officers, including VADM J.S. McCain, the Chief of the Bureau of Aeronautics, ADM D.C. Ramsey, the head of the Navy General Board, ADM A.J. Hepburn, and VADM W. S. DeLany of Naval Operations.<sup>6</sup> These officers became deeply interested in the potentialities of electronic countermeasures and expressed satisfaction in what had been accomplished.

NRL also participated in the formulation of plans for the Normandy invasion. It sent a group of its scientific staff to England, where they became advisors to allied high command, not alone for electronic countermeasures but also for radar, communications, and other aspects of radio-electronics.

During World War II, NRL was designated the center for the collection of all captured enemy electronic equipments sent to the United States. These equipments were analyzed in part by the Laboratory and in part by other organizations having appropriate analysis capability. Some of these equipments, particularly enemy radars, were reconditioned so that the capability of our countermeasures could be determined through direct observation.<sup>8</sup> The German small Wurzburg and their giant Wurzburg were reconditioned and thoroughly investigated. The first Japanese radar available, captured at Guadalcanal, was also placed in operating condition to determine its characteristics and vulnerability.

For interception of hostile radar signals, NRL developed the Model XARD early-warning airborne receiver (1942).<sup>7</sup> This receiver provided for the reception of enemy radar signals in the frequency bands then

known. A considerable quantity of these receivers were constructed and shipped to various Fleet units, to the U.S. Army, and to the British Royal Air Force.

NRL developed the first special armed forces group assembly system, to permit paratrooper groups dropped from aircraft concerned with obtaining intelligence information or on special operations to be quickly brought together about a leader through the use of a combined direction finder and communication equipment carried on the chest or back of each individual (1943).<sup>8</sup> This equipment, known as the Model DAV, was first used during operations in North Africa and the landings at Salerno, Italy. A total of 10,000 equipments were procured. The communication equipment covered a band of 2.3 to 4.5 MHz and furnished the signal for homing on the group leader. The direction finder was of the loop type, with a "sense" antenna which served also as the communication antenna. The loop's null point, as determined from the orally produced signal, was used in finding the direction, the operator turning his body to locate it. If the operator upon pressing the sense antenna button and turning his body in one direction found the null point diverted in the same direction, he knew he was going toward the leader. Otherwise, he had to reverse his direction of travel 180 degrees.

To provide jammers for the operating forces for use in the invasion of Italy, NRL, under a "crash" program, developed the Model XBK spot jammer (1943). In reporting on the results from the use of the Model XBK jammers, the Commander, Task Force in the Atlantic, in a message dated 17 Oct. 1943, stated, "...XBK spot jammers...were considered very successful against enemy airborne radar whose range has been determined to be from 560 to 620 megacycles. It is believed that enemy aircraft radar was effectively jammed, because shortly after jammers were cut in, enemy radar was secured and immediately after jammers were secured, enemy radar was turned on again...no fire was sustained by major vessels during the assault phases."<sup>9</sup>

## ELECTRONIC COUNTERMEASURES



### GERMAN WORLD WAR II RADARS

Shown above is the "small Wurzburg" radar (range on aircraft 30 miles), a portable equipment with a 10-foot-diameter parabolic antenna, and below it is the "giant Wurzburg" (range 45 miles), with a 25-foot-diameter parabolic antenna for fixed installations. These radars were used for both search and fire control. They had rotating dipoles at the focal point and provided both azimuth and elevation data. The small radar was available in considerable numbers. The giant radar was available in smaller numbers. They operated in the frequency range of 450 to 600 MHz and were provided with antenna duplexers. The quality of the workmanship was excellent.

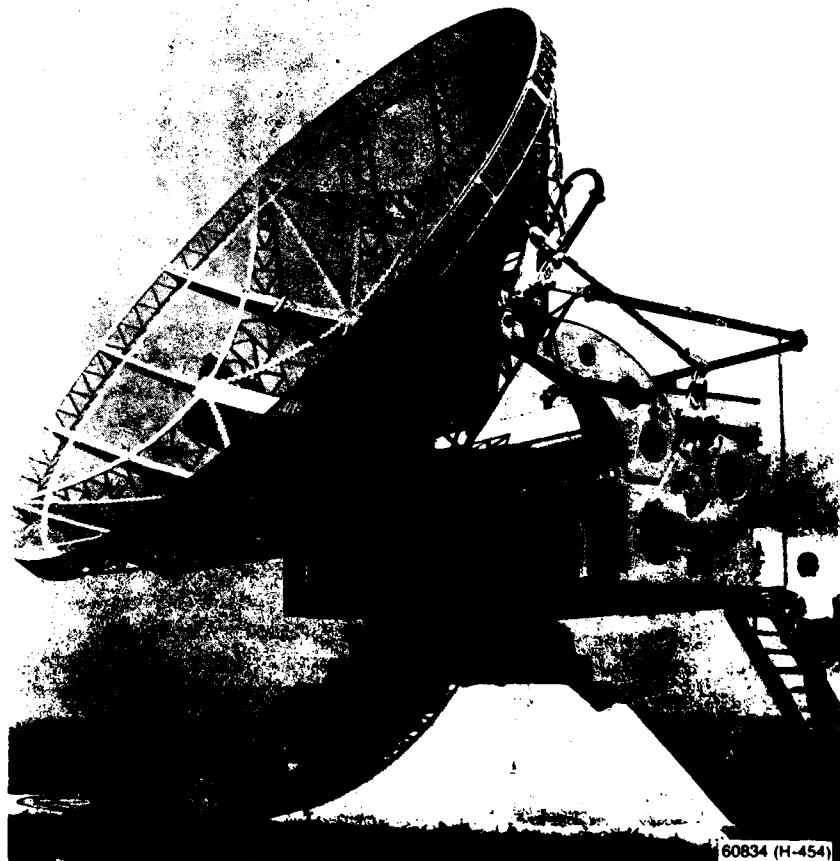

## ELECTRONIC COUNTERMEASURES

60834 (H-457)



**PARATROOPER ASSEMBLY SYSTEM,  
MODEL DAV**

NRL was first to develop a combined direction finder and communication equipment (1943) for use by intelligence and special mission groups during operations in North Africa and landings at Salerno, Italy. The equipment was used for assembling the members of a group about a leader. A total of 10,000 equipments were procured.

From knowledge acquired of the enemy's radar, it was determined that higher powered jammers would be required to protect our ships. Also it was considered that the enemy might change the frequency of his radars, requiring broader frequency coverage in our jammers. To meet these contingencies, NRL in cooperation with a contractor developed the Model TDY jamming equipment, which covered a range of 116 to 770 kHz, with a power output of 150 watts.<sup>10</sup> A number of these equipments were built for use by the Fleet.

NRL developed the first radio-guided-missile countermeasures equipment. This equipment was effectively used against the German radio-controlled air-launched missiles (1943).<sup>11</sup> The Germans started to use these air-launched missiles, the HS-293 and FX, in late August 1943, and were able to sink a number of British and American vessels in the Mediterranean Sea and Bay of Biscay. For a year NRL had been preparing for such eventuality and was in a position to institute a crash program to provide the necessary countermeasures equipment. Two destroyers, the USS DAVIS and USS JONES, were equipped with intercept and recording equipment provided by NRL and were sent to the active warfare area to obtain information on frequency range and type of control signals.<sup>12</sup> Analysis of the data obtained provided the basis for the development of a complete, integrated missile intercept-jamming system by NRL. Four complete search and jamming equipments were rushed to completion and shipped by air to Africa for use on ships operating in the Mediterranean. Two more destroyers, the DD-225 and DD-227, were outfitted with similar equipment at the New York Navy Yard under NRL guidance before proceeding to active duty protecting convoys from missiles in the same warfare area. During the spring of 1944, fourteen equipments of similar design were built for use in the protection of the Normandy invasion fleet. The operators of these equipments were trained by NRL. Fifty equipments, the design of which was modified by NRL, were also constructed in a rush. Including these equipments, 65 ships equipped for jamming

## ELECTRONIC COUNTERMEASURES

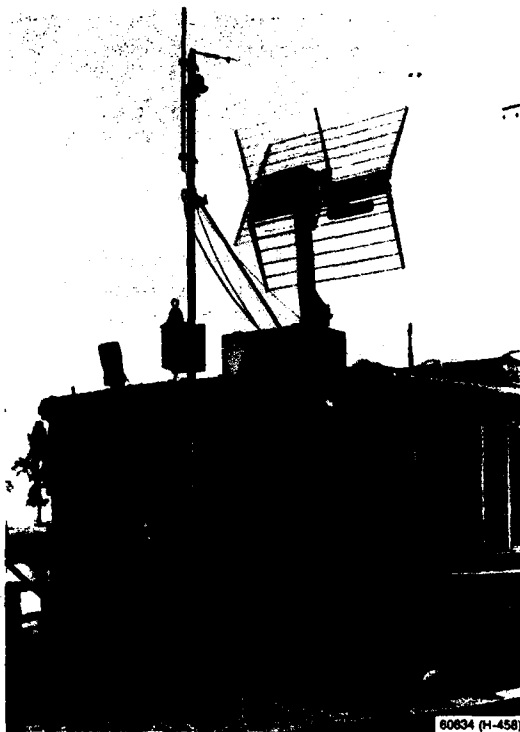

THE U.S. MODEL TDY RADAR JAMMER

At the left is shown the beam antenna, and at the right is the transmitter. This equipment covered a range of 116 to 770 kHz, adequate for the radars used by both the Germans and the Japanese. This equipment was developed by NRL with the aid of a contractor.

participated in the invasion of southern France. No ships so equipped were ever hit, and the ships were so placed that they protected large numbers of other ships.<sup>12</sup>

The principal equipments designed and developed by NRL for the program included the jamming transmitters (Models XCA, CXGE, and TEA), search receivers (Models RDC, RDG, and RDH), monitoring receivers (Models RBK, RBW, RBX, and RAO), modulation analyzer (Model OB), and broadband antennas. The

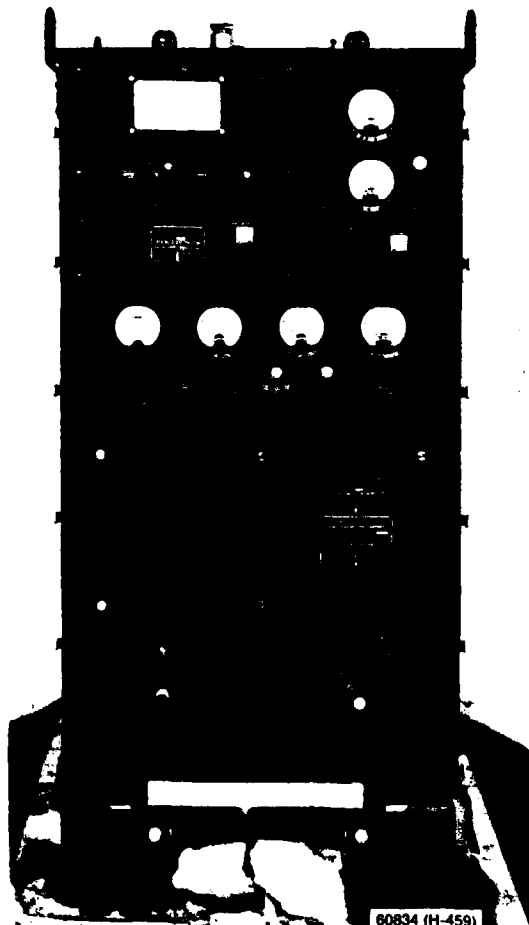

Models RDG and RDH search receivers were wideband, with panoramic capability for quickly locating enemy signals. The monitoring receivers were for setting the jamming transmitters accurately to the enemy's radar frequencies. The modulation analyzer provided information on the type of control signals employed.

If special countermeasures to combat Japanese radar had not been expeditiously developed, the victory over Japan would have cost more American lives than it did. It was realized that the

## ELECTRONIC COUNTERMEASURES



### THE FIRST GUIDED-MISSILE COUNTERMEASURES SYSTEM

This system, developed by NRL and installed on many ships, served during World War II to protect ships of the invasions and convoys. No ship equipped with this system was ever hit by German guided missiles. At the left is shown one of the antennas, projecting at 45° (1), installed on the destroyer DD425. At the right, as installed on the destroyer DD427, is shown the jamming equipment, including the Models RBK receiver (1), the RBW panoramic adapter (2), the XCJ-1 transmitter (3), the RCX panoramic adapter (4), the RAO receiver (5), and the transmitting antenna switches (6).

Japanese had some knowledge of our radars, since they captured some early American radars in their conquest of the Philippines, and also some British equipment was seized at Singapore. However, the first conclusive evidence that the Japanese had radar in operation came through the capture of three badly damaged sets on Guadalcanal. These were shipped promptly to NRL. Using the various components, NRL was able to assemble one complete Japanese radar and to study its characteristics and vulnerability. The results were forwarded to field commanders, which enabled them to judge the probable effectiveness of the Japanese radar and to plan their campaigns to exploit its weaknesses. Concurrently with this, NRL began to devise means for combating the Japanese radar. Intercept receivers were quickly produced by the Laboratory which were successfully used by the U.S. forces in the Aleutian Island operations. Jamming

devices were also developed for the purpose of denying the Japanese of the usefulness of their radar.

As the war progressed, more intercepted Japanese radar information became available. With the capture of Hollandia, New Guinea, the first sample Japanese airborne radar was obtained. NRL reconditioned this equipment, together with similar equipment captured on Saipan. One radar was installed in a captured Japanese airplane, and its performance was determined. Another equipment was installed in a Navy torpedo plane and used in the Fleet maneuvers rehearsing for the Iwo Jima landings.

Experience with jammers provided opportunity for improving their effectiveness. During the Iwo Jima invasion, many Japanese radar-equipped planes tried to come in and sink our ships, but would suddenly become confused and turn back after our jammers were turned on.

## ELECTRONIC COUNTERMEASURES

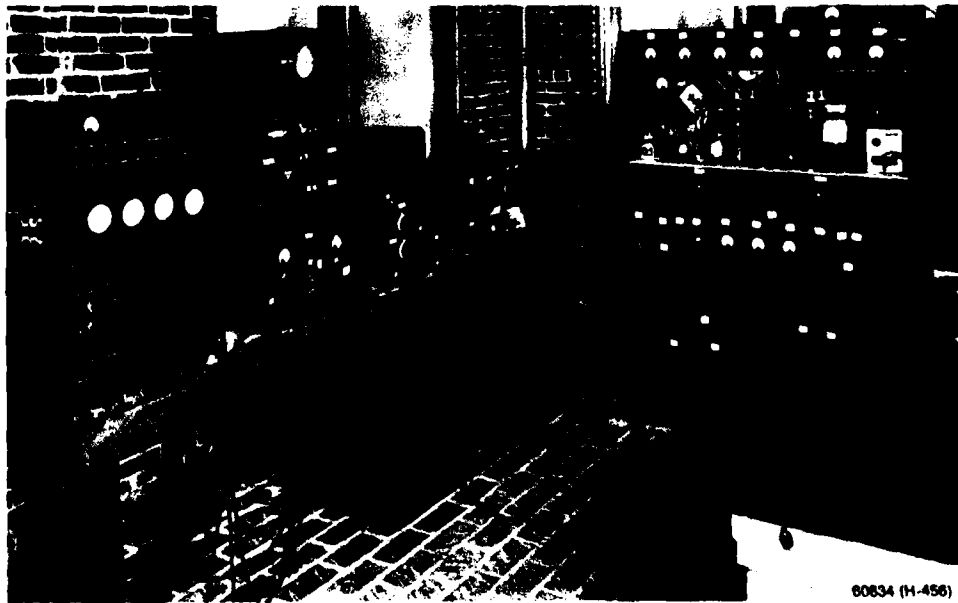
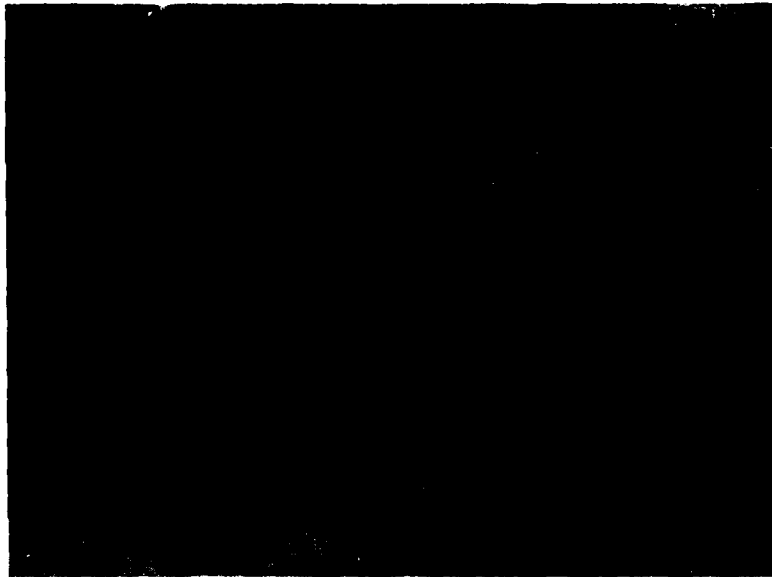

### FIRST JAPANESE RADAR CAPTURED BY U.S. FORCES

This radar, of the search type, was captured at Guadalcanal. Shown above is the antenna; below it is the transceiver and display equipment. The radar had a frequency range of 87 to 105 MHz, with 3-kW pulses and a range on aircraft of 60 miles. It was of poor design, large and heavy. It had no duplexer. The lower half of the antenna was used for transmitting, the upper half for receiving.

## ELECTRONIC COUNTERMEASURES

The first samples of Japanese fire-control radars were captured on Saipan and Peleliu. NRL investigated these equipments, and the results obtained enabled our bombers to take appropriate evasive action. This, together with the use of confusion devices called "window," resulted in Japanese antiaircraft gunfire becoming extremely erratic.

### POSTWAR ELECTRONIC COUNTERMEASURES

The Laboratory's experience during the war made evident the importance of electronic countermeasures in Naval operations and the need for continued research and development in this field to fully exploit its potentialities. Accordingly, after the war, NRL established a major program to provide new techniques and systems of signal interception, signal-source location, signal recording, signal analysis, jamming, and deception. In carrying out this program, NRL became the principal organization in the United States conducting such research programs. The many important advances made and their adoption by the Navy and other military services brought to NRL national and international recognition of leadership in electronic countermeasures. Much of the electronic-countermeasures equipment used by the several military services is based on NRL's work.

### HIGH-FREQUENCY INTERCEPT AND DIRECTION FINDING

The evolution of the lower frequency radio direction finder and the impact of its countermeasures aspect on warfare were reviewed under "Radio Navigation," Chapter 7. The advent of radar brought about the development of pulse-navigation systems such as Loran, which were found, in general, more acceptable than the direction finder for navigational purposes. The direction finder then became primarily a countermeasures device.

After World War I, when high frequencies

became operationally available, submarines could transmit messages over very long distances to home base not previously possible at the lower frequencies, due to lack of installation space for the high-power, lower frequency transmitters. From a countermeasures viewpoint, it became important to have direction finders effective at high frequency to locate enemy submarines. NRL and others had attempted to obtain satisfactory direction-finder performance at high frequencies by using antenna structures similar to those devised for the lower frequencies, but encountered unacceptable bearing errors. NRL eventually observed that bearing errors could be greatly reduced by using a structure employing two opposed vertical dipole spaced antennas, with the receiver placed directly at the midpoint between the two sets of dipoles. The antenna and receivers had to be adequately elevated and without external metallic connections. The whole structure had to be remote from the immediate vicinity of metallic objects.

As a result, NRL was first to develop a high-frequency direction finder which gave bearings of operationally acceptable accuracy (1936).<sup>13</sup> Direction finders of this type were produced in considerable numbers, NRL furnishing an initial quantity of twenty. They were installed along the Atlantic and Pacific coasts and in Oahu, Hawaii. During World War II the Atlantic chain of direction finders extended from Iceland to the middle of South America. Additional direction finders were installed in the Pacific. The radio direction finder, both shore station and ship, had a major part in defeating the German submarine menace and also helped, although to lesser degree, in dealing with Japanese submarines. Some of these direction finders remained in service for many years. In NRL's original high-frequency direction finder, known as the Model XAB and later as the Model DT (2500 to 30,000 kHz), the operator stood on a platform at the top of a quadripod tower support structure to operate the controls. The operator had to move around as the opposed dipole structure was rotated,



## ELECTRONIC COUNTERMEASURES



### **THE FIRST HIGH-FREQUENCY RADIO DIRECTION FINDER PROVIDING BEARINGS OF OPERATIONALLY ACCEPTABLE ACCURACY (1936)**

This direction finder, developed by NRL, was known as the Model DT. A chain of these direction finders was installed from Iceland to central South America and in the Pacific. These equipments gave valuable service in the antisubmarine campaign during World War II and remained in service until recent years. Shown on the right is Dr. M. H. Schrenk, who as head of NRL's aircraft Radio activities was responsible for the development of the first U.S. airborne radar, the Model ASB. Later he became an associate superintendent of the Radio Division. On the left is shown R. A. Gordon, who became head of NRL's Aircraft Radio Division after the war and participated in many important developments.

to obtain the bearing. In the subsequent Model DY, NRL arranged the operating controls to be brought down into the base of the support structure with nonmetallic shafts for more convenient operation. The base of the structure was enclosed to protect the operator in bad weather. To provide maximum accuracy in the performance of radio direction finders, NRL conducted investigations on site factors affecting accuracy and prescribed standards for shore installations.

### **SHIP HIGH-FREQUENCY RADIO DIRECTION FINDERS**

NRL conducted an investigation with the destroyer USS CORRY (DD 463) to determine the possibilities of using radio direction finders in the high-frequency band aboard ship. Bearing deviations on ionospheric transmissions were found to be so great and variable as to render bearings of little value. However, NRL determined that with proper installation of

## ELECTRONIC COUNTERMEASURES

the direction-finder antenna, operationally useful bearings could be obtained aboard ship on high-frequency ground-wave transmissions (1942).<sup>14</sup> This made possible location of the source of enemy transmissions out to a distance of 200 miles, performance of great importance in attacking enemy submarines. For best results, the antenna had to be mounted on the top of a mast as high as possible, clear of all obstructions, and aligned with the ship's keel line. The shielded loop, instead of the opposed-dipole type of antenna, had to be used. Other electronic equipment such as radars could be mounted on the same mast, but had to be well below the direction-finder antenna. Furthermore, since the deviation varied with frequency, the calibration had to be carried throughout the high-frequency band.

The results of NRL's work led to the development of the Model DAQ high-frequency direction finder, the first of its type for ships, by a contractor; NRL participated in this effort (1943).<sup>15</sup> The antenna of this direction finder was of the nonresonant, fixed, shielded-loop type, and of considerable size to enhance its signal-collecting power. A remote goniometer rotating synchronously with the magnetic-deflection structure about the neck of a cathode-ray tube produced instantaneous bearing displays of the received signals. This type display was advantageous for short transmissions and for operators having minimum training. Large numbers of the Model DAQ high-frequency direction finder were produced and installed on Navy ships, where they were employed with great effectiveness against enemy submarines and in other functions.

A series of high-frequency direction finders having novel features for use in both ship and shore installations was developed. NRL took part in this effort. The Model DAQ was the first of the series for shipboard use. The Model DAJ (1942) was for shore stations (1500 to 30,000 kHz). The Model DAR (1942) was originally a British development, modified by NRL (1000 to 20,000 kHz). NRL provided it with a display having two parallel vertical lines to be matched

60834 (H-463)

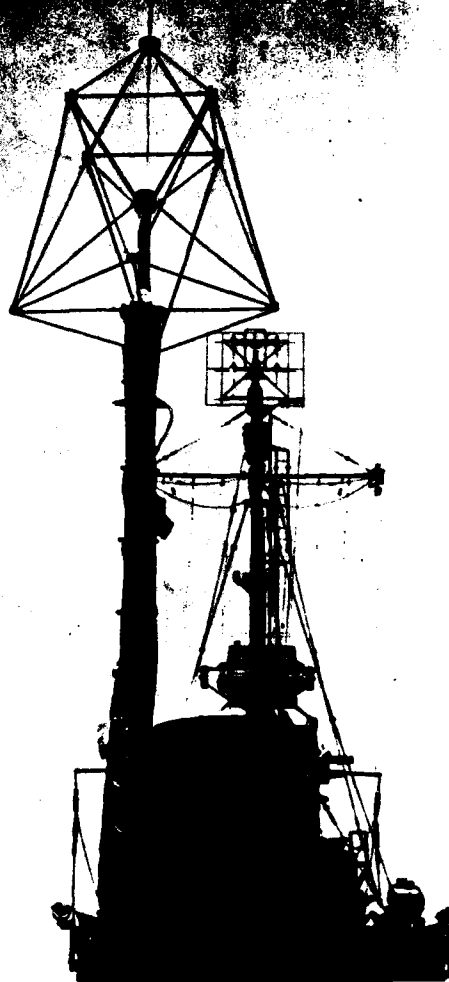

**SHIPBOARD INSTALLATION OF EXPERIMENTAL HIGH-FREQUENCY DIRECTION FINDER**

A fixed cross-loop high-frequency direction finder antenna is shown here mounted on the top of the after mast of the destroyer USS CORRY, which was used by NRL in its investigation of high-frequency direction-finder accuracy possible aboard ship.

## ELECTRONIC COUNTERMEASURES

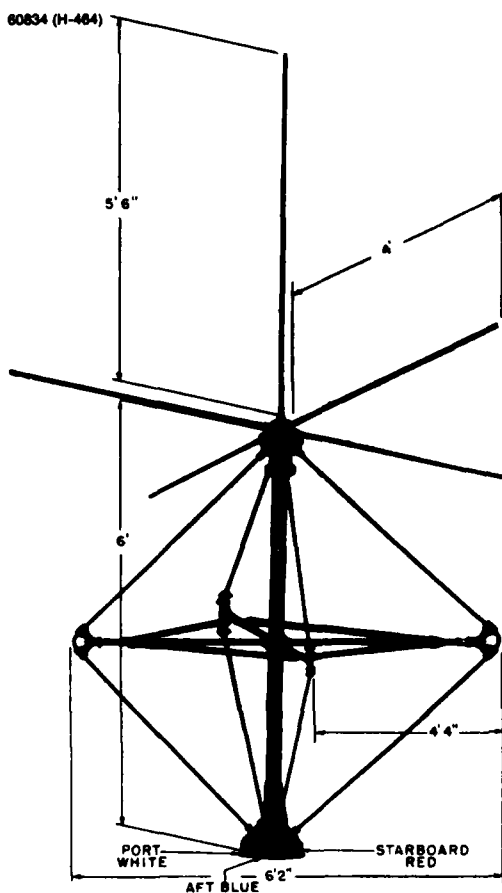

**THE FIRST U.S. HIGH-FREQUENCY SHIP DIRECTION FINDER EMPLOYING FIXED CROSS-LOOP ANTENNAS, WITH BEARING DISPLAYED ON A CATHODE-RAY TUBE THROUGH THE USE OF A ROTATING GONIOMETER AND A SYNCHRONOUSLY ROTATING MAGNETIC DEFLECTION YOKE ABOUT THE TUBE (1943)**

This direction finder, the Model DAQ, was developed collaboratively by NRL and a contractor. It was procured in large numbers and extensively installed on Navy ships, where it was employed with great effectiveness against enemy submarines. The antenna is shown on the left, and the display equipment is on the right.

in height on a cathode-ray tube. NRL had previously developed this display for the lower-frequency Model DAH direction finder. The Model DAU (1943), for ship use, was similar to the Model DAQ, but modified to have a panoramic adapter of  $\pm 7.5$  kHz range (1.5 to 22 MHz). The Model DAW (1944) was similar to the Model DAQ, but truck mounted for mobile use. The Model DBA (1944), for ship use, had

a continuously rotating resonant shielded loop, much smaller than the previous fixed untuned loops (1.5 to 30 MHz). Remote control was provided for it, so that the loop could be tuned in its location to obtain the gain provided by resonance. The Model AN/GRD-6 (1951) was for shore use, for which NRL provided an improved eight-element antenna system to reduce octangular error (2 to 32 MHz). The system used

## ELECTRONIC COUNTERMEASURES

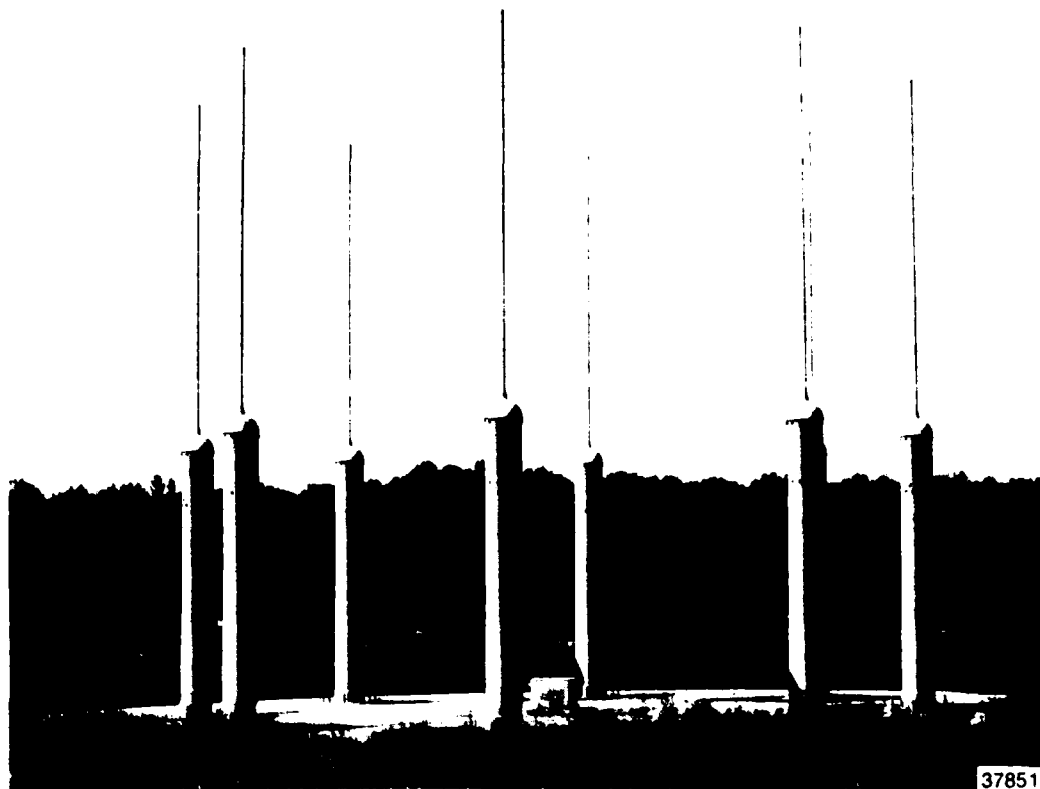

THE AN/GRD-6 IMPROVED HIGH-FREQUENCY DIRECTION FINDER ANTENNA SYSTEM(1958)

NRL developed self-sustaining broadband sleeve antennas to greatly reduce the octangular error of this direction finder.

sleeve broadband self-sustaining antennas which the Laboratory had developed.<sup>16</sup>

### WIDE-APERTURE, CIRCULARLY DISPOSED DIRECTION FINDER

During the early 1950's NRL conducted experiments to determine the improvement in high-frequency direction-finder bearing accuracy that could be obtained if a wide aperture were used.<sup>17</sup> A series of loops extending in a line 1100 feet long was installed at the Laboratory's Fox Ferry, Maryland, site, a short distance south of the Laboratory. The loops, connected with a phasing arrangement, permitted only limited azimuth steering, but sufficient to permit focusing on a

transmitting station 1200 nautical miles distant and to determine variations in bearing. Observations were made in the high-frequency band on "burst type" low-power transmissions to determine bearing variations under typical ionospheric conditions. Although operational siting and instrumentation lacked the desired precision, bearing accuracy of 0.25 degree was obtained, a value many times better than that obtained with earlier direction finders.

Based upon the experimental results obtained, NRL developed the first U.S. wide-aperture, circularly disposed radio direction finder to provide high bearing accuracy (1957).<sup>18</sup> With this direction finder, NRL was first to determine the orbit of a manmade satellite, the

## ELECTRONIC COUNTERMEASURES



**EXPERIMENTAL HIGH-FREQUENCY WIDE-APERTURE RADIO  
DIRECTION FINDER ANTENNA**

With this antenna, NRL was first to demonstrate the capability of a wide aperture to greatly improve high-frequency direction-finder accuracy over earlier types of direction finders (1952). The direction finder used a series of loops extending in a line 1100 feet long.

first Russian satellite, Sputnik I (4 Oct. 1957), using both bearing and doppler information (20 MHz). NRL's direction finder has since been widely used. The antenna system comprised a circle of NRI-developed broadband sleeve antennas arranged in front of a vertical circular reflector screen. The vertical antennas were connected through transmission lines to a rotating goniometer located at the center of the antenna system. The bearing output was displayed on a cathode-ray-tube indicator. Through the antenna scanning function, all signals received at the particular frequency were automatically displayed on the indicator about the entire azimuth.

NRL also was first to provide multiplexing on a single direction-finder antenna system, so that several operators could observe independently the bearings of signals sim-

ultaneously on several frequencies (1958).<sup>10</sup> Each operator, provided with separate cathode-ray-tube consoles, could observe a signal on any bearing at any frequency in the high-frequency band.

NRL was first to devise a digital counter technique to avoid the inaccuracies incurred in taking the bearing of a signal with a mechanical alidade from the conventional indication on a cathode-ray tube (1958).<sup>19</sup>

The shaft of the goniometer carried a magnetic gear with teeth which produced pulses, the digital count of which began at north. The pulse generator controlled by the operator produced a "pip" superimposed on the cathode-ray-tube display, the count of which varied with the signal azimuth, beginning at north. The operator adjusted the pip to coincide with the

## ELECTRONIC COUNTERMEASURES

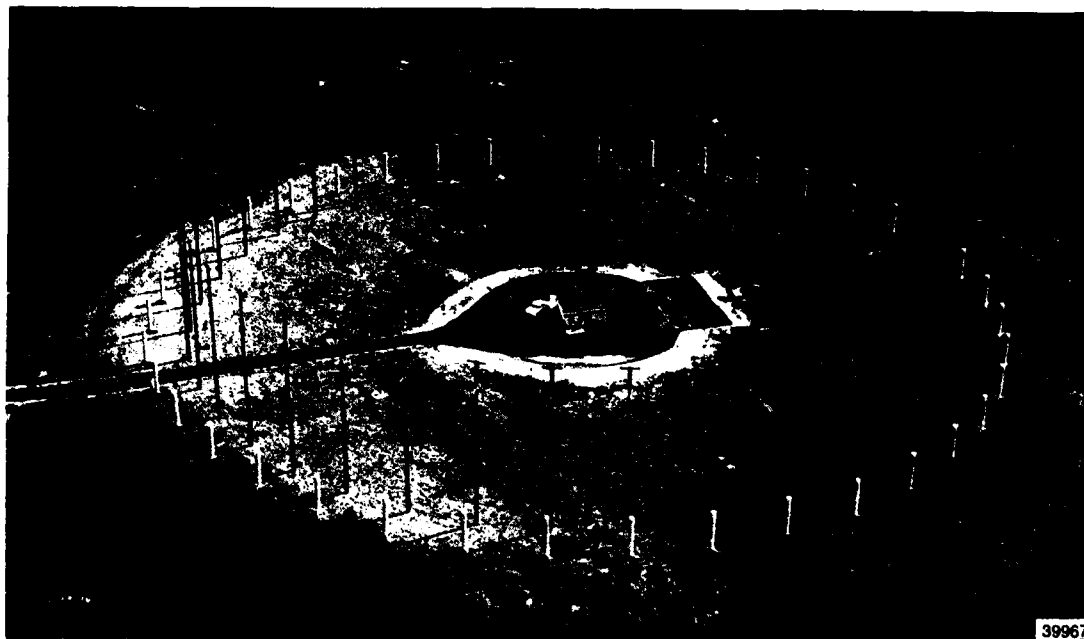

**WIDE-APERTURE CIRCULARLY DISPOSED HIGH-FREQUENCY RADIO DIRECTION FINDER**

NRL was first in the United States to develop a high-frequency direction finder of this nature, to provide greatly improved direction-finder bearing accuracy. The direction finder shown was 400 feet in diameter and was installed at NRL's Hybla Valley, Virginia site. With this direction finder, NRL was first to determine the orbit of a man-made satellite, the Russian Sputnik I (1957). This type of direction finder has been widely used.

cathode-ray indication, taking advantage of the more accurate alignment which could be obtained through offsetting and enlarging the display. When the goniometer bearing count equaled the pip count, the bearing was automatically extracted accurately in digital form and transmitted to the central computer for position determination. Later, this technique was extended by sending all of the video information on the cathode-ray tube to a computer, which determined the direction of arrival.

To determine the position of a transmitting source in a radio direction-finder system, it is necessary to obtain bearings on the same signal at separate geographic points, so that cross-bearings can be plotted or computed in determining the position of the source. However, the conventional manual process was slow and required a high degree of skill obtained through

long training of operating personnel. **NRL was first in the U.S. to devise a radio direction-finder system utilizing an electronic computer to determine automatically the position of a radio signal source through computations from data automatically transmitted from several direction-finder sites to a central computation site (1958).**<sup>20</sup>

High reliability is an important factor in certain uses of electronic computers, particularly those for military purposes, of which radio signal source location is one. In the computer field, high reliability had been achieved through the use of back-up computers to provide the downtime necessary for servicing. This arrangement resulted in a great deal of idle computing capacity. In providing a computer for signal-source location, NRL had to contend with data to be processed from several direction-finder

## ELECTRONIC COUNTERMEASURES

sites for several functions, including that for the identity and association of signals. Computations had to be applied to selected combinations of data, involving multiple programming. With these considerations in view, NRL was first to develop, with the aid of a contractor, a polymorphic multiprocessor computer system which provides, in radio signal source location, high reliability together with minimal redundancy (1965).<sup>21</sup> The very high reliability of the system is provided at modest cost by dynamically restructurable assemblies of autonomous processor, memory, and input modules. Furthermore, the redundant hardware can be used more easily in this system than by a replicated monolithic system in the performance of useful functions beyond those absolutely required. With NRL's system, designated the AN/GYK-3 (V), the redundant hard-

ware amounts to about half that required for operation at maximum allowable degradation, contrasted with the redundancy ratios of one or two for replicated monolithic systems previously used. NRL's system is widely used in the computer field.

NRL's first wide-aperture, circularly disposed antenna had a single circle of dipoles. However, additional concentric rings of NRL-developed sleeve antennas are used if the highest degree of bearing accuracy over the full high-frequency band is required. As many as three sets of such concentric rings of dipoles have been used for ultimate accuracy over the full band, limited only by ionospheric propagation factors.

NRL's wide-aperture antenna system has also been found useful for radio-communication reception in the high-frequency band. The sharp beam provided by the antenna at any azimuth and

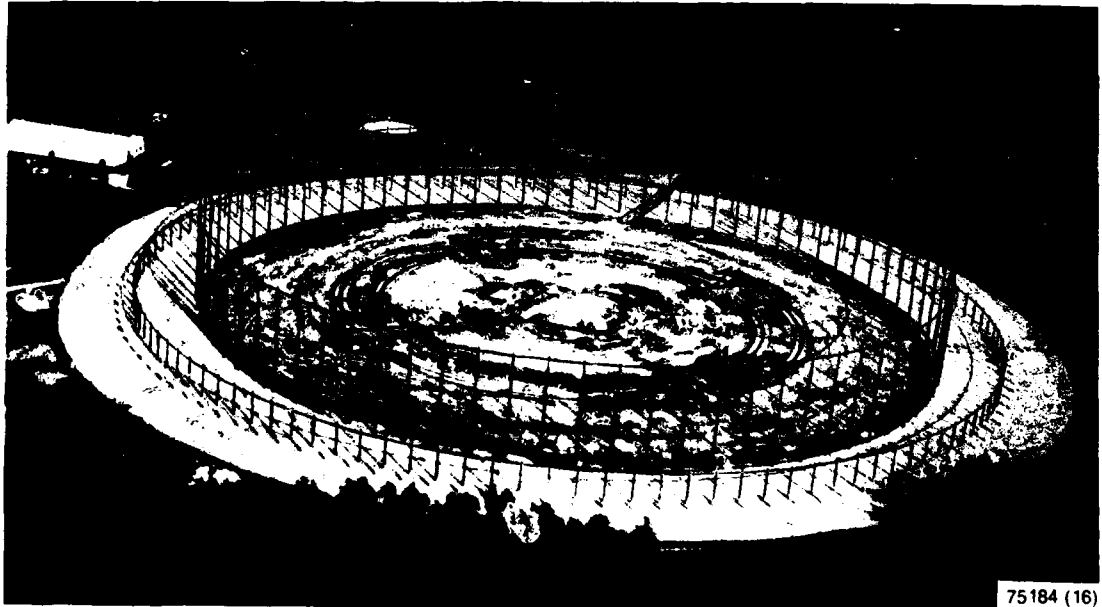

THE WIDE-APERTURE, CIRCULARLY DISPOSED HIGH-FREQUENCY ANTENNA AT THE NAVY'S RADIO COMMUNICATION STATION AT SUGAR GROVE, WEST VIRGINIA

The sharp beams which are available with this antenna greatly reduce interference from unwanted signals on the same frequency but coming from a different direction. The antenna has two sets of dipoles arranged in front of two reflector screens. It has an effective diameter of 800 feet (outer portion), with an overall diameter of 984 feet for the ground mat.

## ELECTRONIC COUNTERMEASURES

at any frequency in the band permitted great discrimination against interference at azimuths other than the one being used.

### BEARING DIRECTION FINDER CALIBRATION WITH A SATELLITE

NRL was first to use a satellite transmitting signals in the high frequency band to determine the performance of a bearing direction finder and its site, including the effects of nearby mountains (1966). The satellite was flown at low altitude, below the F layer, so that an essentially free-space path would be available at night. Thus, nocturnal observations could be made on performance free from errors caused by propagation factors. Comparison of these observations with those made during daytime when the E layer was present indicated that the E layer was relatively stable.

### AIRBORNE VHF-UHF-SHF INTER- CEPT AND DIRECTION FINDER SYSTEMS

During World War II, great difficulty was experienced in developing VHF and higher

frequency direction finders for installation in aircraft. At these frequencies, airframe surface contours caused severe antenna-pattern distortion and prevented obtaining of operationally useful bearings. Later, as the cold war evolved, the Navy was in need of such direction finders for radar intercept in its European "Ferret" aircraft program. NRL developed several direction finders, which provided, for the first time, operationally acceptable bearing accuracy in aircraft in the VHF band and were used by the Navy in the Ferret aircraft program (1950-1951).<sup>22</sup> Antenna-pattern distortion in aircraft was avoided by mounting them well below the wing of the aircraft. Three of these direction finders used rotating dipoles, with signal direction indicated on a cathode-ray tube, the minimum signal level used to indicate the bearing. These equipments were designated the Models AN/APA-24x (XB-1), which covered a range of 50 to 100 MHz (1950); AN/APA-24x (XB-2), with a range of 50 to 140 MHz (1951); and the AN/APA-24x (XB-3), with a range of 142 to 280 MHz (1951).

At the end of the war, NRL conducted an investigation of the probability of intercepting enemy radar signals with direction finders

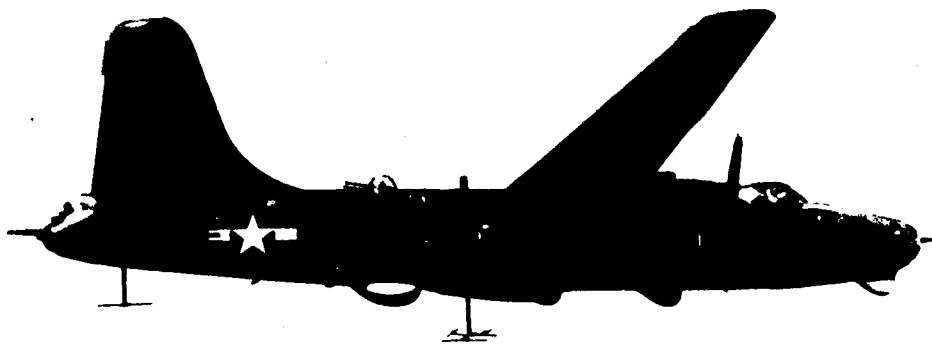

60834 (H-466)

### "FERRET" AIRCRAFT VHF DIRECTION FINDERS (1950-1951)

These NRL-developed direction finders provided, for the first time, operationally acceptable bearing accuracy in aircraft in the VHF band. They were used effectively in the Navy's European "Ferret" aircraft program. The Model AN/APA-24X (50-280 MHz) antenna is shown at the left, extending below the tail of the type P4M aircraft. The Model AN/ARD-6 (55-90 MHz) antenna is shown extending below the middle of the fuselage.



## ELECTRONIC COUNTERMEASURES

which rotated.<sup>23</sup> Since radar signals are intermittent, it is possible to miss a short transmission during part of the rotation period of such direction finders. NRL came to the conclusion that 100-percent probability was necessary, and to attain it, all-around-looking direction finders with instantaneous response to signals coming from any azimuth angle would have to be provided. In providing for the Navy's Ferret program, NRL developed the first VHF airborne direction finder which could display instantaneously and simultaneously both bearing and frequency of intercepted radar signals over a broad frequency band (1951).<sup>22,24</sup> This direction finder, designated the Model AN/ARD-6 (XB-1), covered a range of 55 to 90 MHz. It had four fixed antenna arrays, pointing in the four directions, to cover 360 degrees. The antennas were connected through circuitry to the four deflection plates of a cathode-ray tube. Ten receivers were used to cover the frequency band for the display of the frequency of the received signals on a cathode-ray tube. After the Navy used this direction finder in its Ferret operations, it turned the direction finder over to the Air Force for further

development. NRL developed the first airborne direction finder capable of simultaneously displaying signals from submarine radars coming from any direction and at any frequency in the band 10,000 to 100,000 MHz (1954).<sup>25</sup> This equipment, designated the Model NL/ALD-A, was procured in quantity by the Navy and installed on its ASW aircraft. This equipment allowed aircraft searching for submarines to detect radar signals, regardless of attempts to make these signals extremely short in duration, and to be in a position to home on them, pressing the attack with minimum delay. In addition to fulfilling its primary function, ASW, this equipment was an excellent warning device against airborne or ground-controlled gun-laying radars, because of its wide-open and instantaneous features. The equipment employed two sets of four horn-type antennas, which were mounted on a cylindrical ground plane having its axis vertical. The horn antenna elements were dis-

posed at 90-degree intervals for all-around coverage. The amount of electromagnetic field energy received by each antenna was a function of the azimuth angle of arrival of the energy. The bearings were displayed on a cathode-ray tube.

### SUBMARINE VHF-UHF-SHF INTERCEPT AND DIRECTION-FINDER SYSTEMS

During the war in the Pacific, the Japanese used VHF and UHF radars to search out U.S. submarines and attack them. To provide protection against this Japanese radar threat, NRL developed the first submarine VHF-UHF intercept and direction-finder system (1944).<sup>26</sup> The system was installed and demonstrated on the submarine USS PIKE in July 1944, with satisfactory results. This system, designated the Model XCV and later the Model DBU, covered a frequency range from 100 to 1000 MHz. The system utilized two sets of broadband antennas, arranged at an angle of 45 degrees with the vertical so as to be effective for both vertically and horizontally polarized radiation, as well as to cover the frequency band adequately. The antennas were mounted on the sides of the submarine as clear of obstructions as possible. The direction-finding feature involved swinging the antennas, switching alternately between the two sets of antennas for the equipment to determine the bearings of the signals.

The frequency range of the system was extended by another set of antennas, so as to cover the range from 100 to 10,000 MHz.<sup>27</sup> This modification was designated the Model XCY, and later the Model DBV. The modification was installed and demonstrated on the submarine USS DENTUDA and the USS SKATE with satisfactory results.

After the war, the need continued for an operationally suitable microwave submarine direction finder to take bearings on radar-equipped ships and aircraft at distances well

ELECTRONIC COUNTERMEASURES

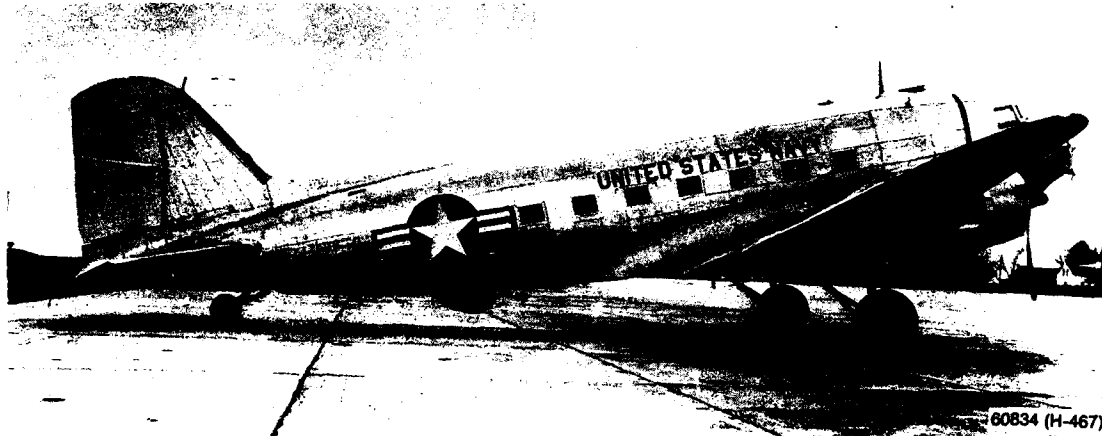

FIRST MICROWAVE INSTANTANEOUS ALL-AROUND-LOOKING DIRECTION FINDER, MODEL NL/ALD-A, 2200 to 10,000 MHz (1954)

This equipment, developed by NRL, was procured in quantity by the Navy and installed on its ASW aircraft to intercept and determine the direction of enemy submarine radar signals. Above is shown the antenna as mounted in a radome on the bottom of the fuselage of an R4D aircraft. Below are shown the elements of the equipment.

## ELECTRONIC COUNTERMEASURES

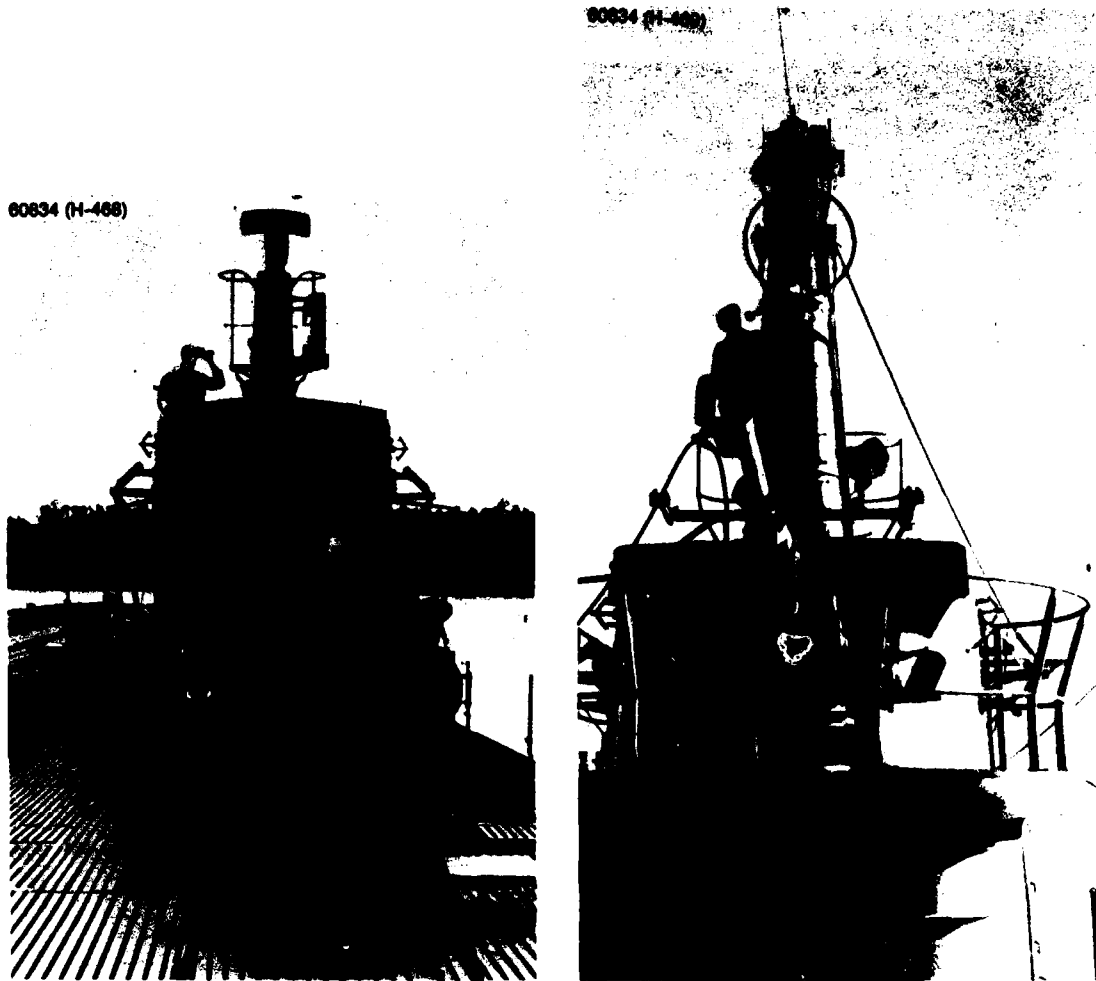

### FIRST SUBMARINE VHF-UHF RADAR INTERCEPT AND DIRECTION-FINDING SYSTEM (1944)

This system was developed by NRL to protect our submarines against attack by Japanese aircraft in the Pacific during the war. The two sets of antennas for this system covering 100 to 1000 MHz are shown on the left, installed on the sides of the submarine USS PIKE (Model XCV). The antennas for the 2000 to 3500 MHz range are shown at the right, inside the circle, as installed on the submarine USS SKATE (Model XCY).

beyond radar range. This required that the direction-finder system have enough sensitivity and a high enough probability of intercept so that the submarine could detect enemy radars at several times radar range. It was necessary that the direction-finder antenna be mounted

in a high, unobstructed position on the submarine and be capable of withstanding the hydrostatic pressure experienced at considerable depths. To meet the Navy's requirement, NRL developed the first microwave direction finder with automatic bearing indication

ELECTRONIC COUNTERMEASURES

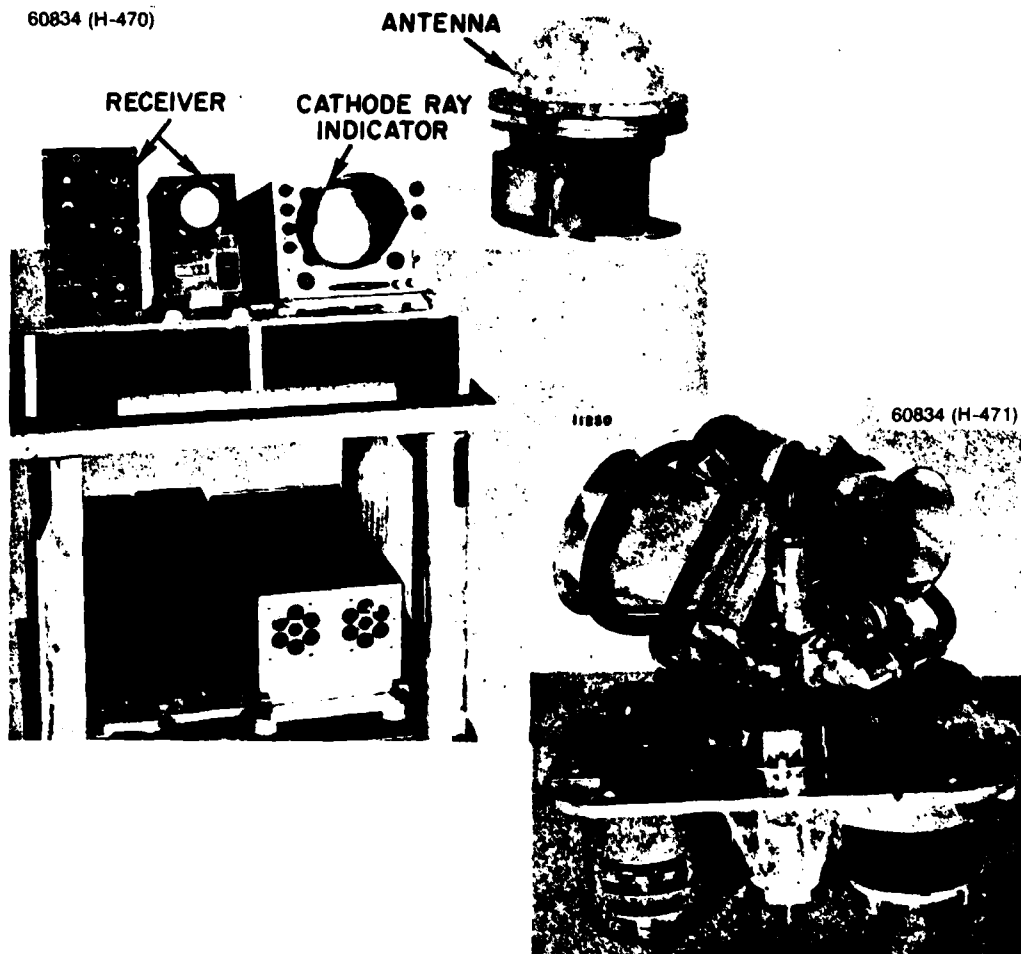

THE FIRST SUBMARINE MICROWAVE DIRECTION FINDER WITH AUTOMATIC BEARING INDICATION, MODEL AN/BPA-1 (1948)

This NRI developed direction finder was first demonstrated on the submarine USS IREX. It was procured in quantity and installed for service on submarines. At left are shown the components of the equipment. At right is shown the antenna structure with the dome removed. The two larger horns on the left are fed as an array to cover the band 2300 to 5000 MHz. The single horn on the right covered 5000 to 10,600 MHz. The antenna system rotated at rates up to 700 RPM.

## ELECTRONIC COUNTERMEASURES

suitable for submarines (1948).<sup>28</sup> Its performance was demonstrated on the submarine USS IREX (SS 482) in 1949. It was subsequently procured and installed in submarines for service use. The direction finder had a frequency range of 2300 to 10,600 MHz and was designated the Model AN/BPA-1. It was provided with a horn-type antenna system. Two larger horns fed in phase as an array served to cover the band from 2300 to 5000 MHz. A single smaller horn covered the band from 5000 to 10,600 MHz. The antennas were so arrayed as to be capable of receiving both horizontally and vertically polarized waves. They were rotated at rates up to a maximum of 700 rpm. The bearings were presented automatically on a cathode-ray tube.

Until 1958, submarine microwave intercept and direction-finder systems had been devised with antennas located on the conning tower, which made it necessary to expose that part of the submarine when making observations. To meet an urgent Fleet operational requirement for an improved system and at the same time to reduce the exposure of the submarine during interception, NRL developed the first radar intercept and direction-finder system in which the antenna was mounted in a submarine periscope without interfering with the operation of the optical system (1958). Various configurations of NRL's basic system saw wide operational use. NRL's system was first installed on the submarine USS DOGFISH (1958). Since the mission of this ship also required communication intercept, a vertical "sleeve-stub" intercept antenna covering the band from VLF to UHF was provided attached outside, behind the periscope head. The internal antenna provided broad coverage in the gigahertz region. The intercept system was of the "wide-open" crystal-video type, with the video amplifier furnished as part of the equipment. Rotation of the periscope provided the directional function. The special periscope was designated the type 8A (later 8B). The Laboratory furnished six equipments for installation on sub-

marines. Subsequently, the equipments were procured from contractors and installed on many submarines. The system was designated the AN/BLR-6.

### "UNIVERSAL" SHIP RADAR INTERCEPT SYSTEM

During World War II, intercept equipment was developed for such specific frequency bands that experience indicated were used by the enemy. This approach required the use of different equipments for the several frequency bands, but expedited availability for use in combat. Furthermore, except for very-narrow-band frequency scanning, the scanning rates were very slow, which made the probability of missing an enemy signal quite high. The phenomenal growth of enemy electronic applications to military problems during the period after the war, including the cold war and the Korean "police action," served to emphasize the need for advanced intercept capability. To improve this type of operation, NRL developed the first universal integrated radar intercept system for both surface ships and submarines, covering VHF through SHF (50 to 10,750 MHz) with rapid, high-probability frequency scanning (1956).<sup>29</sup> Large quantities of this equipment were procured, with extensive installation in the Naval service. This equipment, known as the Model AN/WLR-1, had a speed of operation such that the rate of signal acquisition, of analysis, and of data storage was limited by operator decision time instead of by equipment characteristics. The equipment had both high resolution and high sensitivity, with capability of analyzing the various characteristics of the received signal.

### SHIPBOARD SHF INTERCEPT RECEIVER-DIRECTION FINDER

In response to an urgent Navy requirement, and as requested by the Bureau of Ships, NRL was

ELECTRONIC COUNTERMEASURES

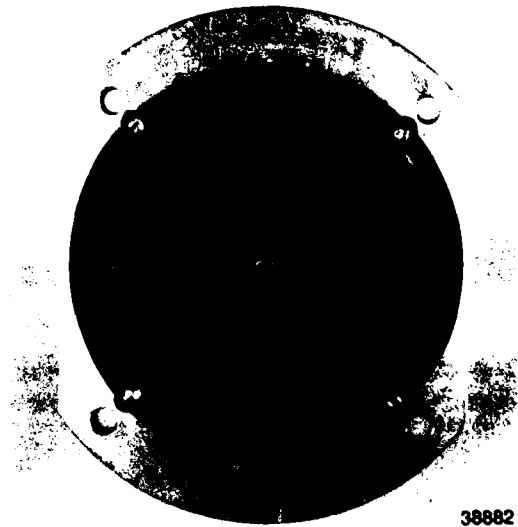
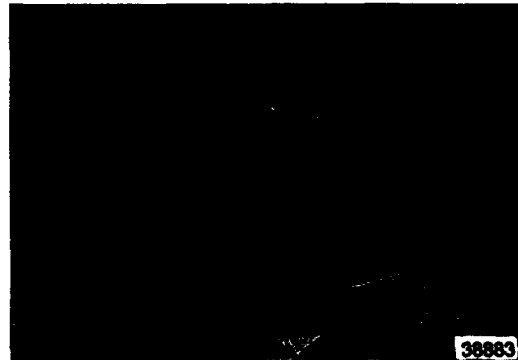
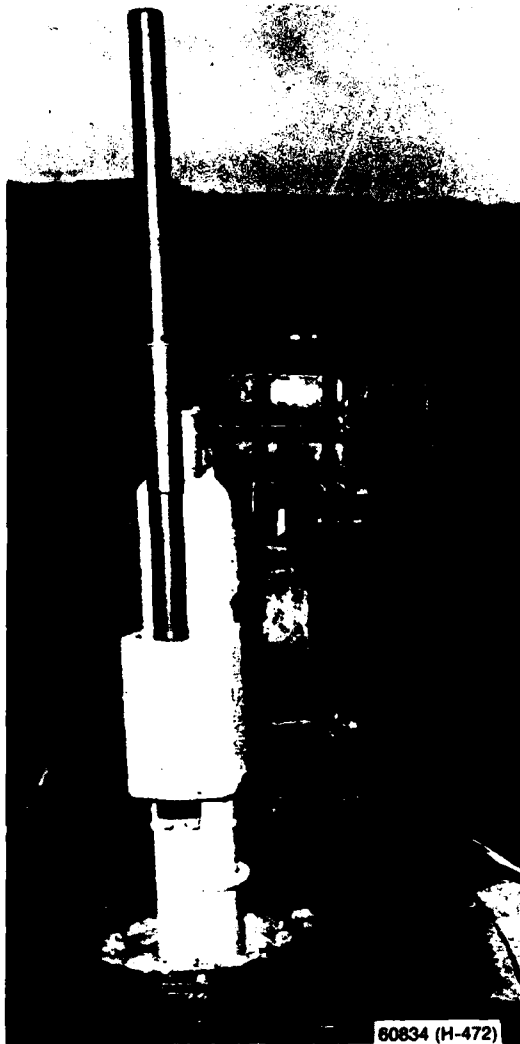

**FIRST RADAR INTERCEPT AND DIRECTION-FINDER SYSTEM MOUNTED IN A SUBMARINE PERISCOPE, MODEL AN/BLR-6 (1958)**

This system, developed by NRL and first demonstrated on the submarine USS DOGFISH (1958), was procured and installed on many submarines. The spiral antenna for microwaves is shown at the lower right. It is mounted in a special window in the upper part of the periscope with the fitting shown at the upper right. At the left is shown the periscope top with an external vertical sleeve intercept antenna to cover VLF through UHF.

## ELECTRONIC COUNTERMEASURES

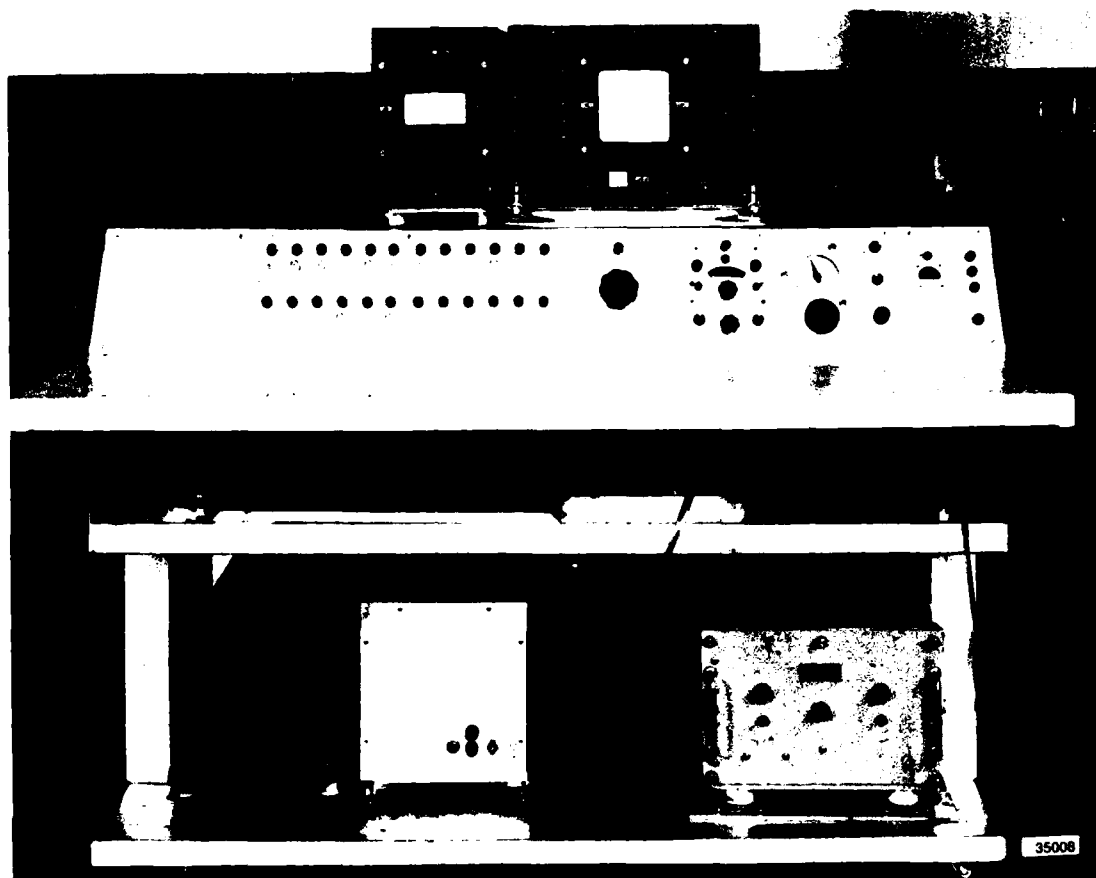

UNIVERSAL SHIP INTEGRATED RADAR INTERCEPT SYSTEM (1956)

NRL developed this system, designated the Model AN/WLR-1, to provide for the first time-integrated intercept coverage of VHF through SHF (50 to 10,750 kHz) with rapid high probability scanning for both surface ships and submarines. Many of these equipments were procured and utilized by the Navy. Shown is NRL's prototype of the equipment without the antennas.

first to develop a shipboard intercept receiver-direction finder which was first to operate successfully at microwave frequencies not previously covered and in the high-power environment of shipboard radars not within the receiver frequency region (1963).<sup>30</sup> NRL's experimental model was successfully demonstrated aboard the destroyer USS HUGH PURVIS (DD709) in 1964. The equipment was designated the Model AN/SLR-12 when pro-

cured, and was installed on many ships. This equipment saw service in southeast Asia. The equipment comprised a crystal-video waveguide-type receiver with a stationary horn antenna illuminated by a rotating reflector which could be continuously spun or remotely trained. High sensitivity was obtained by detecting and pre-amplifying the video signals in low-noise amplifiers in the antenna housing. Interference from out-of-band radars was avoided through the use of

## ELECTRONIC COUNTERMEASURES



**MICROWAVE SHIPBOARD INTERCEPT RECEIVER-DIRECTION FINDER, THE AN/SLR-12 (1963)**

This was the first microwave receiver to operate successfully in a part of the microwave band not previously covered and in the high-power environment of shipboard radars. Production equipment based on NRL's model was installed on many ships and saw service in Southeast Asia. The photograph shows NRL's model as installed on the destroyer USS HUGH PURVIS (DD709), where it was successfully demonstrated.

short sections of reduced-cross-section waveguide preceding the detectors, which acted as high-pass filters attenuating all frequencies below the operating band of the receiver. The directional bearing display was of the polar-cathode-ray-tube type.

### **SHIPBOARD INTERCEPT RECEIVER BLANKING**

The reception of intercept signals aboard ship must contend with the interference pro-

duced by the transmitter pulses of the several local radars when operating at the same time. Since the transmitter pulses are short relative to the interval between them, there is sufficient time to permit "look-through" operation of the intercept receivers. However, the intercept-reception equipment must be capable of withstanding the high power imposed on it and the resulting interference, due to its proximity to the radars. In spite of careful selection of location in siting intercept and radar antennas to minimize mutual coupling, difficulties in simultaneous



## ELECTRONIC COUNTERMEASURES

operation existed. Intercept mixer diodes "burned out," and improved diodes, which could withstand the power level imposed, had to be developed. A major difficulty was the "blocking" of the intercept receiver circuits by the high-power pulses. To avoid this difficulty, NRL devised a means of "blanking" the intercept receiver circuits during radar transmitting pulses, providing, for the first time, intercept signal reception simultaneous with radar operation (1953).<sup>91</sup> In NRL's original system, the radar transmitting pulses were picked up by an antenna and used to operate circuitry which "blanked-out" the video portion of the intercept receiver. This system was found to be limited with respect to the setting of the power level of the blanking, since weak but interfering pulses from a ship's own radars could not be eliminated without also eliminating the intercept signals at that level. NRL met this difficulty by utilizing the energy derived directly from the radar pulse circuitry, via coaxial cable, to the intercept receiver to actuate the blanking. A delay line could be inserted into the trans-

mitter pulse circuitry to compensate for the differences in the pulse rise times of the several radars. NRL's experimental model of this system was installed on board the cruiser USS CANBERRA with satisfactory results (1962). NRL provided another similar blanking equipment installed on the carrier USS ENTERPRISE (1963).

The equipments aboard the USS CANBERRA and the USS ENTERPRISE were especially designed for their particular intercept reception requirements. As a major improvement of the radar interference blanking system, NRL developed a filter-blanker in which the blanking operation was accomplished at intermediate-amplifier frequency instead of at video frequency, the region in which most of the interference occurs (1963). This system avoided the special adaptations required with video blanking in the different ship installations and provided improved interference reduction with installational versatility. NRL's blanking system, designated the Model AN/SLA-10 when

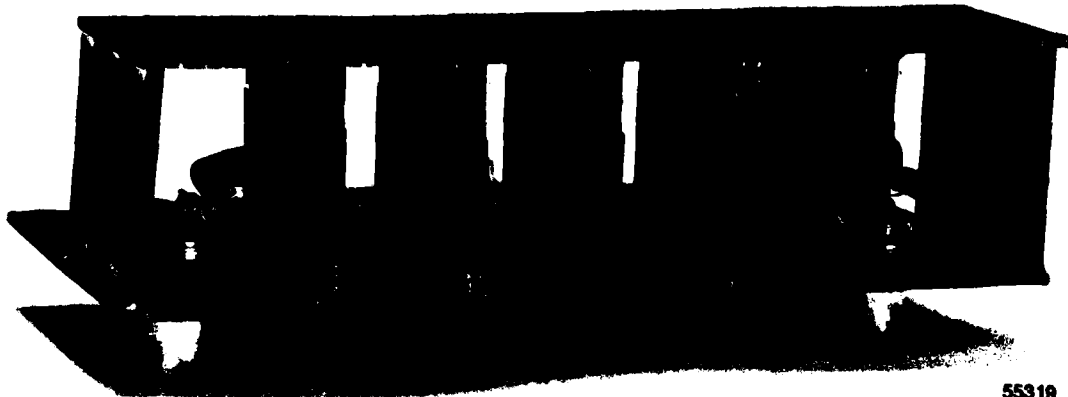

55319

**INTERCEPT RECEIVER RADAR INTERFERENCE BLANKER**

NRL developed the interference blanker which first made feasible intercept receiver "look-through" operation simultaneously with the operation of radars aboard ships (1953). Shown is the final experimental model of the blanker, which provides fully satisfactory operation with installation versatility. The blanker comprises a five-stage low-pass filter with individual diode gates at each stage biased at proper voltage level for adequate blanking. In quantity production, this blanker was designated the Model AN/SLA-10.

## ELECTRONIC COUNTERMEASURES

produced in quantity, was installed on Navy ships responsible for carrying out the intercept function.

### INTERCEPT SIGNAL ANALYSIS

Analysis of the signals emitted by an enemy's electronic equipment is an important means of determining its potential capability. Such analysis also provides the knowledge necessary for devising and applying effective countermeasures against enemy electronic systems. The frequency bands covered, spectral distribution of the emitted energy, modulation type, pulse-repetition rate, pulse length and shape, antenna characteristics, the number of antenna beams, their disposition, horizontal and vertical beam patterns, and their scanning rates, are all of value in assessing performance capability and the potential for devising and applying effective countermeasures. While these characteristics can be determined during the process of interception, further study made possible by recording the signals allows much more accurate and complete appraisal.

During World War II, NRL devised means for analyzing the signals used by the Germans in controlling their guided missiles. The information obtained led to the development of effective countermeasures for these missiles. NRL also developed "fingerprinting" techniques for identifying enemy communication stations through their signal characteristics. With respect to radar, equipments for panoramic spectrum display and analysis of pulses were developed.<sup>82</sup> Due to the urgency in making these equipments quickly available, they had certain limitations which impeded their operation. The analysis and display were dependent upon the reception of signals for relatively long periods of time. The methods used required a number of adjustments by the operator before the various characteristics could be accurately measured. For instance, it was necessary to adjust the sweep frequency of the cathode-ray-tube indicator to synchronize with the repetition frequency of the received radar signal, or to compare the repetition frequency with an audio tone whose frequency was known. Although otherwise

useful, the available techniques were completely inadequate for the analysis of pulse signals of short time duration.

To meet the need for adequate signal analysis, NRL developed the first radar-signal pulse analyzer, which instantaneously and automatically synchronized with the pulse rate of the incoming radar signal and simultaneously displayed the several signal parameters (1948)<sup>83</sup> The design of NRL's original pulse analyzer was the basis on which many subsequent units were built. For this analyzer, NRL developed the first multi-electron-gun cathode-ray tube, which became an important pioneering effort in another aspect (1948). The techniques devised to make the tube's performance satisfactory contributed to the feasibility of the three-electron-gun color picture tube used today in color television sets to generate the three colors, red, blue, and green. The techniques are also used in black-and-white television sets. These unique techniques included shielding the several electron-gun structures from each other to prevent interaction, the use of nonmagnetic materials to prevent electron-beam distortion, a slitting of the gun anodes to prevent their distortion during the high-temperature tube-exhaust process and malformation of the electron beams, and the use of a rectangular shape for the glass envelope of the tube to maximize the display area. NRL's tube used five guns, and its analyzer produced five lines of display, one for short and one for long pulse lengths, one for low and one for high pulse-repetition rates, and one for non-linear signal display. Provision was made for photographically recording the display. When procured in quantity, the shipboard version of NRL's signal analyzer was designated the Model AN/SLA-1 and the airborne version the Model AN/APA-74. These analyzers were followed by a series of models with some modifications, such as the AN/ULA-2 (1963).

### SIGNAL RECORDING

During the war, signal-recording devices available used magnetic steel wire, steel tape,

## ELECTRONIC COUNTERMEASURES



or paper tape with a magnetic coating as recording media. NRL's investigation of two captured German tape recorders disclosed their use of tape with magnetic coating on an acetate film base, very similar to tape in wide use today. This tape was found to have superior qualities, including high signal-to-noise ratio, low residual noise, and smoother and more uniformly distributed magnetic particles. The results of this investigation led to NRL's development, with the aid of a contractor, of the first U.S. recorder for signal recording featuring acetate film base magnetic tape, multispeed, multitrack, tape synchronous capstan drive, phase equalization, and extremely wideband frequency response, particularly

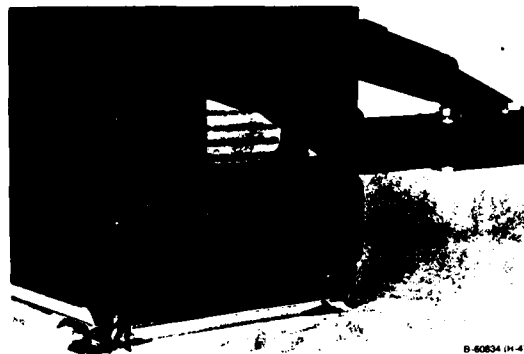

### RADAR SIGNAL ANALYZER

NRL developed the first radar signal analyzer which instantaneously and automatically synchronized with the pulse rate of the incoming radar signal and simultaneously displayed the several signal parameters (1948). Present-day signal analyzers are based on NRL's original analyzer. An important feature of the analyzer is its five-gun cathode-ray tube, the first such tube to be developed (left). The techniques devised by NRL which made this tube possible were later the basis for the three-electron-gun color picture tube used in color television sets today. The techniques are also used in black-and-white television set picture tubes. The analyzer, designated the AN/SLA-1, shipboard version (airborne version was the AN/APA-74), with camera mounting for photographic recording, is shown on the right.

with respect to very low frequencies (1949).<sup>34</sup> This recorder was designated the Model IC/VRT-7. Its features were found attractive for use in many related items for a long period.

In recording signals, a tremendous quantity of tape can quickly be used if measures are not taken to limit recording to signals of particular interest. Such a volume of tape would involve severe problems of storage, selections for analysis, and high cost. However, a certain period of observation is required to determine whether a particular signal is of interest, and if it has not been recorded, the information is lost. In dealing with this problem, NRL was first to develop a short-term, continuous, signal-storage device to hold a signal for a period

ELECTRONIC COUNTERMEASURES

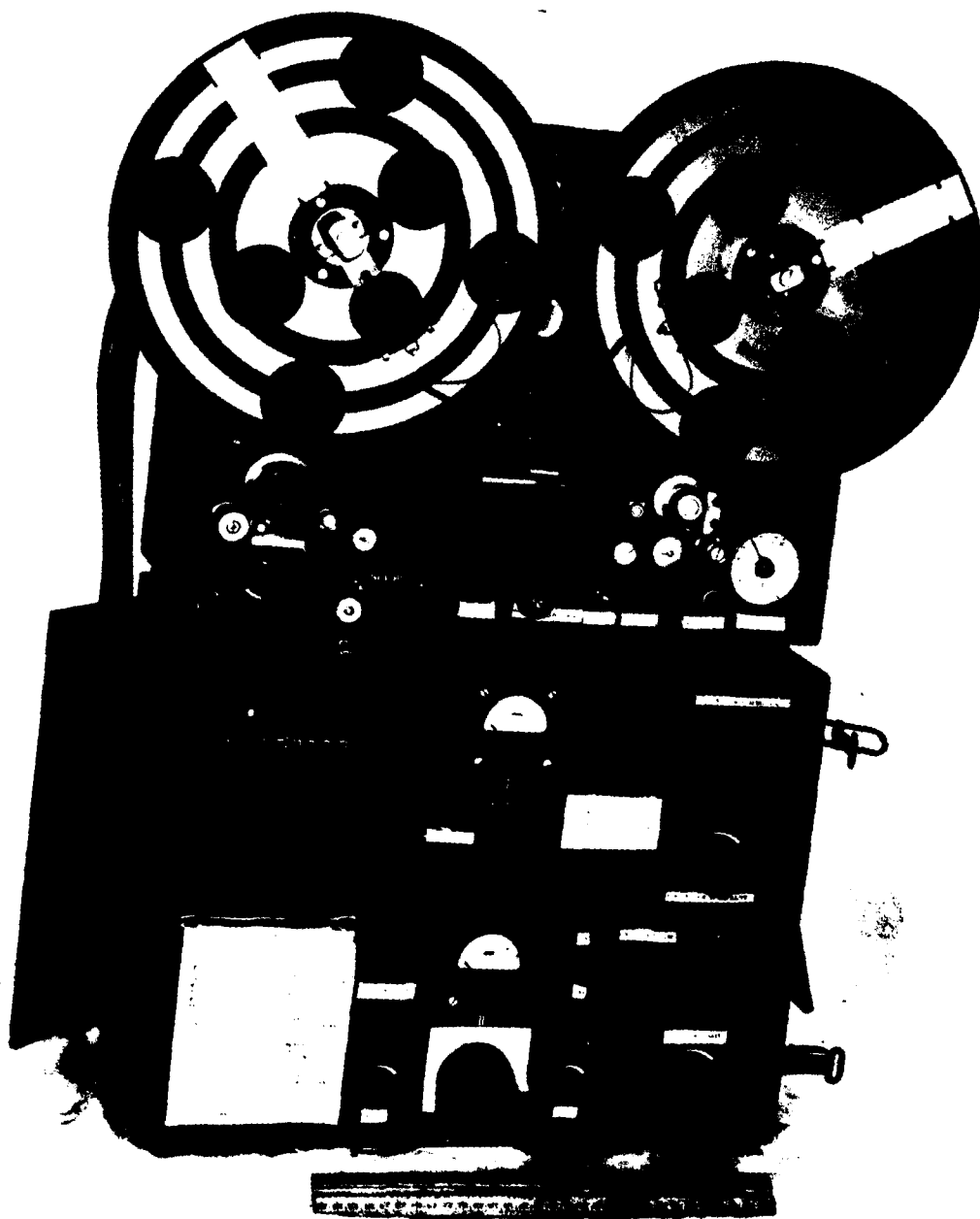

**WORLD WAR II CAPTURED GERMAN TAPE RECORDER**

60834 (H-476)

*This recorder was found to be of advanced design, using tape with a magnetic coating on an acetate film base very similar to the tape in wide use today. It had high reproduction quality.*

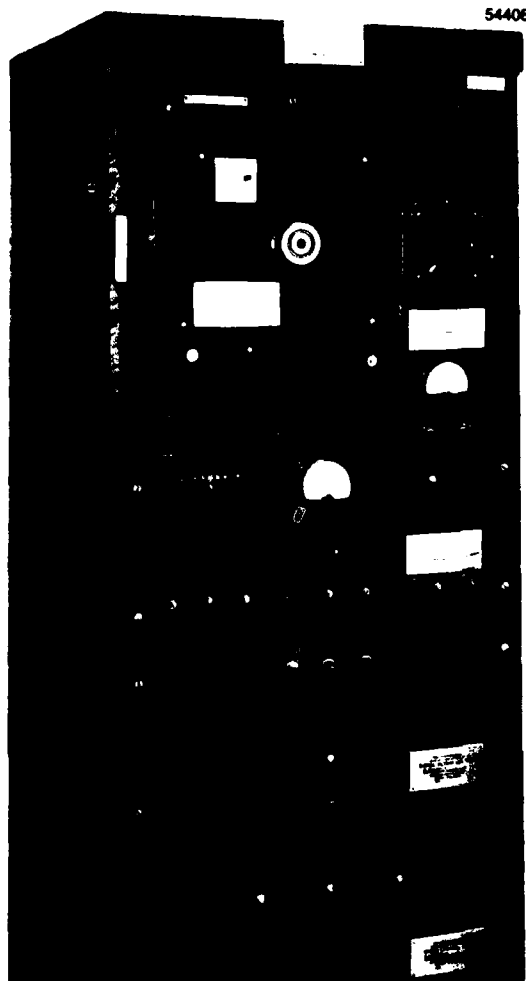

FIRST U.S. SIGNAL RECORDER WITH ACETATE  
FILM BASE TAPE (1949)

This recorder, developed by NRL, featured multispeed, multitrack, tape synchronous capstan drive, phase equalization, and extremely wideband frequency response. Designated the Model IC VRT<sup>7</sup>, it was the forerunner of a series of similar recorders used extensively.

of time sufficient for evaluation, comprising a rubber belt impregnated with magnetic particles and mounted on a drum for continuous recording. The signals could then readily be transferred to magnetic tape for

permanent recording upon recognition of their value (1951).<sup>35</sup> Over the period of years until 1968, NRL developed belt material of much higher quality than existing materials, which did not meet Navy requirements. The new material also had long life, with greater dynamic range, and avoided the long-standing problem of output-amplitude variations. The equipment provided a recording time of up to three minutes, which was found adequate to assess the value of the recorded information for transfer to magnetic tape. NRL's experimental model was followed by the Models AN/FSH-1, AN/FLR-<sup>7</sup> drum recorder, and AN/FSH-5. The AN/FSH-1 was the first of a family of long-life, unattended, magnetic drum recorders for signal recording and analysis. Four analog channels of information were handled simultaneously. The AN/FLR-<sup>7</sup> drum was an extension of the AN/FSH-1 principles to 150 information channels. The AN/FSH-5 was an extension of the AN/FSH-1 principles to wideband predetection recording. The model AN/FLR-<sup>7</sup> drum recorder was turned out in production quantities by NRL's machine shops. The equipments found extensive use by the Navy and other military services.

For various purposes, the Navy used a very large number of expensive, high-quality magnetic tape recorders provided by many manufacturers. A major maintenance expense had been the replacement of recording heads which have had short life and involve stocking in a wide variety of head types. In advancing this situation, NRL developed a universal recording head which matched the requirements of all recorders sufficiently well so as not to compromise performance (1967).<sup>36</sup> The head had seven channels. Two heads were used to provide 14 channels on one-inch tape. NRL's new recording head had much longer life and incorporated radio-frequency-interference shielding. The cost of replacement had been reduced to one-third, and head life was increased three times.

In analyzing signals, it is advantageous to know quickly the spectral distribution of the energy. Since existing methods of obtaining this information were inadequate, NRL developed the

## ELECTRONIC COUNTERMEASURES

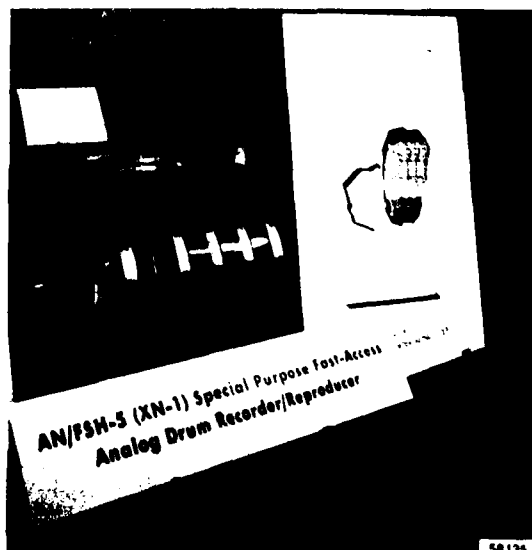
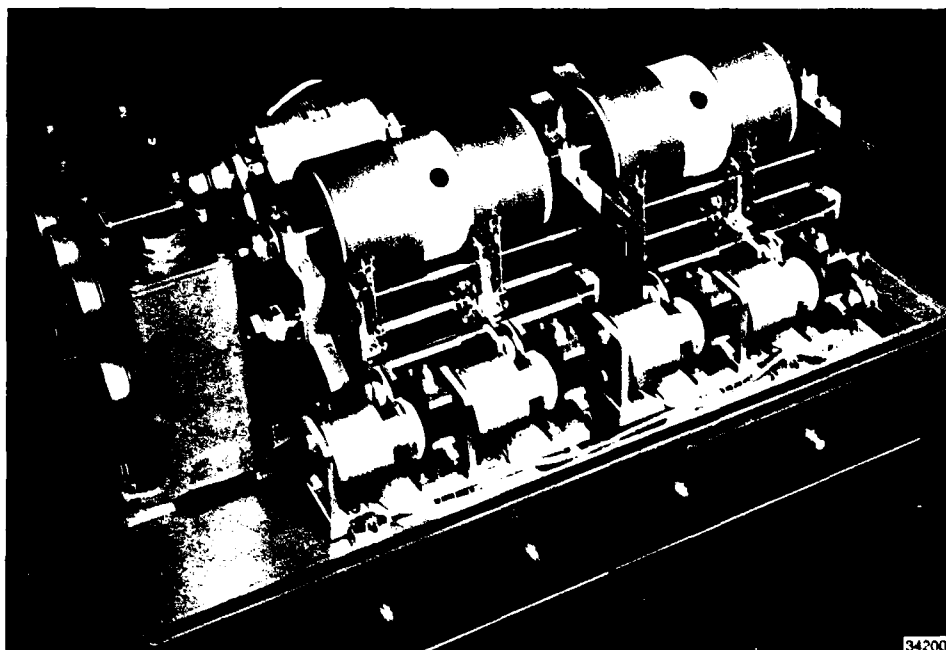

### FIRST SHORT-TERM, LONG-LIFE, CONTINUOUS SIGNAL STORAGE DEVICE (1951)

This NRI developed device permits assessment of the value of the recorded information and transfer to permanent storage if warranted. The Model AN FSH 1, shown at the top, the first of the family of these storage devices, handled four analog channels of information simultaneously. The Model AN FSH 5 was an extension of the principles developed to wideband predetection recording.

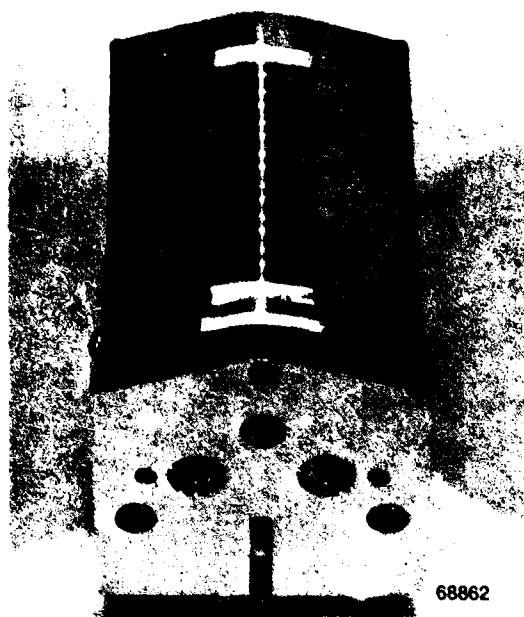

UNIVERSAL SIGNAL RECORDING HEAD

NRL developed this long-life recording head as a replacement for the heads of the various Navy signal recorders (1967). The head has seven tracks. Two heads are used to provide fourteen tracks on one-inch tape.

first instantaneous audio-frequency spectrograph, which provides an instantaneous plot of the energy of a signal in the frequency and time domain (1955).<sup>36</sup> The signal to be analyzed is amplified and fed to a group of comb-type filters. The output of the filter bank is graphically recorded on a new type of chemically treated electro-sensitive paper also developed by NRL.

In analyzing signals, particularly transient signals, recorded on magnetic tape, some means must be provided for their visual display. Since no satisfactory means had been devised, NRL developed the first analysis device for displaying on a cathode-ray-tube screen, or analyzer, transient signals recorded on magnetic tape (1965).<sup>37</sup> In this device, designated the Model AN/FSH-6, a length of magnetic tape is held stationary wrapped around a rapidly rotating

cylinder carrying a magnetic reproducing head. The signal on the tape is repeatedly scanned by the rotating head and displayed on the cathode-ray-tube screen. An air film builds up under the magnetic tape and prevents tape wear by the rotating head during observation. This device provides great time saving for the data analyst.

## JAMMERS

During World War II, jammers for use against enemy radars were developed to cover the limited frequency bands then known to be used by these radars. After the war, since a potential enemy might choose to use any frequency suitable for radar, NRL set about to develop a series of jammers which would cover the most likely radar frequency spectrum. At that time, magnetron tubes were found to be the best type of power generators available. They provided the power output necessary for effective jamming and could be noise modulated. A jammer operates under an inverse second-power law and a radar under a fourth-power law. Thus, based on jammer power, there is a limit to the closeness a vehicle carrying a jammer can approach a radar and still cover its own echo by jamming. However, magnetrons were limited in the frequency range over which they could provide adequate power for echo coverage, making it necessary to use a considerable number of them to provide the desired frequency coverage. In carrying out its magnetron jammer program, NRL developed the first U.S. airborne microwave noise jammer (1948).<sup>38</sup> At first, X band was covered. Later, S and L band coverage was added, with power output up to 200 watts. Several hundred of these jammers were procured under the designation AN/ALT-2. Some of these jammers were used later in combat action in southeast Asia.

Prior to 1949, after a radar signal had been intercepted, the jammer had to be adjusted to the radar frequency manually by an operator using a monitoring receiver. In improving upon the manual type of operation, NRL was first to develop an automatic search and jam

ELECTRONIC COUNTERMEASURES

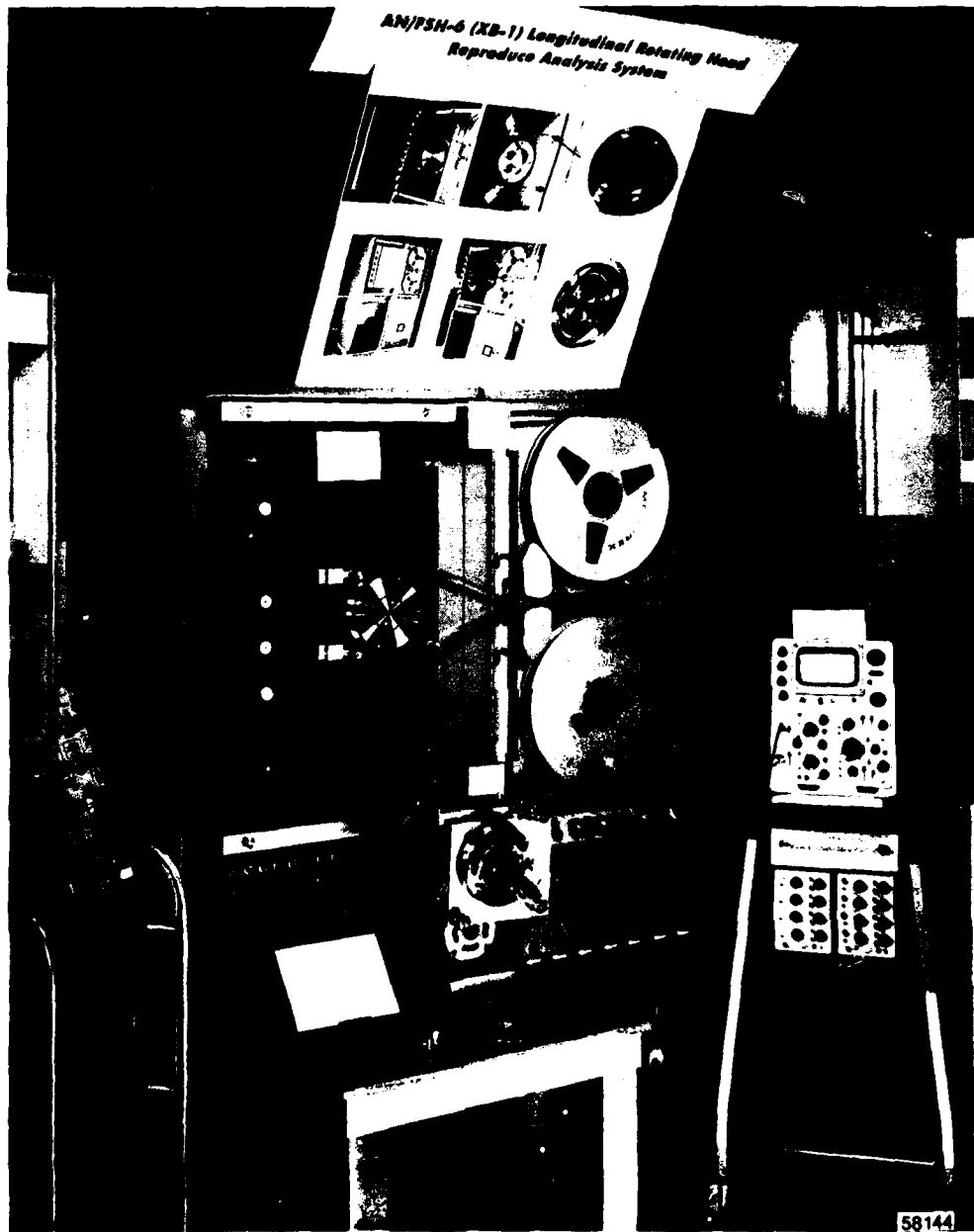

**FIRST DEVICE FOR THE DISPLAY OF TRANSIENT SIGNALS RECORDED ON MAGNETIC TAPE**

In this device, a length of magnetic tape is held stationary while wrapped around a rapidly rotating cylinder carrying a magnetic reproducing head. The tape is repeatedly scanned by the head, and the information is displayed on a cathode-ray tube for analysis. This NRL development was designated the Model AN/FSH-6.



## ELECTRONIC COUNTERMEASURES

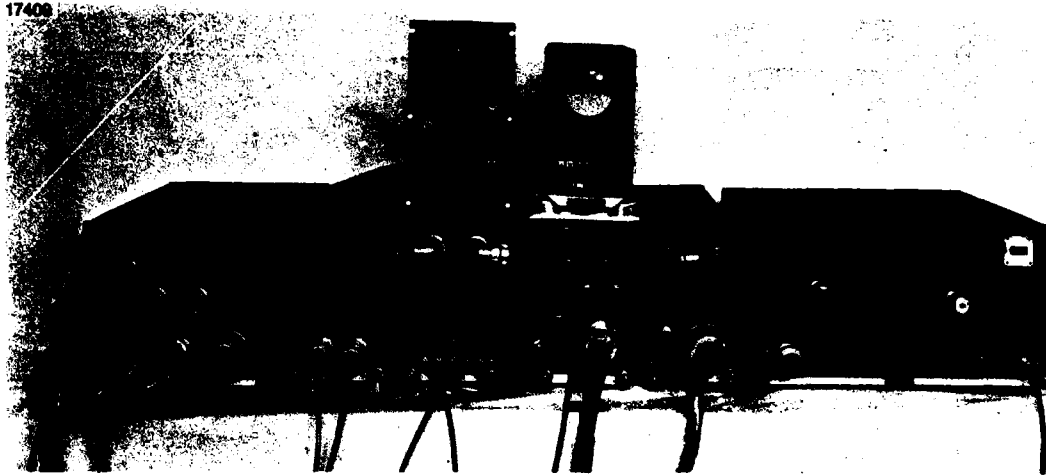

**FIRST U.S. MICROWAVE AIRBORNE NOISE JAMMER SYSTEM GIVING A BARRAGE-TYPE PROTECTIVE COVERAGE (1948)**

This NRL-developed equipment was designated the AN/ALT-2. Some of these magnetron jammers were used in combat activities in Southeast Asia. The jammer transmitter is shown on the right. The rest of the equipment provides look-through reception of the radar signal being jammed to permit the jammer to be set on the radar frequency.

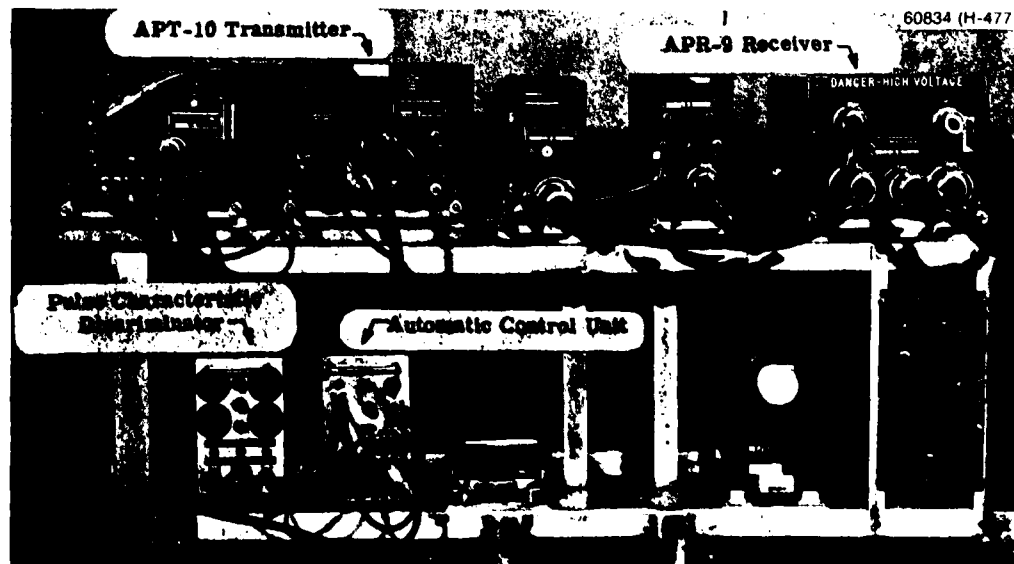

**FIRST AUTOMATIC SEARCH AND JAM SYSTEM (1949)**

Developed by NRL, this system was designated the Model AN ALQ-33. The system was procured in considerable quantity. It was used in Southeast Asia action.

## ELECTRONIC COUNTERMEASURES

system (1949), designated the Model AN/ALQ-23 (earlier the Model APQ-33 (XB)). This system was procured in considerable quantity. It also found use in southeast Asia combat action. In operation, the automatic control stopped the scanning receiver on an intercepted radar signal, which caused the jammer first to scan and then stop on the frequency selected for jamming. Periodic "look-through" sensed the cessation of the radar signal and caused the receiver to search again for a new signal. A unique feature of the system permitted discrimination among several signals based on pulse characteristics. The system would lock on to the signal with the required pulse characteristics. A shipboard version of the Model AN/ALQ-23, known as the Model AN/SLQ-10 (1960), was also developed.

When the Model AN/ALQ-23 automatic search and jam system was developed, the frequency of the magnetron output could be controlled only through mechanical means, relatively a very slow process. To contend with improved radar techniques, much more rapid means of setting on the radar frequency was necessary. NRL sponsored

the development of a backward-wave-oscillator tube, the frequency of which could be controlled electronically. With this tube, NRL developed the first search-and-jam system, in which the jammer could be set onto the radar frequency very rapidly through electronic control (1956).<sup>39</sup> Furthermore, the system provided superior "noise" modulation, with the modulation bandwidth controllable to provide most effective coverage of the radar echo. The experimental model was designated the NL/ALQ-F(XB-1). When procured in quantity, a series of airborne jammer systems resulted, including the models AN/ALT-19 (1960), AN/ALT-21 (1961), AN/ALT-27 (1964), and the AN/ALQ-76 (1966). Of these systems, the Model AN/ALT-27 inboard system and the Model AN/ALQ-76 outboard "pod" system used in type EA-6A jammer aircraft saw extensive service recently in southeast Asia. A shipborne system, the Model AN/SLQ-12 (1963), capable of fully automatic operation, was also developed, avoiding the manual set-on-frequency operation of the airborne versions, which, although rapid, had to be accomplished by personnel. The backward-wave

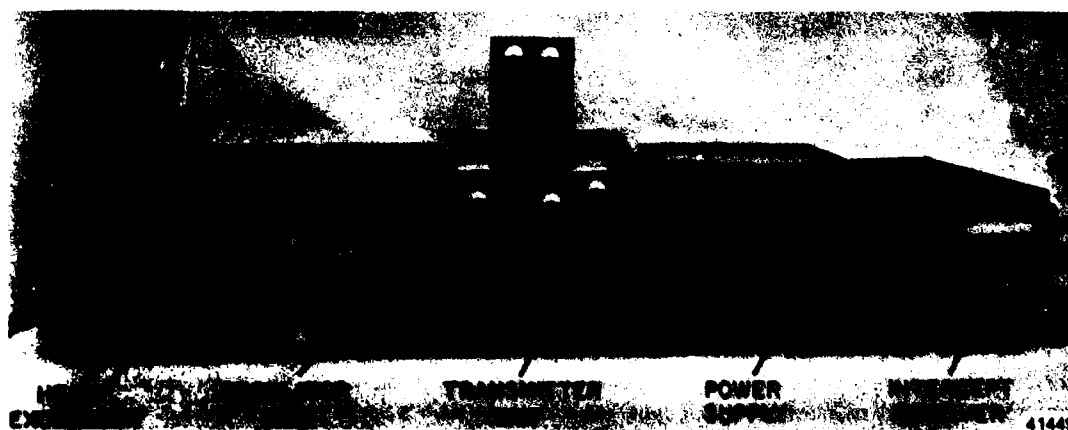

FIRST SEARCH AND JAM SYSTEM IN WHICH THE JAMMER COULD BE SET ON THE RADAR FREQUENCY VERY RAPIDLY THROUGH ELECTRONIC CONTROL (1960)

This NRL developed system, designated Model NL/ALQ-F(XB-1), utilized a backward wave oscillator tube. The system provided superior "noise" modulation with modulation bandwidth controllable to provide most effective coverage of the radar echo.

## ELECTRONIC COUNTERMEASURES



60834 (H-478)

### TYPE EA-6A JAMMER AIRCRAFT

This modern aircraft, which has seen extensive service recently in Southeast Asia, utilizes the AN/ALQ-76 outboard "pod" jammer system, which is based on the experimental model developed by NRL (1956). The system was first to incorporate electronic frequency control with a backward-wave-oscillator tube, which permits rapid setting on the frequency of an enemy radar to be jammed. Five jammer pods, adjusted to cover pertinent frequency bands, can be seen mounted beneath the wings and fuselage of the aircraft. The primary mission of the aircraft is to support strike aircraft and ground troops by suppressing enemy electronic activity.

tube is a variety of traveling-wave tube in which the bunching of the electrons in the beam propagates along the tube's length, but in a direction reverse to that of the electron beam. This action established operation as an oscillator of considerable power and frequency range which was superior to that of the magnetron. The modulation was of the frequency-modulated-noise type of sufficient bandwidth to be effective without precisely setting on the radar frequency of S and X band radars.

NRL sponsored further development of the traveling-wave tube to take advantage of its amplifier characteristics with power generated as a result of bunched electrons traveling in the same direction as the beam. This type tube offered for the first time the potential of amplification over very wide bandwidths, i.e., in excess of octaves. With this traveling-wave tube, NRL was first to develop an automatic search-and-jam system in which the jamming was accomplished through the amplification of noise,

## ELECTRONIC COUNTERMEASURES

with the capability to jam several radars on different frequencies simultaneously (1954).<sup>40</sup> The successful operation of this system was first demonstrated with the equipment on NRL's picket boat against its radars at its Chesapeake Bay site. This system, known as the Model AN/ALQ-99, was used to a major extent in the type EA-6B jamming aircraft in southeast Asia. Since the traveling-wave tube is used as an amplifier with one or more low-power-level master oscillators, the latter can serve to provide great flexibility in operation without the complication of physical manipulation in the amplifier. Thus, modulation can quickly and easily be changed from wideband "barrage" type to multiple "spot" type, with power output concentrated accordingly.

### ELECTRONIC DECEPTION – PULSE REPEATERS

During World War II, the Laboratory made a study of various means to deceive enemy radars

and determined the requirements for successful radar deception equipment. NRL developed a pulse-repeater deception device ("Moonshine"), designated the Model CXFG, for deceiving enemy radars with respect to true range of the target by transmitting back false pulses (1943).<sup>12</sup> Many flight tests were run on this equipment against a captured Japanese radar. In another effort, NRL developed a pulse-repeater deception device in which the target echo was obliterated by the noise modulation of the retransmitted pulse (1943).<sup>41</sup> This equipment was designated the Model MBE. Its performance was proven through trials against a captured Japanese fire-control radar. It was installed on the light cruiser USS MIAMI.

The early deception pulse repeaters were effective only when operating against relatively low-powered radars with long pulse lengths and using the lower radar frequencies. They were ineffective against the higher frequency, short-pulse radars soon to be used for fire and missile control. The minimum time delay possible in repeater circuits then available was much too long to contend



MODEL EA-6B JAMMER AIRCRAFT WITH NRL'S SIMULTANEOUS MULTI-RADAR AUTOMATIC SEARCH AND JAM SYSTEM

NRL was first to develop an automatic search and jam system, incorporating traveling-wave tubes, in which the jamming is accomplished through the amplification of noise. This system has the capability to jam several radars on different frequencies simultaneously (1954). NRL's system, designated the Model AN/ALQ-99 when procured in quantity, was utilized in the Model EA-6B jammer aircraft, which had been used to a major extent in Southeast Asia. To cover a very broad frequency range, five pods, each carrying a jammer, are used. These pods can be seen mounted beneath the wings and fuselage of the aircraft.

ELECTRONIC COUNTERMEASURES

with the shorter pulse lengths of these improved radars. Moreover, much higher repeater output power was required to provide adequate cover for target echos. It was not until considerably later that adequate repeater techniques became available to counter these radars.

NRL sponsored the development of a traveling-wave radio-frequency amplifier tube having very broad bandwidth and high power (2 kW) output (1954). To provide a means of pulsing this output amplifier, NRL developed the first electron-multiplier tube capable

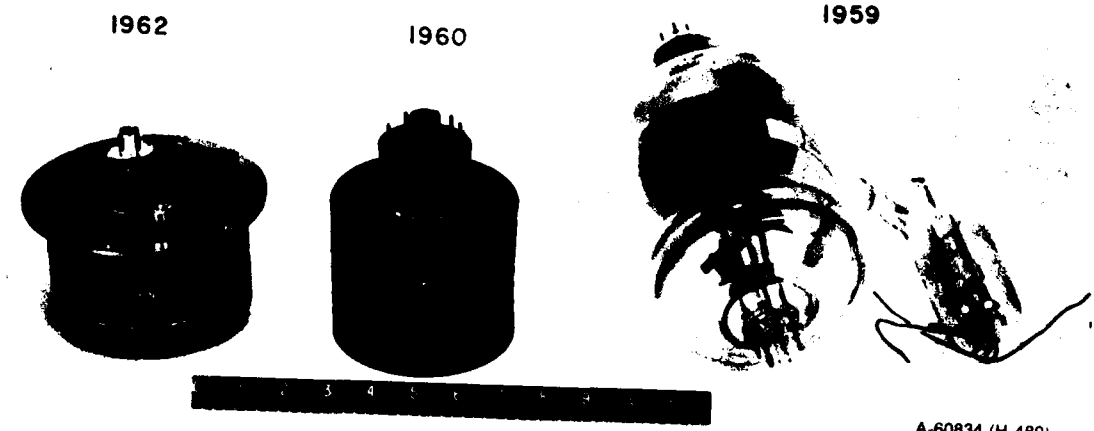

A-60834 (H-480)

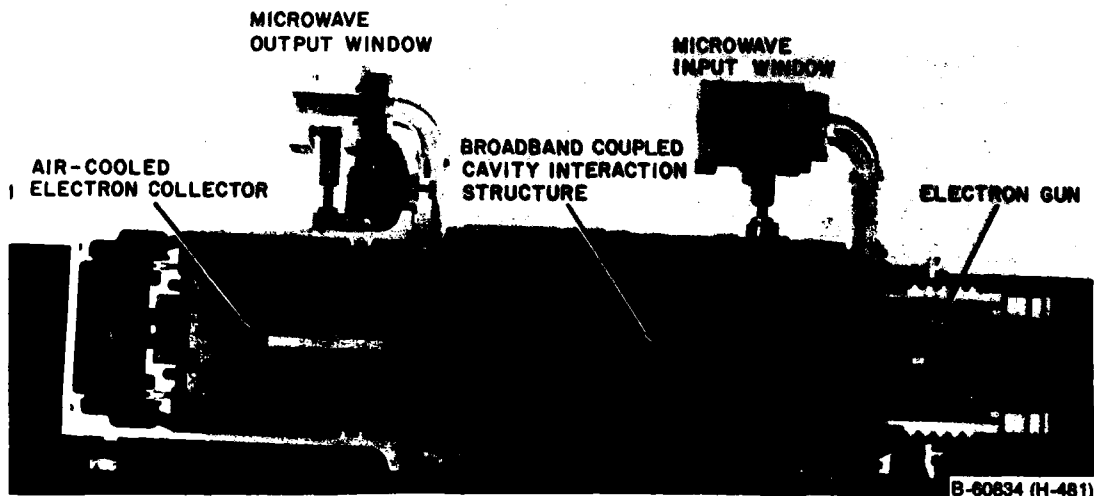

B-60834 (H-481)

NOVEL DECEPTION PULSE REPEATER TUBES (1954)

The electron-multiplier tube (stages of development above) developed by NRL was first to provide pulse amplification to a 6-kW power level with a time delay of less than 20 nanoseconds. It provided pulse power for the traveling wave tube (below) of high power (2 kW) developed under NRL sponsorship. These tubes made possible the first deception pulse repeaters to be successful against modern fire and missile control radars. These tubes were incorporated into the deception pulse repeater, the Model AN/AIQ-H(X), shown subsequently.

## ELECTRONIC COUNTERMEASURES

of pulse amplification to a 6-kW power level with a delay time less than 20 nanoseconds (1954).<sup>42</sup> With these components, NRL developed the first deception pulse repeater to be successful against modern fire and missile control radars (1956). NRL's system was capable of both range and angle deception and could contend with a number of radar signals simultaneously over a frequency band as wide as two to one. This system, known as the Model AN/ALQ-H(X) in early form, was the basis for the procurement in quantity of a series of successful deception pulse repeaters designated the Models AN/ALQ-19 (1959), AN/ALQ-49 (1959), AN/ALQ-51 (1960), AN/

ALQ-100 (1965), and AN/ALQ-126 (1972). The Models AN/ALQ-51 and AN/ALQ-100 saw action in southeast Asia. NRL provided the technical base for many improvements for these equipment as they evolved for service use.

The basic NRL deception pulse repeater system utilized two traveling-wave tubes having broad bandwidth. One of these was a lower power receiver tube which, upon receiving a radar pulse, provided amplification and excitation for the input of the other, which was the power-output tube. The receiver tube also provided video pulses for the electron-multiplier, power-amplifier tube, which in turn provided the high pulse power to operate the traveling-wave output tube



**THE FIRST PULSE REPEATER DECEPTION EQUIPMENT TO BE SUCCESSFUL AGAINST MODERN FIRE AND MISSILE CONTROL RADARS (1956)**

Shown projecting downward from the HSS 1 helicopter is an early version of a receiving and transmitting antenna assembly, arranged for minimum coupling, so that the attenuation between the antennas is greater than the electronic power gain of the system. NRL's model of the equipment was designated the AN ALQ H(X). Production models of this equipment saw action in Vietnam.

## ELECTRONIC COUNTERMEASURES

NRL's system used both receiving and transmitting antennas arranged for minimum mutual coupling, so that the attenuation between antennas was greater than the electronic power gain of the system. Otherwise, the system itself would oscillate and be inoperative as a repeater.

### RADAR PASSIVE DECEPTION AND CONFUSION

During World War II, both the allies and Germany developed passive reflectors to return back echoes for the purpose of deceiving or confusing enemy radars. Lightweight dipoles dispensed from aircraft in large numbers was one form of these reflectors, known as "chaff" or "window." Clouds of these dipoles, which fell slowly, were used by the allies to conceal aircraft in flight and to provide false targets for decoying purposes. Another type of reflector, called "rope," was used, primarily for the lower frequencies. Rope consisted of ribbon-like streamers of narrow aluminum foil about 400 feet long, packaged for dispensing as rolls. Rope was also arranged as a

longitudinal sequence of dipoles mounted on paper tape. Still another form of reflector used large areas of chicken-wire netting suspended from captive balloons to simulate a real target. These devices were employed by the allies with great effectiveness in protecting streams of bombers against enemy anti-aircraft fire, and on "D" day, in causing the Germans to believe that the allied landing was directed at Pas de Calais instead of Normandy.<sup>46</sup>

During the war, NRL carried out a program to determine the best form of chaff dipoles and the best method of dispensing them.<sup>44</sup> Dipoles made of narrow strips of paper-backed aluminum foil bent longitudinally into a flattened V cross section and cut to a length a little less than half a wavelength were considered to give the best results. Investigations were made of types of packaging, package size, dispenser design, rate of dispersion, rate of fall, and effects of polarization. The practicability of ejection by means of shells and rockets was also considered. The tendency of the dipoles to coalesce into a mass, known as "birdnesting," when released into the air was a

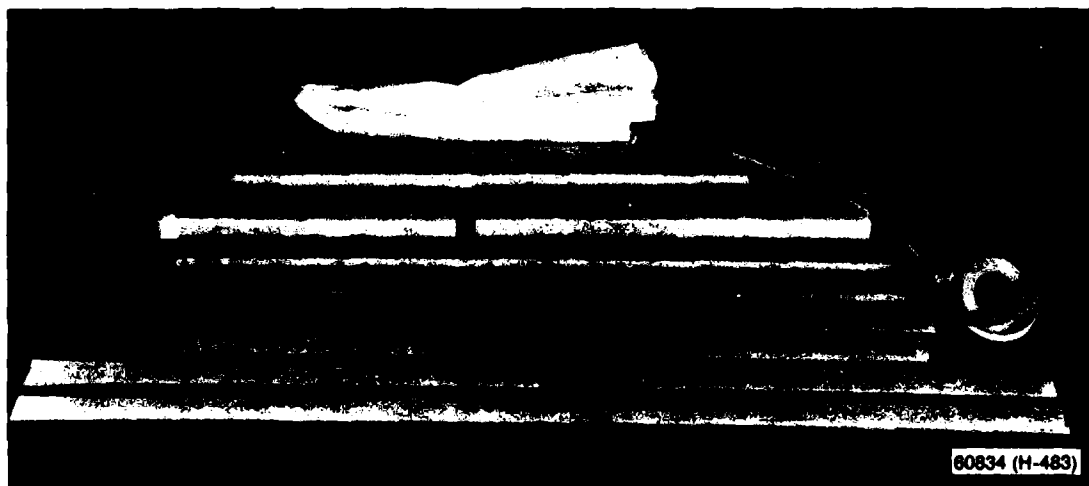

EARLY TYPES OF "CHAFF"

Shown are packages of chaff in cardboard wrappers of various lengths corresponding to the frequencies of the radars to be countered. In its early applications, chaff was ejected manually from the aircraft. The coils attached to the parachutes are "rope," which uncoiled in the air and were held suspended by the chutes.

## ELECTRONIC COUNTERMEASURES



### THE FIRST SUCCESSFUL CHAFF DISPENSER CAPABLE OF PROTECTING AIRCRAFT FROM RADAR-DIRECTED ATTACK

This dispenser, developed by NRL in 1954, incorporated a dispensing technique devised by NRL (1951), utilizing cylindrical cartridges containing squibs which when fired ejected the chaff. The dispenser (Model AM/ALE-29), holding 30 cartridges, is shown above. It was used extensively in Southeast Asia. The rate of cartridge ejection is controllable, so that proper chaff cloud formation can be obtained. Shown below is a cartridge containing (left to right) S, C, and X-band chaff, respectively, 2, 1, and 0.6 in. in length. The five packets of metallic-coated dipoles contain a total of 3,750,000 dipoles per cartridge. V. J. Kutsch, who developed the dispenser, is shown holding a cartridge.



particularly difficult problem. During this work, many trials were conducted with aircraft dispensing chaff using the radars at NRL's Chesapeake Bay site for observation.

After the war this program continued, and for many years NRL was the principal U.S. organization conducting research for Naval chaff objectives. Postwar developments brought about radars of increasingly greater capability, making countermeasures far more difficult. It became important to be able to break the tracking or vitiate the accuracy of the improved fire and missile control radars. It was found possible to do this with improvements in chaff. When properly used, chaff has been found to be an effective weapon. It is a simple and relatively inexpensive material. It can be dropped in large quantities to form barriers to screen the movement of aircraft or ships. It can be dropped in small quantities to confuse an interceptor's missile-control computer. It can be fired from large guns or dispensed from aircraft. It can be fired ahead or dropped behind the vehicle. The very existence of chaff has forced radar system designers to incorporate elaborate and sophisticated circuits to counter its effects, leading to increased probability of malfunctioning.

NRL conducted investigations to improve the effectiveness of chaff, particularly with respect to minimizing dipole volume relative to cloud size, broadening frequency coverage, and increasing rapidity of cloud formation.<sup>45</sup> As the development of chaff evolved, aluminum foil with a plastic coating was used (1950). The plastic coating made it possible to cut the foil so that the volume of the chaff package was reduced to one-fifth that previously used. A further reduction to one-third size or less was accomplished through the use of metallic-coated glass fibers (1952).<sup>46</sup> By proper choice of length of dipoles, a variety could be packaged effectively to cover the frequencies of radars existing in a particular situation. Both types of chaff have been used by the several military services.

To be effective in dealing with the improved radars, it was important that chaff be ejected and

form a cloud or bloom quickly. This is necessary for the adequate protection of aircraft. Chaff dispensers and methods of packaging had to be greatly improved. A series of chaff dispensers was developed, but each one was found to have serious limitations. Finally, NRL developed a chaff-dispenser technique which first gave operationally acceptable results (1954).<sup>47</sup> This technique was incorporated into a dispenser designated the Model AN/ALE-29 (1962). This dispenser has been used to a considerable extent in southeast Asia air operations. A tremendous quantity of chaff has been utilized in protecting our aircraft in these operations. The use of chaff by Naval aircraft is based upon the results of NRL's work. The dispenser utilizes cylindrical cartridges with the chaff cut into packages to fit inside. One end of the cartridge contains a squib which when fired ejects the chaff. The rate of cartridge ejection is controlled to provide the proper spacings of chaff clouds.

The Laboratory has also made important contributions to the development of ship-launched chaff warheads to provide screening for ship operations and decoys. The warheads are fired from ships, and when they attain proper altitude, exploding squibs eject the chaff. These warheads have been used in rockets, mortars, and Naval guns. NRL's work provided the basis for the effectiveness of chaff.

## REFERENCES

1. G.H. Clark, "Radioana—Radio in War and Peace," pp. 30, 31; in the Clark collection, Division of Electricity, National Museum of History and Technology, Smithsonian Institution, Washington, D.C.
2. Report of the Secretary of the Navy, 30 June 1907, p. 46
3. S.C. Hooper, RADM, "Navy History—Radio, Radar and Sonar Recordings," Naval Historical Center, Washington, D.C., Recordings 31R77, 32R78
4. A. Hoyt Taylor, "Radio Reminiscences: A Half Century," NRL Library No. 359.0072.T238
  - a. pp. 33, 34 (1960); pp. 54, 55 (1948)
  - b. pp. 130, 131 (1960); pp. 226, 227 (1948)
  - c. pp. 134, 135 (1960); pp. 233, 234 (1948)
  - d. pp. 132, 133 (1960); pp. 229, 230 (1948)
  - e. p. 135 (1960); p. 234 (1948)

## ELECTRONIC COUNTERMEASURES

5. A.H. Taylor, memorandum to Director, 23 Dec. 1929, in "Radio Plans, Projects, and Policies, 1924-1943," NRL File S67/A1, NRL Problems A4-4, A4-5, A4-6; National Archives, JO 7184, Box 76, Folder 1; NRL CRMO
6. L.V. Blake, "Japanese Radar Equipment - C.E.C. 211 - Captured on Guadalcanal," NRL Report 2183, Nov. 1943
  - W.F. Main, Jr. and L.L. Bonham, "Japanese Radar Equipment - C.E.E. 3088 - Captured on Attu," NRL Report 2184, Nov. 1943
7. "Airborne Radar No. 1," NRL File F-425, Dec. 1941, NRL Consulting Report, 25 Aug. 1942; Archives, JO 7184, Box 26, Folder 1; NRL CRMO
  - I.H. Page log, NRL Register 280, Jan. 19, 1943, p. 265; NRL CRMO
8. NRL letters to Bureau of Ships; NRC JO 8018, Box 40, Folder 26; NRL CRMO
  - C-S64/69 (342-dg), 23 Feb. 1944
  - C-S67/69 (342-RG), 22 Nov. 1944
9. Bureau of Ships letter, S-A16-3/567 (900), Serial 07497, 1 Feb. 1944, NRL File S-S67-5/FS, on Route Slip 004452, 2 Feb. 1944, NRC JO 11029, Box 29, Folder 1; NRL CRMO
10. I.H. Page, "TDY Jamming Tests," NRL Report 2333, July 1944
  - K.M. Watson, C.J. Zaander, L.V. Blake, "Performance Tests and Modifications of the Model TDY Radar Jamming Transmitter," NRL Report 2423, Dec. 1944
  - K.M. Watson, L.V. Blake, "Tests of Model TDY Radar Jamming Transmitter with Z-666 Magnetron and CAKZ-66KZ-66AJT Antenna," NRL Report 2455, Feb. 1945
  - W.F. Main, "Performance Tests of Model TDY 1 Radar Jamming Transmitter," NRL Report 2878, July 1946
11. M. Katzin, J.T. Bollhahn, P.W. Anderson, H.E. LaGow, "Antennas for Guided Missiles Countermeasures on Destroyer Escorts," NRL Report 2240, Mar. 1944
  - S.G. Lutz, "General Instructions for Guided Missile Countermeasure Systems," NRL Report 2241, Mar. 1944
  - M. Katzin, H.E. LaGow, J.T. Bollhahn, "Antennas for Guided Missiles Countermeasures Installed on DD-425 and DD-427," NRL Report 2251, Mar. 1944
  - S.G. Lutz, F.T. Powles, A.L. Howard, "The Development and Test of Model TEA Jamming Transmitter," NRL Report 2330, Aug. 1944
  - F.T. Powles, "Development and Test of Type CAPU 24325 Transmitter Selector Switch for Use with Model TEA Equipment," NRL Report 2465, Mar. 1945
  - D. Wilson, R.E. Taylor, H.E. LaGow, "Guided Missiles Countermeasures, Band C Antenna," NRL Report 2365, Nov. 1944
12. E.H. Krause, "Achievements of NRL During Period July 1941 to June 1945," NRL Memorandum to Superintendent, Radio Division, 18 June 1945, NRL File S-S67/33, NRL CRMO
13. M.K. Goldstein, "The Proximity Effect of a Metallic Fence on a Navy Type DT Direction Finder," NRL Report 1890, June 1942
  - H.F. Hastings, "Model XABHRO Radio Direction Finder Equipment," NRL Report RA 69A 209B, NRL Document 306, 405, Nov. 1937
14. M.K. Goldstein, "Specifications for Minimum Direction Finder Site Requirements," NRL Report 1938, Sept. 1942
  - A.G. Loveberg, "Effects on Shipboard of HF, DF, Radar and Homing Performance Installing of Their Antennas on a Common Mast," NRL Report 2099, Dec. 1943
  - M.K. Goldstein, M.J. Sheets, "Interpolation Charts for HF DF Shipboard Calibration," NRL Report 2229, Feb. 1944
15. NRL letter to Bureau of Ships, 31 Dec. 1943, NRL File C-S67/69 (342E); NRC JO 8018, Box 39, Folder 16; NRL CRMO
16. M.J. Sheets, J.D. Hottman, "Accuracy of the High Band AN/GRD-6 with Sleeve Antenna Elements," NRL Memo. Rept. 839, Aug. 1958
17. R.F. Gleason, J.H. Trexler, "Ionospheric Limitations in the Ultimate Accuracy of Direction Finding," NRL Memo Rept. 61, Sept. 1952
18. J.H. Trexler, "Circularly Disposed Antenna Arrays," NRL Report 3213, Dec. 1947
  - R.F. Gleason, R.M. Greene, "A Wide-Aperture HF Direction-Finder," NRL Memo. Rept. 746, Oct. 1957
  - R.F. Gleason, C.V. Johnson, "An Inductively Coupled Goniometer for Wide-Aperture DF Arrays," NRL Memo. Rept. 832, Aug. 1958
  - R.F. Gleason, R.M. Greene, W.M. McDevitt, "An HF Multicoupler for Use with Wide-Aperture Antenna Arrays," NRL Memo. Rept. 840, Aug. 1958
  - R.F. Gleason, R.M. Greene, "A Wide-Aperture HF Direction-Finder with Sleeve Antennas," NRL Memo. Rept. 843, Aug. 1958
19. R.D. Misner, B. Wald, "Bearing Readout Systems for Goniometric Direction Finders," NRL Memo. Rept. 830, Aug. 1958
20. B. Wald, W.D. Googe, "HF-DF Fixing," NRL Report 5302, May 1959
21. B. Wald, "Utilization of a Multiprocessor in Command and Control," Proc. IEEE, Dec. 1966, pp. 1885-1888
22. NRL letter to Bureau of Aeronautics, C-3940-3/51 (CLW) (048626), May 1951, NRL CRMO
  - J.H. Trexler, Log 23, page 4238, NRL Register N-481; NRL CRMO
23. J.R. Gruber, E.H. Flath, "Requirements of Direction Finders Indicator and Determination of Correct Scanning Rates for DF Collector Systems in the VHF, UHF, and SHF Bands," NRL Report 2648, Apr. 1946
24. J.H. Trexler, Log 25, page 4240, NRL Register N-481, NRL CRMO
25. J.R. Gruber, A.J. Jesswein, Jr., V.S. Rose, "An Airborne Instantaneous Microwave Direction Finder, The NL/ALD-A," NRL Report 4526, May 1955
  - V.S. Rose, "Comparative Performance of Cathode-Ray Tubes in the NL/ALD-A Crystal-Video Direction Finder," NRL Memo. Rept. 534, Oct. 1955
  - A.J. Jesswein, "System Consideration of a Wide-Open Crystal-Video, Two-Channel Direction Finder," NRL Memo. Rept. 605, June 1956
26. NRL letters to Bureau of Ships, NRC JO 8018, Box 41, Folder 15; NRL CRMO
  - S-S67/69 (342C), Ser. 3562, 1 Aug. 1944
  - C-S67/69 (342-JRA), 30 May 1945
  - C-S67/69 (342C), Ser. 5490, 19 Sept. 1945
27. NRL letter to Bureau of Ships, S-S67/69 (342C), 2 July 1945, NRC JO 11029, Box 22, Folder 5, NRL CRMO
28. J.R. Gruber, "A Submarine Direction Finder for Radar Intercept The AN/BPA 1 (XN 1)," NRL Report 3666, May 1950
29. H.K. Weidemann, "Microwave Intercept Systems," NRL Report 4915, Apr. 1957
  - R.A. Carpenter, "The Passive Countermeasures Program at the Naval Research Laboratory," NRL Memo. Rept. 701, July 1957
30. W.B. Bachelor and R.D. Cox, "AN/SLR-12 (XN-1) Sea Trials and Comments," NRL Memo. Rept. 1575, Oct. 1964
  - M.D. Wood, "Shipboard Receiver Interference Suppression," NRL Memo. Rept. 2024, July 1969
31. G.M. Bullock, R.D. Marks, "Video Blanking in Countermeasures Intercept Receivers," NRL Report 4223, Sept. 1953
  - G.M. Bullock, "Operational Aspects of the NRL Microwave

## ELECTRONIC COUNTERMEASURES

- Intercept System," NRL Report 4883, Jan. 1957
- R.D. Cox, "Intercept Receiver Blanking," NRL Memo. Rept. 1397, Feb. 1963
  - A.J. Jesswein, "Reduction of Radiofrequency Interference on the USS ENTERPRISE," NRL Memo. Rept. 1555, July 1964
  - NRL letter reports to Bureau of Ships, NRL File C A22, NRL CRMO
    - H.K. Weideman, C 3940-143/49, 29 Nov. 1949
    - G.Wade, C 3940 162/49, 10 Mar. 1950
    - R.M. Gran, "Universal Intercept Systems," C 3940 124/51, 19 July 1951
- 32 R.G. Hennessey, "Electrical Characteristics of Audio Oscillator in the Model RDJ-1 Pulse Analyzer," NRL Report 2743, Jan. 1946
  - 33 J.E. Gall, "An Instantaneous Pulse-Signal Analyzer," NRL Report 3435, Mar 1949
    - E.N. Munzer, "Improved Countermeasures Pulse Analyzer Techniques," NRL Report 3847, Aug 1951
    - J.H. Markell, "Refinements in Countermeasures Signal Analyzer Techniques," NRL Report 4341, Apr 1954
  - 34 L.C. Holmes, "Progress Report. The Development and Construction of a Countermeasures Recorder Reproducer, July 30, 1949 Sept. 27, 1949," Stromberg Carlson Co., File No. 1155, Project RGE 9037, Report No. VIII, Oct. 1949, NRL Document 496,865
    - "Handbook of Operating Instructions for Radio Countermeasures Sound Recorder Reproducer IC/VRT 7," Stromberg Carlson Co., File No. 2063, Project RGE 9037, NRL Document HB 11584 (undated)
  - 35 "Long Life Universal Magnetic Recording Head," NRL 1969 Annual Report, p. 23
  - 36 R.D. Misner, "An Instantaneous Sound Spectrograph," NRL Report 4671, Jan. 1958
  - 37 "Monthly Progress Report, Oct. 5 Nov. 5, 1962," S. Himmelstein and Co., Nov. 1962, NRL Document 497,674, Contract NONR 3906(00)(X)
  - 38 J.M. Miles, "Experimental Jamming Transmitter Using a 200-Watt CW X-Band Developmental Magnetron," NRL Report 3384, Nov 1948
    - J.M. Miles, "Airborne X-Band Jammer AN-ALT-2(XB-3)," NRL Report 3899, Nov 1951
    - F.J. Hollweck, "A Determination of the Wideband Modulation Capabilities of Jamming Transmitter AN/ALT 2," NRL Report 5573, Dec 1960
  - 39 J.R. Williams, "The NL-ALQ-F (XB-1) Jammer," NRL Report 5539, Oct 1960
  - 40 NRL letters to Bureau of Aeronautics, NRL Problem R06 10, File No. FRC/C A22, NRL CRMO
    - C-3940-50A/53 BWS, 3 Mar. 1953
    - C-3940-172A/53 BWS, 5 Oct. 1953
    - C-3940-188A/53 BWS, 2 Nov. 1953
  - 41 A.V. Haeff and F.H. Harris, U.S. Patents 2,561,363 and 2,562,907
    - F. Harris, U.S. Patent 2,570,233
  - 42 G.L. Stambach, W.J. Graham, and T.E. Hanley, "High-Current Grid Controlled Electron Multiplier Tube," IRE Trans. on Electron Devices, Vol. ED 7, July 1960, pp. 143-146
  - 43 L.A. Cosby, "Continuous Look-Thru as Applied to Airborne Automatic Search and Jam Systems," NRL Report 4676, Jan 1956
  - 44 L.V. Blake, "Preliminary Report on Tests of Reflecting Material as a Radar Countermeasure," NRL Report 2022, Mar. 1943
    - L.V. Blake and L.R. Philpott, "Operational Tests of Special 'Chaff' Developed by Radio Research Laboratory, Harvard University (Supplementary Information for RRL Engineers Harvard University, Cambridge, Mass.)," NRL Report 2081, Apr. 1943
    - T.D. Hanscome, "Features of Design, Preparation and Use of Naval Window," NRL Report 2289, May 1944
    - T.D. Hanscome, "Investigation of Window Types for S Band Use," NRL Report 2351, Mar. 1945
    - J.S. Klein, "Window Types for Naval Use in the Frequency Range 90-3000 Mc.," NRL Report 2443, Mar. 1945
  - 45 J.C. Link, "An investigation of Balloon-Borne Spherical Radar Reflectors as Standard Targets," NRL Memo Rept 301, June 1954
    - R.R. Ford, "Chaff Echo Measurements at 24 KMC," NRL Memo. Rept 757, Nov 1957
  - 46 D.B. Christmas, Coated Dipoles as Confusion Reflectors," NRL Report 4040, Sept 1952
    - V.J. Kutsch, "Performance of Metalized Glass Chaff at X Band," NRL Memo Rept 884, Jan 1959
  - 47 V.J. Kutsch, "A Lightweight Cartridge Type Chaff Dispenser," NRL Memo Rept 802, June 1958
    - V.J. Kutsch, "Flight Evaluation of the ALE 18 Chaff Dispenser," NRL Memo Rept 953, June 1959
    - B.L. Miller, "Major Role in Electronic Air War Fanned by Radar Chaff," Aviation Week and Space Technology, 11 Mar 1968, pp 54, 55

## Chapter 9

# PRECISE RADIO FREQUENCY, TIME, AND TIME INTERVAL

### INTRODUCTION

The adherence of all radio transmissions to their assigned frequency channels with a high degree of precision is essential to the efficient utilization of the radio-frequency spectrum. Without the necessary frequency discipline, the value of this important world asset would be drastically reduced and automatic radio circuit operation rendered ineffective. As radio evolved during the passing years, the constantly increasing demand for more services with greater reliability required the attainment of increasingly higher frequency precision to provide the additional channels needed and the performance necessary to accommodate them.

From its establishment, NRI has been a pioneer and a leader in advancing the standardization of radio frequency and the precision and stability of frequency in radio transmission and reception. Since frequency and time are inter-related, NRI's efforts have included advances in the determination and utilization of time. The progress achieved in this respect has been due to the cooperative work with the Naval Observatory, which has the responsibility for the determination of official standard time and surveillance and control respecting the accuracy of its transmission. NRI's work has resulted in much of the equipment utilized by the military services and commercial organizations dealing with frequency and time functions. The NRI program, carried out over a period of many years, has brought about a tremendous increase in the worldwide accuracy, availability, and utility of both frequency and time.

### RADIO FREQUENCY CHANNEL ALLOCATION

The principal use of radio communication during the early days of the century was for the exchange of messages between ships at sea and land stations. This mode of communication soon became of great importance to safety at sea. However, it was not long before problems in operational procedures having international implications made their appearance. A station equipped with one radio system would refuse to accept messages from a station equipped with another system. No common radio channel was designated for calling and for distress signals. There was great freedom in each nation for radio stations to choose their own radio transmitting channels, generally related to the size of their antennas. The rapid rise in the number of radio stations and the increase in their power made the subject of mutual interference of considerable consequence. It was recognized that regulations dealing with these matters would have to be agreed upon and enforced by the participating nations of the world, if satisfactory use of the radio spectrum were to be effected. These problems and others arising subsequently were dealt with in a series of international radio conferences and related ratifying conventions, which have continued to the present day.<sup>1</sup> The Navy, through its representation on official delegations to these activities, has acted to protect the vital interests of the United States, as well as its own interests. Because of its superior experience, the Navy has made extensive contributions to these conferences which

have had important effects on the resulting international agreements.

The International Radio Conferences of 1903 and 1906, held in Berlin, made it compulsory for all coast stations to receive and forward messages irrespective of the particular radio system. The Third International Radio Conference, held in London in 1912, brought about the designation of 300 meters (1000 kHz) and 600 meters (500 kHz) as common calling and distress signal channels; the latter channel allocation continues to the present day. Except for these actions, allocations of radio channels were left to the discretion of the individual nations. Under the laws of 1910 and 1912, the United States required seagoing and Great Lakes ships to carry radio equipment and operators. They also required the licensing of all the country's radio stations and their operators, and limited amateur stations to wavelengths below 200 meters. Otherwise, there was great latitude in the choice of channel frequency, until the high-frequency band became available and the public interest in radio broadcasting was aroused.

NRI's work and that of other organizations, demonstrating the capability of the high frequencies with relatively low power to transmit via the ionosphere to tremendous distances, highlighted a potential interference problem of worldwide significance. This situation led to the Fourth International Radio Conference, held in Washington, DC, in 1927 and attended by representatives of 80 countries. In preparation for this conference, the Navy, based on the results of NRI's work and with its assistance, prepared a frequency allocation plan covering frequencies up to 25,000 kHz with allocations arranged by types of service.<sup>2</sup> At the time of the conference, a large percentage of the world's radio stations were being allowed a frequency tolerance of 0.1 percent. NRI's work demonstrated the feasibility of maintaining a frequency stability of 0.01 percent over a period of several months. As a result, the conference adopted the

Navy's frequency-allocation plan and agreed to require the maintenance of the authorized frequencies of radio stations as exactly as the state of the art permitted. The convention resulting from the conference became effective for the ratifying nations in 1929. The results of the convention were of far-reaching importance, since they established, for the first time, a high degree of order in the international use of the radio-frequency spectrum, making it possible for ships to operate on any part of the high seas without encountering undue interference. Furthermore, the agreement made possible a tremendous increase in the number of radio-frequency channels which could be assigned. The Navy's plan, as adopted by the conference, established a pattern which, as extended and modified in certain respects in subsequent conferences, has remained basically intact.

The 1927 International Radio Convention established the International Radio Consultative Committee, a body of scientists representing the participating nations, to provide technical support for the conventions, a function it carries out to the present day. Presently, this committee is advisory with respect to radio matters to the International Telecommunications Union, one of the permanent agencies of the United Nations organization. NRI has continued to be active in connection with the technical advisory function of this International Radio Consultative Committee. In this connection NRI has made contributions to advance channel allocation functions in the radio frequency spectrum, such as designations relative to the VHF and UHF bands; these contributions have been covered in other parts of this document.

The Fifth International Radio Conference was held in 1932 in Madrid, and the Sixth in 1938 in Cairo. The Cairo conference, attended by over 300 delegates, representing roughly 70 nations, was concerned with allocation of frequency channels up to 500 MHz. It was the first to deal with channel allocations for such services as television and certain aviation facilities. These

allocations were considered by the conference to be permanent, with the exception of the United States, which held them to be a basis for future research and experiment. The next conference was planned to be held in Rome in 1942, but World War II intervened. Further conferences were not held until the 1947 conference at Atlantic City, which considered channel allocations up to 10,000 MHz. From this time on, conferences have been held periodically on various aspects of radio-spectrum utilization. At various times NRL has been called upon to provide technical information to support the United States positions for these conferences.

In taking the initiative to deal with the radio-interference problem, which later was to receive worldwide consideration, a committee was established in 1922 through the cooperative efforts of the interested United States departments and agencies to coordinate their radio-channel requirements. In 1923 this committee became known as the Interdepartment Radio Advisory Committee and was given official sanction by the President of the United States in 1927.<sup>3</sup> The committee continues to be active in considering radio-frequency-allocation problems of government concern. NRL has continued to provide technical support to this committee. This committee agreed with and supported the 1927 radio-frequency-allocation plan devised by the Navy and offered for consideration at the international conference.

To meet its responsibilities in carrying out the provisions of the 1927 International Radio Convention agreement with respect to commercial radio stations, the United States Congress established the Federal Radio Commission in 1927. The Navy gave extensive assistance in activating this commission; NRL participated to a considerable degree in drafting the first regulations and specifications. In 1934 the scope of this commission was broadened when, through Congressional action, it became the present Federal Communications Commission.

### DESIGNATION OF RADIO SPECTRUM FUNCTIONS BY FREQUENCY

In the very early use of radio equipment, the period of circuit oscillation was expressed in "wavelength" rather than "frequency." This had been the practice since Heinrich Hertz's pioneering work (1887-1888), it being convenient to measure the wavelength, as he had done, by determining the distance between "nodes" and "antinodes" in a radio-frequency energy path. However, at the time the Navy acquired its first radio equipment (1902), existing stations operated on wavelengths in the range 100 to 1000 meters (3000 to 300 kHz), wavelengths so long as to make impractical their direct measurement by this method. Instead, the wavelength was determined from values of inductance and capacitance, calculated from the dimensions of precisely constructed structures, either of which was made variable and calibrated in wavelength. Such a wavemeter, with its inductance variable, was provided with the Navy's first radio equipment (1902). The resonance point was determined by observing the intensity of the spark in a needle-point spark-gap with which the wavemeter was provided. This crude device was followed by the neon tube, the hot-wire ammeter, and the thermocouple ammeter, which improved the accuracy of observation. However, this accuracy was limited to one part in  $10^3$ .

The "wavelength" method of expressing the period of circuit oscillation prevailed until the pressing need for additional radio channels arose, when it became apparent that channel separation was related to "frequency" rather than to "wavelength." Accordingly, in 1923 the Navy agreed, in conference with various government departments, henceforth to use the term "frequency."<sup>4</sup> NRL, as a strong advocate for this designation, was instrumental in having the concept and term "frequency" adopted by the 1927 International Radio Conference for worldwide usage.<sup>2</sup> NRL's pioneering work in the development of the higher frequencies had provided the basis for this acceptance.

PRECISE FREQUENCY AND TIME

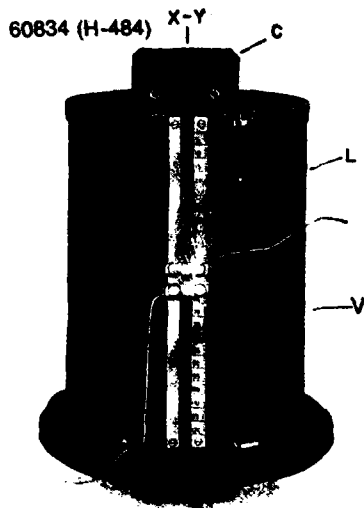

THE NAVY'S FIRST WAVEMETER

This wavemeter was provided with the Navy's first wireless equipment (Slaby-Arco System), produced by the General Electric Co., Berlin (1902). It comprised a fixed capacitor (C) paralleled by a needle-point spark gap (X-Y) and an inductance (L) with a variable contact (V) which varied the wavelength over a range of 100 to 400 meters. In operation, the transmitter was adjusted to provide the most intense "spark" in the spark gap at the desired wavelength.

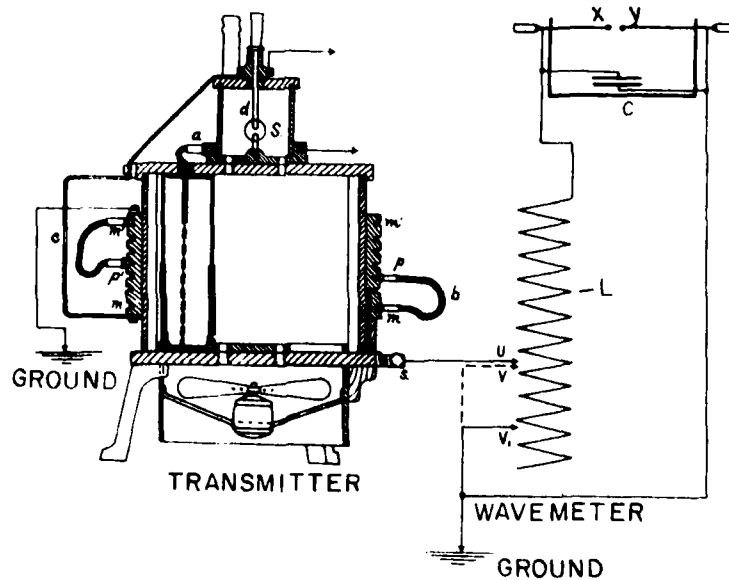

— ARCO TUNING DEVICE. —

DETERMINATION OF RADIO FREQUENCY FROM TIME

During the early 1920's the "tuning fork" was the standard of frequency. It was calibrated by comparing simultaneous recording of its

vibrations with time from a chronograph. Its accuracy was limited to 5 parts in  $10^5$ . The integrally related harmonics of the fork's frequency, obtained through a multivibrator, were used to obtain calibration points on wavemeters in terms of wavelength through calculation.<sup>5</sup>

## PRECISE FREQUENCY AND TIME

In improving upon the existing "tuning-fork" standard and its means of calibration, NRL was first to develop a calibrating method and to calibrate a quartz-crystal frequency standard (25 kHz) directly from official standard Naval Observatory time (1924).<sup>6</sup> The accuracy was thus increased to 1 part in  $10^5$ . The crystal calibrating equipment comprised a drum which was mounted on the shaft of a 500 cycle alternator. The drum carried a recording chart mounted on its surface. A stylus driven by one second time ticks from the Naval Radio Station at Arlington, Virginia, controlled from the Naval Observatory, provided dots made by the stylus on the chart. In making observations, the various

harmonics of the alternator output were compared with the frequency of the source to be measured and the speed of the alternator adjusted to "zero-beat," the precise phase being indicated by a galvanometer. The spacing of the dots on the recording permitted determination of the frequency of the alternator and, through the particular number of the harmonic, the frequency of the source to be measured. The first measurement of a quartz-crystal frequency was made as early as 1923, but indirectly, using a chronometer calibrated from Naval Observatory time to provide the timing.

Since the accuracy of frequency of quartz crystal standards was directly dependent upon



THE FIRST CALIBRATION OF A QUARTZ CRYSTAL FREQUENCY STANDARD DIRECTLY FROM NAVAL OBSERVATORY TIME (1924)

NRL developed the method which employed a motor driven alternator carrying a time recording drum on its shaft (left end). A harmonic of the alternator was adjusted, through control of speed, to "zero beat" with the output of the quartz crystal. The frequency was determined from the time recordings on the drum.



## PRECISE FREQUENCY AND TIME

the accuracy of the Naval Observatory's standard of time, considerable future effort of the Laboratory was devoted to advancing the quality of the standard of time. This subject will be treated later in this chapter.

### RADIO FREQUENCY STANDARDS AND INSTRUMENTATION

In 1923, the Bureau of Engineering requested the Laboratory to conduct a survey in the Fleet to determine the need for radio-frequency meters of much higher accuracy to control radio-channel emissions beyond the capability of the existing wavemeters. To accomplish this survey, NRL developed the Navy's first heterodyne radio-frequency meter (1923). During January 1924, NRL conducted the survey, using two of these instruments.<sup>7</sup> The results confirmed and emphasized the need for higher accuracy. To

provide this accuracy, NRL developed the first radio-frequency meter for operational use in setting the frequencies of Navy radio equipment (125 to 4000 kHz, type SE 2307) (1924).<sup>8</sup> A considerable number of these instruments were produced by the Washington Navy Yard and distributed to the Fleet and shore stations (1926). The Army also obtained these instruments from the Navy for their use.

These meters, which were of the heterodyne type, required periodic recalibration. To permit recalibration to be done in the Fleet, in 1925 NRL developed the Fleet's first quartz-crystal radio-frequency standard (50 kHz) which, as combined with harmonic-generation circuitry, was also the Fleet's first crystal-controlled frequency calibrator (50 to 8000 kHz, type SE 2907).<sup>9</sup> These calibrators were made available to the Fleet and shore stations in quantities in 1926. This instrumentation was

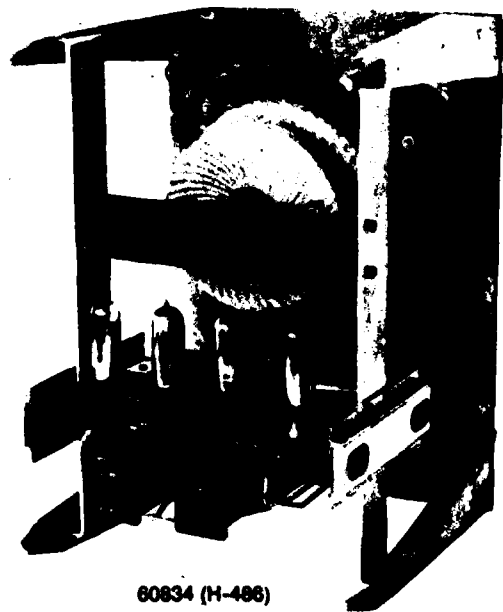
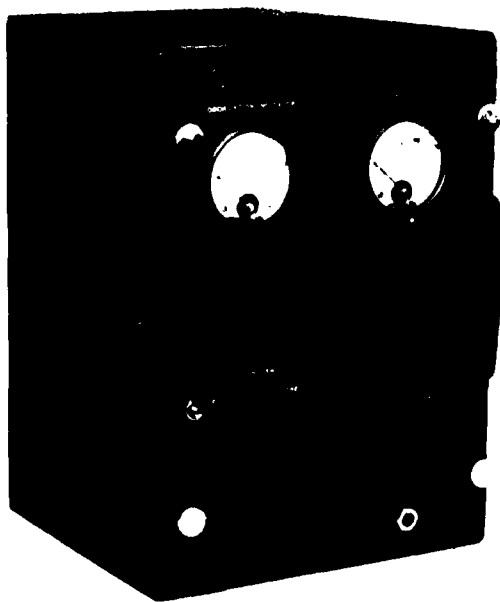

60834 (H-486)

### THE NAVY'S FIRST QUARTZ CRYSTAL RADIO FREQUENCY STANDARD (1925)

This NRL-developed standard, the type SE 2907, permitted accurate calibration of the heterodyne frequency meters (SE 2307) previously furnished, which served to maintain radio equipment on assigned high frequency channels. It was provided to the Fleet in quantities (1926).

the beginning of the development of a long series of improved radio-frequency meters which has continued to the present day and to which NRL has made major original contributions. As a preliminary effort toward standardization of radio frequency, NRL's type SE 2907 quartz-crystal oscillator standard was compared with the Bureau of Standard's tuning-fork standard and found superior to it in accuracy.<sup>10</sup>

### FREQUENCY STANDARDIZATION

With the Navy's increasing procurement of high-frequency equipment, the need for high accuracy in frequency standardization among the commercial suppliers of this equipment became urgent. During 1926 NRL developed a quartz-crystal standard oscillator employing a 25-kHz crystal having its temperature controlled for higher accuracy, the type SE 4376. With additional 50-kHz (type SE 4376A) and 200-kHz crystals (type SE 4376B), the standard oscillators permitted standardization of the entire high-frequency band. These quartz-crystal oscillators became the Navy's principal radio-frequency standards, and the first national quartz-crystal-oscillator radio-frequency standards.<sup>6,11</sup> NRL initiated radio-frequency standardization among commercial suppliers of the Navy equipment by circulating these standards for comparison and coordination among several organizations, including the Bell Telephone Laboratories, RCA, the General Electric Company, and the Bureau of Standards (1927). In March 1927, the NRL 25-kHz standard was taken to the Bell Telephone Laboratories and compared with their frequency standard, which was then a 50-cycle electrically driven tuning fork. The two standards agreed during a three-day trial to one part in 130,000. Subsequent to the round of comparisons of NRL's quartz-crystal standards, the Bureau of Standards, which at that time was using a tuning fork as its standard, requested NRL to furnish them quartz-crystal standards

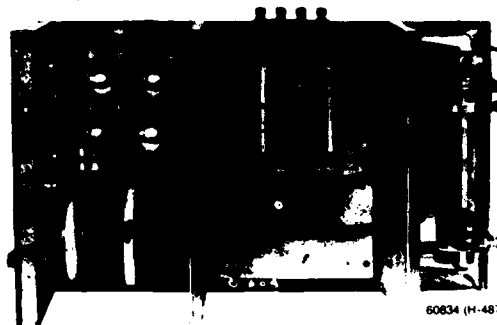
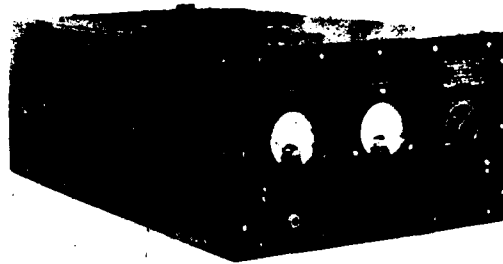

THE FIRST NATIONAL  
QUARTZ-CRYSTAL OSCILLATOR RADIO  
FREQUENCY STANDARD (1927)

This crystal controlled oscillator standard, developed by NRL (1926), using three quartz crystals, permitted standardization of the entire high-frequency band. It was the Navy's principal radio frequency standard. For national standardization, it was circulated among commercial suppliers of Navy equipment and other organizations, including the Bell Telephone Laboratories, RCA, the General Electric Co., and the National Bureau of Standards (1927).

operating at 100 kHz and 250 kHz. NRL delivered these standards to the Bureau of Standards in May 1929.<sup>12</sup>

NRL also initiated high-precision international radio frequency standardization comparisons (Oct. 1928).<sup>13</sup> Transmissions were made by NRL on 17,746 kHz which were observed by the National Physical Laboratories, Teddington, England. These comparisons continued for several years. At this time the British were still using a temperature-controlled, electrically driven tuning fork located in an

## PRECISE FREQUENCY AND TIME

60834 (H-488)

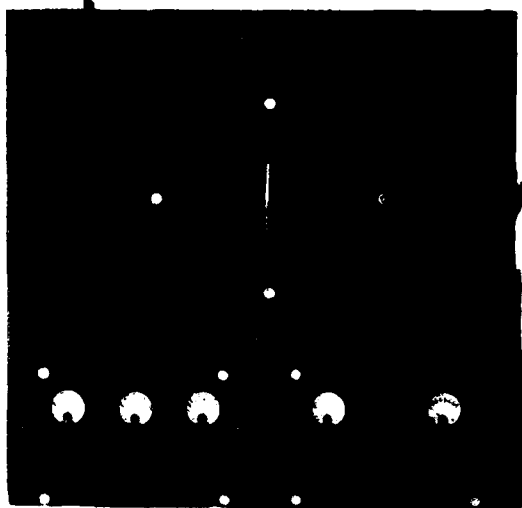

60834 (H-489)

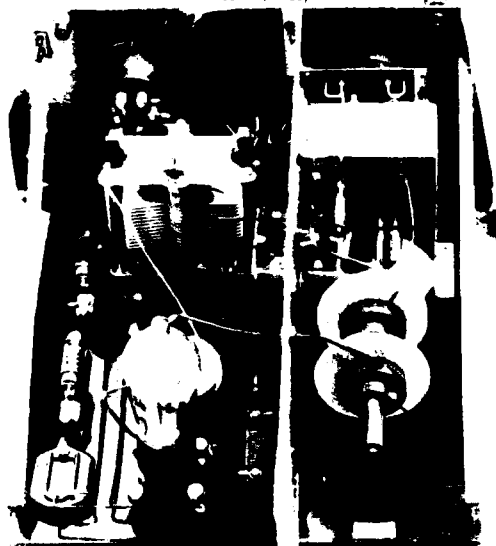

QUARTZ-CRYSTAL-CONTROLLED OSCILLATOR RADIO-FREQUENCY STANDARD FURNISHED TO THE NATIONAL BUREAU OF STANDARDS BY NRL FOR THEIR FREQUENCY STANDARDIZATION (1929)

underground temperature-insulated vault. Nevertheless, agreement of standards to within 2 parts in  $10^5$  was achieved.

### RADIO-FREQUENCY METERS FOR THE HIGHER FREQUENCIES

As the Navy began to utilize increasingly higher radio frequencies for communication, the need arose for radio-frequency meters of correspondingly higher frequency ranges. To meet this need, NRL was first to develop a high-precision radio-frequency meter to cover the entire high-frequency band (1927).<sup>14</sup> This equipment was the first to be used in the Fleet and at shore stations to maintain communication equipments operating in any part of the entire high-frequency band on assigned frequencies (SE 4379, heterodyne; SE 4389, calibrator) (4000 to 20,000 kHz). They were furnished to the operating Navy in 1928.

To provide further increase in the accuracy of maintaining the Navy's radio emissions on their assigned frequency, NRL developed the first radio-frequency meter to incorporate a quartz-crystal-standard oscillator-driven clock which permitted comparison and adjustment in the field through observations made directly from Naval Observatory time-signal transmissions (1927-1930).<sup>15</sup> This equipment, designated the Model LF (30 to 30,000 kHz), provided an accuracy of one part in  $10^5$ . This equipment was installed at the Navy's stations at San Francisco, Hawaii, and the Panama Canal Zone. Radio-frequency meters of this type, but without clocks (Model LG), were installed as standards aboard Naval flagships.

NRL developed the first high-precision radio-frequency meter suitable for use in aircraft covering both the medium and high radio-frequency bands (195 to 20,000 kHz) (1934).<sup>16</sup> Designated the Model LM, it employed a single quartz-crystal standard with a

## PRECISE FREQUENCY AND TIME

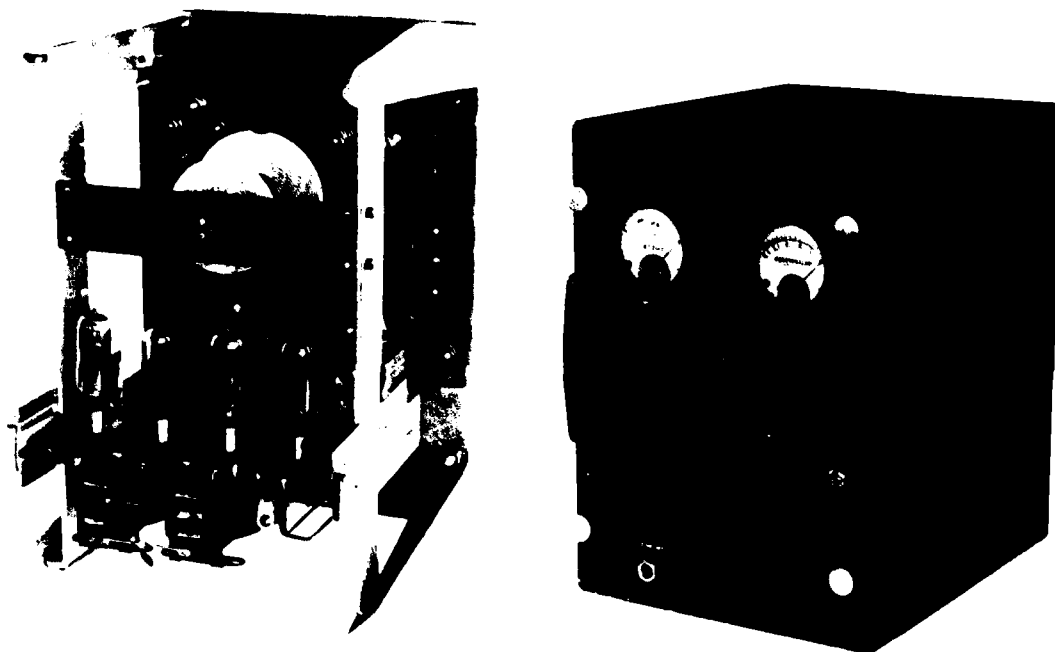

60834 (M 490)

### THE FLEET'S FIRST RADIO-FREQUENCY-MEASURING EQUIPMENT COVERING THE ENTIRE HIGH-FREQUENCY BAND (1927)

This equipment, developed by NRL, comprised the Model SE-4379 heterodyne and the Model SE-4389 calibrator. Only the latter is shown.

low-temperature-coefficient 1-MHz crystal for calibration. It was capable of an accuracy of 0.02 percent. Its compactness, light weight, and flexibility brought about extension of its application to universal use. Thousands of Model LM meters were procured and used, particularly during World War II. The Army also made extensive use of this meter, giving it the designation type BC-221 but retaining its essential features. Many of these instruments remained in operational use for over a quarter century. A considerable number are still being used by nongovernment activities.

### RADIO FREQUENCY MONITORING SYSTEM

In 1944 the Navy planned to establish a radio-frequency-monitoring system to provide

worldwide surveillance of the frequency of its own radio transmissions and those of other nations, with a frequency range covering the very low through the high-frequency bands. It requested NRL to develop the required equipment, which would be capable of rapid measurement of frequency with the highest degree of accuracy then possible. Accordingly, NRL developed the first radio-frequency-monitoring equipment for worldwide surveillance of radio emissions covering a frequency range from 16 to 27,000 kHz and capable of measuring frequencies with an accuracy of one part in  $10^7$ , or one cycle (1946).<sup>17</sup> These equipments (Model LAM) were installed at Navy operating stations in San Francisco and Washington, D.C., with one at NRL in 1946.

Subsequently, the equipment's frequency range was broadened to cover from 14 kHz to

PRECISE FREQUENCY AND TIME

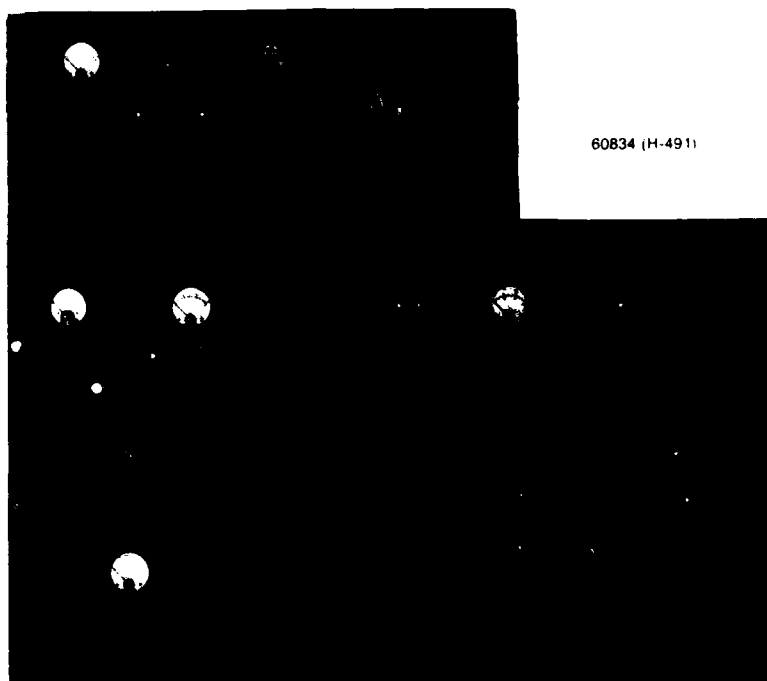

60834 (H-491)

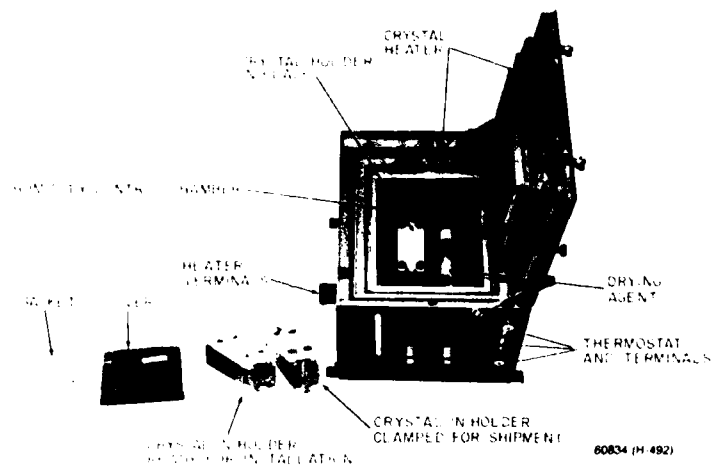

60834 (H-492)

**THE NAVY'S FIRST RADIO FREQUENCY-MEASURING EQUIPMENT INCORPORATING A QUARTZ-CRYSTAL-DRIVEN CLOCK WHICH PERMITTED DIRECT COMPARISONS WITH OFFICIAL NAVAL OBSERVATORY TIME TRANSMISSIONS**

This equipment was developed at NRI between 1927 and 1930. It provided higher accuracy in radio-spectrum channel adherence in radio transmissions. Known as the Model 1E, it was the first equipment to cover the frequency range of 30 to 30,000 kHz. It was used on Fleet flagships and at shore stations. The crystal oscillator details are shown below.

PRECISE FREQUENCY AND TIME

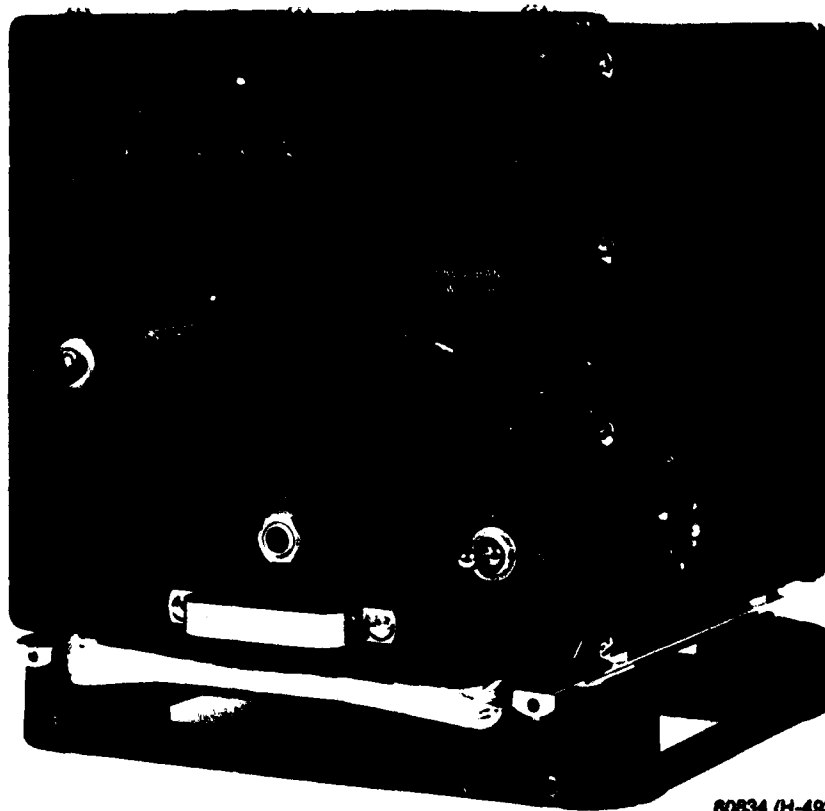

60834 (H-493)

**THE FIRST AIRCRAFT PRECISION RADIO-FREQUENCY METER FOR  
RADIO-CHANNEL ADHERENCE (1934)**

This meter employed a single quartz-crystal calibrator to cover the range 195 to 20,000 kHz. The simplicity, compactness, and utility of this NRL-developed meter brought about universal usage.

PRECISE FREQUENCY AND TIME

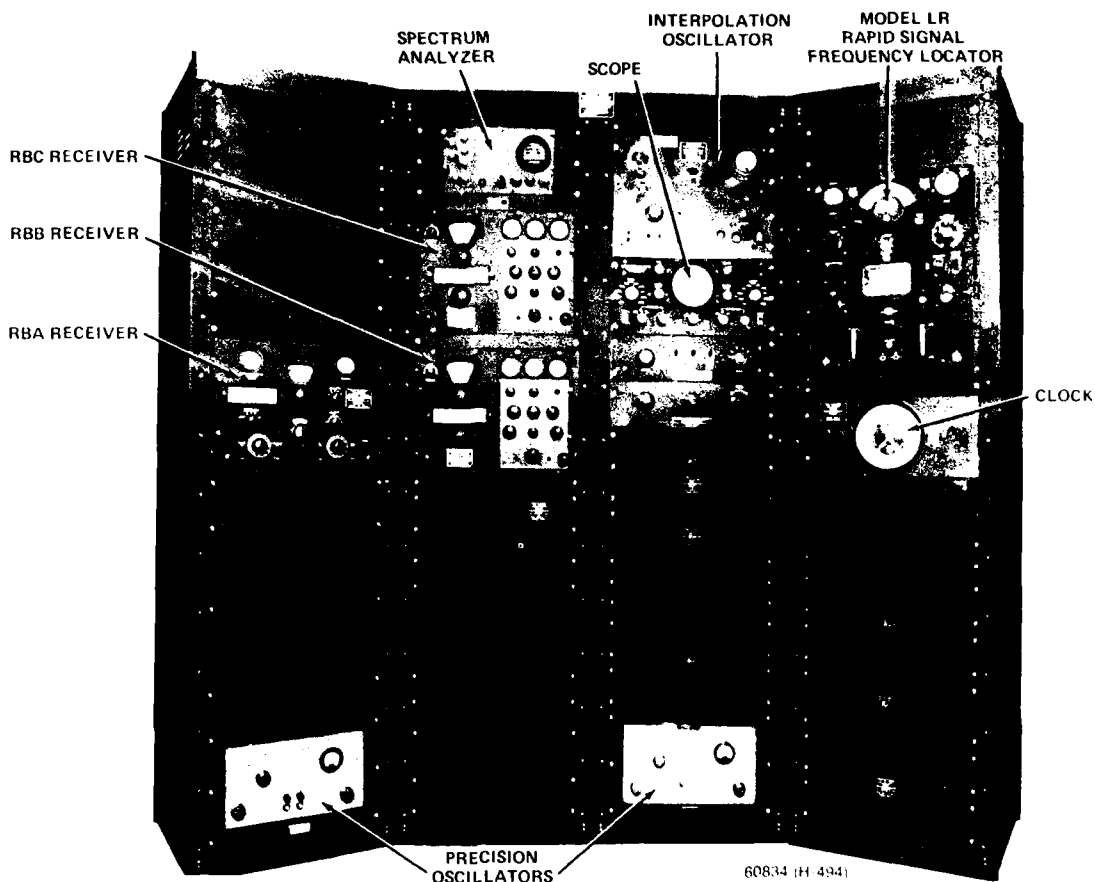

THE FIRST RADIO-FREQUENCY-MONITORING EQUIPMENT FOR WORLDWIDE SURVEILLANCE OF SHIP AND SHORE RADIO EMISSIONS (1946)

This NRL developed equipment, designated the Model LAM (later the AN FRM-5), was installed at Naval radio stations throughout the world for action necessary to maintain all Naval radio transmissions on their assigned frequency channels. The RBA receiver (left panel, upper unit), RBB receiver (next right unit), and RBC receiver (above the RBB) provide frequency coverage of 16 to 27,000 kHz; the other units provide the necessary instrumentation.

400 MHz, and it was redesignated the AN FRM-3 (1950).<sup>18</sup> A considerable quantity of these equipments was obtained from commercial sources working under NRL guidance. The equipment was installed in all Naval districts at certain strategic Naval stations throughout the world, and at certain Navy Yards and laboratories. The equipment also provided a means of accurately checking frequencies during the

development, construction, and inspection of radio equipment being procured. The equipment used a 100-kHz high-precision quartz-crystal oscillator standard, with a system of precisely controlled frequency multipliers and dividers to produce three series of interlaced spectrums of harmonics with basic rate of 9, 10, and 11 kHz. The resulting frequency difference between standards was then measured accurately at the

audio-frequency level, using an interpolation oscillator and a cathode-ray tube with a Lissajous pattern.

### HIGH PRECISION FREQUENCY COMPARATOR

NRL was first to devise a method of instantaneous precise comparison of the frequency stability of highly stable radio-frequency oscillators capable of an accuracy of one part in  $10^{10}$ , to accelerate the advancement of radio-frequency standardization (1947-1962).<sup>19</sup> With NRL's method, frequency differences could be continuously recorded, tremendously

reducing the time previously required in oscillator comparisons. NRL's method is now in worldwide use. In 1951 the original capability of the method of 1 part in  $10^7$  was increased to 1 part in  $10^9$  through NRL's development of an error-multiplier technique. This made feasible for the first time (1951) the rapid, precise comparison of the frequencies of the bank of quartz-crystal oscillators then used in the determination of official standard time for the United States by the Naval Observatory. The method came into general use in the Navy in 1954. In 1962 NRL further increased the accuracy of the method to one part in  $10^{10}$  by devising a crystal-discriminator and active-filter technique

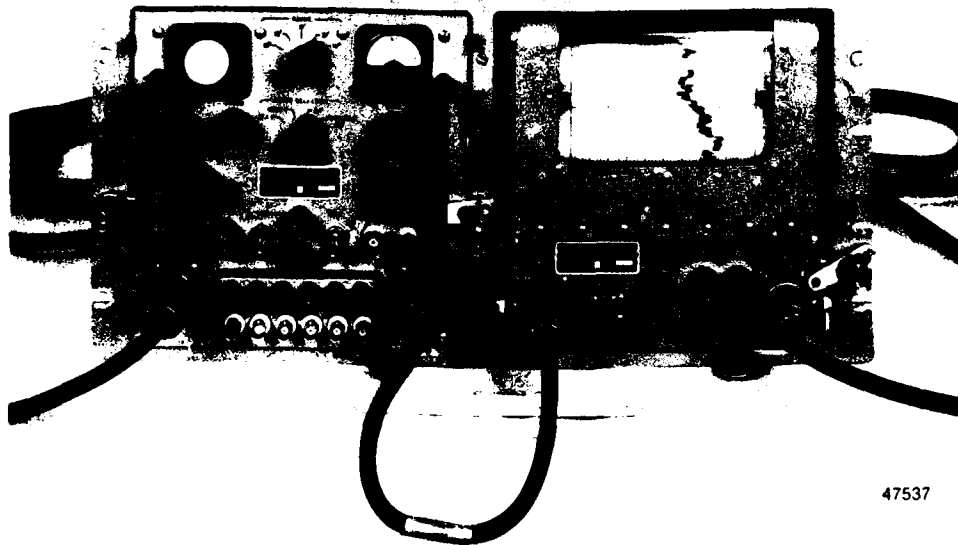

47537

HIGH-PRECISION FREQUENCY COMPARATOR (FREQUENCY DEVIATION METER)

This instrument was first to permit instantaneous comparisons of highly stable oscillators with an accuracy of one part in  $10^{10}$  (1947-1962). The method and the equipment developed by NRL tremendously reduced the time required to make such comparisons. It is now in worldwide use. Frequency difference is continuously recorded.



**DECADE FREQUENCY SYNTHESIZER**

For many years there had been sought a means of generating highly precise radio frequency, selectable on a decade basis, for both transmission and measurement purposes. Various methods were devised involving the use of both single and combinations of precise crystal-controlled oscillators. However, these methods utilized continuous self-oscillators to interpolate between steps to provide the required fine gradations of frequency. Previous attempts to produce the small frequency increments on a decade basis introduced unacceptable spurious frequency components in the output. NRL was first to

develop a decade frequency synthesizer which generated output radio frequencies of high purity, equal in frequency precision to that of the input standard, from a single-crystal frequency standard and selectable on a decade basis with digital increments of any desired degree, the smaller increments having no detrimental effect on output purity (1949).<sup>20</sup> Each decade could be selected either manually or automatically, in accordance with a program digitally controlled. The synthesizer could be frequency-switched at a rapid rate, a feature of importance to certain communication systems. NRL's synthesizer has been used extensively by the Navy, other government organ-

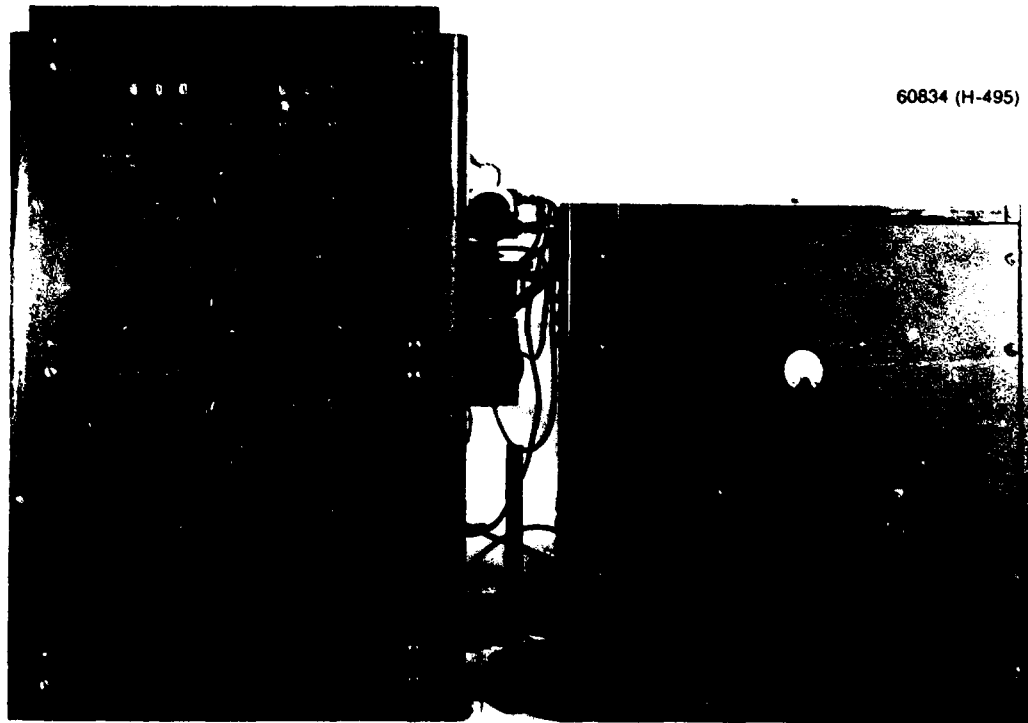

**THE FIRST HIGH-PURITY-OUTPUT DECADE FREQUENCY SYNTHESIZER**

This synthesizer generated an output equal in frequency precision to that of the input standard from a single crystal frequency standard and selectable on a decade basis with digital increments of any desired degree. NRL's original model, shown here, covered a frequency range of 1 Hz to 10 MHz.

izations, and commercial interests in controlling the frequencies of transmitters and receivers for radio communications, navigation, radar, standard time and frequency transmissions, and for measurement and other useful functions. The latest versions of NRL's synthesizer utilized solid-state components. The synthesizer was made possible through NRL's choice of special combinations of electronic algebraic operations and its development of a locked-oscillator-frequency-divider technique which inherently provided filtration of undesirable frequency components. Spurious output components were eliminated by avoiding the use of harmonic steps less than the ninth in the frequency divider chain. With the proper choice of algebraic combinations, any frequency output down to the cycle or any desired decimal fraction thereof can be produced with the precision of the basic input frequency standard. The first production of the synthesizer (Model AN USM-110) had a frequency range of 0.01 Hz to 1 MHz in 0.01-Hz steps (1953). With this model, higher radio frequencies were obtained through frequency multiplication. In 1957 the frequency range was extended to 100 MHz in the Model AN USM-111, and still later to 100 MHz. Available in 1963, the Model AN USM-194, commercially known as the HP 5100 with a frequency range of 50 Hz to 50 MHz, has been a very popular and widely used synthesizer.

#### HIGH PRECISION SHIPBOARD RADIO FREQUENCY STANDARD

The Navy required a radio frequency standard for shipboard installation having precision higher than those then available for the surveillance of the frequency of its radio transmitters and receivers and for time and time interval functions. The precision of frequency of existing shipboard equipment for these uses was then limited to one part in  $10^6$ . The higher precision standards which had been developed for use

ashore were not sufficiently rugged to provide satisfactory performance at sea. Under Bureau sponsorship, NRL provided the necessary guidance of a contractor to develop a satisfactory shipboard quartz-crystal frequency standard which had a precision of one part in  $10^8$ , two orders better than the precision previously available (Model AN/URQ-9) (1952).<sup>21</sup> This standard employed a 5-MHz quartz crystal of special design, utilizing the fifth overtone of 1 MHz, which was less susceptible to ship's motion. Further improvement in the utilization of this standard aboard ship was obtained in the subsequent Model AN/URQ-10 through the use of solid-state components, which reduced the physical size to one-third (1961). These quartz crystal frequency standards were used throughout the Fleet.

#### NAVAL TASK FORCE RADIO FREQUENCY MONITORING SYSTEM

At the request of the Fleet and the Navy Department, NRL devised equipment and provided it to assess the effectiveness of maintaining radio communications during the operations of the task force exercises known as "Baseline II," involving a large number of ships and held in the Pacific Ocean area in 1960. Observations with NRL's equipment established that the existing radio-frequency monitoring facilities were quite inadequate to insure the degree of assigned channel adherence considered essential for the reliability necessary in task-force operations. Principal reliance for the frequency-monitoring function was placed on the monitoring system established ashore. The remoteness of this system impeded the immediate corrective action necessary aboard the individual task-force ships. Furthermore, the monitoring facilities which existed within the task force were not adequate. The situation resulted in intolerable failure to maintain a large percentage of the radio circuits on their assigned channels, causing unacceptable delay and unreliability in important

60834 (H-496)

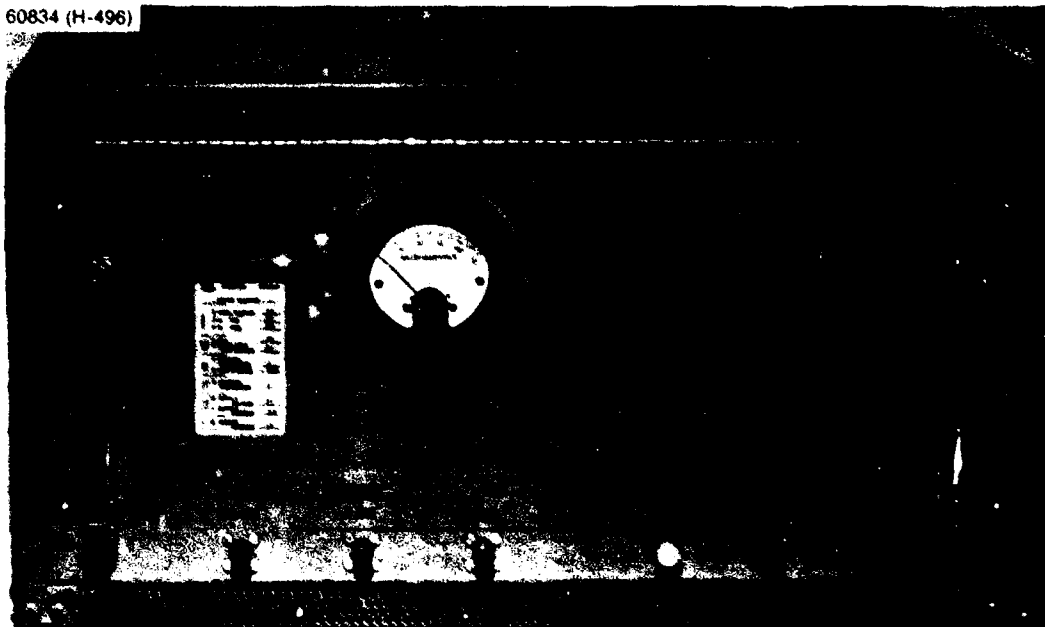

THE FIRST SATISFACTORY SHIPBOARD QUARTZ CRYSTAL FREQUENCY STANDARD WITH A PRECISION OF ONE PART IN  $10^9$

This standard, Model AN URQ-9, had a precision two orders better than the precision previously available. This quartz crystal frequency standard was developed by NRI (1957) in cooperation with a contractor.

communications. As a result of pressure for immediate action, NRI developed the first Naval task force radio frequency monitoring system, which permitted task forces, themselves, through local monitoring and immediate corrective action, to maintain their radio circuits on their respective assigned frequency channels, greatly enhancing the effectiveness and reliability of their radio communications (1966).<sup>27</sup> NRI's system permitted, for the first time, proper monitoring of sideband multichannel frequencies, an area previously responsible for considerable circuit unreliability. NRI's system was widely used by the Fleet and saw lengthy service in support of Naval operations. Due to urgent need in the Fleet for adequate communication circuit maintenance, NRI, in a special effort, furnished 50

equipments within a period of six months.<sup>28</sup>

Additional equipments required were obtained from commercial sources under NRI's guidance. These equipments were installed on flagships and other major ships of the Fleet in a position to bring about necessary immediate corrective action. NRI's development was the basis of the Navy's communication quality control console, the AN SSQ-25.

#### ATOMIC FREQUENCY STANDARDS

The utilization of the atomic resonance phenomena of certain vapors and gases such as ammonia, cesium, rubidium, and hydrogen has been considered a possible means of providing a radio frequency standard of superior accuracy. Through the sponsorship of the Office of

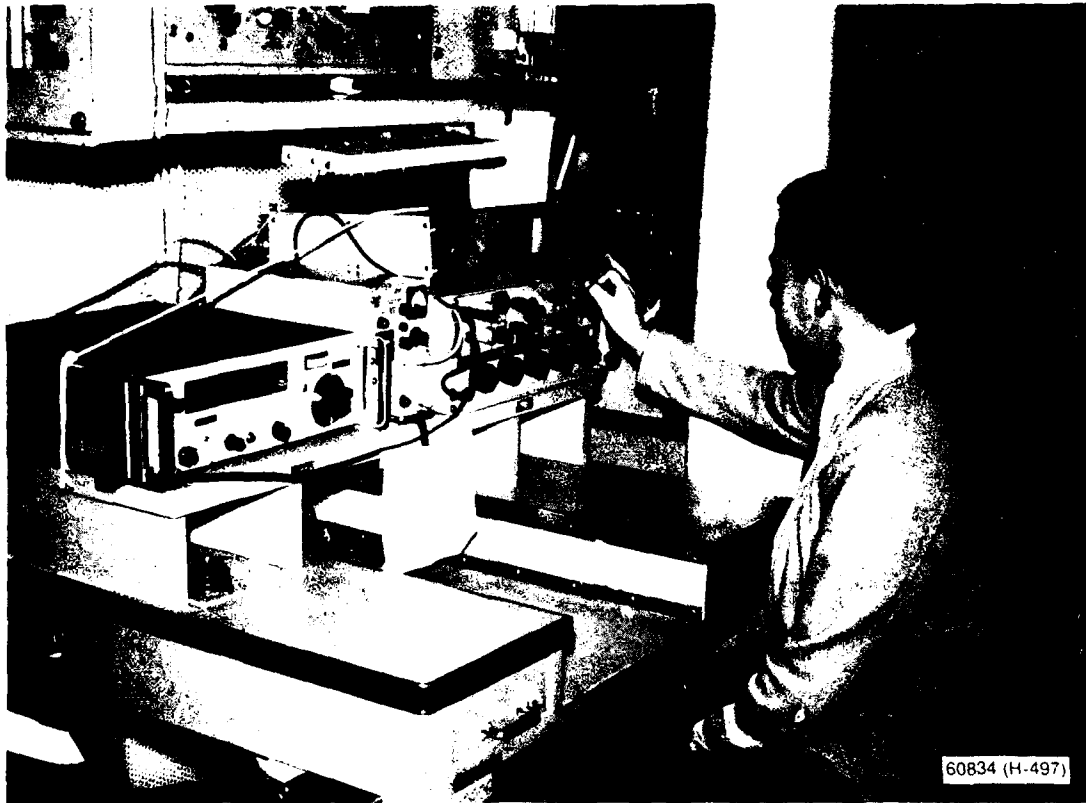

THE FIRST RADIO-FREQUENCY-MONITORING SYSTEM FOR SELF-MONITORING TRANSMISSIONS BY NAVAL TASK FORCES

With this system, immediate action could be taken to maintain radio circuits on their assigned frequency channels. The NRL-developed equipment, shown installed on the cruiser USS ST. PAUL (CA-73), was demonstrated during the First Fleet exercise, "Baseline II" held in Pacific waters in 1966. Its effectiveness led to its immediate installation throughout the main operating forces of the Navy. The system permitted, for the first time, adequate monitoring of sideband multichannel frequencies, previously a major cause of circuit unreliability.

Naval Research and the Navy Bureaus, NRL has participated in a development with the National Company, Malden, Massachusetts, involving the adaptation of the cesium-beam resonance principle to provide the first cesium-beam frequency standard for service use.<sup>23</sup> In 1956 NRL received the first cesium-beam standard and carried out investigations of its accuracy and general performance in collaboration with the Naval Observatory and with the National Physical Laboratory of Teddington, England. Through a special cir-

cuit set up between NRL and the Naval Observatory, this standard was used in the first determination of standard atomic time (A-1) for the United States (1956). The cesium beam was adopted by the International Conference on Weights and Measures, held in Atlantic City in 1967, as the international standard of frequency relative to the second, operating at 9192.631770 MHz (1967).<sup>24</sup> It can be relied upon to provide frequency accuracy to better than one part in  $10^{11}$ , one order higher than that previously attained.

PRECISE FREQUENCY AND TIME

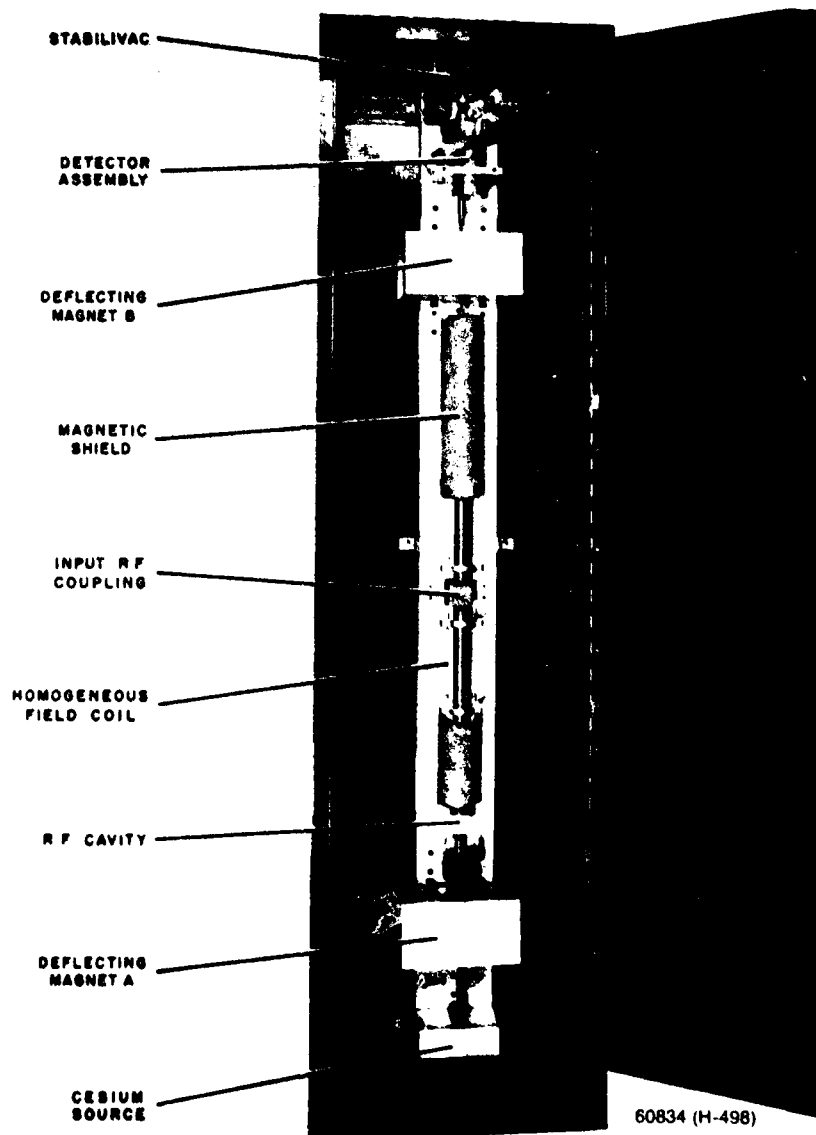

THE FIRST ADAPTATION OF THE CESIUM-BEAM-RESONANCE PRINCIPLE TO PROVIDE A FREQUENCY STANDARD FOR SERVICE USE

The standard was developed by NRL (1956) in cooperation with a contractor. It can be relied upon to provide an accuracy of frequency better than one part in  $10^{11}$ , one order higher than that previously available. This view of the standard shows the beam tube with its magnetic shield removed to show the radio-frequency structure.

Furthermore, the standard is not subject to the aging effects of the physical structure of quartz crystals. Therefore, there is no associated long-term frequency drift. NRI has also participated in adaptations of the standard to important installations now existing in the Naval Service for precise frequency, time, and time interval functions.

The cesium beam is a passive device possessing sharp resonance phenomena which can be utilized precisely to control the frequency of a 5 MHz quartz crystal oscillator. Through a frequency divider, an area of NRI expertise, the oscillator provides the energy required to support the cesium beam's atomic function. The crystal oscillator output also drives a frequency synthesizer to provide the desired output frequency.

#### ATOMIC HYDROGEN MASER FREQUENCY STANDARD

Unlike the passive cesium beam technique, the atomic hydrogen maser is a generator of radio frequency energy, although at very low power level. Under the sponsorship of the Office of Naval Research, NRI obtained two hydrogen masers to investigate the possibility of using a maser of this type as a high precision standard. As a result of its efforts, NRI was first to develop a practical atomic hydrogen maser frequency standard (1964).<sup>25</sup> This standard has proved superior to the cesium-beam standard in short-term frequency stability. Through transmission over a special radio link, the Naval Observatory has used NRI's hydrogen maser frequency standard in its determination of standard time and time interval. The latest derived frequency of the hydrogen maser frequency standard is  $1,420,405,751.7755 \pm 0.0031$  Hz.<sup>26</sup> This standard utilizes techniques similar to those utilized in the cesium-beam frequency standard for the precise control of the frequency of a quartz crystal oscillator. This crystal oscillator then provides the required output frequency through the use of a frequency synthesizer.

The very low level of the power generated by the hydrogen maser has been a deterrent to its use as a direct frequency standard, instead of as a control device for a quartz crystal oscillator. NRI has made possible for the first time, by devising a frequency-divider-amplifier technique, a hydrogen maser radio-frequency standard in which the atomic oscillations directly control the frequency of the standard's output, which is adequate to operate frequency synthesizers to produce any desired frequency (1972).<sup>27</sup> The high frequency precision, stability, and spectral purity of the atomic oscillations are preserved in the output. The previously necessary crystal oscillator and its aging effects are avoided.

#### OFFICIAL STANDARD TIME FOR THE UNITED STATES

The Navy's decision in 1923 to express radio circuit oscillation in "frequency" instead of "wavelength" required reliance upon time for standardization and provided an additional incentive to insure the accuracy of time and time interval. The Navy, in view of its important need of time for navigation, had long had great interest in advancing both the precision of standard time and its dissemination to ships at sea. In 1830 it established a Depot of Charts and Instruments in Washington, DC, which provided service for its ships' chronometers to insure their accuracy. This Depot was renamed the Naval Observatory in 1884. This title was officially recognized by Congress in an appropriation act of 16 Aug. 1956 (11 Sta. L., 44, 47). Although the Observatory since its establishment had continued to improve equipment for astronomical observations for the determination of time, it was provided with superior astronomical observation capability when it was moved from a temporary location to its present site in Washington, DC, in 1893.<sup>28</sup>

The Naval Observatory became recognized as the official source of standard time for the United States. Its authority and responsibility in this regard for the military organizations of

PRECISE FREQUENCY AND TIME

57635



THE FIRST PRACTICAL ATOMIC HYDROGEN MASER RADIO FREQUENCY STANDARD

NRI developed this standard in cooperation with a contractor sponsored by the Office of Naval Research, 1961. The Naval Observatory had been using this standard in its determination of standard time and time interval through transmissions over a special radio link between NRI and the Observatory. H. F. Hastings, who was responsible for the conduct of the Laboratory's precise frequency and time program during the period 1944 to 1965, is shown between the two hydrogen maser standards.

the United States were declared by the Department of Defense (1971).<sup>29</sup> The Observatory began providing standard time service to the nation via transmissions over telegraph lines in 1864. The Navy was first to establish official scheduled transmissions of standard time signals by radio, so that ships at sea could check their chronometers frequently, antedating all similar services by at least 19 years (1904). These transmissions were made from its Boston Navy Yard Radio Station. This was accomplished on an experimental basis from its station at Navesink, New Jersey a year earlier. Thereafter, the Navy's transmission of standard time signals was extended to a number of its radio stations located at strategic coastal points of the country. Beginning in December 1912, the Navy's scheduled time transmissions were placed on a nationwide coverage basis with the availability of its new "Radio Central" station at Arlington, Virginia (NAA), at that time the world's most powerful station (2653 meters, 113 kHz).<sup>30</sup> This dissemination of standard time by the Navy with surveillance for accuracy by the Naval Observatory continues to the present day from the Navy's several radio stations, delegated to provide time service, with worldwide coverage. In cooperation with the Naval Observatory, NRL has made many contributions to advance the determination, coverage, accuracy, and utility of standard time and time interval, some of which have already been indicated.

#### STANDARD TIME TRANSMISSIONS WITH QUARTZ-CRYSTAL CLOCK

In its transmissions of standard time signals, the Naval Observatory, prior to 1934, used pendulum type clocks, checked through astronomical observations. Undesirable inaccuracies were encountered with these clocks, because of actuation of contacts required to produce time signals. To improve both the accuracy of producing the time signals and also the determination of time, NRL was requested by the Naval Observatory under the sponsorship of the Bureau of Engi-

neering to provide a quartz-crystal oscillator-controlled clock (1931).<sup>31</sup> At this time, NRL was advancing its quartz-crystal frequency standards, frequency divider, and clock-operation techniques in providing a frequency standard for the Fleet, the Model LF. Since the General Radio Company had produced the synchronous motor for this equipment, NRL placed a contract with this organization to provide the clock for the Naval Observatory. The resulting device used a 30-kHz quartz-crystal oscillator which, through the use of a frequency divider, drove a 1000-Hz synchronous motor geared to a shaft which rotated once per second. The shaft carried a master cam contactor, producing the time signals. The shaft also carried a dial, illuminated by a neon tube, caused to flash by the contactor, which permitted observation of the precise time of contact and its adjustment to the required time.

Another important feature of the new clock was its use in connection with the Observatory's "Photographic Zenith Tube" (PZT) in the determination of standard time. The PZT comprised a rigidly mounted vertical tube with an objective and a photographic plate carriage at the top and a mercury basin at the lower end. Light from stars near the zenith of the observatory was reflected from the surface of the mercury and recorded on the plate mounted on the carriage. Sharp star images were obtained due to the east-west movement of the carriage, driven through a mechanism by the quartz-crystal oscillator at a rate compensating for the earth's rotation during the exposure. Through a procedure involving measurement of the images on the plate, the time of star transit of the meridian could be obtained. On a clear night as many as 20 star images could be recorded. The quartz-crystal clock equipment was placed in operation by the observatory in May 1934. It remained in service for a considerable period, during which improvement in accuracy was obtained by modifying the mounting of the quartz crystal and enclosing it in an evacuated chamber to reduce the effects of changes in barometric pressure.



**TIME TRANSMISSION EQUIPMENT  
FOR REMOTE STATIONS**

In 1951 the Navy required further increase in the accuracy and reliability in the transmission of its time signals. It had been transmitting time on high frequencies from its stations at Annapolis, San Francisco, Hawaii, and Balboa in the Panama Canal Zone, accomplished through the use of a telegraph line from the Naval Observatory to Annapolis and thence via radio relay to the remote stations. Variable errors had been experienced of up to 20 milliseconds in the Annapolis transmissions and over 100 milliseconds from the Hawaii and Balboa transmissions. After an unsatisfactory attempt to obtain improvements from commercial sources, NRL was requested to undertake the problem. NRL investigations revealed that the inaccuracies and unreliability were due to several factors, including variations in the wire line and in propagation, the reliance upon mechanical contactors to produce the time signals, and inadequacies in the time determination and transmission equipment at the Naval Observatory.

In dealing with this problem, NRL was first to develop a standard time-transmission system in which the several remote stations were provided with equipment to generate their own time-transmission signals with a high degree of accuracy, the errors of which could quickly be corrected by means of observations made at the Naval Observatory in Washington, D.C. (1953).<sup>32</sup> The NRL-developed time-transmitting equipment (Model AN/FSM-5A) was first to utilize the leading edge of continuous-wave transmitted pulses generated by a quartz-crystal oscillator as a means of indicating a desired precise moment of time. This equipment was installed at all the Navy's time transmitting stations which provided coverage of the Atlantic and Pacific Ocean areas. The new system made possible for the first time transmissions from widely separated transmitting stations to a precision of one millisecond.

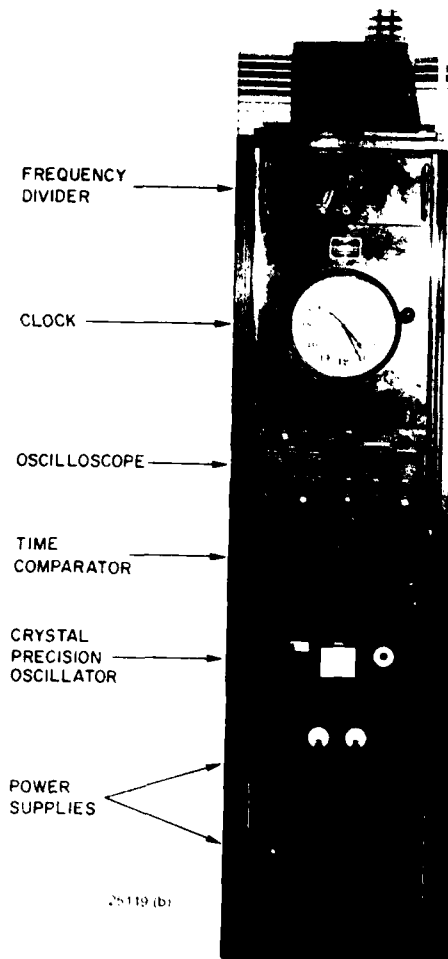

25-119 (b)

**THE NRL-DEVELOPED QUARTZ CRYSTAL CLOCK WHICH AS INSTALLED AT ALL NAVY TIME TRANSMITTING STATIONS PROVIDED, FOR THE FIRST TIME, STANDARD TIME TRANSMISSION COVERAGE OF THE ATLANTIC AND PACIFIC AREAS WITH AN ACCURACY OF ONE MILLISECOND (1953)**

These clocks (AN/FSM-5A) were kept accurate through observations made and corrections furnished by the Naval Observatory. In a later version, the AN/FSM-5B, NRL provided (1954) a clock which for the first time has simultaneous outputs of both sidereal and solar mean time to an accuracy of 2 parts in  $10^{10}$ , eliminating the Naval Observatory's long process in comparing the several clocks used in the determination of standard time.

This Model AN/FSM-5A equipment utilized new pulse-delay and cathode-ray-display techniques for measurements to permit the precise control of the incidence of the timing pulses and to allow adjustment prior to the time transmissions. A novel regenerative type of frequency divider was devised which proved fully reliable in operation of the quartz-crystal clocks. The mechanical contactor, although retained to serve as a gate to pass the time pulses, no longer affected the accuracy of the leading edge of the time transmissions.

To improve substantially the Naval Observatory's time functions, NRL developed a quartz-crystal clock (Model AN/FSM-5B) which, for the first time, provided from a single crystal, power outputs simultaneously at both sidereal and mean solar frequencies to an accuracy of two parts in  $10^{10}$ , equivalent to a possible error of one millisecond each century (1954).<sup>33</sup> Power at the sidereal rate drove the star-image recording mechanism for the determination of time. The power at the mean solar rate was utilized in the observatory's surveillance and control of the time transmission of the Navy's several stations. This clock eliminated the long comparison process and errors involved in the two separate quartz-crystal clocks which previously had to be used by the Observatory in performing these functions. NRL's clock embodied a dual-frequency generator involving a special combination of electronic-algebraic operations to provide a sidereal to mean solar time ratio, as derived from Newcomb's right ascension of the mean sun. Power from the clock was also used to drive other astronomical devices at the Observatory, including its large telescope.

#### VLF WORLDWIDE PRECISION TIME AND FREQUENCY TRANSMISSION SYSTEM

The Navy has been transmitting precise time and frequency on the high-frequency band since 1927, when NRL first equipped the Navy's

"Radio Central" station at Arlington, Virginia with high-power, high-frequency transmitting equipment, the Model XD, already described in Chapter 3, "Radio Communication." The capability of this station to transmit simultaneously on four selected frequencies assured broad coverage for the Navy's time service. Time transmission on high frequencies are still being continued from certain designated Navy radio stations.

Experience has revealed that the rapidity of the change in phase of the transmitted energy in this high-frequency band, due to movements of the ionospheric reflecting surfaces, limited the accuracy of time transfer over long distances to one millisecond and that of frequency and time interval to one part in  $10^7$ . Propagation observations in the VLF band established that transmissions in this band were much more stable and predictable both diurnally and seasonally. In 1959, NRL proposed that the Navy's high-power VLF communication stations be used for the simultaneous transmissions of precise frequency and time together with its communications. In accomplishing this dual time-communication transmission function, NRL devised phase tracking and other techniques and a time-signal format which provided the transfer of time on VLF over long distances to an accuracy nearly two orders higher than on high frequencies, or 50 microseconds, and the transfer of frequency and time interval to one part in  $10^{10}$ , simultaneously with frequency-shift-teleprinter communications (1959-1973).<sup>34</sup> NRL's developments were first applied to the Navy's VLF station at Summit, Panama Canal Zone (NBA) to meet an urgent operational requirement for more precise time rating for missile launchings at the Atlantic and Pacific Missile Ranges, now known as the National Missile Ranges (1959). The NRL developments as they became available have been applied to all of the Navy's high-power VLF radio stations, providing worldwide precise time and frequency service in addition to their communication

PRECISE FREQUENCY AND TIME

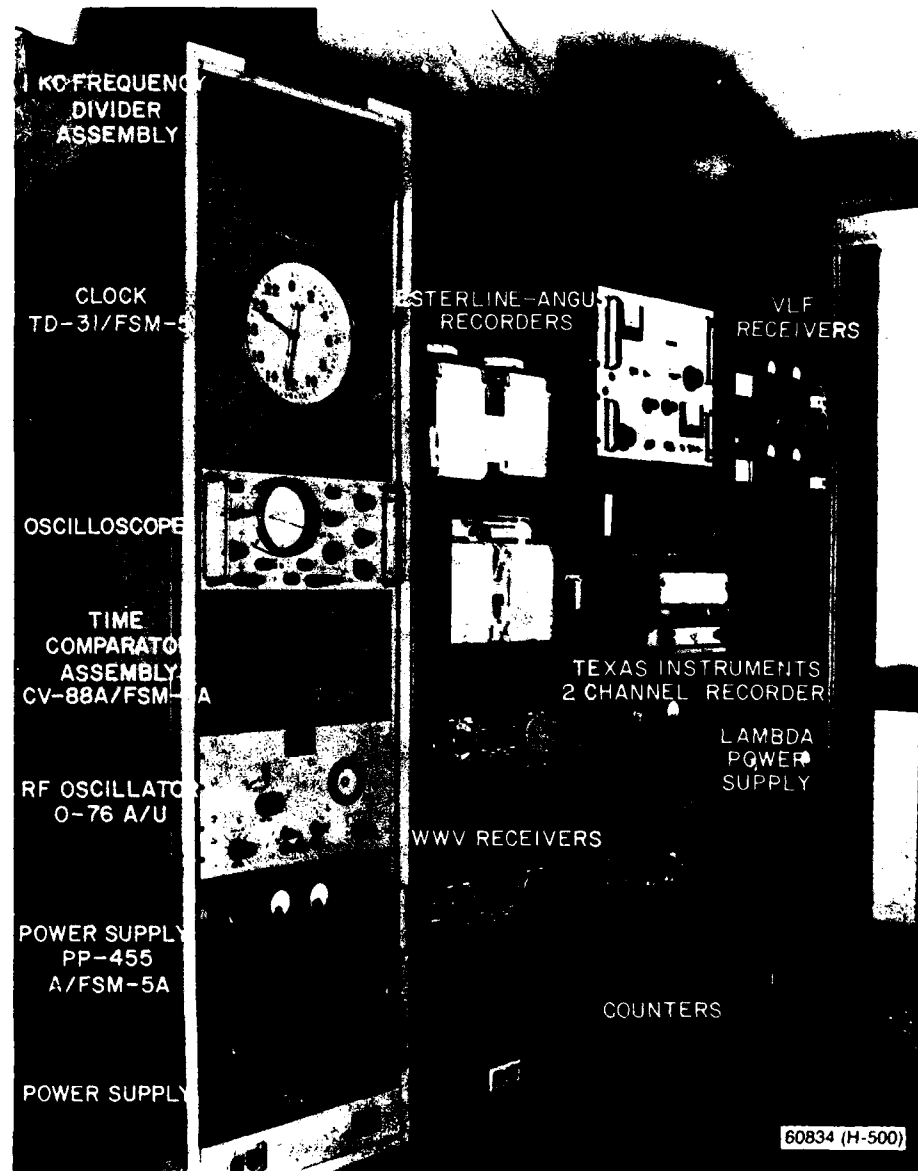

FREQUENCY AND TIME EQUIPMENT DEVELOPED BY NRI AND INSTALLED AT THE NAVAL OBSERVATORY FOR USE IN CONNECTION WITH ITS FREQUENCY AND TIME DETERMINATION AND SURVEILLANCE FUNCTIONS (1955)

Shown at the left is the NRI developed Quartz crystal clock (AN FSM 5A). In a later version, NRI provided (1954) a clock (AN FSM 5B) which for the first time had simultaneous outputs of both sidereal and solar mean time to an accuracy of 3 parts in  $10^{10}$ , eliminating the Naval Observatory's long process in comparing the several clocks used in the determination of standard time.

## PRECISE FREQUENCY AND TIME

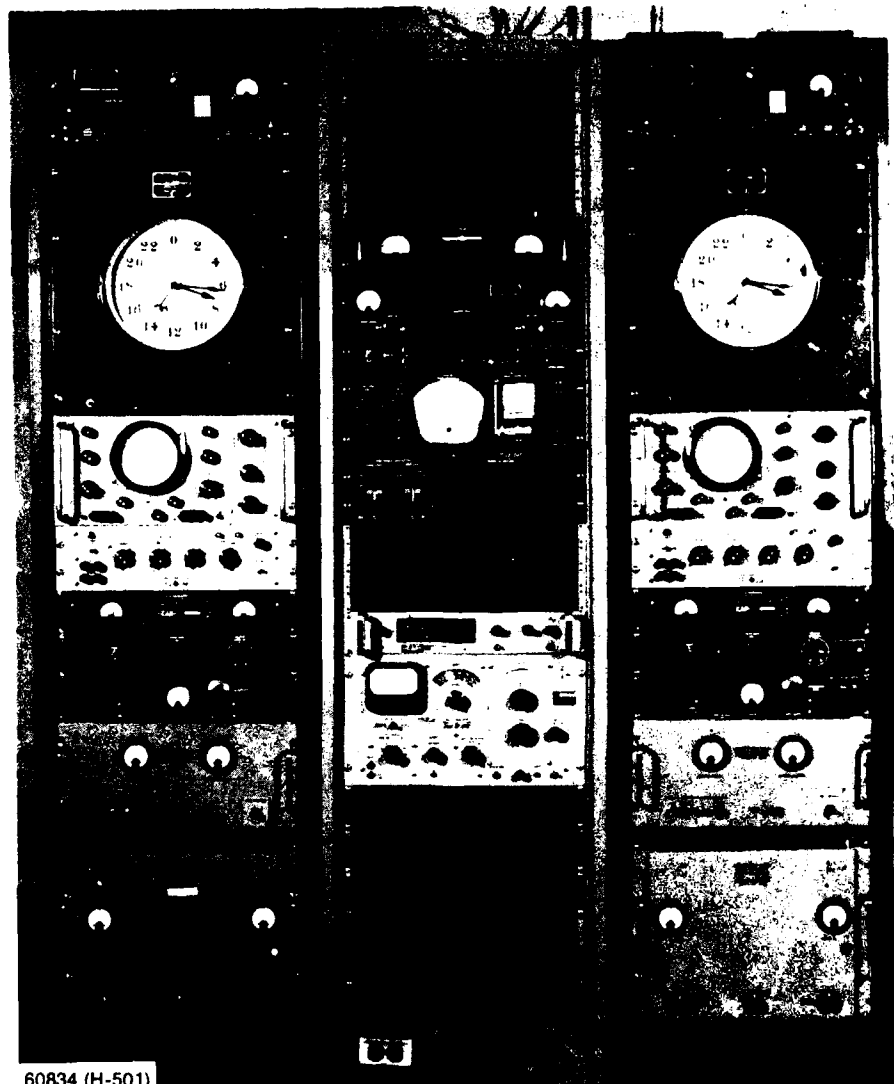

60834 (H-501)  
FIRST TRANSMISSIONS OF HIGHLY PRECISE FREQUENCY AND TIME ON VLF

NRL was first to devise techniques for the transmission of precise frequency and time by VLF and to apply these techniques, thereby obtaining a two-order increase in accuracy (or to 2 parts in  $10^{10}$ ) in frequency and a five-fold increase in the accuracy of time (or to 200 microseconds) over that previously possible with transmissions in the high-frequency band. NRL first applied the techniques to the Navy's station NBA at Summit, Panama Canal Zone (1959). Shown is the NBA frequency-time control equipment. The two similar outer panels contain time comparators immediately below the clocks. The VLF phase indicator and adjuster units are at the top of the center panel. NRL adapted the system for simultaneous FSK operations in 1963 and for timed FSK transmission operations in 1970. The frequency-comparison precision has now been improved to one part in  $10^{12}$  and time accuracy to 50 microseconds. NRL's developments have been applied to the Navy's high-power VLF radio stations, providing worldwide frequency and time service in addition to their communication function.

PRECISE FREQUENCY AND TIME

function. This system currently serves other government organizations, commercial interests, and organizations of other countries such as England, France, Australia, New Zealand, and the South American countries.

Actually, the capability of the Navy's radio stations to operate at VLF in the frequency-shift-keying mode is a direct result of NRL's

work on high-precision frequency stabilization, already reviewed. The necessary phase coherence and continuity were thus made available. For incorporation of time and time-interval transmission in the system, NRL developed the first radio receiver and auxiliary equipment which could automatically track and record the phase of the received VLF energy with high precision. Through observations with NRL's

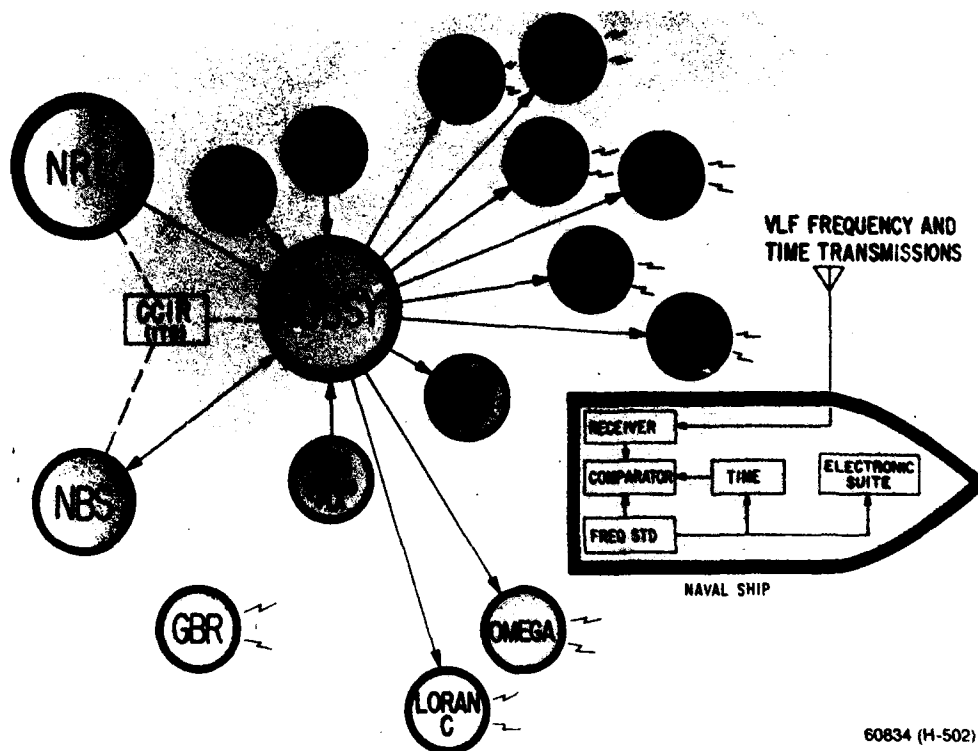

60834 (H-502)

WORLDWIDE VLF FREQUENCY AND TIME SYSTEM

NRL's precise frequency and time developments have been applied to the Navy's high-power VLF communication stations (NAA, NSS, NBA, NPG, NPM, NDT and NWC), making possible precise frequency and time service in addition to the communication function (1959 to 1967). England's station GBR also provides service. NRL's developments have also been applied at the Naval Observatory (NOBSY) to serve its frequency and time determination and surveillance functions. NOBSY has astronomical observation stations (OBS) at Washington, D.C., and Richmond, Florida. NRL provides NOBSY with atomic time data, over a special radio circuit, which is used in combination with data from the NOBSY clock system in the determination of standard frequency and time. The system serves all military services, other government organizations, such as the Bureau of Standards (NBS), commercial interests, and organizations of other countries. International cooperation is accomplished through the International Radio Consultative Committee (CCIR) of the International Telecommunications Union (ITU), an organization under the United Nations.

equipment and the correlation of the data obtained, prediction of the corrections necessary to compensate accurately for ionospheric variations could be determined. The observations also allowed the detection of sudden ionospheric disturbances and permitted taking the necessary action to deal with them.

Further NRL improvements have permitted time transfer between the VLF station at Summit, Panama Canal Zone (NBA) and Washington, D.C. to a precision of one microsecond and frequency and time interval to one part in  $10^{13}$  (1972). These improvements resulted through NRL's application of electronic correlation techniques to the VLF communication system. These improvements were applied to all Navy VLF communication stations.

#### PRECISE TIME TRANSMISSION VIA COMMUNICATION SATELLITES

NRL demonstrated the feasibility of transferring time over long distances via communication satellites with precision as high as one-tenth microsecond, making possible synchronization of time functions on a worldwide basis to this accuracy for the first time (Feb. 1970).<sup>35</sup> Subsequently, the time function was found of such utility that it was incorporated as an integral feature of the Department of Defense satellite communication system. For the demonstration, NRL developed equipment to interface a standard clock with satellite system modems (AN URC-55). Transmissions to establish the accuracy possible were made through NRL's Satellite Research Facility, Waldorf, Maryland via Department of Defense communication satellites. This was followed by transmissions through the satellite ground terminals at Brandywine, Maryland, via satellite to the terminals at Fort Dix, New Jersey and Wahiawa, Oahu, Hawaii. The accuracy of time-epoch transfer at remote locations was observed with a "flying clock," a precise clock carried from one location to another

by aircraft. The success of the demonstrations has led to operational use of satellite time transfer between Brandywine, Maryland, Fort Dix, New Jersey, and Germany to serve our military forces and NATO in the Atlantic and European areas. Satellite links between Brandywine, Maryland, Camp Roberts, California, Hawaii, and Guam serve the U.S. west coast and a large portion of the Pacific Ocean areas. Subsequently, the service was extended to provide coverage of the Western Pacific and Indian Ocean areas. The NRL technique has also improved the communication performance of the Department of Defense satellite communication system, in that it permits time predicted initiation of coded transmissions.

#### CENTRALIZED FREQUENCY AND TIME CONTROL

With the continuing rapid proliferation of electronic equipments aboard ship, the Navy has been faced with a serious problem of accommodating all the equipments for carrying out necessary command and control functions in the limited space available. Some aspects of this problem also exist at the Navy's shore stations. The electronic equipments must be precisely controlled in frequency to avoid mutual interference, to insure reliability in maintaining communication-circuit continuity, and to use the radio spectrum economically. The equipments also require precise time and time interval for their respective functions. Provision of individual standards of highest precision for each equipment would involve further demand for space and added complexity. This situation led NRL to conceive of a centralized frequency and time control system in which a standard of highest precision would control all the frequency and time functions involved from a central point. Synthesizers, located at the individual equipments, would then produce the desired output for the frequency and time functions. It would then be feasible to provide

PRECISE FREQUENCY AND TIME

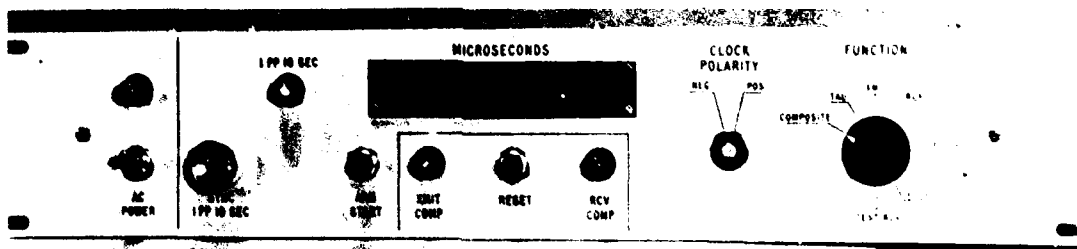

FIRST TIME TRANSFER VIA SATELLITES

NRI was first to demonstrate the feasibility of time transfer via satellite. The Navy's first satellite-based time transfer system was installed on the USS NIMITZ (CVN 68) in 1968. This installation included the centralized frequency and time standard, the AN URQ 13 (XN-1), developed by a contractor under NRI's

the central standard with adequate space to insure the highest degree of precision (1955). NRI developed several models of the system, to establish the principles and illustrate the features involved. Many demonstrations of these models were given to cognizant high Navy officials to show the utility of the

concept.<sup>16</sup> The first implementation of NRI's concept of centralized frequency and time control took place with the installation of part of the system on the carrier USS NIMITZ (CVN 68). This installation included the centralized frequency and time standard, the AN URQ 13 (XN-1), developed by a contractor under NRI's

PRECISE FREQUENCY AND TIME

THE AN/URQ 13  
CENTRALIZED  
FREQUENCY AND  
TIME CONTROL SYSTEM

- TIME DISTRIBUTION  
AMPLIFIER
- FREQUENCY  
DISTRIBUTION  
AMPLIFIER
- VLF RECEIVER  
COMPARATOR
- TIME COMPARATOR
- TIME SIGNAL  
GENERATOR
- FREQUENCY  
COMPARATOR  
COMBINER
- THREE ALTERNATE  
FREQUENCY  
STANDARDS
- POWER  
SUPPLY  
UNITS

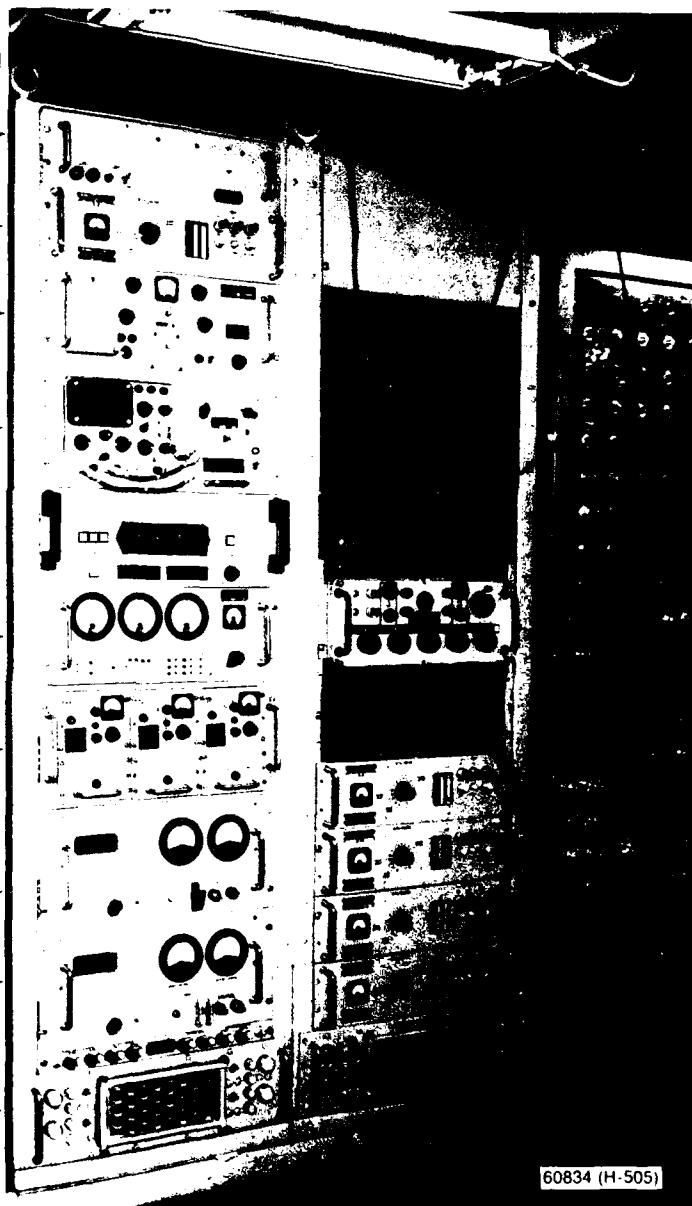

THE FIRST IMPLEMENTATION OF NRL'S CONCEPT OF  
"CENTRALIZED FREQUENCY AND TIME CONTROL"

The system, developed by NRL (1968), is shown installed on the carrier, USS NIMITZ (CVA 68). The second rack of equipment provides the distribution amplifiers for controlling the numerous transmitters and receivers aboard the ship.



PRECISE FREQUENCY AND TIME

guidance. This standard provided frequency control for many transmitters and receivers.

An important difficulty encountered in developing the system was the lack of provision of means for controlling the outputs of the individual equipments, should the precise central standard fail or the transmission line to an individual equipment be disrupted. Additional precise standards at the central point would provide a solution for only part of the problem. To insure reliability in the system of centralized control of frequency and time functions of many electronic equipments aboard ship, NRL was first to develop an oscillator, compact enough to be housed in individual electronic equipments, normally servo-controlled by the centrally located standard, but having sufficient stability to maintain proper operation

for a limited time in an emergency (1972).<sup>37</sup> NRL's servo-controlled oscillator was produced under the designation AN/URQ-23.

A prototype installation of NRL's system has been established at the Navy's radio station, Wahiawa, Hawaii, for the centralized frequency and time control of its many electronic equipments. The local standard at Wahiawa is continuously referenced via the Department of Defense Satellite Communication System to the standard at the Naval Observatory. This is the first time an operation of this type has been accomplished.

A prototype installation of NRL's centralized frequency and time system was also produced for ships. It provided, for the first time, a comprehensive implementation of NRL's concept of the centralized control of the frequency and time functions involved in communication,

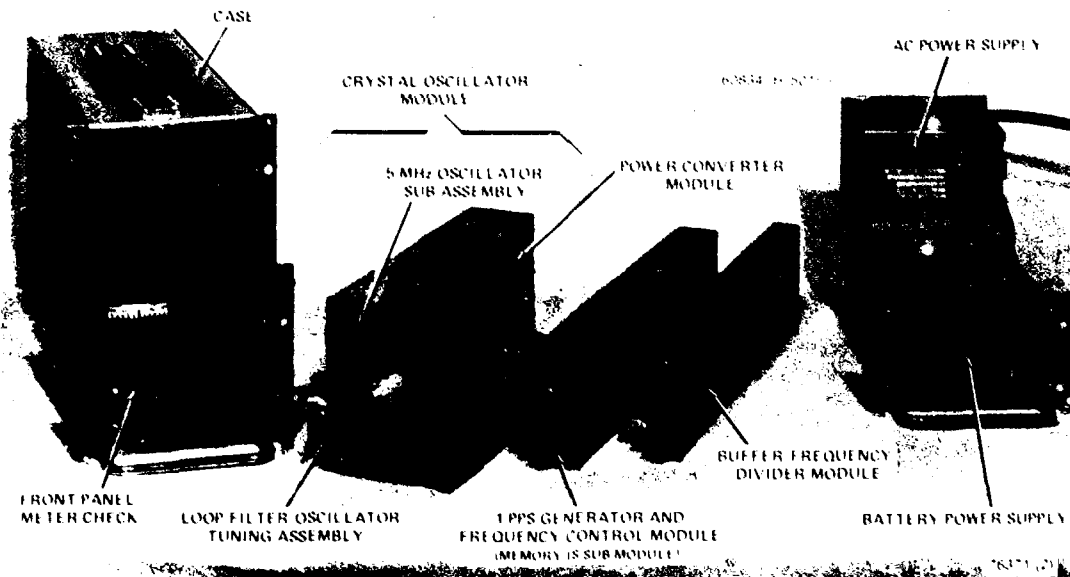

FIRST SHIPBOARD DISCIPLINED FREQUENCY-TIME STANDARD (1972)

This NRL-developed equipment makes practical for the first time the high-precision discipline of frequency and time of all electronic equipment aboard ship from its master disciplined frequency standard. This discipline is AN/URQ-23, which is located in each individual equipment and is remotely controlled from the centrally located frequency standard. This system provides frequency stability and time operation for a limited time in an emergency should the centrally located standard fail.

## PRECISE FREQUENCY AND TIME

radar, IFF, navigation, and electronic counter-measures equipment on shipboard.

### REFERENCES

1. S.C. Hooper, RADM, "International Telecommunication Conferences," *J. Am. Soc. Naval Engineers*, May 1939, pp. 153-177
- \*Radio Spectrum Conservation," IRE Joint Technical Advisory Committee, McGraw-Hill, 1952
2. Bureau of Engineering to Chief of Naval Operations, 4 Mar. 1926, "Radio Telegraph Allocation of Frequencies;" reproduced in NRSR, Mar., Apr. 1926, pp. 5-31
- \* S.C. Hooper, "Considerations Affecting the Licensing of High-Frequency Stations," *IRE*, Sept. 1928, pp. 1240-1251
- \* A. Hoyt Taylor, "Radio Reminiscences: A Half Century," pp. 222-226, 1948 edition; pp. 128-130, 1960 edition; NRL Library 359.0072.T238 Ref.
3. "The Interdepartment Radio Advisory Committee," Executive Office of the President, Office of Telecommunications Policy, TEL-IRAC-72-30, June 1972
4. NRSR, July 1923, pp. 32-33
5. NRSR
  - July 1920, pp. 53, 105-108
  - May 1921, pp. 25-33
  - June 1921, pp. 34-43
  - Sept. 1921, pp. 6-9
6. R.H. Worrall and R.B. Owens, "The Navy's Primary Frequency Standard," *IRE*, 1928, pp. 778-793
7. NRSR, May 1924, pp. 29-32
8. NRSR, Project V-1E-26
  - July, Aug. 1925, p. 5
  - Oct., Nov. 1925, p. 32
  - Mar., Apr. 1926, p. 59
  - May, June 1926, pp. 3, 4
- \*Radio-Frequency Indicating and Measuring Instruments," NRL File S67/74, No. 1; NRL CRMO
9. NRSR
  - Sept. 1925, p. 6
  - Oct., Nov. 1925, p. 57
  - Oct., Nov. 1926, p. 51
  - Feb.-Apr. 1927, p. 41
- \* A. Crossley, "Piezo-Electric Crystal Calibrators," NRSR, May, June 1927, pp. 38-44
10. NRSR, Oct., Nov. 1926, p. 51
11. NRSR, Problem No. 10
  - July, Aug. 1927, p. 22
  - Nov., Dec. 1927, Jan. 1928, p. 15
- \*Radio-Frequency Indicating and Measuring Instruments," NRL File S67/74; NRL CRMO
12. NRSR, NRL Problem No. 57, Nov., Dec. 1927, Jan. 1928, p. 45
13. NRL letter to Bureau of Engineering, S67/74, 10 Nov. 1928; NRL CRMO
14. NRSR, Problem No. 24, July, Aug. 1927, p. 23
  - \*NRSR, Problem No. 24, Nov., Dec. 1927, Jan. 1928, p. 44
  - \*NRSR, July-Sept. 1931, p. 101
15. NRL letter S67/74 RBO:lf to Bureau of Engineering, 21 Dec. 1933; NRL CRMO
16. H.F. Hastings, "Tests of Model LM Radio Frequency Measuring Equipment, Submitted by Radio Research Co.," NRL Report 1310, Sept. 1936
- \*E.J. Kirk, O.R. Buchanan, and H.F. Hastings, "Modifications of LM Frequency Meters," NRL Memo. Rept. 189, July 1953
17. O.R. Buchanan and R.R. Stone, Jr., "Instruction Book for Model LAM Precision Frequency Calibrating Equipment," NRL, July 1947; NRL Document No. MB-3629
- \*Harmonic Frequencies of 9 KC, 10 KC, and 11 KC, up to 30 MC. Addendum to Instruction Book for Navy Model LAM Frequency Calibrating Equipment," NRL, Nov. 1962; NRL Document No. 306, 28
18. E.J. Kirk, O.R. Buchanan, and H.F. Hastings, "Radiation Reduction in the AN/FRM-3 Frequency Calibration Equipment," NRL Memo. Rept. 239, Nov. 1953
19. R.R. Stone, Jr., and H.F. Hastings, "A Technique for the Direct Frequency Comparison and Continuous Recording of Frequency Standards," NRL Report 3631, Feb. 1950
- \*H.F. Hastings and P.B. King, "A Technique for Precise Measurement of Short- and Long-Term Stability of Oscillators," *IRE Trans. on Instrumentation*, Vols. 1-11, Nos. 3 and 4, Dec. 1962, p. 248
20. R.R. Stone, Jr., "A Decade Frequency Generator from a Single Frequency Origin," NRL Report 4081, Dec. 1952
- \*R.R. Stone, Jr., and H.F. Hastings, "A Novel Approach to Frequency Synthesis," *Frequency*, Sept.-Oct. 1963
- \*Proceedings of the 17th Annual Symposium on Frequency Control, May 27-28-29, 1963," Army Electronics Research and Development Laboratory, May 1963; NRL Document No. 330,782
- \*W.B. Berg, "Frequency Synthesizer Hewlett-Packard Model 5100A/5110A (Ruggedized)," NRL Test and Eval. Rept. 73 June 1967
21. T. Lieberman and H.F. Hastings, "Shipboard Time Standard," NRL Memo. Rept. 1075, July 1960
- \*D.L. Pritz and W.B. Berg, "Frequency Standard, Instrument Corporation of Florida Model AN/URQ-9, Ser. C1 and C3," NRL Test and Eval. Rept. 51, Mar. 1965
- \*W.B. Berg, "Frequency Standard Model AN/URQ-10A, Ser. 9810, 9811, and 9812 (Frequency Electronics)," NRL Test and Eval. Rept. 109, Feb. 1970
22. "Frequency Monitoring Applications," NRL letter to Naval Ships Systems Command 5420/202, NRL Problem R08-12, 6 Oct. 1967; NRL CRMO
23. H.F. Hastings, "Frequency Standards for Service Use," NRL Memo. Rept. 661, Dec. 1956
- \*H.F. Hastings, "Precision Frequency Control and Millisecond Timing," Report of NRL Progress, August 1960, pp. 16-22
- \*H.F. Hastings, "Precision Frequency Control and Millisecond Timing," *Naval Research Reviews*, Sept. 1960, pp. 6-12
- \*W. Markowitz, "The Atomic Time Scale," *RE Trans. on Instrumentation*, Vol. 1-11, Dec. 1962, p. 239
- \* A. Shostak, "Research Origins of Modern Time and Frequency Control," *Naval Research Reviews*, Feb., Mar. 1966, pp. 15-25
24. A.R. Chi and H.S. Fosque, "A Step in Time," *IEEE Spectrum*, Jan. 1972, pp. 82-86
- \*A.R. Chi and H.S. Fosque, "A Step in Time: Changes in Standard-Frequency and Time-Signal Broadcasts," *National Aeronautics and Space Administration Technical Note NASA-TN-D-7065*, 1 Jan. 1972, NRL Document No. 492,871
25. D.H. Phillips, R.E. Phillips, and J.J. O'Neill, "Time and Frequency Transfer via Microwave Link," *IEEE Trans. on Instrumentation and Measurement*, Vol. 1M-20, No. 1, Feb. 1971
- \*D.H. Phillips and J.J. O'Neill, "Time and Frequency Transfer via Microwave Link," NRL Report 7140, June 1970

## PRECISE FREQUENCY AND TIME

- J.A. Murray and O.R. Buchanan, "A Technique for Controlling Standard Frequencies with a Hydrogen Maser," Report of NRL Progress, July 1964, pp. 31-33
26. H.E. Peters, "Absolute Frequency of an Atomic Hydrogen Maser Clock," Proc. 26th Annual Symposium on Frequency Control, 27. J.J. O'Neill, D.H. Phillips, and R.R. Stone, "Hydrogen Maser and Frequency Translator," NRL Report 7858, June 1975
28. G.S. Bryan, RADM, "The Naval Hydrographic Office," U.S. Naval Inst. Proc. Nov. 1946, pp. 1395-1403
  - G.A. Weber, "The Naval Observatory—Its History, Activities, and Organization," 1926, Navy Dept. Library Ha 58 W 374
  - U.S. Naval Observatory, "Observatory Pamphlet, July 1970
  - The National Almanac and Annual Record for 1864, Library of Congress
29. "Precise Time and Time Interval (PTTI) Standards and Collaboration Facilities for Use by DOD Components (ASDT)," Department of Defense Directive 5160.51, 31 Aug. 1971
30. "Time Signals from Arlington," NRSR, Mar., Apr. 1926, pp. 110-114
31. "Radio-Crystal-Controlled Clock," Naval Observatory letters to NRL, 7 May and 30 Sept. 1931, NRL File S6774, NRL CRMO R.M. Page, Log III, NRL Register No. 171, pp. 42, 45-48, 50-55, 85
  - J.F. Hellweg, CAPT, "Time Determination and Time Broadcast," J. Franklin Inst., May 1937, pp. 549-563
32. P.P. Bey and H.F. Hastings, "Final Report on the Time Standard AN/FSM-5A," NRL Report 4639, Nov. 1955
33. J.A. Murray and H.F. Hastings, "Instruction Book for Time Standard AN/FSM-5B," NRL Instruction Book 15, Apr. 1959
34. H.F. Hastings, "Time and Frequency Synchronization of Navy VLF Transmissions," IRE Trans. on Instrumentation, Vol. 1-9, No. 2, Sept. 1960
35. R.R. Stone, J. Murray, D. Phillips, and D. Pritt, "Time Transfer by Communication Satellite," NRL Memo. Rept. 2110 Mar. 1970
  - "Dissemination of Defense Worldwide Precise Time and Frequency," sponsored by Naval Electronics Systems Command, Nov. 1970; NRL Document 495,031
36. F.C. Isely and D.A. Venn, NRL Report 4847, Dec. 1956
  - E. Toth and D.A. Venn, "Centralized Electronic Control. Part 1—Basic Concepts," NRL Report 5664, Aug. 1961
  - F.C. Isely, "Considerations of and Proposals for a Centralized Frequency Monitor and Control System for Naval Communication," NRL Memo. Rept. 510, Aug. 1955
  - D.A. Venn and R.G. Hennessy, "Centralized Frequency and Time Control for Ship and Shore," Report of NRL Progress, Sept. 1961, pp. 1-6
  - NRL Annual Report 1963, p. 37
37. R.R. Stone, "Disciplined Time and Frequency Oscillator," Proc. Third Annual Department of Defense Precise Time and Time Interval Strategic Planning Meeting, Nov. 1971, pp. 211-223, NRL Document No. 492,459

## Chapter 10

# ELECTRONIC SYSTEMS INTEGRATION

### INTRODUCTION

The subject of the integration of electronic systems has several facets, each one of which has marked influence on the overall effectiveness of these systems in serving command and control functions. One facet of major importance is that of combining the information provided by systems such as communication, radar, IFF, weapons control, navigation, and countermeasures so that it is most effectively available for command decisions and their execution. Another facet is that of the electromagnetic compatibility of the several systems in close proximity as they are aboard ships and aircraft and in task forces. Compatibility involves the avoidance of mutual interference through proper equipment design to control spurious emissions, realistic frequency channel assignment, and adequate frequency discipline. Still another facet concerns the physical integration of equipment and components to contend with the tremendous pressure for the proliferation of equipments to be fitted into the limited space available aboard ships and aircraft. Allied with this is the factor of reliability and the standardization of components and equipment design to minimize service and to facilitate storage of spares and use of operational manpower.

The Navy's first step in electronic systems integration was taken when the radio facilities of the battleship USS WYOMING were arranged so that simultaneous transmission and reception were first made practical aboard ship (1923). The WYOMING incorporated NRL's multiple reception system, with reception and control facilities for communication centralized forward, and the transmitting facilities located aft.<sup>1</sup> NRL's

developments, which made the high-frequency band available for use, resulted in greatly reduced size of both antennas and equipment. These developments made possible the installation of many more communication equipments aboard ship, with an actual reduction in mutual interference. NRL's subsequent development of broad-band antennas and multiplexing circuitry brought about a further substantial increase in communication capacity, with reduction in ship-board antenna structure complexity and adverse equipment interaction. NRL's developments in the antenna and multiplexing fields are reviewed in Chapter 3 of this document.

An important factor in electronic systems integration is that concerning radio frequency and time discipline. The number of channels in the radio-frequency spectrum which can be practically utilized by the several electronic systems and the reliability of their respective functions are dependent upon the degree of precision of control of the frequency of the system's radio emissions and that of the selectivity of the associated reception equipment. Furthermore, the utilization and reliability of time functions such as synchronization in digital and security code operations over great distances require that highly precise time and time interval be available for the several electronic systems requiring them. To insure maximum radio-spectrum channel and time function utilization and maximum system reliability, NRL initiated the concept and developed a system for the precise control of frequency and time functions of the several electronic systems from a single high-precision, locally situated centralized source with means for reference to the standards of radio frequency and time established by the

ELECTRONIC SYSTEMS INTEGRATION

60834 (H-508)

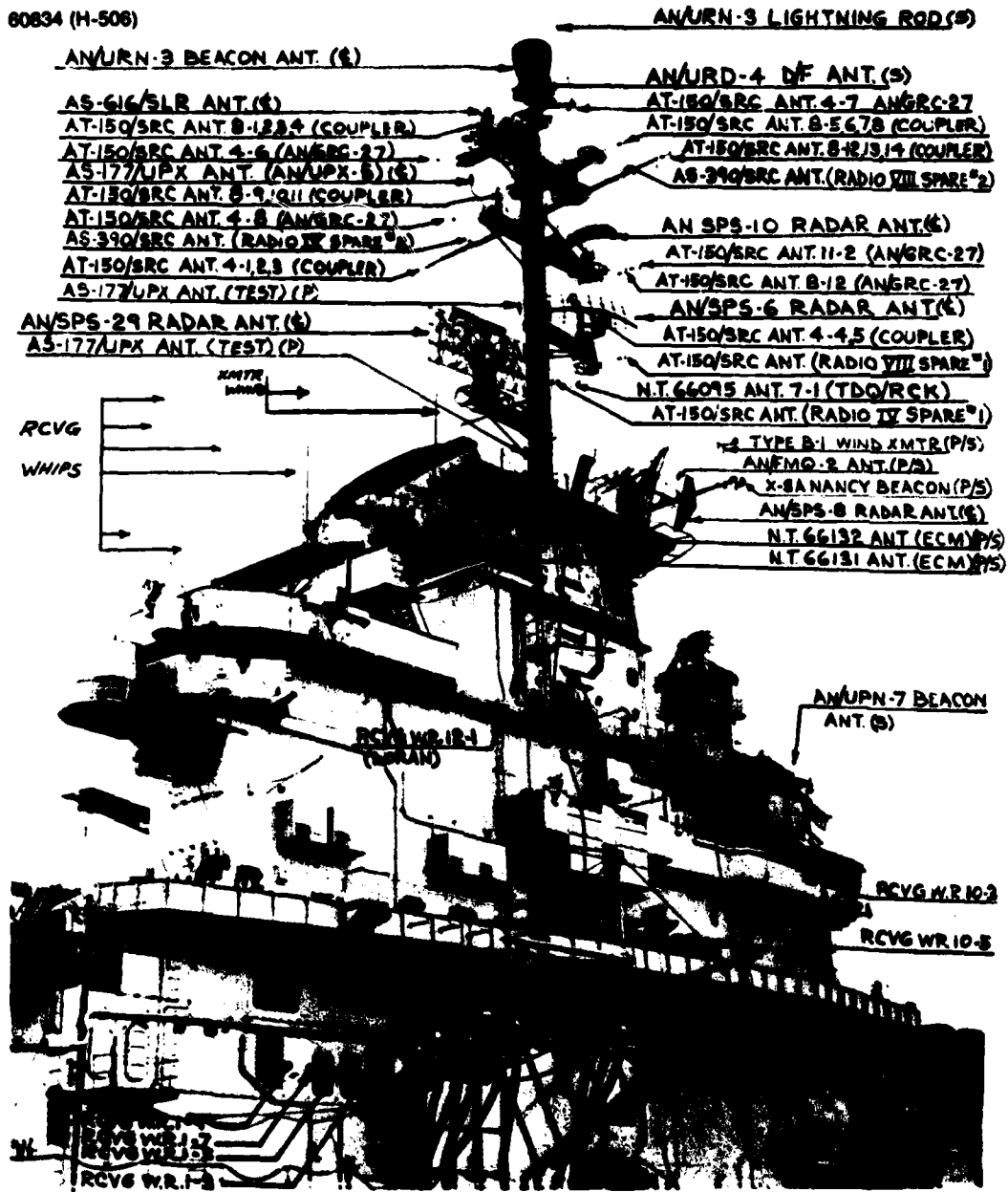

ANTENNA CONGESTION ABOARD SHIP

The USS ESSEX (CVS-9) provides a typical case of the congestion that existed in the superstructures of ships, where the antenna components of the many electronic systems needed compete for the space necessary to provide proper performance without mutual interference. The necessity for integration of physical structures is vividly demonstrated in this view.

## ELECTRONIC SYSTEMS INTEGRATION

Naval Observatory in Washington, D.C. with world-wide coverage. This system, intended for use both aboard ship and at shore stations and termed "Centralized Frequency and Time Control," is described in Chapter 9 of this document.

NRL's development of radar brought about a radical change in the concept of command decision. Instantaneous, comprehensive preception of combat situations and unique means to carry out decisions first became available to command. However, the effectiveness of command's use of radar's capability required the utilization of other electronic systems. During the Fleet exercises in 1939, when NRL first demonstrated the operational capabilities of radar with its Model XAF aboard the battleship USS NEW YORK, the need for associating radio-communication facilities with radar was quickly observed.<sup>2</sup> The alliance of these facilities was promptly arranged, and at once the operational use of the radar-derived information was strikingly expedited. NRL's invention of the PPI, providing a map-like, antenna-centered display of targets and obstacles within range, greatly enhanced command's capability to assess air and surface situations.<sup>3</sup> NRL's IFF developments and its origination of the display of target IFF responses associated with radar echoes in PPIs greatly facilitated the identification of targets and the conduct of operations such as air intercept.<sup>4</sup> PPIs were first mounted integrally with other major components of radars. When the need arose for several radars to be grouped together, the large size of the assemblage interfered with the effective utilization of the target data presented. NRL's development of the remote PPI permitted the compact assembly of several PPIs, a large plotting board, and communication facilities, with other radar components remotely located.<sup>5</sup> This assemblage became known as the "Combat Information Center" (CIC), inaugurated in the Fleet during 1942 and 1943. NRL's developments in these fields have been described in Chapter 4 of this document.

After the war, the greatly increased numbers of aircraft and missiles estimated to be involved in future combat made evident that the existing manual method of plotting data in CIC and the use of voice communications in carrying out such functions as air intercept and task-force target-data coordination would no longer be adequate. New means would have to be devised to process the large amount of data involved and put it into a form suitable for rapid and accurate use for command and control and for task-force distribution. Furthermore, automatization of processes would have to be introduced whenever possible to relieve the burden on manpower. In 1946 NRL initiated a program to seek a solution of the problem.<sup>6</sup> Through observations of data handling during various Fleet operations, the analysis of the characteristics of the several electronic systems, and a study of their interrelationship, the Laboratory endeavored to obtain a thorough and realistic understanding of the nature of the data involved and its flow in conducting the several combat functions. NRL's interest in electronic systems integration led to its taking the initiative in bringing about the establishment of a systems-utilization panel under the Electronic Committee of the Department of Defense Joint Research and Development Board (1947). This panel was responsible for coordination and integration of the various military electronic systems. In March 1950, NRL held the nation's first symposium on electronic systems integration, bringing to the attention of representatives of the Chief of Naval Operations, the several cognizant Navy Bureaus, the Army, Air Force, and British the results of its efforts. NRL reviewed its concepts concerning the utilization of electronic storage, processing, and display of target data. These concepts were particularly apropos, since they offered the most promising solution of the pressing data problem. One item reviewed, which has continued to be useful to the Navy, was the presentation of the technical characteristics of the Navy's radar equipment in document

## ELECTRONIC SYSTEMS INTEGRATION

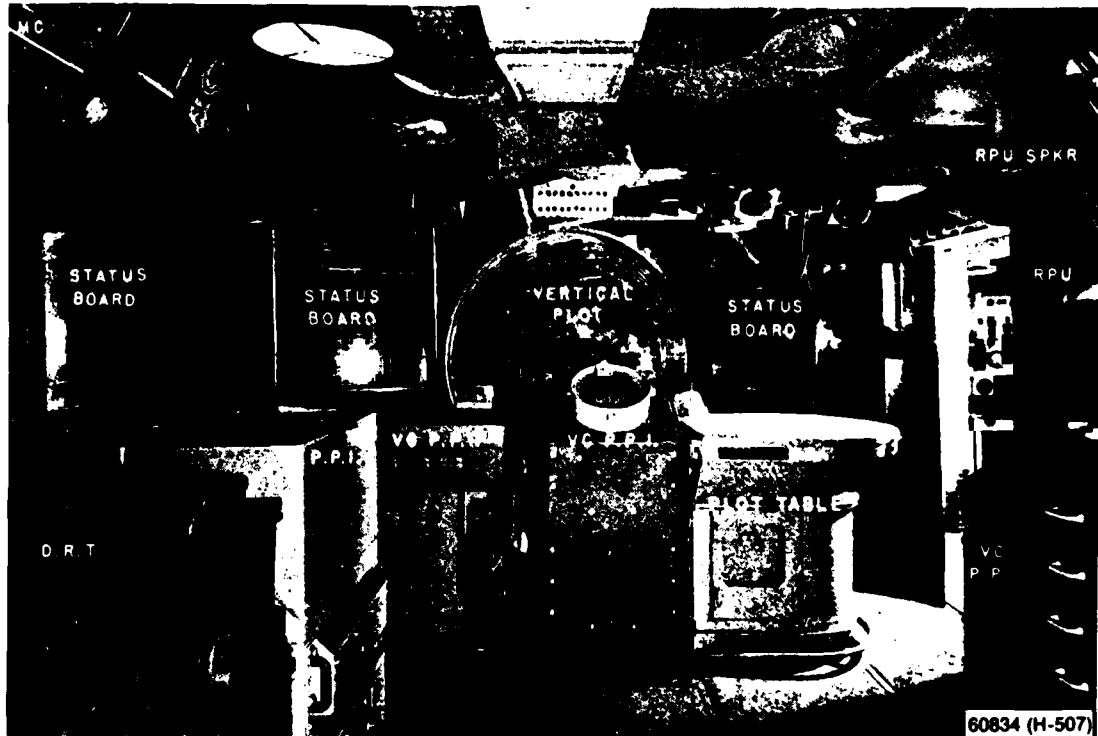

### TYPICAL WORLD WAR II COMBAT INFORMATION CENTER (CIC) ON BOARD A TYPE AGC SHIP

NRL's development of the remote PPI made feasible the compact assembly of several PPI's, large plotting boards, and communication facilities to form an effective CIC. Other radar components could be remotely located. The CIC arrangement greatly facilitated the handling of information for aircraft interceptions and other functions. The AGC ships, usually Amphibious Force Flagships, served the needs of shipboard general headquarters to direct assaults and landing operations. They were needed beginning early in 1943 for the numerous landings which were carried out. They were first used in the Mediterranean Theater with extremely satisfactory results.

form. NRL has periodically revised this document at the Navy's request up to the present day.<sup>7</sup>

### ELECTRONIC TACTICAL DATA SYSTEMS

NRL continued its development of a data system employing electronic means to generate target-position data in tracking, to store the target data in a memory, to display selectively such stored data for command and control, and to transmit the stored data between component ships of a task force for coordination in air defense. During 1950, while proceeding with this program, it became known that an equipment was under development in England (Elliott Brothers) for the British Navy which employed remotely controlled potentiometers operated by trackers to store target information, and telephone stepping switches to scan the stored target data for display on PPIs. This equipment was part of a system termed the "Comprehensive Display System" (CDS). Since the British Navy was not in a position to investigate the performance of this equipment adequately in an air-defense system, it was proposed that the U.S. Navy undertake the task. NRL reviewed the equipment in England and reported its findings to the Bureau of Ships. This review resulted in a decision to proceed with the investigation of the equipment, and under the Bureau's sponsorship NRL assembled a complete air-defense system including the British equipment at its Chesapeake Bay site. With this installation NRL was first to demonstrate an air-defense system utilizing electronic memory and switching means in the tracking of targets and their selective display for command decisions and their execution (1951-1952).<sup>8</sup> This system was the most elaborate assembled up to that time. It aroused widespread interest, and numerous demonstrations were given to many high officials of the U.S. Navy, Army, and Air Force, and to British and Canadian military services and associated laboratories. When

the system was completed, it was subjected to evaluation by the Navy's Operational Development Force personnel, who manned all the operating positions. Extensive operational trials were carried out with both aircraft and simulated targets. The resulting report indicated that the basic concepts of the system were sound and that its potential target capacity was many times greater than existing CIC installations. However, this capacity could not be fully realized until radars of far superior performance, such as that of the Model SPS-2, were made available. The report recommended continued development of the data-system concept (1952).<sup>9</sup>

The air-defense system involved live target data from three radars, an AEW terminal, and Mark X IFF system. Ten HF and UHF equipments were part of an external-internal communication network. Displays were provided for the Flag, ship captain, CIC officer, detectors, trackers, analyzers, air-intercept controllers, supervisors, and gunnery liaison officers. Elaborate instrumentation for automatic recording of operational data electronically was also provided. The data store had a capacity of 96 positions, 24 of which were assigned to target data from three tracker positions, 12 to early-warning data obtained via the AEW terminal and communication circuits, and as many simulated targets as desired to minimize the number of target aircraft and to permit operations to continue during bad weather. Track-number, plan-position, identity, height, and size data were stored. Identity data were stored in categories of friendly or hostile, action taken or no action, own-force aircraft or other, aircraft homing, or emergency. Height was stored as low, medium, or high. The size of aircraft groups was stored as single, few, or many. A "detector" operator, observing a target on own-ship radar PPI, inserted the targets plan-position data into one of the store track number positions by aligning a small circle with the target echo on the PPI with a control stick and pressing a button. Three tracking operators, equipped with PPIs,



## ELECTRONIC SYSTEMS INTEGRATION

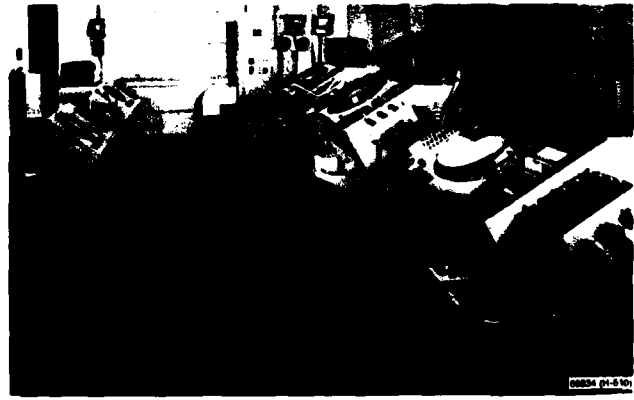
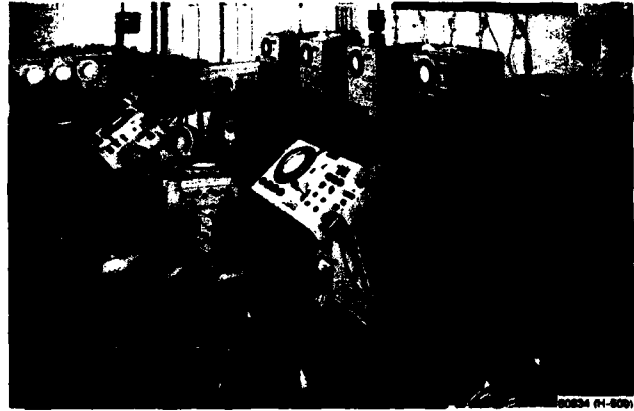

**THE AIR-DEFENSE DATA SYSTEM FIRST TO DEMONSTRATE ELECTRONIC MEMORY AND SWITCHING MEANS IN THE TRACKING OF TARGETS AND THEIR SELECTIVE DISPLAY FOR COMMAND AND CONTROL DECISIONS AND THEIR EXECUTION; ASSEMBLED AND DEMONSTRATED BY NRL AT ITS CHESAPEAKE BAY SITE (1951-1952)**

This system was the forerunner of tactical electronic data systems, such as the Naval Tactical Data System (NTDS). The picture on the left shows the electronic memory (left in picture) and the target and display switching equipments (right in picture). The target detection and tracking equipments are shown at the upper right. The tactical control consoles can be seen at the right in the lower right picture; the air controllers' consoles are to the left.

continually updated this plan-position stored data in a similar manner. Equalization of the target load on the tracking operators was automatic. Analyzer operators equipped with PPI, IFF, and height-finding inserted the identity, height, and size data in the store. A supervisor equipped with PPI, IFF, and height finding maintained surveillance over the detector-tracker-analyzer group. For tactical use the data stored on targets were displayed as small dots in their relative plan-positions on four large cathode-ray-tube consoles. Target data could be displayed and arranged about the plan-position of the target, and could be selected by target number, any category, or any combination of categories. By using a control stick to align a circle with any target plan-position, the data on that target could be individually displayed. A total of 91 symbols and 96 track numbers were available. Early-warning data were handled by a detector-tracker and by a supervisor similarly equipped. Three intercept controller positions equipped with PPI, IFF, and height finding were provided. The analyzer, supervisor, interceptor, and tactical positions were provided with a small "code reading tube" on which individual target information could be displayed, with height presented more accurately in thousands of feet. To obtain satisfactory operation, the British equipment had to be modified with respect to such functions as target selection, display switching, and polar to rectangular coordinate conversion for strobe development in PPI display.<sup>10</sup> Tactical and other display consoles had to be added. Radars, IFF equipment, target position-height data simulators, and other equipment had to be provided.

### PROJECT COSMOS

To study information handling for command purposes, the Bureau of Ships set up Project Cosmos, placing contracts with the Bell Telephone Laboratories and the RCA Corporation for various phases (1951-1956).<sup>11</sup> A feature of

this study was the first comprehensive collection of actual traffic data taken simultaneously on a large number of communication nets during a Naval exercise (LANTFLEX-52, 1952). The volume of communication traffic flowing among the various operational points in the group of ships forming the exercise was carefully measured to serve as a basis for future improvements. NRL contributed to the analysis of the results of this and other phases of the Cosmos project.

### THE NAVY'S ELECTRONIC DATA SYSTEM

The availability of the CDS target data-storage and switching equipment provided valuable experience, with the use of electronically generated, stored, and displayed data in an air-defense system. However, its control-stick, servo-driven potentiometer store and target display switching mechanisms were not suitable for operational use due to bulkiness, mechanical difficulties, temperature sensitivity, and lack of adequate data precision. NRL had devised greatly improved techniques for the target data-handling functions. Using these techniques, NRL developed the Electronic Data System (EDS), the Navy's first system employing electronic means for the generation, storage, display, and utilization of target data and the automatic interchange of such data between component ships of a task force (1953).<sup>12,13</sup> This system was the forerunner of the Naval Tactical Data System (NTDS). It was installed on a number of destroyers and guided-missile ships and served the Fleet's readiness until 1968, when it was replaced by the NTDS. NRL installed a model of its EDS at its Chesapeake Bay site (1953). Numerous demonstrations of the system were given to military and civilian officials of various levels to inform them of the system's capabilities and unique features. In 1955, with the approval of the Department of Defense, the Navy established

## ELECTRONIC SYSTEMS INTEGRATION

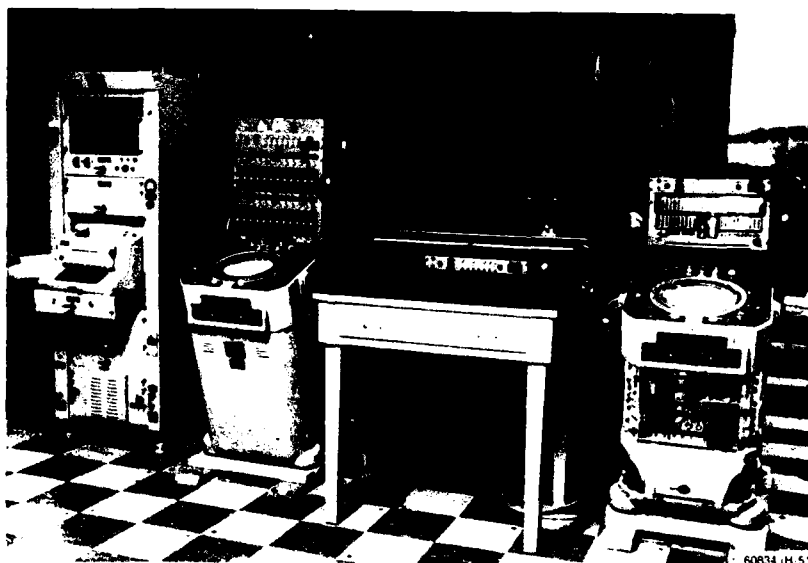

### THE NAVY'S FIRST TACTICAL ELECTRONIC DATA SYSTEM, THE EDS

The EDS, developed by NRL (1953), was the Navy's first system to employ electronic means for the generation, storage, display, and utilization of target data and the automatic interchange of such data among the component ships of a task force. This system was the forerunner of the Naval Tactical Data System (NTDS). The upper picture shows the command decision area, with detection and tracking equipment at the sides and the automatic plotting board in the center. The lower picture shows on the left the EDS data link terminal equipment (AN/SSA-21). The next unit provides for the common task-force track number and for selection of tracks for local display and transmission. The third unit is an improvised CIC Officer's communications station. The fourth unit is the tactical display of memory data for threat evaluation and command decision. The interceptor and fire-control-designation displays are not shown.

Project Lamplight to seek solutions to problems involved in the Navy's role in continental air defense. The country's available qualified scientific talent was assembled to study the problems. In addition to other aspects of the study, NRL's data system was considered and favorably viewed. The final report of the Lamplight project stated that NRL's EDS met important Fleet requirements regarding air defense and recommended its installation by the Navy (1955). The Navy procured 20 EDS equipments (Motorola), the first being installed on the destroyer USS WILLIS A. LEE (DL-4) (1956). Subsequently, installations of the EDS were made on four radar picket destroyers (1959), the USS CARRY (DD 817), O'HARE (DD 889), CECIL (DD 855), and STICKEL (DD 838) of the Destroyer Division 262, and on guided-missile ships of the CAG and CLG types.

An important EDS feature developed by NRL was a unique PPI target-position data-takeoff technique which provided rapid acquisition of targets and accurate plan-position data in target detection and tracking (1949). An electrically excited conducting-glass plate overlay replaced the conventional glass top of the PPI. Contact made with the plate's transparent conducting film by an operator using a pencil-like probe placed directly over a radar echo provided electric potentials corresponding to the two rectangular target-position coordinates. Accuracy was assured by NRL-developed retrace-insertion circuitry, which displayed a bright dot on the PPI screen controllable by the probe so as to coincide with the target echo. These electric potentials were stored by a compact "capacitor" memory with a capability of storing data on 24 targets. As a new target appeared, a detector-tracker operator stored its plan position, continually revising the previously stored target data by rapidly running through the series stored, with each position displayed in succession by a bright dot on the PPI. This operation generated stored velocity data. Automatic rate-aiding circuitry provided in the store

projected the plan position of the target, as indicated by the moving dot. This technique reduced the number of position readjustments and expedited the tracking operation. An operator could effectively track up to eight targets with this new technique, as compared with two targets possible under similar conditions with the earlier nonelectronic method. With the EDS rate-aiding circuitry, it was possible for the first time to provide velocity data in electrical form for use in determining aircraft interceptions. The data stored included track number, plan position, velocity, height, size, and identity. Two operators took care of storing the height, size, and identity information. Provision was made for target designation for the air-intercept and gunfire-control functions. A supervisor maintained surveillance over the data-handling operations. The group of consoles involving these functions was designated the AN SPA-26 (XN-1).

To provide a large-scale display of the stored tactical data, NRL devised the first automatic tactical target plotting board as a feature of the EDS (1952).<sup>10,14</sup> This device greatly accelerated the plotting of target tracks, as compared with the previously used oral, grease-pencil method. With it, plots on the edge-lighted plastic board could be made at the rate of one per second. The plotting board, designated the AN/SPA-15, 5 by 5 feet in size, was servo-driven, the marker being positioned by the electrical data in the memory.

The NRL-developed Electronic Data System was the first data system to provide means to exchange tactical data automatically between the memories of component ships of a task force for rapid, coordinated action against air attack based on the possession of common information.<sup>16</sup> Such exchange was first accomplished with the EDS installations aboard four destroyers (DDR) of Destroyer Division 262 (1959). During trials at sea, the EDS data were successfully exchanged between ships out to ranges of 400 miles. The transmission system, designated the Model AN/SSA-21, utilized teletype format transmissions

in the high-frequency band with a compact message structure transmitting track number, target status, plan position, velocity, identity, height, and size. Means were provided for automatic conversion of the data between analog and teletype forms at both transmitting and receiving terminals. Position data were related to a 1000-mile-square grid. Incoming target data could be displayed separately or jointly with own-ship tracked targets. Orders and messages could be transmitted by the usual teletype process.

#### NAVAL TACTICAL DATA SYSTEM (NTDS)

At the time the EDS was under development, binary digital techniques had not yet attained practicality for operational use, so analog techniques were employed. However, the prospective versatility of binary digital techniques with respect to storage, computation, selection, and display of data and its transmission via communication links made these techniques particularly attractive. NRL had conducted a program to explore the capabilities of various approaches to the use of these techniques. Electronic computers were investigated with respect to the processing of tactical data (1949).<sup>16</sup> Techniques were devised employing the magnetic-drum and magnetic-core devices for the memory, switching, selective scanning, and display of digitized information. **NRL was one of the first to devise a digital memory comprising a series of rotating magnetic disks (1952).**<sup>17</sup> Such devices formed the basis for certain electronic computer systems. NRL conducted investigations of solid-state devices (diodes, transistors) to avoid the use of bulky vacuum tubes in large numbers and thus greatly reduce the size and increase the reliability of binary digital equipment (1949-1955).<sup>18,19,20</sup> One unique feature of this work was the early use of the "avalanche" effect in silicon diodes for the maintenance of precise, stable voltage levels such as required in the PPI display of the

position of tactical targets (1953). This feature is now used in great profusion in voltage regulators wherever highly precise and stable voltage is required. **Information, as provided by radar, is in analog form, and it must also be in this form to display it on a PPI. To utilize digital techniques in this connection, NRL devised the first high-precision (0.1 percent) analog-to-digital and digital-to-analog converters (1951) and the first high-speed converters (1953) for digital data systems.**<sup>19,20</sup> With the latter, a ten-bit word could be completely converted in less than 20 microseconds. These converters were termed ADCON (analog-digital) and DACON (digital-analog), respectively. NRL adapted its conducting-glass-probe technique, so that a PPI operator in tracking a target could generate target-position coordinates in binary digital form and insert the data in this form in the memory (1957).<sup>21</sup> Provision was made for automatic digital switching to the next target of the series being tracked to accelerate the tracking operation. Velocity data were then generated automatically in digital form. NRL also developed a technique for automatic target detection and determination of target-position coordinates in binary digital form (1955).<sup>22</sup> This technique (MATALOC) involved conversion of digitized video data from polar to rectangular coordinates, integration of the converted digitized video data, and automatic determination of the center of the radar target to obtain the coordinates. Means were also developed for the electronic generation of letters and numbers to display target characteristic data. The alphanumeric data were arranged about and associated with the target plan position on the PPI (1952).<sup>23</sup>

To provide advanced capability for coordinated effort by Naval task forces in air defense, NRL devised a binary-digital tactical data-transmission system for the interchange of pertinent data existing in the memories of the several ships in company (1952).<sup>24</sup> This system was capable of transmitting ship-position coordinates, target number, target

ELECTRONIC SYSTEMS INTEGRATION



**THE FIRST HIGH-PRECISION ANALOG-TO-DIGITAL (ADCON) AND DIGITAL-TO-ANALOG (DACON) CONVERTERS (1951); THE FIRST USE OF A LADDER DIGITAL NETWORK FOR ENCODING AND DECODING CIRCUITRY (1951); THE FIRST MAGNETIC DISK TYPE DIGITAL MEMORY, NOW WIDELY USED (1952)**

NRL was the first to develop analog-to-digital and digital-to-analog converters having a precision of 0.01 percent. These converters are necessary for displaying digital data on cathode-ray tubes of PPIs and for processing of digital data taken from the analog circuits of such tubes and of radars which are also analog. The rack right of center contains the converter. The magnetic-disk digital memory is shown at the lower right.

plan-position, identity, size, and height for 100 targets. An experimental model was developed by NRL to demonstrate the capability of transmitting and displaying such data. Transmission was over channels in the high-frequency band, with frequency multiplexing to permit operation over circuits disturbed by multipath, with ranges out to 200 miles (1952). In 1955 the Bureau of Ships placed a contract with Collins Radio Corporation for a tactical data-transmission system, designated the HICAPCOM SYSTEM (High Capacity Communication), with NRL providing technical guidance of the contractor. This system was based on the results of NRL's work on data systems and also on high-precision frequency control, single-sideband transmission, multiplexing, and cipher generation, previously covered in Chapter 3, "Radio Communication." Models of this system were produced by the contractor. Sea trials were conducted with installations of the system aboard three of the four destroyers forming Destroyer Division 61, the USS NOAH, USS MEREDITH, and USS STRIBLING, to verify performance of the system (1957).

In 1956 the Navy proceeded to contract for operational equipment for a binary digital data system known as the Naval Tactical Data System (NTDS),<sup>26</sup> which was used extensively throughout the Naval forces. The system processes data available from the various electronic sensors through the use of electronic computers and provides data in a form effective for use in carrying out command-and-control functions in the coordinated conduct of the several modes of Naval warfare. Responsibility for the overall contract and production of the computer portion was placed with the Remington-Rand Corporation (UNIVAC division of Sperry Rand Corporation). Collins Radio Corporation had responsibility for the ship data link, and Hughes Aircraft Corporation for the data displays. The Naval Electronics Laboratory was assigned responsibility for overall evaluation

of the system. NRL had responsibility for guidance of Collins Radio Corporation in producing the ship data link equipment and its evaluation. The HICAPCOM system merged into the NTDS data link. Its high precision of frequency control and its flexibility through the early use of frequency synthesizers was an important factor in making the NTDS effective. The features of the NTDS reflect the basic concepts of NRL's original work. NRL placed the results of its work at the disposal of the several contractors, engaging in many conferences with them in furtherance of the development. Since then, NRL has continued to provide consulting services and technical assistance to the Naval Ship Systems Command concerning aspects of the NTDS, such as integrated sensor processing and conversion equipment, and evaluation of prototype hardware and software. NRL has contributed to the automatic signal data converter of the auto-tracking system, to the video signal-processing system which supplies automatic tracking and identity input for all friendly targets, to the conversion of analog data to digital for the weapons interface, and to the processing of radar (SPS-48) data in a format suitable for input to the NTDS for automatic tracking (1966-1971).<sup>26</sup> In 1961 the first NTDS service test ships, systems, and operational programs went to sea. The first NTDS group of ships, comprising the USS ORISKANY, the USS KING, and the USS MAHAN, were deployed in company in July 1962. Since then, additional installations were made as rapidly as possible in an effort to equip all major combatant ships and most guided-missile destroyers. NTDS versions were adapted to a variety of vessels, large and small.

#### THE NAVY'S AIRBORNE TACTICAL DATA SYSTEM (ATDS)

As previously stated, upon entering the postwar period the prospective threat of very large

## ELECTRONIC SYSTEMS INTEGRATION



60834 (H-512)



60834 (H-513)

### THE NAVAL TACTICAL DATA SYSTEM (NTDS)

Since 1956, NRI has made contributions to the elements of this system, including integrated sensor processing and conversion equipment, the automatic signal data converter of the auto-tracking system, the video signal processing system, the conversion of analog data to digital for the weapons interface, the processing of data into a format suitable for automatic tracking, the evaluation of prototype hardware and software, and the transmission of data between task force ships. The NTDS air-coordination and threat-evaluation area (above) and the detection and tracking area (below) aboard the nuclear-powered carrier USS ENTERPRISE are shown.



numbers of attacking aircraft operating at much higher velocities in future warfare was visualized as requiring the use of automatic means wherever possible, to relieve own personnel and to speed up operations in carrying out interception functions, if these were to be successfully accomplished. From the airborne viewpoint interception of enemy aircraft was considered largely a problem in the realm of the air. While powerful shipborne radars would provide long-range detection and identity of targets, once the target of attack came within the range of the fighter-aircraft capability, interception was a task to be accomplished through airborne means. After the war, consideration of this requirement for automatic operation led NRL to initiate a program, supported by the Bureau of Aeronautics (later the Bureau of Weapons), to develop a system entitled the Automatic Aircraft Interceptor Control System, AAICS (1948).<sup>27</sup> All aspects of the system were treated, including the collection and processing of target data aboard ship or AEW aircraft, its transmission to interceptor aircraft, its utilization aboard this aircraft, and repeat-back from the aircraft to ship or AEW aircraft to permit remote instantaneous observation of the action of the interceptor aircraft.<sup>28</sup> New techniques were devised; some have already been described, such as the generation, storage and display of target data.<sup>29</sup>

In introducing one phase of automatic operation, NRL was first to develop a system employing an electronic computer-type device for replacing voice communications in carrying out the major function of vectoring interceptor aircraft in the acquisition of aircraft targets (1952).<sup>30</sup> Designated the Triangle system, its performance was first demonstrated in simple form with simulated targets at NRL's Chesapeake Bay site (1952). NRL was also first to demonstrate, in an aircraft-interception system, the transmission, automatically via digital data link, of remotely acquired and processed data (as from ship or AEW aircraft) to an interceptor for direct control of the interception of target aircraft aboard the interceptor aircraft (1958). NRL was first to

demonstrate another valuable feature of the system, involving return transmissions from the interceptor aircraft automatically via digital data link for instantaneous observations at the remote-control station of interceptor data, such as present heading, airspeed, and altitude for determining ability to complete intercepts in target assignment (1958). The Triangle system permitted quick determination of whether an interception with selected paired aircraft was possible. Thus, the pairing of existing aircraft could be effectively and promptly carried out. Time-to-go to interception was continuously indicated to aid the pilot. In NRL's device, two strobes were presented on a cathode-ray tube, one proceeding from the interceptor's position, the other from the target's position, which showed the present relative course of the target, the predicted intercept point, and the course the interceptor should fly to effect interception. The relative lengths of the strobes represented the ratio of the speeds of the two aircraft. This factor was automatically computed by multiplying electronically the speed of each aircraft by the time required for coincidence of the two strobes or the interception point. Numerous interceptions were conducted with an F4B interceptor aircraft equipped with the NRL Triangle system against available target aircraft, using radar and data-processing equipment located at the NRL Chesapeake Bay site (1958-1959). The Navy equipped four F4H-1 and twelve F4G interceptor aircraft with the Triangle system and sent these to the Fleet for operational use.

About the time that the Bureau of Ships established the NTDS project, the Bureau of Aeronautics initiated the Airborne Tactical Data System project (1956). The ATDS provides data gathering, processing, display, control, and transmission facilities to serve airborne command and control functions.<sup>31</sup> It includes the several airborne components, whereas the NTDS includes related components that are shipborne. The ATDS and NTDS have provision

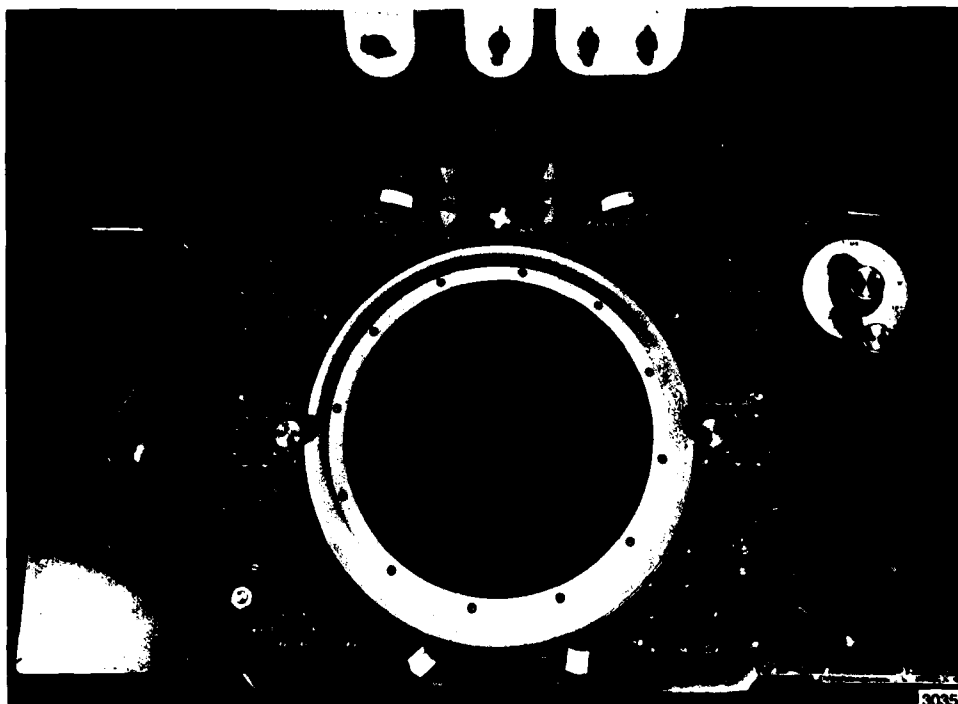

**TRIANGLE SYSTEM, THE FIRST ELECTRONIC COMPUTER-TYPE DEVICE FOR VECTORING INTERCEPTOR AIRCRAFT IN ACQUISITION OF AIRCRAFT TARGETS**

The Triangle system, developed by NRL (1952), used two strobos drawn on the PPI. The angle between the strobos corresponded to the course of the target and the course required to be flown by the interceptor for interception. The lengths of the strobos corresponded to the product of the velocities of the respective aircraft and the time required for closing. The course of the interceptor and the closing time were adjusted so that the tips of the strobos met in a point, with offset allowance being made for the final intercept maneuver. A number of aircraft were equipped with the Triangle system and were sent to the Fleet for use.

for the compatible interchange of tactical data pertinent to airborne-ship functions. The earlier AAICS program merged into that for the ATDS. NRL's continuing contributions to these programs, particularly those with respect to AEW radar and to data handling and transmission, were essential to the satisfactory performance of the ATDS. The ATDS was used extensively by the Navy. To provide a suitable AEW aircraft, a major element of ATDS, the Bureau of Aeronautics entered into a contract with Grumman Aircraft Corporation for the type W2F-1

(Hawkeye) aircraft. NRL developed the Rotodome antenna, possessing low beam-pattern distortion, for the Model AN/APS-96 radar, specially designed for this aircraft.

NRL also developed the monopulse technique, giving high angular accuracy and the instantaneous height-finding technique utilized in this radar. To increase the angular accuracy of the target-position data furnished by this radar, NRL contributed its MATALOC automatic digital antenna beam-splitting technique, which provided position coordinates in rectangular

form with high accuracy. NRL developed the conducting-glass-probe technique through which target plan-position coordinates were obtained in digital form from PPIs, for the initiation of automatic tracking and the display of selected targets in utilizing the data of this AEW radar. The data links for two-way transmission of interception data between AEW and the interceptor aircraft and for data interchange with the NTDS are also important components of the ATDS. The development of the Navy's AEW-interceptor data link for the ATDS, the AN/USC-2 (by Bell Telephone Laboratories) evolved from NRL's early demonstration of transmission via digital data link of interception data for vectoring interceptors and return transmission to the control point for determining capability to complete intercepts. The AN/USC-2 data link has been designated "NATOLINK-4." Another data link for interchange of interception data between ATDS and NTDS has been designated "NATO LINK-11." NRL has provided extended guidance and consultative services to the several contractors engaged in the production of the ATDS components. The Laboratory has also been involved in the evaluation of the performance of these components. The type W2F-1 (Hawkeye) aircraft was redesignated the E-2A (1964), with modernization including a programmable computer. Further improvements have been included in the type E-2B AEW aircraft (1969). The types of AEW aircraft, the E-2A, E-2B, and E-2C, utilize the NRL-originated unique features incorporated earlier in the type W2F-1 aircraft. These features included the monopulse radar, rotodome antenna, and the automatic antenna beam-splitting, conducting-glass-probe target designation and data-link techniques.

#### MARINE TACTICAL DATA SYSTEM (MTDS)

In 1953 NRL brought the results of its Electronic Tactical Data System program to the attention of Marine Corps representatives, to

interest the Marine Corps in developing a data system to advance its operational capability. Lack of funds impeded subsequent action. However, sponsorship by the Office of Naval Research of an effort in which NRL and Navy Department representatives participated resulted in the formulation of detailed requirements and specifications for an electronic tactical data system to meet the command-and-control needs of the Marine Corps. Based upon these requirements and the attending specifications, the Marine Tactical Data System (MTDS) project was initiated (1957).<sup>31,32</sup> A contract was awarded the Data System Division of Litton Systems by the Marine Corps office of the Bureau of Ships for procurement of equipment (1957).

The MTDS is similar in basic philosophy to the NTDS and the ATDS. It differs principally in its transportable packaging, its capability for quick installation, such as on beaches, and in its provision of communication netting most suitable for Marine Corps type of operations. The MTDS is compatible with the NTDS and the ATDS, with respect to the interchange of the tactical data necessary for the conduct of Marine Corps operational functions. Since technical parameters and software variations exist between these systems, interfacing has been provided where necessary. The MTDS provides, as do the other two systems, operation commanders with data pertinent to air defense, air-traffic control, weapon systems, and force status, and to many other areas required in the operational environment. Carrier-based aircraft may be used by an MTDS land-based control center to permit deployment in close support of Marine Corps actions.

In addition to NRL's contributions to the MTDS made during its formative period, the MTDS incorporates NRL's conducting-glass-probe PPI plan-position data take-off technique for target selection and track initiation. This technique has proven successful in operational use, since it is both rapid and accurate. The MTDS also uses data links similar to the

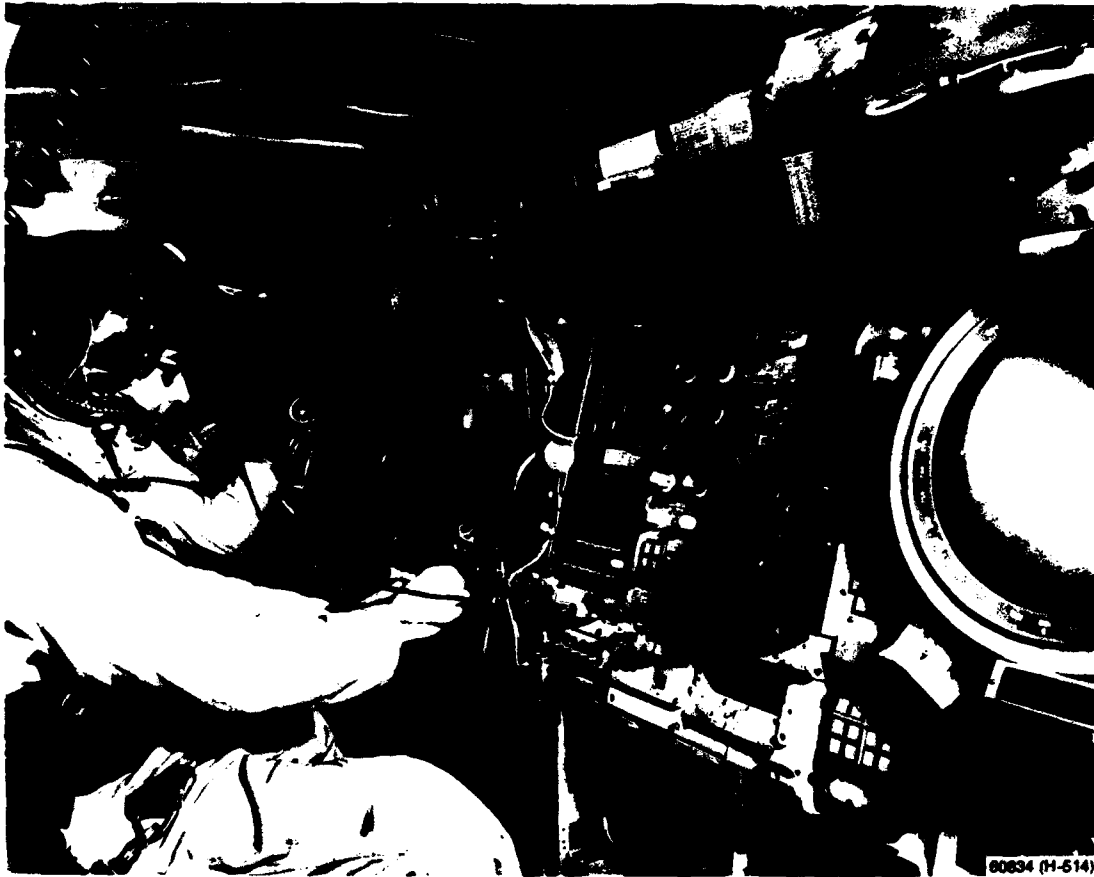

**AIR TACTICAL DATA SYSTEM (ATDS) CIC ARRANGEMENT WITH ITS PPI DISPLAYS ON A TYPE E2-C AIRCRAFT, THE LATEST VERSION OF THE E2-A AEW AIRCRAFT (1973)**

The operator is shown using NRL's conductive-glass-probe PPI target-position take-off. Through its research, which began in this field in 1948, NRL has contributed to important aspects of the ATDS. In addition to the probe take-off technique, NRL's work included the monopulse radar, its aircraft rotodome antenna, the automatic beam splitter, data link, and the Triangle aircraft interception system.

NRL data link previously described. For interchange of data with the MTDS, it uses NATO LINK-11 (U.S. designation, TADIL-A). For interchange with the ATDS, it uses NATO LINK-4 (U.S. designation, TADIL-C). For interchange between surface units it uses NATO LINK-1 (U.S. designation TADIL-B). NRL continued to provide technical consultative services to the Bureau of Ships

and guidance to the contractor during the several years of MTDS developmental effort. Developmental models of one command center and two operational centers became available in 1962. This action was followed by procurement in quantity, with the MTDS going operational in 1967. Subsequently, it was utilized extensively in Vietnam, one important feature being

## ELECTRONIC SYSTEMS INTEGRATION



00834 (H-518)



00834 (H-518)

### MARINE TACTICAL DATA SYSTEM

The MTDS console operator of a mobile installation is shown below using the NRL-originated conducting-glass-probe PPI target data-take-off device. This device is used for placing plan-position information into the electronic memory, for updating the position in tracking, for associating other information with the target, and for selectively displaying information in the memory. The detector-tracking-control area is shown above, and the operator using NRL's conductive-glass probe is shown below.

## ELECTRONIC SYSTEMS INTEGRATION

the rapid location of downed aircraft and the effective pickup of personnel by rescue craft.

### REFERENCES

1. NRSR, Feb. 1923, pp. 16-27, reproducing Bureau of Engineering letter of 2 Jan. 1923 to Commander-in-Chief, U.S. Fleet
  - NRSR, Oct. 1922, pp. 29-33
  - NRSR
    - Feb. 1923, p. 22
    - Mar. 1923, pp. 15-24
    - Aug. 1923, p. 58
    - Nov. 1923, pp. 1-10
    - Dec. 1923, pp. 18-20
    - May 1924, p. 11
    - Aug. 1924, pp. 26-27
2. R.M. Page, report to Commander Atlantic Squadron via Commanding Officer, USS NEW YORK, 3 Apr. 1939, copy in NRL File S-567/5, "Radio Detection of Moving Objects," 1936 to 1939, NRL CRMO
3. "Report of Progress - Problem W5-2S," NRL letter to Bureau of Engineering S-567/36, Ser. 135, 26 Feb. 1940, copy in NRL File S-567/5/36, No. 2, July 1939-Sept. 1940, NRL CRMO
  - R.M. Page, U.S. Patent 2,779,939
4. (See Chapter 6, Refs. 2 through 11.)
5. R.M. Page, U.S. Patent 2,702,899
6. NRL letter C-567/5(381), C-380-567/45 to OIR, 26 Oct. 1945, NRL CRMO
  - OIR, Planning Division, letter to NRL, JTB.rej, 8 Nov. 1945
7. D.J. McLaughlin, L.M. Johnson, "U.S. Navy Radar Systems Survey," NRL Report 3544, Sept. 1949
  - C.B. Upp, "U.S. Navy Radar Systems Survey, Second Edition," NRL Report 4128, Apr. 1953
  - E. Ornstein, "U.S. Navy Radar Systems Survey - Third Edition," NRL Report 4963, Nov. 1957
8. R.M. Maiden, "Systems Integration, Evaluation of the British Comprehensive Display System," Report of NRL Progress, Oct. 1951, pp. 10, 11
  - "British Comprehensive Display System," Report of NRL Progress, Apr. 1951
  - G.C. Winston, "Systems Integration, Combined Electronics Systems (Intercept Control Studies)," Report of NRL Progress, Apr. 1952, p. 8
  - E.F. Kulikowski and R.M. Maiden, "Systems Integration, Comprehensive Display System," Report of NRL Progress, Apr. 1952 pp. 8,9
  - R.B. Whiteley, "Synchronization of Comprehensive Display System Early Warning Group with AEW Facility on AN/SPA-9 Radar Indicator," NRL Memo. Rept. 10, May 1952
9. "Final Report on Evaluation of the Comprehensive Display System," Fleet, Comopdev for Project No. OP/S224/J-15, July 1952, NRL 88,290
10. D.F. Grady, "An Improved Display Switch for the Comprehensive Display System," NRL Memo. Rept. 39, July 1952
  - H.G. Talmadge, "A Gating Circuit for Displaying Selected Targets on a Range Height Indicator," NRL Memo. Rept. 50, Sept. 1952
  - L. Nelson, "Retrace Insertion Equipment for Use with Radar Repeater Indicators," NRL Memo. Rept. 86, Oct. 1952
- F.R. Fluhr, "Height Radar Target Simulator," NRL Memo. Rept. 105, Sept. 1952
- W.H. Huntley, "A Range Computer Based on X-Y Coordinate Voltages," NRL Memo. Rept. 118, Jan. 1953
- T.H. Mickelson, "A Method for Equally Distributing Tracks to Tracking Operators in the Comprehensive Display System," NRL Memo. Rept. 154, May 1953
- A.C. Grosvenor, "Target Course and Speed Display," NRL Memo. Rept. 270, Mar. 1954
11. "COSMOS, A Survey of Existing Fleet Radio Communications and Recommendations for Improvement," Western Electric Co., Inc., Oct. 1951, NRL 76,257
  - "Project COSMOS," Bell Telephone Labs. Final Report, Oct. 1956, NRL 174,331
12. D.J. McLaughlin, "Electronic Data System," NRL Report 4473, Jan. 1955
  - F.R. Fluhr, "Naval Data Handling System Circuits," NRL Report 5645, Aug. 1961
  - A.S. Irish, E.L. Plowman, J.L. Nichols, W.H. Wiederspahn, and J.E. Karroll, "Evaluation of the Electronic Data System," NRL Memo. Rept. 503, July 1955
  - J.L. Nichols and E.L. Plowman, "Evaluation of the Electronic Data System (Second Partial Report)," NRL Memo. Rept. 566, Feb. 1956
  - D.H. Abbott, J.H. Caywood, J.C. Pavetto, and M.S. Vargo, "A Technical Evaluation of the Electronic Data System on the USS Willis A. Lee (DL-4)," NRL Memo. Rept. 595, May 1956
  - "Combat Information Center Systems," Annual Report, 1957, Naval Research Laboratory, p. 20
  - "Naval Data Handling System," Annual Report, 1959, Naval Research Laboratory, pp. 16-18
  - H.G. Talmadge, Jr., "Use of an Electrolytic Tank in Study of Surface Electric Field Distributions," NRL Report 3834, Oct. 1951
  - F.R. Fluhr and D.J. McLaughlin, "The Naval Data Handling System Pickoff Display Converter," NRL Report 5248, Jan. 1959
  - D.F. Grady and W.D. Dahl, "Evaluation of an Experimental Plan Tracking Equipment," NRL Report 5266, Apr. 1959
  - S.C. Wardrip, "The Naval Data Handling System Capabilities in Position and Rate-Aided Target Tracking," NRL Report 5672, Oct. 1961
13. C.J. Kurner, "An Electronic Rate-Aided Position Storage Device," NRL Memo. Rept. 139, Mar. 1953
  - L.S. Rider, "Symbol Generation Employing Lissajous Figures," NRL Memo. Rept. 178, July 1953
  - C.J. Kurner, "An Improved Electronic Store for Manual Rate-Aided Tracking," NRL Memo. Rept. 331, July 1954
  - J.E. Karroll, "A Partial Evaluation of the Target Designation Features of the NRL Electronic Data System," NRL Memo. Rept. 471, May 1955
14. P.L. Wedding, "A Method of Target Data Pick-Off and Display," NRL Report 3959, Apr. 1952
  - H.G. Paine, "Electromechanical Plotting Board - 4 Foot by 4 Foot," NRL Report 5032, Nov. 1957
15. C.C. Rae, "A Proposed Teletype Data Communication System for Use with the Electronic Data System," NRL Report 4646, Nov. 1955
  - D.J. McLaughlin, "The Naval Data Handling System Operations with the Data Link and Track Number Store," NRL Report 5261, Feb. 1959

## ELECTRONIC SYSTEMS INTEGRATION

- D.J. McLaughlin, "The Naval Data Handling System Communications System," NRL Report 5442, Mar. 1960
- 16. R.B. Whiteley, "Capabilities of Computers with Possible Application in Electronic Command Systems," NRL Report 3409, Mar. 1949
  - P.C. Sherertz, "Proposals for CODAER (Combat Data Exchange Relay)," NRL Report 3455, Apr. 1949
- 17. D.J. McLaughlin and F.R. Fluhr, U.S. Patent 2,840,440
- 18. E. Burstein, E. Toth, D. Gridley, and A. Schooley, "Colloquium on Transistors in Theory and Practice," NRL Report 4049, May 1952
  - F.R. Fluhr, "Subminiature Package Units," NRL Memo. Rept. 461, May 1955
  - F.R. Fluhr, Logbook, NRL Registry No. 7990, 1952, NRL CRM0
  - F.R. Fluhr, File Memo C-51110-97; 56 MCH 24 May 1956, NRL Problem 51Y01-02, NRL CR MO
- 19. F.R. Fluhr, U.S. Patent 3,100,298
- 20. R.M. Rappel, "The ADCON, An Analogue-to-Digital Converter," NRL Memo Rept 40, July 1952
  - F.R. Fluhr, "A Binary to Analog Resistance Network," NRL Memo Rept 241, Dec. 1953
- 21. F.R. Fluhr, "Digitalized Pickoff Display Converter," NRL Report 5281, Mar. 1959
  - F.R. Fluhr, U.S. Patent 3,102,926
- 22. J.K. Strake and J.P. Leiphart, "Magnetic Target Locator (MATA LXX)," NRL Report 4841, Oct. 1956
- 23. R.B. Whiteley, "Electronic Display of Combat Data in the Form of Letters and Numbers," NRL Memo Rept 174, June 1953
  - L.S. Rider, "Symbol Generation Employing Lissajous Figures," NRL Memo Rept 178, July 1953
  - D.J. McLaughlin, "Orbital Code Display Digital Data Systems Displays," NRL Memo Rept 241, Dec. 1953
  - R.B. Whiteley, "Tactical Display Systems," NRL Memo Rept 282, Apr. 1954
- 24. R.M. Maiden and R.B. Whiteley, "Electronic Data Processing Techniques," NRL Report 4540, June 1955
  - C.B. Davis, "A Tactical Display Data Transmission System," NRL Memo Rept 7, May 1952
  - B.W. Graham, "Terminal Systems—Telepicture and Speech Privacy," Report of NRL Progress, Sept. 1956, p. 13
- 25. J.W. Newland, CAPT, "Pacific Fleet Data Communications," Signal, Nov. 1970, pp. 22-24
- 26. D.A. MacGillivray and J.D. Byrd, "CIC Requirements for Future Aircraft Carriers," NRL Report 5670, Nov. 1961
  - D.F. Grady, "Summary of Factors Related to Tracking Systems," NRL Report 5754, Feb. 1962
  - D.F. Grady, "Evaluation of Tracking and Display System (TADS) at the Chesapeake Bay Annex of NRL," NRL Report 6211, Mar. 1965
  - D.F. Grady and W.D. Dahl, "Evaluation of Signal Data Converter CV-760/SS in Conjunction with an Automatic Tracking Program," NRL Test and Evaluation Report 63 Feb. 1966
  - D.F. Grady and W.D. Dahl, "Evaluation of Beacon Video Processor (BVP) System," NRL Test and Evaluation Report 78, Dec. 1967
  - D.F. Grady and W.D. Dahl, "Technical Evaluation of Honeywell Voltage and Synchro Interface Module (VASIM)," NRL Test and Evaluation Report 82, Feb. 1968
  - D.F. Grady and W.D. Dahl, "Technical Evaluation of Voltage and Synchro Interface Module (VASIM II), CV-203(V), USQ-20(V)," NRL Test and Evaluation Report 86, June 1968
  - D.F. Grady, W.D. Dahl, and R.J. Orsino, "Evaluation of AN/SPS-48 Micro-Min Data Programmer System (XN-1)," NRL Test and Evaluation Report 100, Aug. 1969
  - D.F. Grady, W.D. Dahl, and R.J. Orsino, "Evaluation of SIF Processor of AN/SPS-48 Micro-Min Data Programmer System," NRL Test and Evaluation Report 103, Jan. 1970
  - D.F. Grady, W.D. Dahl, and R.J. Orsino, "AN/SPS-48B Operational Program Baseline Tests," NRL Test and Evaluation Report 109, Feb. 1970
- 27. J.J. MacGregor, S. Riccobono, W.W. Balwanz, G.F. Wall, K.L. Huntley, and J.F. Plunkert, "Preliminary Study of an Airborne Command System," NRL Report 3164, Aug. 1947
  - "Airborne Radio Systems Interrogation Study," NRL Problem 36R07-23, Radio Div. III, Report of NRL Progress, June 1947, p. 26
  - "Airborne Radio Systems Integration (BuShips)," NRL Problem 36R07-23, Radio Div. III, Report of NRL Progress, July 1947, p. 49
  - "Systems Integration, Combat Command," NRL Problem 39R07-25, Radio Div. II, Report of NRL Progress, Mar. 1948, p. 33
- 28. W.S. Alderson, P.A. Guarino, and A.A. Varela, "A Study of Computers and Radar for Aircraft Interception Control," NRL Report 3368, Nov. 1948
  - B.F. Harrell, "An Analysis of the Attack Approach to the Aircraft Duel," NRL Report 3479, June 1949
- 29. H.G. Paine, "Two-Dimensional Simulation of the Automatic Aircraft Intercept Control System," NRL Report 3617, Jan. 1950
  - H.G. Paine, "An Electronic Aid for Aircraft Tracking and Interception," NRL Report 3665, Apr. 1950
  - R.B. Whiteley, C.J. Kurner, and W.D. Dahl, "Evaluation of Manual Tracking Techniques for Search Radar," NRL Report 4744, Apr. 1956
  - S. Riccobono, H.G. Paine, and G.C. Winston, "Evaluation of Integrated Airborne Displays for Interceptor Aircraft," NRL Report 5339, June 1959
- 30. H.G. Paine, "Evaluation of Integrated Airborne Displays for Interception Aircraft. Part 2—Triangle Display System," NRL Report 5644, Aug. 1961
  - H. Bixhorn, "Statistical Decomposition of a Mixture of Two Gaussian Populations," NRL Report 6226, Mar. 1965
  - A.C. Grosvenor and J.C. Pavetto, "Intercept Control Triangle System for Use with Radar Indicator AN/SPA-9," NRL Memo. Rept. 360, Sept. 1954
  - D.F. Grady, "An Experimental Shipboard Intercept Control System," NRL Memo. Rept. 307, Aug. 1955
  - "Triangle System for Aircraft Control," NRL Annual Report 1958, pp. 3-4
- 31. "D : Transmission, Automatic Tactical Communications," US Naval Aviation Electronics Digest, Dec. 1957, pp. 3-15
- 32. A.M. Cordes, COL, USMC, "Tactical Data Comm is Well in Hand," Signal, Nov. 1970, pp. 42, 43

## Chapter 11

### SATELLITE ELECTRONICS

#### INTRODUCTION

NRL has been a pioneer in the development of satellites and satellite systems for scientific and operational objectives, and has conducted a long-term, continuing program in this field. In Chapter 8, NRL's work in providing the first determination of the orbit of a manmade satellite (1957), the first Russian satellite, Sputnik I, was described. Chapter 3 reviewed NRL's work which resulted in the world's first operational satellite-communication system (1959). The Laboratory's further work to meet the satellite-communication requirements of the Navy was also described. Chapter 3 also reviewed NRL's work with NRL-developed satellites to determine the feasibility of communicating with submerged submarines with satellites transmitting on VLF (1961). Chapter 8 stated that NRL was first to determine the performance of a radio direction finder and its site, including the effects of nearby mountains, using signals transmitted from an NRL-developed satellite (1966). In Chapter 9, NRL's success was described in transferring standard time for the first time over long distances via communication satellites, with a precision as high as one-tenth microsecond. This first made possible highly precise synchronization of time functions on a worldwide basis (February 1970).

#### PROJECT VANGUARD

As a part of the scientific program for the International Geophysical Year (1957-1958), through the coordinated efforts of the National Academy of Sciences, the National Science Foundation, the Department of Defense, and the Office of

Naval Research, NRL was officially delegated the responsibility of placing an artificial satellite with a scientific experiment into orbit around the earth (9 Sept. 1955).<sup>1</sup> The responsibility included the provision of the first U.S. satellite tracking system, to demonstrate that the satellite had actually attained orbit. Proposals for such a satellite system had been made by three organizations; NRL's proposal was the one which was accepted. The project was named "Vanguard."

The acceptance of NRL's proposal was based on the experience and successful results NRL had obtained in the extensive use of rockets to determine the properties of the earth's upper atmosphere.<sup>2</sup> This experience included the design and execution of scientific experiments, the development of telemetry systems for transmitting real-time data to earth, and the design of rockets. Parts for almost 100 German V-2 rockets had been brought to this country after the war. The U.S. Army had undertaken the task of assembling the rockets at White Sands, New Mexico, for research and experimentation by government agencies and universities. In taking advantage of this situation, NRL was first to use one of these V-2 rockets and equipped it with instrumentation for probing the earth's higher atmosphere. On 28 June 1946, NRL launched a V-2 rocket which carried to an altitude of 67 miles a geiger-counter telescope to detect cosmic rays, pressure and temperature gages, a spectrograph, and radio transmitters for telemetry transmissions. During the following six years, 63 V-2 rockets were launched at White Sands. They carried over 20 tons of scientific instruments to altitudes ranging usually between 50



and 100 miles. Two-thirds of the flights were successful.

When it became evident that the supply of V-2 rockets would be exhausted, NRL proceeded to develop its own rocket, with the aid of a contractor, the Glenn L. Martin Company. NRL's rocket, designated the "Viking," embodied the successful, important innovations of a gimballed motor for steering and intermittent gas jets for stabilizing the vehicle after the main power cutoff (1949).<sup>3</sup> These devices are now extensively used in large, steerable rockets and in space vehicles. The engine was one of the first three large, liquid-propelled, rocket-powered plants produced in the United States. The Viking-1 rocket, fired early in 1949, attained a 50-mile altitude. The Viking-10, fired early in 1954, provided the first measurement of positive ion composition at an altitude of 136 miles. Viking-11, fired in May 1954, rose to 158 miles, an all-time altitude record for a single-stage rocket. A total of twelve Viking rockets were launched. Through these Viking rocket firings, NRL was first to measure temperature, pressure, and winds in the upper atmosphere, and electron density in the ionosphere, and to record the ultraviolet spectra of the sun. NRL also took the first high-altitude pictures of the earth (1949-1954). During a launching over New Mexico, a camera mounted in an NRL Viking rocket took the first picture of a hurricane and a tropical storm, from an altitude as high as 100 miles (5 Oct. 1954).<sup>4</sup> The picture embraced an area more than 1000 miles in diameter, including Mexico and the area from Texas to Iowa. This was also the first natural-color picture of earth from rocket altitudes. NRL's high-altitude photographs of earth cloud cover led to the interest of the U.S. Weather Bureau in high-altitude weather reconnaissance, which is now routinely accomplished with satellites. The data obtained are universally used in daily weather broadcasts.

The success NRL achieved in the series of experiments cited encouraged Laboratory scientists to believe that, with a more powerful engine and the addition of upper stages, the Viking

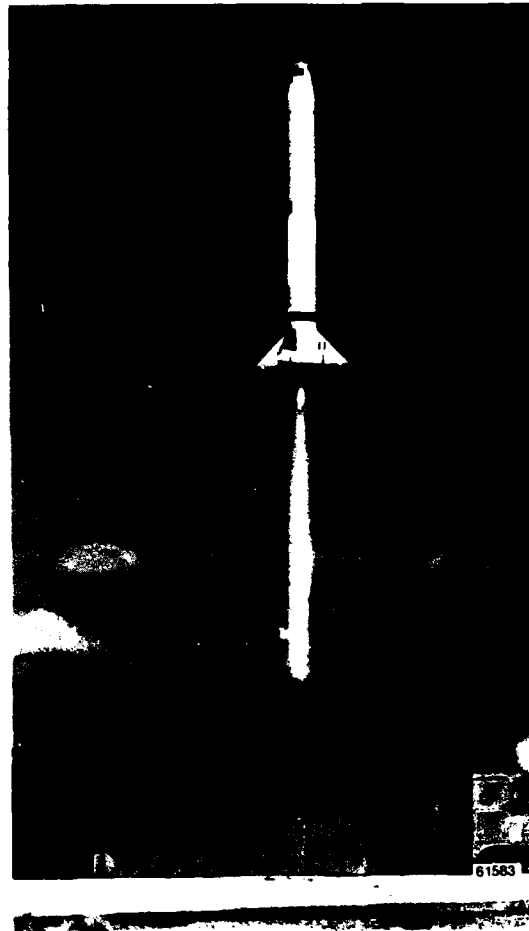

NRL'S VIKING ROCKET (1949-1954)

This rocket contained the important innovations of a gimballed motor for steering and intermittent gas jets for stabilizing the vehicle after main power cutoff. These devices are now used extensively in large steerable rockets and in space vehicles. The engine was one of the first three large liquid-propelled rocket power plants produced in the United States. With the Viking rockets, NRL was first to measure temperature, pressure, and wind in the upper atmosphere and to record the ultraviolet spectra of the sun. With one of these rockets, NRL took the first high-altitude pictures of the earth. NRL's success with these rockets led to NRL's Vanguard project. Shown is the Viking-11, launched in May 1954, which rose to 158 miles, an all-time altitude record for a single-stage rocket. It was also the heaviest Viking of the series fired.

## SATELLITE ELECTRONICS

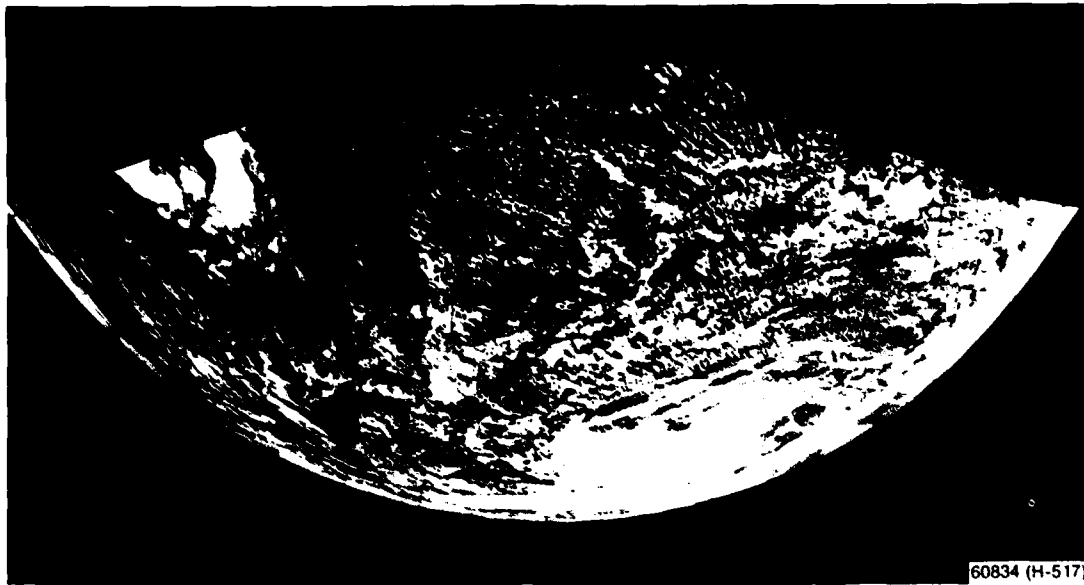

60834 (H-517)

### FIRST HIGH-ALTITUDE PICTURE OF A HURRICANE IN A TROPICAL STORM (5 OCT. 1954)

This picture, taken from an altitude of 100 miles during an NRL Viking rocket launching, embraces an area more than 1000 miles in diameter, including Mexico (left) and Texas to Iowa (right). The eye of the hurricane is shown in the bottom portion (light area) over the Gulf of Mexico. Note the position of the minor vortex in the upper left corner. The picture is a mosaic assembled from individual frames of a movie camera carried by the rocket. Although shown here in black and white, it is the first successful natural-color picture from rocket altitudes. NRL's high-altitude photographs of earth cloud cover initiated the interest of the U.S. Weather Bureau in high-altitude weather reconnaissance, now accomplished with satellites. The data now obtained are universally used in daily weather broadcasts.

rocket could be made a vehicle capable of launching an earth satellite. With much travail with respect to funding, negotiations, design, construction, and testing, NRL, through the aid of a contractor, developed a three-stage launching vehicle patterned after its Viking rocket for project Vanguard. This vehicle became an important milestone, since it was the basis for the design of future launching vehicles, particularly the reliable, present-day "Delta," which has had a remarkable record, having placed into orbit the majority of the National Aeronautics and Space Administration's communication, meteorological, and scientific satellites.

Since suitable satellite-launching facilities were not available, NRL constructed the first

complete satellite-launching facility, installing it at Cape Canaveral, with central control at NRL (1957). Suitable means for observing launchings underway were not available, so NRL provided the first "down-range" instrumentation for determining the performance of multistage vehicles under launch, where critical functions involved in attaining orbit had to be performed many hundreds of miles from the launch pad. To provide means for determining the orbit of a satellite, NRL developed the first satellite-tracking system, called "Minitrack" (1956).<sup>3</sup> This system evolved from NRL's work on phase-comparison and angle-tracking, and utilized a series of fan-shaped, vertical antenna beams. The system comprised a chain of stations extending

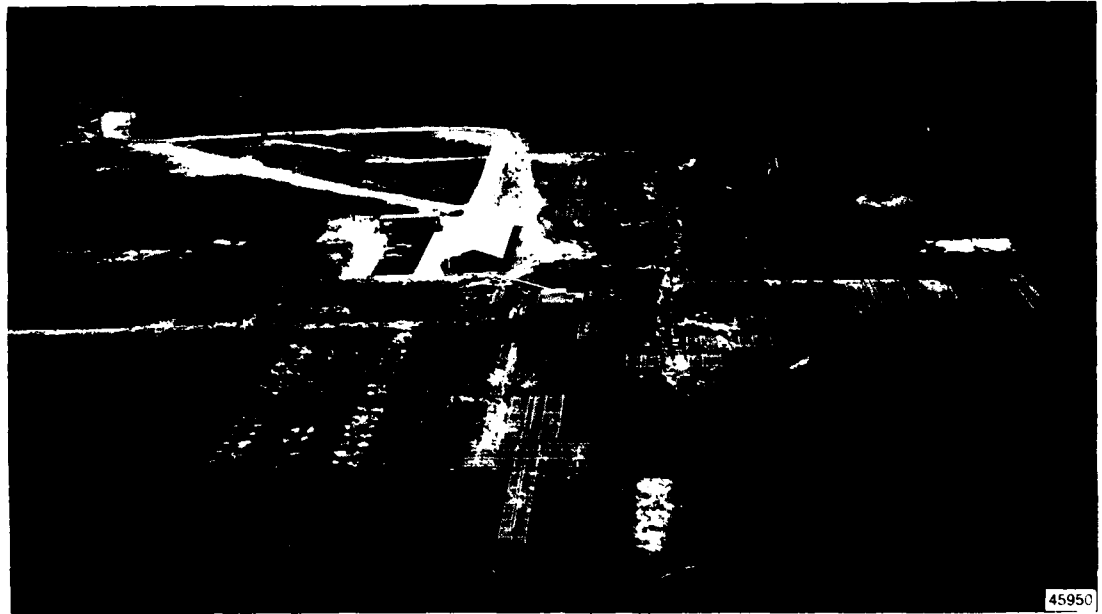

THE FIRST SATELLITE TRACKING SYSTEM – "MINITRACK" (1956)

This system, developed by NRL to track the Vanguard Satellite, incorporated NRL's phase-comparison and angle-tracking techniques and utilized a series of fan-shaped vertical antenna beams forming a "fence." The antennas are seen as rectangular-shaped objects on the field. The system comprised a chain of stations extending from Blossom Point, Maryland, to Santiago, Chile, with additional stations at San Diego, California, Australia, and South Africa. The data collected by these stations, telemetered from the Vanguard Satellite, were transmitted to NRL's Control Center in Washington. Only the Blossom Point station is shown. This station was also used in NRL's demonstration to prove the feasibility of tracking nonradiating satellites, which led to NRL's development of the existing U.S. Naval Space Surveillance System (WS-434).

from Blossom Point, Maryland, to Santiago, Chile, and other stations at San Diego, California, Australia, and South Africa, which collected the data telemetered from the satellite and transmitted it to the NRL control center in Washington.

NRL placed the satellite, Vanguard-I, into orbit on 17 Mar. 1958.<sup>6</sup> While not the first satellite launched, Vanguard-I reached the greatest distance into space from earth of any manmade vehicle at that time (apogee 2466 miles, perigee 404 miles). Vanguard-I is still in orbit, the longest in orbit of any manmade satellite to date. Its orbit has been particularly stable (present apogee 2120 nautical

miles, perigee 354 nautical miles, period 133.8 minutes, inclination 34.2 degrees, as of July 1973). The Vanguard satellite is a 6.4-inch, 3-1/2-pound sphere which transmitted a signal on 108 MHz until it became silent in May 1964; the duration of its transmission was the longest at that time of any satellite. NRL's Vanguard-I was the first satellite to use solar cells as an electrical power source. These have become commonplace components of modern satellites. Probably the most noteworthy of Vanguard's many major contributions to knowledge was the discovery of the "pear shape" of the earth. Vanguard provided extensive observations and measurements of air-density variations associated with

## SATELLITE ELECTRONICS

### NRL'S VANGUARD-I SATELLITE

This NRL-developed satellite, launched in March 1958, has been the longest in earth orbit of any man-made object. It is still in orbit. With it the "pear shape" of the earth was discovered. It was the first satellite to use solar cells for electrical power; solar cells are now generally used in satellites. Dr. J. P. Hagen, director of the Vanguard project, is shown below holding a model of the satellite. On the right is shown the satellite launching from Cape Canaveral. The satellite-launching facility shown was the first complete facility for launching satellites.

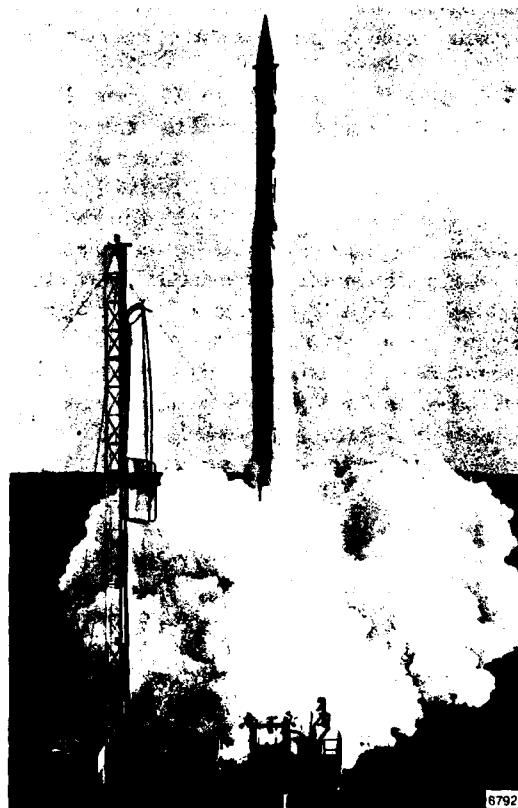

solar activity and the first quantitative data on how solar radiation pressure affects a satellite orbit.

**Vanguard-II, launched on 17 Feb. 1959, was the first satellite designed to observe and record the cloud cover of the earth and was a forerunner of the television infrared observation satellites (TIROS).** It was also the first full-scale Vanguard (20-inch-diameter sphere, 21 pounds) to achieve orbit. Vanguard-III, placed in orbit on 18 Sept. 1959, was a 20-inch sphere weighing 50 pounds. Both Vanguard II and III are still in orbit. The scientific experiments which were flown on the Vanguard satellites increased the amount of scientific knowledge of space and opened the way for more sophisticated experiments.

When the National Aeronautics and Space Administration (NASA) was established on 29 July 1958, the NRL Vanguard group, a total of approximately 200 scientists and engineers became the core of its space-flight activities. The group remained housed at NRL until the new facilities at the Goddard Space Flight Center at Beltsville, Maryland, became available in September 1960.

#### SATELLITE DEVELOPMENT

When NRL's Vanguard staff was transferred to the cognizance of NASA in 1958, sufficient personnel with satellite expertise remained at the Laboratory to establish a satellite-development activity, which grew to substantial size and capability. Through its own satellite-development activity, NRL has developed for scientific and operational purposes 64 satellites (1958-1974). NRL has also provided support in launching these satellites and in the determination of their orbits. Furthermore, it has developed techniques to enhance the operational performance of satellites. **NRL was first to incorporate in a satellite means to extend and retract long antennas for VLF operation. These antennas were first installed in the Lofti-I (1961) and Lofti-II (1963) satellites.**<sup>7</sup> The antenna mechanism

utilized a metal ribbon, wound on a spool, which could be extended and retracted through remote control from a ground station. To provide rigidity when the antenna was extended, the ribbon was prestressed to provide tension, which caused it to curl up to form a tube as it was unwound from the spool.

With the metal ribbon antenna mechanism, **NRL pioneered the gravity-gradient system for stabilizing the attitude of satellites with respect to earth (1964).** This system was widely used in satellites. NRL incorporated this system first in its Gravity Gradient Stabilization Experiment-1 (GGSE-1) satellite, launched 11 Jan. 1964. The stabilizing mechanism comprised a magnetically anchored damper attached to the end of the metal ribbon formed into a tube. When this boom-like device was extended, the mechanical oscillations incurred by the satellite system were gradually stopped by the damper. If the satellite assumed an inverted position with respect to earth, the boom was retracted and again extended when the satellite rotated to the correct position. Satellite GGSE-1 was stabilized in pitch and roll, but not in yaw.

**NRL was first to make satellite orbital "station-keeping" with micropound thrusters feasible.** NRL's system, first used in NRL's satellite GGSE-3, launched 9 Mar. 1965, has subsequently been used in many satellites and space vehicles. The thrusters are electrically heated to provide long-life impulse capability in the use of the ammonia gas supply.

**NRL was first to provide stabilization of a satellite in all three axes—pitch, roll, and yaw.** This system was first used in NRL's satellite GGSE-3. It was used in certain subsequent satellites. While this stabilization system involves the use of three booms, each with a damper, it has the advantage of requiring no electrical power, which would otherwise be needed.

In its first observations of solar radiation with a satellite (Solrad-1), NRL used a spin-stabilized satellite without gyroscopic precession control. Therefore, sensors to determine radiation from the sun would go out of the sun's view due to

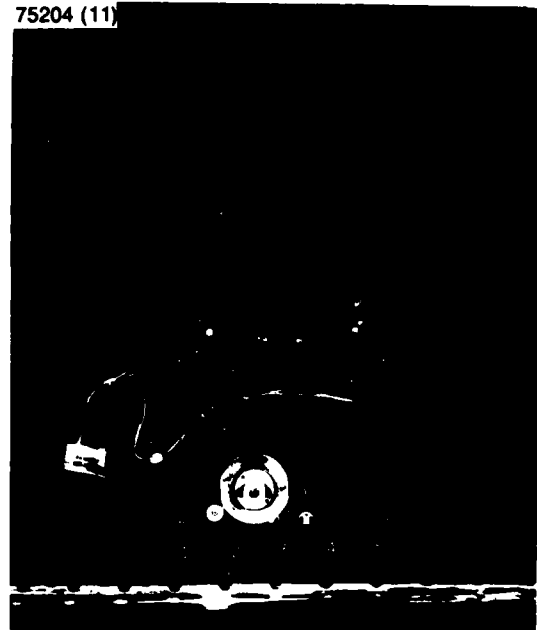
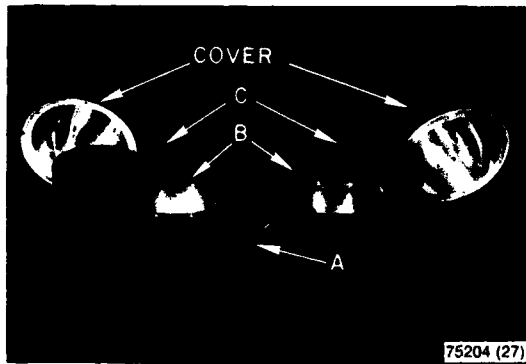

**FIRST GRAVITY-GRADIENT-SATELLITE ATTITUDE-STABILIZATION SYSTEM**

NRL pioneered this first system for stabilizing the attitude of satellites with respect to earth. First incorporated in NRL's satellite GGSE-1, launched 11 Jan. 1964, the system was subsequently used widely in satellites. The mechanism comprises a magnetically anchored damper attached to the end of a boom extending from the satellite. The damper, shown on the left, uses a magnetic element (A) held suspended in a spherical copper shell (B) by means of the diamagnetic shell (C) which magnetically repels element A. Shell C passes the earth's magnetic field so that A, which is free to turn, can align itself with this field. As the satellite and its boom swing, the movement of shell B in the magnetic field of element A induces electrical currents in B, causing corresponding losses which dampen the oscillations of the satellite. The boom is formed by a prestressed beryllium-copper ribbon, which curls up into a rigid tube (pointing upward in the photograph to the right) as it is extended by the mechanism.

precession until the satellite was again in proper viewing position. This lack of precession control severely limited observations time. To increase solar observation time, NRL devised the first satellite gas thrusters, which automatically provided millipound pulses for a fraction of each revolution of the satellite to orient its spin axis so that it was held perpendicular to the sun (1965). Thus, the solar sensor could continue to observe the sun on each rotation of the satellite. The observation time was dependent upon the beamwidth of the sensor. NRL's millipound gas thrusters used ammonia and were first used in the Solrad-8 satellite, launched 19 Nov. 1965.<sup>8</sup> Gas thrusters are used in this type of satellite control.

The advancement of NRL's solar-radiation program required the use of a larger number of solar sensors than could be accommodated with the arrangement previously described. To provide proper viewing of the sun by these sensors, NRL devised a system of precession control which utilized millipound thrusters. This system stabilized a satellite with respect to gyroscopic precession, with the spin axis pointing directly toward the sun (1971). With this system, the solar sensors could be positioned about the satellite so that they would continuously view the sun while the satellite was spinning, except when the path was obscured by the earth. Furthermore, the data from the solar-radiation sensors could be stored and sampled at a rate entirely

## SATELLITE ELECTRONICS

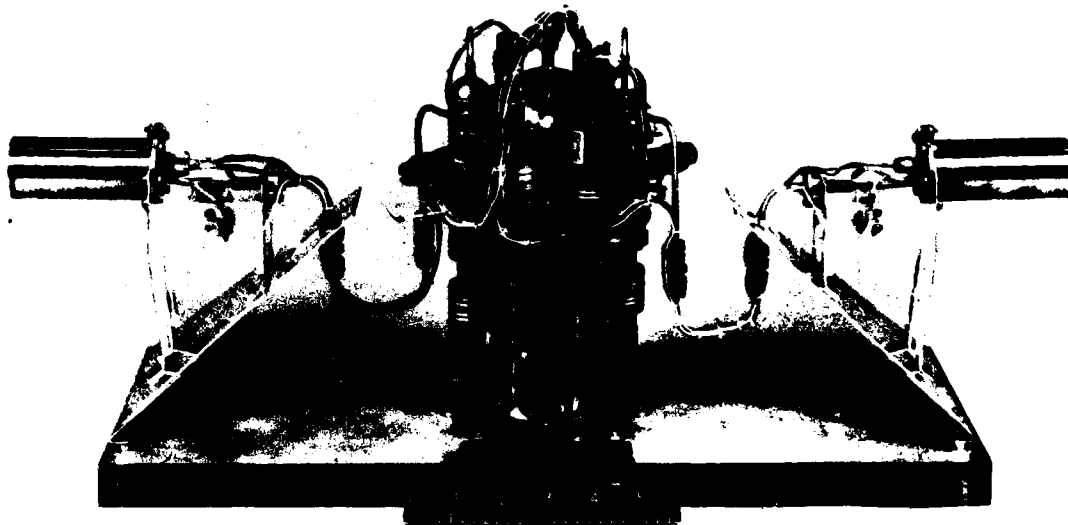

77270 (5)

### FIRST SATELLITE ORBITAL "STATION-KEEPING" WITH MICROPOUND THRUSTERS

NRL was first to make satellite orbital "station-keeping" with micropound thrusters feasible. This system, first incorporated in NRL's satellite GGSE-3, launched 9 Mar. 1965, has been used in many satellites and space vehicles. Shown is an actual size model of the first micropound thrusters with the gas supply containers (center) and two thrusters to right and left.

independent of the satellite spin rate. This system was first used in the Solrad-10 satellite, launched 8 July 1971.<sup>9</sup>

Satellites had previously depended upon real-time telemetry; therefore solar x-ray monitoring and similar types of data collection could be conducted only at those times when the satellite was within range of a telemetry ground station. NRL was first to provide a satellite data system in which information, such as solar-radiation data, is collected and stored in an electronic digital memory during an entire orbit of the earth and is transmitted to a ground station when the satellite is within range of the station (1965). NRL first incorporated this system into its satellite Solrad-8, launched 19 Nov. 1965.<sup>9</sup> NRL's system continues to be used in satellite data collection.

NRL has pioneered in multiple satellite launchings. In 1960, the Laboratory provided

one of the satellites for the first dual satellite launching. In 1961, it provided a satellite for the first trio satellite launching. NRL also developed all the satellites and the support structures to interface with the standard launch vehicles for the first launchings of four satellites at one time with one launch vehicle (1962), five satellites (1963), six satellites (1965), seven satellites (1967), and nine satellites (1969).

NRL was also first to develop a satellite-stabilization system which was stabilized in all three axes—pitch, roll and yaw—using a single boom with damper and a motor-driven rotating flywheel (1969). The energy required to drive the motor is so low that it is easily supplied by the solar cells of the satellite. This system of stabilization has seen considerable use. It was first used in an NRL satellite launched 30 Sept. 1969.

## SOLRAD

During NRL's early investigations of the propagation of high-frequency transmissions via the ionosphere, reviewed in Chapter 3, it was evident that radiations from the sun had major influence on the ionosphere's radio-transmission characteristics. Knowledge of these characteristics, particularly those which attend serious transmission disturbances, were essential to the operational reliability of radio communication and other over-the-horizon electronic systems. Such knowledge permits predictions of usable frequency channels relative to time of day and distance and forewarning of radio circuit blackouts. NRL's early theoretical considerations indicated that the sun's ultraviolet radiation produced electron and ion densities in the upper atmosphere which were in agreement with the densities inferred from experimentally acquired propagation data (1928).<sup>10</sup> Further considerations indicated that the x-ray component of the solar radiation was a major factor in the ionization process occurring in the ionosphere (1938).<sup>11</sup> It was thought that the generation of x-ray radiation in solar flares was responsible for radio transmissions suddenly being disrupted. However, no experimental data on radiations from the sun to confirm the cause of the phenomena were available, since the pertinent radiations were absorbed in the earth's atmosphere. Thus measurements had to be made at high altitude.

It was not until the German V-2 rockets became available that experimental data could be obtained. These rockets made it possible for NRL to initiate an extensive program to determine the nature and effects of radiation from the sun, particularly its impact on radio communication (Solrad).<sup>3</sup> NRL used the V-2 rockets to make first observations of the far-ultraviolet spectrum of the sun (1946).<sup>12,12a</sup> In its subsequent rocket research, NRL discovered solar x-ray emission and its role in the production of the ionosphere (1948).<sup>12b</sup> The Laboratory made the first direct observation of solar Lyman-Alpha radiation and its influence on the ionospheric D-region (1949).<sup>12c</sup> It also made the first

measurement of ultraviolet and x-ray emission during a solar flare. NRL discovered that x-ray emission, rather than ultraviolet, is the variable solar component which causes radio fadeout (1956).<sup>12d</sup>

While rockets served to provide solar-radiation data to determine its effects on the transmission characteristics of the ionosphere, the transient nature of this method of collecting data made it impractical to provide the continuous solar observations needed to serve Naval requirements. Satellites possessed this potential. When satellites became available, NRL developed the first satellite, Solrad-1, incorporating observation equipment which first successfully monitored solar x-ray and Lyman-Alpha radiation (June 1960).<sup>12e</sup>

Since the Solrad-1 satellite was launched, NRL has developed and successfully placed into orbit a total of eight Solrad satellites. These satellites have incorporated successively improved means of satellite solar orientation, data collection, and means to transmit these data to NRL's ground data collection site. The improved stabilization and data-collection instrumentation of these satellites provided data of successively greater wavelength range and dynamic sensitivity range, making possible more extensive and thorough analysis of solar radiation for operational use. Solrad-10, launched 8 July 1971, is still in orbit, and is still providing useful operation data.<sup>13</sup>

NRL was first to use a single-channel photomultiplier for recording extreme ultraviolet radiation from the sun and for imaging the sun from a satellite (1965).<sup>12f</sup> NRL's photomultiplier equipment was installed in the NASA satellite OSO-2 for this work. NRL also used television for the first time to observe solar radiation from a satellite (1971).<sup>14</sup> This equipment was first installed in the NASA satellite OSO-7. This work was followed by NRL's "XUV monitor," which, operating in Skylab, produced, by TV images of the sun, data in the extreme ultraviolet. Images of the sun in x-rays and extreme ultraviolet are important, because they show that these emissions arise from highly localized



## SATELLITE ELECTRONICS

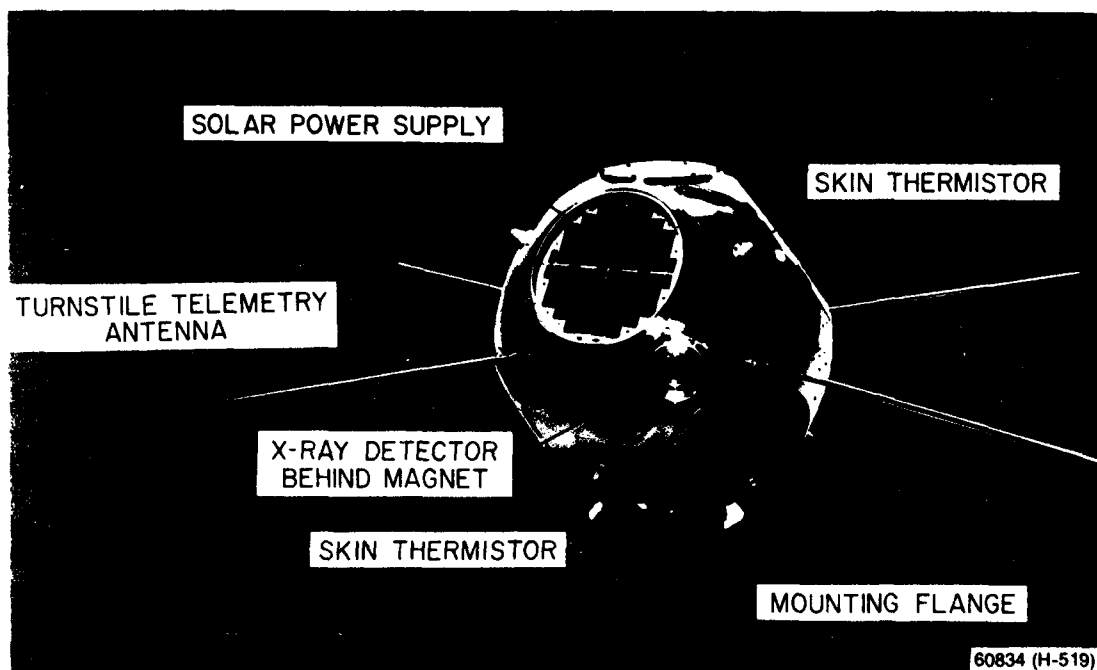

**SOLRAD-1 SATELLITE (1960) – FIRST SUCCESSFUL MONITORING OF SOLAR X-RAY AND LYMAN-ALPHA RADIATION BY A SATELLITE**

Since the NRL-developed satellite Solrad-1 was launched, NRL has developed and placed in orbit a total of eight Solrad Satellites with successively advanced means of orientation toward the sun, solar-radiation data collection, and data transmission to earth. The data are processed, converted into operationally useful message formats, and transmitted to many users concerned with radio communication and other solar-forecast functions.

regions, which are related to solar flare production and to earth ionospheric disturbances. While this fact was known from NRL's earlier photographic work with rockets, only with photoelectric detection and TV transmission from a satellite could the changing character of the sun be studied from day to day.

NRL's Solrad work is recognized by the Navy and by the Department of Defense as an example of space science effort which has genuine operational utility. Unlike other satellites that have multipurpose space functions, Solrad's principal mission is to monitor all aspects of the sun's activity. Telemetered data from the satellite are received at the NRL Tracking and Data Acquisition Facility at

Blossom Point, Maryland, where they are relayed by dataphone to the Solrad Data Operations Center at NRL's main site in Washington. The telemetry data are then converted into operationally useful message formats and transmitted to many users. For example, Naval Communications Command has utilized the data in formulations of Naval alerts to all communicators. Outside the Navy, Solrad data are furnished on a routine basis to the Environmental Services Space Disturbance Forecast Center at Boulder, Colorado, and the U.S. Air Force Air Weather Service.<sup>18</sup>

NRL has underway the development of two Solrad monitoring satellites, Solrad-11A and 11B, for future placement in a 65,000-nautical-mile

## SATELLITE ELECTRONICS

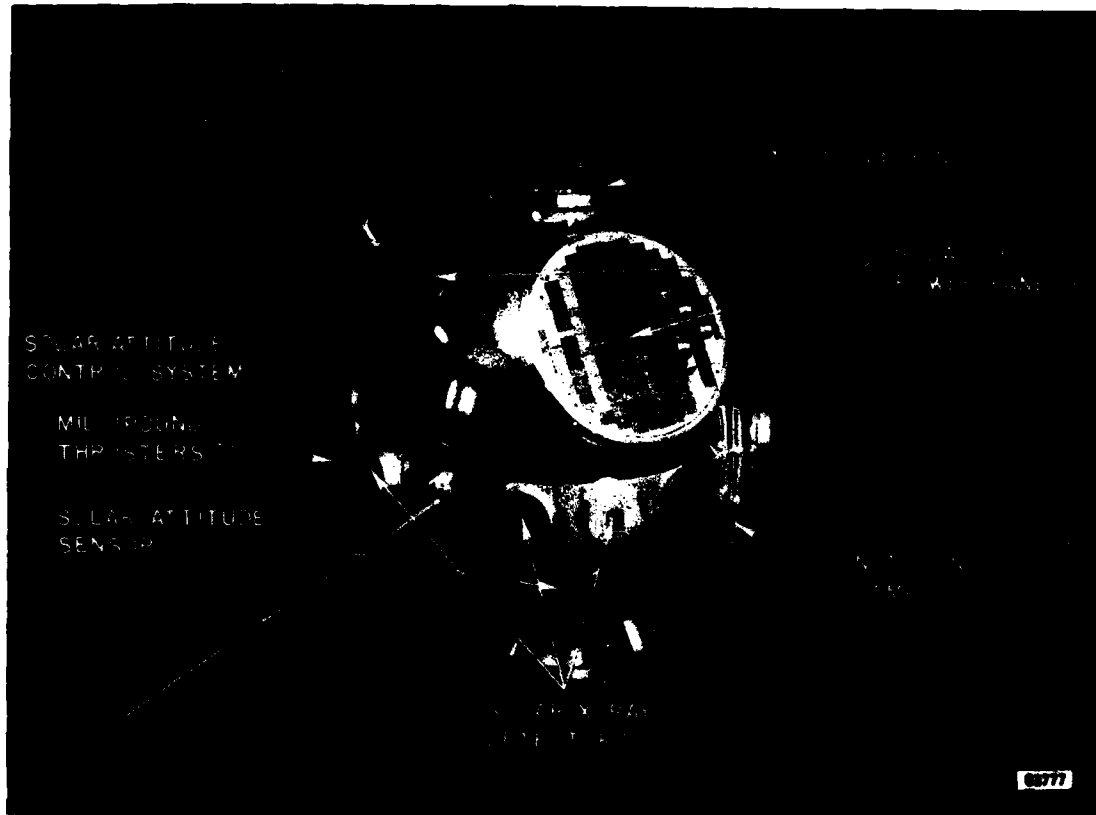

**SOLRAD-8 SATELLITE**

Two unique features, first devised by NRL, were embodied in the Solrad-8 satellite (1965). One feature involved the first *gas thrusters* which automatically provided millipound pulses for a fraction of each revolution of the satellite, to orient its spin axis. This feature allowed Solrad-8 to maintain an orientation with respect to the sun such that its radiation could be observed without considerable loss in observation time due to precession of the satellite. Ammonia gas was used. Another feature was the first satellite data system with which information, such as solar-radiation data, is collected and stored in an electronic digital memory during an entire orbit of the earth and transmitted to a ground station, when the satellite is within range of the station. Both features, the gas thrusters and the data-collection system, continue to be used in modern satellites.

## SATELLITE ELECTRONICS

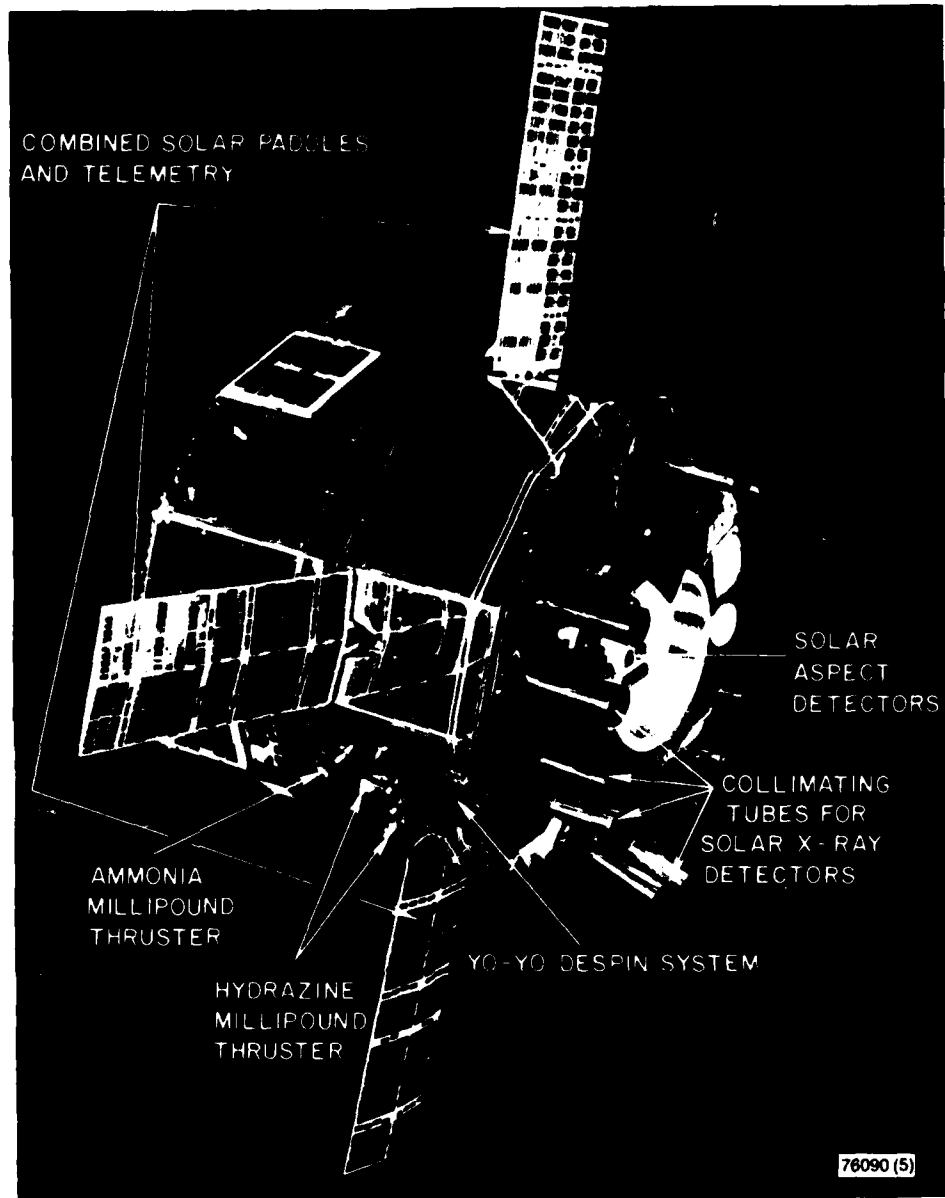

### SOLRAD-10 SATELLITE

This satellite was an advance over satellites Solrad-8 and Solrad-9, since its spin axis points directly at the sun instead of in a direction perpendicular to it. This improvement allows continuous viewing of the sun by several solar sensors. Furthermore, the data from these sensors can be stored and sampled at a rate entirely independent of the satellite spin rate. It also makes possible continuous viewing by solar power cells, which provide three times the electric power previously available. Solrad-10, launched 8 July 1971, is still in orbit and providing useful solar radiation operational data.

orbit. At this altitude, continuous coverage of solar activity will make real-time continuous acquisition and transmission of solar data to the single existing ground station with daily solar forecasts a reality.

#### TIMATION SATELLITE

By 1964, the accuracy of electronic time-keeping devices had advanced to such a degree that the range between two objects could be measured by radio transmissions from one to the other with an accuracy acceptable for operational navigation purposes. By using stable timepieces at each location, the time that a signal is received could be compared to the known time it was sent to obtain the transit time. The distance between the objects could then be obtained from the transit time and the velocity of propagation of radio waves. If a stable timing device is located in a satellite, and if another is located at a navigator's position on the surface of the earth, the constant-distance sphere centered at the satellite cuts the earth's surface on a circle through the navigator's position. If the satellite moves to a new position, or if two satellites are in view, the earth's surface is cut by two circles, which provide two possible fixes. Since these fixes are a great distance apart, no problem exists in resolving ambiguity to obtain the correct position. Furthermore, by modulating the satellite transmissions, controlled by its precise timing source, precise time epoch and time interval can be made available at locations on the earth's surface.

NRL was first to demonstrate the feasibility of a satellite navigation system using radio transmission transit time to obtain positions on the earth's surface. It was also first to provide a high-precision clock in a satellite which made available both time epoch and time interval at points on the surface of the earth. This was successfully accomplished with NRL's Timation satellite, launched on 31 May 1967, transmitting at 400 MHz.<sup>16</sup> To provide the necessary high precision of frequency and time, an oscillator with a temperature-controlled, fifth-overtone, 5-MHz AT-cut quartz crystal was

employed in the satellite. This crystal oscillator had a stability of one part in  $10^{11}$  per day. During investigations of the frequency stability of the oscillator in orbit, NRL was first to observe that a change in frequency of a quartz crystal occurs when it is subjected to high-energy proton radiation, present in the radiation belt around the earth (1968).<sup>17</sup> This effect, which lowers the frequency as compared with the increase in frequency normally occurring with crystal aging, was confirmed through laboratory investigations. In the satellite system, these frequency changes are compensated for through the use of remote control of the oscillator circuit from ground.

For navigation, the Timation satellite system has an accuracy adequate for Naval operational purposes. For transfer of time epoch and time interval from one earth position to another, the accuracy is better than one microsecond.

NRL's research has demonstrated that it is feasible to obtain position-fixing accuracies measured in tens of feet or better in a satellite navigation system.<sup>18</sup> The Laboratory, seeking to provide a capability to meet the requirements of the several military services of the Department of Defense in a single satellite navigation-time system, is currently developing another Timation satellite, which is scheduled for launching in the near future.

#### U.S. NAVAL SPACE SURVEILLANCE SYSTEM (WS-434)

By 1958, it became apparent that in the future the United States would have to contend with large numbers of earth-orbiting satellites, its own and those launched by other nations as well, and that a system of detecting, tracking, and classifying these satellites would have to be devised. Moreover, space would become cluttered with parts of launching vehicles and other space debris, which also would have to be identified and followed. Knowledge of the existence and position of orbiting objects would be necessary if the requirements of national security and the

## SATELLITE ELECTRONICS

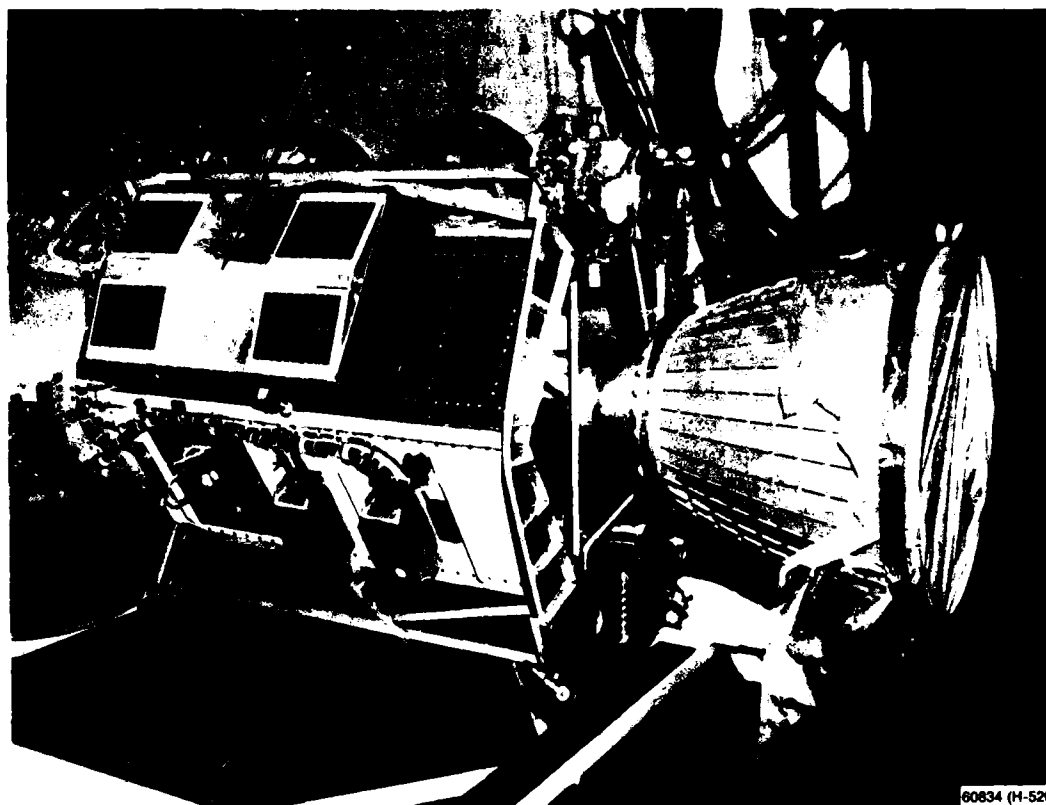

TIMATION SATELLITE

With this satellite, launched 31 May 1967, NRL was first to demonstrate the feasibility of a satellite navigation system using radio transmission transit time to obtain positions on the earth's surface. This satellite also was first to provide a high-precision clock in a satellite which made available both time epoch and time interval at points on the surface of the earth. The satellite is shown mounted on the side of its launching vehicle.

placement of future satellites and space vehicles in proper noninterfering orbits and other needs were to be satisfactorily met. Many satellites and the space debris would be nonradiating, so a system, such as NRL's Minitrack system, requiring radiation from objects tracked, would not suffice.

NRL was first to demonstrate the feasibility of a detection and tracking system for earth-orbiting nonradiating satellites (1958).<sup>19</sup> The system utilized a ground-located, continuous-wave transmitter to illuminate the orbiting object and NRL's Vanguard Minitrack Tracking Station,

Blossom Point, Maryland, for reception. The signals reflected by the Russian satellite Sputnik (1957 Beta) were the first observed by the system. The transmitter (50 kW, 108 MHz), operating into a 50-foot parabolic antenna and located at Fort Monmouth, New Jersey, was provided by the Army Signal Corps Engineering Laboratories. Based on the results obtained from this work, the Laboratory proposed a satellite-surveillance system for the United States.

NRL was responsible for the development of the world's first system to detect and track all types of earth-orbiting satellites, space

## SATELLITE ELECTRONICS

vehicles, and other orbital objects (1958). In view of the satisfactory results it obtained in its experimental satellite observations and its experience with the Minitrack system, NRL was requested by the Advanced Research Project Agency (ARPA) of the Department of Defense on 20 June, 1958, to develop and operate this space-surveillance system for the United States.<sup>20</sup> Many of the principles and techniques devised by NRL for the Minitrack system were embodied in the new system.

The system as it evolved at first comprised an eastern complex and western complex, and eventually a midcontinental transmitter. All these are located on a great circle at 33.5 degrees north, passing across the southern part of the country from Georgia to California. Each complex includes a centrally located transmitter site and receiver sites approximately 250 miles to the east and west of the transmitter site. The transmitter sites are located at Jordan Lake, Alabama; Kickapoo Lake, Texas; and Gila River, Arizona. The



U.S. SPACE SURVEILLANCE SYSTEM (SPASUR)

This system, developed by NRL as an outgrowth of the Vanguard Program, spans the continent on a great circle at 33.5° north. It is the U.S. system for the detection and tracking of all types of earth-orbiting satellites and debris. Shown is the station at Ft. Stewart, Mississippi, one of the receiving stations of the eastern complex of the system which became operational 29 July 1958. The sharp vertical beam antennas mounted on the ground are seen as rectangular shaped objects. The related transmitting station is at Jordan Lake, Alabama.

Kickapoo Lake transmitter spans the United States for all space objects of sufficient altitude. The other two transmitters cover the very low altitudes. The receiver sites are located at Ft. Stewart, Georgia; Hawkinsville, Georgia; Silver Lake, Mississippi; Red River, Arkansas; Elephant Butte, New Mexico; and San Diego, California. The transmitters are of the continuous-wave type, with 50 kW power output capability for the Jordan Lake and Gila River installations and 1 MW for the Kickapoo Lake installation. The transmitting antennas are of the fan type, with coplanar antenna beams, wide in the east-west plane and very narrow in the north-south plane. The Jordan Lake and Gila River antennas are respectively 1100 feet and 1200 feet long, whereas the antenna at Kickapoo Lake, the central, high-power site, extends a distance of two miles. This long antenna at the Kickapoo Lake site has a north-south beamwidth of 1.5 minutes and an east-west beamwidth of 120 degrees. It produces the extraordinarily high effective radiated beam power of 13.6 billion watts. The antenna beam of the Kickapoo Lake station overlaps the beams of the other two transmitting station antennas, to provide complete east-west continental coverage. The receiving sites have two sets of antennas, with fan-type coplanar beams, and extend from 1200 to 4800 feet in length. One set provides an alert, detecting the presence of a satellite slightly before it comes within range of the second set. The second set of antennas provides for the determination of the look-angle of the satellite with respect to the zenith and its height through phase-difference measurements and interstation triangulation.

In operation, the transmitters of the system illuminate the satellites and other objects, and the reflected radio-frequency signals detected at each receiving site are processed in a radio-interferometer system to produce phase-modulated carriers. The radio interferometer utilized in the system measures the angular position of the radio signal source by measuring the difference in radio signal path lengths from the objects reflecting the signal to each of a number of paired antennas. The large amounts of data ob-

tained from the several receiving stations of the system have made necessary the transfer of this information via land line to a central processing site. The information to be sent consists of interferometer phase channels, analog data, and administrative functions. Since most of the data to be transferred comprises phase information, phase-modulation transmission to duplicate the primary data at the central processing site is used. The telemetry which has evolved is a frequency-division multiplex system comprising phase-modulated and reference subcarriers. Information signals phase modulate the data subcarriers with respect to the reference subcarriers. Correlation techniques are used at the central processing site both to derive a reference time base phase locked to the remote sites and to retrieve the information signals. The data-processing and control center is located at Dahlgren, Virginia, where an IBM 7090 computer computes the longitudinal position and altitude of objects as they pass through the "fence."

The first portion of the system, involving the stations at Fort Stewart and Jordan Lake, was placed into operation on 29 July 1958, less than six weeks after NRL was designated by ARPA to proceed with the system. The Silver Lake station became operational in November 1958, and the Western Complex in February 1959. The high-power, central transmitting station at Kickapoo Lake was placed into operation in June 1961. The system was first operated on 108 MHz, the same frequency used for the Minitrack system. Since this was only a temporary frequency assignment, the system was changed over to the permanently assigned frequency of 216 MHz during the period 1965 to 1967.

After completing the development of the Space Surveillance System (WS-434), NRL was responsible for its operation. The Laboratory was relieved of this responsibility when the Secretary of the Navy established the U.S. Naval Space Surveillance Facility (NAVSPASUR) at Dahlgren, Virginia, on 19 Apr. 1960.<sup>21</sup> However, the Laboratory has continued to provide scientific improvements to the system.<sup>22</sup>

## SATELLITE ELECTRONICS



### U.S. NAVAL SURVEILLANCE SYSTEM (WS-430) KICKAPOO LAKE, TEXAS TRANSMITTER

This system, developed by NRI, has this high beam power transmitter (150 billion watts) which spans the United States for the observation of orbital space objects at all altitudes except the very low, which are covered by lower powered transmitters at Jordan Lake, Alabama, and Gila River, Arizona. The beam antenna is two miles long and provides a very sharp north-south beamwidth (1.5 minutes) for precise look angle determination of orbiting objects.



## SATELLITE ELECTRONICS



NAVSPASUR OPERATION CENTER DATA RECORDING AREA, DAHLGREN, VIRGINIA

The NRL-developed U.S. Space Surveillance System (SPASUR, WS-434) included the data-recording equipment located at the Navspasur Operations Center, Dahlgren, Virginia, as shown above. This system detects and tracks all types of earth-orbiting satellites, space vehicles, and other orbital objects. The receivers of the data from the four tracking stations are shown in the background. The operators concerned with processing of the data are seen at their consoles in the foreground. A completely automatic data-assembly system involving an electronic computer was developed and installed later by NRL. NRL was responsible for the development and operation of the complete NAVSPUR system, including the equipment shown, until 19 April 1960, when it was relieved of its responsibility for the operation of the system with the establishment of the "U.S. Naval Space Surveillance Facility (NAVSPASUR)" at Dahlgren, Virginia, by the Secretary of the Navy. However, NRL has continued to provide scientific improvements to the system.

The WS-434 served an important function in the North American Air Defense Command's Space Detection and Tracking System known as SPADATS.

WS-434 makes over 600,000 single-station observations per month on over 1900 different earth-orbiting objects, of which 500 are pay-

loads and 1400 are last-stage rockets and miscellaneous debris. A total of 6800 earth-orbiting objects have been cataloged by NAVSPASUR and other space-surveillance sensors since the advent of the Russian satellite Sputnik-I in 1957.

For certain scientific work, the orbital-accuracy

requirements are much higher than that needed for cataloging. NRL has been acting as an intermediary to furnish high-accuracy data on orbital elements to world scientists needed in their specialized investigations.

REFERENCES

1. Alfred Rosenthal, "Venture Into Space," NASA SP-4301, U.S. Government Printing Office, 1968, Washington, D.C.; NRL Library 629.1380973.R815
2. J. W. Townsend, Jr., H. Friedman, and R. Tousey, "Upper-Atmosphere Research Report No. XXXII, History of the Upper-Air Rocket Research Program at the Naval Research Laboratory, 1946-1957," NRL Report 5087, Feb. 1958
3. M. Rosen, "The Viking Rocket Story," New York, Harper, 1955; NRL Library 629.138.R813
4. O. E. Berg, "High-Altitude Portrait of Storm Clouds," ONR Research Reviews, Sept. 1955, pp. 12-18
5. J. T. Mengel, "Tracking the Earth Satellite and Data Transmission by Radio," IRE, June 1956, pp. 755-760
6. K. R. Stehling, "Project Vanguard," Doubleday and Co., Garden City, N.Y., 1961; NRL Library 359.0072S817 Ref
  - C.M. Green and M. Lomask, "Vanguard, A History," NASA SP-4202, Government Printing Office, 1970, Washington, D.C.; NRL Library 359.0072.G795
  - J.P. Hagen, "Vanguard-The Laboratory Ventures Into Space," Report of NRL Progress, July 1973, pp. 30-32
  - M. W. Rosen, "The Pre-Vanguard Era at NRL," Report of NRL Progress, July 1973, pp. 49-51
  - J.P. Hagen, "The Exploration of Outer Space with an Earth Satellite," IRE, June 1956, pp. 744-747
  - D. G. Mazur, "Telemetry and Propagation Problems of Placing the Earth Satellite in its Orbit," IRE, June 1956, pp. 752-754
  - M. W. Rosen, "Placing the Satellite in Orbit," IRE, June 1956, pp. 748-751
7. (See Chapter 3, Ref. 286)
8. D. M. Horan, R. W. Kreplin, A. T. McClinton, and L. C. Schneider, "Using Solar X-Rays as Indicators of Solar-Flare Activity," NRL Report 6884, Mar. 1969
9. D. M. Horan and R. W. Kreplin, "The Solrad 10 Satellite, Explorer 44, 1971-058A," NRL Report 7408, July 1972
10. A. Hoyt Taylor and E. O. Hulburt, "Wave Propagation Phenomena at High Frequencies," NRSR, Sept. 1925, pp. 42-59
  - E. O. Hulburt, "Ionization in the Upper Atmosphere of the Earth," Phys. Rev., June 1928, pp. 1018-1037
11. E. O. Hulburt, "Photoelectric Ionization in the Ionosphere," Phys. Rev., Mar. 1938, pp. 344-351
12. R. Tousey, "Highlights of Twenty Years of Optical Space Research," Apl. Opt., Vol. 6, Dec. 1967, pp. 2044-2077; see the following references in Tousey:
  - a. Ref. 2
  - b. Refs. 53, 54
  - c. Refs. 21, 54
  - d. Ref. 56
  - e. Refs. 58, 59
  - f. Refs. 34, 64, 68
13. R. W. Kreplin and D. W. Horan, "The NRL Solrad 9 Satellite Solar Explorer B 1968-17A," NRL Report 6800, Mar. 1969
14. G. E. Bruckner, "Digitized Sec-Vidicon System for Satellite Coronagraph," Space Applications of Camera Tube, International Colloquium, Paris, 23-25 Nov. 1971; published by Center National D'etudes Spatiales, CNS, pp. 105-120
15. O'Connor, N. F., "Solrad in Space and the United States Navy" issue, Naval Aviation News, Nov. 1970, pp. 50-51
16. R. L. Easton, "The Timation-1 Satellites," NRL Report 6781, Nov. 1968
17. R. L. Easton, C. A. Bartholomew, R. R. Wenzel, and R. Carson, "Radiation Effects on Satellite Crystal Oscillators," NRL Report 7368, Feb. 1972
18. P. J. Klass, "Compromise Reached on NAVSAT," Aviation Week and Space Technology, 26 Nov. 1973, pp. 46, 47, 49, 51
19. "Space Surveillance System, Technical Summary Report No. 1," NRL Memo. Report 896, Dec. 1958
20. C. E. Cleeton and W. E. Berg, "The Space Surveillance System," NRL Report 5419, Oct. 1959
  - M. G. Kaufman and F. X. Downey, "Data Transmission for the NRL Space Surveillance System," NRL Report 5522, Aug. 1960
  - C. E. Cleeton, "The Space Surveillance System - A Summary Report," NRL Report 5575, Oct. 1960
  - "Space Surveillance System, Technical Summary Report No. 2," NRL Memo. Rept. 954, June 1959
  - "Space Surveillance System, Technical Summary Report No. 3," NRL Memo. Rept. 1025, Dec. 1959
  - R. L. Easton and J. J. Fleming, "The Navy Space Surveillance System," IRE, Apr. 1960, pp. 663-669
  - P. J. Klass, "Navy Improves Accuracy, Detection Range of Space Surveillance Chain," Aviation Week and Space Technology, 16 Aug. 1965, pp. 56-61
21. "Space Surveillance System, Technical Summary Report No. 4," NRL Memo. Rept. 1078, June 1960
22. R. R. Zirm, "Optimization of Range Capability in the U.S. Navy Space Surveillance System," NRL Report 5621, Aug. 1961
  - R. Brescia, D. Ballou, and R. Zirm, "Decay Prediction of 1963-21 Using U.S. Naval Space Surveillance System Observations," NRL Report 6049, Mar. 1964

## Index

- A4D-2N aircraft, 240-241
- ABA IFF system, 253
- ABK transponder, 253, 255
- ACHERNAR, USS, 109-110
- Acoustic treatment, 24
- Adak, Alaska, 137-138
- Adams, Charles Francis, 34
- ADCON (analog-digital), 384-386
- ADIRONDACK, USS, 104
- Admiralty Signal Establishment, 104
- Advanced Research Projects Agency, 125, 409-410
- Aerial targets, maneuverable, 228
- Aerial torpedo concept, 236
- AEW-interceptor data link AN/USC-2, 390
- AFAX code generator, 75
- Agriculture, Department of, 123
- AIA radar, 204
- Air traffic control, 258
- Air Traffic Control Radar Beacon System, 258
- Airborne radar systems, 113, 201-203, 204-205
- Airborne Tactical Data System, 211, 386-391
- Air-cooled radio vacuum tubes, 55
- Air defense
  - IFF in, 379-381
  - radar in, 198
  - systems integration, 379-381
- Air density, measuring, 398
- Air search by radar, 188-189
- Airborne early warning (AEW) systems
  - airship as platform, 209
  - electronics in, 379-381, 383-390,
  - radar in, 195, 206-212, 315-316, 379-381, 387-390
- Airborne microwave radar, 203, 204, 209, 315
- Airborne Omega system, 287-290
- Airborne Tactical Data System (ATDS), 386-390
- Airborne VLF transmission, 142
- Airborne weapon systems, radar in, 205-206
- Aircraft
  - AKRON, USS, 276
  - automatic navigator, 276-279, 318-320
  - B-29, 205
  - BG-1, 299
  - C-54, 289-294
  - Convair, 237
  - Culver Cadet, 228
  - D1, 230
  - detection by radar, 171-179, 186-188, 191-193, 204, 215-216
  - DH-4B, 63
  - E1B, 209
  - E-2A(W2F-1), 209-211, 389-390
  - E2B, 212, 390
  - E2C, 218, 390-391
  - EA-6, 333-335
  - EC-121, 286-287, 290
  - F2H, 205
  - F3D, 205, 237, 280-281
  - F3H, 205
  - F4B, 228, 389
  - F4C, 206
  - F4D, 205-206
  - F4G, 388
  - F4H, 205-206, 388
  - F4J, 205
  - F4U, 201
  - F5L, 25, 223, 268, 270
  - F6F, 204, 228, 237-239, 279
  - F8E, 205
  - F8F, 205
  - F8J, 205
  - F8U, 205
  - F14, 206-207
  - F-111, 206
  - Ferret, 315-316
  - FJ-4B, 240
  - first radar detection, 171-176, 179, 188
  - first radio detection, 171-172
  - first satellite communication in, 126
  - H-16, 268
  - HSS-1 helicopter, 337
  - intercept systems, 315-316, 388-389, 391
  - types, 203
  - KC-135, 290
  - N2C2 drones, 228-231
  - N-9, 225-226
  - NC-4, 24, 268-269
  - O2U, 228
  - P3A, 213
  - P4M, 315
  - PB, 209
  - PB4Y, 232
  - PBY, 201, 203, 268, 271
  - PDM, 268, 271
  - PN-9, 268
  - PV-1, 203, 232
  - Q2C, 243
  - R4D, 317
  - radar in direction, 191-193
  - radio direction finders, 17-18, 25, 267-271

## INDEX

- SB2C**, 203  
**SC**, 204  
**SHENANDOAH**, USS, 46, 49, 59  
**SNB**, 237, 240  
**TBF**, 201, 203, 272  
**TBM**, 202, 204, 208  
**TDC**, 228  
**TDR**, 232  
**TG-2**, 228-229  
**TU-2**, 227  
 vectoring systems, 388-390  
**W2F-1 (E-2A)**, 209-211, 389-390  
**Wright B-1**, 17  
**WV**, 139-140, 209  
**ZPG** airship, 209-210
- Aircraft-vs.-battleship controversy**, 223-224  
**Aircraft navigators**,  
   **AN/APN-67**, 276  
   **AN/APN-99**, 290  
   **AN/APN-122**, 278  
   **AN/APN-153**, 279  
   **AN/APN-187**, 279  
   **AN/APN-190**, 279  
   **AN/APN-200**, 279  
**Aircraft radio communications**  
   first two-way, 24-25  
   first UHF system, 100-101  
   naval operations, importance in, 17  
**Aircraft radio equipment**  
   early development, 16-18, 21-25  
   first effective system, 25  
   first UHF system, 101-102  
   first VHF system, 98-99  
   HF development, 63-67  
   problems in, solving, 24-25, 37-38  
   shielding measures, 25  
**Aircraft receivers**, 58-59  
   **CW1058**, 14  
**Aircraft Radio Corporation**, 67  
**Aircraft ranging, first by radar**, 172-175  
**Aircraft target identification**. *See* Identification, friend-foe  
**Air-ground communications**, 25  
**Airlines, commercial**, 290  
**Air-sea rescue**, 113-114  
**Air-search systems, radar in**, 189  
**Airships, as AEW platforms**, 209. *See also* Aircraft  
**Airspace, avoiding violation**, 94  
**AKRON**, USS, 276  
**Alaska area**, 91, 139, 145, 286, 288  
**ALBEMARLE**, USS, 183  
**Alberporrh, Scotland**, 246  
**Aldra, Norway**, 284  
**Aleutian Islands**, 203, 260, 282, 305  
**Alexanderson, E. F. W.**, 11  
**Alexandria, Va.**, 171  
**Alidade, mechanical**, 312  
**All-Weather Carrier Landing System**, 280  
**Alternating-current powered receivers**, 156  
**Alternator, HF transmitter**, 10-11
- Altimeters**  
   **AN/APN-141**, 276  
   **AN/APN-171**, 276  
   **AN/APN-194**, 276  
   designs, 274-276  
**Altitude determination**, 274-276  
**Amateur operators**, 44. *See also* American Radio Relay League  
**AMERICA**, USS, 211  
**American Marconi Company**, 11  
**American Radio Relay League**, 22. *See also* Amateur operators  
**American Telephone & Telegraph Company**, 13, 15  
**Ammunition, hazards to**, 55  
**Amphibious operations**, 96-97, 100, 188, 260, 274-275  
**Amplifier circuit, doubling and tripling**, 53  
**Amplifiers**  
   master oscillator-power, 49  
   radio-frequency tube, 19  
   **SE1605**, 19  
   **SE1615**, 19  
**Anacostia Naval Air Station**, 21, 68-69, 169  
**Anacostia River area**, 169  
**Anacostia River area**, 171  
**AN/ALE-29** chaff dispenser, 339-340  
**Analog-to-digital converters**, 384-386  
**Analog techniques**, 384  
**AN/ALQ-H(X)** pulse repeater, 336-337  
**AN/ALQ-19** pulse repeater, 337  
**AN/ALQ-23** jammer, 332-333  
**AN/ALQ-49** pulse repeater, 337  
**AN/ALQ-51** pulse repeater, 337  
**AN/ALQ-76** jammer, 333-334  
**AN/ALQ-100** pulse repeater, 337  
**AN/ALQ-126** pulse repeater, 337  
**AN/ALT-2** jammer, 330, 332  
**AN/ALT-19** jammer, 333  
**AN/ALT-21** jammer, 333  
**AN/ALT-27** jammer, 333  
**Analyzers, statistical**, 76  
**AN/APA-24x(XB-1)** direction finder, 315  
**AN/APA-24x(XB-2)** direction finder, 315  
**AN/APA-24x(XB-3)** direction finder, 315  
**AN/APA-74** signal analyzer, 325-326  
**AN/APG-25** radar, 198  
**AN/APG-26** radar, 198, 205  
**AN/APG-35** radar, 198  
**AN/APG-49** radar, 205  
**AN/APG-51** radar, 198  
**AN/APG-59** radar, 205  
**AN/APN-7** transponder beacon, 253  
**AN/APN-13** beacon, 260  
**AN/APN-41** radar beacon, 241  
**AN/APN-67** aircraft navigator, 276  
**AN/APN-99** aircraft navigator, 290  
**AN/APN-122** aircraft navigator, 278  
**AN/APN-141** altimeter, 276  
**AN/APN-153** aircraft navigator, 279  
**AN/APN-171** altimeter, 276  
**AN/APN-187** aircraft navigator, 279  
**AN/APN-190** aircraft navigator, 279

## INDEX

- AN/APN-194 altimeter, 276  
 AN/APN-200 aircraft navigator, 279  
 AN/APQ-33(XB) jammer, 333  
 AN/APQ-35 radar, 198, 205  
 AN/APQ-36 radar, 198, 205  
 AN/APQ-41 radar, 198  
 AN/APQ-42 radar, 198  
 AN/APQ-43 radar, 198  
 AN/APQ-47 radar, 198  
 AN/APQ-50 radar, 198, 205-206  
 AN/APQ-51 radar, 205  
 AN/APQ-59 radar, 198  
 AN/APQ-72 radar, 198, 205-206  
 AN/APQ-83 radar, 205  
 AN/APQ-94 radar, 205  
 AN/APQ-100 radar, 198, 206  
 AN/APQ-124 radar, 205  
 AN/APS-2 radar, 203  
 AN/APS-3 radar, 203  
 AN/APS-4 radar, 203-205  
 AN/APS-6 radar, 204-205  
 AN/APS-17 radar, 209  
 AN/APS-18 airborne radar-link transmitter, 208, 232  
 AN/APS-19 radar, 205  
 AN/APS-20 radar-link system, 208, 212  
 AN/APS-20B radar, 209  
 AN/APS-20E radar, 209  
 AN/APS-21 radar, 205  
 AN/APS-25 radar, 198  
 AN/APS-28 radar, 198, 205  
 AN/APS-38 radar, 212  
 AN/APS-44 radar, 212  
 AN/APS-67 radar, 198, 205  
 AN/APS-70 radar, 209-210  
 AN/APS-80 radar, 212-213  
 AN/APS-82 radar, 209  
 AN/APS-87 radar, 209  
 AN/APS-96 radar, 209-212, 391  
 AN/APS-111 radar, 212  
 AN/APS-116 radar, 212  
 AN/APS-120 radar, 212  
 AN/APW-4 guidance receiver, 238  
 AN/APW-19 command-guidance system, 243  
 AN/APW-33 radar beacon, 241  
 AN/APX-1 transponder, 255  
 AN/APX-6 transponder, 256  
 AN/ARC-1 transceiver, 98-99  
 AN/ARC-13 transceiver, 104  
 AN/ARC-19 transceiver, 101-102  
 AN/ARC-27 transceiver, 101  
 AN/ARC-146 satellite communications terminal, 134  
 AN/ARD-6 direction finder, 315  
 AN/ARR-9 link receiver-display, 208, 232  
 AN/ARR-16 receiver, 113  
 AN/ARW-17 receiver, 233, 241  
 AN/ARW-37 receiver, 233, 241  
 AN/AWG-9 weapon system, 206  
 AN/AWG-10 weapon system, 205  
 AN/BLR-6 direction finder, 320-321  
 AN/BPA-1 direction finder, 319, 320  
 AN/BRA-10 communications buoy, 89  
 AN/BRA-27 communications buoy, 89-90  
 AN/BRN-4 receiver, 284  
 AN/CPN-6 beacon, 260  
 AN/CPX-2 transponder, 256  
 AN/CRT sono-radio buoy, 111-113  
 Anderson, ADM George W., 121.  
     *See also* Chief of Naval Operations  
 AN/DPN-3 transmitter, 238  
 AN/DPN-7 transmitter, 239  
 AN/DPW-2 receiver-decoder-beacon, 240  
 AN/FLR-7 recorder, 328  
 AN/FPQ-6 radar, 246  
 AN/FPS-7 radar, 190  
 AN/FPS-16 radar, 246  
 AN/FRA-49 antenna multicoupler, 85  
 AN/FRM-3 frequency monitor, 354  
 AN/FSH-1 recorder, 328-329  
 AN/FSH-5 recorder, 328-329  
 AN/FSH-6 recorder, 330-331  
 AN/FSM-5 time transmitter, 336-366  
 AN/GRC-27 transceiver, 101  
 AN/GRD-6 direction finder, 310-311  
 Angular accuracy, enhancing, 198-201, 209  
 AN/GYK-3(V) digital counter, 314  
 AN/MPQ-5 radar, 238  
 AN/MPS-25 radar, 246  
 AN/MS-58 mobile SATCOM terminal, 123  
 ANNAPOLIS, USS, 85  
 Annapolis naval radio station (NSS), 5, 9, 31, 46, 67, 85, 117,  
     137-138, 140, 144-145, 147-148, 152, 227, 364, 368  
 AN/SLA-1 signal analyzer, 325-326  
 AN/SLA-10 blanking system, 324  
 AN/SLQ-10 jammer, 333  
 AN/SLQ-12 jammer, 333  
 AN/SLR-12 direction finder, 322-323  
 AN/SPA-4 plan-position indicator, 194  
 AN/SPA-8 plan-position indicator, 193, 195  
 AN/SPA-9 plan-position indicator, 195  
 AN/SPA-15 plotting board, 383  
 AN/SPA-25 plan-position indicator, 195  
 AN/SPA-26 console, 383  
 AN/SPA-33 plan-position indicator, 195  
 AN/SPA-34 plan-position indicator, 195  
 AN/SPA-59 plan position indicator, 195  
 AN/SPA-66 plan-position indicator, 195  
 AN/SPG-48 radar, 198  
 AN/SPG-49 radar, 200-201  
 AN/SPG-50 radar, 198  
 AN/SPG-53 radar, 198  
 AN/SPG-55 radar, 201  
 AN/SPG-56 radar, 201  
 AN/SPG-59 radar, 201  
 AN/SPN-10 carrier-landing equipment, 280-281  
 AN/SPN-40 receiver, 282-283  
 AN/SPN-42 carrier-landing equipment, 280  
 AN/SPQ-2 radar, 238  
 AN/SPQ-5 radar, 200-201

## INDEX

- AN/SPS-2 radar, 189-190
- AN/SPS-17 radar, 191
- AN/SPS-29 radar, 191
- AN/SPS-30 radar, 193
- AN/SPS-37 radar, 191
- AN/SPS-40 radar, 191
- AN/SPS-43 radar, 191
- AN/SRA-13 antenna multicoupler, 84-85
- AN/SRA-14 antenna multicoupler, 84-85
- AN/SRA-15 antenna multicoupler, 84-85
- AN/SRA-16 antenna multicoupler, 84-85
- AN/SRA-35 antenna multicoupler, 85
- AN/SRA-36 antenna multicoupler, 85
- AN/SRA-37 antenna multicoupler, 85
- AN/SRA-38 antenna multicoupler, 86
- AN/SRA-39 antenna multicoupler, 86
- AN/SRA-40 antenna multicoupler, 86
- AN/SRA-49 antenna multicoupler, 86
- AN/SRA-50 antenna multicoupler, 86
- AN/SRA-56 antenna multicoupler, 85
- AN/SRA-57 antenna multicoupler, 85
- AN/SRA-58 antenna multicoupler, 85
- AN/SRC-20 transceiver, 104
- AN/SRC-21 transceiver, 104
- AN/SRN receiver, 291
- AN/SRN-12 receiver, 284
- AN/SSA-21 data-link terminal, 382-383
- AN/SSR-11 receiver, 157
- AN/SSC-2 SATCOM terminal, 129-30
- AN/SSC-3 SATCOM terminal, 130-133
- AN/SSC-6 SATCOM terminal, 130, 133
- AN/SSQ-65 console, 358
- Antarctic areas, 143
- AN/TED transmitter, 104
- Antenna coupler, SE4363, 60
- Antenna diplex coupling, XZ, 84
- Antenna multicouplers
  - AN/FRA-49, 85
  - AN/SRA-13, 84-85
  - AN/SRA-14, 84-85
  - AN/SRA-15, 84-85
  - AN/SRA-16, 84-85
  - AN/SRA-35, 85
  - AN/SRA-36, 85
  - AN/SRA-37, 85
  - AN/SRA-38, 86
  - AN/SRA-39, 86
  - AN/SRA-40, 86
  - AN/SRA-49, 86
  - AN/SRA-50, 86
  - AN/SRA-56, 85
  - AN/SRA-57, 85
  - AN/SRA-58, 85
- CU255/UR, 107
- CU1573, 86-87
- CU1574, 86-87
- CU1575, 86-87
- Antennas, radar
  - corner reflector type, 215
  - curtain type, 178
  - dipole type, 172, 173, 198
  - directional systems, 201
  - duplexing circuits, 201-203
  - Mark 22, 297
  - parabolic reflector, 169, 187-88
  - paraboloid type, 193
  - planar types, 178, 206
  - polarized beam, 173
  - random-installed, distortion by, 209
  - rotating types, 188, 198
  - rotodome-installed, 209-211, 391
  - sequential lobing, 196
  - SK-3, 109
  - stacked-beam type, 189-190
  - Yagi type, 176-178, 214, 252
- Antennas, radio
  - AT-317 loop antenna, 153
  - balloon-supported, 137-138, 145-146
  - Bellini-Tosi crossed loop, 263.
  - See also* Radio direction finders
  - biconical systems, 106-107
  - broadband types, 78-79
  - characteristics, testing, 17
  - clearing-line loop system, 152
  - congestion, shipboard, 78
  - conical monocone, 80-82
  - conical monopole, 79-80
  - diplex coupling, 84
  - dipole type, 111, 307, 314-315
  - directional systems, 107, 123, 253
  - DQ loop antenna, 153
  - duplexing circuits, 176
  - early types, 6
  - fan type, 410
  - helicopter-supported, 145
  - high-frequency, 78
  - high frequency multiplexing, 82-84
  - high-frequency, shipboard integration, 78-79
  - high-frequency shipboard, radiation characteristics, 82
  - horizontal, end-fire array, 209
  - horn types, 316-320, 322
  - loop-receiver coupling, 153
  - loop types, 20-21, 149, 151-157, 284, 309-310
  - lower-frequency multiplexing, 155-156
  - lower-frequency, shipboard, 145-146
  - lower-frequency types, 144-145
  - multicoupler systems, 84-86, 107, 156
  - multiplexing, 107, 312, 375
  - for Omega systems, 284
  - omnidirectional, 253
  - parabolic reflector, 114, 117-123, 127, 129-130, 276
  - paraboloid types, 109-110, 115-116, 123
  - pattern distortion, avoiding, 315-316
  - radiation resistance in, 16
  - rotating beam, 251, 274
  - in satellites, 400
  - size reduction, 375
  - sleeve types, 78-79, 312

## INDEX

- spiral types, 321
- submarine-towable buoy, 88, 154-155
- subsurface, potentiality explored, 20-21
- trailing-wire, aerial, 49, 98, 142, 283
- trailing-wire, submarine, 145, 149-150, 223
- UHF types, 105-107
- variations, minimizing, 49
- wide-aperture, circular, 314-315
- Antiaircraft defense. *See* Airborne early warning
- Antigua, 246
- ANTIETAM, USS, 280-281
- Antipodes of stations, diurnal variations, 139-140
- Antisubmarine radio buoy, 111-113
- Antisubmarine warfare (ASW), 212, 264, 267-268, 300, 307, 309, 316
- AN/TPQ-18 radar, 246
- AN/TRC-156 SATCOM terminal, 134
- AN/ULA-2 signal analyzer, 325
- AN/URC-9 transceiver, 104
- AN/URC-32 transceiver, 73
- AN/URC-55 spread-spectrum modem, 132, 369-370
- AN/URC-61(S) spread-spectrum modem, 132
- AN/URN-2 receiver, 287
- AN/URN-18 receiver, 284, 287
- AN/URQ-9 frequency standard, 357-358
- AN/URQ-10 frequency standard, 357
- AN/URQ-13 frequency-time standard, 370
- AN/URQ-23 oscillator, 372
- AN/URR-13 receiver, 104
- AN/URR-35 receiver, 104
- AN/USC-2 AEW-interceptor data link, 390
- AN/USD-1A secure-guidance system, 243
- AN/USM-110 frequency synthesizer, 357
- AN/USM-111 frequency synthesizer, 357
- AN/USM-194 frequency synthesizer, 357
- AN/WLR-1 radar interceptor, 320, 322
- AN/WPN-4 receiver, 283
- AN/WPN-5 receiver, 283
- AN/WRN-2 receiver, 284
- AN/WRR-2 receiver, 73
- AN/WRT-2 transmitter, 73
- AN/WSC-1 ship SATCOM terminal, 134
- AN/WSC-2 SATCOM terminal, 130, 132-133
- Appropriations, Congressional, 1, 27, 31-32, 35-37, 39, 171
- Arabian Sea area, 138
- Arc oscillation generators, 16
- Arc stations, 136
- Arc transmitters, 6-11, 47, 53-54, 86
- Arctic areas, 138, 143, 145, 284, 287, 290
- Argentina, 286
- ARIZONA, USS, 96
- Arlington naval radio station (NAA), 6, 8-9, 14, 24, 52-53, 347, 363, 365, 368
- Army Communications Net, 55
- ASA radar, 203
- ASB radar, 201-203, 208, 212, 232, 277, 308
- ASD radar, 203
- ASE radar, 203
- ASG radar, 203
- ASH radar, 203
- Assault drones. *See* Drones
- Assistant Secretary of the Navy. *See* Roosevelt, Theodore, Jr.
- Astronomical observation stations, 368
- Astronomical observations, 361-363
- Astronomy, advances in, 27
- ASV radar, 203
- AT-317 loop antenna, 153
- Atlantic area, 93-94, 133, 136-138, 142, 186, 201, 209-210, 260, 264, 305, 364, 369
- Atlantic City Conferences, 345, 359
- Atlantic Fleet, 47, 228
- Atlantic Missile Range, 246, 365
- Atmosphere, measuring phenomena in, 396
- Atmospheric noise, shielding against, 290
- Atomic explosion, radar detection, 216
- Atomic frequency standards, 358-362
- Atomic hydrogen maser standard frequency, 361
- ATULE, USS, 90
- Audio amplifiers, 12
- Audio-frequency equalization, 24
- Audion vacuum tube, 12-13, 16
- AUGUSTA, USS, 183
- Austin, L. W., 15
- Austin-Cohen formula, 16, 137
- Australia area, 47-48, 144, 286, 368, 398
- Automatic Aircraft Interceptor Control System (AAICS), 388-390
- Automatic aircraft navigator, 276-279, 316-318
- Avalanche in silicon diodes, 384
- Azon guided bomb, 233-234
- Azores area, 286-288, 290
- B-29 aircraft, 205
- BA IFF system, 253
- Backscatter reflections, 178, 213-216
- Backward-wave-oscillator tube, 333-334
- Baffin Bay area, 138
- Bahamas area, 287
- Bahrain Island, 139
- Bainbridge Island, Wash., 283
- Balanced-amplifier circuit, 51, 59
- Balboa naval radio station, 364
- Balewa, A. T., 126
- Balloon-borne transmitter, 91
- Balloon-supported antenna, 137-138, 145-146
- BANG, USS, 147
- Bar Harbor naval radio station, 20
- Barbers Point, Hawaii, 144
- Barrage system receivers, 156
- Baseline II exercises, 357-359
- Bat missile, 235
- Battleship-vs.-aircraft controversy, 223-224
- Baudot code, 224
- BC-221, frequency meter, 353
- BE IFF system, 253
- Beacon responses, display of, 193-194
- Beam-riding guidance in guided missiles, 236-238
- Bedrock system, 147

## INDEX

- Bell Telephone Laboratories, 176, 196, 349, 381, 390  
 Bellini-Tosi crossed-loop antenna, 263  
 Belmar naval radio station, 20-21, 300  
**BELMONT, USS**, 122  
 Bendix Electric Company, 201  
 Bennett, CAPT E. L., 31-32  
 Bering Sea area, 137-138  
 Berlin radio conference, 344  
 Bermuda area, 284, 287-288, 294  
 BF IFF system, 253  
 BF IFF system, 253  
 BG-1 aircraft, 229  
 BH IFF system, 253  
 BI IFF system, 253  
 Bichowsky, F. R., 37  
 Biconical antenna, 106-107  
 Bikini nuclear tests, 229  
*Binary digital techniques*, 253-254, 259, 384-386  
 Birdnesting, 338  
**BIRMINGHAM, USS**, 263  
 Biscay, Bay of, 264, 300, 303  
 BJ transponder, 253,  
 BK transponder, 253  
 BL transponder, 253, 255  
 Blackouts, high-frequency, 137, 145  
 Blanking system AN/SLA-10, 324  
**BLENNY, USS**, 88, 111  
 Bloch, ADM C. C., 228  
 Blossom Point Tracking and Data Acquisition Facility, 398, 404, 408  
 BM transponder, 255  
 BN transponder, 253, 255  
 BO transponder, 255  
 Bod, Norway, 138-139, 284  
**Bombs**  
     Azon, 233-234  
     glide types, 229, 233, 236  
     Glomb type, 235  
     Pelican, 235  
     Razon, 233  
 Bordeaux, France, 10  
 Bosphorus area, 111  
**BOSTON, USS**, 200, 242  
 Boston naval radio station, 137, 363  
 Botswana, 140  
 Bougainville area, 232  
 Boulder, Colo., 91, 404  
 Bowen, RADM H. G., 35-36, 38, 173-176  
 Brandywine satellite ground terminal, 83, 129, 369  
 Branly, Edouard, 6  
 Brazil area, 286  
 Brenner Pass, 233  
 Brest naval base, 264, 300  
*British Mission*, 187  
 Broadband antenna, 78-79  
 BRR-3 radio receiver, 157  
 BT aircraft, 228  
 Bullpup missile, 240-241  
 Buoy system, 89  
 Bureau of Aeronautics, 37, 175, 180, 204, 227, 229, 233, 236, 251,  
     280, 287, 308-309. *See also* Cook, RADM A. B., McCain,  
     VADM John S.  
 Bureau of Construction and Repair, 31, 36, 180  
 Bureau of Engineering, 24, 31-32, 34-36, 39, 47, 49, 59, 61-63,  
     67, 169, 172, 175, 180, 196, 225, 227, 251, 348, 363. *See also*  
     Bowen, RADM H. G., Robinson, RADM, S. M.  
 Bureau of Equipment, 3, 15, 18, 299  
 Bureau of Naval Weapons, 259, 287, 308  
 Bureau of Ordnance, 31, 37, 175, 180, 195, 225, 235-236. *See also* Stark, ADM  
     Harold R.  
 Bureau of Ships, 36-37, 194, 279-280, 283-284, 287, 320, 379, 381, 386, 390-  
     391  
 Bureau of Steam Engineering, 18, 21, 24, 31  
 Bureau system, Navy Department, 27  
 Bureau of Yards and Docks, 31  
 Burke, ADM Arleigh A., 116-117. *See also* Chief of Naval Operations  
**BURTON ISLAND, USS**, 137, 145-146  
**BUSHNELL, USS**, 148  
 Buzz bomb attacks, 195, 241  
  
 C-1 timer, 282  
 C-54 aircraft, 289-294  
 Cable, John L., 23  
 Cable communications, 2, 5  
 Cairo, Egypt, 99  
 Cairo radio conference, 344  
**CALIFORNIA, USS**, 49, 61, 96, 183, 224  
 California area, 109, 141, 398  
 Call letters, stations by. *See* Radio stations by call letters  
 Call sign encryptor, electronic, 76  
**CAMDEN, USS**, 54  
 Camp Roberts, Calif., 369  
 Canada, 379  
 Canal Zone area, 5, 46, 147, 287, 350  
**CANBERRA, USS**, 129-130, 200, 324  
 Canfield, R. L., 37  
 Capacitor, high-power, vacuum variable, 85  
 Cape Canaveral, Fla., 143, 200, 238, 246, 397  
 Cape Hatteras area, 264  
 Cape May, N.J., 228, 230, 265  
**CARBONERO, USS**, 238  
 Caribbean area, 5, 24, 86, 180-181, 227  
 Carnarvon radio station (MUU), 21  
 Carnegie Institution, 44, 171  
 Carrier-landing equipment  
     AN/SPN-10, 280-281  
     AN/SPN-42, 280  
 Carrier traffic and landing control, 279-280  
**CARRY, USS**, 383  
 Cathode-coupled crystal oscillator, 104  
**CAVELLA, USS**, 89  
 Cavite Naval Station, 5, 9  
 CDS (Comprehensive Display System), 379, 381  
 CE615 transmitter, 17  
**CECIL, USS**, 383  
 Central Pacific area, 282  
 Cesium-beam resonance principle, 358-361  
 CG916 tube, 14  
 CG1144 tube, 14, 169



## INDEX

- CG1162 tube, 14  
 CG1353 tube, 15  
 CG2172 tube, 15  
 Chaff confusion device, 338-340  
 Chaff dispenser AN/ALE-29, 339-340  
 Channel allocation. *See* Frequencies, channel allocation  
 Charleston naval radio station, 137  
 Chatham naval radio station, 20  
 CHESTER, USS, 183  
 Chesapeake Bay area, 70, 82, 109, 189, 215, 23, 238, 240, 280, 282, 290, 294, 301, 335, 340, 379-381, 388  
 CHICAGO, USS, 183  
 Chief Constructor, Navy Department, 31  
 Chief of Naval Operations, 34-36, 47, 125, 175, 176, 180, 183, 227-229, 283, 377. *See also* Anderson, ADM George W., Burke, ADM Arleigh A., Coontz, ADM R. E. King, Fleet ADM Ernest J., Leahy, ADM William D., Standley, ADM William H.  
 Chief of Naval Research, 121. *See also* Bowen, VADM H. G.  
 Chile area, 286  
 Chollas Heights, Calif., 9, 283  
 Choshi, Japan, 139  
 Christ Church, England, 133  
 CINCINNATI, USS, 183  
 Cipher keys, quality of, 75  
 Circular trace on screen, 172  
 Circumnavigation of globe by submarine, 147  
 Civilian employees, 18  
 Clearing-line loop antenna, 151-152  
 Cleeton, C. E., 188, 254  
 Clock, quartz-crystal, time transmissions with, 363-365  
 Cloud cover, recording, 400  
 Clutter factor in radar, 177-178, 209, 212-213  
 Coastal shore stations, 111, 137  
 Coastal radio direction finding, 264  
 Coco Solo, C. Z., 144  
 Code generator, 75  
 Coding and decoding systems. *See* Encryption system, electronic  
 Coherer, Branly's, 6  
 Coherer detector, 11  
 College, Alaska, 144  
 Collins Radio Corporation, 386  
 COLORADO, USS, 24, 86  
 Combat Information Center, 194, 209, 211, 279, 377-379, 382, 391  
 Combined Chiefs of Staff, 256  
 Combined Communications Board, 256  
 Combined Research Group, 254, 256-257  
 Command and control  
   electronics in, 375-381, 388, 390  
   radar role in, 377  
   radio needs in, 147  
   satellites role in, 133  
 Command-guidance system AN/APW-19, 243  
 Command ship (APD), 83  
 Commander, Aircraft Battle Force, 273  
 Commander, Aircraft Scouting Force, U.S. Fleet, 67  
 Commander, Atlantic Squadron. *See* Johnson, ADM A. W.  
 Commander, Battleship Division, Battle Fleet, 267  
 Commander, Submarine Division, Battle Fleet, 56-57  
 Commander, Task Force, Atlantic, 301  
 Commander-in-Chief, Pacific Fleet, *See* Hopwood, VADM, Stump, VADM  
 Commander-in-Chief, U.S. Fleet, 56, 180, 228. *See also* Bloch, VADM, Coontz, ADM R. E., Hepburn, ADM A. J., King, Fleet ADM Ernest J., United States Fleet  
 Communications Moon Relay (CMR), 116-122  
 Communications buoys  
   AN/BRA-10, 89  
   AN/BRA-27, 89-90  
 Communications equipment, radio (*see also* Radio equipment, general)  
   AN/APW-4 guidance receiver, 238  
   AN/APW-19 command-guidance system, 243  
   AN/ARC-1 transceiver, 98-99  
   AN/ARC-13 transceiver, 104  
   AN/ARC-19 transceiver, 101-102  
   AN/ARC-27 transceiver, 101  
   AN/ARC-146 SATCOM terminal, 134  
   AN/ARR-16 receiver, 113  
   AN/ARW-17 receiver, 233, 241  
   AN/ARW-37 receiver, 233, 241  
   AN/BPA-1 direction finder, 319, 320  
   AN/BRA-10 communications buoy, 89  
   AN/BRA-27 communications buoy, 89-90  
   AN/BRA-7 submarine-towed buoy antenna, 155  
   AN/CRT sono-radio buoy, 111-113  
   AN/DPN-3 transmitter, 238  
   AN/DPN-7 transmitter, 239  
   AN/DPW-2 receiver-decoder-beacon, 240  
   AN/GRC-27 transceiver, 101  
   AN/SRC-20 transceiver, 104  
   AN/SRC-21 transceiver, 104  
   AN/SSQ-17 transmitter, 111  
   AN/SSR-11 receiver, 157  
   AN/TED transmitter, 104  
   AN/URC-9 transceiver, 104  
   AN/URC-32 transceiver, 73  
   AN/URC-55 spread-spectrum modem, 132, 369-370  
   AN/URR-13 receiver, 104  
   AN/URR-35 receiver, 104  
   AN/WRR-2 receiver, 73  
   AN/WRT-2 transmitter, 73  
   arc transmitters, 6-11, 47, 53-54, 86  
   BRR-3 receiver, 157  
   CW936 transceiver, 14, 49  
   CW1058 aircraft receiver, 14  
   DQ loop antenna, 152  
   GF transmitter, 67  
   GR/RU system, 67  
   GH transmitter, 67  
   GI transmitter, 67  
   GL aircraft communications system, 98  
   IP-76 receiver, 16, 18  
   JM sono-radio buoy, 111-112  
   MD transmitter, 67  
   ME transmitter, 67  
   RAA receiver, 156  
   RAB receiver, 61  
   RAC receiver, 156

## INDEX

- RAK receiver, 149, 152, 156  
 RAL receiver, 61, 156  
 RAO receiver, 61, 304-305  
 RBA receiver, 156, 354  
 RBB receiver, 61, 354  
 RBC receiver, 61, 354  
 RCK shipborne receiver, 99  
 RDZ receiver, 101, 104-105  
 RE receiver, 61-62, 155-156  
 REN sono-radio buoy, 111  
 RF receiver, 61-62, 155-156  
 RG receiver, 60-61  
 RO submarine receiver, 156  
 RU receiver, 67, 272, 274  
 SE95 equipment, 18  
 SE143 equipment, 18  
 SE1000 vacuum-tube audio amplifier, 19  
 SE1310 transmitter, 269  
 SE1375 equipment, 25  
 SE1385 transmitter, 25, 65  
 SE1420 equipment, 18  
 SE1605 amplifier, 19  
 SE1615 amplifier, 19  
 SE950 aircraft receiver, 19  
 SE3716 crystal holder, 57  
 SE4363 antenna coupler, 60  
 T-347/SRT submarine-rescue buoy, 114  
 T-616/SRT submarine-rescue buoy, 114  
 TAF transmitter, 84  
 TAR transmitter, 57  
 TBF transmitter, 58  
 TBG transmitter, 57  
 TBJ transmitter, 9  
 TBK transmitter, 58  
 TBL transmitter, 57-58  
 TBN transmitter, 64  
 TBS transceiver, 96-97  
 TBX transmitter, 58  
 TCS transmitter, 58  
 TDP transmitter, 282  
 TDQ transmitter, 99  
 TDZ transmitter, 101-102, 104-105  
 TL transmitter, 62  
 TO transmitter, 84  
 TU transmitter, 84  
 TV transmitter, 49, 62, 84  
 TW equipment, 49  
 TX equipment, 49  
 XA transmitter, 54-55  
 XB transmitter, 55  
 XCS shipboard receiver, 101  
 XCU transceiver, 101  
 XCX transmitter, 111  
 XD transmitter, 53-54, 365  
 XDM submarine-rescue buoy, 114  
 XE transmitter, 55-56  
 XF transmitter, 54  
 XF-1 transmitter, 55  
 XJ-1 receiver, 96  
 XJ-2 receiver, 95-96  
 XK transmitter, 56  
 XP-1 transmitter, 95-97  
 XT aircraft communications system, 98  
 SV receiver, 96  
 XZ antenna duplex coupling, 84  
 Communications equipment, World War I, 1, 10-14, 16-21, 27-28, 47, 136, 131  
 Communications: ships (AGC), 78, 82  
 Communications systems. *See by type*  
 Comparator, high-precision, 355  
 Compass Link project, 129  
 Comprehensive Display System (CDS), 379, 381  
 Computer systems  
   in aircraft navigation, 280, 289-291  
   IBM 7090, 410  
   radar, use with, 313-314  
   in satellite communications, 123, 130, 132  
   in space surveillance, 410  
   in tactical data systems, 384, 386  
   in target determination, 189-190, 206  
 Conducting-glass-probe technique, 389-392  
 Congress  
   appropriations by, 1, 27, 31-32, 35-37, 39, 171  
   first broadcasts from, 23  
 Conical monocone antenna, 80-82  
 Conical-scan radar, 198  
 Conical monopole antenna, 79-80  
 CONNECTICUT, USS, 9  
 Consoles  
   AN/SPA-26, 383  
   AN/SSQ-65, 358  
 Continental Air Defense system, 190, 200  
 Continuous-wave radar, 169, 172, 414  
 Continuous-wave radio, 6, 51  
 Continuous-wave receivers, 73  
 Continuous-wave transmitters, 73  
 Convair, 237  
 Convoy operations, 96-97, 186, 264, 300  
 Cook, RADM A. B., 173. *See also* Bureau of Aeronautics  
 Coontz, ADM R. E., 30-31, 47. *See also* Commander-in-Chief, U.S. Fleet  
 Coordinates, circular, 287-290  
 Corner reflector antenna, 215  
 Corner transmitter, 53  
 CORRY, USS, 308-309  
 Cosmos project, 381  
 Council of National Defense, 28, 35  
 Council for Research, 35  
 Countermeasures. *See* Electronic countermeasures  
 Countermeasures intercept, radio, 21, 39  
 Coupling tube-resistor network, 86  
 Craggion, Wales, 284  
 Cryptographic generators, 75  
 Cryptographic security, 253-254  
 Crystal-controlled frequencies, 46, 346-350, 363  
 Crystal-controlled oscillator, 50-51, 56, 355-356, 361, 363-364, 407  
 Crystal-controlled transmitters, 48, 51-53, 55, 57-59, 64, 101, 171

## INDEX

- Crystal detectors, 11  
 Crystal holder SE3716, 57  
 Crystal oscillator circuit, 50  
 Crystals  
   procurement, storage and supply, 57  
   structure studies, 51  
   temperature control of, 51  
 CU255/UR antenna multicoupler, 107  
 CU1573 antenna multicoupler, 86-87  
 CU1574 antenna multicoupler, 86-87  
 CU1575 antenna multicoupler, 86-87  
 Cuba area, 5  
 Cuban missile crisis (1962), 89  
 Culver Cader aircraft, 228  
 Curtain antenna, 178  
 CURTIS, USS, 183  
 CUSK, USS, 241-42  
 Cutler naval radio station (NAA), 138-141, 145, 147-148  
 Cutting & Washington, 17  
 CW931 tube, 14  
 CW933 tube, 13  
 CW936 transceiver, 14, 49  
 CW1058 aircraft receiver, 14  
 CW1344 tube, 59-60  
 CW1818 tube, 55-56  
 CXAM radar, 109, 181, 183  
 CXAS radar, 196  
 CXA7 radar, 195  
 CXBF radar, 195  
 CXFG pulse repeater, 335  
 CXGE jammer, 304  
 CXS direction finder, 268  
 Cycle matching, 282  
 Cyprus area, 133
- D1 aircraft, 230  
 DA direction finder, 263, 267  
 DACON (digital-analog), 384-386  
 DAE direction finder, 267  
 DAF direction finder, 264  
 DAH direction finder, 264, 310  
 Dahlgren, Va., 225-226, 410, 412  
 DAJ direction finder, 309  
 DAK direction finder, 267  
 DALLAS, USS, 50, 62  
 Dam Neck, Va., 109  
 Daniels, Josephus, 14, 28, 30-31  
 DAP direction finder, 264, 267  
 DAR direction finder, 309  
 DAS receiver, 282  
   Darien naval radio station, 9, 14, 54  
   DARN (Data Relay Navigation System), 279-280  
   Data-collection systems, satellites in, 404-406, 411-412  
 Data-link terminal AN/SSA-21, 382-383  
 Data-recording systems, 410-412  
 Data Relay Navigation System (DARN), 279-280  
 Data systems  
   computers in, 384, 386  
   electronic systems, 381-384
- DAU direction finder, 310  
 DAV direction finder, 301  
 DAVIS, USS, 303  
 DAW direction finder, 310  
 DB direction finder, 267  
 DBA direction finder, 310  
 DBU direction finder, 316  
 DBV direction finder, 316  
 Decca navigation system, 294  
 Deception in electronic countermeasures, 335-338, 375. *See also*  
   Electronic countermeasures  
 Deception systems, radar, 335-340  
 Decoding systems. *See* Encryption systems, electronic  
 Defense, Department of, 125, 244, 246, 258-259, 293, 363, 369, 377, 381, 395  
   404, 407, 409  
 Defense Communications Agency, 127, 133  
 Defense Communications System, 133  
 DeForest, Lee, 12  
 DeForest Company, 9  
 De Lany, VADM W. S., 301  
 Delta launching vehicle, 397  
 DENTUDA, USS, 316  
 Denby, Edwin, 31, 34. *See also* Secretary of the Navy  
 Depot of Charts and Instruments, 361  
 Depression period, 61  
 Destroyer Division 61, 386  
 Destroyer Division 262, 383  
 Destroyers, 693 class, 79  
 Destroyers-for-bases agreement, 60  
 Detectors, magnetic, 11  
 DETROIT, USS, 84, 96  
 Dewey, ADM George, 2  
 DH-4B aircraft, 63  
 Digital-to-analog converters, 384-386  
 Digital counter AN/GYK-3 (V), 314  
 Digital counter technique, 312-313  
 Digital data converters, 384  
 Digital memory, first magnetic disk, 384-385  
 Diplex coupling antenna, 84  
 Dipole antenna, 111, 172, 173, 198, 307, 314-315  
 Direction finder stations, frequencies for, 264  
 Direction finders. *See* Radio direction finders  
 Director of Defense Research and Engineering, 134  
 Director of Naval Communications, 70  
 Dirigibles, *See* Aircraft  
 Disarmament program, 31, 39  
 Distance measuring with pulses, 169, 171  
 Dividers, frequency, 354-355, 357, 361, 363, 365  
 DK direction finder, 264, 267  
 DL direction finder, 267  
 DM direction finder, 264, 267  
 DN direction finder, 267  
 DOGFISH, USS, 151, 320-321  
 DOLPHIN, USS, 223  
 Doppler effect, 132, 276  
 Doppler radar, 169  
 DORCHESTER, SS, 169  
 Double heterodyning, 61  
 Double sideband superseded, 73

## INDEX

- Dow, COM J. B., 224  
 DP direction finder, 264, 266  
 DQ loop antenna, 152  
 Drift determination by RDF, 276-279  
 Drone Service Group, 228  
 Drones, assault functions tested, 229  
 DSCS satellites, 130-134  
 DT direction finder, 307-308  
 DU direction finder, 268  
 Duplexers  
   gaseous-discharge type, 178-179  
   improved types, 178  
 Duplexing circuit antenna, 176, 201-203  
 DV direction finder, 268  
 DW direction finder, 268  
 DY direction finder, 308  
 Dynamic winged buoy, 89  
 DZ direction finder, 268, 271
- E tube, 14  
 E1B aircraft, 209  
 E2A aircraft, 210-211, 390  
 E2B aircraft, 212, 390  
 E2C aircraft, 212, 390-391  
 EA-6 aircraft, 333-335  
 Early warning systems. *See* Airborne early-warning systems  
 Earth  
   first high-altitude photos, 396-398  
   ionosphere interspace, 140-141  
   magnetic field, 140  
   satellite systems, 397  
   satellite objects, number recorded, 412  
 Eastern Test Range, 246  
 EC-121K aircraft, 286-287, 290  
 ECHO satellites, 121  
 Echo transmissions  
   from moon, 115-116  
   in radio direction finding, 276-279  
   studies of effects, 176, 191, 193, 201, 276  
 Ecuador area, 287  
 Edison, Charles, 35, 176, 227. *See also* Secretary of the Navy  
 Edison, Thomas A., 27-28, 31, 35-36  
 EDISTO, USS, 138, 145  
 EDS (Electronic Data System), 381-384  
 Eiffel Tower, 14  
 Eitel-McCullough, 178, 183  
 Electric dog, 225  
 Electrolytic detectors, 11  
 Electromagnetic shielding, 51  
 Electron-coupled oscillator, 57-58  
 Electron-coupled, oscillator-controlled transmitters, 57-58  
 Electron-multiplier tube, 336-337  
 Electron tube, development, 1-2  
 Electronic countermeasures  
   airborne intercept systems, 315-316  
   AN/ALE-29 chaff dispenser, 336-337  
   AN/ALQ-H(X) pulse repeater, 336  
   AN/ALQ-19 pulse repeater, 337  
   AN/ALQ-23 jammer, 332-333  
   AN/ALQ-49 pulse repeater, 337  
   AN/ALQ-51 pulse repeater, 337  
   AN/ALQ-76 jammer, 333-334  
   AN/ALQ-100 pulse repeater, 337  
   AN/ALQ-126 pulse repeater, 337  
   AN/ALT-2 jammer, 330, 332  
   AN/ALT-19 jammer, 333  
   AN/ALT-21 jammer, 333  
   AN/ALT-27 jammer, 333  
   AN/APA-24x(XB-1) direction finder, 313  
   AN/APA-24x(XB-2) direction finder, 315  
   AN/APA-24x(XB-3) direction finder, 315  
   AN/APA-74 signal analyzer, 325-326  
   AN/APQ-33(XB) jammer, 333  
   AN/BLR-6 direction finder, 320-321  
   AN/GRD-6 direction finder, 310-311  
   AN/GYK-3(V) digital counter, 314  
   AN/SLA-1 signal analyzer, 325-326  
   AN/SLA-10 blanking system, 324  
   AN/SLQ-10 jammer, 333  
   AN/SLQ-12 jammer, 333  
   AN/SLR-12 direction finder, 322-323  
   AN/WLR-1 radar interceptor, 320, 322  
 CXFG pulse repeater, 335  
 CXGE jammer, 304  
 deception practices, 335-338, 375  
 definition, 299  
 first strategic use, 299  
 growth of, 299  
 interference blanking system, 324-325  
 jamming in, 299  
 jamming devices, 330-335  
 Japanese development, 186, 189, 300-301, 305-307, 316  
 MBE pulse repeater, 335  
 missile-control systems, 337, 340  
 naval operations, importance in, 299  
 Navy development, 299-300  
 OB modulation analyzer, 304  
 postwar development, 307  
 pulse repeaters in, 335-338  
 pulse repeaters in deception, 335-340  
 radar passive deception and confusion, 338-340  
 radio direction finders in. *See* Radio direction finders  
 RBK receiver, 304-305  
 RBW receiver, 304-305  
 RBX receiver, 304  
 RCX receiver, 305  
 RDC receiver, 304  
 RDG receiver, 304  
 RDH receiver, 304  
 SE2952 receiver, 300  
 shipboard intercept systems, 320-323  
 shipboard systems, 308-311, 320-325  
 source, radio-determined, 313  
 submarine intercept systems, 316-320  
 TEA jammer, 304  
 TDY jammer, 303  
 in World War I, 300

## INDEX

- in World War II, 300-307, 325  
 XAB direction finder, 307  
 XARD receiver, 301  
 XBK jammer, 301  
 XCA jammer, 304  
 XCJ transmitter, 305  
 XCV direction finder, 316, 318  
 XCY direction finder, 316, 318  
**Electronic Data System (EDS)**, 381-384  
**Electronic following technique**, 195  
**Electronic sequential switching**, 199  
**Electronic systems**  
   in air defense, 379-381, 383-390  
   airborne tactical data systems, 386-390  
   command and control, role in, 375-381, 388, 390  
   commercial development, 386, 390  
   Cosmos project, 381  
   encryption system, 73-76  
   fleet tactical data systems, 379-388  
   in IFF, 379  
   integration, need for, 375  
   Marine Corps tactical data system, 390-393  
   Navy development, 1-2  
**Electronic warfare**. *See* Electronic countermeasures  
**Electronic Committee**, 377  
**Electrostatic deflection plan-position indicator**, 193  
 Elephant Butte, N. M., 410  
 Elliott Brothers, 379  
 Emanations, suppressing, 77-78  
 Encoding-decoding circuitry, 385  
 Encryption system, electronic, 73-76  
 Encryptor, call sign, 75  
 Energy radiation by transmitters, 144  
 Engineer-in-Chief, Navy Department, 31  
 England. *See* Royal Air Force, Royal Navy, United Kingdom  
**ENTERPRISE**, USS, 183, 324, 387  
 Environmental effects, 63-64, 107-109, 155, 191  
 Environmental Services Space Disturbance Forecast Center, 404  
 E-PCS-1425, USS (patrol craft), 107  
 Error-multiplier technique, 375  
**ESSEX**, USS, 376  
**ESTES**, USS, 85  
 European areas, 94, 287, 290, 369  
 Explorer satellites, 200  
 Exercises. *See* Fleet exercises  
 Extraordinary Administrative Radio Conference, 127  
  
**F2H aircraft**, 205  
**F3D aircraft**, 205, 237, 280-281  
**F3H aircraft**, 205  
**F4B aircraft**, 228, 390  
**F4C aircraft**, 206  
**F4D aircraft**, 205-206  
**F4G aircraft**, 388  
**F4H aircraft**, 205-206, 388  
**F4J aircraft**, 205  
**F4U aircraft**, 201  
**F5L aircraft**, 25, 223, 268, 270  
  
**F6F aircraft**, 204, 228, 237-239, 279  
**F8E aircraft**, 205  
**F8F aircraft**, 205  
**F8J aircraft**, 205  
**F8U aircraft**, 205  
**F14 aircraft**, 206-207  
**F-111 aircraft**, 206  
**FA radar**, 196  
  
**Facsimile multiplexing**, 71-72  
**Facsimile radio communications**, 147  
**Fahrney, RADM D. S.**, 227  
**Fallon, Nev.**, 92  
**Fan antenna**, 410  
**FC radar**, 196  
**FD radar**, 196  
**Federal Aviation Administration**, 123, 258, 288, 290  
**Federal Communications Commission**, 1, 121, 123, 190-191, 345.  
   *See also* Federal Radio Commission  
**Federal Radio Commission**, 345. *See also* Federal Communications  
   Commission  
**Federal Telegraph Company**, 6, 10  
**Ferret aircraft**, 315-316  
**Fessenden, Reginald**, 12  
**FH radar**, 196  
**Fighter aircraft**. *See* Aircraft, Patrol aircraft  
**Fiji Islands area**, 286, 290  
**Fire control, radar in**, 176, 193-198, 337, 340  
**Fire control techniques**, 260  
**First Fleet**, 357-359  
**Fixed azimuth antenna**, 263  
**FJ radar**, 198  
**FJ-4B aircraft**, 240  
**FL radar**, 198  
**Flame plasmas, studies of**, 247  
**Fleet exercises**, 47, 86, 126, 299, 357, 359, 377, 381  
**Fleet Tactical Data Systems**, 379-388  
**Florida area**, 287  
**FM radar**, 196  
**Foley, CAPT Paul**, 70  
**Forestport naval radio station**, 144, 284, 286  
**Forestry Service**, 123  
**FORRESTAL**, USS, 280  
**Forrestal, James V.**, 36. *See also* Secretary of the Navy  
**Fort Dix, N.J.**, 126, 133, 369  
**Fort Monmouth, N.J.**, 133, 408  
**Fort Myers, Fla.**, 144  
**Fort Pond Bay, N.Y.**, 148  
**Fort Stewart, Ga.**, 409-410  
**Fort Washington, Md.**, 114, 253  
**Fourth International Radio Conference**, 48  
**Fox Ferry, Md.**, 311  
**France**, 368  
**Frequencies**  
   channel allocation, 1, 6, 10, 20-23, 43-51, 61-63, 86, 96-104,  
     115-117, 134-139, 183, 189-191, 209-216, 253-258,  
     284, 287, 343-366, 375-377  
   comparator, high-precision, 355-356

## INDEX

- control, centralized, 369-373
- control, highly precise, 73, 386
- crystal control, 46, 346-350, 363
- determining, 345-348
- for direction-finder stations, 264
- dividers, 354-355, 357, 361, 363, 365
- heterodyne meter, 348
- high, general use of, 151
- high, Navy adoption, 45-47, 49
- high, shore-station, 53
- high, superior capabilities, 47
- high, erratic performance, 43-45
- higher, long-range, 24
- higher, meters for, 350-351
- higher, propagation characteristics, 44
- instrumentation, 348-349
- lower, defined, 136
- lower, use of, 5-6
- monitoring systems, 351-355, 357-358
- multipliers, 354-355
- navigational carriers, 284
- mark and space, 148
- oscillators, 355
- over, 10,000 MHz, potentiality studied, 134
- piezoelectric crystal control, 49-51
- radio-wave propagation at VLF, 138-142
- seawater, attenuation of radio waves in, 152
- shift keyer, 148
- shipboard optimum, 189
- spectrum functions designation by, 345-346
- stability, improving, 49, 52, 58
- stability, maintaining, 48-49
- standard, atomic hydrogen maser, 361
- standard, high-precision shipboard, 357
- standardization, 343, 349, 350, 355
- standards for, 348-349, 357-359
- standards, atomic, 358-362
- super-high, 187
- synthesizers, decade, 356, 357, 369, 386
- task force monitoring, 357, 358
- time, determination from, 346-348
- transmission system, global, 365, 369
- very low, 21
- very low, absorption loss, 142
- very low, computer performance predictions, 141-142
- very low, coverage predictions, 141, 142
- very low, ionosphere penetration, 144
- very low, night attenuation rates, 140
- very low, propagation, first global study, 138-142
- very low, satellite transmissions, 144
- very low, sea penetration, 150
- very low transionospheric propagation, 144
- Frequency Allocation Board, 256
- Frequency meter crystal SE4376, 349
- Frequency meters
  - BC-221, 351
  - LF, 350, 352, 363
  - LG, 350
  - LM, 350, 351
  - SE2307, 348
  - SE4379, 350-351
  - SE4389, 350-351
- Frequency modulation vs. amplitude modulation, 104-105
- Frequency-monitoring equipment
  - AN FRM-3 frequency monitor, 354
  - AN URQ-9 frequency standard, 357-358
  - AN URQ-10 frequency standard, 357
  - AN URQ-13 frequency-time standard, 370
  - AN USM-110 frequency synthesizer, 357
  - AN USM-111 frequency synthesizer, 357
  - AN USM-194 frequency synthesizer, 357
  - BC-221 frequency meter, 351
  - HP-5100 frequency synthesizer, 357
  - LAM frequency monitor, 351
  - LF frequency meter, 350, 352, 363
  - LG frequency meter, 350
  - LM frequency meter, 350-351
  - NBA frequency-time control, 367
  - SE2307 frequency meter, 348
  - SE2907 frequency standard, 348
  - SE4376 frequency meter crystal, 349
  - SE4379 frequency meter, 350-351
  - SE4389 frequency meter, 350-351
- Frequency-shift-keying (FSK), 68-69, 73, 116
- Frequency standards,
  - AN URQ-9, 357-358
  - AN URQ-10, 357
  - SE2907, 348
- Frequency synthesizers
  - AN USM-110, 357
  - AN USM-111, 357
  - AN USM-194, 357
  - HP-5100, 357
- Frequency-time control NBA, 367
- Frequency-time standard AN URQ-13, 370
- FTDS (Fleet Tactical Data Systems), 379-388
- Furth, ADM F R., 170
- FX German missile, 303
  
- GALVESTON, USS, 200
- Gammatron tube, 175
- GAR, USS, 186
- Gas thrusters, 402, 405
- GBR radio station, England, 368
- General Board, Navy Department, 34, 36, 301 *See also* Ramsey, ADM D C
- General Electric Company, 11, 14-15, 55, 67, 183, 189-191, 251, 255, 349
- General Electric Company (Berlin), 4, 5, 346
- General Radio Company, 363
- Generators
  - aircraft-engine driven, 98
  - arc oscillation, 16
  - cryptographic, 75
  - dual frequency, 365
- Geneva, Switzerland, 127
- GEORGE WASHINGTON, USS, 246

## INDEX

- GEORGETOWN, USS,** 122  
**Geostationary equatorial satellite orbit,** 127-129  
**Germany**  
     air assaults against, 260  
     missiles development, 227, 229, 233, 236, 303, 325  
     radar development, 255, 299-302  
     rocket development, 395-396, 403  
     signal recorder development, 326-327  
     submarines of attacked, 201  
     time transfer to, 369  
**GF transmitter,** 67  
**GF/RU radio equipment,** 67  
**GGSE satellites** *See* Gravity Gradient Stabilization Experiment  
**GH transmitter,** 67  
**GI transmitter,** 67  
**Gila River, Ariz.,** 409-411  
**GILLIS, USNS,** 70, 288  
**Gillis, James, M., USS,** 294  
**Gimbaled motor,** 396  
**GL aircraft communications system,** 98  
**Glide bombs,** 229, 233, 236 *See also* Guided missiles  
**Glomb guided bomb,** 235  
**Goddard Space Flight Center,** 400  
**Goniometer, rotating,** 309-310, 312  
**Gordon, R. A.,** 308  
**Gorgon missile,** 233, 236  
**Gravity Gradient Stabilization Experiment (GGSE),** 400-402  
**Great Lakes naval radio station (NAJ),** 20  
**Great Lakes Naval Training station,** 20  
**Great White Fleet,** 9  
**Green Island area,** 232  
**Greenland area,** 138, 145, 286  
**Ground speed determination by RDF,** 276-279  
**Grumman Aircraft Corporation,** 389  
**Guadalcanal,** 305-306  
**Guam,** 126, 139, 141, 369  
**Guam naval radio station,** 5  
**Guantanamo Bay,** 133  
**Guidance receiver AN/APW-1,** 248  
**Guided missiles**  
     airborne radars in, 205-206  
     automatic homing, 235  
     beam-rider guidance, 236-238  
     commercial production, 237  
     control, radar in, 198-201  
     development, 39  
     first air-to-air intercept, 237  
     first Polaris launching, 236  
     first launching radar detection, 215-216  
     first radio-guided countermeasures, 303, 305  
     first simulation, 229  
     first surface-to-air, 236-239  
     first ship surface-to-surface, 241  
     first submarine ship-to-surface, 241-42  
     first unmanned flight, 225, 227  
     German development, 227, 229, 233, 236, 303, 325  
     intermediate-range ballistic missiles, 244  
     Kingfisher, 235, 239-240  
     Little Joe, 235, 236  
     Loon, 235, 241-242  
     Nike-Ajax, 200  
     Phoenix, 206-207, 247  
     potentiality demonstrated, 229  
     propellants in, 247  
     radar-controlled, 198-201, 337, 340  
     radar homing in, 235  
     radio inertial guidance, 244  
     range, radar instrumentation, 246  
     Regulus, 242-243  
     Sidewinder, 205-206  
     Skylark guidance system, 198, 236-239  
     Sparrow, 205-206, 237, 247  
     Super-Talos, 201  
     Talos, 200-201, 237, 247  
     Tartar, 198, 247  
     telemetry in, 246-247  
     Terrier, 200-201, 237, 247  
     Typhoon, 201  
**Gulf area,** 264-307  
**Gunnery training** *See* Aerial targets, Drones  
**GUPPY class submarines,** 78, 79, 82  
  
**H-16 aircraft,** 268  
**Hagen, Dr. J. P.,** 188, 103  
**Haifa, Israel,** 138  
**Haiku naval radio station,** 141, 143, 145, 283, 281  
**Haines Point,** 171  
**Hammerfest, Norway,** 138  
**Hammond, John Hays, Jr.,** 223  
**Hampton, Va.,** 293  
**Hampton Roads Naval Aircraft Radio Laboratory,** 17, 21  
**HANCOCK, USS,** 138  
**HARDHEAD, USS,** 151  
**Harding, Warren, G.,** 23, 70  
**HARRY LEE, USS,** 274  
**Hastings, H. E.,** 362  
**Hawaii area** 55, 91, 139, 286, 287, 350, 364, 369  
**Hawkinsville, Ga.,** 410  
**Hay, D. I.,** 37  
**Hayes, Dr. H. C.,** 34, 37  
**Hazeltine Electronics Company,** 258  
**Headphones, development,** 17  
**Heintz & Kaufman,** 173  
**Height-finding, radar in,** 210-211  
**Helgoland Island,** 232  
**Helicopter supported antenna,** 145  
**Helicopters** *See* Aircraft  
**Helicopters, in confirming ship-to-surface missile hits,** 8  
**Hepburn, ADM A. J.,** 176, 301 *See also* **USS Zumwalt (DDG-105)**, **U.S. Fleet**  
**Hertz, Heinrich, S. G.,** 345  
**Heterodyne application,** 60  
**Heterodyne meter,** 348  
**Heterodyne method receivers,** 11, 12  
**Heterodyne reception,** 18  
**HICAPCOM system,** 386

## INDEX

- High-Capacity Communication, 386
- High frequencies (HF)
- for aircraft, 63-67
  - antennas, 78
  - blackouts in, 137, 145
  - equipment development, 49
  - equipment performance standards, 61-63
  - equipment technical problems, 61-63
  - erratic performance, 43-45
  - global radio communications, 45
  - multiplexing antenna, 82-84
  - Navy adoption, 45-47, 49
  - pulses in, 44
  - radar intercept, 307-308
  - radio communications in, 43-94
  - radio direction finder systems, 307-311
  - receiver models, 46, 58-61
  - shipboard antenna integration, 78-79
  - shipboard antenna radiation, 82
  - for shore stations, 53
  - single sideband system, 72-73
  - submarines, communications from, 88-89
  - superheterodyne receivers, 60-61
  - superior capabilities, 47
  - wave propagation theory, 44
- High Power Madre OTH radar, 215
- High-precision oscillator, 290
- Higher frequencies
- long range, 24
  - meters for, 350-351
  - propagation characteristics, 44
- Highland Light, 2
- HOLLAND, USS, 96
- Hollandia, New Guinea, 305
- Holmdel, N. J., 121
- Homing systems
- in aircraft, 270-274
  - in guided missiles, automatic, 235
- Hong Kong area, 286
- Honolulu area, 14
- Hooper, RADM Stanford C., 31-32
- Hoover, Herbert, C., 70
- Hopwood, VADM H. G., 117
- Horizontal, end-fire array antenna, 209
- Horn, ADM Charles, 100
- Horn antenna, 316-320, 322
- Howard, D. D., 199
- HP-5100 synthesizer, 357
- HS-293 German missile, 303
- HSS-1 helicopter, 337
- HUGH PURVIS, USS, 322-323
- Hughes Aircraft Corporation, 386
- Hulburt, Edward O., 37-38
- Hum filters, 215
- Humidity control. *See* Temperature-humidity-pressure chamber
- Hurricane, first high-altitude photograph, 396-397
- Hybla Valley site, 313
- Hydrographic Office, Navy Department, 27
- Hydrography, advances in, 27
- IBM 7090 computer, 410
- IC/VRT-7 recorder, 326, 328
- Iceland area, 138, 145, 147, 284, 286-288, 307-308
- Identification, friend-foe (IFF), 39, 45, 111, 186
- ABA system, 253
  - in air defense, 379-381
  - AN/APN-7 transponder beacon, 253
  - AN/APN-13 transponder beacon, 260
  - AN/APN-41 radar beacon, 241
  - AN/APX-1 transponder, 255
  - AN/APX-6 transponder, 256
  - AN/CPN-6 transponder beacon, 260
  - AN/CPX-2 transponder, 256
  - ABK transponder, 253, 255
  - BA system, 253
  - BE system, 253
  - BF system, 253
  - BG system, 253
  - BH system, 253
  - BI system, 253
  - BJ transponder, 253
  - BK transponder, 253
  - BL transponder, 253, 255
  - BM transponder, 255
  - BN transponder, 253, 255
  - BO transponder, 255
  - British development, 253, 255, 381
  - with cryptographic security, 253-259
  - electronic system in, 379
  - first system, 251-255
  - Mark II to XII systems, 255-258
  - Mark X system, 379
  - Navy development, 377
  - pulse beacons in, 259-260
  - pulse method in, 253
  - in systems integration, 379-381
  - in World War II 253-255
  - YH transponder beacon, 260
  - YJ transponder beacon, 260
- IDO radio station, Rome, 21
- Ignition shielding, 64-67
- Inclination-testing equipment, 63
- Indian Ocean area, 138-139, 369
- Information displays, radar, 193-195
- Intercept systems, radar in, 315-320
- Intercepting electronic emissions. *See* Electronic countermeasures
- Interception system, aircraft, Triangle, 388-389, 391
- Interceptor aircraft systems, 206
- Interdepartmental Radio Advisory Committee, 48, 101, 345
- Interference
- generation and elimination, 5-6, 10, 17, 123, 156, 172
  - heterodyne-caused, 61
  - ignition shielding in aircraft, 64-67
  - by Japan, 156, 300
  - mutual among senders, 6, 18, 47
  - from precipitation static, 290
  - radar blanking system, 324-325
  - reducing, 47
  - shielding against, 268



## INDEX

- Interferometer, radio, 410  
 Interim Defense Communications Satellite System, 127  
 International Conference on Weights and Measures, 359  
 International Geophysical Year, 143, 199  
 International Ice Patrol, 55  
 International Radio Conferences, 344-345  
 International Radio Consultative Committee, 127, 344, 368  
 International Radio Conventions, 344-345  
 International Radio Telegraph Company, 17  
 International Telecommunications Conference, 99  
 International Telecommunications Union, 344, 368  
 International Yacht Races (1899), 2  
 Invention and Development, Department of, 28  
 Inventions, Office of, 28  
 Inyokern, Calif., 238  
 Ionosphere  
   investigation of, 171, 403  
   layers, heights of, 44  
   performance prediction, 45  
 Ionospheric sounding stations, 44  
 Ionospheric-wave propagation, 44  
 IOWA, USS, 223-224  
 Iowa area, 396-397  
 IP-76 receiver, 16, 18  
 IREX, USS, 85, 319-320  
 Italy area, 233, 288, 301  
 Iowa Jima, 305
- J tube, 13-14  
 Jacksonville Naval Air Station, 80  
 JAMESTOWN, USS, 122  
 Jamming (*see also* Electronic countermeasures)  
   devices used in, 300-301, 303, 305, 330-335  
   in electronic countermeasures, 299  
   radar devices, 330-335  
 Jamming devices, 330-335  
   AN/ALQ-23, 332-333  
   AN/ALQ-76, 333-334  
   AN/ALT-2, 330-332  
   AN/ALT-19, 333  
   AN/ALT-21, 333  
   AN/ALT-27, 333  
   AN/APQ-33(XB), 333  
   AN/SLQ-10, 333  
   AN/SLQ-12, 333  
   CXGE, 304  
   TDY, 303  
   TEA, 304  
   XBK, 301  
   XCA, 304
- Japan  
   air assaults against, 201, 203, 241  
   assault drones against, 232  
   interference by, 156, 300  
   Kamikaze attacks by, 186, 208, 228, 236  
   Omega propagation studies from, 286  
   radar development, 300-301, 305-307, 316  
 JB-2 guided bomb (Army), 241
- Jenkins (C. Francis) Laboratory, 69-70  
 Jennings Company, 85  
 Jim Creek naval radio station (NPG/NLK), 138, 141, 144-145, 147-148, 368  
 JM sono-radio buoy, 111-112  
 Jodrell Bank, England, 115  
 Johnson, ADM A. W., 180-181. *See also* Commander, Atlantic Squadron  
 Johnson, Lyndon B., 216  
 Joint Chiefs of Staff, 134  
 Joint Research and Development Board, 377  
 Joint Weapons Evaluation Group, 70  
 JONES, USS, 303  
 Jordan Lake, Ala., 409-411  
 Judge Advocate General, 34  
 Jupiter missile, 244
- K type airships, 203  
 Kamikaze attacks, 186, 208, 228, 236  
 Karachi, West Pakistan, 138  
 KC-135 aircraft, 290  
 Keflavik Naval Communications Station, 86  
 KENNEDY, USS, 280  
 Kennedy, John F., 126  
 Kennedy, LT Joseph, P., 232  
 Kennedy Space Center, 247  
 Key-click interference, eliminating, 172  
 Key West, Fla., 149  
 Key West naval radio station, 227  
 Kickapoo Lake, Tex., 409-411  
 KING, USS, 338  
 King, Fleet ADM Ernest J., 183, 273, 301. *See also* Chief of Naval Operations, Commander-in-Chief, U.S. Fleet  
 Kingfisher missiles, 235, 239-240  
 KINGSPORT, USNS, 126, 135  
 Klystron tube, 193, 209, 212  
 Knox, Frank, 36  
 Kodiak, Alaska, 137  
 Kolster, F. A., 263  
 Korean War, 240, 320  
 Kurach, V. J., 339  
 Kurile Islands, 203
- Laboratory established, 2  
 Labrador area, 288  
 Lafayette Radio Station, 10  
 Lagos, Nigeria, 126  
 Lahaina, Hawaii, 57  
 Lakehurst, N. J., 46, 63  
 LAM monitor, 451  
 Lamplight project, 183  
 Land mobile communications, 104  
 Landing craft control system (LCCS), 294  
 Lane identification by RDF, 287  
 LANGLEY, USS, 271, 279  
 LANTFLEX-52, 481  
 Lark missile, 198, 235-239  
 Lasham, England, 284

## INDEX

- LCM radio station, Stavanger, Norway, 21  
 Leahy, ADM William D., 228. *See also* Chief of Naval Operations  
 LEARY, USS, 100, 114, 176-178, 187-188  
 LEBANON, USS, 263, 299  
 Letts system, 294  
 LES 5 and 6 satellites, 134  
 Leveley, Va., 229  
 Lewes, Del., 109  
 LEXINGTON, USS, 96, 183, 271  
 LF frequency meter, 350, 352, 354  
 LG frequency meter, 350  
 Liaison procedures, 36  
 LIBERTY, USS, 122  
 Licitra, M. C., 199  
 Light-blinker system, 114  
 Lighthouse tube, 183  
 Lincoln Laboratory, 209  
 Lincoln Memorial dedication, 23  
 Lines of position, determining, 283-284  
 Link receiver-display, AN/ARR-9, 208, 232  
 Little Joe Missile, 235-236  
 Litton Systems, 390  
 LM frequency meter, 350-351  
 Lodge, Henry Cabot (1850-1924), 23  
 LOFTI (Low Frequency Trans Ionospheric) satellite systems, 143-144, 400  
 Log-log selectivity curves, 105  
 London, England, 46  
 Long-distance communications, 1  
 Long Island South area, 150  
 Long-range navigation. *See* Loran  
 Long Range Navigation Aids Analysis Group, 283  
 Long-Wave Propagation Center, 138  
 Loon Missile, 235, 241-242  
 Loop antenna DQ, 153  
 Loop antennas, 20-21, 149, 151-157, 284, 309-310  
 Loop radio direction finder, 301  
 Loop-receiver coupling technique, 153  
 Lorac system, 294  
 Loran systems, 280-283  
 Low frequencies, night effect at, 24  
 Lower frequencies  
   defined, 136  
   phase stability in, 283  
   radar systems, 190-191  
   radio communication in, 136-137  
   receivers, 155-157  
   use of, 5-6  
 Lower-frequency antennas, 144-145  
 Lower frequency multiplexing antenna, 155-156  
 Lower-frequency shipboard antenna, 145-146  
 LST 506, 104  
 Lualualei naval radio station (NPM), 138-141, 145, 147-148, 368  
 Lyman-Alpha radiation, 403-404  
 Lyons radio station, 21  
  
 Madagascar area, 126  
 Madre OTH radar, 214-216  
  
 Madrid conference, 344  
 Magnetic detectors, 11  
 Magnetic field, earth, 140  
 Magnetic plan-position indicator, 193  
 Magnetron tubes, 187-188, 203, 330  
 MAHAN, USS, 386  
 Maine area, 264, 299  
 MAKASSAR STRAIT, USS, 273  
 Maneuvers. *See* Fleet exercises  
 Manila Bay, battle of, 2, 5  
 Marconi, Guglielmo, 2, 5-6  
 Marconi Wireless Telegraph Company, 2-5, 17, 20  
 Mare Island Navy Yard, 14, 54  
 Mariana Islands area, 5, 274  
 Marine Tactical Data System (MTDS), 390-393  
 Mark I Omega equipment, 287-288  
 Mark I (FA) radar, 196  
 Mark II Omega equipment, 288-289  
 Mark 3 (FC) radar, 198  
 Mark III Omega equipment, 290-291  
 Mark 4 (FD) radar, 196  
 Mark 8 (FH) radar, 196  
 Mark 9 (FJ) radar, 198  
 Mark X IFF system, 379  
 Mark 10 (FL) radar, 198  
 Mark 12 (FM) radar, 196  
 Mark 13 radar, 196  
 Mark 22 radar antenna, 197  
 Mark 25 radar, 198, 240  
 Mark 28 radar, 198  
 Mark 29 radar, 198  
 Mark 34 radar, 198  
 Mark 35 radar, 198  
 Mark 37 optical director, 197-198  
 Mark 39 radar, 198  
 Mark 49 radar, 200  
 Mars, 115  
 Martin (Glenn L.) Company, 396  
 MARYLAND, USS, 267  
 Maser, atomic hydrogen, 361-362  
 MASSACHUSETTS, USS, 2-3  
 Master oscillator-power amplifier transmitter, 211-212  
 MATALOC system, 384, 389  
 MBE pulse repeater, 335  
 McCain, VADM John S., 301. *See also* Bureau of Aeronautics  
 MD transmitter, 67  
 ME transmitter, 67  
 Mediterranean area, 126, 138, 142, 147, 260, 283, 303, 368  
 MEDREGAL, USS, 145, 149  
 Mehl, R. T., 37  
 Melbourne, Australia, 47  
 MEMPHIS, USS, 54-55  
 MEREDITH, USS, 386  
 Meteorological data collection. *See* Weather data collection  
 Meters, higher-frequency, 350-351  
 Mexican incident (1914), 18  
 Mexico area, 396-397  
 MIAMI, USS, 335  
 Microphone placement, 24

## INDEX

- Micropound thrusters, 402  
 Microwave search systems, radar, 191  
 Microwaves, 118  
 MIDWAY, USS, 130  
 Millimeter waves, 114-115  
 Millipound thrusters, 401  
 Miniaturization programs, 13, 46  
 Ministry of Supply, UK, 104  
 Minitrack system, 397-398, 408-410  
 MISSISSIPPI, USS, 224  
 MIZAR, USNS, 290-292  
 Modal effect in VLF propagation, 137  
 Modems  
   in satellite systems, 369  
   spread-spectrum, 132-133  
 Modulated continuous waves, 187  
 Modulation analyzer, OB, 304  
 Modulator-demodulator (modem), 132-133  
 Mojave, California, 144  
 Monitoring  
   for frequencies, 351-355, 357-358. *See also* Frequency-monitoring equipment  
   signal-modulation, 24  
   task force frequencies, 357-358  
 Monopulse systems, radar, 198-201, 209, 246, 389  
 Moon  
   radar contact with, 118-121  
   radio echoes from, 115-116  
 Moonshine pulse repeater, 335  
 Morocco area, 126  
 Morse code transmission, 147, 256  
 Mororola, 383  
 Moving-target indication, radar, 211-212  
 MPQ-50 radar, 198  
 Multicoupler antenna systems, 84-86, 107, 156  
 Multi-electron-gun cathode-ray tube, 325-326  
 Multifrequency radar systems, 212  
 Multi-mesh resonant circuitry, 86  
 Multiple-access satellites, 133  
 Multiple horizontal line display, 173  
 Multiple transmission and reception, first, 24  
 Multiplex carrier-suppressed pulse-duration modulation, 132-133  
 Multiplexing, facsimile, 71-72  
 Multiplexing antennas, 107, 312, 375  
 Multiplexing receivers, 86-88  
 Multiplexing transmitters, 84-86  
 Multipliers, frequency, 354-355  
 Music OTH radar, 214  
 MUU radio station, Carnarvon, England, 21  
 Mylar (balloon covering), 93  
  
 N tube, 13  
 N2C2 aircraft (drones), 228-231  
 N-6 submarine, 145, 223  
 N-9 aircraft, 225-226  
 NAA. *See* Arlington naval radio station  
 NAA. *See* Cutler naval radio station  
 Nantes radio station, 21  
  
 National Academy of Sciences, 397  
 National Aeronautics and Space Administration, 120, 123, 126, 246, 397, 400, 403  
 National Bureau of Standards, 15, 21, 37, 349-350, 368  
 National Center for Atmospheric Research, 91  
 National Company, 359  
 National Defense Research Committee, 35-36, 187, 280  
 National Electric Signalling Company, 6  
 National Electric Supply Company, 17  
 National Emergency Command Post Afloat, 111, 189  
 National Missile Test Ranges, 238, 245, 365. *See also* Atlantic Missile Range; Pacific Missile Range  
 National Physical Laboratory (UK), 349, 359  
 National Radio Astronomy Observatory, 123  
 National Radio Quiet Zone, 123  
 National Science Foundation, 397  
 NATO LINK-1, -4 and -11, 390, 391  
 Nauen (Germany) radio station, 21, 300  
 Naval Aircraft Factory, 227  
 Naval Aircraft Radio Laboratory (NARL), 17, 21-22, 34  
 Naval Communications Command, 404  
 Naval Consulting Board, 27-32, 36-37  
 Naval Electronics Laboratory, 283, 386  
 Naval Electronics Systems Command, 284, 287  
 Naval Engineering Experiment Station, 28, 31, 34  
 Naval Experimental and Research Laboratory, 36  
 Naval Gun Factory, 85  
 Naval Navigation Facilities Advisory Committee, 283  
 Naval Observatory, 27-28, 343, 347, 348, 350, 355, 359, 361-365, 368, 372, 377  
 Naval Ordnance Test Station, 238  
 Naval Radio Central, Navy Department, 53  
 Naval Radio Communications Control, Navy Department, 46  
 Naval Radio Laboratory, 20  
 Naval Radio Telegraphic Laboratory, 15-16, 34  
 Naval Research and Development Board, 36  
 Naval Research Laboratory  
   activities, scope of, 36-37  
   administrative status, 34-36  
   establishment, 2, 20, 27-31, 36  
   organization structure, 31-34, 37-39  
   as principal research agency, 39, 43  
   Radio Division activated, 25  
   site selected, 31  
   work force, periodic, 34, 37, 59  
 Naval Ship Systems Command, 386  
 Naval Space Surveillance System (Facility), 398, 410-412  
 Naval Tactical Data System (NTDS), 380-382, 384-390  
 Navesink naval radio station, 2, 363  
 Navigation and navigation systems  
   advances in, 27  
   air navigation, 259-260  
   airborne Omega system, 287-290  
   aircraft homing system, 270-274  
   aircraft navigators, 274-279, 290  
   aircraft systems, 17-18, 20, 22, 25, 267-271  
   altitude determination, 274-276  
   AN/APN-67 aircraft navigator, 276  
   AN/APN-99 aircraft navigator, 290

## INDEX

- AN/APN-122 aircraft navigator, 278**  
**AN/APN-153 aircraft navigator, 279**  
**AN/APN-187 aircraft navigator, 279**  
**AN/APN-190 aircraft navigator, 279**  
**AN/APN-200 aircraft navigator, 279**  
**AN/APN-141 altimeter, 276**  
**AN/APN-171 altimeter, 276**  
**AN/APN-194 altimeter, 276**  
**AN/BRN-4 receiver, 284**  
**AN/SPN-10 carrier-landing equipment, 280-281**  
**AN/SPN-42 carrier-landing equipment, 280**  
**AN/SPN-40 receiver, 282-283**  
**AN/SRN receiver, 291**  
**AN/SRN-12 receiver, 284**  
**AN/URN-2 receiver, 287**  
**AN/URN-18 receiver, 284, 287**  
**AN/WPN-4 receiver, 283**  
**AN/WPN-5 receiver, 283**  
**AN/WRN-2 receiver, 284**  
 automatic aircraft navigator, 276-279, 316-318  
 British development, 294  
 C-1 timer, 282  
 carrier traffic and landing control, 279-280  
 coastal system, 264  
 commercial production, 267  
 computer systems in, 280, 289-291  
 DBV direction finder, 314  
 Decca navigation system, 294  
 deficiencies in, 267  
 drift determination, 276-279  
 echo transmissions in, 276, 279  
 first shipboard installation, 263, 299  
 ground speed determination, 276-279  
 high-frequency systems, 307-311  
 high-precision DF in, 293-294  
 high-precision systems, 293-294  
 lane identification, 287  
 LCCS system, 294  
 Lelts system, 294  
 long-range system (Loran), 280-294  
 Lorac system, 294  
 Loran systems, 280-294  
 Mark I Omega equipment, 287-288  
 Mark II Omega equipment, 288-289  
 Mark III Omega equipment, 290-291  
 Navy development, 263-264  
 night effect in, 268, 271  
*Omega systems, 283-293*  
 paratrooper assembly system, 301, 303  
 Prefix system, 294  
 pulse radar in, 280-283  
 pulse systems, 280-283  
 pulse technique in, 276  
 radar as aid to, 263-294, 343  
 radio as aid in, 263-294, 343  
 Radux system, 283  
 Rana system, 294  
 rotating loop systems, 263, 268  
 RU receiver, 272, 274  
 satellites, use in, 407-408  
 shielding from interference, 268  
 ship development, 267  
 shore development, 264-267  
 stations, 264  
 submarine applications, 283-284  
 TACAN system, 260, 274  
 UE timer, 282  
 vectoring aircraft, 388-390  
 XM direction finder, 264  
 YE direction finder, 272-274  
 YG direction finder, 273-274  
 YL direction finder, 275  
 YN direction finder, 275  
 ZB direction finder, 272-274  
 NBA frequency-time control, 367  
 NBA. *See* Summit naval radio station  
 NC-4, 24, 268-269  
 NDT. *See* Yosami naval radio station  
 New Brunswick, N.J., 11  
 New Brunswick naval radio station (W11 and NFF), 20  
 NEW HAMPSHIRE, USS, 14  
 NEW JERSEY, USS, 7, 196-198  
 New London naval radio station, 34, 137, 150-151  
 New Mexico area, 396  
 New Orleans, La., 287  
 NEW YORK (armored cruiser No. 2), 2-3  
 NEW YORK (battleship), 100, 180-182, 195, 253, 280, 377  
 New York naval radio station, 137  
 New York Navy Yard, 303  
*New York Times Magazine, 27*  
 New Zealand area, 47, 286, 368  
 Newcomb's right ascension, 365  
 Newfoundland area, 287-288, 290  
 Newport, R.I., 137  
 NEWPORT NEWS, USS, 86  
 Night effect  
     at low frequencies, 24  
     in radio direction finding, 268, 271  
     in very low frequencies, 140  
 Night-fighter aircraft radar systems, 204-205  
 Nike-Ajax missile system, 200  
 NIMITZ, USS, 370-371  
 NKF (naval Research Laboratory station), 52, 59, 63  
 NL/ALD-A direction finder, 316-317  
 NOAH, USS, 386  
 Nodal point technique, 24  
 NOF (NARL radio station), 22, 69-70  
 Noise  
     atmospheric, shielding against, 290  
     measurements, 284  
     survey of levels, 137-138, 142, 147  
 Nome, Alaska, 137  
 Norfolk Naval Station, 133, 137, 150, 268, 294  
 Normandy invasion (1944). *See* Overlord Operation  
 North Africa area, 147, 301, 303  
 North America area, 144  
 North American Air Defense Command (NORAD), 412  
 North Atlantic area, 53, 138, 282, 288

## INDEX

- North Atlantic Fleet, 299  
 North Atlantic Treaty Organization (NATO), 101, 369  
 NORTH CAROLINA (battleship), 183  
 NORTH CAROLINA (cruiser), 17  
 North Pole, 147  
 North Solomons area, 232  
 NORTHAMPTON, USS, 78-79, 81-83, 85, 111, 183, 189-190  
 Northwest Cape naval radio station (NWC), 138, 145, 148, 368-371  
 NORTH SOUND, USS, 238-239, 242  
 Norway area, 148, 188, 286  
 NOTABLE, USS, 294  
 NPG/NLK. *See* Jim Creek naval radio station  
 NPM. *See* Lualualei naval radio station  
 NSF. *See* Naval Aircraft Radio Laboratory  
 NSS. *See* Annapolis naval radio station  
 Nuclear explosions, data collection on, 214, 216, 229  
 Nuclear tests, 229  
 Nuration technique, 198  
 NWC. *See* Northwest Cape naval radio station
- O2U aircraft, 228  
 Oahu area, 117, 129, 284, 307  
 Oakhanger, England, 122  
 OB modulation analyzer, 304  
 OBSERVATION ISLAND, USS, 81, 246  
 Oceana Naval Air Station, 293  
 Office of Naval Research, 36, 123, 283, 358-359, 361-362, 390, 395  
 O'HARE, USS, 383  
 OHIO, USS, 25, 223-224, 268, 270  
 Okinawa area, 122  
 Omnidirectional antenna, 253  
 Omega systems  
   airborne, 287-290  
   antenna for, 284  
   becomes operational, 293  
   differential Omega, 290-293  
   first aircraft operational use, 288  
   lane identification by, 287  
   propagation studies, 283-287  
   stations, proposed sites, 293  
 On-line electronic encryption, 74  
 Opana, Hawaii, 117  
 Operational Development Force, 379  
 Operational Development, Test and Evaluation Force, 113  
 Optical director, Mark 37, 197-198  
 Orbit, determination, 311-313, 395  
 ORISKANY, USS, 279, 386  
 Oscillator circuit, quartz-crystal, 50  
 Oscillator filter, crystal, 120-121  
 Oscillators  
   AN/URQ-23 oscillator, 372  
   backward-wave, 333-334  
   cathode-coupled crystal, 104  
   crystal-controlled, 50-51, 56, 355-356, 361, 363-364, 409  
   electron-coupled, 57-58  
   high-precision, 290  
   radio frequency, 355  
   ring type, 178, 186  
   self-quenching, 173  
   servo-controlled, 372  
   ultra-audion, 12  
   vacuum-tube, 12  
 Oscillograph, high-speed, 45  
 OSO satellites, 403  
 Over-the-horizon (OTH) radar, 45, 212-216  
 Overlord operation, 100, 301, 303, 338  
 OXFORD, USS, 121-122
- P tube, 14  
 P3A aircraft, 213  
 P4M aircraft, 315  
 Pacific area, 5, 24, 56, 86, 136, 138, 156, 186, 188, 201, 204, 206, 235, 255-256, 260, 264-267, 273, 279, 290, 307, 316, 357, 359, 364, 369  
 Pacific Fleet, 47  
 Pacific Missile Range, 143, 246, 365  
 Page, Dr. Robert M., 178  
 Panama Bay, 224  
 Panama Canal Zone. *See* Canal Zone  
 Parabolic reflector antenna, 109, 114, 116-123, 127, 129-130, 169, 187-188, 276  
 Paraboloid antenna, 109-110, 115-116, 123, 193  
 Pas de Calais, 338  
 Patents, effect on development, 18, 36  
 Patrol aircraft, radio in, 65-67  
 Pattern distortion, antenna, 315-316  
 PB aircraft, 209  
 PB4Y aircraft, 232  
 PBY aircraft, 201, 203, 268, 271  
 PDM aircraft, 268, 271  
 Pearl Harbor, 5, 9, 67, 138, 152, 176  
 Peleliu Island, 307  
 Pelican glide bomb, 235  
 PENNSYLVANIA, USS, 96, 183, 263, 267  
 PENSACOLA, USS, 183  
 Pensacola Naval Air Station, 17, 280  
 PEREGRINE, USS, 104  
 Periscope  
   as radar waveguide, 196  
   radio direction finder on, 320-321  
   television buoy, 70  
 Perth, Australia, 139  
 Peru area, 286  
 Phase stability in lower frequencies, 283  
 Phase-tracking technique, 365-369  
 PHILADELPHIA, USS, 196  
 Philadelphia Evening Bulletin, 70  
 Philadelphia Navy Yard, 19, 263, 267  
 Philco Corporation, 203  
 PHILIPPINE SEA, USS, 279  
 Philippines area, 139, 305  
 Phoenix missile, 206-207, 247  
 Photographic Zenith Tube, 363  
 Photographs  
   first of hurricane, 396-397  
   first satellite transmission, 118  
   first of tropical storm, 397

## INDEX

- satellite target transmissions, 129
- transmission, 69
- Photomultiplier, single-channel, 403-404
- Pierce, J. A., 283
- Piezoelectric crystal frequency control, 49-51
- PIKE, USS, 316, 318
- Pilotless aircraft, radio-controlled, 224-227
- PITTSBURGH, USS, 54
- Planar antenna, 178, 180, 206
- Plan-position indicators, 193-195, 203, 377, 379-381, 383-384, 390-392
  - AN/SPA-4, 194
  - AN/SPA-8, 193, 195
  - AN/SPA-9, 196
  - AN/SPA-23, 195
  - AN/SPA-33, 195
  - AN/SPA-34, 195
  - AN/SPA-59, 195
  - AN/SPA-66, 195
  - VC, 194
  - VD, 194
  - VE, 194
  - VF, 194
  - VG, 194
  - VH, 194
  - VJ, 194
  - VK, 194
  - VL, 194
  - VM, 194
  - VN, 194
  - VP, 194
- Plotting boards
  - AN/SPA-15, 383
  - target, 383
- PN-9 aircraft, 268
- Point Barrow, Alaska, 137
- Point Mugu, Calif., 236, 242
- Polar-coordinate display, 193
- Polaris Fleet Ballistic Missile, 244
- Polaris submarines, 138, 148, 155, 283
- Polaris weapon system, 147, 241-247
- Polarization of radio waves, 176
- Polarized beam antenna, 173
- Poldhu, England, 6
- PORTER, USS, 2
- PORTLAND, USS, 228
- Position indication and accuracy, 284, 293-294
- Post Office Department, 121
- Potentiometers, 379, 381
- Potomac River area, 169, 172, 187-188, 225
- Poulsen, Valdemar, 6
- Power output, in radio tubes, 13
- POZ (Nauen radio station), 21, 300
- PRAIRIE, USS, 4-5
- Precipitation static, interference from, 290
- Prefix system, 294
- President, U.S. (*see also* Harding, Warren G., Johnson, Lyndon B., Kennedy, John F., Roosevelt, Franklin D., Wilson, Woodrow)
  - command post afloat, 111, 189
  - first broadcast by, 23
- Pressure control. *See* Temperature-humidity-pressure chamber
- Pre-television system, 70
- PROCYON, USS, 54
- Propaganda broadcasts, German, 300
- Propagation
  - first formula, 15
  - high-frequency wave, 44
  - in higher frequencies, 44
  - lower-frequency waves, 137-138
  - modal effect in VLF, 137
  - Omega, studies, 286
  - precipitation, effect on, 111
  - radio, progress in, 43-45
  - radio, in satellite communications, 115
  - radio-wave, at VHF, 138-142
  - radio-wave, at VLF, 138-142
  - transionospheric VLF, 144
  - tropospheric scatter, 107-111
- Propellants, missile, 247
- PROVIDENCE, USS, 130
- Provincetown, Mass., 148
- Proximity fuze, 229
- Public Health Service, 23
- Puerto Rico area, 5, 286
- Pulse beacons in IFF, 259-260
- Pulse-delay technique, 365
- Pulse method, 44-45, 253
- Pulse navigational radar, 280-283
- Pulse power, higher in radar, 178-179
- Pulse repeaters
  - AN/ALQ-H(X), 336-337
  - AN/ALQ-19, 337
  - AN/ALQ-49, 337
  - AN/ALQ-51, 337
  - AN/ALQ-100, 337
  - AN/ALQ-126, 337
  - CXFG, 335
  - in electronic countermeasures, 335-338
  - MBE, 335
  - moonshine, 335
  - in radar deception, 335-338
- Pulse technique
  - in IFF, 253
  - in radar, 253, 276
- Pulse transponder, 253
- Pulses
  - distance measurement with, 169-171
  - high-frequency, 44
- PV-1 aircraft, 203, 232
- Q2C aircraft, 243
- Quantico, Va., 294
- Quartz crystals
  - determining optical axis, 51
  - production and supply, 51
- R4D aircraft, 317
- RAA receiver, 156

## INDEX

- RAB receiver, 61**  
**Rabaul area, 232**  
**RAC receiver, 156**  
**Radar (radio direction and ranging)**  
   acronym adopted, 170  
   air search by, 188-189  
   airborne gun-laying by, 205  
   aircraft detection by, 171-179, 186-188, 191-193, 204, 215-216  
   in antiaircraft defense, 198  
   AN/APG-25 radar, 198  
   AN/APG-26 radar, 198, 205  
   AN/APG-35 radar, 198  
   AN/APG-49 radar, 205  
   AN/APG-51 radar, 198  
   AN/APG-59 radar, 205  
   AN/APN-41 radar beacon, 241  
   AN/APQ-35 radar, 198, 205  
   AN/APQ-36 radar, 198, 205  
   AN/APQ-41 radar, 198  
   AN/APQ-42 radar, 198  
   AN/APQ-43 radar, 198  
   AN/APQ-47 radar, 198  
   AN/APQ-50 radar, 198, 205-206  
   AN/APQ-51 radar, 205  
   AN/APQ-59 radar, 198  
   AN/APQ-72 radar, 198, 205-206  
   AN/APQ-83 radar, 205  
   AN/APQ-94 radar, 205  
   AN/APQ-100 radar, 198, 206  
   AN/APQ-124 radar, 205  
   AN/APS-2 radar, 203  
   AN/APS-3 radar, 203  
   AN/APS-4 radar, 203-205  
   AN/APS-6 radar, 204-205  
   AN/APS-17 radar, 209  
   AN/APS-18 airborne radar-link transmitter, 208, 232  
   AN/APS-19 radar, 205  
   AN/APS-20 radar-link system, 208, 212  
   AN/APS-20B radar, 209  
   AN/APS-20E radar, 209  
   AN/APS-21 radar, 205  
   AN/APS-25 radar, 198  
   AN/APS-28 radar, 198, 205  
   AN/APS-38 radar, 212  
   AN/APS-44 radar, 212  
   AN/APS-67 radar, 198, 205  
   AN/APS-70 radar, 209-210  
   AN/APS-80 radar, 212-213  
   AN/APS-82 radar, 209  
   AN/APS-87 radar, 209  
   AN/APS-96 radar, 209-212, 391  
   AN/APS-111 radar, 212  
   AN/APS-116 radar, 212  
   AN/APS-120 radar, 212  
   AN/FPQ-6 radar, 246  
   AN/FPS-7 radar, 190  
   AN/FPS-16 radar, 246  
   AN/MPQ-5 radar, 238  
   AN/MPS-25 radar, 246  
   AN/SPG-48 radar, 198  
   AN/SPG-49 (Mark 49) radar, 200  
   AN/SPG-50 radar, 198  
   AN/SPG-53 radar, 198  
   AN/SPG-55 radar, 201  
   AN/SPG-56 radar, 201  
   AN/SPG-59 radar, 201  
   AN/SPQ-2 radar, 238  
   AN/SPQ-5 radar, 200-201  
   AN/SPS-2 radar, 189-190  
   AN/SPS-17 radar, 191  
   AN/SPS-29 radar, 191  
   AN/SPS-30 radar, 193  
   AN/SPS-37 radar, 191  
   AN/SPS-40 radar, 191  
   AN/SPS-43 radar, 191  
   AN/TPQ-18 radar, 246  
   ASA radar, 203  
   ASB radar, 201-203, 208, 212, 223, 277, 308  
   ASD radar, 203  
   ASE radar, 203  
   ASG radar, 203  
   ASH radar, 203  
   ASV radar, 203  
   clutter factor in, 177-178, 209, 212-213  
   command and control role in, 377  
   CXAM radar, 109, 181, 183  
   CXAS radar, 196  
   CXAZ radar, 195  
   CXBF radar, 195  
   deception systems and measures, 335-340  
   FA (Mark 1) radar, 196  
   FC (Mark 3) radar, 196  
   FD (Mark 4) radar, 196  
   FH (Mark 8) radar, 196  
   in fire control, 193, 195-198  
   first aircraft detection, 171-176, 179, 188  
   first aircraft ranging, 172-175  
   first atomic explosion detection, 216  
   first effective detection, 172-179  
   first long-distance missile-launching detection, 215-216  
   first object detection, 169  
   first sea clutter detection, 177-178  
   FJ (Mark 9) radar, 198  
   FL (Mark 10) radar, 198  
   FM (Mark 12) radar, 196  
   in height-finding, 210-211  
   high-power Madre OTH radar, 215  
   higher pulse power in, 178-179  
   information displays, 193-195  
   intercept receiver blanking, shipboard, 323-325  
   intercept signal analysis and recording, 300-301, 303, 305, 325-330  
   Mark 1 (FA) radar, 196  
   Mark 3 (FC) radar, 196  
   Mark 4 (FD) radar, 196  
   Mark 8 (FH) radar, 196  
   Mark 9 (FJ) radar, 198  
   Mark 10 (FL) radar, 198

## INDEX

- Mark 12 (FM) radar, 196
- Mark 13 radar, 196
- Mark 25 radar, 198, 240
- Mark 28 radar, 198
- Mark 29 radar, 198
- Mark 34 radar, 198
- Mark 35 radar, 198
- Mark 37 optical director, 197-198
- Mark 39 radar, 198
- Mark 49 (AN/SPG-49) radar, 200
- in missile control, 198-201
- missile-launching detection, 215-216
- moon, contact with, 118-121
- moving target indication, 211-212
- MPQ-50 radar, 198
- Music OTH radar, 214
- naval operations, importance in, 180, 183, 193
- Navy development, 24, 39, 114, 377
- origin, 169
- over-the-horizon (OTH) radar, 45, 212-216
- passive deception and confusion in, 338-340
- radio, association with, 377
- range, determination by, 171, 195-198
- SA radar, 183
- SC radar, 185, 194
- SC-1 radar, 183
- SCR-270 radar, 176
- SCR-584 radar, 195
- SD radar, 186-188
- SE radar, 187
- in sea surveillance, 201-203
- SF radar, 187-188
- SG radar, 187, 194, 203
- SH radar, 187
- SJ radar, 187-188
- SK radar, 116, 183, 185, 194
- SK-3 radar antenna, 109
- SL radar, 187, 189
- SM radar, 187, 189, 191, 193
- SN radar, 187, 189
- SO radar, 187-188
- SP radar, 187, 189, 191, 193, 198, 238
- SPS-2 radar, 379
- SPS-48 radar, 386
- SQ radar, 187
- SR radar, 186
- SR-1 radar, 186
- SR-2 radar, 186
- SR-3 radar, 186
- SR-6 radar, 186
- ST radar, 196
- SU radar, 189
- in submarine attacks, 188, 196-198
- SV radar, 187-188
- SX radar, 191-193
- techniques, association of, 172
- transmission source, determining, 313
- XAE radar, 251-252
- XAF radar, 179-183, 193, 195, 251, 280, 377
- XAR radar, 183-184, 186
- XAS radar, 186
- XAT radar, 201
- XBF radar, 186
- XBF-1 radar, 186
- Radar beacons
  - AN/APN-41, 241
  - AN/APW-33, 241
- Radar displays
  - AN/ARR-9 link receiver-display, 208, 232
  - AN/SPA-4 plan-position indicator, 194
  - AN/SPA-8 plan-position indicator, 193, 195
  - AN/SPA-9 plan-position indicator, 195
  - AN/SPA-15 plotting board, 383
  - AN/SPA-25 plan-position indicator, 195
  - AN/S A-26 console, 383
  - AN/SPA-33 plan-position indicator, 195
  - AN/SPA-34 plan-position indicator, 195
  - AN/SPA-59 plan-position indicator, 195
  - AN/SPA-66 plan-position indicator, 195
  - VC plan-position indicator, 194
  - VD plan-position indicator, 194
  - VE plan-position indicator, 194
  - VF plan-position indicator, 194
  - VG plan-position indicator, 194
  - VH plan-position indicator, 194
  - VJ plan-position indicator, 194
  - VK plan-position indicator, 194
  - VL plan-position indicator, 194
  - VM plan-position indicator, 194
  - VN plan-position indicator, 194
  - VP plan-position indicator, 194
- Radar interceptor AN/WLR-1, 320, 322
- Radar systems
  - 200-MHz system, 176
  - 450-MHz system, 186
  - airborne early warning systems, 195, 206-209, 386-390
  - airborne guided missile radar, 205-206
  - airborne systems, 201-206
  - airborne sea surveillance systems, 212
  - airborne weapon systems radar, 205-206
  - aircraft direction systems, 191-193
  - air-search systems, 189
  - commercial production, 176, 183, 196, 203, 212
  - conical-scan systems, 198
  - continuous-wave, 169, 172
  - Doppler radar, 169
  - early pulsed system, 172-176
  - fire-control systems, 176, 195-198, 337
  - first airborne, 276
  - first fleet system, 179-183
  - first shipboard system, 176-178
  - German development, 255, 299-302
  - height-finding system, 210-211
  - High Power Madre OTH system, 215
  - Loran systems, 280-283
  - lower-frequency systems, 190-191
  - Madre OTH system, 214-216
  - microwave search systems, 191



## INDEX

- missile-control systems, 198-201
- missile-range instrumentation, 246
- monopulse systems, 198-201, 209, 246, 389
- multifrequency systems, 212
- Music over-the-horizon, 214
  - as navigational aids, 263-294
  - for night-fighter aircraft, 204-205
  - over-the-horizon systems, 45, 212-216
  - periscope, use as waveguide, 196
  - procurement program, 180
  - pulse navigational systems, 280-283
  - search systems, *World War II*, 183-186
  - shipboard search systems, 176-178, 189-190
  - submarine detection systems, 203-204, 212
  - submarine direction systems, 201-203
  - submarine search systems, 186-187
  - super-high frequency systems, 187-189
  - in systems integration, 379-381
  - target-finding systems, 176
  - UHF-AEW systems, 209-212
  - world's most powerful, 189-190
- Radial scan, 193
- Radiated power, vertical, 142
- Radiation Laboratory, 187, 203-204, 208, 235, 256, 280
- Radiation resistance in antenna, 16
- Radio broadcasting
  - advent of, 1
  - broadcast band adoption, 44
  - commercial exploitation, 39
  - continuous-wave, 6, 51, 410
  - early developments, 21-24
  - public interest in, 44
- Radio Central station, 363, 365
- Radio communications buoys, 88-89, 111-114
- Radio communications (*see also* Aircraft radio communications)
  - airborne VLF transmission, 142
  - air-ground, 25
  - amplitude modulation vs. frequency modulation, 104-105
  - command and control needs, 147
  - commercial interest in, 2
  - control, national and international, 1, 343-345
  - early uses, 343-345
  - first aircraft message transmission, 16-17
  - first installations, 1
  - first multiplex transmission-reception, 24
  - first Navy message transmission, 2
  - first radio teleprinter messages, 25
  - first shipboard integration, 86, 375
  - first VHF system, 96-99
  - fleet communications, deficiencies in, 47
  - in high-frequency band, 43-94
  - high-frequency, global, 45
  - high-frequency, from submarines, 88-89
  - at lower frequencies, 136-157
  - lower frequencies, phase stability in, 283
  - naval operations, importance in, 1-2, 138
  - as navigational aids, 263-294, 343
  - Navy, inception in, 2-5
  - propagation program, beginning, 43-45
  - radar, association with, 377
  - sea safety, importance in, 343-344
  - solar radiation, effect on, 403
  - submarine reception, omnidirectional, 153
  - from submerged submarines, 43, 56, 145, 148-55
  - at super-high frequencies, 114-136
  - systems planning and analysis, 105
  - trans-Atlantic transmission, 5-6, 20-21
  - transoceanic and transcontinental, 52-53
  - tropospheric scatter propagation, 107-111
  - in UHF band, 99-100
  - UHF, first shipboard, 100-104
  - in VHF bands, 94-99
  - VLF facsimile, 147
  - VLF propagation study, 138-142
  - VLF transmission, 147-148
- Radio Control, Navy Department, 227
- Radio Corporation of America, 11, 157, 183, 200-201, 212, 349, 381
- Radio countermeasures intercept, 21, 39
- Radio direction and ranging. *See* Radar, Radar systems
- Radio direction finders
  - airborne Omega, 287-290
  - airborne systems, 315-316
  - aircraft homing system, 270-274
  - Aircraft systems, 17-18, 20, 22, 25, 267-271
  - all-around-looking type, 317
  - altitude determination, 274-276
  - AN/APA-24X(XB-1) system, 315
  - AN/APA-24X(XB-2) system, 315
  - AN/APA-24X(XB-3) system, 315
  - AN/ARD-6 direction finder, 315
  - AN/BLR-6 direction finder, 320-321
  - AN/BPQ-1 direction finder, 319, 320
  - AN/GRD-6 direction finder, 310-311
  - AN/SLR-12 direction finder, 322-323
  - AN/SRN-12 direction finder, 284
  - British development, 294, 309
  - carrier traffic and landing control, 279-280
  - coastal system, 264
  - commercial production 264
  - computer systems, use with, 313-314
  - CXS system, 268
  - DA direction finder, 263, 267
  - DAE direction finder, 267
  - DAF direction finder, 264
  - DAH direction finder, 264, 310
  - DAJ direction finder, 309
  - DAK direction finder, 267
  - DAP direction finder, 264, 267
  - DAQ direction finder, 309-310
  - DAR direction finder, 309
  - DAS receiver, 282
  - DAU direction finder, 310
  - DAV direction finder, 301
  - DAW direction finder, 310
  - DB direction finder, 267
  - DBA direction finder, 310
  - DBU direction finder, 316

## INDEX

- DBV direction finder, 316  
 Decca navigation system, 294  
 deficiencies in, 267  
 DK direction finder, 264, 267  
 DL direction finder, 267  
 DM direction finder, 264, 267  
 DN direction finder, 267  
 DP direction finder, 264, 266  
 drift determination, 276-279  
 DT direction finder, 307-308  
 DU direction finder, 268  
 DV direction finder, 268  
 DW direction finder, 268  
 DY direction finder, 308  
 DZ direction finder, 268, 271  
 echo transmissions in, 276, 279  
   in electronic countermeasures, 299  
   first shipboard installation, 263, 299  
   ground-speed determination, 276-279  
   high-frequency intercept, 307-308  
   high-frequency systems, 307-311  
   high-precision navigation systems, 293-294  
   in lane identification, 287  
   LCCS system, 294  
   Lelts system, 294  
   long-range systems (Loran), 280-294  
   Lorac system, 294  
   Navy development, 263-264  
   night effect in, 268, 271  
   NL/ALD-A direction finder, 316-317  
   Omega navigational systems, 283-293  
   paratrooper assembly system, 301, 303  
   periscope-mounted, 320-321  
   Prehx system, 294  
   pulse navigational systems, 280-283  
   Rana system, 294  
   rotating loop systems, 263, 268  
   satellite, calibration with, 315  
   SE74 direction finder, 267  
   SE995 direction finder, 263-264  
   SE1440 direction finder, 263  
   shielding from interference, 268  
   ship development, 267  
   shore development, 263-267  
   source, radio-determined, 313  
   stations, transoceanic, 91  
   submarine applications, 283-284  
   wide-aperture, circularly disposed, 311-315  
 XAB direction finder, 307  
 XCV direction finder, 316, 318  
 XCY direction finder, 316, 318  
 XM direction finder, 264  
 YF direction finder, 272-274  
 YG direction finder, 273-274  
 YL direction finder, 275  
 YN direction finder, 275  
 ZB direction finder, 272-274
- Radio Division, Bureau of Equipment, 5**  
**Radio equipment, general (see also by type, also Aircraft radio**  
   **equipment, Receivers, Transmitters**  
   commercial research and development, 15, 18, 39, 57  
   compulsory installation, 344  
   early models, 4  
   efficiency and deficiency assessments, 15, 18  
   environmental effects on, 63  
   first Navy acquisition, 345  
   high-frequency development, 49  
   high-frequency, interfleet, 49  
   high-frequency, performance standards, 61-63  
   high-frequency, supply to Navy, 61-63  
   high-frequency, technical problems, 61-63  
   Navy development, 1-3, 5-6, 17, 18-25, 27, 32-33  
   in patrol aircraft, 65-67  
   procurement and distribution, 5, 9, 16-17  
   shipboard installation, 5, 14  
   UHF equipment, 100-104  
   voice equipment, 100-104  
   voice equipment, first, 14, 49  
   weight and size reduction, 93, 375
- Radio identification. See Identification friend-foe**  
**Radio inertial guidance in missiles, 244**  
**Radio interferometer, 410**  
**Radio laboratory, first. See Naval Radio Telegraphic Laboratory**  
**Radio Modernization Plan, 47, 49**  
**Radio remote control**  
   of aircraft, 224-227  
   of assault drones, 229-232, 243  
   of bombs, 232-233  
   of drones, 227-232  
   early experiments, 67, 223-227  
   of guided missiles, postwar, 198, 233-247, 300  
   of guided missiles, World War II, 232  
   jamming, vulnerability to, 223, 227  
   of radio transmitters, 227  
   of ships, 223-224  
   of torpedoes, 223, 229  
   of transmitters, 227
- Radio stations**  
   antipodes, variations in, 139-140  
   arc stations, 136  
   coastal shore stations, 111, 137  
   foreign stations, 21  
   remote, time transmission by, 364-365
- Radio stations by call letters**  
   GBR England, 368  
   IDO Rome, 21  
   JPG/NLK Jim Creek, 138, 141, 144, 145, 147-148, 368  
   LCM Stavanger, 21  
   MUU Carnarvon, 21  
   NAA Arlington, 6, 8-9, 14, 24, 52-53, 547, 363, 365, 368  
   NAA Cutler, 138-141, 145, 147-148  
   NAJ Great Lakes, 20  
   NBA Summit, 138, 140, 143, 145, 147-148, 153, 284, 365,  
     367-369  
   NDD Sayville, 20  
   NDT Yonam, 148, 368  
   NFF New Brunswick, 20  
   NKF Naval Research Laboratory, 52, 59, 63

## INDEX

- NOF** Naval Aircraft Radio Laboratory, 22, 68-70  
**NPG/NLK** Jim Creek, 138, 141, 144-145, 147-148, 468  
**NPM** Lunenburg, 138-141, 145, 147-148, 468  
**NSF** Naval Aircraft Radio Laboratory, 17, 21-22, 34  
**NSS** Annapolis, 5, 9, 31, 46, 67, 85, 117, 137-138, 140, 144-145, 147-148, 153, 227, 468  
**NWC** Northwest Cape, 138, 145, 148, 468-469  
**NWW** Tuckerton, 20  
**POZ** Nauen, 21, 300  
**SLI** Sayville, 20  
**UA** Nantes, 21  
**WGG** Tuckerton, 20  
**W11** New Brunswick, 200  
**YN** Lyons, 21  
**Radio target identification** *See* Identification friend-or-foe  
**Radio-telephone communications**, two-way, 14  
**Radio-telephone equipment**, early procurement, 6-9, 15  
**Radio Test Shop (RTS)**, 18-19, 34  
**Radio transmission**  
     first aircraft detection by, 171-172  
     for object detection by, 169  
     ships, detection by, 169  
     spark technique in, 4, 6  
     time, precision transmissions, 465-469  
     in very low frequencies, 147-148  
     zones, 44  
**Radio waves**  
     polarization studied, 170  
     propagation, lower-frequency, 137-138  
**Radome**-installed antenna, distortion by, 209  
**Radar** navigation system, 283  
**Rain**, effect on propagation, 111  
**RAK** receiver, 149, 153, 156  
**RAI** receiver, 61, 156  
**Ramsey**, ADM D C., 401  
**Rana** system, 294  
**Range**, radar determination, 171, 195-198  
**Range finders**, optical, 195  
**Range resolution**, 172  
**RANGER**, USS, 183, 228, 229, 251  
**RAO** receiver, 61, 304-305  
**Rate-aiding circuitry**, 383  
**Rayleigh probability distribution**, 109  
**Raytheon**, 172, 187  
**Razon** guided bomb, 234  
**RBA** receiver, 156, 354  
**RBB** receiver, 61, 354  
**RBC** receiver, 61, 354  
**RBK** receiver, 304-305  
**RBW** receiver, 304-305  
**RBX** receiver, 304  
**RCK** shipborne receiver, 99  
**RCX** receiver, 305  
**RDC** receiver, 304  
**RDX** receiver, 304  
**RDH** receiver, 304  
**RDZ** receiver, 101, 104-105  
**RE** receiver, 61, 62, 155-156  
**Receiver** display beacon AN DPW-2, 240  
**Receivers (see also** Radio equipment, general)  
     aircraft, 58-59  
     alternating-current powered, 156  
     AN/ARR-16 receiver, 113  
     AN/ARW-17 receiver, 233, 241  
     AN/ARW-37 receiver, 233, 241  
     AN/BRN-4 receiver, 284  
     AN/SPN-40 receiver, 282-283  
     AN/SRN receiver, 291  
     AN/SSR-11 receiver, 157  
     AN/URN-2 receiver, 287  
     AN/URN-18 receiver, 284, 287  
     AN/URR-13 receiver, 104  
     AN/URR-35 receiver, 104  
     AN/WPN-4 receiver, 283  
     AN/WPN-5 receiver, 283  
     AN WRN-2 receiver, 284  
     AN/WRR-2 receiver, 73  
     barrage system, 156  
     BRR-3 receiver, 157  
     commercial production, 59, 63, 101-102, 157  
     continuous-wave, 73  
     deficiencies, correcting, 101-102  
     early models, 4, 11-12, 19  
     heterodyne method, 11-12  
     high-frequency models, 46, 58-61  
     high-frequency, superheterodyne, 60-61  
     IP-76 receiver, 16, 18  
     lower-frequency models, 155-157  
     multiplexing, 86-88  
     Navy development, 18  
     number on ships, 63  
     RAA receiver, 156  
     RAB receiver, 61  
     RAC receiver, 156  
     RAK receiver, 149, 153, 156  
     RAI receiver, 61, 156  
     RAO receiver, 61, 304-305  
     RBA receiver, 156, 354  
     RBB receiver, 61, 354  
     RBC receiver, 61, 354  
     RBK receiver, 304-305  
     RBW receiver, 304-305  
     RBX receiver, 304  
     RCX receiver, 305  
     RDC receiver, 304  
     RDX receiver, 304  
     RDH receiver, 304  
     RDZ receiver, 101, 104-105  
     RE receiver, 61, 62, 155-156  
     RF receiver, 61, 62, 155-156  
     RG receiver, 60-61  
     RU receiver, 67, 272, 274  
     SE2952 receiver, 300  
     selectivity problem, 11  
     shielding from interference, 268  
     UHF, shipboard, 99-101, 104  
     universal for submarines, 156  
     World War I equipment, 14

## INDEX

- XARD receiver, 301  
 XJ-1 receiver, 96  
 XJ-2 receiver, 95-96  
 XV receiver, 96
- Recorders**  
 AN/FLR-7 recorder, 328  
 AN/FSH-1 recorder, 328-329  
 AN/FSH-5 recorder, 328-329  
 AN/FSH-6 recorder, 330-331  
 German development, 326-327  
 IC/VRT-7 recorder, 326, 328
- Red River, Ark., 410  
 Reflectometers, development, 85  
 Regulus missile, 242-243  
 Remington Rand Corporation, 386  
 Remote control. *See* Radio remote control  
 Remote indicators, 194  
 REN sono-radio buoy, 111  
 Research and development, general, 27, 36  
 Retrace-insertion circuitry, 383  
 RF receiver, 61-62, 155-156  
 RG receiver, 60-61  
 Richmond (Fla.) astronomical observation station, 368  
 Ring-type oscillator, 178, 186  
 RK-20 tube, 172  
 RO submarine receiver, 156  
 Robinson, ADM. J. K., 31  
 Robinson, RADM. S. S., 69-70. *See also* Bureau of Engineering  
 ROCK HESTER, USS, 54  
**Rockets**  
 development and employment, 395-396  
 German V-2, 395-400, 403  
 Viking, 396-397  
 ROCKVILLE, USS, 294  
 Rocky Point naval radio station, 137  
 ROE, USS, 196  
 Rome conference, 345  
 Rome radio station, 21, 138  
 Roosevelt, Franklin D., 35  
 Roosevelt, Theodore, Jr., 32, 34  
 Rope confusion device, 338  
 Rotary quenched gap, 6  
 Rotating antenna, 188, 198  
 Rotating beam antenna, 251, 274  
 Rotating loop RDF, 263, 268  
 Rotodome-installed antenna, 209-211, 389  
 Round Hill Point, Mass., 109  
 Royal Air Force, 301  
 Royal Aircraft Establishment, 104  
 Royal Navy, 14, 60, 228, 379  
 RU receiver, 67, 272, 274  
 Rugby, England, 138  
 Russia. *See* Soviet Union
- S class submarines, 56-57  
 S-4 and S-5 submarines, 148  
 S-30 submarine, 152  
 SA radar, 183
- SABLE FISH, USS, 147  
 Safety, marine, 1  
 St. John's, Newfoundland, 6  
 ST PAUL, USS, 359  
 Saipan area, 305, 307  
 Salerno landings, 301, 303  
 San Diego area, 46, 57, 109, 116, 148, 228, 398, 410  
 San Francisco naval radio station, 67, 72, 350, 351, 364  
 Sandy Hook Peninsula, 31  
 Santiago (Chile) naval radio station, 140, 144, 398  
 SARATOGA, USS, 84, 96, 183, 271, 273  
**SATCOM TERMINALS**  
 AN ARC, 136, 134  
 AN MSC-58, 123  
 AN SSC-2, 129, 130  
 AN SSC-3, 130, 133  
 AN SSC-6, 130, 133  
 AN TRC-156, 134  
 AN WSC-2, 130, 132, 134
- Satellite communications and electronics**  
 acquisition and tracking, 123, 130  
 active systems, communication with, 124, 127  
 antennas in, 400  
 characteristics, 127, 129  
 communications plan, 125, 127  
 computer systems in, 123, 130, 132  
 data-collection systems in, 404-406, 411-412  
 first aircraft two-way, 126  
 first message over, 116  
 first orbit determination, 311-313, 395  
 first photograph transmission, 118  
 first telephone conversation, 126  
 Gravity Gradient Stabilization Experiment, 400-402  
 modems in, 369  
 multiple access, 133  
 navigational systems, 407, 408  
 radio direction finder calibration with, 315  
 radio propagation in, 115  
 shore-ship communication, 121  
 submarines, communication with, 142-144  
 target photograph transmissions, 129  
 terminals, defining technical features, 129-130  
 terminals, shipboard, 126, 129-133  
 thrusters in, 400-402, 405  
 time transmission by, 369, 370, 407  
 VLF transmissions, 144
- Satellite Communication Plan, 125-127**
- Satellite systems**  
 Defense Satellite Communications System, 127-129, 133-134,  
 369, 372  
 earth systems, 397  
 earth systems, number 412  
 Explorer, 200  
 first global system, 122  
 first launching, U.S., 200, 395  
 first launching facility, 397, 399  
 first operational system, 43, 116, 118, 395  
 first shipboard systems, 121, 122, 126  
 first tracking system, 397, 398, 408

## INDEX

- in geostationary equatorial orbit, 127-129
- GGSE, 400-402
- in global command and control, 133
- Interim Defense Communications Satellite System, 127
- LFS 5 and 6 satellites, 90, 134
- life expectancy, 134
- LOFTI system, 90, 143, 144, 400
- multiple launchings, 402
- Navy development, 115, 116, 395, 400-402
- numbers developed, 400
- OSO satellite, 403
- ship-shore systems, 118-123
- Skylab, 403
- Solrad systems, 402-407
- Soviet development, 311-313, 395
- space surveillance systems, 407-413
- Sputnik 1, 312-313, 395, 408
- stabilization systems in, 400-402, 406
- SYNCOM system, 126, 127, 130, 135
- Tactical Satellite Communications System, 134-136
- Timing systems, 407-408
- TIRCS system, 91, 400
- transcontinental and transoceanic, 116
- Vanguard system, 91, 200, 246, 395, 400-406
- Saville naval radio station (SLL and NDD), 20
- SB2C aircraft, 203
- SC aircraft, 204
- SC radar, 185, 194
- SC-1 radar, 183
- Scaled models, in communications improvement, 82-83, 149
- Schrenk, M. H., 308
- Science, Navy contributions to, 27
- Science Advisory Committee, 191
- Scientific Research and Development Office, 36
- Situate, Mass., 109
- SCR-270 radar, 176
- SCR-584 radar, 195
- Screen-grid, four-element tube, 55
- Scruggam, James G., 171
- SD radar, 186-188
- SF radar, 187
- SF74 direction finder, 263
- SF95 radio equipment, 18
- SF143 radio equipment, 18
- SF950 aircraft receiver, 19
- SF995 direction finder, 263-264
- SF1000 vacuum-tube audio amplifier, 19
- SF1310 transmitter, 269
- SF1375 radio equipment, 25
- SF1385 transmitter, 25, 65
- SF1420 radio equipment, 18
- SF1440 direction finder, 263
- SF1444 tube, 13
- SF1605 amplifier, 19
- SF1615 amplifier, 19
- SF2307 frequency meter, 348
- SF2907 frequency standard, 348
- SF2952 receiver, 300
- SF3119 tube, 55-56
- SF3124 tube, 55
- SF3382 tube, 60
- SF3716 crystal holder, 57
- SF4363 antenna coupler, 60
- SF4376 frequency meter crystal, 349
- SF4379 frequency meter, 350-351
- SF4389 frequency meter, 350-351
- Sea clutter, first radar detection, 177-78 *See also* Clutter
- SEA LEOPARD, USS, 149
- SEA LION, USS, 145, 152
- Sea safety, radio importance in, 343-344
- Sea surveillance
  - airborne radar systems, 212
  - radar in, 201-203
- Sea water, attenuation of radio waves in, 152
- SEACAT, USS, 71, 89, 153
- Search systems
  - radar in, 183-186
  - shipboard radar in, 176-178, 189-190
- SEATTLE, USS, 47-48, 54
- Secretary of Defense *See* Defense, Department of
- Secretary of the Navy, 3, 38, 410 *See also* Adams, Charles Francis, Daniels, Josephus, Denby, Edwin, Edis, A., Charles, Forrestal, James V., Knox, Frank, Swanson, Claude A., Whitney, William C., Wilbur, Curtis D.
- Secretary, 193
- Security guidance system AN USD-1A, 243
- Security safeguarding, 1, 44, 73, 75, 78, 96, 243, 251, 253-254, 256-259
  - cryptographic, 253-259
  - slow code, 256-258
- Selective identification, 258
- Selectivity in receivers, 11
- Self-quenching oscillator, 173
- SEMMES, USS, 183, 194
- Sequential switching, electronic, 199
- Sequential lobing antenna, 196
- Servo-controlled oscillator, 372
- SF radar, 187-188
- SG radar, 187, 194, 203
- SH radar, 187
- SHENANDOAH, USS, 46, 49, 59
- Shielding
  - aircraft radio, 25
  - against interference, 268
- Shift-keying, 68-69, 73, 116
- Ship SATCOM terminal AN WSC-1, 134
- Ship-air communications, 111
- Ship-aircraft rendezvous by Omega, 290-293
- Shipboard conditions, simulating, 63-64
- Shipboard receiver XCS, 101
- Shipborne receiver RCK, 99
- Ship-ship communications, 2, 3, 9, 96, 111
- Ship-ship-shore communications, 73
- Ship-shore communications, 2, 5, 15, 96, 109
- Ship-shore satellite communications, 118-123
- Ship-to-surface missiles *See* Guided missiles
- Ships
  - ACHENAR, USS 109-110

## INDEX

- ADIRONDACK, USS, 104**  
**AGC (communications ship), 78, 82**  
**ALBEMARLE, USS, 183**  
**AMERICA, USS, 211**  
**ANNAPOLIS, USS, 85**  
**ANTIETAM, USS, 280-281**  
**APD (command ship), 83**  
**ARIZONA, USS, 96**  
**ATULE, USS, 90**  
**AUGUSTA, USS, 183**  
**BELMONT, USS, 122**  
**BIRMINGHAM, USS, 263**  
**BOSTON, USS, 200, 242**  
**BURTON ISLAND, USS, 137, 145-146**  
**RUSHNELL, USS, 148**  
**CAG class, 383**  
**CALIFORNIA, USS, 49, 61, 96, 183, 224**  
**CAMDEN, USS, 45**  
**CANBERRA, USS, 129-130, 200, 324**  
**CARRY, USS, 383**  
**CECIL, USS, 383**  
**CHESTER, USS, 183**  
**CHICAGO, USS, 183**  
**CINCINNATI, USS, 183**  
**CLG class, 383**  
**COLORADO, USS, 24, 86**  
**CONNECTICUT, USS, 9**  
**CORRY, USS, 308-309**  
**CURTIS, USS, 183**  
**DALLAS, USS, 50, 62**  
**DAVIS, USS, 303**  
**DETROIT, USS, 84, 96**  
**DORCHESTER, USS, 169**  
**EDISTO, USS, 138, 145**  
**ENTERPRISE, USS, 183, 324, 387**  
**E-PCS-1425 (patrol craft), 107**  
**ESSEX, USS, 376**  
**ESTES, USS, 85**  
**FORRESTAL, USS, 280**  
**GALVESTON, USS, 200**  
**GEORGE WASHINGTON, USS, 246**  
**GEORGETOWN, USS, 122**  
**GILLIS, JAMES M., USS, 294**  
**HANCOCK, USS, 118**  
**HARRY LEE, USS, 274**  
**HOLLAND, USS, 96**  
**HUGH PURVIS, USS, 322-323**  
**IOWA, USS, 223-224**  
**JAMES M. GILLIS, USS, 294**  
**JAMESTOWN, USS, 122**  
**JONES, USS, 303**  
**KENNEDY, USS, 280**  
**KING, USS, 386**  
**KINGSPORT, USNS, 126, 135**  
**LANGLEY, USS, 271, 279**  
**LEARY, USS, 100, 114, 176-178, 187-188**  
**LEBANON, USS, 263, 299**  
**LEXINGTON, USS, 96, 183, 271**  
**LIBERTY, USS, 122**  
**LST 506, 104**  
**MAHAN, USS, 386**  
**MAKASSAR STRAIT, USS, 273**  
**MARYLAND, USS, 267**  
**MASSACHUSETTS, USS, 2-3**  
**MEMPHIS, USS, 54-55**  
**MEREDITH, USS, 386**  
**MIAMI, USS, 335**  
**MIDWAY, USS, 130**  
**MISSISSIPPI, USS, 224**  
**MIZAR, USNS, 290-292**  
**NEW HAMPSHIRE, USS, 14**  
**NEW JERSEY, USS, 7, 196-198**  
**NEW YORK (armored cruiser No. 2), 2-3**  
**NEW YORK (battleship), 100, 180-182, 195, 253, 280, 377**  
**NEWPORT NEWS, USS, 86**  
**NIMITZ, USS, 370-371**  
**NOAH, USS, 386**  
**NORTH CAROLINA (battleship), 183**  
**NORTH CAROLINA (cruiser), 17**  
**NORTHAMPTON, USS, 78-79, 81-83, 85, 111, 183, 189-190**  
**NORTON SOUND, USS, 238-239, 242**  
**NOTABLE, USS, 294**  
**OBSERVATION ISLAND, USS, 81, 246**  
**O'HARE, USS, 383**  
**OHIO, USS, 25, 223-224, 268, 270**  
**ORISKANY, USS, 279, 386**  
**OXFORD, USS, 121-122**  
**PENNSYLVANIA, USS, 96, 183, 263, 267**  
**PENSACOLA, USS, 183**  
**PEREGRINE, USS, 104**  
**PHILADELPHIA, USS, 1**  
**PHILIPPINE SEA, USS, 279**  
**PITTSBURGH, USS, 54**  
**PORTER, USS, 2**  
**PORTLAND, USS, 228**  
**PRAIRIE, USS, 4-5**  
**PROCYON, USS, 54**  
**PROVIDENCE, USS, 130**  
**RANGER, USS, 183, 228-229, 251**  
**TAMPA, USS, 54**  
**ROCHESTER, USS, 54**  
**ROCKVILLE, USS, 294**  
**ROE, USS, 196**  
**ST. PAUL, USS, 359**  
**SARATOGA, USS, 84, 96, 183, 271, 273**  
**SEATTLE, USS, 47-48, 54**  
**SEMMES, USS, 183-194**  
**SOLOMONS, USS, 279**  
**STICKEL, USS, 383**  
**STODDERT, USS, 224-225**  
**STRIBLING, USS, 386**  
**STRINGHAM, USS, 16**  
**TENNESSEE, USS, 49**  
**TEXAS, USS, 54-55, 84, 96, 183**  
**THUBAN, USS, 109-110**  
**TOPEKA, USS, 5**  
**UTAH, USS, 224-225, 228-229**  
**VALDEZ, USS, 122**

## INDEX

- VALLEY FORGE, USS, 279**  
**VIRGINIA, USS, 9**  
**WAINWRIGHT, USS, 132**  
**WASHINGTON, USS, 183**  
**WASP, USS, 183**  
**WEST VIRGINIA, USS, 96, 183**  
**WICHITA, USS, 196**  
**WILFONG, USS, 483**  
**WRIGHT, USS, 85, 111, 130, 132-133**  
**WYCOMING, USS, 24, 54, 86, 263, 375**  
**YORKTOWN, USS, 109, 183**
- Ships, detection by radio, 171**  
**Shock-testing equipment, 63**  
**Shore-ship satellite communications, 121**  
**Shoemaker, Harry, 223**  
**Sidewinder missiles, 205-206**  
**Signal analyzers**  
     AN/APA-74, 325-326  
     AN/SLA-1, 325-326  
     AN/UUA-2, 325  
**Signal Corps, U.S. Army, 55, 173, 176, 408. *See also* United States Army**  
**Signal data converter, 386**  
**Signal processor, 216**  
**Signal recorders, German, 326-327**  
**Silver Lake, Miss., 410**  
**Simon, E. J., 17**  
**Singapore area, 286, 305**  
**Single-channel photomultiplier, 403-404**  
**Single sideband**  
     high-frequency system, 72-73  
     operation feasible, 73  
**Sixth Fleet, 126**  
**SJ radar, 187-188**  
**SK radar, 116, 183, 185, 194**  
**SK-3 radar antenna, 109**  
**SKATE, USS, 147, 316, 318**  
**Skip-distance effect, 44**  
**Skylab system, 403**  
**Skylark missile-guidance system, 198, 236-239**  
**SL radar, 187, 189**  
**Slaby-Arco system, 4-5, 346**  
**Sleeve antenna, 78-79, 312**  
**Slow-code security, 256, 258**  
**SM radar, 187, 189, 191, 193**  
**Smith, RADM William Strother, 28, 30-32**  
**SN radar, 187, 189**  
**SNB aircraft, 237, 240**  
**Snorkel-type submarine, 212**  
**SO radar, 187-188**  
**Solar power cells, 398-399, 406**  
**Solar radiation**  
     effect on radio communications, 403  
     measuring, 400-407  
     television in measuring, 403-404  
**Solid state devices, 195, 259, 384**  
**SOLOMONS, USS, 279**  
**Solrad Data Operations Center, 404**  
**Solrad systems, 402-407**
- Sono-radio buoys**  
     AN/CRT, 111-113  
     JM, 111-112  
     REN, 111  
**Sound detectors, development, 36**  
**South Africa area, 396**  
**South America area, 144, 265-267, 286-287, 290, 307-308, 368**  
**South Dakota area, 288**  
**South Pacific area, 232, 260**  
**Southeast Asia areas, 129, 138, 241, 322-323, 332-335, 337-340, 391**  
**Southern France area, 304**  
**Southwest Pacific area, 282**  
**Soviet Union, satellite development, 311-313, 395**  
**SP radar, 187, 189, 191, 193, 198, 238**  
**Space Detection and Tracking System, 410**  
**Space exploration, 400**  
**Space frequencies, 148**  
**Space mail, 121**  
**Space surveillance**  
     computer systems in, 410  
     by satellite, 407-413  
**Space vehicles**  
     communications in, 247  
     Surveyor, 247  
**Spain area, 290**  
**Spanish-American War, 2, 5**  
**Spark quenching, 6**  
**Spark technique in transmission, 4, 6**  
**Spark transmitters, 6-7, 47, 86**  
**Sparrow missiles, 205-206, 237, 247**  
**Special Projects Office, 244**  
**Sperry Rand Corporation, 203-205, 386**  
**Spiral antenna, 321**  
**Splashback reflections, 45, 213**  
**Spread-spectrum modems, 132-133, 369-370**  
     AN/URC-55, 132, 369-370  
     AN/URC-61 (S), 132  
**SPS-2 radar, 379**  
**SPS-48 radar, 386**  
**Sputnik 1 satellite, 312-313, 395, 408**  
**SQ radar, 187**  
**SR radar, 186**  
**SR-1 radar, 186**  
**SR-2 radar, 186**  
**SR-3 radar, 186**  
**SR-6 radar, 186**  
**ST radar, 196**  
**Stabilization systems, in satellites, 400-402, 406**  
**Stacked-beam antenna, 189-190**  
**Stanley, ADM William H., 173. *See also* Chief of Naval Operations**  
**Stark, ADM Harold R., 170, 173. *See also* Bureau of Ordnance**  
**Station call sign encryptor, electronic, 75**  
**Station keeping thrusters, 402**  
**Statistics analyzer, electronic, 76**  
**Stavanger radio station, 21**  
**STICKEL, USS, 383**  
**Stirling Island area, 232**  
**STODDERT, USS, 224-225**

## INDEX

- Stone Radio & Telegraph Company, 263  
**STRIBLING**, USS, 386  
**STRINGHAM**, USS, 16  
 Stump, VADM F. B., 116  
 Stump Neck satellite research facility, 115, 120-121, 144  
**SU** radar, 189  
 Submarine receiver RO, 156  
 Submarine-rescue buoys.  
   T-347/SRT, 114  
   T-616/SRT, 114  
   XDM, 114  
 Submarine towable antenna, 8, 154, 155  
 Submarine-towed buoy antenna AN/BRA-7, 155  
**Submarines**  
   attacks by, radar in, 188, 196-198  
   **BANG**, USS, 147  
   **BLENNY**, USS, 88, 111  
   **CARBONERO**, USS, 238  
   **CAVELLA**, USS, 89  
   **CUSK**, USS, 241-242  
   **DENTUDA**, USS, 316  
   **DOGFISH**, USS, 151, 320-321  
   **DOLPHIN**, USS, 223  
   **GAR**, USS, 186  
   globe circumnavigation by, 147  
   **HARDHEAD**, USS, 151  
   high-frequency radio communication from 88-89  
   **IREX**, USS, 85, 319-320  
   **MEDREGAL**, USS, 145, 149  
   N-6, 145, 223  
   omnidirection radio reception, 153  
   **PIKE**, USS, 316, 318  
   **POLARIS** class, 138, 148, 155, 283  
   radar detection systems, 203-204, 212  
   radar direction systems, 201-203  
   radar search systems, 186-187  
   RDF applications, 283-284  
   S class, 56-57  
   S-4 and S-5 class, 148  
   S-30, 152  
   **SABLE FISH**, USS, 147  
   satellite communication with, 142-144  
   **SEA LEOPARD**, USS, 149  
   **SEA LION**, USS, 145, 153  
   **SEACAT**, USS, 71, 89, 153  
   **SKATE**, USS, 147, 316, 318  
   snorkel types, 212  
   snorkel-type, communications in, 215  
   submerged, radio communication in, 43, 56, 145, 148-155  
   television application to, 70-72  
   **THRESHER**, USS, 288  
   **TIRANTE**, USS, 71, 89  
   transmitters, high-frequency, 55-57  
   **TRITON**, USS, 147  
   **TRUTTA**, USS, 71, 89  
   universal receivers for, 156  
   V class, 55-57  
 Subsurface antenna, 20-21  
 Sugar Grove Satellite Communications Research Facility, 123-124  
 Summit naval radio station (NBA), 138, 140, 143, 145, 147-148, 152, 284, 365, 367-369  
 Superhetrodyne receivers, 60-61  
 Super-high frequencies, 187  
   in radar systems, 187-189  
   radio communication in, 114-136  
 Super-Talos missile, 201  
 Supreme Court justice, first broadcast by, 23  
 Surface-to-air missiles. *See* Guided missiles  
 Surface-to-surface missiles. *See* Guided missiles  
 Surgeon General, U.S., 23  
 Surveillance systems, global, 171, 409-410  
 Surveyor space vehicle, 247  
**SV** radar, 187-188  
 Swanson, Claude A., 35  
**SX** radar, 191-193  
 Synchronizer, first electronic, 283  
 Synchronous rotary spark-gap transmitter, 6  
**SYNCOM** satellites, 126, 129-130, 135  
 Synthesizers, frequency, 356-357, 369, 386  
**Systems integration**  
   of air-defense systems, 379-381  
     Airborne Tactical Data System, 386-390  
     Automatic Aircraft Interceptor Control System, 388-389  
     Combat Information Center role in, 377-379, 382, 391  
     Comprehensive Display System, 379, 381  
     COSMOS project, 381  
     Electronic Data System, 381-384  
     Electronic Tactical Data Systems, 379-381  
     Marine Tactical Data System, 390-393  
     MATALOC system, 384, 389  
     NATO LINK-1, -4, and -11, 390-391  
     Naval Tactical Data System, 384-386  
     plan-position indicators in, 193-195, 203, 377, 379-381, 383-384, 390-392  
     TADIL-A, -B and -C systems, 391  
     Triangle system development, 389  
 T rube, 14  
 T-147/SRT submarine-rescue buoy, 114  
 T-616/SRT submarine-rescue buoy, 114  
**TACAMO** project, 142  
**TACAN** navigation system, 260, 274  
**TACSAT** satellite, 134-136  
**TACSATCOM** Executive Steering Group, 134  
 Tactical Satellite Communications Systems (TSCS), 134-136  
**TADIL-A, -B and -C** systems, 391  
**TAF** transmitter, 84  
 Tahiti area, 286  
 Talos missile, 200-201, 237, 247  
**TAMPA**, USS, 54  
 Tananarive, Malagasy, 139  
**TAR** transmitter, 57  
 Target determination, computers in, 189-190, 206  
 Target identification  
   radar in, 176  
   satellite photo transmission, 129  
**Targets**  
   serial, maneuverable, 28



## INDEX

- data storing of, 379-384
- drones. *See* Drones
- identification. *See* Identification friend-foe
- plotting board, 383
- television in remote observation, 229, 232, 235
- Tartar missile, 198, 247
- Task force frequency monitoring, 357-358
- Tatoosh Island naval radio station, 5
- Taylor, Dr. A. Hoyt, 20-21, 34, 37, 59, 178, 188
- TBF aircraft, 201, 203, 272
- TBF transmitter, 58
- TBG transmitter, 57
- TBJ transmitter, 9
- TBK transmitter, 58
- TBL transmitter, 57-58
- TBM aircraft, 202, 204, 208
- TBN transmitter, 64
- TBS transceiver, 96-97
- TBX transmitter, 58
- TCS transmitter, 58
- TDC aircraft, 228
- TDP transmitter, 282
- TDR aircraft, 232
- TDQ transmitter, 99
- TDY jammer, 303
- TDZ transmitter, 101-102, 104-105
- TEA jammer, 304
- Technical Research Ship Special Communications (TRSSCOM), 121-122
- Teddington, England, 349, 359
- Telemetry, in guided missiles, 246-247
- Telemetry systems, development, 395, 402, 410
- Telephone conversation, first by satellite, 126
- Teletypewriters
  - first radio messages, 25, 147
  - message transmission by, 67-70, 147
- Television
  - first transmissions, 70
  - Navy development, 70-71
  - in remote target observation, 229, 232, 235
  - in solar radiation measurement, 403-404
  - submarine applications, 70-72
- Television buoy, periscope, 70
- Television three-electron-gun tube, 325-326
- Temperate areas, 284
- Temperature control of crystals, 51
- Temperature-humidity-pressure chamber, 63
- TENNESSEE, USS, 49
- Terrier missiles, 200-201, 237, 247
- Tesla, Nikola, 223
- Tetrode tube, 13
- TEXAS, USS, 54-55, 84, 96, 183
- Texas area, 394, 397
- TG-2 aircraft, 228-229
- Thoriated-filament tube, 13, 15
- Three Sisters radio towers, 8
- THRESHER, USS, 228
- Thrusters in satellites, 400-402, 405
- THUBAN, USS, 109-110
- Tikker circuit, 11
- Tillamook, Ore., 91-92
- Timing satellites, 407-408
- Time
  - control centralized, 369-373, 375
  - frequency determination from, 346-348
  - precision transmission system, 365-369
  - quartz-crystal clock transmissions, 363-365
  - remote stations transmission by, 364-365
  - satellite, transmission by, 369-370, 407
  - standard, for U. S., 361-363
  - standard atomic, 359
  - standard time transmissions, 361-369
  - standardization, need for, 343
  - zones, Navy efforts in fixing, 27
- Time-difference method, 211
- Time interval, standardizing, 361-363
- Time transmitter AN/FSM-5, 364-366
- Timed spark, 6
- Timers
  - C-1, 282
  - first electronic, 283
  - UE, 282
- TIRANTE, USS, 71, 89
- Tizard, Henry T., 187
- TL transmitter, 62
- TO transmitter, 84
- TOPEKA, USS, 5
- Toulon, France, 284
- Tracking system, satellite, 397-398, 408
- Trailing-wire antenna
  - aerial, 49, 98, 142, 223
  - submarine, 145, 149-150, 223
- Trans-Atlantic flight, first, 24, 268-269
- Trans-Atlantic radio transmission, 5-6, 20-21
- Transceivers
  - AN/ARC-1, 98-99
  - AN/ARC-13, 104
  - AN/ARC-19, 101-102
  - AN/ARC-27, 101
  - AN/GRC-27, 101
  - AN/SRC-20, 104
  - AN/SRC-21, 104
  - AN/URC-9, 104
  - AN/URC-32, 73
  - CW936, 14, 49
  - TBS, 96-97
  - XCU, 101
- Transcontinental and transoceanic radio communication, 52-53
- Transcontinental and transoceanic satellite communication, 116
- Transistors, 259
- Transmitters (*see also* Radio equipment, general)
  - AN/APS-18, 208, 232
  - AN/DPN-3, 238
  - AN/DPN-7, 239
  - AN/SSQ-17, 111
  - AN/TED, 104
  - AN/WRT-2, 73

## INDEX

- arc transmitters, 6-11, 47, 53-54, 86
- commercial production, 57-58, 96
- continuous-wave, 73
- crystal-controlled, 48, 51-53, 55, 57-59, 64, 101, 171
- early models, 5-6
- electron-coupled, oscillator-controlled, 57-58
- energy radiated by, 144
- first shipboard UHF, 101-104
- GF, 67
- GH, 67
- GI, 67
- in global surveillance, 409-410
- high-frequency alternator, 10-11
- high-frequency, balloon-borne, 91
- high-frequency, high-power, for ships, 54-55
- high-frequency, high-power, for shore stations, 53-54
- high-frequency models, development, 46, 49, 58
- high-frequency, submarine, 55-57
- oscillator power-amplifier type, 211-212
- MD, 67
- ME, 67
- oscillator power-amplifier type, 211-212
- multiplexing, 84-86
- number on ships, 63
- performance predictions, 142
- radio remote control of, 227
- SE1310, 269
- SE1385, 25, 65
- spark transmitters, 6-7, 47, 86
- synchronous rotary spark-gap, 6
- TAF, 84
- TAR, 57
- TBF, 58
- TBG, 57
- TBJ, 9
- TBK, 58
- TBL, 57-58
- TBN, 64
- TBX, 58
- TCS, 58
- TDP, 282
- TDQ, 99
- TDZ, 101-102, 104-105
- TL, 62
- TO, 84
- TU, 84
- TV, 49, 62, 84
- vacuum-tube transmitters, 6, 9-10
- XA, 54-55
- XB, 55
- XCJ, 305
- XD, 53-54, 365
- XE, 55-56
- XF, 54
- XF-1, 55
- XK, 56
- XP-1, 95-97
- Transosonde system, 89-94
- Transponder beacons
  - AN/APN-7, 253
  - AN/SPN-13, 260
  - AN/CPN-6, 260
  - YH, 260
  - YJ, 260
- Transponders
  - ABK, 253, 255
  - AN/APX-1, 255
  - AN/APX-6, 256
  - AN/CPX-2, 256
  - BJ, 253
  - BK, 253
  - BL, 253, 255
  - BM, 255
  - BN, 253, 255
  - BO, 255
  - pulse systems, 253
- Traveling-wave tube, 334-336
- Triangle aircraft interception system, 388-389, 391
- Trinidad naval radio station, 284
- Tropical areas, 284
- Tropical storm, first high-altitude photo, 396-397
- TRITON, USS, 147
- Tri-Service Radar Instrumentation Technical Group, 246
- Tropospheric scatter propagation, 107-111
- Truk Island, 201
- TRUTTA, USS, 71, 89
- TU transmitter, 84
- TU-2 aircraft, 227
- Tube types
  - air-cooled, 55
  - audion, 12-13, 16
  - backward-wave-oscillator, 333-334
  - CG916, 14
  - CG1144, 14, 169
  - CG1162, 14
  - CG1353, 15
  - CG2172, 15
  - CG38161, 58
  - CW931, 14
  - CW933, 13
  - CW1344, 59-60
  - CW1818, 55-56
  - development and exploitation, 12-15
  - E, 14
  - electron-development, 1-2
  - electron-multiplier, 336-337
  - feedback circuit in, 18
  - first radio-frequency amplifiers, 19
  - Gammatron, 173
  - J, 13-14
  - klystron, 193, 209, 212
  - magnetron, 187-188, 203, 330
  - multi-electron-gun cathode-ray, 325-326
  - N, 13
  - P, 14
  - power output, 13-14
  - radar development, lack in, 173

## INDEX

- RK-20, 172  
 screen-grid, four-element, 55  
 SE1444, 13  
 SE3119, 55-56  
 SE3124, 55  
 SE3382, 60  
 T, 14  
 tetrode, 13  
 thoriated-filament, 13, 15  
 three-electron-gun for television, 325-326  
 traveling-wave, 334-336  
 tungsten filament, 14-15  
 U, 14  
 water-cooled metal-anode, 10-11, 15, 55  
 Tucker, RADM S. M., 170  
 Tuckerton naval radio station (WGG and NWW), 20  
 Tungsten filament tube, 14-15  
 Tuning-fork standard, 346-347, 349  
 TV radio transmitter, 49, 62, 84  
 TW radio equipment, 49  
 TX radio equipment, 49  
 Typhon missile, 201
- U** tube, 14  
 UA radio station (Nantes), 21  
 UE timer, 282  
 Ultra-audion oscillator, 12  
 Ultra-high-frequency (UHF)  
   in aircraft, 100-102  
   antennas, 105-107  
   first shipboard, 100-104  
   radio communication in, 99-100  
   radio equipment, 100-104  
   receivers, shipboard, 99-101, 104  
 United Kingdom, 147, 195, 201-203, 288, 290, 368, 377, 379, 381. *See also*  
   Royal Air Force; Royal Navy  
 United Nations, 344, 368  
 United States Air Force, 80, 101, 104, 127, 129, 134, 136,  
   189-190, 206, 209, 243, 258-259, 276, 279, 288, 290, 316,  
   377, 379, 404  
 United States Army, 101-102, 104, 126, 133-134, 171, 223, 228,  
   238-239, 241, 243-244, 255, 259-260, 276, 290, 301, 348,  
   351, 377, 379, 395, 408. *See also* Signal Corps, U.S. Army; War  
   Department  
 United States Coast Guard, 55, 59, 282-283, 288, 290  
 United States Fleet, 47, 65. *See also* Commander-in-Chief, U.S. Fleet  
 United States Marine Corps, 55, 59, 190, 294, 390-393  
 United States Weather Bureau, 91, 396-397  
 UNIVAC, 386  
 UTAH, USS, 224-225, 228-229  
 Utility Squadron, East Coast, 228  
 Utility Squadron Three, 228
- V** class submarines, 55-57  
 V-2 rockets, German, 395-396, 403  
 Vacuum-tube audio amplifier SE1000, 19  
 Vacuum-tube oscillator, 12  
 Vacuum-tube transmitters, 6, 9-10  
 VALDEZ, USS, 122  
 VALLEY FORGE, USS, 279  
 Vandenberg Air Force Base, Calif., 246  
 Vanguard satellite system, 91, 200, 246, 395-400, 409  
 Varhaug, Norway, 138  
 VC plan-position indicator, 194  
 VD plan-position indicator, 194  
 VE plan-position indicator, 194  
 Vectoring systems, aircraft, 190-192  
 Velocity-heading compensation, automatic, 288-290  
 Veracruz, Mexico, 18  
 Vertical, effective radiated power (VERP), 142  
 Very-high frequency (VHF)  
   aircraft systems, 98-99  
   first system, 96-99  
   radio communication in, 94-99  
 very low frequency (VLF), 21  
   absorption loss, 142  
   computer predictions of performance, 141-42  
   coverage predictions, 141-142  
   ionosphere penetration, 144  
   night attenuation rates, 140  
   propagation study, 138-142  
   radio-wave propagation, 138-142  
   radio communication parameters, 155  
   radio facsimile communication, 149  
   satellite transmissions, 144  
   sea penetration, 151  
   transionospheric propagation, 144  
   transmission in, 147-148  
 VF plan-position indicator, 194  
 VG plan-position indicator, 194  
 VH plan-position indicator, 194  
 Vibration-testing equipment, 63-64  
 Vietnam. *See* Southeast Asia areas  
 Viking rockets, 396-397  
 VIRGINIA, USS, 9  
 Virginia Capes, 14  
 VJ plan-position indicator, 194  
 VE plan-position indicator, 194  
 VL plan-position indicator, 194  
 VM plan-position indicator, 194  
 VN plan-position indicator, 194  
 Voice equipment, first, 14, 49  
 VP plan-position indicator, 194
- W2F aircraft, 209, 211, 389-390  
 Wahiaua naval radio station, 116-117, 122, 371, 372  
 WAINWRIGHT, USS, 132  
 Wake Island area, 286, 290  
 Waldorf Satellite Communication Research Facility, 123-125, 129,  
   133, 369  
 Wallops Island, Va., 109, 123  
 War Department, 173, 175, 223. *See also* United States Army  
 WASHINGTON, USS, 183  
 Washington astronomical observation station, 368

- Washington Channel area, 169  
 Washington Naval Air Station. *See* Anacostia Naval Air Station  
 Washington naval radio station, 8, 72, 76, 109, 116-117, 129, 133, 137, 351, 369  
 Washington Navy Yard, 5, 18, 51, 227, 267, 348  
 WASP, USS, 183  
 Water-cooled metal-anode tubes, 10-11, 15, 55  
 Waveguide feed, 198  
 Wavelengths  
   control, fixing and measuring, 6, 15  
   determining, 345, 361  
   dial calibration instituted, 18  
   first propagation formula, 15  
 Wavemeter, 346  
 Weapon systems  
   AN/AWG-9, 206  
   AN/AWG-10, 205  
   Polaris, 147, 241-247  
 Weather data collection and dissemination, 89-94, 396  
 Weather reports, first broadcasts, 24  
 Webster Field, Md., 93  
 WEST VIRGINIA, USS, 96, 183  
 Western Complex, 410  
 Western Electric Company, 17, 196, 203  
 Western Pacific area, 369  
 Western Test Range, 246  
 Westinghouse Electric Company, 67, 201, 204-205  
 Whistlers, 142-143  
 White, Edward D., 23  
 White Sands Missile Range, N. M., 246, 395  
 Whitney, William C., 27  
 WICHITA, USS, 196  
 Wide-aperture circular antenna, 314-315  
 Wide-aperture circularly disposed RDF, 311-315  
 Wilbur, Curtis D., 34, 70  
 WILLIS A. LEE, USS, 383  
 Wilson, Woodrow, 1, 11, 18  
 Winch-buoy assembly, 88  
 Window confusion device, 307, 338  
 Winkfield naval radio station, 144  
 Wireless Specialty Company, 18  
 Woomera, Australia, 144, 246  
 World War I  
   communications and equipment, 10-14, 16-21, 26-28, 47, 136, 151  
   electronic countermeasures in, 300  
   receiver equipment, 14  
 World War II  
   electronic countermeasures in, 300-307, 325  
   identification friend-foe, 253-255  
   ships in service, 63  
 Wright B-1 aircraft, 17  
 WRIGHT, USS, 85, 111, 130, 132-133  
 WS-434 space surveillance system, 398, 407-413  
 WV aircraft, 139-140, 209  
 WYOMING, USS, 24, 54, 86, 263, 375  
 XA transmitter, 54-55  
 XAB direction finder, 307  
 XAE radar, 251-252  
 XAF radar, 179-183, 193, 195, 251, 280, 377  
 XAR radar, 183-184, 186  
 XARD receiver, 301  
 XAS radar, 186  
 XAT radar, 201  
 XB transmitter, 55  
 XBF radar, 186  
 XBF-1 radar, 186  
 XBK jammer, 301  
 XCA jammer, 304  
 XCJ transmitter, 305  
 XCS shipboard receiver, 101  
 XCU transceiver, 101  
 XCV direction finder, 316, 318  
 XCY direction finder, 316, 318  
 XD transmitter, 53-54, 365  
 XDM submarine-rescue buoy, 114  
 XE transmitter, 55-56  
 XF transmitter, 54  
 XF-1 transmitter, 55  
 XJ-1 receiver, 96  
 XJ-2 receiver, 95-96  
 XK transmitter, 56  
 XM direction finder, 264  
 XP-1 transmitter, 95-97  
 XT aircraft communications system, 98  
 XV receiver, 96  
 XZ antenna diplex coupling, 84  
 YE direction finder, 272-274  
 YG direction finder, 273-274  
 YH beacon, 260  
 YJ beacon, 260  
 YL direction finder, 275  
 YN radio station, Lyons, 21  
 YN direction finder, 275  
 YORKTOWN, USS, 109, 183  
 Yosami naval radio station (NDT), 148, 368  
 ZB direction finder, 272-274  
 Ziegmeier, RADM H. J., 70  
 ZPG airships, 209-210