

INSTRUCTION BOOK

RESTRICTED

MODEL TDF  
RADIOTELEPHONE  
TRANSMITTING EQUIPMENT

NOMINAL POWER OUTPUT

125 Watts CW (A1)  
125 Watts MCW (A2)  
125 Watts Phone (A3)

TYPES OF EMISSION

CW Telegraphy (A1)  
MCW Telegraphy (A2)  
Telephony (A3)

FREQUENCY RANGE

2000 to 9400 Kcs

POWER SUPPLY

105-125 or 210-250 Volts  
50-60 Cycle, Single Phase

Manufactured for U. S. Navy Department, Bureau of Ships

- by -

**RADIOMARINE CORPORATION OF AMERICA**

75 VARICK STREET, NEW YORK, N. Y.

Contract NXs 9542 (Dated September 8, 1942)

August, 1943



7.2 - Component Units: The model TDF radiotelephone transmitting equipment consists of the following major component units:

- 1 CRM-52261 Radiotelephone Transmitter
- 2 CRM-23288 Control Units
- 2 CRM-51027 Hand Telephone Assembly
- 2 Type CQ Standard Telegraph Keys
- 1 Cat. 31322 DPST Fused Line Safety Switch
- 1 50 Ft. Length\*28 Conductor Cable
- 1 Set Transmitter Tubes
- 1 Set Type R-2 Quartz Crystals in holders (Crystal Frequencies as specified for particular installation)
- 1 Set Frequency Conversion Parts as in Tables II and IV
- 1 Lot of Spare Tubes and Spare Parts as in Table IV
- 2 Instruction Books

7.3 - Special Accessory Equipment: For installations where 50/60 cycle, single phase, power supply is not available, "Power Conversion Units" are required. Each power conversion unit consists of a motor generator set, motor starter, alternator field rheostat and alternator voltmeter.

Either one of the following four types may be furnished, if ordered. One type is designed for operation from a 220 volt, 25 cycle, 3 phase, power supply and delivers 2 K.W. single phase at 220 volts, 48 cycles. Another type is designed for operation from a DC power supply of 440 volts and delivers 2 K.W. single phase at 220 volts, 60 cycles. These power conversion units may also be ordered, if required, to operate from DC supply line voltages of 110/120 volts and 210/230 volts.

See separate instruction book for details on power conversion units.

7.4 - Power Output: The CRM-52261 radiotelephone transmitter is designed to deliver 125 watts of carrier power into an antenna of 200 mmfd. capacity, 16 ohms 2000 to 3050 KC and 24 ohms 3050 to 9400 KC. Modulation is substantially 100 per cent.

7.5 - Emission: The transmitter is designed to provide CW (A1), MCW (A2) and telephone (A3) emission. For MCW emission, a modulation frequency of approximately 600 cycles is employed, and the keying circuits are designed so that both carrier and modulation are removed in the "key up" condition. For telephone emission, the equipment is designed to provide good speech fidelity with the high grade commercial type carbon microphones that are supplied. Speech frequencies between 200 and 3500 cycles are transmitted with negligible attenuation.

7.6 - Frequency Range: The frequency range of the transmitter is 2000 to 9400 KC. There is provision for a total of six pre-tuned transmitting frequencies, any one of which may be quickly selected by means of the frequency switch on either

\*See W-603 Table II Sheet 12

CRM-23288 control unit. The equipment as ordered may be shipped with all six operating frequencies at any frequency in the band 2000-3050 KC or with three frequencies at any frequency in the band 2000-3050 KC and three frequencies (in the band 2750-9400 KC) with one frequency 2750-5000 KC, one frequency 3750-5500 or 7000-9400 KC and one frequency 5000-9400 KC. Additional coils are provided with each equipment so that conversion may be made in the field for either arrangement. See Section X "Instructions for Frequency Conversion" and Drawing T-1200.

7.7 - Frequency Control: Each of the six output frequencies of the radio transmitter is controlled by means of quartz crystals mounted in suitable holders. Low temperature coefficient crystals ground to a tolerance of plus or minus .01 per cent are used.

7.8 - Control Units: Two control units, each CRM-23288, are furnished with each transmitter to permit selection of transmitting frequencies and control of other circuit functions. Each control unit contains a six position frequency switch, six frequency indicator lamps, a stand-by OFF-ON switch, a carrier OFF-ON switch and an emission switch for selecting CW, MCW or phone. A small rectifier using a 6X5GT vacuum tube is built in each control unit and furnishes energy for actuating certain relays in the radio transmitter, as described in detail further in this book. Two frequency marker plates for frequencies as ordered are supplied with each crystal, six of which plates are to be selected at time of installation and fastened on each control unit. A #28 conductor color coded, rubber covered cable is used to connect each control unit to the radio transmitter. 16 conductors are actually used in this cable, the remaining conductors being reserved as spares.

7.9 - Hand Telephone Assembly: Two CRM-51027 hand telephone assemblies are furnished with each equipment, one hand telephone assembly being used with each CRM-23288 control unit. Each hand telephone assembly consists of a type 302-AW-3 (HS-40L,50L) desk stand, modified, and a type F3AW3 "Press-to-Talk" handset. The cord from the handset terminates in a four point plug which is inserted in a four point jack on the desk stand. The "Press-to-Talk" push-button in the handset, when closed, places the carrier on the air.

7.10 - Vacuum Tubes: A total of twenty vacuum tubes are used in the CRM-52261 transmitter as follows:

- 6 Type A-4154-D Crystal Oscillator Tubes
- 1 Type 813 Power Amplifier Tube
- 2 Type 811 Class B Modulator Tubes
- 2 Type 6L6G Audio Amplifier Tubes
- 4 Type 83 Bias Rectifier Tubes
- 2 Type 83 Low Voltage Rectifier Tubes
- 1 Type 6L6G Audio Oscillator Tube
- 2 Type 866A/866 High Voltage Rectifier Tubes

Each CRM-23288 control unit uses one type 6X5GT rectifier tube.

\* - See W-603 Table II Sheet 12



7.11 - Power Supply: The radio transmitter and control units are designed to operate from a basic power supply of 105/125 volts, or 210/250 volts, 50/60 cycles, single phase, AC. The radio transmitter is provided with a built-in matching transformer designed with two tapped primary windings so that the primaries may be connected in series or parallel, and the correct primary taps selected to accommodate the power supply voltages listed above. The secondary winding of the matching transformer is designed to deliver 220 volts, single phase, AC to the transmitter proper. The rectifier transformer in each control unit has a double primary with taps for series or parallel connection to also accommodate the power supply voltages listed above.

The total AC power required for the equipment is approximately as follows:

Each CRM-23288 Control Unit - 15 watts.

The CRM-52261 radio transmitter requires the following power under the conditions listed below:

Stand-by - 600 watts

Carrier "on", no modulation or CW, key closed -  
800 watts

MCW, key closed - 1000 watts

Phone, 100 per cent modulation - 1000 watts

7.12 - Dimensions and Weights: CRM-52261 Radiotelephone Transmitter -  $61\frac{1}{4}$  inches high, 34 inches wide and 20 inches deep. The front panel doors swing through a radius of  $15\text{-}\frac{3}{8}$  inches. The weight of the transmitter is 690 pounds.

CRM-23288 Control Unit -  $8\frac{1}{4}$  inches high, 14 inches wide,  $9\frac{1}{4}$  inches deep. The front panel of this unit swings through a radius of  $7\text{-}\frac{3}{4}$  inches. The weight of each control unit is 16 pounds.

CRM-51027 Hand Telephone Assembly -  $5\frac{1}{2}$  inches high, 9 inches wide and  $7\frac{1}{2}$  inches deep. The weight is 5 pounds.

Catalog 31322 Fused Line Switch -  $7\frac{1}{2}$  inches high,  $6\frac{1}{2}$  inches wide and 4 inches deep. The door on this unit swings through a radius of  $7\text{-}\frac{3}{4}$  inches. The weight is  $4\frac{1}{4}$  pounds.

Type CQ Telegraph Key -  $1\text{-}\frac{3}{8}$  inches high,  $2\text{-}\frac{7}{8}$  inches wide and  $5\frac{1}{2}$  inches deep. The weight is  $\frac{1}{3}$  pound.

The total weight of the spare parts is approximately 390 pounds. The total weight of complete TDF radiotelephone transmitting equipment with spares is approximately 1135 pounds.

7.13 - Antenna Characteristics: The model TDF radiotelephone transmitting equipment is designed for operation with a simple quarter wave antenna and a suitable ground system. The antenna may consist of a single wire having an overall length, including lead-in, of approximately 50 to 65 feet. The antenna



may be of any convenient height, although as high as possible, and may be vertical, horizontal or sloping. The equipment should be located on the ground floor of the radio station and a very short ground lead employed. The ground lead should be not more than 15 feet for proper transmitter operation. A good low resistance ground system is essential. If moist soil is available, a buried ground plate of copper having an area of at least 36 square feet should be placed in the ground several feet deep as near to the transmitter location as possible, and connected to the transmitter ground terminal with large copper straps or copper conductor not less than "0" American Wire Gauge (105,500 Circular Mils). The ground conductor should be brazed or soldered to the ground plate for a length of at least 12 inches to insure a good connection which will not corrode in a short time. If the station has available one or more buried water pipes or similar structures, such pipes may be used for a ground connection.

For installations where the soil under the antenna is of a sandy or dry nature, it may be necessary to install buried counterpoise wires in shallow trenches. Such wires should preferably be installed so that they are approximately 5 feet apart and cover a ground area considerably greater than the area directly underneath the antenna. If desired, in the case of vertical or sloping antennas, the counterpoise system may consist of a radial grouping of wires, like spokes on a wheel, with each radial wire 150 to 200 feet in length.

The total length of the antenna, including lead-in, may have to be extended or shortened to secure correct resonance for frequencies at each end of the 2000-3050 and 3050-9400 KC bands, as described further under "Transmitter Adjustments," Section XI.

### VIII. CIRCUIT DESCRIPTION

8.1 - An understanding of the various circuits employed in the model TDF radiotelephone equipment is best obtained by considering the circuits in the following categories:

- Radio Frequency Circuits
- Audio Frequency Circuits
- Power Supply and Relay Circuits
- Metering Circuits
- Control Unit Circuits

8.2 - Radio Frequency Circuits: Refer to schematic diagram T-1188. Parts are identified throughout using standard Navy "Symbol Designations". The basic radio frequency circuits consist of a type A-4154-D crystal oscillator tube (V-101-106) and a type 813 power amplifier tube (V-107). Actually, there are six A-4154-D crystal oscillator tubes, but only one of these tubes is used at a time when transmitting on any one of the six frequencies. Type R-2 crystals are used, six crystals total, and each crystal mounts in jacks (J-101-106) directly in front



of its respective oscillator tube. Two small padding capacitors (C132-143) and a grid leak (R149-154) are all connected in parallel across the crystal as shown on T-1188.

The plate circuit of each crystal oscillator tube is provided with a tuned tank circuit consisting of a fixed inductor (L107-112) and a variable capacitor (C126-131). The variable capacitor is coupled through a shaft to the oscillator tuning dial (N101-106), and a lock is provided for this dial. A small amount of capacitative feedback for each crystal oscillator circuit is provided by means of a few turns of wire connected to the grid of the tube, which are wound around the lead to the plate of the tube. -

Mounted behind each crystal oscillator tube is a double-pole double-throw relay (K107-112). One pole of this relay is used to energize the filament circuit of the tube, while the other pole connects the high side of the oscillator tank circuit to the control grid of the power amplifier tube. The back contact of the latter pole short-circuits the oscillator tuned circuit when the relay is de-energized. When a particular frequency is selected, the appropriate crystal oscillator relay is energized permitting that tube to function. The DC plate supply for the crystal oscillator tubes is obtained from the low voltage rectifier which uses two type 83 tubes (V114-115). The DC supply for the screens of the oscillators is obtained from a tap on the voltage divider network of the low voltage rectifier (Resistors R-115-116-117).

The power amplifier tube receives its radio frequency grid excitation, through the respective oscillator relay and then through coupling capacitors (C125 or C148), as shown on Diagram T-1188. The plate of the type 813 power amplifier tube is connected through a coupling capacitor (C116), through power amplifier circuit relays (K101-106), and thence to an adjustable slider (red) on the antenna loading inductor (L101-106). The other slider connects to relay (K101-106) for 2000-3050 KC operation or to Antenna Variable Series/Coupling Capacitors for 2750-9400 KC operation. Each power amplifier relay (six in number for the six frequencies) is a double-pole double-throw unit, one pole connecting the power amplifier and the other pole the antenna to the respective power amplifier-antenna circuits.

The DC supply for the type 813 power amplifier tube is obtained from the high voltage rectifier which uses two 866A/866 tubes (V112-113). The supply from this rectifier passes through one of the secondary windings of the modulation transformer (T103), then through the P.A. plate chokes (L129 and L123), through a parallel combination of parasitic choke and resistor (L122) and finally to the power amplifier plate.



The transmitter is provided with an antenna grounding relay (K113), double-pole single-throw, with the two poles connected in series as shown. This relay, when de-energized, places a ground on the antenna, which is the condition when no power is applied to the transmitter.

8.3 - Audio Frequency Circuits: For telephone communication, the audio frequency circuits begin at the microphone in the handsets (HS402-HS502) of each hand telephone assembly. The negative side of the 40 volt output of the bias relay rectifier circuit furnishes DC microphone voltage through reactor (L124), 500 ohm resistance (R145 and R164 in parallel) and reactor (L125). A shunting resistor (R146) of 2000 ohms is connected in parallel to the microphone. The audio voltage developed by the microphone is applied to the primary windings of microphone transformer (T105) through a blocking capacitor (C113). The high or ungrounded side of the microphone passes through contacts on control relay (K120 or K121), the test push-button (S105) and emission relay (K119).

The primary of the microphone transformer (T105) consists of two windings which are connected in parallel. The secondary of this transformer also has two windings which are connected to the control grids of the push-pull 6L6G audio driver tubes (V110-111). The plate circuit of the driver tubes connects to the primary of driver transformer (T104), while the secondary winding connects to the grids of the push-pull type 811 modulator tubes (V108-109).

The modulation transformer (T103) has its primary winding connected to the plates of the type 811 tubes. There are two secondary windings of the modulation transformer (T103), one of which is in series with the DC plate supply to the type 813 power amplifier tube (V107). This secondary winding modulates the power amplifier tube plate circuit in the conventional manner. To suppress undesired high audio frequencies as well as parasitics, a resistor capacitor circuit (R118-119-120-121 and C117) is connected in parallel to this secondary winding. The other secondary winding of the modulation transformer is not used in this transmitter.

The screen grid of the type 813 power amplifier tube is connected to its DC supply source on the low voltage rectifier voltage divider (R115-116-117) through an iron core inductor (L120), which permits the voltage on the screen to rise and fall at an audio rate during modulation. The screen of the power amplifier tube is provided with a parallel parasitic resistor inductor network (L121), the usual radio frequency by-pass capacitor (C124), the latter being connected between screen and ground, and a series screen dropping resistor (R132).

For MCW telegraph operation a 6L6G audio frequency oscillator tube (V120) and its associated audio transformer



(T109) are used to deliver audio frequency at approximately 600 cycles to the primary of the microphone transformer (T105). A relay (K119), whose coil is actuated through the "MCW-Phone" switch on the control units, is employed to close the cathode circuit of the 6L6G audio oscillator (V120) and to open the microphone circuit for A2 emission. The contacts on this relay perform reverse functions for A1 or A3 transmission.

The DC plate supply for the type 6L6G driver tubes is obtained from the output of the low voltage rectifier tubes (V114-115). The screens of these tubes obtain their DC power supply from a tap on the voltage divider of the low voltage rectifier (R115-116-117). The DC supply for the plate circuit of the type 811 modulator tubes is obtained from the high voltage rectifier tubes (V112-113). The DC plate and screen supply for the 6L6G audio oscillator is obtained from the low voltage rectifier output.

**8.4 - Keying:** The radio transmitter is keyed for CW, for MCW or phone by means of relay (K114). The coil of this relay is controlled either by the push-button (S401-501) in the handset or by the telegraph key (K601-602), or by the carrier switch (S203-S303), coil energy being obtained from the bias rectifier. When the front contact of relay (K114) is closed (coil energized) it short-circuits resistor (R114) thereby removing cut-off bias from the tubes used in the oscillator, power amplifier, driver and audio oscillator. The back contact of the relay (coil de-energized) short-circuits the carrier lights on the control units. These lights receive their supply through a resistor (R208-308) so that, when the light is shorted, the resistor limits the current. Therefore, each time relay (K114) is energized, the carrier is placed on the air and the carrier lights are illuminated.

For keying the transmitter directly at the set and for connecting the handset locally, a test push-button (S105) and a microphone receptacle (J107) are mounted in the forward section of the transmitter. Closing the test push-button applies plate power to the transmitter by short-circuiting the interlocks, and also energizes the keying relay and transfers the microphone circuit to the receptacle adjacent to the test push-button.

**8.5 - Power Supply and Relay Circuits:** Refer to diagrams T-1188 and T-1189. The incoming 105/125 or 210/250 volt, 50/60 cycle, single phase power supply, or the 220 volt, 48/60 cycle power supply from power conversion units is connected to the external main line fused switch (S601) catalog 31322. The power circuit, after passing through this switch, is then connected to the pair of terminals marked "IN" on the matching transformer (T110) in the transmitter. The two primary windings, with their taps, are to be connected on installation to match the supply voltage as shown on drawing T-1190.

The secondary ("Out" terminals) of the matching transformer (T110) delivers 220 volts and then is connected through the various power relays to apply power to the primaries of the several transformers.

The sequence of operation of the various power supply relays is as follows:

When the "Stand-by" control switch (S202-302) on either control unit is placed in the "On" position, this energizes the primary of the 6X5GT rectifier transformer (T201-301) in that control unit. The filtered output of the control unit rectifier energizes the coil of the control relay (K120-121) in the transmitter which is associated with the respective control unit. The control relay coil is connected in series with the filament control relay (K116) in the transmitter. One pole of this relay energizes the time delay unit motor (B101) (a part of time delay unit E101). The second pole energizes the filament contactor (K117), thereby applying voltage to the primaries of filament transformers (T101 and 106) and meter (M104). After the contacts on the time delay unit (E101) have closed, they apply power to the primary of transformer (T108) which applies plate voltage to the four type 83 bias relay rectifier tubes (V116-119). As soon as the bias relay rectifier delivers output voltage, this permits current to flow through the interlocks (S102-103-104) on the transmitter cabinet to the coil of plate control relay (K115). One pair of contacts on this relay energizes the coil of relay (K118) and the contacts of relay (K118) apply power to the primary of the low voltage rectifier transformer (T107) and the high voltage rectifier plate transformer (T102). An analysis of the circuit arrangement described above will, therefore, show that plate power cannot be obtained until after the time delay unit has closed its contacts and the bias relay rectifier has delivered its output voltage. Failure of bias supply, therefore, automatically removes plate voltage and protects the tubes. The time delay unit is normally adjusted for a time interval of approximately thirty seconds in order to permit the filaments of the rectifier tubes to reach operating temperature before application of plate voltage.

Control relays (K120-121) have their coil circuits energized by the respective 6X5GT rectifiers in each control unit. The contacts on these relays are so interlocked with their coil circuits so that if, for example, relay (K120) is in use, relay (K121) cannot be energized. This arrangement prevents a party at one control unit from interrupting the circuit in the event that a party at the other control unit is using the equipment. However, the frequency indicator lights (I201-206 and I301-306) and carrier light (I208-I308) on the control unit not in use will be illuminated when the other



control unit is in use, thereby giving warning to anyone who attempts to use one control unit when the other is already in service. The stand-by light (I207-I307) on the unused control unit will be illuminated if the frequency switch (S201-S301) on that unit happens to be in the same position as the frequency switch on the control unit in use.

The six position frequency switch on each control unit, switches (S201 and S301), are used to energize the oscillator relays (K107-112) and power amplifier relays (K101-106). For example, if the frequency switch on control unit #1 is placed in position 1, this energizes oscillator relay (K107) and power amplifier relay (K101). Coil energy for these relays is obtained from the DC output of the bias-relay rectifier. To minimize sparking on oscillator and P.A. relays if the frequency is changed with carrier on, these relay coils are connected in series with the coil of plate control relay (K115).

The coil of the antenna grounding relay (K113) is energized at all times whenever the bias relay rectifier delivers output voltage, thereby removing the ground from the antenna when the transmitter is in operation.

8.6 - Metering Circuits: The transmitter is designed with four meters in the upper section of the front panel. The first meter at the left (M101), marked "Antenna Current," is a 0-8 ampere R.F. meter for indicating antenna current. This meter is in the "hot" or high side of the antenna, and is, therefore, separately insulated from the panel by the means of a Mycalex support.

The second meter from the left (M102), marked "Current", is used in connection with the meter switch (S101). The meter is a 0-50 m.a. DC instrument. The meter switch has six positions and is provided with six shunts (R101-106) mounted directly on the switch so that the various currents outlined below may be read.

Important: Meter scale reading must be multiplied by 10 on position 1, 2 and 3. For example, on any of these three positions if meter reads 20, actual current is 200 m.a.

<u>Meter Switch Position</u>	<u>Current</u>
1	Power Amplifier Cathode
2	Modulator Cathode
3	Audio Frequency Amplifier Cathode
4	Radio Frequency Oscillator Cathode
5	Audio Frequency Oscillator Cathode
6	Power Amplifier Grid

The normal values of current that are obtained are listed under "Installation Adjustments".

The third meter from the left (M103), marked "Filament Voltage", is rated 0-250 volts AC, and is used to adjust the filament voltage to its normal value of 200 volts. This 200 volt value is that applied to the primaries of the two filament transformers and is adjusted by means of the filament rheostat (R163).

The fourth meter (M104), marked "AC Voltage", is a 0-250 volt AC instrument and indicates AC voltage which will normally be 220 volts. This voltmeter is connected across the secondary of the matching transformer, and is to be used for selecting the correct matching transformer primary taps, during installation, and for routine checking under normal operation.

8.7 - Control Unit Circuits: The six frequency-indicator lights (I201-206, 301-306) on each control unit are mounted directly above their respective frequency marker plates so as to permit convenient observation of the frequency which is selected. These indicator lights are energized at the same time and from the same voltage source as the respective oscillator and power amplifier relays.

The stand-by light (I-207,-307) on each control unit is energized also from the source for the oscillator and power amplifier relays. The "Carrier" ON-OFF switch (S203-S303) is connected in parallel to the push-button on the handset and short-circuits this push-button in the "ON" position. This is useful in cases where relatively long telephone transmissions of a one way nature are being carried out.

The emission switch (S204-S304) on the control unit controls relay (K119) in the transmitter to permit selection of CW (A1), MCW (A2) or phone (A3) emission.

## IX. INSTALLATION AND CONVERSION OF FREQUENCIES 1, 2 & 3

9.1 The CRM-52261 transmitter should be installed in such a manner that there is liberal access on the front, sides and rear. The access doors on the front require a clearance, when opened, of approximately 16 inches. A space of at least 30 inches on either side of the transmitter and a space of not less than 20 inches at the rear of the transmitter is recommended to permit removal of the side and rear panels for service and maintenance.

9.2 All tubes, with the exception of the 813 power amplifier tube, are accessible through the front access doors. The 813 power amplifier tube is accessible through a small door in the upper left side of the cabinet. The transmitter should be firmly bolted to the floor of the station using four lag screws,  $\frac{1}{2}$  inch diameter and  $2\frac{1}{2}$  inches long. These screws hold down the transmitter through the mounting brackets at the base of the cabinet. These mounting brackets are



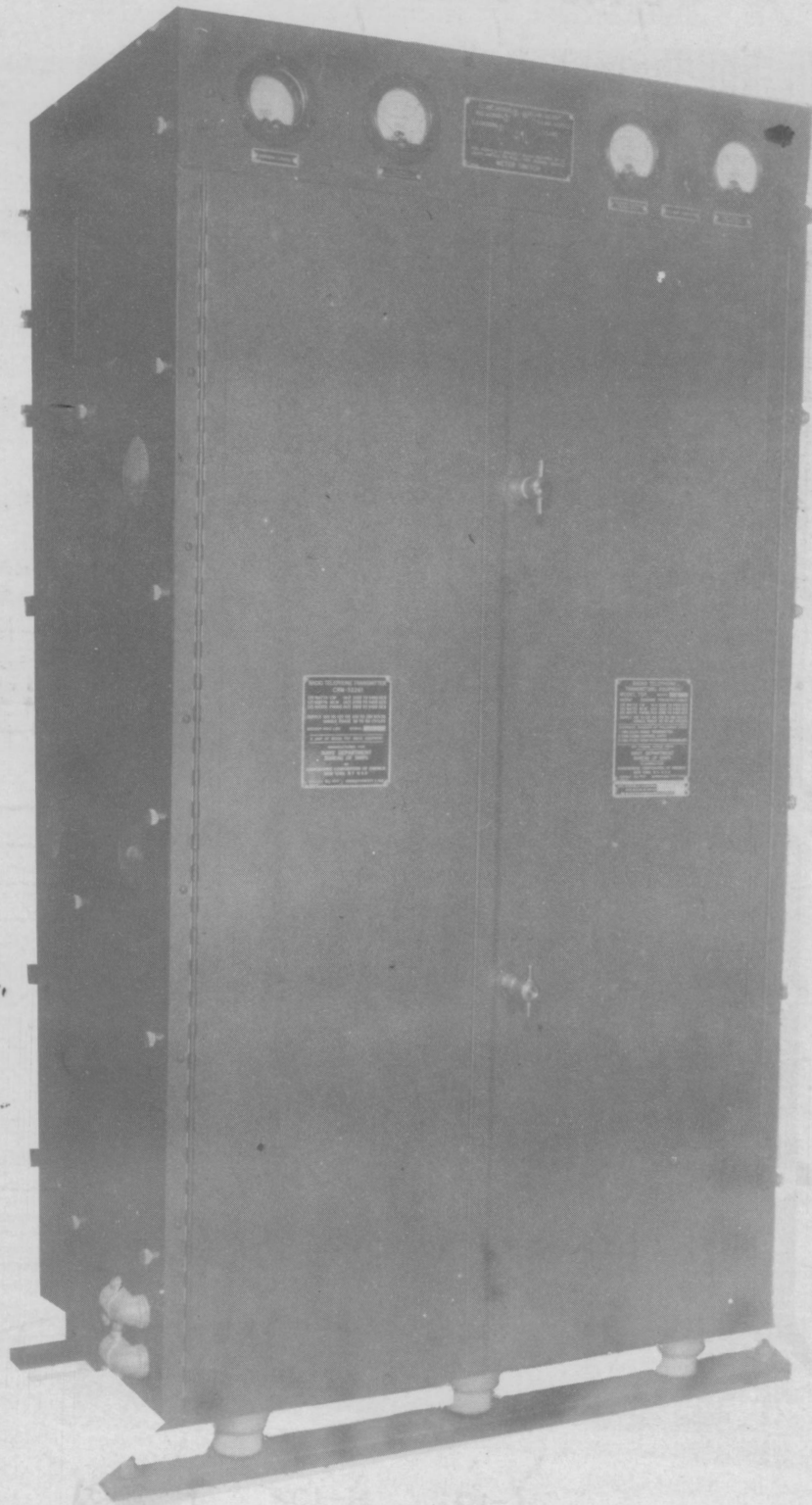

FIG. 1 CRM-52261 TRANSMITTER

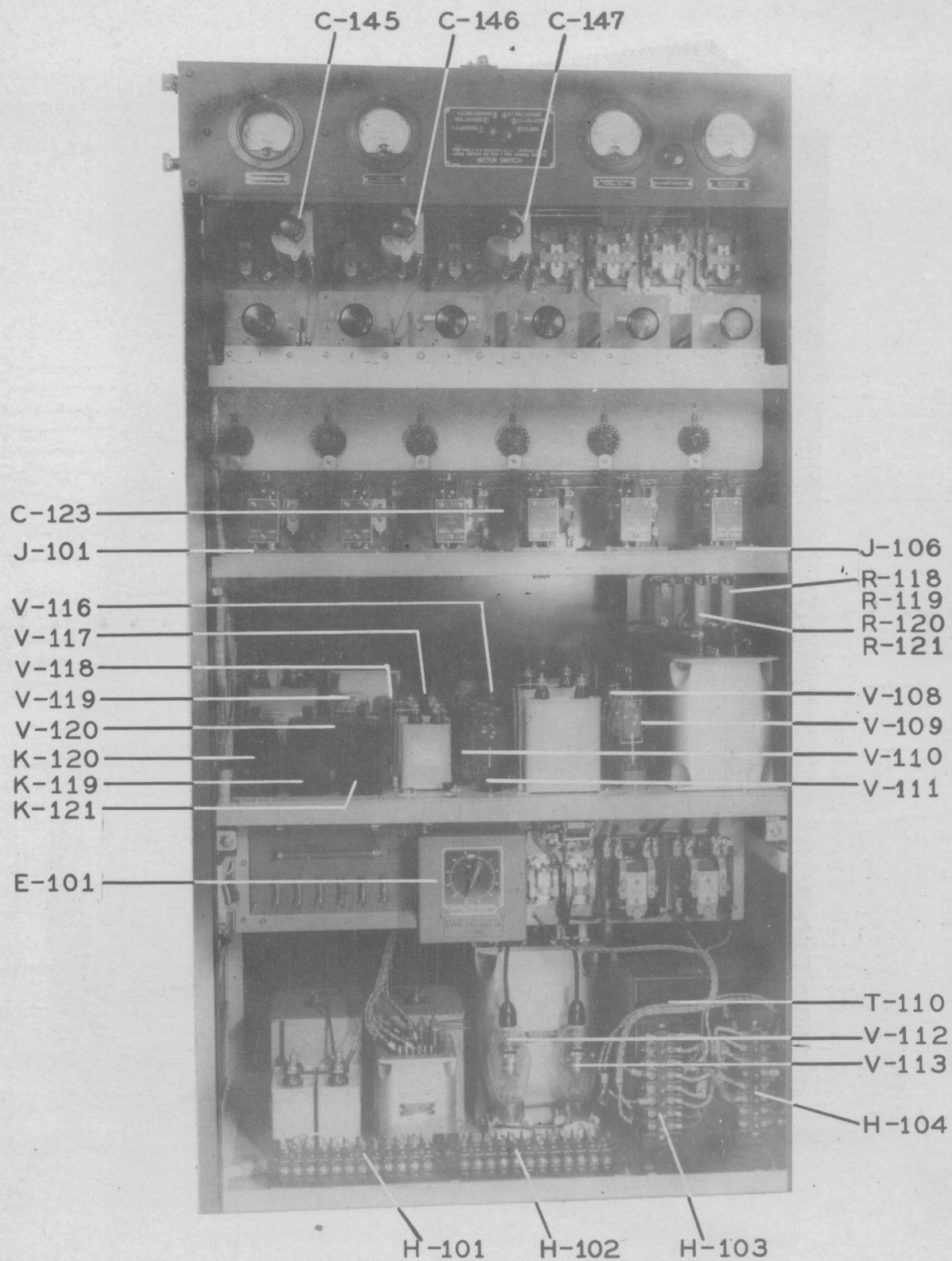

FIG. 2 CRM-52261 TRANSMITTER



L-126

K-101

C-145

V-107

S-102

L-101-B

L-121

C-126

L-107 B

K-107

V-101

R-124

J-101

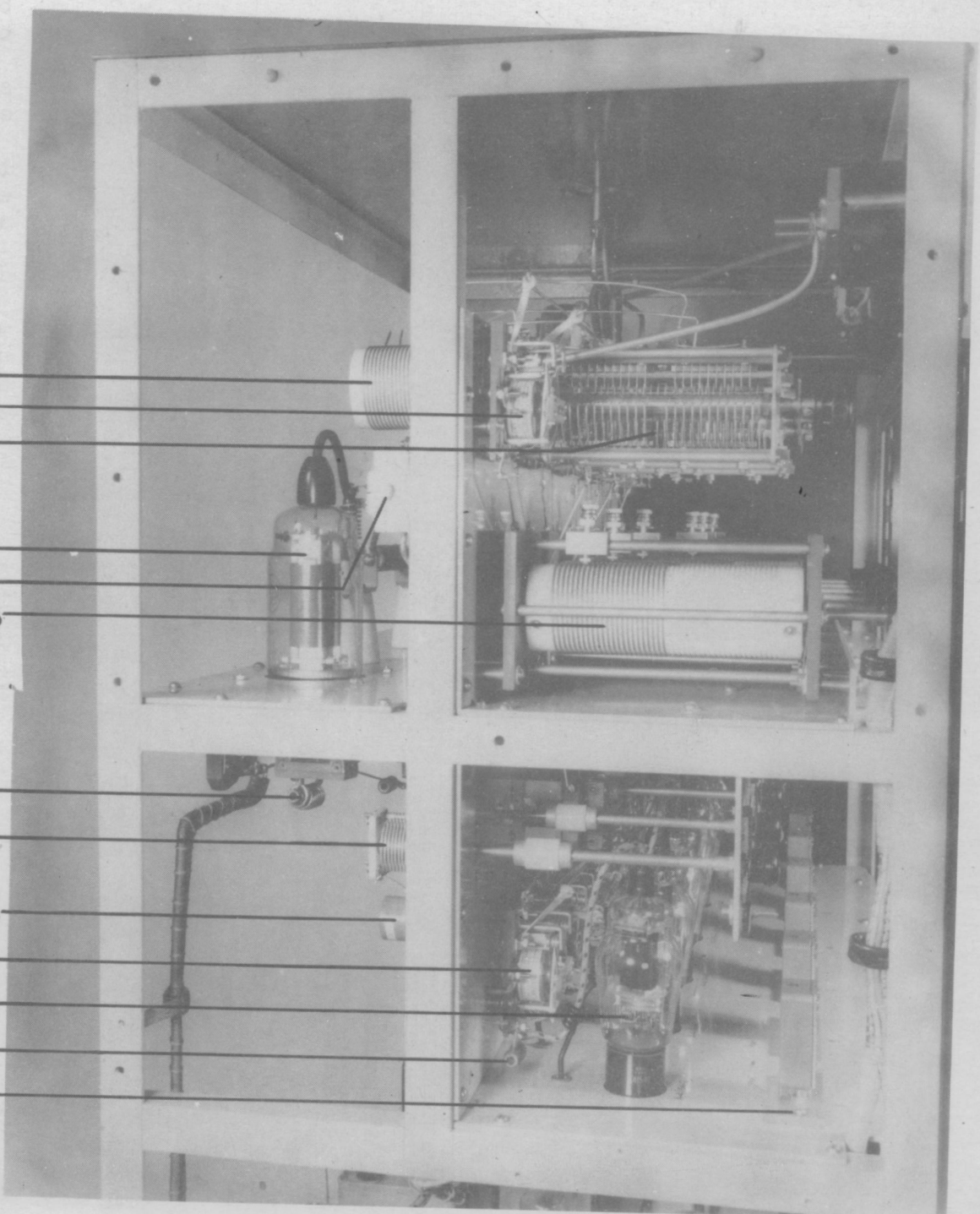

FIG. 4 CRM-52261 TRANSMITTER

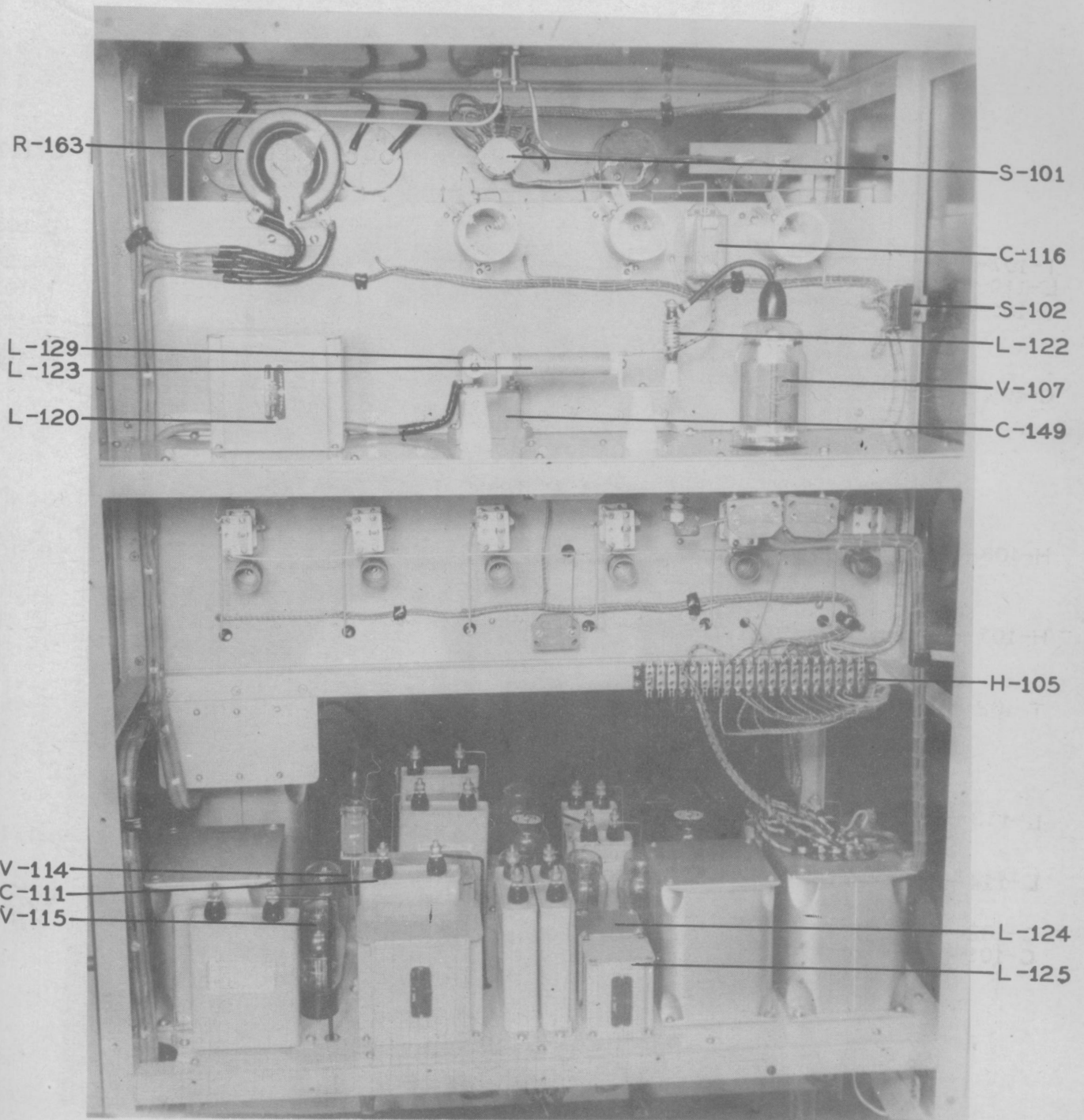
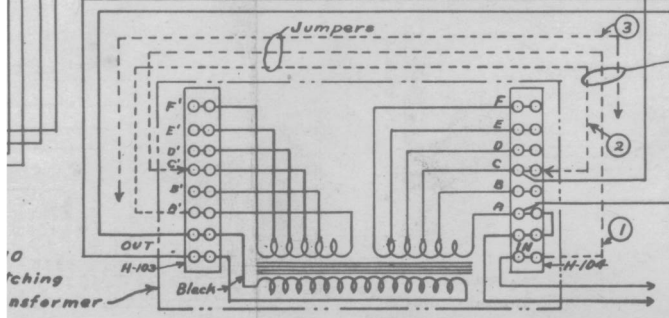
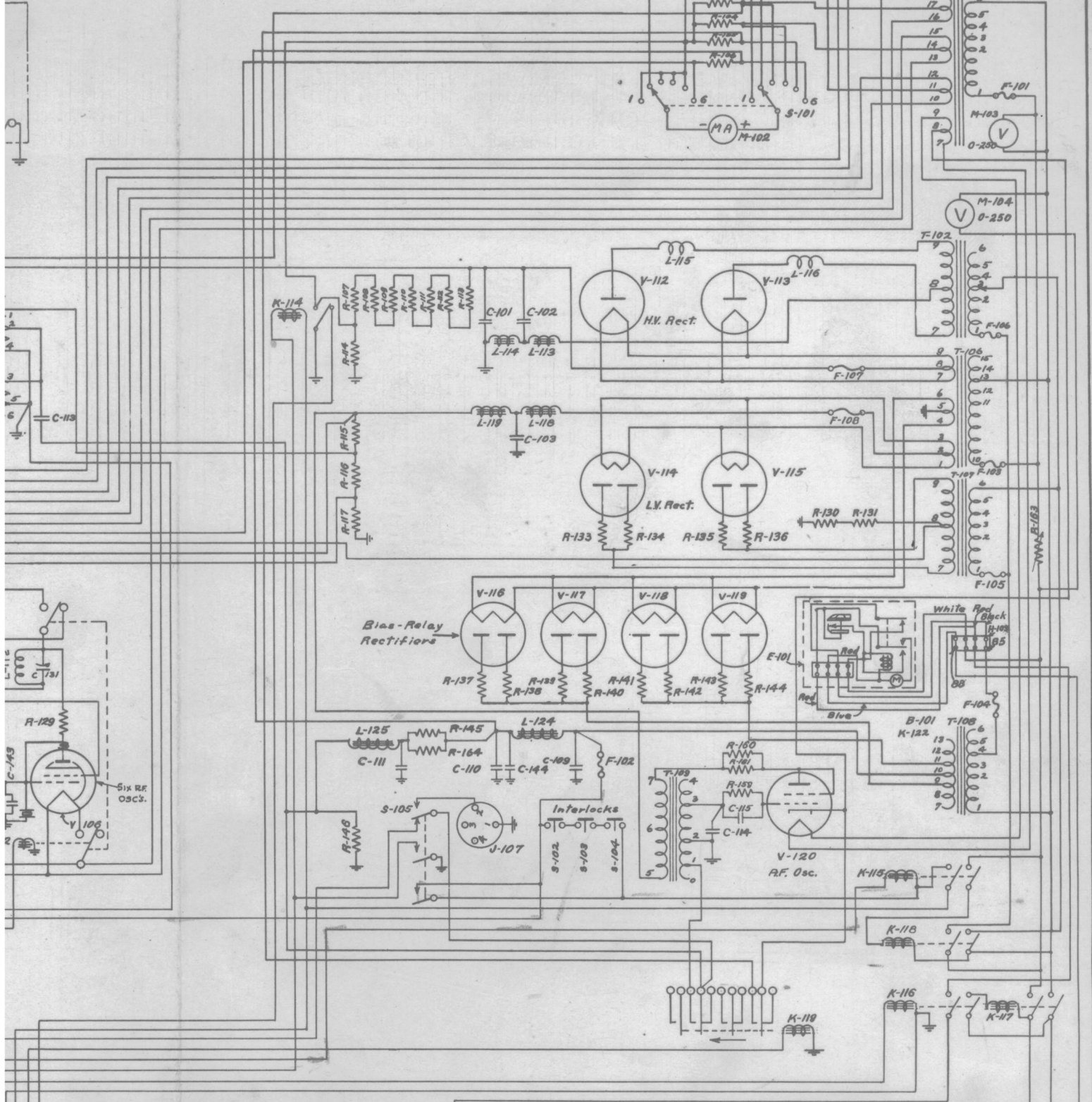

FIG. 6 CRM-52261 TRANSMITTER



FREQUENCIES OF 2000 TO 3050 K.C. FOR OTHER FREQUENCIES, SEE DIAGRAM T-1200.

ANT.



Jumpers shown Connected for 220 V.A.C. Input

To Main Line Switch, See Dwg. 1189 and 1190

**RESTRICTED**

**SCHEMATIC CIRCUIT DIAGRAM CRM-52261 TRANSMITTER A UNIT OF MODEL TDF RADIO TELEPHONE EQUIPMENT**

**RADIOMARINE CORP. OF AMERICA**

ENGINEERING DEPT.  
NEW YORK

by S.S. Traced by A.S.K.  
Sub. DX 2845

**T-1188**  
Date 5-21-42

NOTE: ANTENNA CIRCUIT CONNECTIONS SHOWN FOR FREQUENCIES OF 2000 TO 3

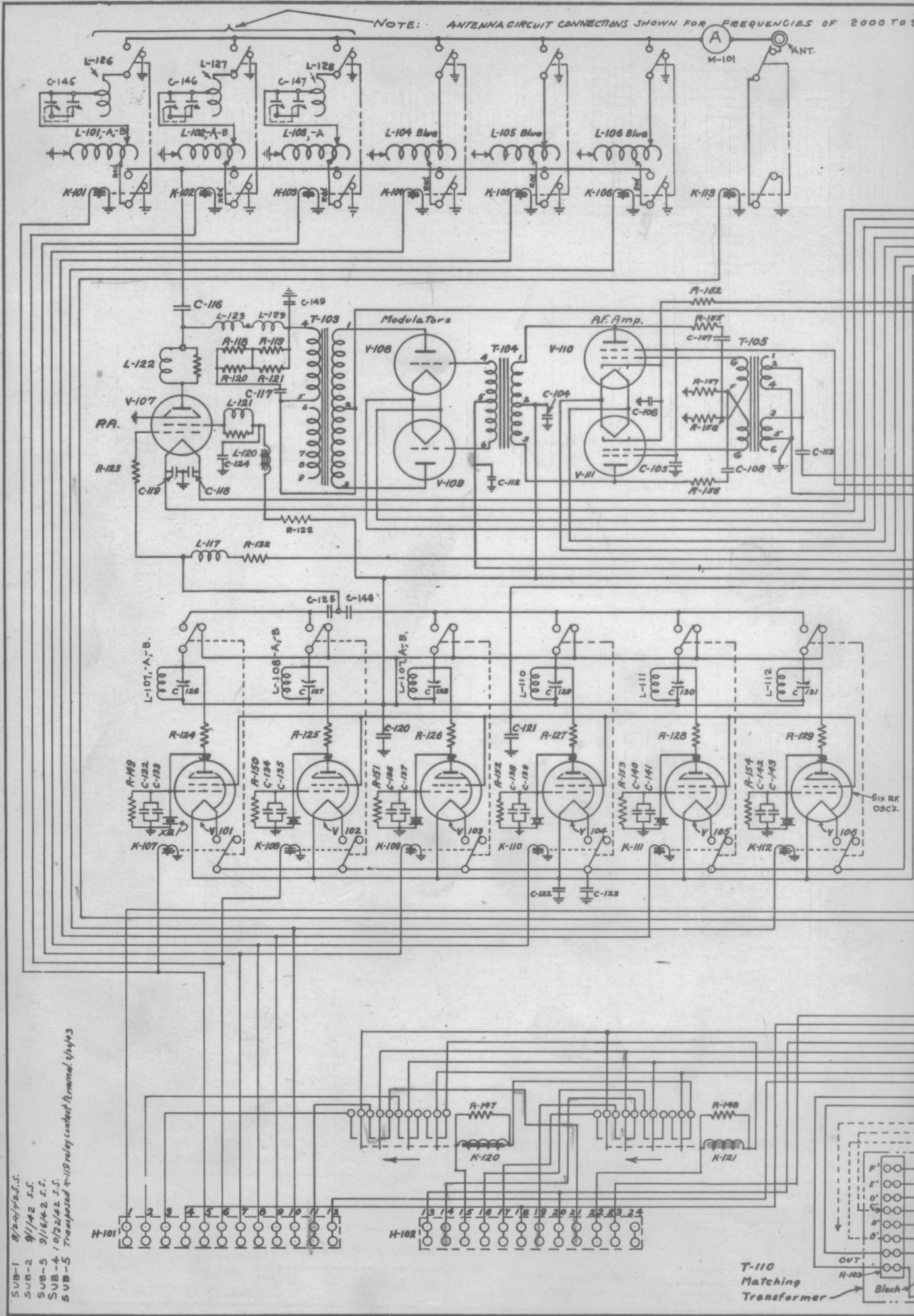

SUB-1 8/24/42 S.S.  
 SUB-2 9/1/42 S.S.  
 SUB-3 9/16/42 S.S.  
 SUB-4 10/22/42 S.S.  
 SUB-5 Transposed 4-119 relay contact terminals 2/24/43

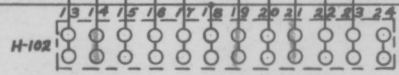
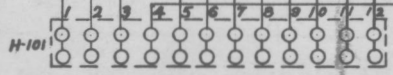

T-110  
 Matching  
 Transformer

