

36

QUESTION #1. What is meant by coupled circuits?

ANSWER #1. Two circuits are said to be coupled when there is a transfer of energy from one to the other. There are three ways of accomplishing this; by electromagnetic induction, by electric induction, and by resistance coupling. Besides these three, coupling is divided into two classes, whether resistance, electromagnetic, or electric coupled. The two classes are: direct and indirect coupling. If the coupling element is common to both circuits, whether it is resistance, inductance, or capacity, the circuit is said to be directly coupled. Indirect coupling is accomplished between circuits by magnetically coupling the inductances of each circuit, or by capacitive coupling using condensers between the circuits.

QUESTION #2. Show sketches of methods of accomplishing direct coupled and indirect coupled circuits.

ANSWER #2.

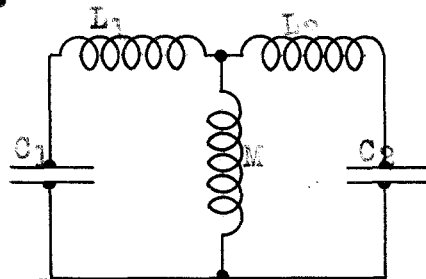

Sketch 1. Direct coupling by inductance.

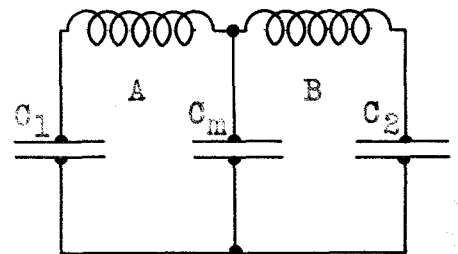

Sketch 2. Direct coupling by capacity.

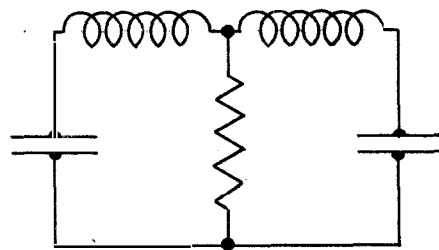

Sketch 3. Direct coupling by resistance.

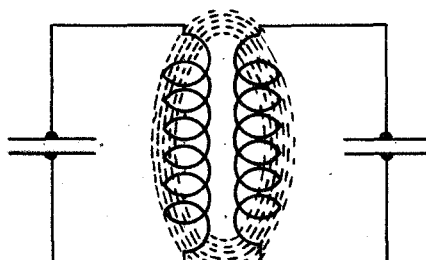

Sketch 4. Indirect coupling by inductance.

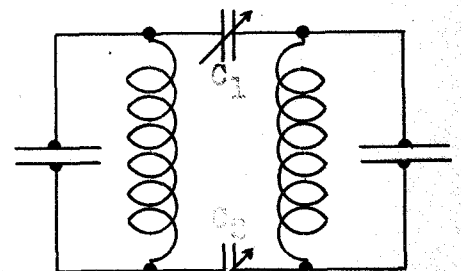

Sketch 5. Indirect coupling by capacity.

QUESTION #3. How is transfer of power affected when varying the coupling of indirect coupled circuits?

ANSWER #3. In an indirectly coupled (electromagnetic) circuit the amount of power that is transferred from one circuit to the other is directly proportional to the distance between the two inductances (sketch 4) that is, the closer the inductances the greater the power transfer; the further apart they are, the less is the power transfer. In an indirectly coupled (capacitive) circuit the transfer of power is proportional to the value of the condensers used. If the values of the coupling capacities are increased, the power transfer will be increased; if the values are decreased, the power transfer will be decreased. The condition of maximum power transfer in both cases is referred to as tight coupling and the condition of minimum power transfer as loose coupling.

QUESTION #4. What effect has tight and loose coupling on resonance and frequency?

ANSWER #4. If the coupling between two circuits is loose, each circuit will be resonant to one frequency, while if the coupling is tight, each circuit will be resonant to two frequencies, one frequency being lower than the original frequency and the other being higher than the original frequency. The difference in frequencies is dependent on the degree of coupling. Sketch 6, below, shows the resonance curve for a loosely coupled circuit and sketch 7, below, shows the same circuit when tightly coupled. The two circuits are resonant to two frequencies, when tightly coupled, because the mutual inductance of the circuits momentarily adds or subtracts from the inductances of each circuit. The value of the inductance in each circuit varies momentarily and the circuits are resonant to two frequencies. The difference in the two frequencies depends on the value of mutual inductance or, on the coupling between the circuits.

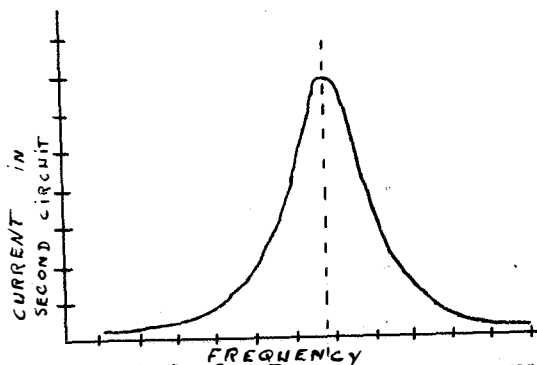

Sketch 6. Resonance curve for loosely coupled circuit.

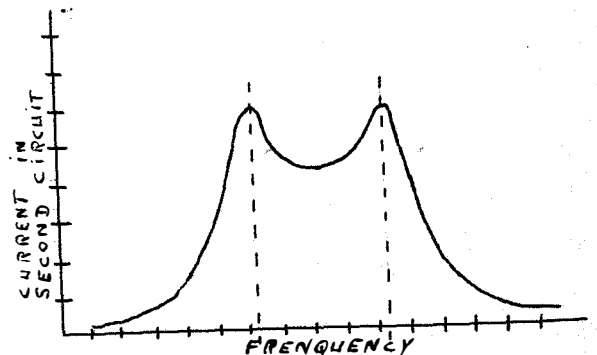

Sketch 7. Resonance curve for tightly coupled circuit.

QUESTION #5. Explain the transfer of power in direct capacitive circuits.

ANSWER #5. Sketch 2, shows the direct capacitive method of coupling two circuits together. The amount of power that is transferred from one circuit to the other is controlled by the coupling condenser  $C_m$ . If the value of  $C_m$  is increased the amount of power that is transferred will be reduced and if the value of  $C_m$  is reduced the power transfer will be increased. This is the exact opposite of an indirectly capacitive coupled circuit where the value of the coupling condensers is directly proportional to the power transfer. The formula for finding the coupling coefficient of the directly capacitive coupled circuit is as follows:

$$k = \sqrt{\frac{C_1 C_2}{(C_1 + C_m)(C_2 + C_m)}}$$

Where:  $k$  = coupling coefficient in percent.

$C_1$  = condenser in circuit A.

$C_2$  = condenser in circuit B

$C_m$  = coupling condenser between circuits.

QUESTION #6. Draw sketch and briefly explain a combination of both capacitive and inductively coupled circuits.

ANSWER #6. In sketch 8, below,  $L$  and  $L_1$  are coupled inductively while the two circuits, A and B, are coupled by the capacity  $C_3$ . When the induced currents due to the two kinds of coupling are in phase the coupling is increased; when the induced currents are out of phase the coupling is reduced in proportion to the difference in currents. The change in position of  $L$  and  $L_1$ , and also the method of winding of the inductances will produce currents which will differ in phase with the current due to capacitive coupling. Much trouble is met with when using two types of coupling, so this method is seldom used.

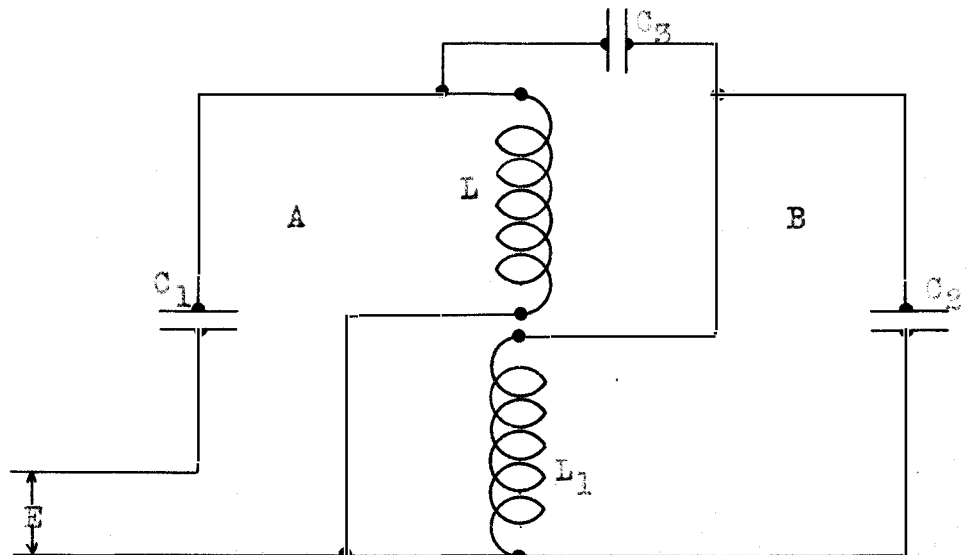

Sketch 8. Circuits coupled inductively as well as capacitively.

## USEFUL NOTES.

### SIMPLE SERIES CIRCUITS.

An inductance at low frequencies acts as an ordinary conductor.

An inductance at high or radio frequencies has a high reactance, which in most cases is greater than the RF resistance of the circuit.

A capacitance at low frequencies acts as an open circuit.

A capacitance at radio frequencies acts as a low resistance path for the current.

Resistance at radio frequencies is greater than the same resistance at low frequencies due to the skin effect.

The ratio of the reactance to the resistance of a coil increases rapidly as the frequency is increased.

The capacitive reactance of a condenser decreases rapidly as the frequency increases.

Inductance and capacity are used in series circuits to produce any desired resonant frequency by inserting values which will cancel each other and produce zero reactance.

For frequencies below resonance, capacitive reactance predominates.

For frequencies above resonance, inductive reactance predominates.

When resonance is obtained in a circuit, the only resistance in the circuit is the RF resistance of the circuit.

At resonant frequency, the power consumed by a circuit is equal to  $I^2R$ , where  $I$  is the Radio frequency current of the circuit measured between the inductance and the capacity, and  $R$  is the RF resistance of the circuit.

At resonant frequency the voltage drop across the condenser is high but is exactly cancelled by the voltage drop across the inductance (At resonant frequency, the lagging component of the voltage equals the leading component of the the voltage, in a series circuit). The resultant current flowing thru the circuit is only that produced by the voltage drop across the RF resistance but any circuit connected to the condenser terminals would have this high condenser voltage and must be insulated accordingly.

This is the reason for such heavy insulation on transmitting antennae. To illustrate: If a transmitting antenna having a capacity of 0.005  $\mu\text{f}$  and a resonant current of 80 amperes at 30,000 cycles, the voltage on the antenna, or the voltage strain on the insulators would be 119,000 volts.

## USEFUL NOTES.

### PARALLEL CIRCUITS.

The applied voltage, in the case of a parallel circuit without resistance, is balanced by the combined reactive voltages of the inductive and capacitive branches. These voltages are equal and opposite in case the applied voltage is of resonant frequency. Therefore, the total reactive voltage is equal to the numerical voltage value of either the inductance or the capacity.

So far as the parallel circuit is concerned, the reactive voltages are neutralized, but at any instant the voltage across the condenser is equal and opposite to the applied emf. If a greater emf is applied, more current will flow within the reactances and the required counter emf will be built up.

The larger the capacity of a parallel combination, the greater will be the value of the circulating current.

In a parallel circuit containing resistance, as the circuit resistance increases, the circulating current will decrease, due to the applied emf being reduced by the IR voltage drop of the circuit.

This current component in phase with the applied emf, is the current which flows in the supply circuit.

If the capacity branch contains resistance, it is to be treated the same as the inductive branch.

The in-phase components of the currents through the capacitive and inductive branches add together and form the current which flows through the supply circuit.

The impedance, or effective resistance, which the parallel circuit offers to the supply circuit is given by:

$$R = \frac{L}{r_c}$$

Where:

R = effective resistance of the combination.  
r = circulating resistance of the combination  
( $r_1$  plus  $r_c$ )

L = inductance of combination  
C = capacity of combination.

This formula is only useful in finding the effective resistance to the resonant frequency of the combination, the sharpness of the circuit or the resistance which it offers to other frequencies. This will vary inversely as the circulating resistance and the ratio of L/C.

When the circuit applied emf is greater than the resonant frequency of the parallel circuit, that circuit will offer a capacitive reactance to the supply circuit. If the applied emf frequency is lower, the resultant reactance will be inductive.