

164C2 TELEGRAPH TRANSMISSION MEASURING SET DESCRIPTION

CONTENTS	PAGE
1. GENERAL	1
2. PHYSICAL DESCRIPTION	2
3. GENERAL DESCRIPTION OF OPERATION	2
4. PRIMARY OR BASIC CALIBRATION	3
5. ROUTINE CALIBRATION	6
6. USE	7
7. MAINTENANCE	9
8. REFERENCES	9

1. GENERAL

1.01 The 164C2 telegraph transmission measuring set is a portable instrument for use in measuring the distortion in start-stop telegraph signals. It is capable of measurements in circuits transmitting at the standard nominal rates of 60, 75, or 100 words per minute, and in addition at one higher speed. The higher speed now available is 200 words per minute. It will also measure the 6-level code equivalents of these speeds. The circuit features which provide the 200 wpm speed are shown as options on the SD drawing, and may be replaced by arrangements permitting measurement of any speed within the ultimate capacity of the set. This upper limit of capability is 750 dot cycles, or signal elements of 0.67 milliseconds' duration.

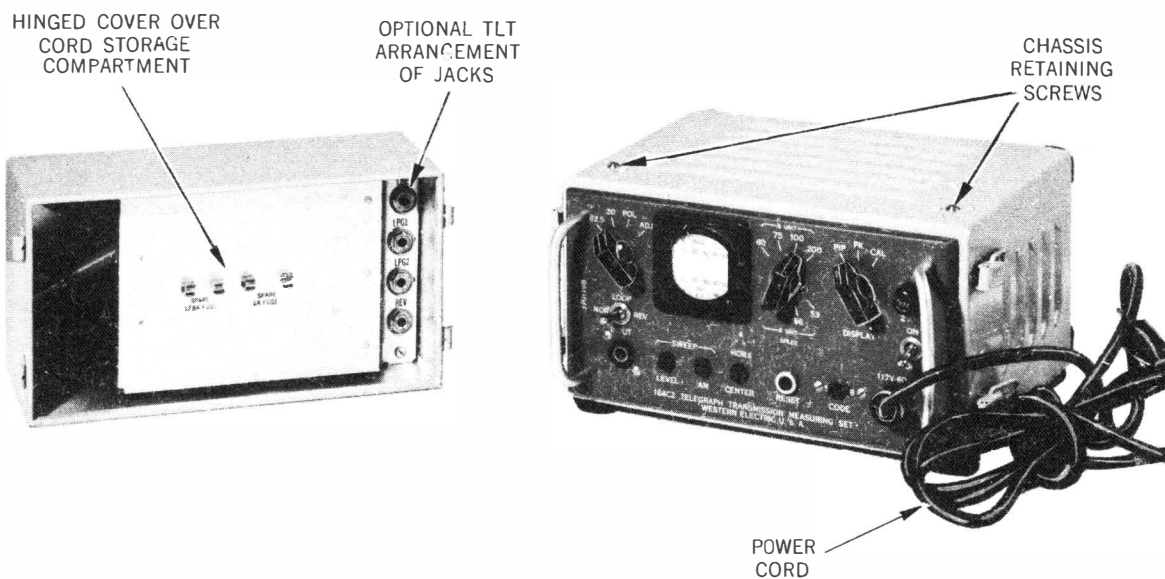

Fig. 1 - General View of Set

2. PHYSICAL DESCRIPTION

2.01 The set, less cover, measures six inches by eight inches by eleven inches. It weighs about fifteen pounds, including the cover.

2.02 The ac power cord of the set terminates in a 3-conductor plug (one grounding pin). This requires the use of a power plug adapter when the ac supply is available only at 2-conductor parallel-slot receptacles. A Hubbell adapter is provided for this purpose.

2.03 There are 5 different patch cords which may be used with this set under various conditions. There is also an optional set of jacks which mounts in the cover and facilitates the use of the set at a station equipped with a "red" jack. The tabulation in Fig. 15 outlines the uses of the various cords and jacks.

2.04 A compartment in the cover provides space for storage of the power cord, power plug adapter, and patch cords. The cover also contains holders for spare fuses.

2.05 CD-70865-01 gives detailed descriptions of the various circuits of the set and of their operation. This section describes the set's application, with only a brief description of its operating principles.

3. GENERAL DESCRIPTION OF OPERATION

3.01 The following definitions are given for terms used in this section. (See Fig. 2 for illustrations.)

BIAS is a uniform displacement of space-to-mark signal element transitions from their proper positions in relation to the beginning of the start pulse.

MARKING BIAS is a displacement of the space-to-mark transitions so that they occur before their proper positions.

SPACING BIAS is a displacement of the space-to-mark transitions so that they occur after their proper positions.

END DISTORTION is a uniform displacement of the mark-to-space signal element

transitions from their proper positions in relation to the beginning of the start pulse.

MARKING and SPACING END DISTORTION are displacements of the mark-to-space transitions so that they occur later and earlier, respectively, than their proper positions.

FORTUITOUS DISTORTION is a random distortion of signals such as that commonly produced by interference.

PEAK DISTORTION is the largest *total* distortion of signals noted during a period of observation.

3.02 The 164C2 set presents its distortion indications as displays on the face of a cathode ray tube on which is etched a scale. There are two different types of display, the choice of which is controlled by the DISPLAY switch. The PK position of the switch gives a display which indicates the peak value of distortion during the period of observation. The PIP setting of the switch produces a display which indicates the amount of distortion occurring in every signal element. It also indicates whether the distortion observed is bias or end distortion.

3.03 For the PIP type of display, the internal circuits of the set produce a sweep voltage which is applied to the plates causing horizontal deflection of the beam of the cathode ray tube. This sweep is triggered by the leading edge of the start element of the external signal being measured. The voltage which causes the beam to "sweep" has a "sawtooth" shape, which causes the spot on the tube face to move from left to right and then from right to left, with uniform velocity during both directions of travel. The period of a full cycle is equal to that of a unit length element for the signal speed to be measured. Thus, the left end of the horizontal trace occurs at times corresponding to both the beginning and end of the period of a correctly timed signal element. (See Fig. 3.) The right end of the trace occurs at the center point of the period of a perfectly timed element. It, therefore, corresponds to a scale value of 50%. The sweep circuit oscillates for a given number of cycles

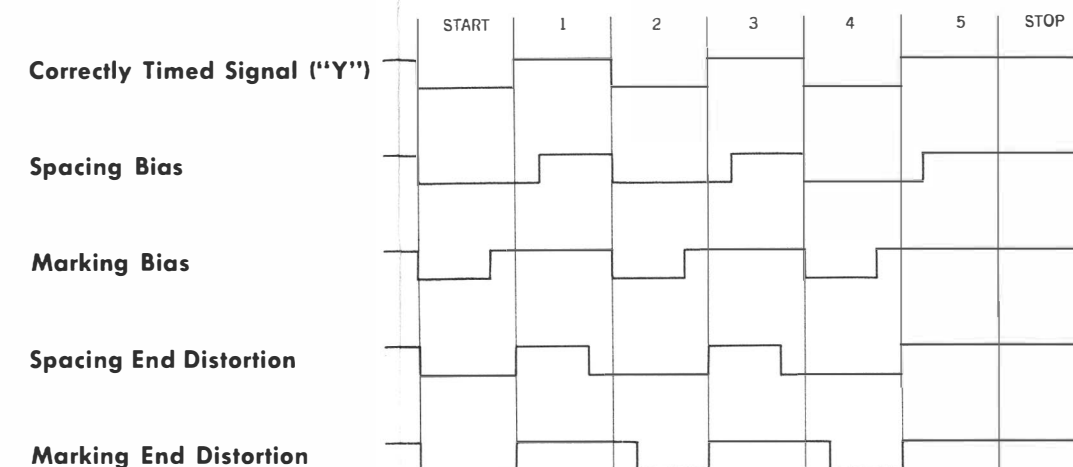

Fig. 2 - Bias and End Distortion

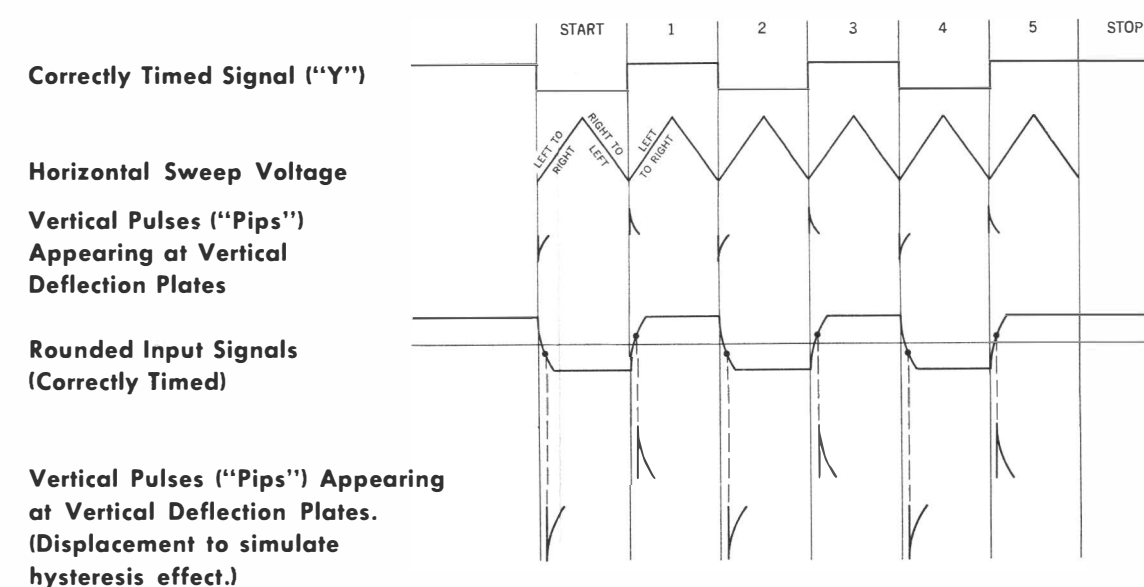

Fig. 3 - Time Relations of Signal, Horizontal Sweep, and Vertical Pulses

which is determined by the setting of the CODE switch on the face of the set: 6 cycles (start plus 5 code elements) for 5 level codes, and 7 cycles (start plus 6 code elements) for 6 level codes. In both cases it stops oscillating shortly after the beginning of the stop element.

3.04 The internal circuits of the set produce other voltages from the signals which are being measured, and these voltages are applied to the plates of the cathode ray tube causing vertical deflection of the beam. These voltages are "impulses" or "pips" which occur at times corresponding to those at which a relay would operate and release when driven by the signal. For "square" signals these points correspond in time to the signal transitions. For rounded signals, they correspond to points representing relay operate values, as shown in Fig. 3. The displacement of these points above and below the nominal operate value of relay current is provided to take account of hysteresis, or magnetic lag, of normal relays. Thus the 164 set responds to signals in the same manner as any telegraph signal receiver which has an input relay. The voltage pips produced on the face of the cathode ray tube are upward for space-to-mark transitions and downward for mark-to-space transitions. The impulses or voltage pips consist of a steep wave front followed by a slower return, or "tail." If distortion causes the signal transition(s) to occur at times other than integral multiples of the pulse period as measured from the leading edge of the "start" pulse, then the "pips" which correspond to the input signal transitions will not occur at the left, or zero, end of the trace. They will appear somewhere to the right of that point, and the scale indicates the percentage displacement (of a unit pulse length).

3.05 From the preceding paragraph and the definitions in 3.01 it can be seen that:

1. Bias is indicated by the upward pips on the screen.
2. End distortion is indicated by the downward pips.

Figs. 4 and 5 illustrate the relations of bias, end

distortion, the horizontal sweep, and corresponding tube displays.

4. PRIMARY OR BASIC CALIBRATION

4.01 The primary calibration should be performed *only* when electron tubes have been changed, or the set has not been used for a long period of time, say six months. It should *not* be performed on new sets since the factory calibrates all sets before shipment.

4.02 The primary calibration requires the following auxiliary equipment:

- (1) A 1A teletypewriter test set, or a 100A teletypewriter test distributor, known to be in good adjustment.
- (2) A dummy loop — either 62.5 ma or 20 ma.
- (3) A cathode-ray oscilloscope.

4.03 The primary calibration includes these operations:

- (1) Adjustment of BIAS control to simulate an input signal (4.08).
- (2) Balancing of two halves of the element-timing multivibrator so that the two halves of the horizontal sweep voltage signal will be symmetrical (4.09 - 4.11).
- (3) Adjustment of SWEEP LEVEL control to insure that all sweeps occurring during one character stop and start at the 0 scale point (4.14, 4.17, 4.21).
- (4) Adjustment of the period of the horizontal sweep to equal the duration of a unit pulse (element) for the speed of signals for which the set is being calibrated (4.15, 4.18).
- (5) Adjustment of the character length for the speed at which the set is being calibrated (4.16).
- (6) Positioning and adjustment of the horizontal trace so that it extends from 0 to 50 on the scale (4.19, 4.20).

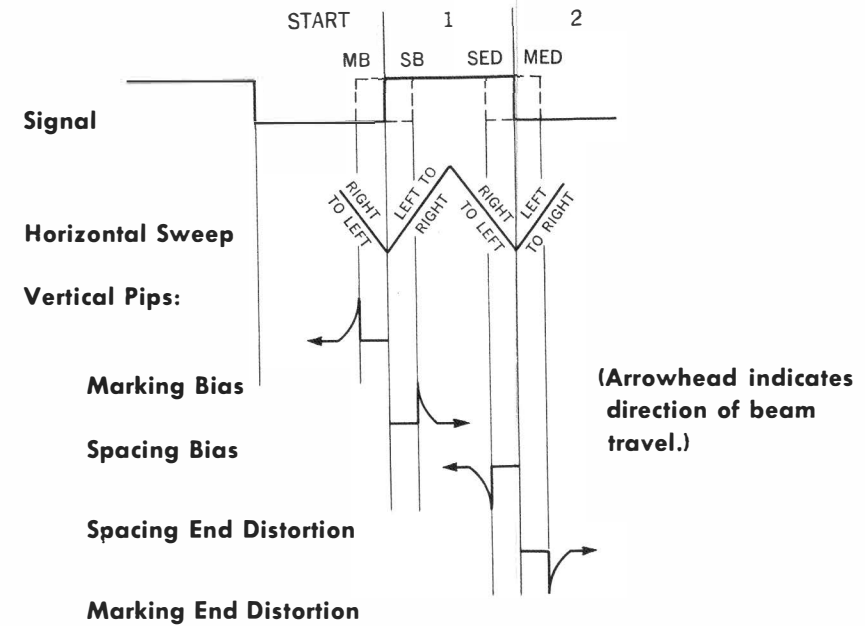

Fig. 4—Pulses (or "Pips") Caused by Different Types of Distortion

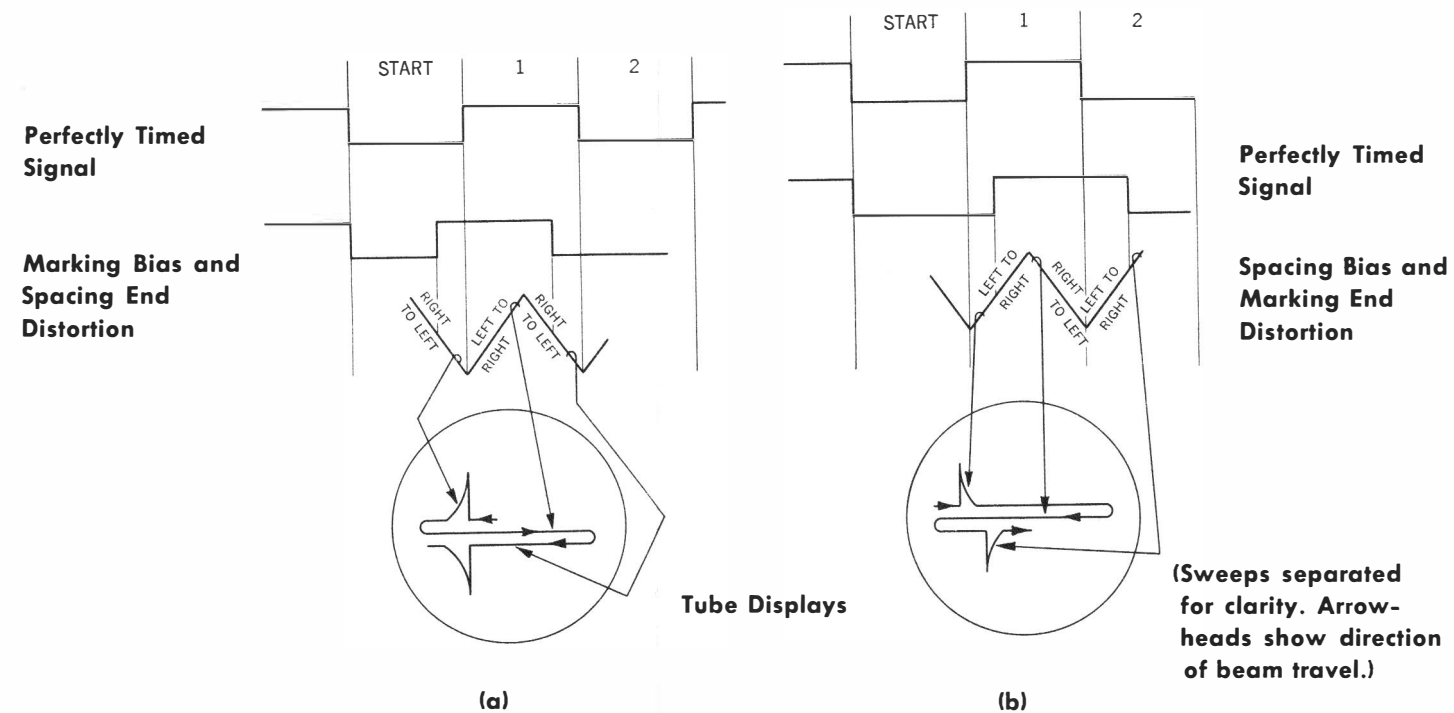

Fig. 5 — Relation of Input Signals, Sweep Voltage and CR Tube Display

Procedure

4.04 Remove the four large screws which hold the chassis in the case. (See Fig. 1.) Remove the chassis from the case and place it on an *ungrounded* support with the electron tubes up.

4.05 Set the controls as follows: (See Fig. 6.)

LOOP on ADJ

DISPLAY on PIP

SPEED on 100

CODE on 5 or 6 depending on the type of signals to be used for calibration.

SWEEP AM, SWEEP LEVEL, BIAS, and all other controls in the center of their mechanical ranges.

4.06 Connect the power cord to a source of 115-volt, 60-cycle ac. The front panel should not be grounded. Do not use a 3-wire receptacle, but use the Hubbell adapter provided *and do not connect the ground wire of the adapter to building ground.*

Caution: Potentials as high as 800 volts are present in the set. Exercise extreme care to contact no parts of the equipment with the body. Also use care to see that test probes or leads contact only those circuit points specified.

Operate the power switch to ON.

4.07 After a one minute warmup adjust FOCUS, INTENSITY, V-CENTER and HOR CENTER controls to give a small fluorescent spot on the face of the cathode-ray tube. (See Figs. 6 and 7 for locations of controls.) Position the spot so that it is centered from top to bottom and at about scale 10 horizontally.

4.08 Slowly rotate the BIAS control until a position can be found which causes the spot to move back and forth across the face of the tube to form a horizontal line. Each time the BIAS control is moved through this position, one or more horizontal sweeps should appear. Leave the control set as nearly as possible at this

critical point. (A margin of one-tenth of a turn is tolerable.)

Note: A small vertical display may appear on the horizontal line. Disregard it.

4.09 Operate the power switch to OFF. Connect the vertical input (Y axis) of a cathode-ray oscilloscope to the MV BAL and NEUT test pin jacks. (See Fig. 7.) See that the NEUT jack connects to the return or ground side of the CRO input.

Note: The ground side of the CRO input should not be connected to ground. This means that the CRO should not be resting on a grounded support nor should a third wire in its power cord be grounded.

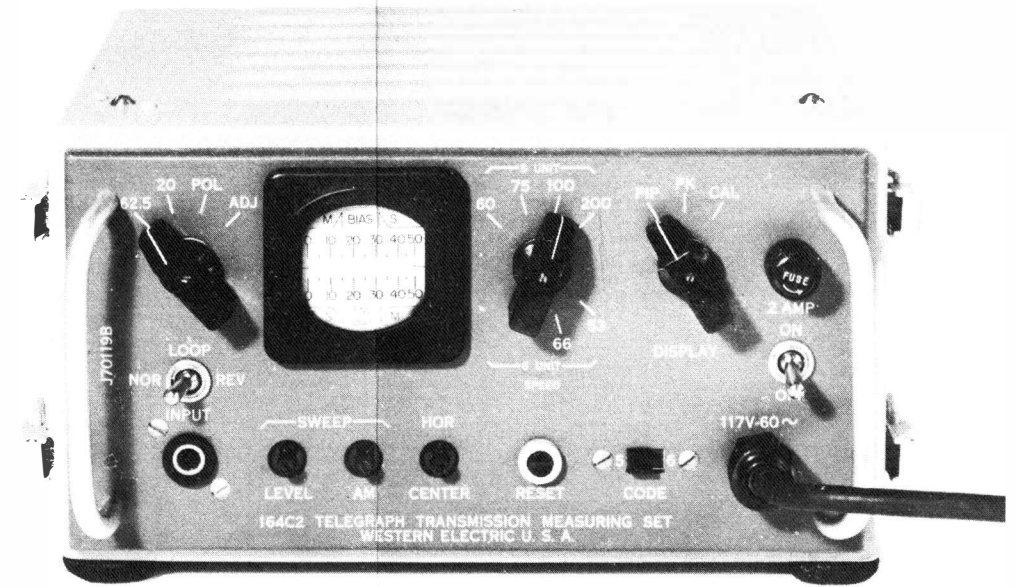

Fig. 6 - Face of Set

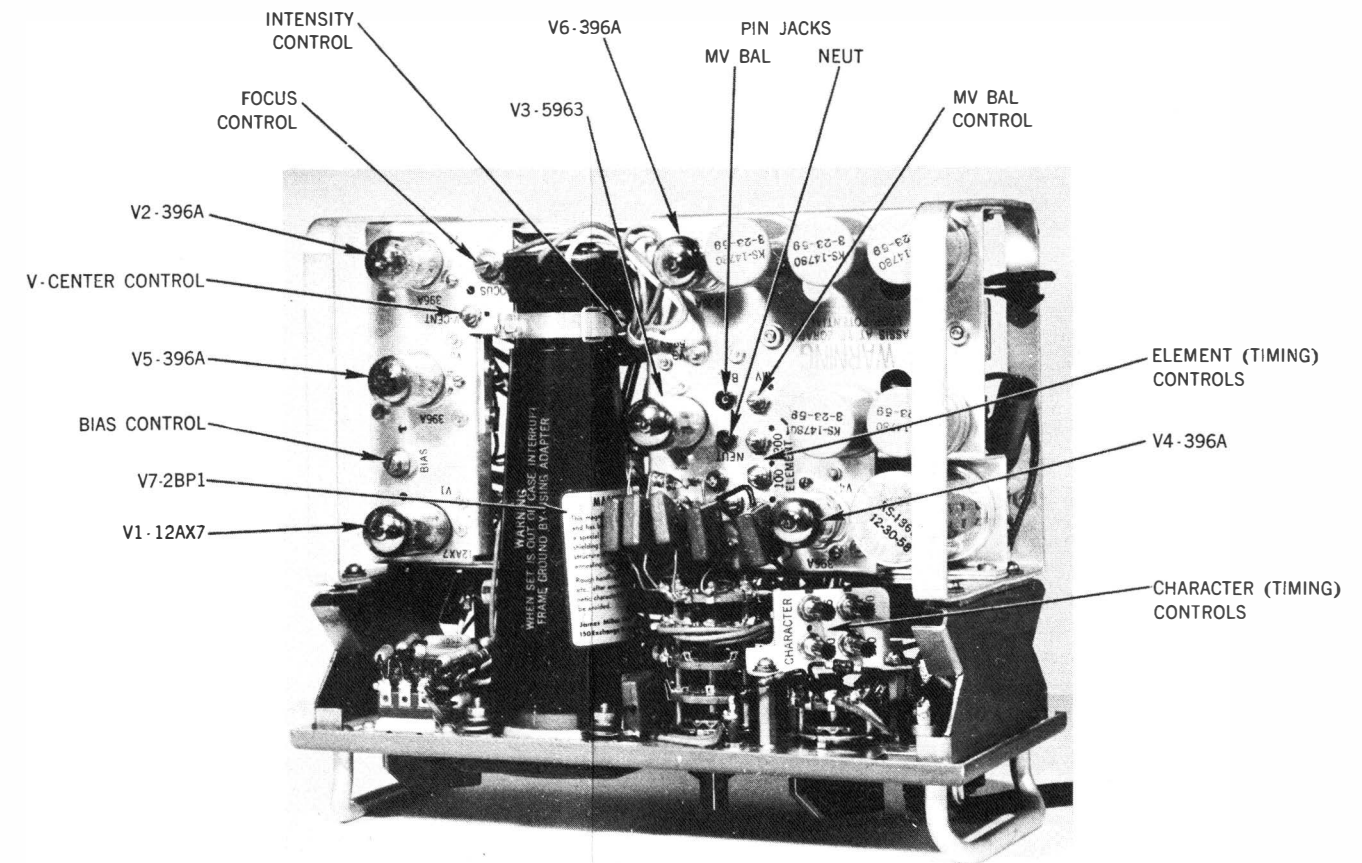

Fig. 7 - Plan View of Chassis

4.10 Operate the power switch to ON. After a one-minute warmup, operate the DISPLAY switch to CAL.

4.11 Arrange the test oscilloscope for internal horizontal "synch" and set its "synch" control to 0. Carefully adjust the speed of its horizontal sweep to produce a display corresponding to that of Fig. 8. The speed should be slow enough that only a single transition region appears in the pattern. The intersection of the two traces should occur exactly midway between the upper and lower horizontal lines of the display. If not, *use an insulated screwdriver* to adjust the MV BAL control until it does. Then remove the test connections to the oscilloscope.

Note: The MV BAL control setting should be checked about every 6 months. It should also be checked whenever tube V3 is changed.

4.12 Connect a source of undistorted test signals from either the 1A or 100A test sets to a dummy loop. (See Fig. 9.) Use the 2P31A cord. (See Fig. 15.) Insert the 359A plug (shorter one) into the INPUT jack of the 164C2 set and then insert the 347A plug into the NORMAL jack of the dummy circuit. If the circuit arrangements are such that the polarity of the voltage on the tip of the 359A plug is positive for a "mark" signal, set the NOR-REV switch to NOR. If negative, set the switch to REV. Fig. 9 polarity for the NOR jack requires NOR switch setting. Set the LOOP switch to agree with the marking loop current. Set the SPEED switch to agree with that of the test signal source.

Note: If a 100A set is used as a test signal source for 60, 75, or 100 speed, set it to send the letter "O" (SSSMM). For 200 speed use *only* a repeated 100 speed "M" (SSMMM). The first three spacing pulses (including "start" pulse) equal in time six code pulses (including "start") at 200 wpm. The last four marking pulses (including "stop" pulse) appear to the test set as a long "stop."

Coarse Element Adjustment

4.13 Move the DISPLAY switch to PIP, and the SPEED switch to agree with that of the test signals.

4.14 Disregard the signal "pips" appearing in the display and adjust the SWEEP LEVEL control so that there is a very small **horizontal** gap between left end of trace and the bright spot. (See Fig. 10a.)

4.15 Using the ELEMENT control which corresponds to the speed of the signals being used, try to bring all the pips to the zero end of the scale. If this can not be done, change the setting of the CHARACTER control (for the appropriate speed) and try again. For 200 speed, use only the *upward* pips.

4.16 When the pips are stable and near scale zero, rotate the CHARACTER control clockwise until pips begin to appear upscale (10 to 40%). Then back off the CHARACTER control (counterclockwise) 1/3 turn from this point. If no pips appear upscale, back off 1/3 turn from the clockwise stop. For 200 speed, first calibrate the set at 100 speed. Then set 200 speed CHARACTER control at same physical angle as 100 speed CHARACTER control.

Fine Element Adjustment

4.17 Rotate the SWEEP LEVEL control until the left end of the horizontal trace appears to separate from the bright spot at the left. (See Fig. 10b or 10d.) Reverse the direction of rotation *until the gap is just short of closing*.

4.18 Adjust the appropriate ELEMENT control until the downward deflections of the trace all come as closely as possible to scale zero. For greatest accuracy the downward pips should just form small loops at scale zero. (See Fig. 10c.) For 200 speed use *upward* pips only.

4.19 Adjust the HOR CENTER control so that the left end of the trace is at scale zero. (This puts the bright spot just to the left of zero.)

4.20 Adjust SWEEP AM control so that the right end of the trace extends to scale 50.

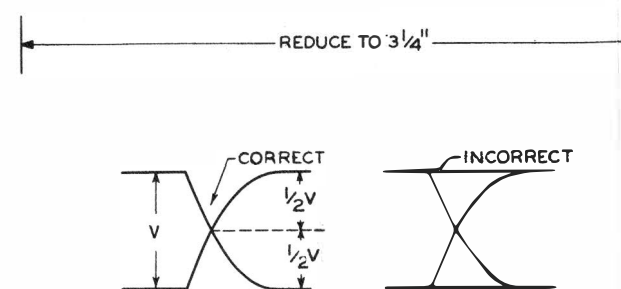
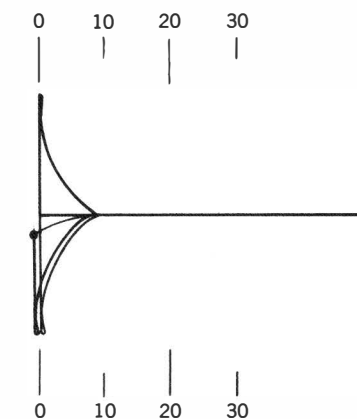
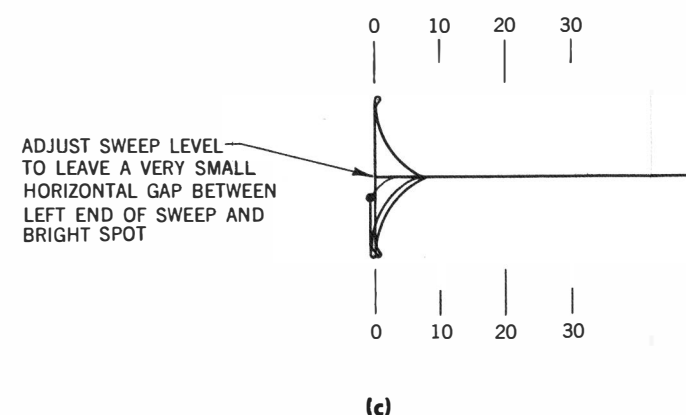

Fig. 8 - Adjustment of MV BAL Control



(a) Prior to "character" tuning other pips may appear upscale.



(c)

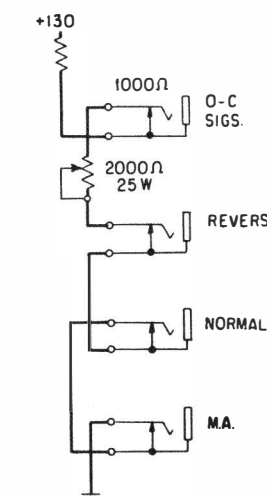
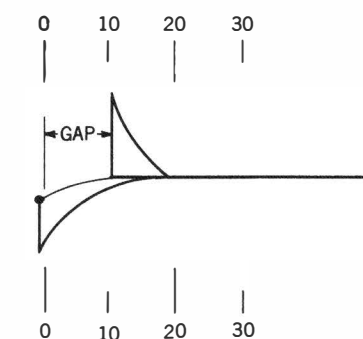
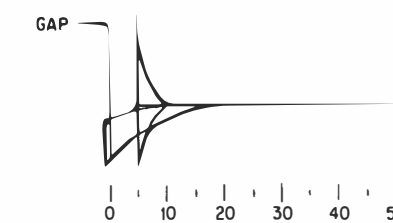

Fig. 9 - Dummy Loop



(b) Using two-transition character.



(d) Using miscellaneous signals.

Fig. 10 - Calibration Displays

4.21 Readjust the SWEEP LEVEL control as follows:

- (1) Use the HOR CENTER control to move left end of trace to spot for easier observation.
- (2) Slowly rotate SWEEP LEVEL control clockwise until the left end of the trace moves about 1/8 inch away from the bright spot. (See Fig. 10b or 10d.)
- (3) Slowly rotate SWEEP LEVEL control counterclockwise. Stop at the point where the horizontal gap is *just short of closing*.
- (4) Further counterclockwise rotation of the control will close the small gap and make the trace brighter. The correct setting is that which leaves the smallest possible horizontal gap between the left end of trace and the spot.
- (5) Use the HOR CENTER control to restore the end of the trace to scale zero. Recheck that the right end is at scale 50, and correct if necessary.

4.22 Repeat the procedures of Paragraphs 4.10 through 4.18 for any other speeds at which it is desired to calibrate the set. Use test signals of appropriate speeds. (The SWEEP AM and SWEEP LEVEL controls will require only minor readjustments.)

4.23 Operate the power switch to OFF. Restore the chassis to its case and fasten the four mounting screws securely.

5. ROUTINE CALIBRATION

5.01 Connect the power cord to a source of 115-volt ac. If a three-conductor receptacle is not available, use the Hubbell adapter, *and be sure to connect the third wire to the building ground.*

5.02

- (1) Operate the power switch to ON.
- (2) Operate the LOOP switch to the position corresponding to the current in the circuit to which the set is to be connected.

(3) Operate the SPEED switch to the position which agrees with the speed of the signals to be used.

(4) Operate the DISPLAY switch to PIP.

(5) Operate the CODE switch to match that of the signals.

(6) Operate the INPUT key to NOR.

5.03 A small bright spot will appear and drift across the screen toward scale zero. After a one-minute warmup the spot should lie somewhere between scale 5 and scale 15. If no spot is visible, proceed as follows:

- (1) Check for presence of power by observing the tube filaments through the case louvers.
- (2) If the tubes are energized, adjust the HOR CENTER control to bring the spot on the screen at scale 5. If no spot appears, the set requires maintenance.

5.04 Set SWEEP AM and SWEEP LEVEL controls at the centers of their ranges of rotation.

5.05 Using the 2P31A (red-gray) patch cord, insert the 359A plug (shorter one) into the INPUT jack of the set. Insert the other plug into a jack of a circuit in which teletypewriter signals are available.

5.06 A horizontal trace should appear, with pips both above and below it. Note the following, however:

- (1) If no trace appears and LOOP switch is set at 62.5 or 20, operate NOR-REV switch to REV.
- (2) If LOOP switch is set at POL and pips appear clustered near scale 40, operate NOR-REV switch to REV.

OPERATION	CONNECTING CORD(S)	CONNECT TO:	SWITCH SETTINGS IN 164C2 SET			DISPLAY	
			LOOP	SPEED	CODE		
Primary Calibration MV BAL adjustment			Not in	ADJ	100	Not in ckt.	Both PIP and CAL
Other adjustments	2P31A	of dummy	NOR for + Bat. on tip REV for - Bat. on tip	Must correspond to test signals			PIP
Routine calibration	2P31A	Any source of tgh. test signals	NOR for + Bat. on tip REV for - Bat. on tip	Must correspond to test signals			PIP
Measurement in relay type TLT	2P31A	Looping jack	NOR	Must correspond to test signals			PIP for avg. bias & distortion, PK for peak distortion
Measurement of signals from station in 43A1 HDX loop (Note 3)	2P32A	Pin jks. on 43A1 term.: red to MD, black to C	Not in ckt.	62.5 Note 2	Must correspond to test signals		PIP for avg. bias & distortion, PK for peak distortion
Measurement of signals toward station in 43A1 HDX or FDX loops, or toward terminal in FDX loops only (Note 4)	2P31A	Drop 2 jk. of 43A1 TLT or	NOR	Must correspond to test signals			PIP for avg. bias & distortion, PK for peak distortion
		Any convenient series jk.	NOR for + Bat. on tip REV for - Bat. on tip	Must correspond to test signals			PIP for avg. bias & distortion, PK for peak distortion
Measurement at 15 or 19 teletypewriter station equipped with "red" jk.	2P1 or 2P2 and 2P31A	2P1 from "red" jk. to J2* jk. 2P31A from J3 or J4* to input jk. Set's "red" cord to J3 or J4* jk.	NOR for + Bat. on tip REV for - Bat. on tip	Must correspond to test signals			PIP for avg. bias & distortion, PK for peak distortion
Measurement at station with no jacks	2W44A and 2P31A	2W44A from loop to J2* jk. 2P31A from J3 or J4* to input jk.	NOR for + Bat. on tip REV for - Bat. on tip	Must correspond to test signals			PIP for avg. bias & distortion, PK for peak distortion
Measurements at 82B1 switching center	2P33A	Jacks in line cabinet	NOR for + Bat. on tip REV for - Bat. on tip	Must correspond to test signals			PIP for avg. bias & distortion, PK for peak distortion

* See Fig. 15

Note 1. Battery polarities refer to "marking" signal condition.

Note 2. Should be set on 62.5 regardless of loop conditions.

Note 3. Should be measured with channel terminal send switch set on HM.

Note 4. Also applies to signals sent toward station in loops connected to 96A1 loop repeaters or 144B1 coupling units.

Fig. 11 - Application Information

5.07 Adjust the HOR CENTER control so that the left end of the horizontal trace is at scale zero.

Note: After a one-minute warmup most of the set's circuitry will have stabilized. However, there will be a slight drift in the horizontal centering during the first 15 minutes of operation. This will require small readjustments of the HOR CENTER control.

5.08 Adjust the SWEEP AM control so that the right end of the trace extends to scale 50.

5.09 Adjust the SWEEP LEVEL control as follows: (Refer to Figs. 10a, b and c.)

- (1) Use the HOR CENTER control to move left end of trace to scale 5 for easier observation.
- (2) Slowly rotate SWEEP LEVEL control clockwise until the left end of the trace moves about 1/8 inch away from the bright spot. (See Fig. 10b or 10d.)
- (3) Slowly rotate SWEEP LEVEL control counterclockwise. Stop at the point where the horizontal gap is *just short of closing*.
- (4) Further counterclockwise rotation of the control will close the small gap and make the trace brighter. The correct setting is that which leaves the smallest possible horizontal gap between the left end of trace and the spot.
- (5) Use the HOR CENTER control to restore the end of the trace to scale zero. Recheck that the right end is at scale 50, and correct if necessary.

Note 1: Adjustment of the HOR CENTER, SWEEP AM and SWEEP LEVEL controls does not affect the over-all calibration of the set. These three adjustments are self-calibrating. If these controls are moved from their correct settings, they may be reset using *any* source of telegraph signals.

Note 2: The SWEEP LEVEL adjustment is simplified when the test signal is a repeated two-transition character. The letter "O" is recommended (S-S-S-M-M).

5.10 The set is now ready for use. If the SPEED switch is moved to measure signals at speeds other than that used for the above calibration, minor readjustment of the SWEEP AM and SWEEP LEVEL controls may be necessary.

6. USE

6.01 This part describes how to connect the set to telegraph circuits and how to interpret the displays on the cathode-ray tube.

6.02 There are two broad categories of telegraph circuits in use in the plant. We shall call these "relay" type and "electronic" type circuits. The latter consists of loop circuits connected to 96A1 repeaters, 43A1 channel terminals and 144B1 coupling units. The relay-type category includes all others. There is a difference between these two which affects transmission measurements. In relay-type circuits all the devices connected to the circuit are operated by current. In electronic-type circuits the station equipments or other gear used to terminate the loops are also operated by current. However, the modulator tube in 96A1 repeaters and 43A1 channel terminals is driven by voltage changes. In half-duplex 43A1 loops and in 96A1 loops (always half-duplex) the voltage does not have the same waveform as the current when signals are being sent toward the electronic terminal. In order to measure the quality of signals sent from a station toward an electronic terminal it is necessary to arrange the 164C measuring set to observe the voltage signals. When signals are sent from the terminal toward the station, the current and voltage waves are similar, and current measurements are satisfactory.

6.03 The 164C2 set is arranged to measure both current and 43A1 loop voltage signals. Separate input circuits are included for each case, but both are connected to the same input jack. The input circuit for current signals is connected to the ring and sleeve of the input jack. Observation of such signals requires use of the 2P31A or 2P33A patch cords for connection to the circuit. These cords have a 359A plug on one end (tip-sleeve only). The plug is of such

length that the tip contacts the ring spring of the input jack. The input circuit for voltage signals connects to the tip and sleeve of the input jack. The 2P32A patch cord provided for measurement of voltage signals has a 310 (3-conductor) plug on one end. This plug is longer than the 359A so that the tip contacts the tip spring of the input jack.

6.04 Connection of the set to electronic loops for voltage measurements connects a transistor amplifier between the tip of the input jack and the grid of the first amplifier tube of the circuit. This voltage measurement requires that the pin plug end of the 2P32A cord be connected to the MD and C pin jacks on the 43A1 terminal: the red cord connects to the MD jack and the black to the C jack. It is not practicable to connect the 164 set for measurements of distortion at a 96A1 repeater on signals sent from the station, since the connections to the circuit would have to be made within the repeater unit.

6.05 Connection of the 164C2 set to relay-type circuits for measurement on a current basis adds a 150-ohm resistor in series in the telegraph circuit. The voltage developed across this resistor is used as the input to the set's circuits.

6.06 Fig. 11 outlines connecting information for various applications of the set.

6.07 Fig. 12 shows the displays caused by various common types of distortion.

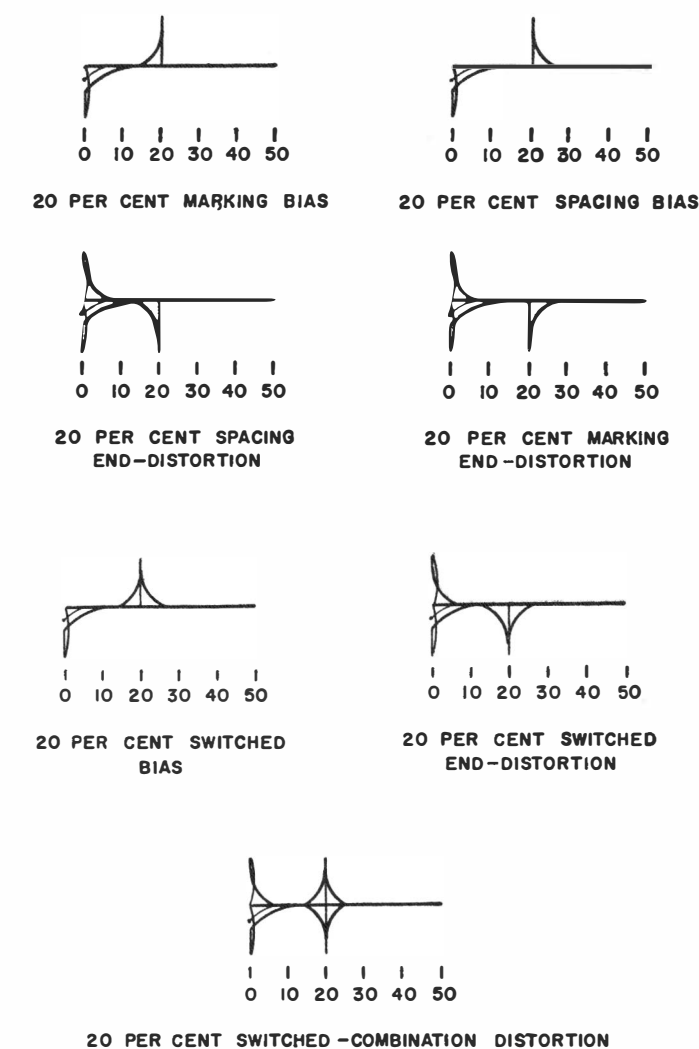

Fig. 12 - Typical Distortion Displays

6.08 Fig. 13 shows the displays caused by speed errors in the signals.

6.09 Fortuitous "hits" in telegraph circuits will add to the systematic components of distortion and produce random peaks of distortion which exceed in magnitude the average value. The PK setting of the DISPLAY switch permits observation of fortuitous hits and determination of the peak value which occurs during the period of observation. Fig. 14 illustrates a peak display. Fortuitous hits will cause the trace to jump toward the right. It will drift slowly back from the peak value until it reaches the average value, or until another hit causes it to jump to the right again. Momentary operation of the RESET button will discharge the circuit which gives the peak reading and allow it to respond to new peaks. (The peak indicating circuit is inoperative while the RESET button is actually depressed.)

6.10 Characteristic distortion may be determined by observation of the distortion on different repeated characters. If the average distortion value is higher for a repeated character that contains unit length pulses than it is for one which contains no unit length pulses, the difference is probably due to characteristic distortion. The following teletypewriter characters contain no unit length pulses: I, M, O, T, V, BLANK, and LETTERS.

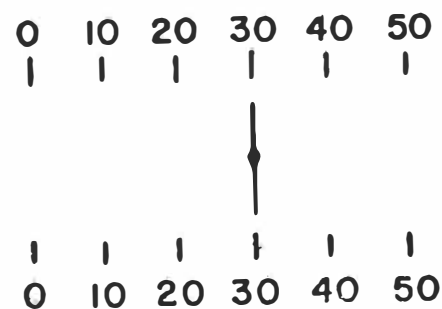
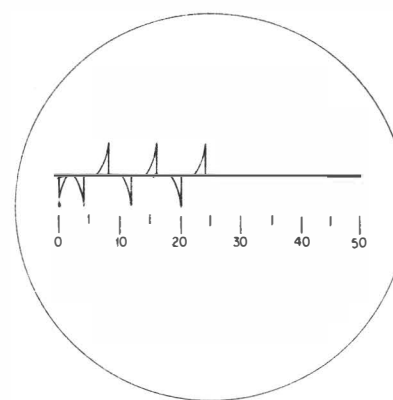
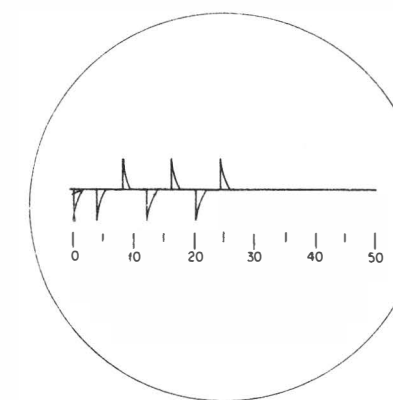

Fig. 14 - Peak Display — 30% Distortion



(a) Miscellaneous Signals — Transmitter 4% Fast



(b) Miscellaneous Signals — Transmitter 4% Slow

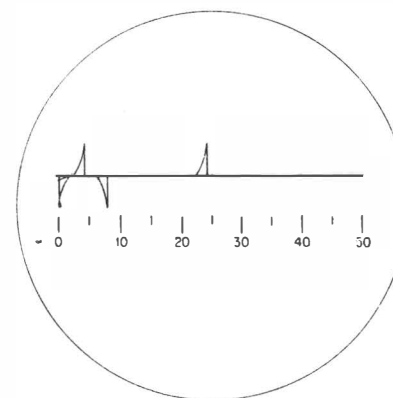

(c) Repeated "E" — Transmitter 4% Fast

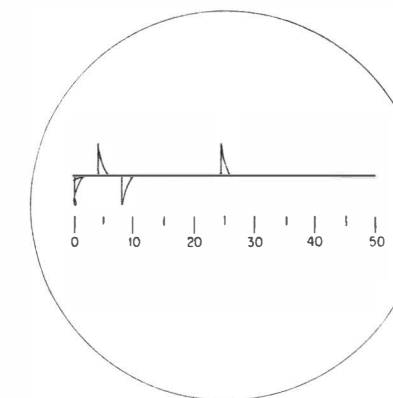

(d) Repeated "E" — Transmitter 4% Slow

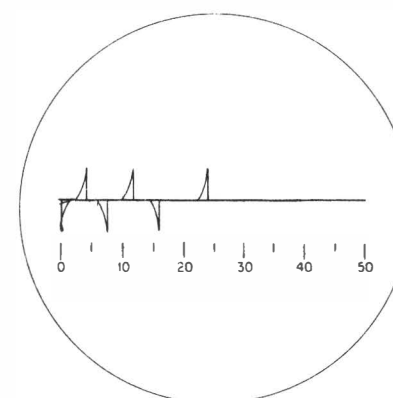

(e) Repeated "S" — Transmitter 4% Fast

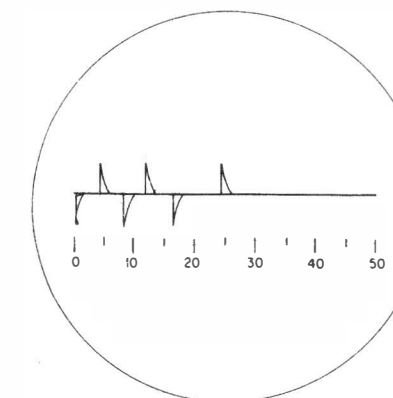

(f) Repeated "S" — Transmitter 4% Slow

Fig. 13 - Typical Displays Caused by Speed Errors

7. MAINTENANCE

7.01 If maintenance information is required, refer to 103-823-100, Section 5. This section refers to the 164C1 set. However, the test information given applies in general to the 164C2 set also. The sets differ only in equipment layout and in a few features of the character and element timing circuits.

8. REFERENCES

Circuit drawing	SD-70865-01
Circuit description	CD-70865-01
Specification drawing	J70119B
Equipment drawings	
Front panel assembly	ED-71193-30
Chassis assembly	ED-71193-31
Wiring drawings	
Front panel assembly	T-70865-30, 32
Chassis assembly	T-70865-31, 33
164C1 Telegraph Transmission Measuring Set	103-823-100
Preliminary Information on 164C2 Set *	B-128279

* Furnished to 82B1 switching centers only.

EQPT.	PROVIDED UNDER	CONNECTOR	CORD	CONNECTOR	CONNECTS	
					FROM	TO
Set of jacks, J2, J3, J4, J5, per SD-70865-01, Fig. 2	J70119B, List 2					
2P31A cord	J70119B, List 1	347A plug	2-cond.*	359A plug	TLT; J3, J4, or J5	Input jack Input jack
2P32A cord	J70119B, List 1	Pin plugs	2-cond.	310 plug	MD & C jacks in 43A1 terminal	Input jack
2W44A cord	J70119B, List 2	Alligator clips	2-cond.	347A plug	Loop connecting block	J2 jack
2P1 cord	J70119B, List 2	347A plug	2-cond.	347A plug	"Red" jack	J2 jack
2P33A cord	J70119B, List 1, when specified by the customer	310 plug	2-cond.*	359A plug	Jacks in line cabinet at 82B1 tty. sw. ctr.	Input jack

* Plugs are interconnected tip to sleeve.

Fig. 15 - Connecting Cords and Jacks

164C2, 164C3, AND 164C4 TELEGRAPH TRANSMISSION
MEASURING SETS — DESCRIPTION

1. GENERAL

1.001 This addendum supplements Section 103-823-101, Issue 1.

1.002 The addendum is issued to provide information covering the 164C3 and 164C4 Telegraph Transmission Measuring Sets.

The following changes apply to Part 1 of the section:

- (a) 1.01 — revised.
- (b) 1.02 to 1.04 inclusive — added.

1.01 The 164C2 Telegraph Transmission Measuring Set is a portable instrument for use in measuring the distortion in start-stop telegraph signals. It is capable of measurements in circuits transmitting the 5-level code at the standard nominal rates of 60, 75, and 100 words per minute, and in addition, at one higher speed. The higher speed now available is 200 words per minute. The circuit features which provide the 200 wpm speed are shown as options on the SD drawing and may be replaced by arrangements permitting measurements at speeds up to 375 cycles, with signal elements of 1.33 milliseconds length. The set will also measure the 6-level code equivalents of 60, 75, and 100 wpm, provided that the baud rates are the same as for the 5-level code at the corresponding nominal word speeds.

1.02 The 164C3 Telegraph Transmission Measuring Set provides, in addition, for distortion measurements of the 8-level code equivalents, that is, with the same baud rates, of the nominal 60, 75, 100, and 200 words per minute speed. The speed relationships are shown in the following table.

SIGNAL TRANSMISSION SPEEDS

NOMINAL WPM (Speed Switch Position)	ACTUAL WPM Code Switch Position			BAUDS (Bits per Second)
	5	6	8	
60	61.4	52.9	43.7	45.5
75	76.6	66.0	54.5	56.8
100	100.0	88.1	71.2	74.2
200	200.0	176.2	142.4	148.4

1.03 Further, the 164C3 set provides, at the 200 position of the SPEED switch, for measurements of other signal speeds up to 750 bauds by the use of optional values for four capacitors within the set.

1.04 In addition to the measurement capabilities for the 5-level and 6-level codes, which are the same as for the 164C2 and 164C3 sets, the 164C4 Telegraph Transmission Measuring Set makes use of the 8-level position on the CODE switch and the 100-speed position on the SPEED switch (now labeled 8/100 and 100/8, respectively) for distortion measurements of the standard 8-level code, but only at the actual speed of 100 wpm. With eight information elements, one start element and a double-length stop element, the actual baud speed of this code is 110.

2. PHYSICAL DESCRIPTION

The following changes apply to Part 2 of this section:

- (a) 2.01, 2.02, and 2.05 — revised.
- (b) 2.06 and 2.07 — added.

2.01 The 164C2 set, less cover, measures 6 inches by 8 inches by 11 inches. It weighs about 15 pounds including the cover.

2.02 (Add after the last sentence) In the 164C3 and 164C4 sets the power cord is detachable from the face panel and may be stored in the set cover.

2.05 CD-70865-01 gives detailed descriptions of the various circuits of the 164C2 set and their operation. This section describes the set's application with only a brief description of its operating principles. CD-70886-01 applies similarly to the 164C3 and 164C4 sets. In addition, Fig. 16 provides connecting information for these sets.

2.06 The outside dimensions of the 164C3 and 164C4 excluding hardware, are approximately 11-3/4 inches wide by 5-3/4 inches high by 13 inches deep. Total weight, including cover, is 10 pounds.

2.07 The faceplate engraving of the 164C4 Telegraph Transmission Measuring Set differs from that of the 164C3 set. The SPEED switch of the 164C4 set is engraved 100/8 instead of 200. The CODE switch of the 164C4 is engraved 8/100 instead of 8. This is to accommodate the 8 element 100 speed signals that the 164C4 set is designed to measure.

3. GENERAL DESCRIPTION OF OPERATION

The following change applies to Part 3 of this section:

(a) 3.03 — added sentence.

3.03 (Add prior to the last sentence). The 164C3 and 164C4 sets provide the same action; however with the CODE switch in the 8-unit position or the 8/100 position, the sweep circuit oscillates for 9 cycles (start plus 8 code element). In all cases, the sweep circuit stops oscillating shortly after the beginning of the stop-pulse.

4. PRIMARY OR BASIC CALIBRATION

The following changes apply to Part 4 of this section:

(a) 4.05 and 4.10 — revised.

(b) 4.06 — added sentence.

4.05 Set the controls as follows. (See Fig. 6)

LOOP on ADJ

DISPLAY on PIP

SPEED on 100

CODE on 5 or 6 (164C2), 5, 6, or 8 (164C3) or 5, 6, or 8/100 (164C4) depending on the type of signals to be used for calibration. SWEEP AM, SWEEP LEVEL, BIAS, and all other controls in the center of the mechanical ranges.

4.06 (Add at the end of this paragraph.) For the 164C3 and 164C4 sets, a 3-wire receptacle may be used since the front panel and case are made of insulating material and hence have no connection to building ground.

Operate the power switch to ON. After a minute warmup, operate the DISPLAY LEVEL for the 164C2 or BEAM OFF for 164C4 set.

6. The following changes apply to Part 6 of this section:

(a) 6.09 — revised note.

(b) 6.11 — added. 1

6.09 (Add at the end of this paragraph).

Note: The 164C3 and 164C4 sets provide, in addition to the features of the 164C2 set, auxiliary reset terminals (immediately behind the RESET button) to accomplish remote reset. Also provided are H. AMP and NEUT jacks on the face panel of the 164C3 and 164C4 sets which facilitate auxiliary monitoring of peak distortion indications.

6.11 If it is suspected that relay-chatter or other medium-high frequency disturbance is present on the circuit being measured, this can be checked on either the 164C3 or 164C4 set by depressing the INPUT FILTER OUT switch, which will reduce the input filtering action. Erratic indications on the set will then be observed if there is disturbance present.

7. MAINTENANCE

The following change applies to Part 7 of this section:

(a) 7.01 — revised.

7.01 (Change the next to the last sentence to read) However, the test information given applies in general to the 164C2, 164C3, and 164C4 sets.

8. REFERENCES

The following changes apply to Part 8 of this section:

(a) References — added.

(b) Fig. 16 — added.

8. REFERENCES

Circuit Drawing SD-70886-01
Circuit Description CD-70886-0
Specification Drawing J70146A
Wiring Drawings
Chassis Assembly T-708

Cable Drawings

LC NO. 1	LC 215 535
LC NO. 2	LC 215 536
LC NO. 3	LC 215 537
LC NO. 4	LC 215 538
LC NO. 5	LC 215 539

Equipment Engineering

Information	AA 286.053
-------------	------------

EQPT	PROVIDED UNDER	CONNECTOR	CORD	CONNECTOR	CONNECTS	
					From	To
Set of jacks J2, J3, J4, J5 per SD-70886-01, Fig. 2	J70146A, List 1					
2P31A Cord	J70146A, List 1	347A Plug	2-cond.*	359A Plug	TLT; J3, J4, or J5	Input jack
2P32A Cord	J70146A, List 1	Pin Plugs	2-cond.	310 Plug	MD and C jacks in 43A1 terminal	Input jack
2W44A Cord	J70146A, List 1	Alligator clips	2-cond.	347A Plug	Loop connecting block	J2 jack
KS-14532, L1	J70146A, List 1	7484 Conn. (Hubbel)	3-cond.	Twist-lock	117V AC outlet	
2P33A Cord	J70146A, List 1	310 Plug	2-cond.*	359A Plug	Jacks in cabinet tty sw	Jack
2P1	Generally Available	347A	2-cond.	347A	"Red" jack	J2 jack

* Plugs are interconnected tip to sleeve.

Fig. 16 - Connecting Cords and Jacks for 164C3 Set