

KEY LEVER ASSEMBLY ARRANGEMENTS FOR NO. 28 TTY

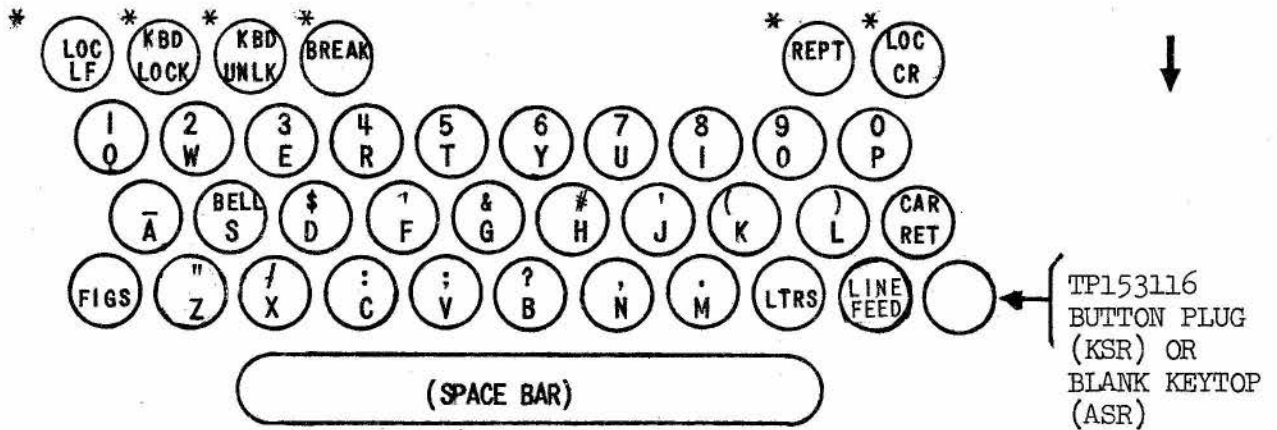

Fig. 1 Arrangement RA

* Indicates red body keytops with white characters. All other keytops gray-green body with white characters.

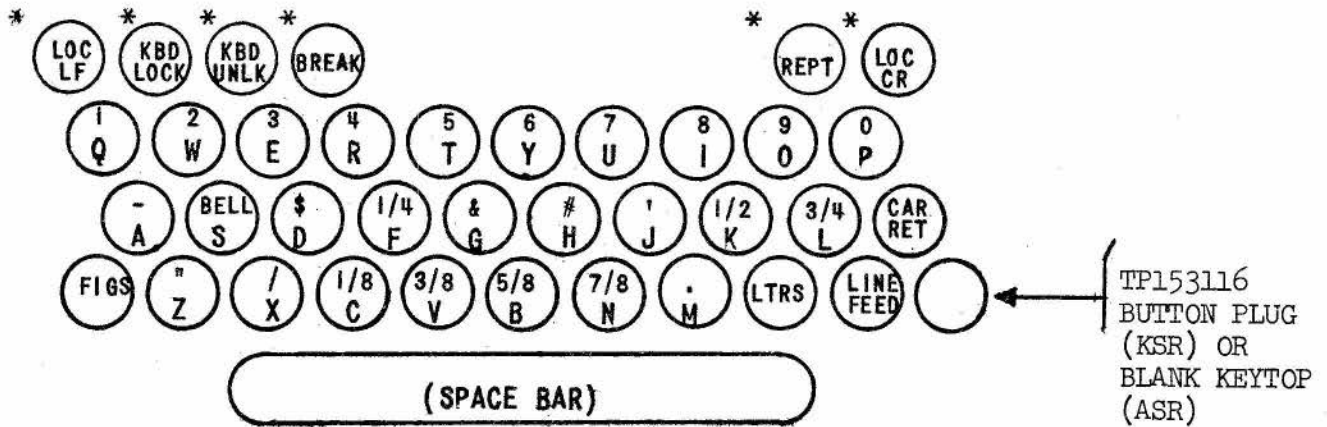

Fig. 2 Arrangement RB

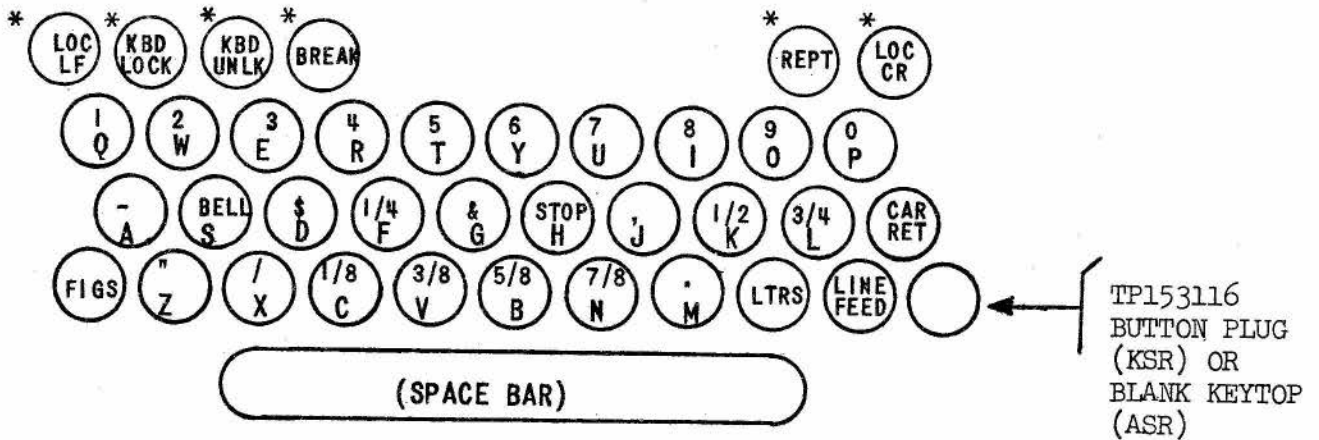

Fig. 3 Arrangement RC

KEY LEVER ASSEMBLY ARRANGEMENTS FOR NO. 28 TTY

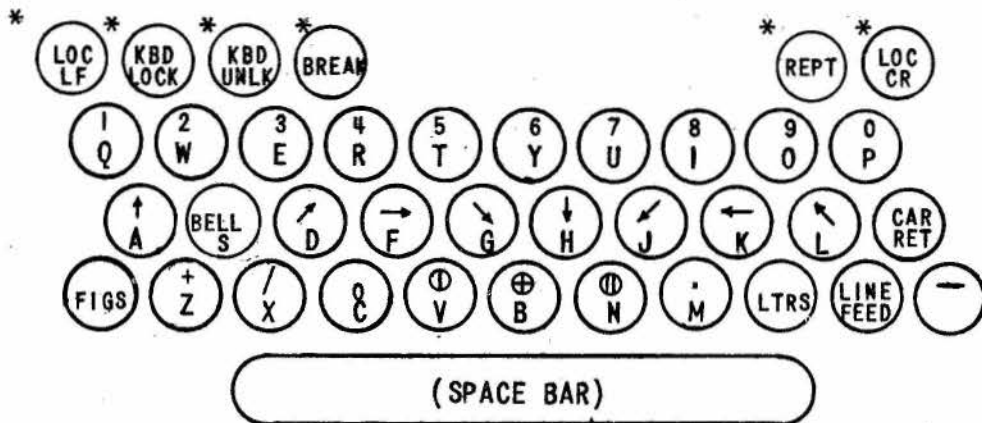

Fig. 4 Arrangement RD

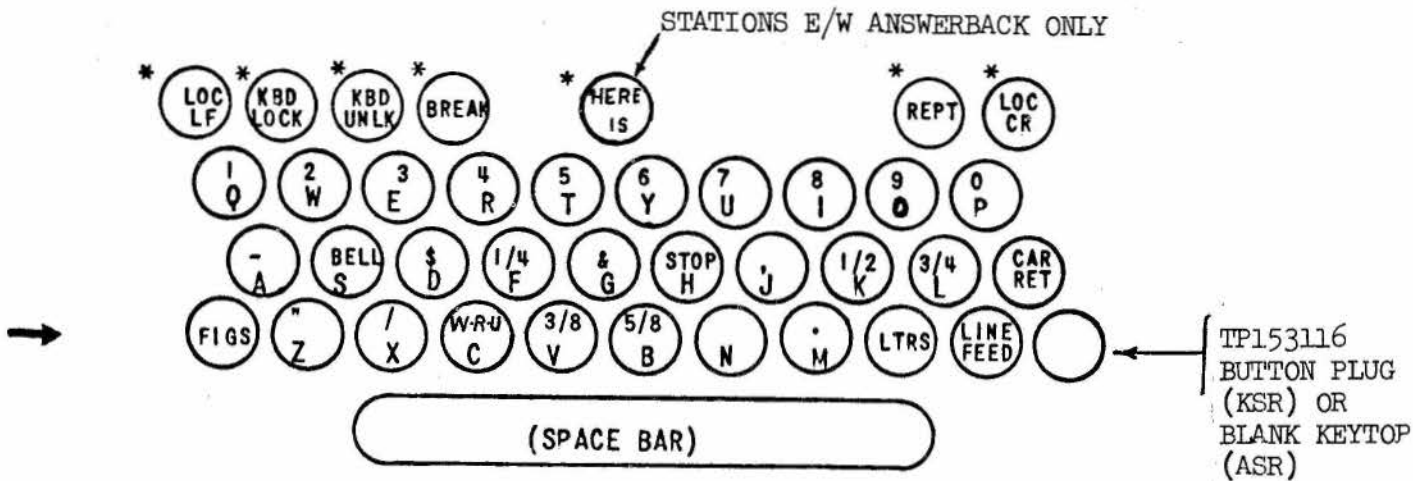

FIG. 5 - MODIFIED ARRANGEMENT "C" FOR TWX

NO. 28 TYPE TELETYPEWRITER (Cont'd)

28A Set of Gears

Set of gears consisting of a motor pinion and a countershaft gear to provide for operating the teletypewriter at 60 words per minute. Usable with either synchronous or governed motor.

28B Set of Gears

A set of gears similar to 28A set of gears for operating the teletypewriter at 75 words per minute.

28C Set of Gears

A set of gears similar to 28A set of gears for operating teletypewriter at 100 words per minute.

28A Motor Unit

A synchronous motor unit equipped with a starting relay.

28B Motor Unit

A series motor unit equipped with a centrifugal type governor and all the necessary components for governing and spark protection circuits. It is designed for operation of 110 a-c or 110-volt d-c with a suitable accessory mounted in the service assembly. Requires indicator TP104986 for setting speed. Speed is same as that of 28A motor.

28A Electrical Service Unit

A power service assembly for mounting in the 28-type cabinet. It is equipped with the line shunt relay, fuses, switches, wiring and cables with plug receptacles. It is not equipped with but has provision for mounting other accessory units such as motor stop mechanism, 100 Ma. rectifier line relay unit local test key, AC to DC applique, etc. (See following pages for description of accessory units).

28A40 Teletypewriter Cabinet

A cabinet for housing a 28-type sending-receiving or receiving-only teletypewriter. It is equipped with a copy lamp, an end of the line indicator signal lamp, a signal bell associated with the S contacts of the typing unit, the necessary cabling and terminal blocks for connecting the teletypewriter to the line circuit and built in copyholder and line guide. The lower portion of the cabinet has a shelf to mount a rectifier, and is equipped with a door that can be used as a maintenance tray. The upper section is equipped with a hinged cradle for the teletypewriter. The cabinet is finished in gray-green wrinkle. Other finishes may be ordered.

NO. 28 TYPE TELETYPEWRITER (Cont'd)

Auxiliary Features:
28A40 Copyholder

An offset copyholder designed for mounting on the right side of a teletypewriter apparatus cabinet. It is finished in grey-green wrinkle.

TP152910 AB Directory Holder

A holder similar to 38Y3816 except adapted for use with 28 type TTY.

TP152909 Auxiliary Apparatus Mounting Rack

A rack to mount auxiliary apparatus such as a teletypewriter subscriber set. Fastens in the lower portion of the 28A40 Cabinet. Will also mount other apparatus using standard 19 inch relay rack panels.

TP151822 Line Relay Unit

Provides mounting for 255A Relay in electrical service unit.

TP152744 Line Test Key

For mounting in electrical service unit.

TP151999 Rectifier

100 Ma. Rectifier for mounting in electrical service unit to provide direct current for selector magnets and line relay bias winding. Will not provide signal line current.

TP151400 Electrical Motor Control Mechanism

For mounting in electrical service unit to provide remote starting and stopping of TTY.

TP152021 DC Applique Unit

For mounting in electrical service unit to provide necessary resistances for motor and other circuits to permit DC operation.

TP152911 Break Key for Receiving-Only Base

For mounting in hole in R-O Keyboard normally filled by apparatus blank to provide Break Key for R-O TTY.

TP152904 Set of Conversion Key Levers

For use in converting Keyboard with Arrangement C to Arrangement D.

TP152905 Set of Conversion Keytops

For use in converting Keyboard with Arrangement C to Arrangement B.

TP152906 Set of Conversion Keytops

For use in converting Keyboard with Arrangement C to Arrangement A.

28 TYPE CABINETS

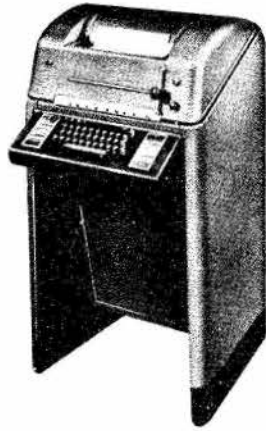

28 KSR
(Console Model)



28 RO
(Console Model)



28 KSR
(Table Model)

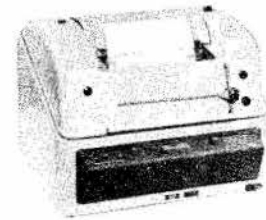

28 RO
(Table Model)



28 KSR
(Cover Model)

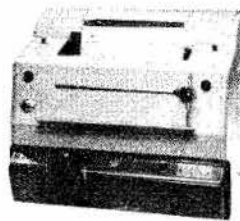

28 RO
(Cover Model)



28 ASR

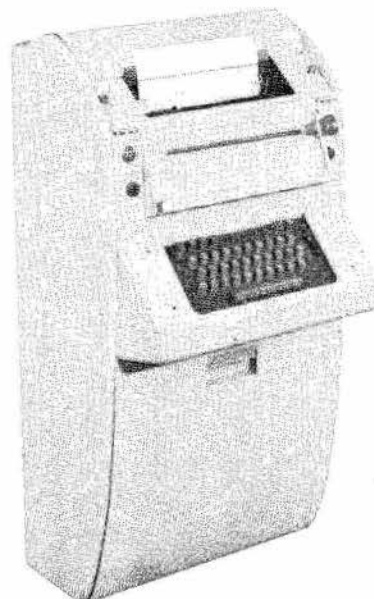

28 KSR
(Wall Mtd. Model)

28 TYPE CABINETS

28C40 Teletypewriter Cabinet (Manufacture Discontinued)

This cabinet is ELECTRICALLY the same as the 28B40 cabinet and requires the 28B Electrical Service Unit. It is designed for table mounting rather than for floor mounting. The cabinet is intended to be used only on D.C.

*28D40 Teletypewriter Cabinet

The 28D40 cabinet is similar to the 28B40 cabinet except for the wiring of the copy lamps. It is equipped with a transformer and two 6 volt copy lamps in parallel. This cabinet is to be used on AC only.

→ ••• 28E40 Teletypewriter Cabinet

The 28E40 cabinet is similar to the 28C40 cabinet except for the use of a transformer and two 6 volt copy lamps in parallel instead of the 60 volt copy lamps used on the 28C40. This cabinet is for use on A.C. current.

→ ••• 28F40 Teletypewriter Cabinet

The 28F40 cabinet is designed for use in the 82B System and arranged to house a 28 type Automatic Sending-Receiving Set.

This cabinet has an opening provided in the left front surface through which the forward portion of a 28B Transmitter-Distributor Unit will project. When the cabinet is equipped with a 28B Transmitter Distributor Unit and Base a 28B transmitter housing is used. When the cabinet is equipped with a 28C Transmitter Distributor and Base a 28C Transmitter housing is used.

The cabinet includes a compartment with hinged door for a 4A Tape Winder and a tape storage magazine for storage of tape between the punch block and the pivoted transmitter. Terminal blocks are provided on the rear wall of the cabinet for making connections to internal wiring of the units not provided by terminal blocks in the 28C Electrical Service Unit. There are two 6 volt copy lamps.

The cabinet is arranged for angle mounting details in the lower portion for holding relay racks.

*28G40 Teletypewriter Cabinet

→ The 28G40 cabinet is designed for general purpose use in housing a 28 Automatic Sending-Receiving Set. It is similar to the 28F40 cabinet except that the 28G40 has no tape winder compartment or tape bin. Included with the 28G40 is a relay rack mounting. This cabinet is designed for use with the 28F or 28G electrical service unit.

*These cabinets are equipped with directory holders.

28 TYPE CABINETS

GENERAL DESCRIPTION: The 28 type teletypewriter cabinet is a sheet metal enclosure designed to house the components of a receiving only, keyboard sending and receiving, or Automatic sending and receiving station.

↳ The upper section of the cabinet contains a cradle, copy lamps, an end of line indicator lamp, and various terminal blocks required for making connections to internal circuits not provided by the terminal blocks on the Electrical Service Unit. Major components of the station are mounted on the cradle. Covering the upper section is a hinged dome which contains various doors through which access to the page copy, tape reel, tape punch, or ribbon spools of the tape printer is attained. Mounted on the front of the dome is a copyholder and line guide. Cutouts are provided for mounting various units.

↳ The lower section of the console type cabinet is a compartment covered by a hinged door that may be used as a maintenance tray. Contained in this lower section is a signal bell associated with the "S" contacts of the typing unit and a mounting rack which will accommodate 19 inch mounting plates in the KSR Cabinets and 19 or 23 inch mounting plates in the ASR Cabinets.

↳ The 28 type cabinet standard finish is gray green vinyl but other finishes may be ordered when required. Approximate dimensions of the cabinet are as follows: KSR or RO Console Model - 40 1/2 inch high, 20 1/2 inches wide and 18 1/2 inch deep. Table Model - 16 inches high, 20 1/2 inches wide and 18 1/2 inches deep. ASR - 39 inches high, 36 inches wide and 18 1/2 inches deep. Wall Mounted Model (KSR) - 31 3/4 inches long, 16 1/2 wide and 14 1/4 inches deep. Wall Mounted Model (RO) 31 3/4 inches long, 16 1/2 inches wide and 10 1/2 inches deep.

Western Electric Company, Inc.
Telephone Sales Division - Excl. I.
Engineer of Shops



CODE DESIGNATION	WIRING DIAGRAM	TELETYPE CODE
28A45	P34.302	LAC202
28B45	P34.302	LAC202GA240
28C45	P34.302	LAC203GA241
28D45	P34.302	LAC217GA
28E45	P34.302	LAC203GA238
28F45	P34.319	LAAC235GA
28G45	P34.314	LAAC236GA
28H45	P34.314	LAAC233GA
28J45	P34.302	LAC216GA
28K45		LAC219GA
28LA45		NOTE 8
28LB45	P34.356	LAC215GA





28 TYPE TELETYPEWRITER CABINETS

WIRING DIAGRAM	TELETYPE CODE	ARRANGEMENT			COPYLIGHT		DIRECTORY HOLDER	NOTES	REMARKS
		RO-KSR		ASR	(2) 60 VOLT AC/DC	(2) 6 VOLT AC			
		CONSOLE	TABLE	CONSOLE					
34.302	LAC202	X					1	MANUFACTURE DISCONTINUED	
34.302	LAC202GA240	X			X		X	2	MANUFACTURE DISCONTINUED
34.302	LAC203GA241		X		X		X	2	MANUFACTURE DISCONTINUED
34.302	LAC217GA	X				X	X		
34.302	LAC203GA238		X			X	X		
34.319	LAAC235GA			X		X	X	3,4	83B SYSTEM
34.314	LAAC236GA			X		X	X	4,6	
34.314	LAAC233GA			X		X		5,6	BOEING LINE SWITCHING SYSTEM
34.302	LAC216GA	X				X		5	BOEING LINE SWITCHING SYSTEM
	LAC219GA		X					7	6A SWBD. CENTER - DIAL TWX
	NOTE 8			X		X	X	8	SEND STATION - DELTA LINE SW. SYS.
34.356	LAC215GA	X				X			RECEIVE STATION - DELTA LINE SW. SYS.

NOTE 1: O
 NOTE 2: D
 A
 b:
 A:
 NOTE 3: TH
 f:
 su
 A:
 W:
 th
 NOTE 4: TH
 28
 ar
 NOTE 5: Ac
 (e
 (h
 (c
 (d
 NOTE 6: Ho
 NOTE 7: Co
 NOTE 8: Te
 TE
 eq
 si
 co
 eq

Replacing Page 3 dated 4-13-62

NOTE 1: Original Copylight was a 115 Volt Flourescent Lamp.

NOTE 2: D.C. Operation only. Old style cabinets originally wired for A.C. or D.C. Operation should be modified for D.C. Operation by installation of a TP-154777 Mod. Kit. A D.C. Copylight Assembly.

NOTE 3: This cabinet is arranged to include a pivoted or a pivoted and fixed lead TD and is equipped with an opening in the left front surface through which the fixed TD of a 28B TD Unit projects. Also included is a compartment with hinged door for a 4A Tape Winder and a tape storage magazine for storage of tape between the punch block and the pivoted transmitter.

NOTE 4: The TP-152901 Copyholder previously provided on the 28F40 and 28G40 cabinets is not included on the 28F45 or 28G45 cabinets and must be ordered separately when required.

NOTE 5: Additional features are as follows:

- (a) Terminal blocks 41 to 80 (28H & 28J) and 181 to 220 (28H only) are furnished.
- (b) The lower left lamp in the dome is provided and equipped with a yellow lens instead of red.
- (c) Low paper and paper out contacts for sprocket feed paper are furnished.
- (d) A 28C Copyholder is furnished.

NOTE 6: Houses a fixed head transmitter distributor only.

NOTE 7: Copylights and indicator lamps operate on 48 volts, D.C.

NOTE 8: Teletype Code LAAC230GA E/W TP-145000 Dist. Panel Assem. and TP-145200 Key and Lamp Assembly. Designed to house Delta equipment. It includes a message tray mounted on the left side of the dome, a housing for the 28LA TD Unit, a chad container, and miscellaneous mounting details for Delta equipment.

SYS.
W. SYS.

FEATURES IN ADDITION TO GENERAL DESCRIPTION
 28 TYPE TELETYPEWRITER CABINETS

CODE DESIGNATION	WIRING DIAGRAM	TELETYPE CODE	ARRANGEMENT			COPYLIGHT		DIRECTORY HOLDER	NOTES (See Page 3A)	REMARKS
			RO-KSR		ASR	(2) 60 VOLT AC/DC	(2) 6 VOLT AC			
			CONSOLE	TABLE	WALL MTD					
28A45	P34.302	LAC202	X						1	MANUFACTURE DISCONTINUED
28B45	P34.302	LAC202GA240	X			X		X	2	MANUFACTURE DISCONTINUED
28C45	P34.302	LAC203GA241		X		X		X	2	MANUFACTURE DISCONTINUED
28D45	P34.302	LAC217GA	X				X	X		
28E45	P34.302	LAC203GA238		X			X	X		
28F45	P34.319	LAAC235GA				X	X	X	3,4	82B Switching System
28G45	P34.314	LAAC236GA				X	X	X	4,6	
28H45	P34.314	LAAC233GA				X	X		5,6	BOEING LINE SWITCHING SYSTEM
28J45	P34.302	LAC216GA	X				X		5	BOEING LINE SWITCHING SYSTEM
28K45	P34.302	LAC219GA		X					7	6A SWBD. CENTER - DIAL TWX
28L		LPC209			X				9,10	NEW YORK STOCK EXCHANGE - KSR
28L-1		LPC209BV			X				9,11	NEW YORK STOCK EXCHANGE - KSR
28M		LPC210			X				9,12	NEW YORK STOCK EXCHANGE - RO
28N		LAC222BV	X						11,13	101 ELECTRONIC SW. SYS.
28LA45		NOTE 8				X	X	X	8	SEND STATION - DELTA LINE SW. SYS.
28LB45	P34.356	LAC215GA	X				X			RECEIVE STATION - DELTA LINE SW. SYS

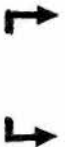

NOTES FOR 28 TELETYPEWRITER CABINETS:

1. Original Copylight was a 115 Volt Fluorescent Lamp.
2. D.C. Operation only. Old style cabinets originally wired for A.C. or D.C. Operation should be modified for D.C. Copylight Operation by installation of a TP-154777 Mod. Kit.
3. This cabinet is arranged to include a pivoted or a pivoted and fixed lead TD and is equipped with an opening in the left front surface through which the fixed TD of a 28B TD Unit projects. Also included is a compartment with hinged door for a 4A Tape Winder, a tape storage magazine for storage of tape between the punch block and the pivoted transmitter, and a total of 140 terminals on the "C" Terminal Strips.
4. The TP-152901 Copyholder previously provided on the 28F40 and 28G40 cabinets is not included on the 28F45 or 28G45 cabinets and must be ordered separately when required.
- 5. Included is a lower left dome lamp with a yellow lens in place of red, low paper and paper out contacts, a 28C Copyholder, a stunt box connector, a fuse, 40 additional terminals for the 28J cabinet and 80 additional terminals and a TP144958 Chad container for the 28H cabinet.
6. Houses a fixed head transmitter distributor only.
7. No transformer is provided; Copylights and indicator lamps operate on 48 volts, D.C.
8. Teletype Code LAAC230GA E/W TP-145000 Dist. Panel Assem. and TP-145200 Key and Lamp Assembly. Designed to house Delta equipment. It includes a message tray mounted on the left side of the dome, a housing for the 28LA TD Unit, a chad container, mounting details for Delta equipment, and 20 terminals on the "C" terminal strip.
- ↵ 9. Additional features of this cabinet include Identification card holders, a wall mount frame, a rubber-cushioned subframe for mounting the base, a Keyboard hood, a subframe for mounting the E.S.U., and various access doors. The copylights and terminal blocks are not furnished with this cabinet.
10. Finish is light and dark gray.
11. Finish is BV613A Federal Gray.
12. Additional features include a filler plate incorporating the local line feed, break and carriage return keys instead of the keyboard hood.
- ↵ 13. This cabinet, similar to the 28D cabinet, contains additional terminal blocks, resistors and wiring not found on the 28D.

CONVERSION OF
28 TYPE CABINETS

<u>Conversion</u>		<u>Installation Spec. No.</u>	<u>Parts Required</u>
<u>To</u>	<u>From</u>		
28B	28A	57758	TP152321

28 Type Covers

28A45 Teletypewriter Cover (Teletype LPC205GA)

This is a close fitting cover designed as special teletypewriter equipment for use in brokerage service where space is at a premium.

The cover is equipped with an end-of-line indicator lamp, a busy lamp, and 2 six volt copy lamps. It is furnished with a base plate.

The connections from the terminal block associated with the six volt transformer and from the primary side of the transformer which connect to the electrical service unit are by means of a plug and cord approximately 3 feet long.

The following brackets and associated parts are furnished for mounting on a standard electrical service unit:

- (A) A bracket plate which mounts on the front side of the electrical service unit, having two vertical extensions with turned over tabs to fit on the legs of the electrical service unit. The bracket is drilled to accommodate two rows of terminal blocks each having 40 terminals, numbers 1 to 40 at the bottom and numbers 41 to 80 at the top. Terminal blocks 1 to 40 are furnished with mounting details and terminal block insulators.
- (B) Two hanger brackets for the electrical service units are provided to extend under the ends of the electrical service unit.
- (C) Two additional brackets with wood screws are provided for mounting on the rear wall of a stand.
- (D) A cover consisting of a hinged sheet metal detail is provided which fastens under the bottom of the electrical service unit.
- (E) Magnetic latch fasteners are provided on the terminal block bracket to hold the cover in its upper position thus shielding the terminal blocks and mechanisms in the electrical service unit.

28 TYPE COVERS

28A-1 45 Teletypewriter Cover (Teletype LPC7298S GA)

This is a close fitting cover designed primarily for use in connection with the BMEWS system. The 28A-1 teletypewriter cover is the same as the 28A teletypewriter cover except that the parts for mounting and covering the electrical service unit are not supplied.

Two receptacles are required with the cover - one for connecting to the typing unit and the other for connecting to the base. No cords are furnished with the receptacles.

The finish of the cover is a dark gray enamel.

END OF SECTION

NO. 28 TYPE TYPING UNIT

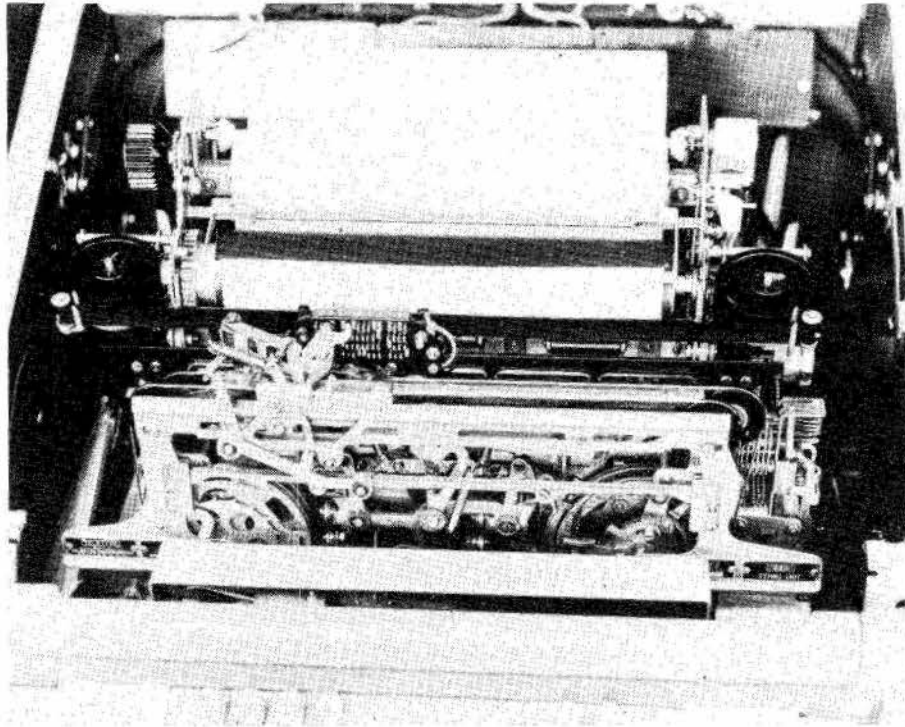

└─ TYPING UNIT

This unit incorporates the necessary electrical and mechanical features for translating the 5 unit code signals, at speeds of 60, 75 or 100 WPM, into mechanical action in order to record the message and perform the usual functions.

└─ The 5 unit code signals are applied to a electing mechaniam which interprets the signals and controls the motions involved in typing a character or performing a required function.

NO. 28 TYPE TYPING UNIT

└─┐ TYPING UNIT (Cont'd)

The motor is geared to the main shaft which extends motion to the keyboard mechanism. The typing and various functions are activated by individual clutches that completely disengage at the end of each operating cycle and thus reduce the motor load to the minimum when idling.

Type pallets are arranged in a compact, lightweight type box which must be ordered separately. A complete description of type box arrangements is included in Section 23I. In operation the type box keeps step with the printing carriage and presents the proper type pallets to the printing hammer to receive the printing strokes as the printing carriage advances along the line.

└─┐ All non-printing operations such as line feed, carriage return, shift, signal bell are controlled from a stunt box. The stunt box has slots for a total of 42 function bars. This is enough for the commonly used functions and leaves a reserve for many special features that may be added, including circuit switching.

NO. 28 TYPE TYPING UNITS

CONVERSION OF
28 TYPE TYPING UNITS

CONVERSION
TO FROM

PARTS REQUIRED

28A-1 28A

TP152316 Set of Parts (Sprocket Feed Parts)
Set of Parts from Columns A and B depending on
width of paper to be used.
TP153926 Set of Parts (Cabinet Parts)

<u>WIDTH OF PAPER</u>	<u>COLUMN A</u> <u>PAPER HANDLING PARTS</u>	<u>COLUMN B</u> <u>TRAY ASSEMBLY</u>
3-5/8"	TP153717	TP153726
4"	TP153716	TP153727
4-1/4"	TP153715	TP153728
4-5/16"	TP153714	TP153729
4-1/2"	TP153713	TP153726
5"	TP153712	TP153727
5-1/2"	TP153711	TP153726
5-3/4"	TP153710	TP153728
6"	TP153709	TP153727
6-1/4"	TP153708	TP153729
6-3/8"	TP153707	TP153728
6-1/2"	TP153706	TP153726
7"	TP153705	TP153727
7-1/2"	TP153704	TP153726
8"	TP153703	TP153727
8-1/2"	TP153702	TP153726
9	TP153701	TP153727

28A-2 28A

Same Parts are used on conversion from 28A to
28A-1 with addition of TP152304 Parts for
Horizontal Tabulation.

No. 28 Type Typing Units (Cont'd)

→ 28H-1 Typing Unit

This unit is used in the 83C1 Switching System. It is an adaptation of the 28H typing unit and provides the following features:

1. Shift to "select" condition on "upper case H LTRS" (slots 10 and 11) and momentarily close a contact (slots 27 and 28).
2. Shift to "nonselect" condition on "CAR RET, LINE FEED" (slots 13 and 14) and momentarily open a contact (slots 18 and 19).
3. Shift to "print" condition on receipt of 2 two-letter sequence such as AD or AF (these may be any characters except T, O, M, V or H), (slots 6 and 7, and 8 and 9)
4. Momentarily open a contact on receipt of "FIGS" in both the "select" and "nonselect" conditions (slot 23).
5. Momentarily close a contact on receipt of "LTRS" in both the "select" and "nonselect" conditions (slot 24).
6. Momentarily open a universal contact on receipt of any character in the "select" condition only (slot 25).
7. Momentarily close a contact on receipt of a character such as A in the "select" condition only (slot 33). (This may be any character except T, O, M, V or H).
8. Momentarily close a contact on receipt of a "SPACE" in both the "select" and "nonselect" conditions (slot 36).
9. Momentarily close a contact on receipt of a "K" in the "select" condition only (slot 38).
10. Other standard functions as in the 28H typing unit for machine operations.
11. Five universal function bars accompany the unit.

28H-2 Typing Unit

→ This unit is an adaptation of the 28H typing unit and provides the following features:

(Continued on next page)

No. 28 Type Typing Units (Cont'd)

28H-2 Typing Unit (Cont'd)

1. Shift to "select" condition on "upper case H LTRS" (slots 10 and 11) and momentarily close a contact (slots 27 and 28).
2. Shift to "nonselect" condition on CAR RET, LINE FEED" (slots 13 and 14) and momentarily open a contact (slots 18 and 19).
3. Shift to "print" condition on receipt of two letter sequence such as AD (these may be any characters except T, O, M, V or H) (slots 6 and 7).
4. Close and latch a contact on receipt of two letter sequence such as AE (these may be any characters except T, O, M, V or H) (slots 22 and 23). This contact unlatches on "upper case H LTRS."
5. Momentarily open a universal contact on receipt of any character in the select condition only (slot 25).
6. Momentarily close a contact on the receipt of letter "O" in the "select" condition only (slot 33).
7. Momentarily close a contact on the receipt of "double BLANK" in both "select" and "nonselect" condition, (slots 35 and 36).
8. Momentarily close a contact on the receipt of letter "V" in the select condition only (slot 38).
9. Other standard function as in the 28H typing unit for machine operations.
10. Four universal function bars accompany the unit.

28J Typing Unit

This typing unit is designed for use with the SAGE System. It is equipped with a special stunt box with parts to shift to the print condition on receipt of the character U. This unit types 5 characters per inch in the lines and is intended to be used with the 28F or 28F-1 type box. Other cut-on parts are intended to be used as arranged for upon installation. This typing unit is arranged for handling roll paper 8 1/2 inches wide.

28J-1 Typing Unit

This typing unit is designed for use with the SAGE System and Maine Line Network. It is the same as the 28J Typing Unit except that it is arranged for handling paper 4 1/4 inches wide.

↳ 28K Typing Unit

This unit is somewhat like the 28H typing unit with respect to contacts in the stunt box. It provides for the following:

1. Shift to "select" condition on "upper case H LTRS."
2. End of Address code is "CR LF."
3. Three sets of latching transfer contacts are provided each of which will operate on a two letter CDC in the "select" condition. All parts for contact operation on two of the CDC's, except function bars, are in the stunt box. These contacts are unlatched by the stripper bail. On these two CDC's, the unit will shift to "print" condition.
4. A transfer contact operates momentarily on "upper case H LTRS" in "select" or "nonselect" condition.
5. In "select" condition a contact latches open on reception of letter "K". Contact unlatches on "CR LF" sequence.
6. In "select" or "nonselect" condition a transfer contact operates and latches on reception of "upper case S." Contacts unlatch on operation of stripper bail.
7. In "select" or "nonselect" condition a contact breaks on reception of sequence "Figs, Ltrs, Figs, Figs." Contacts unlatch on operation of stripper bail.
8. The combination in Item 7 followed by a "blank" opens a contact which latches open. Contact closes on operation of stripper bail.
9. In "select" or "nonselect condition" a transfer contact operates and latches on reception of "blank." Unlatches on operation of stripper bail.
10. If "blank" in Item 9 is followed by "Ltrs" or "Figs" a contact latches open. Contact unlatches on operation of stripper bail.
11. In "select" or "nonselect" condition on every operation, a transfer contact shall operate momentarily. (Universal contact)
12. On "upper case S", in addition to feature provided in Item 6 above, the regular Bell contacts operate momentarily in print cond.
- ↳ 13. Eight universal function bars and one "Ltrs" function bar accompany each unit.

Western Electric Company, Inc.
 Service Division
 Distribution Engineering

FEATURES IN ADDITION TO GENERAL DESCRIPTION
 28 TYPE TYPING UNITS

CODE DESIGNATION	WIRING DIAGRAM (SEE P34.301) OR	TELETYPE CODE	PAPER FEED		STUNT BOX	HORIZONTAL TAB (NOTE 3)	NORMAL PAPER WIDTH ADJUST	NOTES	
			FRICITION	SPROCKET					
28A	ES-897220	LP5RX/AG003	A		AG		8-1/2	1	
28A-1	ES-897220			A-1	AG		8-1/2	1	
28A-2	ES-897220			A-2	AG	A2	8-1/2	1	
28B	ES-897220	LP86RX/AGX		B	AGX		8-1/2	4	
28B-1	ES-897220	LP31WB/AX		B-1	AX		7	8	AMA COMPUTE
28B-2	ES-897220	LP28RX/AES		B2	AES		8-1/2		REPUBLIC S
28C*	ES-897220			C*	AFP	C*	8-1/2	4	
28C	ES-897220	LP87RX/AGY		C	AGY	C	8-1/2	4	
28D	ES-897220	LP15RX/AR	D		AR		8-1/2		
28D-1	ES-897220	LP7287S	D-1		AR	D-1	5	1	BMEWS SYST
28E	ES-941461	LP19RX/AN	E		AN		8-1/2	2	SELECTIVE (
28F	ES-941461	LP88RX/AGZ		F	AGZ		8-1/2	2,4	SELECTIVE (
28G*	ES-941461			G*	AFW	G*	8-1/2	2,4	SELECTIVE (
28G	ES-941461	LP89RX/AHA		G	AHA	G	8-1/2	2,4	SELECTIVE (
28H	ES-942656	LP49RX/AED	H		AED		8-1/2	2	83B1 SELEC
28H-1	ES-942656	LP49RX/AFA	H1		AFA		8-1/2	2	83C1 SELEC
28H-2	ES-942656	LP49RX/AFB	H2		AFB		8-1/2	2	83C1 SELEC
28J	B-135539	LP41RX/AEG	J		AEG		8-1/2	2,4	SAGE SYSTEM
28J-1	B-135539	LP47RX/AEG	J1		AEG		4-1/4	2,4	SAGE SYSTEM
28K	B-132357	LP49RX/AFC	K		AFC		8-1/2	2	83C1 SELEC
28L	ES-129921	LP49RX/AFG	L		AFG		8-1/2	2,6	83B2 SELEC
28M	ES-942656	LP7380S		M	AED		8-1/2	1,2,4	83B1 SELEC
28M-1	ES-942656	LP7381S		M1	AFA		8-1/2	1,2,4	83C1 SELEC
28M-2	ES-942656	LP7382S		M2	AFB		8-1/2	1,2,4	83C1 SELEC
28N	ES-942656	LP7384S		N	AED	N	8-1/2	1,2,4	83B1 SELEC
28N-1	ES-942656	LP7385S		N1	AFA	N1	8-1/2	1,2,4	83C1 SELEC
28N-2	ES-942656	LP7386S		N2	AFB	N2	8-1/2	1,2,4	83C1 SELEC
28P	B-132357	LP7383S		P	AFC		8-1/2	1,2,4	83C1 SELEC
28R	B-132357	LP7387S		R	AFC	R	8-1/2	1,2,4	83C1 SELEC
28S	SD-70832-01-C8	LP92RX/AHD		S	AHD		8-1/2	2,4,6	83B2 SELEC
28T	SD-70832-01-C8	LP7388S		T	AFG	T	8-1/2	2,4,6	83B2 SELEC
28U	B-135549	LP90RX/AHB		U	AHB		4	4,5	BROKERAGE S
28W	B-135550	LP91RX/AHC		W	AHC		4	2,4,5	BROKERAGE S
28Y	SD-70832-01-C8	LP49RX/AGU	Y		AGU		8-1/2	6	DELTA LINE
28AA	B-132000	LP93RX/AHE		AA	AHE		8-1/2	7	BOEING SYS
28AB	B-134833	LP106RX/AHS	AB		AHS		8-1/2	9	DIAL TWX
28AC	B-135391	LP107RX/AHU		AC	AHU		8-1/2	9	DIAL TWX
28AD	B-134833	LP106RX/AHR	AD		AHR		8-1/2	10	DIAL TWX-S



FEATURES IN ADDITION TO GENERAL DESCRIPTION
28 TYPE TYPING UNITS

TYPE	PAPER FEED		STUNT BOX	HORIZONTAL TAB (NOTE 3)	NORMAL PAPER WIDTH ADJUST	NOTES	REMARKS
	FRICITION	SPROCKET					
003	A		AG		8-1/2	1	
		A-1	AG		8-1/2	1	
		A-2	AG	A2	8-1/2	1	
AGX		B	AGX		8-1/2	4	
AX		B-1	AX		7	8	AMA COMPUTER CIRCUIT
AES		B2	AES		8-1/2		REPUBLIC STEEL 81D1 SWITCHING SYSTEM
		C*	AFP	C*	8-1/2	4	
AGY		C	AGY	C	8-1/2	4	
AR	D		AR		8-1/2		
	D-1		AR	D-1	5	1	BMEWS SYSTEM
AN	E		AN		8-1/2	2	SELECTIVE CALLING SYSTEM
AGZ		F	AGZ		8-1/2	2,4	SELECTIVE CALLING SYSTEM
		G*	AFW	G*	8-1/2	2,4	SELECTIVE CALLING SYSTEM
AHA		G	AHA	G	8-1/2	2,4	SELECTIVE CALLING SYSTEM
AED	H		AED		8-1/2	2	83B1 SELECTIVE CALLING SYSTEM
AFA	H1		AFA		8-1/2	2	83C1 SELECTIVE CALLING SYSTEM
AFB	H2		AFB		8-1/2	2	83C1 SELECTIVE CALLING SYSTEM
AEG	J		AEG		8-1/2	2,4A	SAGE SYSTEM
AEG	J1		AEG		4-1/4	2,4A	SAGE SYSTEM AND MAINE LINE NETWORK
AFC	K		AFC		8-1/2	2	83C1 SELECTIVE CALLING SYSTEM
AFG	L		AFG		8-1/2	2,6	83B2 SELECTIVE CALLING SYSTEM
		M	AED		8-1/2	1,2,4	83B1 SELECTIVE CALLING SYSTEM
		M1	AFA		8-1/2	1,2,4	83C1 SELECTIVE CALLING SYSTEM
		M2	AFB		8-1/2	1,2,4	83C1 SELECTIVE CALLING SYSTEM
		N	AED	N	8-1/2	1,2,4	83B1 SELECTIVE CALLING SYSTEM
		N1	AFA	N1	8-1/2	1,2,4	83C1 SELECTIVE CALLING SYSTEM
		N2	AFB	N2	8-1/2	1,2,4	83C1 SELECTIVE CALLING SYSTEM
		P	AFC		8-1/2	1,2,4	83C1 SELECTIVE CALLING SYSTEM
		R	AFC	R	8-1/2	1,2,4	83C1 SELECTIVE CALLING SYSTEM
AHD		S	AHD		8-1/2	2,4,6	83B2 SELECTIVE CALLING SYSTEM
		T	AFG	T	8-1/2	2,4,6	83B2 SELECTIVE CALLING SYSTEM
AHB		U	AHB		4	4,5	BROKERAGE SERVICE
AHC		W	AHC		4	2,4,5	BROKERAGE SERVICE-SELECTIVE CALLING
AGU	Y		AGU		8-1/2	6	DELTA LINE SWITCHING SYSTEM
AHE		AA	AHE		8-1/2	7	BOEING SYSTEM
AHS	AB		AHS		8-1/2	9	DIAL TWX
AHU		AC	AHU		8-1/2	9	DIAL TWX
AHR	AD		AHR		8-1/2	10	DIAL TWX-SWBD. CENTER

NOTES:

1. Manufacture d
2. Auxiliary typ
Blocks are fu
units.
3. The TP152304
the horizonta
across the fr
TP152903 part
the spacing d
4. Sprocket feed
TP154770 Mod.
and form feed
disc set for
TP157274 clip
feature until
form lengths
when required
- 4A. Unit is equip
spacing for u
5. Typing unit i
feed of four
and arranged
6. TP163146 Mod.
contacts.
7. Typing unit i
activated by
tact operated
first charact
8. Equipped with
Keyboard lock
9. TP-178343 Mod
provided.
10. For use in 28
toring and se
Center. Feat
Unshift on Sp
U.C. "S".



TYPING UNITS FOR USE WITH AUTOMATIC LINE SWITCHING SYSTEMS

28LA Typing Unit (Teletype LP18RA/AGN)

This is a friction feed typing unit designed for use in the send set. A TP-152467 Auxiliary Connector and two normally open stunt box contacts over slots 29 & 30 are provided. Wiring is in accordance with Teletype Drawing WD4227.

28LB Typing Unit (Teletype LP82RA/AGQ)

This is a friction feed typing unit designed for use in the send set where monitoring on the send set will be required at times. A TP-152467 Auxiliary Connector, miscellaneous stunt box contacts, a universal contact assembly, and a paper-out contact are provided. Wiring is in accordance with Teletype Drawing WD4228.

28LC Typing Unit (Teletype LP82RA/AGR)

This is a friction feed typing unit designed for use in the receive set. It is similar to the 28LB Typing Unit except for the disconnection of the leads from the normally open stunt box contact over slot 30.

28LD Typing Unit (Teletype LP80RA/AGP)

This unit, designed for use in the receive set, is similar to the 28LB Typing Unit except for the following:

- (1) Paper-Out Contact is omitted.
- (2) Sprocket Feed is provided for 8 1/2" wide paper, 3 1/2" form.

28LE Typing Unit (Teletype LP81RA/AGP)

This unit, designed for use in the receive set, is similar to the 28LB Typing Unit except for the following:

- (1) Paper-Out Contact is omitted.
- (2) Sprocket Feed is provided for 6 1/2" wide paper, 4" form.

28LF Typing Unit (Teletype LP100RA/AHL)

This unit is the same as the 28LD Typing Unit except for the inclusion of "Automatic Carriage Return and Line Feed."

Company, Inc.

Engineering

FEATURES IN ADDITION TO GENERAL DESCRIPTION
28 TYPE TYPING UNITS (Cont'd)

	TELETYPE CODE	PAPER FEED		STUNT BOX	HORIZONTAL TAB (NOTE 3)	NORMAL PAPER WIDTH ADJUST	NOTES	REMARKS
		FRICTION	SPROCKET					
	LP97YK/AGE		AE	AGE		5	11,12,14	WALL MTD-N.Y. STOCK EXCHANGE
I-C3		AF				8- $\frac{1}{2}$	2,13	83B3 SELECTIVE CALLING SYSTEM
	LP95RX/AGE		AG	AGE		8- $\frac{1}{2}$	4,11,19	WALL MTD
	LP102RX/AGE		AH	AGE		5	4,11,19	WALL MTD
	LP96RX/AR	AJ		AR		8- $\frac{1}{2}$	11	WALL MTD
			AK			8- $\frac{1}{2}$	2,13,15	83B3 SELECTIVE CALLING SYSTEM
			AL		AL	8- $\frac{1}{2}$	2,13,15	83B3 SELECTIVE CALLING SYSTEM
I-C2		AM				8- $\frac{1}{2}$	2,17	83B3 SELECTIVE CALLING SYSTEM-R.O.
	LP115AK/AJB	AN		AJB		8- $\frac{1}{2}$	6,18	101 ELEC. SW. SYSTEM
			AP	AGX		-	4,11,16	WALL MTD

NOT
11.
12.
13.
14.
15.
16.
17.
18.
19.

DESCRIPTION
(Cont'd)

NOTES (Cont'd)

REMARKS
WALL MTD-N.Y. STOCK EXCHANGE
83B3 SELECTIVE CALLING SYSTEM
WALL MTD
WALL MTD
WALL MTD
83B3 SELECTIVE CALLING SYSTEM
83B3 SELECTIVE CALLING SYSTEM
83B3 SELECTIVE CALLING SYSTEM-R.O.
101 ELEC. SW. SYSTEM
WALL MTD

- 11. The side plates of the unit have been shortened and paper storing facilities have been eliminated. The driven gear is relocated on the mainshaft.
- 12. A YK Typebox, a Mod Kit for 8 Characters per inch spacing & 4 lines per inch vertical spacing are provided.
- 13. A TP178358 "STUNT SHIFT CONTROL" Mod. Kit and a TP163146 "Universal Contacts" Mod Kit are provided.
- 14. Vertical Tabulation and Form Feed Out similar to note 4 are provided except a gear and disc set for form length of $3\frac{1}{2}$ inches is furnished.
- 15. Vertical Tabulation and Form Feed Out parts for 8" long forms provided.
- 16. Width of paper must be specified in order.
- 17. A TP178358 "STUNT SHIFT CONTROL" Mod Kit is provided.
- 18. This unit, furnished with an AF Typebox, contains a set of code reading parts, is latched in the letters position, and contains features for providing carriage return and line feed either in association with or without signal bell. Features such as unshift on space, motor stop and keyboard lock and unlock are not provided on this unit.
- 19. Vertical spacing of 6 lines per inch is provided.

TYPING UNITS FOR USE WITH AUTOMATIC LINE SWITCHING SYSTEMS

28LA Typing Unit (Teletype LP18RA/AGN)

This is a friction feed typing unit designed for use in the send set. A TP-152467 Auxiliary Connector and two normally open stunt box contacts over slots 29 & 30 are provided. Wiring is in accordance with Teletype Drawing WD4227.

28LB Typing Unit (Teletype LP82RA/AGQ)

This is a friction feed typing unit designed for use in the send set where monitoring on the send set will be required at times. A TP-152467 Auxiliary Connector, miscellaneous stunt box contacts, a universal contact assembly, and a paper-out contact are provided. Wiring is in accordance with Teletype Drawing WD4228.

28LC Typing Unit (Teletype LP82RA/AGR)

This is a friction feed typing unit designed for use in the receive set. It is similar to the 28LB Typing Unit except for the disconnection of the leads from the normally open stunt box contact over slot 30.

28LD Typing Unit (Teletype LP80RA/AGP)

This unit, designed for use in the receive set, is similar to the 28LB Typing Unit except for the following:

- (1) Paper-Out Contact is omitted.
- (2) Sprocket Feed is provided for 8 1/2" wide paper, 3 1/2" form.

28LE Typing Unit (Teletype LP81RA/AGP)

This unit, designed for use in the receive set, is similar to the 28LB Typing Unit except for the following:

- (1) Paper-Out Contact is omitted.
- (2) Sprocket Feed is provided for 6 1/2" wide paper, 4" form.

28LF Typing Unit (Teletype LP100RA/AHL)

This unit is the same as the 28LD Typing Unit except for the inclusion of "Automatic Carriage Return and Line Feed."

↓

Western Electric Company, Inc.
 Service Division
 Distribution Engineering

SLOT NO.	STUNT BOX	AG	AN	AR
	TYPING UNIT	28A;28A-1;28A-2	28E	28D;28D-1
	T.P. NUMBER	152804	152810	154944
1	UNSHIFT ON SPACE	X	X	X
2	FIGURES SHIFT	X	X	X
3	LETTERS SHIFT	X	X	X
4	AUTO. CR-LF	-	-	-
5	CR	X	X	X
6			SU	
7			CDC	
8				
9				
10			FIG } ②	
11			● UCH }	
12				
13			CR } ③	
14			LF } SLIDE	
15			BL	
16			LF	
17				
18				
19				
20				
21		CLIP		
22		UCBL } MOTOR STOP		BL
23		UCH } SEQ. ①		
24				
25			SIG.BELL PUCS ①	
26			LETTERS ④	
27			SPACE ④	CLIP
28		BL	PS UNIV. ①	UCBL } MOTOR STOP
29		SIG.BELL UCS ①		UCH } ① SEQ.
30			FIG } ②	SIG.BELL PUCS ①
31			● UCH }	
32				
33				
34		CLIP		CLIP
35		BL } KYBD LOCK	BL } KYBD LOCK	BL } KYBD LOCK
36		BL } SEQ.	BL } SEQ.	BL } SEQ.
37		-	⑤	
38	SPACE SUPR ON LINE FEED	X	-	X
39	AUTO. CR - LF	-	-	-
40	LINE FEED	X	P-LF	P-LF
41	VERTICAL TABULATION			
42	PAGE FEED-OUT	X ⑨		

	AR	AX	AED	AEG	AES	A
	28D;28D-1	28B-1	28H; 28M; 28N	28J; 28J-1	28B-2	28H-1;2
	154944	154961	157400	157405	154948	15
	X]	X]	X]	X]	X]	
	X]	X]	X]	X]	X]	
	X]	X]	X]	X]	X]	
	-	-	-	X	-	
	X	X	X	-	X	
			} * *CDC]	LF BL		} *CDC *SLI
			} * *CDC]	SIG.BELL PUCS ① FIG.) ②		* } CDC * } SLI
			UCH } ②	• UCH }		UCH } (
			• LTR }			• LTR }
			SV }			
			CR } ③			CR } (
WIDE			LF } SLIDE	CR ③ SLIDE		LF } SL
			BL			BL
			LF			LF
			-			
			} *CDC			CR }
			} * ④	SU CDC]		LF }
			} *CDC			
			} * ④			
	BL		-		BL	
			- ④			FIG. (
			*TRANS ①			LTR. (
PUCS ①			*CONT. ④			*
			SIG.BELL PUCS ①			UCS
	CLIP		UCH } ① ②		CLIP	UCH }
①	UCBL } MOTOR STOP		• LTR } ④		UCBL } MOTOR STOP	• LTR }
	UCH } ① SEQ.				UCH } SEQ ①	
	SIG.BELL PUCS ①				SIG.BELL PUCS ①	
			} *AUTO ④	FIG } ②		
			• SV } TRANS ①	• UCH }		*
			} *CONT. ④			
LOCK	CLIP		BL } CONT.		CLIP	
	BL } KYBD LOCK		BL } SEQ. ①		BL } KYBD LOCK	
	BL } SEQ.		NON-P L.F.		BL } SEQ.	SP
	X		S UNIV ①	PUCS ⑥	LF	SK
	-		-	P-LF ⑥	-	
	P-LF	LF ON CR	P-L.F.	PCR	P-LF	P-LF
			X ⑫			
			X ⑫			

STUNT BOXES USED IN 28 TYPE TYPING UNITS

AES	AFA	AFB	AFC	AFG	AGE
28B-2	28H-1;28M-1;28N-1	28H-2;28M-2;28N-2	28K;28P;28R	28L, 28T	28AE;28AG;28AF
154948	157401	157402	157404	162296	164320
X	X	X	X	X	X
X	X	X	X	X	X
X	X	X	X	X	X
-				X	-
X	X	X	X		X
	} *CDC-SEQ	} *CDC-SEQ	} *CDC-SEQ	LF	
	} *SLIDE	} *SLIDE	} *SLIDE	UCH } ①	
	* } CDC-SEQ		* } CDC-SEQ	• LTR } SEQ ④	
	* } SLIDE		* } SLIDE	PUCS BELL ①	
	UCH } ②	UCH } ②	• UCH } ②	* } TRANS.START ①	
	• LTR }	• LTR }	LTR }	S.M CONT.SEQ. ④	
				* } 2 LTR.CDC ④	
	CR } ③	CR } ③	CR } ③	* } ⑧	
	LF } SLIDE	LF } SLIDE	LF } SLIDE	S. CR	
	BL	BL	BL	S. LF ①	
	LF	LF	LF	** } CDC	
				** } SEQ ①⑦	
	CR } ③	CR } ③	* } CDC-SEQ	** } CDC	
	LF } ④	LF } ④	* } ⑦	** } SEQ	
			* } CDC-SEQ	** } CDC	
			* } ⑦	** } SEQ	
BL		* } CDC ①	* } CDC-SEQ	** } CDC	BL
	FIG. ④	* } SEQ ④	* } ⑦	** } SEQ	
	LTR. ①		UCH } ②	** } CDC	
	* 4	S UNIV ④	• LTR } ⑦	** } SEQ	
	UCS ①	UCS ①	PC UCS BELL ⑦	** } CDC	
CLIP	UCH } ① ②	UCH } ①	UCS ⑦	** } SEQ	CLIP
UCBL } MOTOR STOP	• LTR } ④	• LTR } ④	FIGS LTRS ⑦	* } CDC	UCBL } MOTOR S
UCH } SEQ ①			CR	* } SEQ	UCH } ① SEQ.
SIG.BELL PUCS ①			LF	** } CDC	SIG.BELL PUC
			SK ⑦	** } SEQ	
			FIG } TRANS		
	* ①	SO ①	LTR } START	UCH } ③	
CLIP			FIG } SEQ.	• LTR } SEQ	CLIP
BL } KYBD LOCK		BL } SEQ.	FIG } ⑦	BL } ⑨	BL } KYBD LOC
BL } SEQ.	SP ①	BL } ①	BL } ⑦	BL } ①	BL } SEQ.
-			BL } ⑩ ⑦	S. LTR ①	
LF	SK ①	SV ①	FIG LTR } ⑦	• S. M-V ①	X
-			* ⑦	S.V ⑧	-
P-LF	P-LF	P-LF	P-LF	LF	P-LF
	X ⑬	X ⑭	X ⑮	X ⑯	
	X ⑬	X ⑭	X ⑮	X ⑯	X



CFG	AGE	AGN	AGP	AGQ	AGR	SLOT NO.
ST	28AE;28AG;28AH	28LA	28LD, 28LE	28LB	28LC	1
	164320	145303	145306	145305	145304	2
	X]	*]	*]	*]	*]	3
	X]	X]	X]			4
	X]	X]	X]			5
	-	-	-	-	-	6
	X	X	X	X	X	7
						8
①						9
SEQ ④						10
BELL ①						11
ANS.START ①						12
ONT.SEQ. ④						13
LR.CDC ④						14
						15
						16
①]						17
CDC						18
SEQ ①7						19
CDC			N }	N }	N }	20
SEQ			N }	N }	N }	21
CDC			N } DISCONNECT	N } DISCONNECT	N } DISCONNECT	22
SEQ			N } SEQ. ④	N } SEQ. ④	N } SEQ. ④	23
CDC	BL		BL	BL	BL	24
SEQ						25
CDC			UCS-BELL ①	UCS-BELL ①	UCS-BELL ①	26
SEQ						27
CDC			D } ①1	D } ①1	D } ①1	28
SEQ	CLIP		L } ①	L } ①	L } ①	29
CDC	UCBL } MOTOR STOP	CR }	SP } ④	SP } ④	SP } ④	30
SEQ	UCH } ① SEQ.	LF } ①		CR } MONITOR		31
CDC	SIG.BELL PUCS ①	UCS-BELL ①		LF } BLIND.SEQ. ①		32
SEQ						33
						34
③						35
SEQ	CLIP					36
⑨	BL } KYBD LOCK					37
①	BL } SEQ.					38
①			LF			39
①	X	X	CR } SEQ.	X	X	40
⑧			PLF }			41
	P-LF	PLF	N }	PLF	PLF	42
①6			N }			43
①6	X		N } FORM OUT			44
			N } SEQ.			45

AGR		SLOT NO.	NOTES & LEGEND	
	28LC			
	145304			
	*	1	X = ITEM PRESENT IN ACCORDANCE WITH BASIC SLOT ASSIGNMENT.	
		2	- = SLOT EMPTY, ITEM ABSENT, OR IN DIFFERENT SLOT.	
		3	UC = UPPER CASE	
	-	4	BL = BLANK	
	X	5	S = SELECT	
	-	6	CDC = CALL DIRECTING CHARACTERS.	
	-	7	P = PRINT	
	-	8	* = FUNCTION BARS TO BE ORDERED SEPARATELY.	
	-	9	** = FUNCTION PARTS TO BE ORDERED SEPARATELY.	
	-	10	CONT. = CONTROL	
	-	11	SEQ. = FUNCTION PERFORMED ONLY ON SEQUENTIAL RECEPTION OF DESIGNATED CODE CHARACTERS.	
	-	12	⌞ = FUNCTION LEVER TO OPERATE TWO CONTACTS.	
	-	13	⌋ = FUNCTION LEVER OPERATES CONTACT IN LOWER NUMBER SLOT.	
	-	14	⌋⌋ = SAME SLIDE FOR TWO OR MORE FUNCTION LEVERS.	
	-	15	⬮ = LATCH RELEASE BAIL WHICH RELEASES LATCHED MECHANISM AS INDICATED.	
	-	16	SLIDE = CONTROL OF MARKING AND SPACING POSITIONS OF ASSOCIATED CODE BARS.	
	-	17		
	N	18	① = NORMALLY OPEN CONTACT	⑭ = EXCEPT 28H-2
	N	19	② = END OF MESSAGE SEQUENCE	⑮ = EXCEPT 28K
CONNECT	N DISCONNECT	20	③ = END OF ADDRESS SEQUENCE	⑯ = EXCEPT 28L
①	N SEQ. ④	21	④ = NORMALLY CLOSED CONTACT	⑰ = HORIZ. TAB. FOR 28T TYPING UNIT
	BL	22	⑤ = NON-PRINT LINE FEED KYBD. LOCK, UNSELECTED UNITS	⑱ = KEYBOARD LOCK, UNSELECTED UNITS
		23	⑥ = SPECIAL PAWLS REQUIRED	⑲ = TRANS. START CONT. SEQ.
①	UCS-BELL ①	24	⑦ = TRANSFER CONTACT - REAR CONT. NORMALLY OPEN	⑳ = TRANSFER CONTACT - REAR CONT. NORMALLY CLOSED
		25	⑧ = ANSWER BACK	
①	D } ⑪	26	⑨ = AUTO. TRANS. START STOP SEQ.	
①	L } ①	27	⑩ = EMERGENCY START STOP SEQ.	
①	SP } ④	28	⑪ = CONFORMATION SEQ.	
R	-	29	⑫ = EXCEPT 28H	
①	-	30	⑬ = EXCEPT 28H-1	
	-	31		
	-	32		
	-	33		
	-	34		
	-	35		
	-	36		
	-	37		
	X	38		
	-	39		
	PLF	40		
	-	41		
	-	42		

Western Electric Company, Inc.
 Service Division
 Distribution Engineering

SLOT NO.	STUNT BOX	AGU	AGX	AGY
	TYPING UNIT	28Y	28B	28C
	T.P. NUMBER	174477	164322	164321
1	UNSHIFT ON SPACE	X	X	X
2	FIGURES SHIFT	X	X	X
3	LETTERS SHIFT	X	X	X
4	AUTO. CR-LF	CR	-	-
5	CR	UCH } ②	X	X
6		• LTR } ④		
7		*TRANS. START ①		
8		*ROTR-CDC ④		
9		UCS ①		
10		*2 LTR CDC ④		
11		* SEQ.		
12		LF		
13		SEL CR } ③		
14		SEL LF }		
15		*)		
16		* 5 LTR		
17		* GRP CALL		PUCG HORI
18		* 1ST LTR		
19		* COMM.		
20		* ①		
21		*)		
22		*)	BL	BL
23		* 4 LTR		
24		* GRP CALL		
25		* 1ST LTR		
26		* COMM.		
27		*)	CLIP	CLIP
28		* 2 LTR	UCBL } MOTOR STOP	UCBL } MOI
29		* CDC	UCH } SEQ. ①	UCH } SEQ
30		* 2 LTR	PUCS-BELL ①	PUCS-BELL
31		* CDC		
32		UCH } ② ①		
33		• LTR } ④		
34		SEL-M-V	CLIP	CLIP
35		SEL LTR	BL } KYBD LOCK	BL } KYBD I
36		* ④	BL } SEQ.	BL } SEQ.
37		• SEL-M-V		
38	SPACE SUPR ON LINE FEED	BL } ①	X	LF
39	AUTO. CR - LF	BL }		
40	LINE FEED	PLF	PLF	PLF
41	VERTICAL TABULATION	-	X - UCJ	X - UCJ
42	PAGE FEED-OUT	-	X - UCZ	X - UCZ

STUNT BOXES USED IN 28 TYPE TYPING UNITS (Cont'd)

AGX 28B	AGY 28C	AGZ 28F	AHA 28G	AHB 28U	AHC 28W
164322	164321	176485	176486	164323	176484
X]	X]	X]	X]	X]	X]
X]	X]	X]	X]	X]	X]
X]	X]	X]	X]	X]	X]
-	-	-	-	-	-
X	X	X	X	X	X
		SEL - UCDC]	SU } CDC]	-	SU CDC]
				-	
				-	
				-	
		FIG. } ②	FIG. } ②	-	FIG. } ②
		• UCH }	• UCH }	-	• UCH }
				-	
		CR } ②	CR } ③	-	CR } ③
		LF } SLIDE	LF } SLIDE	-	LF } SLIDE
		BL	BL	-	BL
		LF	LF	-	LF
	PUCG HORIZ.TAB.		PUCG-HORIZ TAB	-	-
			-	-	-
			-	-	-
			-	-	-
			-	-	-
BL	BL	BL	-	BL	-
			-	-	-
			-	-	-
		PUCS-BELL ①	PUCS-BELL ①	-	PUCS-BELL ①
		LTR ①	LTR ④	-	LTR ④
CLIP	CLIP	SPACE ④	SPACE ④	CLIP	SPACE ④
UCBL } MOTOR STOP	UCBL } MOTOR STOP	PS UNIV ①	PS UNIV ①	UCBL MOTOR STOP	PS UNIV ①
UCH } SEQ. ①	UCH } SEQ. ①		-	UCH SEQ. ①	-
PUCS-BELL ①	PUCS-BELL ①	FIG. } ②	FIG. } ②	PUCS-BELL ①	FIG. } ②
		• UCH }	• UCH }	-	• UCH }
			-	-	-
			-	-	-
CLIP	CLIP		-	CLIP	-
BL } KYBD LOCK	BL } KYBD LOCK	BL } KYBD LOCK	BL } KYBD LOCK	BL } KYBD LOCK	BL } KYBD LOCK
BL } SEQ.	BL } SEQ.	BL } SEQ.	BL }	BL } SEQ.	BL } SEQ.
		LF (18)	LF (18)	-	LF (18)
X	LF		-	X	-
			-	-	-
PLF	PLF	PLF	PLF	PLF	PLF
X - UCJ	X - UCJ	X - UCJ	X - UCJ	X - UCJ	X UCJ
X - UCZ	X - UCZ	X - UCZ	X - UCZ	X - UCZ	X UCZ

	AHC	AHD	AHE	AHL	AHR	A
	28W	28S	28AA	28LF	28AD	28
	176484	176487	176652	145883	165664	165665
	X	X	X	*	X	X
	X	X	X	X	X	X
	X	X	X	X	X	X
	-	X	-	X	-	
	X	-	X	X	X	X
	SU CDC	LF	-	-		
		UCH } ①	BL	-		
		LTR } SEQ. ④	NON-P UNIV	-		
		UCS-BELL ①	-	-		
	FIG. ②	* } ①⑨	-	-		
	UCH	SEL. M } ④	-	-		
		*}2 LTR CDC ④	LF	-		
	CR ③	*} ⑧	BL	-		
	LF SLIDE	SEL CR } ①	LTR	-		
	BL	SEL LF } ①	BL	-		
	LF	} CDC	N } ⑦	-		
	-	} SEQ.	-	-		
	-	} CDC	-	N		
	-	} SEQ.	-	N		
	-	} CDC	-	N ④		
	-	} SEQ.	-	N DISCONN. SEQ.		
	-	} CDC	BL	BL	BL	BL
	-	} SEQ.	FIG } ⑦	-		
	-	} CDC	UCC } ⑦	UCS-BELL ④		
	PUCS-BELL ①	} SEQ.	-	-		
	LTR ④	} CDC	UCH ⑦	U } ①⑧		
	SPACE ④	} SEQ.	-	A } ①		
FOR STOP	PS UNIV ①	*} CDC	-	SP } ④		PUCS-BE
Q. ①	-	*} SEQ.	-	-		
LL ①	FIG. } ②	} CDC	PUCS-BELL ①	-		
	UCH }	} SEQ.	-	-		
	-	-	-	-		FIG
	-	UCH } ③	-	-		FIG
	-	LTR }	-	-		C
ED LOCK	BL } KYBD LOCK	BL } ⑨	BL } KYBD LOCK	-	BL } KYBD LOCK	BL } KYB
Q.	BL } SEQ.	BL } ①	BL } SEQ.	LF	BL } SEQ.	BL } S
	LF ①⑧	SEL. LTR ①	-	CR } LINE FEED		
	-	SEL. M-V ①	LF	LF } SEQ.	LF	LF
	-	SEL. V ⑧	-	X		
	PLF	LF	PLF	N	PLF	PLF
	X UCJ	X-UCJ	-	N } FORM OUT		
	X UCZ	X-UCZ	NON-P Z ①	N } SEQ.		

AHR	AHS	AHU	SLOT NO.
28AD	28AB	28AC	
165664	165665	165666	
X]	X]	X]	1
X]	X]	X]	2
X]	X]	X]	3
-	-	-	4
X	X	X	5
			6
			7
			8
			9
			10
			11
			12
			13
			14
			15
			16
			17
			18
			19
			20
			21
BL	BL	BL	22
			23
			24
			25
			26
			27
	PUCS-BELL ①	PUCS-BELL ①	28
			29
			30
			31
	FIG ④	FIG ④	32
	FIG	FIG	33
	c } ⑧ ⑳	c } ⑧ ⑳	34
L } KYBD LOCK	BL } KYBD LOCK	BL } KYBD LOCK	35
L } SEQ.	BL } SEQ.	BL } SEQ.	36
			37
LF	LF	LF	38
			39
PLF	PLF	PLF	40
		X - UCJ ④	41
		X - UCZ ①	42

See Page 7 for notes

END OF SECTION

28 TYPE TELETYPEWRITER BASES

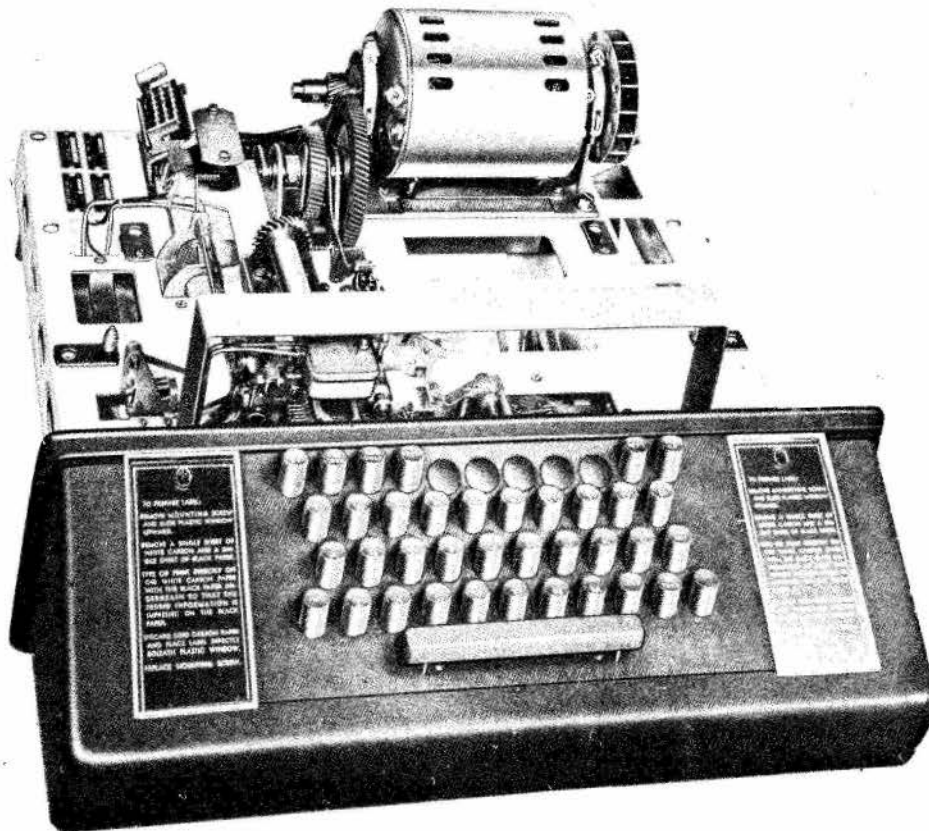

➤ GENERAL DESCRIPTION

The Teletypewriter Base supports the motor and typing units which must be ordered separately in addition to the required set of gears. Receiving Only Bases are equipped with local line feed and local carriage return keys located on its front plate. The keyboard, which is furnished as part of the send-receive base only, has the following features:

- 1. A standard three-row arrangement of green keys with numerals, punctuation marks and special symbols available on upper case position.

28 TYPE TELETYPEWRITER BASES

GENERAL DESCRIPTION (Cont'd)

2. Special red keys in a top fourth row to provide local line feed, keyboard lock, keyboard unlock, line break, repeat operation and local carriage return features. Additional red keys are provided when the base is equipped with special features such as Answer-Back and provision is made for the addition of red keys to operate features added to the base as required.
3. Keytop Arrangement "C" is provided as standard except for "Modified Arrangement C" on special bases designed for Boeing and Dial TWX. Modifications will be specified in applicable notes. Keytop arrangements A, B and D are acquired through use of Modification Kits which may be ordered separately.
4. A signal generator, a blank code lever, a margin indicator switch, cabling and connectors are provided.
5. The space bar in the keyboard will provide repeated spacing in addition to single space by pressing the bar fully down.
6. The front of the keyboard protrudes beyond the cabinet and is fitted with a rubber pad that seals the edges of the base for a silencing effect.

MODIFICATION KITS FOR CONVERSION OF KEYBOARD TYPE ARRANGEMENTS

TP152904 SET OF CONVERSION KEY LEVERS

For use in converting keyboard with Arrangement C to Arrangement D.

→ In addition to the TP152904 S.O.P. a TP152675 Function Bar is required which provides for spacing on upper case "Blank".

TP152905 SET OF CONVERSION KEY LEVERS

For use in converting keyboard with Arrangement C to Arrangement B.

TP152906 SET OF CONVERSION KEY LEVERS

For use in converting keyboard with Arrangement C to Arrangement A.

IN ADDITION TO THE STANDARD FEATURES SPECIFIED UNDER GENERAL DESCRIPTION BASES ARE EQUI

CODE DESIGNATION	WIRING DIAGRAM	TELETYPE CODE	SERVICE		KYBD. ARRAN.		FILTERS		FEATURES INCLUDE								NOTES (PAGES 3 & 4)	RE
			SEND & RECEIVE	RECEIVE ONLY	"C"	MODIFIED C	R. F. FILTER	185A NETWORK	BUSY KEY (IN HOOD)	POWER SW.	28D-1 DISTRIBUTOR	MAGNETIC GEAR SHIFLT	MANUAL GEAR SHIFLT	ANSWER BACK S.O.P.	FORM OUT SOLENOID	UNIVERSAL CONTACT		
28A	ES-897220	-	X		X		X										1	MANUFACTURE
28B	ES-897220	LB4/146		X													2	
28B-1	ES-897220	LB4/218		X				X									2	81D1 SW. 9
28B-2		LB7288S		X						X							2,12	BMEWS SYST
28C	ES-932783	LK5RC131	X		X		X											MANUFACTURE
28C-1	ES-932783	-	X		X		X										3	MANUFACTURE
28D	ES-932783	LK16ARC	X		X		X										4,5	
28E	WD3814	LK22BRS	X		X		X	X									5,6	BROKERAGE
28F	WD3810	LB9/146		X				X									6	BROKERAGE
28G	WD4343	LK26BRX	X			X	X			X	X	X	X	X			5,7	BOEING LIM
28H	-	*	X			X								X			5,8,9	DIAL TWX
28H-1	-	*	X			X											5,8	DIAL TWX
28J	-	LK32BRX	X			X						X					5,10	DIAL TWX
28K	B-136594	LK27ARC	X		X		X	X									5,11	WALL MTD.
28L	B-136670	LB31		X				X									5,11	WALL MTD.
28M		LK45BSD	X														13	101 ELECT

*Converted from 28D Keyboard per RS-581.84 Section AA

28 TELETYPEWRITER BASES

SPECIFIED UNDER GENERAL DESCRIPTION BASES ARE EQUIPPED AS FOLLOWS:

KEYED. ARRAN.		FILTERS		FEATURES INCLUDE								NOTES (PAGES 3 & 4)	REMARKS
"C"	MODIFIED C	R. F. FILTER	185A NETWORK	BUSY KEY (IN HOOD)	POWER SW.	28D-1 DISTRIBUTOR	MAGNETIC GEAR SHIFT	MANUAL GEAR SHIFT	ANSWER BACK S.O.P.	FORM OUT SOLENOID	UNIVERSAL CONTACT		
X		X										1	MANUFACTURE DISCONTINUED
												2	
				X								2	81D1 SW. SYSTEM
						X						2,12	BMEWS SYSTEM
X			X										MANUFACTURE DISCONTINUED
X			X									3	MANUFACTURE DISCONTINUED
X			X									4,5	
X			X	X								5,6	BROKERAGE SERVICE
				X								6	BROKERAGE SERVICE
	X		X			X	X	X	X	X	X	5,7	BOEING LINE SW. SYSTEM
	X								X			5,8,9	DIAL TWX
	X											5,8	DIAL TWX
	X						X					5,10	DIAL TWX - SWBD. CENTER
X			X	X								5,11	WALL MTD. N.Y. STOCK EXCH.
				X								5,11	WALL MTD. N.Y. STOCK EXCH.
												13	101 ELECTRONIC SW, SYS.

NOTES:

1. This unit is equipped with contacts of the signal generator. Key mechanism which provides use with 28A ESU Only.
2. Base may be equipped with a
3. Similar to the 28C TTY Base isolated from the sending contact of the connecting plug.
4. Replaces the 28C TTY Base. signal generator instead of on
5. E/W an interconnecting drive cams and a roller-type latch for
6. The Power Switch is mounted keyboard hood in the present location. The plate is replaced by a stainless steel plate to the position of the upper roller to prevent accidental operation of the right portion of the base hood,
7. The keyboard is E/W Arrangement U.C. "C", a red "Here is" key for top in place of the button plug and de-energized for 100 WPM with a contact is operated by a cam utilized to prevent operation of Also included with the base is a resistor and a terminal block with
8. Arrangement "C" modified by a TP154147 "Local Paper Feedout
9. E/W TP178344 Modification Key, TP164129 basic Answerback feature.

81.84 Section AA



TELETYPE WRITER BASES

DETAILED AS FOLLOWS:

MARKS
DISCONTINUED
SYSTEM
DISCONTINUED
DISCONTINUED
SERVICE
SERVICE
SW. SYSTEM
SWBD. CENTER
.Y. STOCK EXCH.
.Y. STOCK EXCH.
NIC SW, SYS.

NOTES:

1. This unit is equipped with a break key which opens the keyboard contacts of the signal generator. It may be equipped with a TP154726 Break Key mechanism which provides separate break key contacts. Designed for use with 28A ESU Only.
2. Base may be equipped with a TP152344 Break Key when required.
3. Similar to the 28C TTY Base except that the break contacts are isolated from the sending contacts and brought out to isolated terminals of the connecting plug.
4. Replaces the 28C TTY Base. The 185A Network is mounted in the signal generator instead of on the base.
5. E/W an interconnecting drive between signal contact and activating cams and a roller-type latch for code bars.
6. The Power Switch is mounted on the 28E Base at the right side of the keyboard hood in the present location of the plastic identification plate. The plate is replaced by a stainless steel plate. The switch is as close to the position of the upper row of keys as possible and is E/W a guard to prevent accidental operation. Mounted in the 28F Base on the upper right portion of the base hood, it is E/W a guard similar to the 28E Base.
7. The keyboard is E/W Arrangement C modified by a Maltese Cross on U.C. "C", a red "Here is" key for Answer-Back trip off and a blank key top in place of the button plug. The gear shaft is energized for 60 WPM and de-energized for 100 WPM with no provision for 75 WPM. The universal contact is operated by a cam on the signal generator shaft and is utilized to prevent operation of the originating station answer back. Also included with the base is a pinion gear for the motor, a 500 ohm resistor and a terminal block with 9 terminals.
8. Arrangement "C" modified by WRU on U.C. C and Blank on U.C. N. plus a TP154147 "Local Paper Feedout" Mod. Kit are provided.
9. E/W TP178344 Modification Kit which contains TP163852 "Here Is" Key, TP164129 basic Answerback Mechanism and TP178349 Noncontention feature.



(Notes Cont'd on Page 4)

NOTES:

- 10. An "End-of-Line" indicator and type arrangement "C" modified by WRU or U.C. "C" and a Blank key lever and keytop are provided. The character counter is omitted.
11. Designed for use with special typing units, this base is shortened to 9-1/2 inches deep and mounts to its frame at an angle. It contains a signal bell, margin indicator and copy lamps, and the previously coded 28G Motor Unit. A belt-sprocket gear drive requires the ordering of a separate gear determined by the speed. The 28L Base utilizes the filler plate on the 28M TTY Cabinet and omits the margin indicator switch and lamp.
12. Terminal Blocks, Cord & plug to bring out connections from the distributor are provided.
13. This unit contains a special keytop arrangement with unused keytop positions sealed. Included is a momentary make pushbutton, a single pole single throw toggle switch, and six D.C. lamps all with wiring for connection to the cabinet terminal blocks. The period keytop will be protected by a cover and the keyboard lock - unlock keytop will be removed.
-

END OF SECTION

28 TYPE MOTOR UNITS

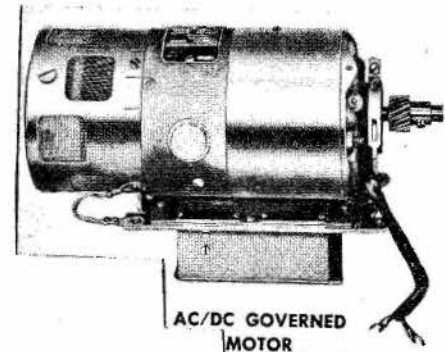
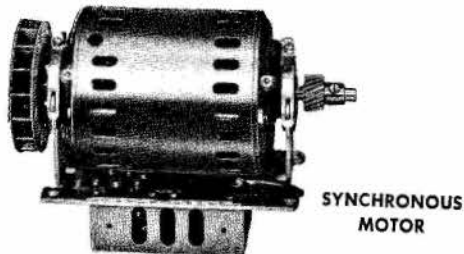

NOTE: Motor units are furnished without gears.

28A Motor Unit-AC (Teletype LMU3)

The 28A motor unit consists of a synchronous motor equipped with a starting relay and a thermal overload protective device. Features are as follows:

Voltage - 115V A.C. \pm 10%

Phase - Single Phase

Frequency - 60 cycles \pm 0.75%

Input Current - Starting 9 amperes
Running 1.85 amperes

Wattage - 65 watts

Horsepower - 1/20

Speed - 3600 rpm

Wiring is in accordance with ES-897220 and Teletype drawing WD2900.

28B Motor Unit - AC or DC (Teletype LMU 6)

The 28B motor unit consists of a series motor equipped with a centrifugal type governor and all necessary components for governing and spark protection circuits. When operated on DC power a capacitor resistor assembly which is mounted on the associated Electrical service Unit is required. A Tuning Fork TP-103628 is required for setting speed. Features are as follows:

(28B Motor Unit Cont'd. on next page)

28 TYPE MOTOR UNITS

28B Motor Unit - AC or DC (Teletype LMU 6) (Cont'd)

→ Voltage - 115V AC or DC \pm 10%

→ Phase - Single Phase or DC

Frequency - 50 Cycles - 60 Cycles - DC

Input Current - Starting 2.7 amperes 1.9 amperes 1.8 amperes
Running 1.4 amperes 1.2 amperes 0.9 amperes

Wattage - 115 watts 95 watts 105 watts

Horsepower - 1/20

Target - 4, 6 & 35 spot

Speed - 3600 rpm

→ Wiring in accordance with ES-897220 and Teletype drawing WD2900.

28C Motor Unit - AC (Teletype LMU 12)

This is a synchronous motor unit designed for use in a 28 type automatic sending and receiving set. It is similar to the 28A motor unit except for the following:

Input Current - Starting - 13.8 amperes
Running - 2.6 amperes

Horsepower - 1/12

→ Wattage - 150 watts

The 28C motor unit also has a larger starting capacitor and a heavier duty thermal cutout switch and starting relay than the 28A.

28 TYPE MOTOR UNITS

28D Motor Unit - AC (Teletype LMU 14)

→ This is a series motor unit designed for use in a 28 automatic sending and receiving set where 50 or 60 cycle nonregulated frequency AC power is provided. It is equipped with radio frequency suppressors, a ground strap between the motor housing and mounting bracket and a centrifugal type governor with all necessary components for governing and spark protection circuits. Features are as follows:

Voltage	-	115V AC \pm 10%
Phase	-	Single Phase
Frequency	-	<u>50 Cycles</u> - <u>60 Cycles</u>
Input Current	-	Starting 5 amperes 4 amperes Running 2.10 amperes 2.10 amperes
Wattage	-	200 watts 190 watts
Horsepower	-	1/15
Target	-	4, 6 & 35 spot
Speed	-	3600 rpm

Wiring in accordance with ES-897220 and Teletype drawing WD2900.

→ NOTE: This motor may also be operated on DC or 25 cycle AC through use of a suitable capacitor resistor assembly which is mounted in the electrical service unit.

28E Motor Unit - DC (Teletype LMU 29)

This is a series motor unit designed for use in 28 type tape teletype-writer and 28 type KSR's on the supervisor's desk in a 6A switchboard center. It is equipped with a radio frequency suppression filter and a centrifugal type governor with spark protection. Features are as follows:

→ Voltage 48V DC

28 TYPE MOTOR UNITS

28E Motor Unit - DC (Teletype LMU 29) (Cont'd)

Input Current - Starting 15 amperes
Running 2.75 amperes

Wattage - 130 watts

Horsepower - 1/15

Target - 4, 6 & 35 spot

Speed - 3600 rpm

→ 28G Motor Unit - AC (Teletype LMU 27) (Cancelled) - Furnished as part of 28K & 28L Bases.

This is a synchronous motor unit designed for use in a wall mounted teletypewriter set. It has the same features as the 28A Motor Unit except for the arrangement of the starting components to facilitate mounting on the underside of the base.

28LA Motor Unit - AC (Teletype LMU 21)

This is a synchronous motor unit designed for use in Delta Line Switching System. It has the same features as the 28A Motor Unit except that the capacitor is mounted on the side of the motor instead of beneath it.

END OF SECTION

Western Electric Company, Inc.
 Service Division
 Distribution Engineering

28 RECEIVING ONLY, 28 KEYBOARD SENDING & RECEIVING, AND 28 AUTOMATIC

CODE DESIGNATION	USED ON		TELETYPE CODE	CODE INCLUDES S.O.P.	SPEED		S.O.P. CONSISTS												
	MSR & RO *	ASR *			60	75	MOTOR PINION												
							100	TP151130 (14T)	TP159278 (14T)	TP151132 (17T)	TP159281 (17T)	TP151134 (20T)	TP159284 (20T)	TP158085 (14T)	TP158005 (9T)	TP158083 (17T)	TP158003 (12T)	TP158081 (20T)	TP158002 (11T)
28A	A		TP151060		A		A											A	
28A-1	A1		TP161293		A1		A1												A1
28B	B		TP151075		B			B											B
28B-1	B1		TP161294		B1			B1											B1
28C	C		TP151100			C				C									
28C-1	C1		TP161295			C1				C1									
28D	D		TP160675	TP158084	D					D								D	
				TP158029	D						D								
28D-1	D1		TP164583	COUPLING	D1														
				TP161293	D1			D1											D1
				TP158029	D1						D1								
28E	E		TP160676	TP158082	E						E								E
				TP158028	E						E								
28E-1	E1		TP164584	COUPLING	E1														
				TP161294	E1			E1											
				TP158028	E1						E1								
28F	F		TP160677	TP158080	F												F		
				TP158027	F														F
28F-1	F1		TP164585	COUPLING	F1														
				TP161295	F1					F1									
				TP158027	F1													F1	

*FOR STATION E/W A PERFORATOR TRANSMITTER BASE UPON WHICH IS MOUNTED A TYPE WHICH IS MOUNTED A TYPING OR NON-TYPING REPERFORATOR MUST BE E/W A 28N-1, 28D-1, 28E-1, OR 28F-1 GEARS.

28 TYPE SETS OF GEARS

GEARS FOR OPERATING THE REPERFORATORS ON THE 28D & 28F PERFORATOR TRANSMITTER BASE

CODE DESIGNATION	TELETYPE CODE	SPEED			CONSISTS OF								MATERIAL	REMARKS	
		60	75	100	PINION				DRIVEN GEAR						
					TP159894 (14T)	TP163021 (14T)	TP159891 (21T)	TP163019 (21T)	TP159888 (28T)	TP163015 (28T)	TP159895 (40T)	TP163022 (40T)			TP159892 (48T)
28N	TP159893	N			N					N				N	REPLACED BY 28N-1
28N-1	TP163023	N1			N1					N1				N1	REPLACES 28N
28P	TP159890	P			P					P				P	REPLACED BY 28P-1
28P-1	TP163024	P1			P1					P1				P1	REPLACES 28P
28R	TP159887		R			R					R		R	R	REPLACED BY 28R-1
28R-1	TP163025		R1				R1					R1	R1	R1	REPLACES 28R

28C TYPING REPERFORATOR BASE (NYLON GEARS)

CODE DESIGNATION	TELETYPE CODE	SPEED			CONSISTS OF							
		60	75	100	PINION			GEAR				
					TP161784 (18T)	TP161785 (24T)	TP161786 (26T)	TP161790 (44T)	TP161791 (47T)	TP161792 (39T)		
28S	TP161811	S			S				S			
28T	TP161812		T			T				T		
28U	TP161813			U			U				U	

28G Set of Gears

This set of gears is required in self-contained transmitter distributor applications with 28H and 28G transmitter distributor mounting and cover assemblies for operating corresponding 28H and 28G transmitter distributor units at 60 words per minute. This set consists of two gears as follows:

Set number TP156658 consists of:

Motor Pinion part number TP156627 (18T)
Countershaft Gear part number TP156626 (88T)

28H Set of Gears

Similar to the 28G set of gears except for operation at 75 words per minute.

Set number TP156728 consists of:

Motor Pinion part number TP156725 (24T)
Countershaft Gear part number TP156726 (94T)

28J Set of Gears

Similar to the 28G set of gears except for operation at 100 words per minute.'

Set number TP156659 consists of:

Motor Pinion part number TP156629 (24T)
Countershaft Gear part number TP156628 (72T)

28K Set of Gears

The TP161680 modification kit includes the TP156400 (28T) typing reperforator sprocket gear TP161510 (16T) cross shaft sprocket, TP161520 belt and necessary hardware for mounting and operating a typing reperforator at 60 words per minute. The 28K set of gears is used with the 28B typing reperforator base.

28L Set of Gears

The TP162213 modification kit includes the TP156400 (28T) typing reperforator sprocket gear TP162214 (20T) cross shaft sprocket, TP161520 belt and necessary hardware for operating a typing reperforator at 75 words per minute. The 28L set of gears is used with the 28B typing reperforator base.

28M Set of Gears

The TP162217 modification kit includes the TP162218 (29T) typing reperforator sprocket gear, TP162219 (27T) cross shaft sprocket, TP162222 belt and necessary hardware for operating a typing reperforator at 100 words per minute. The 28M set of gears is used with the 28B typing reperforator base.

28N Set of Gears (Replaced by 28N-1 Set of gears)

This is a TP159893 set of gears to be used in the 28D or 28F perforator transmitter base for operating the typing and non-typing reperforator selector mechanisms at 60 words per minute.

Set number TP159893 consists of:

Motor Pinion part number TP159894 (14T)
Countershaft Gear part number TP159895 (40T)

28N-1 Set of Gears (Replaces 28N Set of Gears)

This is a TP163023 set of gears of nylon construction to be used in the 28D and 28F Perforator Transmitter Bases for operating the typing and non-typing reperforator mechanisms at 60 words per minute.

28P Set of Gears (Replaced by 28P-1 Set of Gears)

This is a TP159890 set of gears to be used in the 28D or 28F perforator transmitter base for operating the typing and non-typing reperforator selector mechanism at 75 words per minute.

Set number TP159890 consists of:

Motor Pinion part number TP159891 (21T)
Countershaft Gear part number TP159892 (48T)

28P-1 Set of Gears (Replaces 28P Set of Gears)

This is a TP163024 set of gears of nylon construction to be used in the 28D and 28F Perforator Transmitter Bases for operating the typing and non-typing reperforator mechanisms at 75 words per minute.

28R Set of Gears (Replaced by 28R-1 Set of Gears)

This is a TP159887 set of gears to be used in the 28D or 28F perforator transmitter base for operating the typing and non-typing reperforator selector mechanism at 100 words per minute.

(28R Set of Gears Cont'd on next page)

28R Set of Gears (Replaced by 28R-1 Set of Gears) (Cont'd)

Set number TP159887 consists of:

Motor Pinion part number TP159888 (28T)
Countershaft Gear Part number TP159889 (49T)

28R-1 Set of Gears (Replaces 28R Set of Gears)

This is a TP163025 set of gears of nylon construction to be used in the 28D and 28F Perforator Transmitter Bases for operating the typing and non-typing reperforator mechanisms at 100 words per minute.

28S Set of Gears

This is a set of nylon gears (TP161811) for use with the 28C typing reperforator base to provide operation of the typing reperforator at 60 words per minute.

Set number TP161811 consists of:

Motor Pinion part number TP161790 (44T)
Countershaft Gear part number TP161784 (18T)

28T Set of Gears

This is a set of nylon gears (TP161812) for use with the 28C typing reperforator base to provide operation of the typing reperforator at 75 words per minute.

Set number TP161812 consists of:

Motor Pinion part number TP161791 (47T)
Countershaft Gear part number TP161785 (24T)

28U Set of Gears

This is a set of nylon gears (TP161813) for use with the 28C typing reperforator base to provide operation of the typing reperforator at 100 words per minute.

Set number TP161813 consists of:

Motor Pinion part number TP161792 (39T)
Countershaft Gear part number TP161786 (26T)

28W Set of Gears

This is a set of nylon speed change gears for use with the 28J Transmitter Distributor Base to provide 60 words per minute operation. The set number is TP173098

28Y Set of Gears

This is a set of nylon speed change gears for use with the 28J Transmitter Distributor Base to provide 75 words per minute operation. The set number is TP173101.

28AA Set of Gears

This is a set of nylon speed change gears for use with the 28J Transmitter Distributor base to provide 100 words per minute operation. The set number is TP173104.

28AB Set of Gears

This is a set of nylon speed change gears for use with the 28K Transmitter Distributor Base to provide 60 words per minute operation. The set number is TP172767.

28AC Set of Gears

This is a set of nylon speed change gears for use with the 28K Transmitter Distributor Base to provide 75 words per minute operation. The set number is TP172770.

28AD Set of Gears

This is a set of nylon speed change gears for use with the 28K Transmitter Distributor Base to provide 100 words per minute operation. The set number is TP172773.

END OF SECTION

28 TYPE COPYHOLDERS

All cabinets are equipped with a built-in copyholder on the front of the cabinet for paper 6" long.

28A45 Copyholder (Teletype TP164024GA)

An offset copyholder for paper 11" long designed for mounting on the right side of a Console type teletypewriter cabinet. This copyholder was provided as a standard item in gray green wrinkle on 28G40 and 28F40 Cabinets. It is not provided on the 28G45 and 28F45 Cabinets which are gray green vinyl and must be ordered separately when required.

NOTE: 28G40 and 28F40 Cabinets are to be furnished without copyholders unless the copyholder is specifically requested.

28B45 Copyholder (Teletype TP173400GA)

An offset copyholder designed to fit the table mounted cabinet, which has no lower portion, since the 28A45 copyholder cannot be used.

28C45 Copyholder (Teletype TP178897GA)

An offset copyholder designed for use in a Dial TWX station. This copyholder mounts above the 689A Subscriber Set on the right side of a console type cabinet and is hinged to move out of the way when the cabinet cover is to be opened.

END OF SECTION

28 TYPE ELECTRICAL SERVICE UNIT

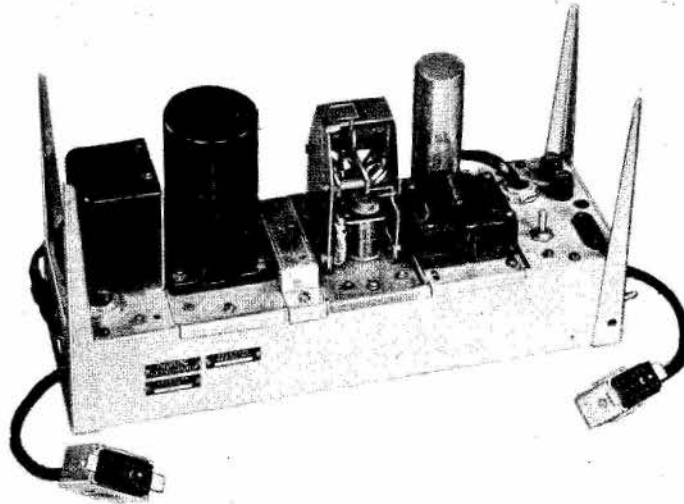

↳ GENERAL DESCRIPTION

The 28 type Electrical Service Unit provides the cable assemblies and wiring for ease in interconnection of the various units used in assembling a station. Utilizing the connectors, the units may be assembled into a station or removed from the station without removing individual leads.

Included in each electrical service unit are miscellaneous AC power connectors, switches, rectifiers, relays, terminal blocks, test keys and additional items required to provide a particular type of operation by the station. Various features such as a motor control relay may be added to many coded electrical service units through the use of modification kits. These features will replace a blank cover plate which is utilized to cover the blank spaces when all positions in the electrical service unit are not used.

↳ Features of the various coded units and the use for which they were designed may be found on the following pages of this section.

Western Electric Company, Inc.
 Service Division
 Distribution Engineering

28 TYPE ELECTRICAL

CODE DESIGNATION	WIRING DIAGRAM	TELETYPE CODE	FOR USE IN	LINE SHUNT RELAY	RECTIFIER		LINE RELAY MFG.	LINE TEST KEY	POWER SWITCH	NO. OF TERMINAL BLOCKS			CONNECTORS & CA							
					150 MA	500 MA				3	4	6	KEYBOARD	TYPING UNIT	REPERFORATOR	TAPE OUT	AUX. HARDGATE READER	PIVOTED HEAD T.D.		
28A	P34.302	-	RO & KSR	A					A	A			A	A						
28B	P34.302	LESU7/184	RO & KSR	B					B		B		B	B						
28B-1		LESU107	KSR	B1	B1				B1		B1		B1	B1						
28C	P34.304	LESU11	ASR						C				C	C	C	C	C			
28D	P34.309	LESU12	KTR & ROTR	D			D				D									
28D-1	P34.309	LESU30	KTR & ROTR	D1	D1		D1				D1									
28D-2	P34.309	LESU75	ROTR	D2	D2		D2				D2									
28E	P34.302	LESU7/134	RO & KSR	E	E		E	E			E		E	E						
28E-1	P34.302	LESU31	RO & KSR	E1	E1		E1	E1			E1		E1	E1						
28F	P34.317	LESU13	ASR	F	F		F	F	F				F	F	F					
28F-1	P34.317	LESU35	ASR	F1			F1	F1	F1				F1	F1	F1					
28G	P34.318	LESU15	ASR	G		G	G	G					G	G	G					
28G-1	P34.318	LESU36	ASR	G1			G1	G1	G1				G1	G1	G1					
28H	P34.317	LESU32	ASR	H	H			H	H				H	H	H					
28J	P34.317	LESU33	ASR	J	J		J	J					J	J	J					
28K	P34.309	LESU27	ROTR	K							K									
28L	P34.325	LESU66	ASR			L	L					L	L	L						
28M	P34.302	LESU67	KSR			M	M					M	M	M						
28N		*	KSR						N			N	N	N						
28N-1		*	KSR						N1			N1	N1	N1						
28P		*	ASR						P			P	P	P						
28P-1		*	ASR						P1			P1	P1	P1						
28R	WD4911	LESU86	KSR						R			R	R	R						
28S	WD4913	LESU87	KSR						S			S	S	S						
28T	B136671	LESU72	RO & KSR	T		T	T						T	T						
28U																				
28W																				

*Converted from other E.S.U. per RS-581.84 Section AB

ELECTRICAL SERVICE UNIT

FEATURES											NOTES	REMARKS									
ORDERS & CABLE																					
TAPE OUT	AUX. HARDGATE READER	PIVOTED HEAD T.D.	REF. BASE	TRANS. DISTRIBUTOR	ANSWERBACK	LAMP SWITCH (DPDT)	FUSE	CONV. RECP. (3 PRONG)	SIGNAL BELL	MOTOR CONT. RELAY	SLOW RELEASE RELAY	SLOW RELEASE RELAY, DIODE & RESISTORS	TP178345 ANSWERBACK MOD. KIT	TP178307 MOTOR CONT. ASSEM.	TP165687 MOTOR CONT. ASSEM.	TP165673 MOTOR CONT. ASSEM.	SELECTOR MAGNET DRIVER (TP-177010)	MARGIN INDR. LAMP RESISTOR (700 Ω)			
						A	A	A											1	MANUFACTURE DISCONTINUED	
							B	B										B	2		
						B1	B1												11	101 ELEC. SW. SYSTEM	
C	C	C				C	C												13	83B2 SYSTEM IN 28F CABINET	
			D					D											3		
			D1					D1											4	81D1 SWITCHING SYSTEM	
			D2					D2	D2												
						E	E											E			
						E1	E1											E1	5	81D1 SWITCHING SYSTEM	
			F			F	F														
			F1			F1	F1														
			G			G	G			G											BREAK-TURNER FEATURE
			G1			G1	G1			G1											BREAK-TURNER FEATURE
			H			H	H														DIRECT MAGNET OPERATION
			J			J	J												10		MANUFACTURE DISCONTINUED
			K					K													81D1 SWITCHING SYSTEM
			L			L	L	L	L	L	L										BOEING LINE SWITCHING SYSTEM
						M	M	M	M	M								M			BOEING LINE SWITCHING SYSTEM
			N			N	N						N					N	6		TWX
						N1	N1							N1				N1	7		TWX
			P	P		P	P					F							6		TWX
			P1			P1	P1							P1					7		TWX
						R									R				8,9		TWX-SWBD CENTER - 48VDC
						S	S									S		S	8		TWX-SWBD CENTER -120VAC
						T	T	T									T		12		WALL MTD - N.Y. STOCK EXCH.
																					NEVER MANUFACTURED
																					NEVER MANUFACTURED

28 TYPE ELECTRICAL SERVICE UNIT

NOTES:

1. Designed for use in 28A Cabinets.
2. Differs from 28A in that power switch and fuse are connected in only one side of the power supply, line shunt relay is connected to base and typing unit through connectors and new wiring is provided.
3. A TP-161829 modification kit provided brackets, studs, and the necessary hardware to mount a 28 electrical service unit on the relay rack in the kneewell of a 28ASR cabinet and is to be ordered when required.
4. Differs from 28D in that the unit is wired for reverse polarity to the line relay assembly.
5. The 28E-1 electrical service unit is the same as the 28E electrical service unit except that the wiring to the terminal blocks in the cavity of the unit have been modified as follows:
 1. Rectifier positive to A-9 terminal.
 2. Rectifier negative to A-8 terminal.
 3. Red wire to A-7 removed from A-7 and connected to terminal A-8.
 4. Strap between A-7 and A-8 is omitted (this frees terminal A-7).
 5. Brown wire from 600 ohm resistor to terminal A-3 is removed from A-3 and connected to terminal A-7.
 6. Straps are provided from terminals A-7 to C17 and A-3 to C18.
 7. Straps from terminals B6 to C17 & B4 to C18 are omitted.
 8. Leads from J2-4 to J1-5 & J2-1 to J1-6 are omitted.
6. The TP-178345 Answerback Mod. Kit consists of:
 1. A TP-178306 Motor Control Relay designed to operate on $20V \pm 20\%$ dc; coil resistance $440 \text{ ohms} \pm 10\%$.
 2. A TP-178306 Answerback Control Relay to be actuated by the Data-Phone Subset.
 3. A 20mfd, 250VDC Capacitor, a 470 diode, a 2810 ohm resistor, an answerback connector and cable, and miscellaneous mounting material.
7. The TP-178307 Motor Control Assembly consists of a TP-178306 Motor Control Relay designed to operate on $20V \pm 20\%$ dc and miscellaneous mounting material. It has a coil resistance of $440 \text{ ohms} \pm 10\%$.

28 TYPE ELECTRICAL SERVICE UNIT

8. The Motor Control Assembly utilizes a TP-178306 Motor Control Relay in series with a 600 ohm current limiting resistor and equipped with a 185A Network across the relay winding. It is designed to operate on 48VDC.
9. Equipped with an R-C Network for protection of the Motor Control Contacts. E.S.U. operates from 48V. D.C.
10. Early models did not have a rectifier or line relay mounting assembly. These features were added per BSP P98.909.
- ➔ 11. Differs from 28B electrical service unit in the omission of the 700 ohm margin indicator resistor and the addition of a 120 ma rectifier and two leads from keyboard connector terminals F6 and F8 to cabinet auxiliary terminal blocks AF60 & AF59 respectively.
12. This unit, usable only in the Wall Mtd Set, contains a strobing jack, a 5.5 volt A.C. copylight transformer, an A.C. power inlet connector and a terminal block that takes the place of the "C" terminal strips. The motor control relay operates on a make after a break.
- ➔ 13. Includes a spare fuse in addition to standard.

28 TYPE ELECTRICAL SERVICE UNIT
FOR USE IN DELTA LINE SWITCHING SYSTEM

28LA Electrical Service Unit (Teletype LESU 56)

This unit, designed for use in the 28LA Teletypewriter Cabinet, contains all the AC wiring for the Codomat and the Rectifiers associated with the send set. Features of this unit are the following:

- 1) Two terminal blocks
- 2) A 48V DC rectifier
- 3) A fuse on each side of the AC input
- 4) Three power switches (Master, E.S.U. and Copyholder)
- 5) Two switched three prong receptacles. Two three prong receptacles that are not switched and a convenience receptacle.
- 6) Cables and connectors (Cabinet, AC Input, Codomat, Clock, T, and Keyboard)

Wiring is in accordance with BSP P34.350.

28LB Electrical Service Unit (Teletype LESU 57)

This unit, designed for use in the 28LA Teletypewriter Cabinet, contains the wiring and components necessary to serve as a link between a local loop of a send set and the external loop made accessible by the data subset. Features of this unit are the following:

- 1) Four terminal blocks
- 2) A TP-162361, 500MA, 120 Volts DC Rectifier Assembly
- 3) TP-144620 Receive and TP-144621 Send Line Relay mounting assemblies
- 4) Line following and monitor line mercury relays
- 5) "Call Telco" and "XMSN Test" Keys
- 6) A Circuit Assurance Detector Card
- 7) Cables and connectors (AC Input and a 36 point distribution panel connector)

Wiring is in accordance with BSP P34.352.

28 TYPE ELECTRICAL SERVICE UNIT
FOR USE IN DELTA LINE SWITCHING SYSTEM

➤ 28LC Electrical Service Unit (Teletype LESU 58/256)

This unit, designed for mounting in the 28LB Teletypewriter Cabinet, contains the wiring and components necessary to serve as a link between the local loop of a receive set and the external loop made accessible by the data subset. Features of this unit are the following:

- 1) Five terminal strips
- 2) A 115V DC rectifier assembly
- 3) A receptacle and two fuses
- 4) A power switch
- 5) Two wire spring relays, a circuit assurance mercury relay, and a line relay mounting assembly
- 6) Cables and connectors (AA, CP, K, A, TP-145282 Cable, TP-145283 Cable, TP-145284 Cable)

Wiring is in accordance with BSP P34.351.

28LC-1 Electrical Service Unit (Teletype LESU 58/257)

This unit, designed for mounting in the 28LA three tier Apparatus Cabinet, is the same as the 28LC Electrical Service Unit except that the TP-145282, TP-145283 and TP-145284 Cable Assemblies are replaced by TP-145064, TP-145062 and TP-145063 Cable Assemblies, respectively. These cable assemblies provide the additional length required when the three tier cabinet is utilized.

Wiring is in accordance with BSP P34.351.

28LD Electrical Service Unit (Teletype LESU 59/256)

This unit, designed for mounting in the 28LB Teletypewriter Cabinet, contains the wiring and components necessary to serve as a link between the local loop of a receive set and the external loop made accessible by the data set. It also contains the relay necessary for typing unit interchange. Features of this unit are the following:

-
- 1) Five terminal strips
 - 2) A 115V DC rectifier assembly
 - 3) A receptacle and two fuses

(28LD E.S.U. Cont'd on next page)

28 TYPE ELECTRICAL SERVICE UNIT
FOR USE IN DELTA LINE SWITCHING SYSTEM

↳ 28LD Electrical Service Unit (Teletype LESU 59/256) (Cont'd)

- 4) A power switch
- 5) Three wire spring relays, a circuit assurance mercury relay, and a line relay mounting assembly
- 6) Cables and connectors (AA, CP, K, A, PS, TP-145282 Cable, TP-145283 Cable, TP-145284 Cable)

Wiring is in accordance with BSP P34.353.

28LD-1 Electrical Service Unit (Teletype LESU 59/257)

This unit, designed for mounting in the 28LA three tier Apparatus Cabinet, is the same as the 28LD Electrical Service Unit except that the TP-145282, TP-145283 and TP-145284 Cable Assemblies are replaced by TP-145064, TP-145062 and TP-145063 Cable Assemblies, respectively. These cable assemblies provide the additional length required when the three tier cabinet is utilized.

↳ Wiring is in accordance with BSP P34.353.

END OF SECTION

AUXILIARY FEATURES OF NO. 28 TYPE TELETYPEWRITER

TP152910GA Directory Holder

A holder similar to 38Y3816 except adapted for use with 28 type TTY.

TP152300GA Directory Holder

For use on the 28C45 cabinet. For further information see PEL 5839.

TP152909 Auxiliary Apparatus Mounting Rack (Repl. by TP159373 Mod. Kit)

A rack to mount auxiliary apparatus such as a teletypewriter subscriber set. Fastens in the lower portions of the 28 Cabinet. Will also mount other apparatus using standard 19 inch relay rack panels.

TP159373 Modification Kit

Replaces the TP152909 Kit and provides TP155547 and TP155548 brackets for mounting panels with mounting holes 1 or 1 1/4 inch centers.

TP151822 Line Relay Mounting

Provides mounting for 255A relay in 28A Electrical Service Unit.

TP152623 Line Relay Mounting

Provides mounting for 255A relay in 28B Electrical Service Unit.

TP152744 Line Test Key

For mounting in 28A electrical service unit.

TP152625 Line Test Key

For mounting in 28B electrical service unit.

TP151999 Rectifier

100 MA rectifier for mounting in 28A electrical service unit to provide direct current for selector magnets and line relay bias winding. Will not provide signal line current.

TP152950 Rectifier

Similar to the TP151999 Rectifier with the difference being the wiring in the 28B electrical service assembly and the mounting of the rectifier stack to provide maximum space between the terminal and the side wall of the mounting plate.

AUXILIARY FEATURES OF NO. 28 TYPE TELETYPEWRITER (Cont'd)

TP162361 Rectifier

A 500 ma full wave rectifier and cable assembly equipped with a Fuse holder. This rectifier is a part of the 28G Electrical Service assembly, but is used where a self contained D.C. supply is required for operation of a 28G Transmitter Distributor.

TP151400 Electrical Motor Control Mechanism

For mounting in the 28A electrical service unit to provide remote starting and stopping of teletypewriter.

TP153251 Electrical Motor Control Mechanism

Similar to the TP151400 Electrical Motor Control Mechanism with the difference being the wiring in the 28B electrical service assembly.

TP152021 DC Applique Unit

For mounting in 28A electrical service unit to provide necessary resistances for motor and other circuits to permit DC operation.

TP152624 DC Applique Unit

Similar to the TP152021 DC Applique Unit, but, for wiring in the 28B electrical service unit.

TP152911 Break Key for Receiving-Only Base

For mounting in hole in receive-only keyboard normally filled by apparatus blank to provide break-key for receive-only teletypewriter.

28A45 Paper Box (Teletype TP152349GA)

This paper box, designed to be mounted on the rear of the 28 type teletypewriter cabinet, contains facilities for holding a box of form paper and includes a form accumulator shelf. The screws for locating or attaching the box at the rear of the cabinet and a 153842 clip to facilitate insertion of paper are included.

➔ 28B45 Paper Box (Teletype TP195837GA)

This paper box, superseding the 28A45 paper box, will accommodate forms up to 9 inches wide by 11 inches long. The form accumulating shelf will hold about 1800 sheets of single-ply paper which is approximately twice the capacity of the 28A. The lower surface of the box is approximately 2 inches lower than on the 28A.

AUXILIARY FEATURES OF NO. 28 TYPE TELETYPEWRITER (Cont'd)

28A Tape Splicer (Teletype LTS1)

This is a tape splicing device designed to be positioned on the end of a re-perforator transmitter set and provide means for splicing the tape supply prior to feeding the tape to a perforator mechanism.

The unit is equipped with a cutting mechanism to cut the tape on a diagonal: a heating element for bonding the two cut ends together with a thermosetting splicing medium. Suitable indicators provided to indicate when the unit is at the correct temperature for splicing and when the heating element has been applied to the splice for a sufficient period to properly bond the tape.

➔ 1A** Paper Winder (Teletype LPW300**)

Designed for mounting on the rear of a 28, 33 or 35 type teletypewriter cabinet, this paper winder utilizes a TP193951 Paper Guide which provides for all standard widths of papers. Features of this winder include an induction motor, an on-off switch, a mercury activating switch, a 600 ohm 10 watt resistor, a TP195258 Power Cord, a TP114466 twist-lock connector and additional terminals for bringing in power from a source other than the convenience receptacle.

When utilized with a 28 or 35 type teletypewriter a TP193950 Copy Display Rod should be ordered while a TP195259 Modification Kit should be ordered when used with a 33 type teletypewriter.

➔ **Standard colors are 45 (Gray Green Vinyl) for 28 type and 46 (Light Olive Gray Vinyl) for 33 and 35 type.

(Cont'd on Page 3)

PLATES FOR 28 TYPE APPARATUS

<u>Teletypewriter Base</u>	TP150948A	Teletype Plate
	TP150949	Serial Number Plate
	TP152879	Patent Plate
	TP153000	Bell System Identification Plate
	TP154629	Underwriters Lab. Plate
<u>Typing Unit</u>	TP150948A	Teletype Plate
	TP150949	Serial Number Plate
	TP150951	Patent Plate
	TP153001	Bell System Identification Plate
<u>Electrical Service Unit</u>	TP150948A	Teletype Plate
	TP150949	Serial Number Plate
	TP153002	Bell System Identification Plate
<u>Motor Unit</u>	TP150948A	Teletype Plate
	TP150949	Serial Number Plate
	TP153003	Bell System Identification Plate
<u>Sequence Selector Unit</u>	TP153004	Bell System Identification Plate
<u>Sequence Selector Base</u>	TP153005	Bell System Identification Plate
<u>Multi-Contact Distributor</u>	TP153006	Bell System Identification Plate
<u>Typing Reperf. Base</u>	TP153007	Bell System Identification Plate
<u>Typing Reperf. Unit</u>	TP150948A	Teletype Plate
	TP150949	Serial Number Plate
	TP153008	Bell System Identification Plate
	TP156201	Patent Plate
<u>Non-Typing Reperf. Unit</u>	TP150948A	Teletype Plate
	TP150949	Serial Number Plate
	TP150950	Code Plate
	TP157996	Patent Plate
<u>Typing Reperf. Trans. Unit</u>	TP153009	Bell System Identification Plate
<u>Reperf. Transmitter Stand</u>	TP153010	Bell System Identification Plate
<u>Typing Perforator</u>	TP150948A	Teletype Plate
	TP150949	Serial Number Plate
	TP150950	Code Plate
	TP156201	Patent Plate
<u>Non-Typing Perforator</u>	TP150948A	Teletype Plate
	TP150949	Serial Number Plate
	TP150950	Code Plate
	TP155578	Patent Plate

(Cont'd on next page)

PLATES, FOR 28 TYPE APPARATUS (Cont'd)

<u>Perforator Transmitter Base</u>	TP153011	Bell System Identification Plate
<u>Transmitter Distributor Unit</u>	TP150948A	Teletype Plate (28B)
	TP150949	Serial Number Plate
	TP153012	Bell System Identification Plate
	TP155567	Patent Plate
	TP156769	Teletype Plate
	TP157995	Patent Plate (28C, F, G)
	TP162069	Patent Plate
	TP164119A	Teletype Plate
	TP176389	"Free-Stop" Label (28H)
	TP176390	"Run" Label (28H)
<u>Transmitter Distributor Base</u>	TP150948A	Teletype Plate (28B, E, E-1, E-2 F, G)
	TP150949	Serial Number
	TP153013	Bell System Identification Plate
	TP156769	Teletype Plate
<u>Reperf. Transmitter Unit</u>	TP153014	Bell System Identification Plate
<u>Stroboscopic Test Set</u>	TP161657	Bell System Identification Plate
<u>T. D. Cover</u>	TP151796	Bell System Identification Plate
	TP154346	Instruction Plate
	TP156770	Teletype Plate
<u>Mtg. & Cover Assem.</u>	TP151658	Bell System Identification Plate
<u>Cabinet (KSR & RO)</u>	TP150948A	Teletype Plate
	TP152113	Patent Plate
	TP154346	Instruction Plate
	TP154348	Instruction Plate
	TP154399	Customer Plate
<u>Cabinet (ASR)</u>	TP150948A	Teletype Plate
	TP154346	Instruction Plate
	TP154348	Instruction Plate
	TP154399	Customer Plate
	TP161292	Patent Plate
<u>Cabinet (Table Model)</u>	TP150948A	Teletype Plate
	TP152114	Patent Plate
	TP154346	Instruction Plate
	TP154348	Instruction Plate
	TP154399	Customer Plate

CONVERSION OF AUXILIARY EQUIPMENT FROM 28A TO 28B TYPE TTY

<u>Apparatus</u>	<u>Old Code Number</u>	<u>New Code Number</u>	<u>Conversion Set of Parts</u>	<u>"S" Spec.</u>
Line Relay Mtg.	TP151822	TP152623	TP152326	5664S
Line Test Key	TP152744	TP152625	TP152325	5701S
Elec. Motor Control	TP151400	TP153251	TP152329	5706S
Rectifier	TP151999	TP152950	TP152327	5707S
Capacitor Resistor Assembly	TP152021	TP152624	TP152328	5662S
Reverse Current Motor Control	TP152332		TP152331	5779S

END OF SECTION

28 TYPE BOXES

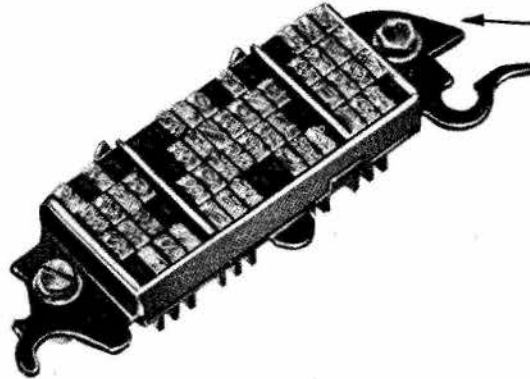

NOTE:

TYPE BOX IS IDENTIFIED BY TP-151738 IDENTIFICATION SCREW WHICH IS FURNISHED STAMPED WITH TWO LETTER TELETYPE CODE REQUIRED.

LOCATION OF PALLETS IN TYPE BOXES FOR STANDARD TYPE ARRANGEMENTS

TYPE ARRANGEMENT A

LETTERS				FIGURES					
M	N	H		T	O	.	#	5	9
X	F	Y	S	E	Z	D	B /	3"	\$?
V	C	P	I	L	R	G	;)	4 &
	K	Q	U	A	W	J	(1	7
								-	2'

TYPE ARRANGEMENT B

LETTERS				FIGURES					
M	N	H		T	O	.	$\frac{7}{8}$ #	5	9
X	F	Y	S	E	Z	D	B /	3"	\$ $\frac{5}{8}$
V	C	P	I	L	R	G	$\frac{3}{8}$ $\frac{1}{8}$ 0 8	$\frac{3}{4}$	4 &
	K	Q	U	A	W	J	$\frac{1}{2}$ 1 7	-	2'

TYPE ARRANGEMENT C

LETTERS				FIGURES					
M	N	H		T	O	.	$\frac{7}{8}$	5	9
X	F	Y	S	E	Z	D	B /	3"	\$ $\frac{5}{8}$
V	C	P	I	L	R	G	$\frac{3}{8}$ $\frac{1}{8}$ 0 8	$\frac{3}{4}$	4 &
	K	Q	U	A	W	J	$\frac{1}{2}$ 1 7	-	2,

TYPE ARRANGEMENT D

LETTERS				FIGURES					
M	N	H		T	O	.	0 ↓	-	5 9
X	F	Y	S	E	Z	D	B / →	3 +	↑ ⊕
V	C	P	I	L	R	G	0 0 0 8	↖	4 ↘
	K	Q	U	A	W	J	← 1 7	↑	2 ↙

MURRAY STYLE PALLETS

PALLETS COMMON
 TO ALL ARRANGEMENTS

PALLETS DETERMINED
 BY ARRANGEMENTS

PALLET	TP NO.
A	157600
B	157601
C	157602
D	157603
E	157604
F	157605
G	157606
H	157607
I	157608
J	157609
K	157610
L	157611
M	157612
N	157613
O	157614
P	157615
Q	157616
R	157617
S	157618
T	157619
U	157620
V	157621
W	157622
X	157623
Y	157624
Z	157625
1	157626
2	157627
3	157628
4	157629
5	157630
6	157631
7	157632
8	157633
9	157634
.	157636
-	157642
/	157643

PALLET	TP NO.	TYPE ARR.			
		A	B	C	D
.	157637	X		X	
"	157638	X	X	X	
'	157639	X	X		
;	157640	X			
:	157641	X			
?	157644	X			
)	157645	X			
(157646	X			
!	157647	X			
\$	157648	X	X	X	
&	157649	X	X	X	
1/8	157651		X	X	
1/4	157652		X	X	
3/8	157653		X	X	
1/2	157654		X	X	
5/8	157655		X	X	
3/4	157656		X	X	
7/8	157657		X	X	
#	157659	X	X		
←	157663				X
→	157664				X
↓	157665				X
↑	157666				X
↖	157667				X
↗	157668				X
↘	157669				X
↙	157670				X
+	157671				X
o	157672				X
o	157673				X
o	157674				X
o	157675				X

*GOTHIC STYLE PALLETS
 (12-TO-INCH SPACING)

PALLETS COMMON
 TO ALL
 ARRANGEMENTS

PALLETS DETERMINED
 BY ARRANGEMENTS

PALLET	TP NO.
A	155432
B	155433
C	155434
D	155435
E	155436
F	155437
G	155438
H	155439
I	155440
J	155441
K	155442
L	155443
M	155444
N	155445
O	155446
P	155447
Q	155448
R	155449
S	155450
T	155451
U	155452
V	155453
W	155454
X	155455
Y	155456
Z	155457
1	155458
2	155459
3	155460
4	155461
5	155462
6	155463
7	155464
8	155465
9	155466
/	155469
.	157636
-	157642

PALLET	TP NO.	TYPE ARR.			
		A	B	C	D
&	155467	X	X	X	
\$	155468	X	X	X	
1/2	155471		X	X	
1/4	155472		X	X	
#	155473	X	X		
7/8	155474		X	X	
5/8	155475		X	X	
1/8	155476		X	X	
3/8	155477		X	X	
3/4	155478		X	X	
+	155479				X
.	157637	X		X	
"	157638	X	X	X	
'	157639	X	X		
;	157640	X			
:	157641	X			
?	157644	X			
)	157645	X			
(157646	X			
!	157647	X			
←	161366				X
→	161367				X
↓	161368				X
↑	161369				X
↖	161370				X
↗	161371				X
↘	161372				X
↙	161373				X
o	161374				X
o	161375				X
o	161376				X
o	161377				X

*TYPING UNIT MUST BE
 EQUIPPED WITH TP-154792
 MOD. KIT TO PROVIDE 12
 SPACES PER INCH
 HORIZONTALLY

PALLE
A
B
C
D
E
F
G
H
I
J
K
L
M
N
O
P
Q
R
S
T
U
V
W
X
Y
Z
1
2
3
4
5
6
7
8
9
.
-
/
\$
&
#
1/8
1/4
3/8
1/2
5/8
3/4
7/8

**TYPIN
 TP-15
 PROVI
 HORIZ

****LARGE GOTHIC
STYLE PALLETS**

Specification RS-581.0
Section 23I
Page 2
6-20-62

28G TYPEBOX
(MODIFIED ARRAN. B)

PALLET	TP NO.
A	157729
B	157730
C	157731
D	157732
E	157733
F	157734
G	157735
H	157736
I	157737
J	157738
K	157739
L	157740
M	157741
N	157742
O	157743
P	157744
Q	157745
R	157746
S	157747
T	157748
U	157749
V	157750
W	157751
X	157752
Y	157753
Z	157754
1	157755
2	157756
3	157757
4	157758
5	157759
6	157760
7	157761
8	157762
9	157763
.	157765
'	157768
-	157771
/	157772
\$	157777
&	157778
#	157779
1/8	163308
1/4	163309
3/8	163310
1/2	163311
5/8	163312
3/4	163313
7/8	163314

**LONG GOTHIC
STYLE PALLETS**

PALLETS COMMON
TO ALL
ARRANGEMENTS

PALLET	TP NO.
A	155618
B	155619
C	155620
D	155621
E	155622
F	155623
G	155624
H	155625
I	155626
J	155627
K	155628
L	155629
M	155630
N	155631
O	155632
P	155633
Q	155634
R	155635
S	155636
T	155637
U	155638
V	155639
W	155640
X	155641
Y	155642
Z	155643
1	155644
2	155645
3	155646
4	155647
5	155648
6	155649
7	155650
8	155651
9	155652
'	155653
:	155654
-	155655
/	155656
(155657
)	155658
#	155659
&	155666

PALLETS
DETERMINED
BY ARRANGE-
MENTS

PALLET	TP NO.	MODIFIED A	TYPE ARR.
◇	155660	X	
⊙	155661	X	
⊖	155662	X	
→	155663	X	
*	155664	X	
∞	155665	X	
\$	155667		X
?	155668		X
!	155669		X
;	155670		X
,	155671		X
.	155672		X
"	155673		X

****TYPING UNIT MUST BE EQUIPPED WITH
TP-154755 OR TP-159395 MOD. KIT TO
PROVIDE 5 OR 6 SPACES PER INCH
HORIZONTALLY.**

28 TYPE BOXES

28A Type Box (Teletype Arrangement RA; TP-151930)

This type box contains the standard Murray Style pallets for Punctuation Characters Arrangement A.

28A-1 Type Box (Teletype Arrangement WY; TP-155701)

This type box was designed for use with the 82B System. It contains Murray Style pallets for Punctuation Characters Arrangement A modified by the replacement of the TP-157614 zero pallet with a TP-157635 zero with diagonal stroke (\emptyset) pallet. A TP-151301 Keylever Assembly is required.

28A-2 Type Box (Teletype Arrangement XR; TP-161362)

This type box contains the standard Gothic Style pallets for Punctuation Characters Arrangement A. It is designed for use on a typing unit which is equipped with a TP-154792 Modification Kit to provide 12 spaces per inch horizontally.

28A-3 Type Box (Teletype Arrangement YS; TP-178724)

This type box is equipped with Murray Style pallets for type Arrangement A. It is the same as the 28A Type Box except it is equipped with pallets to print on all functions for monitoring purposes.

28B Type Box (Teletype Arrangement RB; TP-152881)

This type box contains the standard Murray Style pallets for Fraction Characters Arrangement B.

28B-1 Type Box (Teletype Arrangement XS; TP-161363)

This type box contains the standard Gothic Style pallets for Fraction Characters Arrangement B. It is designed for use on a typing unit which is equipped with a TP-154792 Modification Kit to provide 12 spaces per inch horizontally.

28C Type Box (Teletype Arrangement RC; TP-151931)

This type box contains the standard Murray Style pallets for Fraction Characters Arrangement C.

28 TYPE BOXES

→ 28C-1 Type Box (Teletype Arrangement XT; TP-161364)

This type box contains the standard Gothic Style pallets for Fraction Characters Arrangement C. It is designed for use on a typing unit which is equipped with a TP-154792 Modification Kit to provide 12 spaces per inch horizontally.

28D Type Box (Teletype Arrangement RD; TP-151937)

This type box contains the standard Murray Style pallets for Weather Characters Arrangement D.

28D-1 Type Box (Teletype Arrangement WN; TP-157018)

This type box was designed for use with the Republic Steel 81D1 Switching System. It contains Murray Style pallets for Weather Characters Arrangement D modified as follows:

<u>PALLET</u>	<u>REPLACING STANDARD PALLET</u>	<u>ON U.C.</u>
& (TP-157649)	↘ (TP-157669)	G
' (TP-157639)	↙ (TP-157670)	J
,	0 (TP-157674)	N
# (TP-157659)	0 (TP-157672)	C
Dummy Pallet	↓ (TP-157665)	H
Ω (TP-157718)	-	S
" (TP-157638)	+ (TP-157671)	Z
Dummy Pallet	- (TP-157642)	BLANK
- (TP-157642)	↑ (TP-157666)	A

28D-2 Type Box (Teletype Arrangement XV; TP-161365)

This type box contains the standard Gothic Style pallets for Weather Characters Arrangement D. It is designed for use on a typing unit which is equipped with a TP-154792 Modification Kit to provide 12 spaces per inch horizontally.

28E Type Box (Teletype Arrangement XH; TP-155709)

→ This type box contains the standard Long Gothic Style pallets for Punctuation Characters Arrangement A.

28 TYPE BOXES

→ 28E-1 Type Box (Teletype Arrangement WP; TP-155693)

This type box contains Long Gothic Style pallets for Punctuation Characters Arrangement A modified as follows:

<u>PALLET</u>	<u>REPLACING STANDARD PALLET</u>	<u>ON U.C.</u>
◇ (TP-155660)	\$ (TP-155667)	D
⊕ (TP-155661)	, (TP-155671)	N
⊖ (TP-155662)	; (TP-155670)	V
→ (TP-155663)	# (TP-155659)	H
* (TP-155664)	? (TP-155668)	B
∞ (TP-155665)	. (TP-155672)	M
# (TP-155659)	! (TP-155669)	F
BLANK	" (TP-155673)	Z

28F Type Box (Teletype Arrangement RV; TP-154643)

This type box contains Large Gothic Style pallets for Punctuation Characters Arrangement A modified by the replacement of the TP-157743 zero pallet with a TP-157764 zero with diagonal stroke (∅) pallet and the removal of the TP-157779 (#) pallet for upper case H. It is designed for use on a typing unit which is equipped with a TP-154755 or TP-159395 Modification Kit to provide 5 or 6 spaces per inch horizontally.

28F-1 Type Box (Teletype Arrangement WA; TP-153518)

This type box contains Large Gothic Style pallets for Punctuation Characters Arrangement A modified by the replacement of the TP-157743 zero pallet with a TP-157764 zero with diagonal stroke (∅) pallet. It is designed for use on a typing unit which is equipped with a TP-154755 or TP-159395 Modification Kit to provide 5 or 6 spaces per inch horizontally.

28G Type Box (Teletype Arrangement YK; TP-164348)

← This type box contains Large Gothic Style pallets for Fraction Characters Arrangement B modified by the removal of the quotation mark on upper case Z. It is designed for use as special teletypewriter equipment for brokerage service on typing units equipped with TP-154755 or TP-159395 Modification Kits. These Kits provide 5 or 6 spaces per inch horizontally.

28 TYPE BOXES

└─┬─▶ 28H Type Box (Teletype Arrangement YP; TP-176651)

└─┬─▶ This type box contains Murray Style pallets for Fraction Characters Arrangement C modified by the replacement of the TP-157651 (1/8) pallet by the TP-157719 (Maltese Cross) pallet and the replacement of the TP-157657 (7/8) pallet by the TP-179088 (\) pallet. It is the Dial TWX type arrangement.

END OF SECTION

28 SEQUENCE SELECTORS
& ASSOCIATED EQUIPMENT

SEQUENCE SELECTOR

28A Sequence Selector (Teletype LS1ADA201)

The 28A Sequence Selector is basically a 28 typing unit from which all the mechanisms required for printing and functions associated with printing have been omitted. It is equipped with a stuntbox so as to be responsive to teletypewriter selective-calling codes and provides a means whereby 15 KSR and 19 ASR teletypewriter equipment can be used with teletypewriter selective-calling systems. The contact arrangement and wiring are designed for the 83B1 selective-calling system.

Other features of the 28A Sequence Selector are as follows:

- a) A 28A distributor is supplied only when needed. It is mounted on the same base and is driven by the same motor as the selector.
- b) Numerous drillings on the side frames and front plate are vacant due to the omitted mechanisms.
- c) The selecting mechanism is the one which is standard for the 28 line, including the range-finder assembly.
- d) TP153440 universal function bars and TP4703 function bar springs are to be ordered and coded for required call directing characters and transmitter start codes as specified by customer.
- e) The stuntbox, associated cable, and connector can be removed from the unit. It is designated the ADA stuntbox.
- f) Since printing and the associated functions are not required, the main shaft is not equipped with the space-clutch assembly, spacing driving gear, keyboard driving gear, line-feed clutch assembly and typebox-clutch assembly.
- g) The 28A or 28B motor and intermediate shaft assembly as used on the 28 typing units are provided. Operation at 60, 75, or 100 W.P.M. can be provided.
- h) The 28A selector and motor unit are mounted on the 28A sequence selector base.
- i) A 35 terminal connector is mounted on the right-hand side frame to terminate the wiring from the stuntbox and the selector magnets. The motor wiring terminates at a 4 terminal block mounted on top of the 28A distributor or on the sequence selector when the distributor is not used.

Additional information may be found in Bell System Practices P70.034, P70.035, P70.037 and P98.474.

28 SEQUENCE SELECTORS
& ASSOCIATED EQUIPMENT

SEQUENCE SELECTOR

→ 28A-1 Sequence Selector (Teletype LS1ADB201)

This selector is the same as the 28A selector except that the ADA stuntbox is replaced by the ADB Stuntbox.

28A-2 Sequence Selector (Teletype LS1ADC201)

This selector is the same as the 28A selector except that the ADA stuntbox is replaced by the ADC stuntbox.

28B Sequence Selector (Teletype LS1ADD201)

This selector, designed for use in the 83B2 Selector Calling System, is the same as the 28A Selector except for the addition of a TP163146 (Universal Contacts) Mod. Kit and the replacement of the ADA stuntbox with an ADD stuntbox.

28D Sequence Selector (Teletype LS1ADG201)

This selector is the same as the 28A selector except the ADA stuntbox is replaced by the ADG stuntbox. This stuntbox is provided without contact blocks but has holes extended which allows mounting of contact blocks in any position.

28E Sequence Selector (Teletype LS1ADH201)

→ This selector is the same as the 28A selector except for the addition of a TP162146 (Universal Contacts) Mod. Kit and the replacement of the ADA stuntbox with an ADH stuntbox.

Western Electric Company, Inc.
 Service Division
 Distribution Engineering

Slot No.	STUNT BOX	ADA	ADB	ADC
	Sequence Selector	28A	28A-1	28A-2
	T.P. Number	154990	154991	154992
1				
2				
3				
4				
5				
6				
7				
8				
9				
10		FIG } H } ②	FIG } H } ⑤	FIG } H } ④
11		LTR } •	LTR } •	LTR } •
12		SV } CR } ③	CR } ③	CR } ④
13		LF } SLIDE	LF } SLIDE	LF } SLI
14				
15				
16				
17				
18		* } ①	CR } ③ ①	CR } ③ ④
19		* } ④	LF } ④	LF } ④
20		* } ①		* } CDC ④
21		* } ④		* } SEQ ④
22				* } CDC ④
23		- ④	FIG ④	* } SEQ ④
24		* } CONT. ①	LTR ①	
25		* } SEQ. ④	* ④	S UNIV ④
26		FIG } ②	FIG } ⑤	FIG } ④
27		H } ①	H } ①	H } ④
28		LTR } ④	LTR } ④	LTR } ④
29				
30				
31				
32		* } AUTO ④		
33		SV } TRANS ①	* ①	SO ④
34		* } CONT ①		
35		• BL } CONT		BL } SEQ
36		BL } SEQ ①	SPACE ①	BL } ①
37				
38		S UNIV. ①	SK ①	SV ④
39				
40		S UNIV.	S UNIV.	S UNIV.
41		SY } TEST]	SY } TEST]	SY } TEST]
42		SR } DEVICE]	SR } DEVICE]	SR } DEVICE]

STUNTBOKES FOR SEQUENCE SELECTORS

ADB	ADC	ADD	ADG	ADH	
28A-1	28A-2	28B	28D	28E	
154991	154992	154993	173151	154994	
		FIG } H } ②		FIG } H } ②	- = Slot en
		• LTR } ⑥		• LTR } ⑥	BL = Blank
		SY		SY	S = Select
		SV ⑦		M/V ⑦	CDC = Call
FIG } H } ⑤	FIG } H } ⑤		FIG } H } ②		* = Functio
• LTR)	• LTR)	FIG } ⑦	• LTR)	FIG } ⑦	** = Functio
		H } ② ⑦		H } ② ⑦	Cont. = Cont
CR } ③	CR } ③	• LTR)	CR	• LTR)	Seq. = Func
LF) SLIDE	LF) SLIDE	CR } ③	LF	CR } ③	code
		LF)		LF)	
		** } TRANS START		** } TRANS START	= Functio
		** } SEQ ⑥		** } SEQ ⑥] = Same sl
CR } ③ ①	CR } ③ ①	** } CDC SEQ		** } CDC SEQ	! = Latch r
LF) ④	LF) ④	**) ⑥		**) ⑥	Slide = Con
	* } CDC ①	** } CDC SEQ		** } CDC SEQ	
	* } SEQ ④	**) ⑥		**) ⑥	
	* } CDC ①	** } CDC SEQ		** } CDC SEQ	
FIG ④	* } SEQ ④	**) ⑥		**) ⑥	
LTR ①		** } TRANS START		** } TRANS START	① Normally
* ④	S UNIV ④	** } SEQ ⑥		** } SEQ ⑥	② End of m
FIG } ⑤	FIG } ⑤	** } CDC SEQ	FIG } ②	** } CDC SEQ	③ End of a
H } ①	H } ①	**) ⑥	H } ②	**) ⑥	④ Normally
• LTR) ④	• LTR) ④	** } CDC SEQ	• LTR)	** } CDC SEQ	⑤ Disconne
		**) ⑥		**) ⑥	⑥ Transfer
		** } CDC SEQ		** } CDC SEQ	Contact
		**) ⑥		**) ⑥	⑦ Transfer
* ①	SO ①			M/V	Contact
				LTR	
	BL } SEQ	• M/V }			⑦ Transfer
SPACE ①	BL } ①	LTRS } SEQ ⑦			Contact
		BL }		M/V	
SK ①	SV ①	BL } SEQ ⑦		BL }	⑧ Answer B
		SV ⑧ ⑥		BL } SEQ ⑦	
S UNIV.	S UNIV.	S UNIV.	S UNIV.	SV ⑧ ⑥	
SY } TEST]	SY } TEST]	SY } TEST]	SY } TEST]	SY } TEST]	
SR } DEVICE]	SR } DEVICE]	SR } DEVICE]	SR } DEVICE]	SR } DEVICE]	

ADH	
28E	
154994	
	NOTES & LEGEND
	- = Slot empty, item absent, or in a different slot.
FIG } H } ②	BL = Blank
• LTR } ⑥	S = Select
SY	CDC = Call Directing Characters
M/V ⑦	* = Function bars to be ordered separately
	** = Function parts to be ordered separately
FIG } ⑦ H } ② ⑦	Cont. = Control
• LTR } CR } ③ LF }	Seq. = Function performed only on sequential reception of designated code characters
** } TRANS START	= Function lever to operate two contacts
** } SEQ ⑥	⌋ = Same slide for two or more function levers
** } CDC SEQ	! = Latch release bail which releases latches mechanism as indicates
** } ⑥	Slide = Control of marking and spacing positions of associated code bars
** } CDC SEQ	
** } ⑥	
** } TRANS START	① Normally open contact
** } SEQ ⑥	② End of message sequence
** } CDC SEQ	③ End of address sequence
** } ⑥	④ Normally closed contact
** } CDC SEQ	⑤ Disconnect code sequence
** } ⑥	⑥ Transfer contact - rear Contact normally closed
M/V	
LTR	
⑦	⑦ Transfer contact - rear Contact normally open
• M/V	
BL }	⑧ Answer Back
BL } SEQ ⑦	
SV ⑧ ⑥	
S UNIV.	
SY } TEST	
SR } DEVICE	

28 SEQUENCE SELECTORS
& ASSOCIATED EQUIPMENT

BASE

28A Sequence Selector Base (Teletype LSB1/000)

This is a base structure for mounting a 28 type sequence selector and a 28 type motor unit. The 28A distributor which is supplied only when needed is also mounted on this base.

The base includes an intermediate gear assembly and a motor terminal block. If a 28 type distributor is required a longer intermediate gear driving shaft is required.

The base measures 15 1/2" wide and 9 1/2" deep. For additional information see Specification 5757S and Bulletin 1159B.

END OF SECTION

28 SEQUENCE SELECTORS
& ASSOCIATED EQUIPMENT

SEQUENCE SELECTOR

28B Sequence Selector- (Cont'd)

Slots

- 36-37 Close and latch a contact in Slot 37 in the "select" condition on receipt of M or V (in Slot 36) which latches lever in Slot 37 which remains latched to stripper bail as long as LTRS are received (in Slot 37). Provide 152299 function lever equipped with 152357 stud and 3599 nut in Slot 36. Provide 154646 function lever and 154613 latch plate in Slot 37.
- 38 Momentarily operate a transfer contact on receipt of V (answerback) in the "select" condition.
- 39 Momentarily close a "universal" contact in the "select" condition.
- 40-41-42 Provide RY test mechanism.

→ NOTE: TP153440 Universal Function Bars and TP4703 Function Bar Springs are to be ordered and coded for required Call Directory Code as specified by Customer.

Wiring information is found on drawing SD-70867-01-C4

28D Sequence Selector (Teletype LS1ADG201)

This unit is similar to a 28A Sequence Selector except that it has a stripped down stunt box. It is mounted on A 28 Sequence Selector Base equipped with a 28 type motor unit and a set of gears.

- Features:
1. A 35 terminal connector is mounted on the right hand side frame to terminate the wiring from the stunt box and selector magnets. The stunt box associated cable and connector can be removed as an assembly.
 2. No contact blocks are provided (these are to be provided locally where required).
 3. The row of tapped holes on the stunt box used for mounting contact blocks is extended so that the contact blocks can be mounted in any position.

28 SEQUENCE SELECTORS
& ASSOCIATED EQUIPMENT

SEQUENCE SELECTOR

28D Sequence Selector(Cont'd)

- Features:
4. CR and LF function bars are provided in slots 13 and 14 respectively.
 5. R-Y test mechanisms are provided in slots 40, 41 and 42.
 6. Figs., H and LTRS function bars are provided in slots 9, 10 and 11 and in 26, 27 and 28 with a latch release bail between the function levers in slots 11 and 28.

STUNTBX

ADA Stuntbox (TP154990-95)

The ADA Stuntbox is designed for use with the 28A sequence selector and arranged exclusively for use with the 83B1 selective-calling system.

No features associated with printing are provided and the "FIGS LTRS" shift slide is omitted, since no distinction between upper and lower case characters is required.

The stuntbox associated cable, and connector can be removed from the unit. Additional information may be found in Bell System Practices Section. P70.035.

BASES

28A Sequence Selector Base (Teletype LSB1/000)

This is a base structure for mounting a 28 type sequence selector and a 28 type motor unit. The 28A distributor which is supplied only when needed is also mounted on this base.

The base includes an intermediate gear assembly and a motor terminal block. If a 28 type distributor is required a longer intermediate gear driving shaft is required.

The base measures 15 1/2" wide and 9 1/2" deep. For additional information see Specification 5757S and Bulletin 1159B.

END OF SECTION

28 TYPING & NON-TYPING REPERFORATOR UNITS
& ASSOCIATED EQUIPMENT

TYPING REPERFORATOR UNITS

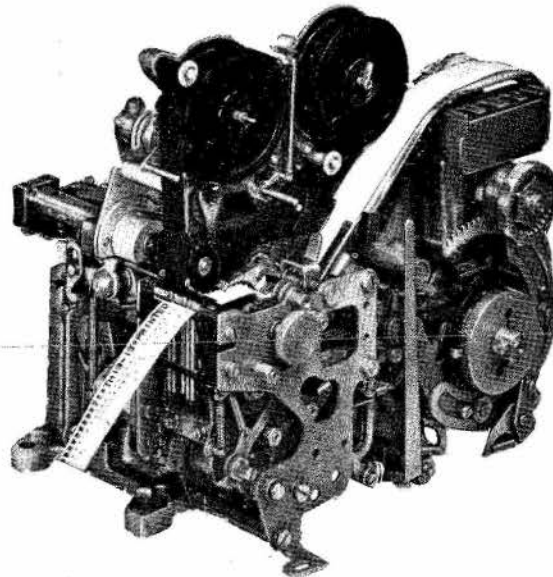

↳ GENERAL DESCRIPTION

The typing reperforator is utilized to receive telegraph signals from the line and present them on standard 11/16 inch wide tape in a five level perforated condition, for ease in transmission from a tape reading unit, and in a printed condition, for ease in reading the tape. The unit is equipped with a selecting mechanism, a tape punch and feeding mechanism and a type wheel printer which prints the characters in the area of the No. 1 and No. 2 code punch holes six characters after the associated perforation. Automatic ribbon reversal is provided.

↳ The typing reperforator is utilized as a self contained unit when mounted on its own table or associated with other typing reperforators in a cabinet. It may also be utilized as an auxiliary typing reperforator by mounting it in a 28ASR over the transmitter distributor base. In addition, the typing reperforator is a part of certain Perforator Transmitter Bases and Reperforator Transmitter Units.

Western Electric Company, Inc.
 Service Division
 Distribution Engineering

28 TYPING & NON-TYPING
 & ASSOCIATED

TYPING REPERFC

CODE DESIGNATION	WIRING DIAGRAM	TELETYPE CODE	TYPE ARRAN. (NOTE 1)				FUNCTION BARS				SIGNAL BELL CONTACT	LETTERS FEED OUT			PERF.	CODE READING CONTACTS (TRANSFER TYPE)	RECEIVE AUX. CONTACTS
			A	B	C	D	FIGURES	LETTERS	U.C. "S" - BELL	UNSHIFT ON SPACE (NOTE 2)		MANUAL TP161340	NON-INTERF.				
													SOLENOID (NOTE 3)	AUTOMATIC TP-162379 (4 SEC. DELAY)			
28A	P34.308	LPR4AWA	A				A	A	A	A	A				A		
28B	P34.308	LPR7AWA	B				B	B	B	B	B	B			B		
28C	P34.308	LPR22ARC			C		C	C	C	C	C				C		
28D	P34.308	LPR23ARC			D		D	D	D	D	D	D			D		
28E	P34.308	LPR22ARE			E		E	E	E	E	E				E		
28F	P34.308	LPR23ARE			F		F	F	F	F	F	F			F		
28G	P34.308	LPR32ARC			G		G	G	G	G			G		G		
28J	P34.308	LPR42ARA	J				J	J	J		J			J	J		
28J-1	P34.308	LPR42ARC			J1		J1	J1	J1		J1			J1	J1		
28K	P34.308	LPR54AXW			K		K	K	K	K				K	K		
28L	WD3628	LPR46BRB	L				L	L		L			L		L	L	L
28M	WD3628	LPR47BRB	M				M	M		M		M			M	M	M



28 TYPING & NON-TYPING REPERFORATOR UNITS
& ASSOCIATED EQUIPMENT

TYPING REPERFORATOR UNITS

NOTES:

1. TYPEWHEELS SUCH AS SH AND SPACE. MODIFIED B AND TYPE A U.C. "J".
2. UNSHIFT ON FOR DISABL
3. THE SOLENO TROLLING T IS DESIGNE 1/10 AMPHE ADDITION O
4. UNIT IS WI BASE TERMI
5. TYPE ARRAN ON U.C. "C
6. THESE UNIT FEED HOLES CONTACT. APPLICATION MULTIPLE M MOUNTED IN BOARD MOUN TO PROVIDE TP176615GA T.R. BASE (SET MUST BI PROVIDED W

E AN. E 1)	FUNCTION BARS				SIGNAL BELL CONTACT	LETTERS FEED OUT			PERF.	CODE READING CONTACTS (TRANSFER TYPE)	RECEIVE AUX. CONTACTS	36 POINT CONNECTOR	NOTES	REMARKS
	FIGURES	LETTERS	U.C. "S" - BELL	UNSHIFT ON SPACE (NOTE 2)		INTERF.	NON-INTERF.							
	A	A	A		A	A			A				4	82B SYSTEM
	B	B	B		B	B	B		B				4	82B SYSTEM
C	C	C	C	C	C	C			C			C		
D	D	D	D	D	D	D	D		D			D		
	E	E	E	E	E	E			E			E		
	F	F	F	F	F	F	F		F			F		
G	G	G	G	G	G		G		G			G		
	J	J	J		J			J	J			J		DELTA LINE SW. SYS.
J	J	J	J		J			J	J			J		Never Issued
K	K	K	K	K	K			K	K			K	5	DIAL TWX
	L	L		L			L		L	L	L	L	6	
	M	M		M					M	M	M	M	6	



REPERFORATOR UNITS
EQUIPMENT

REPERFORATOR UNITS

NOTES:

1. TYPEWHEELS INCLUDE STANDARD SYMBOLS FOR FUNCTIONS SUCH AS SHIFT, UNSHIFT, LINE/FEED, CARRIAGE RETURN AND SPACE. TYPE ARRANGEMENTS "A" AND "D" ARE MODIFIED BY A SLASH THROUGH ZERO (Ø) ON U.C. "P" AND TYPE ARRANGEMENT "B" IS MODIFIED BY A COMMA ON U.C. "J".
2. UNSHIFT ON SPACE FEATURE IS PROVIDED WITH A MEANS FOR DISABLING IT.
3. THE SOLENOID PROVIDES A MEANS OF MAGNETICALLY CONTROLLING THE MANUAL LETTERS FEED OUT MECHANISM. IT IS DESIGNED TO OPERATE ON 48VDC AT APPROXIMATELY 1/10 AMPHERE, BUT MAY BE USED ON 120VDC THROUGH THE ADDITION OF A CURRENT LIMITING RESISTOR.
4. UNIT IS WIRED DIRECTLY TO 28A TYPING REPERFORATOR BASE TERMINAL STRIP. NO CONNECTOR IS PROVIDED.
5. TYPE ARRANGEMENT "C" IS MODIFIED BY A MALTESE CROSS ON U.C. "C" AND A REVERSE SLANT (\) ON U.C. "N".
6. THESE UNITS ARE EQUIPPED WITH PRINTING BETWEEN THE FEED HOLES AND A TRANSFER TYPE (MAIN SHAFT) AUXILIARY CONTACT. A TP179252 CHAD CHUTE FOR SELF CONTAINED APPLICATION, A TP164341 MOD. KIT FOR EACH UNIT WHEN MULTIPLE MOUNTED, A TP164272 MOD KIT WHEN AUXILIARY MOUNTED IN A 28ASR, OR A TP170306 MOD. KIT WHEN KEYBOARD MOUNTED IN A 28ASR MUST BE ORDERED SEPARATELY TO PROVIDE CHAD DISPOSAL PARTS. IN ADDITION, A TP176615GA MOD. KIT FOR THE 28A T.R. TABLE AND 28 T.R. BASE OR A TP195391GA MOD. KIT FOR THE 28ASR SET MUST BE ORDERED. THE 28M UNIT WAS ORIGINALLY PROVIDED WITHOUT FEED-OUT.

30 POINT CONNECTOR	NOTES	REMARKS
	4	82B SYSTEM
	4	82B SYSTEM
		DELTA LINE SW. SYS.
		Never Issued
	5	DIAL TWX
	6	
	6	



CONVERSION KITS & TYPEWHEELS

→ CHADLESS TAPE UNITS

TP163415 Modification Kit - This kit is required to convert a 28C to a 28E typing reperforator or a 28D to a 28F typing reperforator. It consists of a typewheel with type arrangement D and two identification plates, one stamped 28E and the other stamped 28F.

TP163416 Modification Kit - This kit is required to convert a 28E to a 28C typing reperforator or a 28F to a 28D typing reperforator. It consists of a typewheel with type arrangement C modified by a diamond on upper case H and two identification plates, one stamped 28C and the other stamped 28D.

TP173967 Typewheel - Type arrangement "A" modified by a slash through O (Ø) on upper case P.

TP173968 Typewheel - Type arrangement "B" modified by a comma on upper case J.

TP173971 Typewheel - Type arrangement "C".

TP173970 Typewheel - Type arrangement "D" modified by a slash through O (Ø) on upper case P.

↪ FULLY PERFORATED TAPE UNITS *

TP173757 Typewheel - Type arrangement "A" modified by a slash through O (Ø) on upper case P.

TP175701 Typewheel - Type arrangement "B"

TP175711 Typewheel - Type arrangement "C"

↳ *Designed with smaller characters for printing between the feed holes.

28 TYPING & NON-TYPING REPERFORATOR UNITS
& ASSOCIATED EQUIPMENT

NON-TYPING REPERFORATOR UNIT

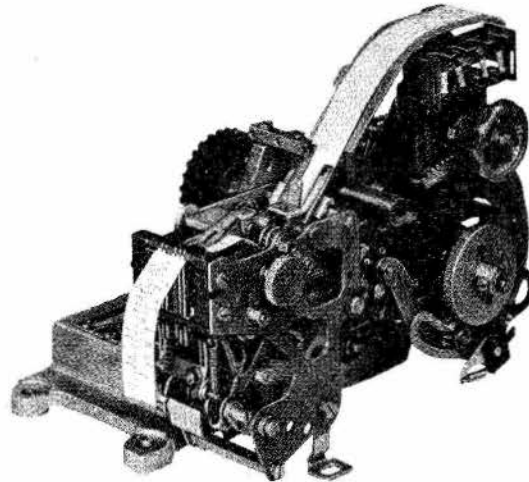

↳ 28H NON TYPING REPERFORATOR UNIT (Teletype LRPELO)

This unit, which produces fully perforated tape, is designed to mount on a 28D typing reperforator base which in turn mounts on a 28A typing reperforator table. The table must be modified to accommodate a chad container. Features of this unit are a chad chute which has an opening on top for clearing out chad in the event of a jam, a chad container for mounting on the table, and 31 point male & female connectors. Facilities are provided to accommodate manual, magnetic or noninterfering letters feed out which are not provided as standard.

↳ A TP164272 Mod. Kit when auxiliary mounted in a 28ASR or a TP16431 Mod. Kit for each unit when multiple mounted must be ordered separately in addition to a TP176615 GA Mod. Kit to provide chad disposal parts.

28 TYPING & NON-TYPING REPERFORATOR UNITS
& ASSOCIATED EQUIPMENT

TYPING REPERFORATOR BASES

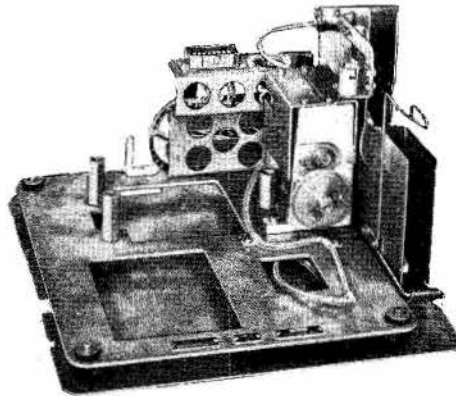

28A & 28D TYPING REPERFORATOR BASE
(SEE DESCRIPTIONS FOR DIFFERENCE)

28A TYPING REPERFORATOR BASE (Teletype LRB3)

This is a typing reperforator base designed to mount a 28A or 28B typing reperforator unit and a 28A Motor Unit for use in the 82B System.

It is a receiving only base structure equipped with a three speed gear shift mechanism designed to provide for operation at 60, 75, or 100 words per minute. The base includes a tape supply reel, 2 terminal strips, a 16 point connector, a power switch, a male three point twist lock power connector, a 4 ampere fuse, a low tape contact which operates an indicating lamp visible through a plastic button in the cover and an associated contact to operate the electrical service unit signal bell on low tape. A matching female power connector is also provided. The typing reperforator unit is driven from the gearshift mechanism by a flexible timing belt.

Dimensions of this base are 13 1/2" X 13" X 9".

Wiring is in accordance with BSP P34.308.

28 TYPING & NON-TYPING REPERFORATOR UNITS
& ASSOCIATED EQUIPMENT

TYPING REPERFORATOR BASES

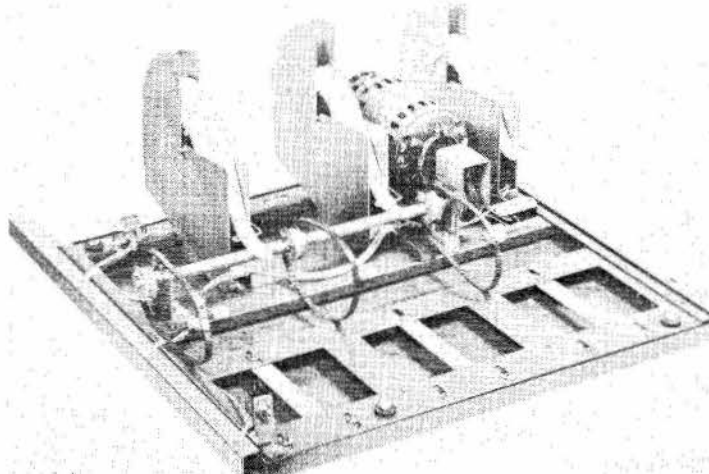

28B TYPING REPERFORATOR BASE

➤ 28B TYPING REPERFORATOR BASE (Teletype LMRB201BZ)

This two-piece sheet metal base, consisting of a mounting plate and an oil pan, is arranged to mount a 28 type motor unit and three 28 type typing reperforator units. It is intended for mounting in a 28 type apparatus cabinet.

The features of this base are the following:

1. A TP-161530 fixed drive gear set, consisting of a TP-161531 gear and a TP-161532 motor pinion, is furnished to drive the cross shaft at 368 opm. The cross shaft, through use of belt connectors, drives the typing reperforators equipped with the 28K, 28L or 28M sets of gears for operation at 60, 75 or 100 words per minute, respectively, and independent of each other.
2. Three tape supply containers equipped with tape out contacts are provided.
3. A 14 point female connector at which motor and tape out wiring is terminated. The matching male connector is also provided.
- 4. An on-off power switch located at the left front of the base is provided.

(28B TYP. REPERF. BASE Cont'd on next page)

28 TYPING & NON-TYPING REPERFORATOR UNITS
& ASSOCIATED EQUIPMENT

TYPING REPERFORATOR BASES

28B TYPING REPERFORATOR BASE (Teletype LMRB201BZ) (Cont'd)

5. Provision is made for installing a TP-164341 Modification Kit to provide chad disposal parts when the base is used with typing reperforators producing fully perforated tape.

→ 6. The base, supplied in charcoal gray smooth finish only, includes a TP161678 Mod. Kit for mounting in an apparatus cabinet.

Wiring is in accordance with BSP P34.308.

28C TYPING REPERFORATOR BASE (Teletype LRB5)

This is a base structure designed to mount in a 28G teletypewriter cabinet above the transmitter distributor base to provide the 28ASR with an auxiliary ROTR. The typing reperforator base is arranged to mount a T.R. unit, other than 28A or 28B, a 28A motor unit and a 28S, 28T or 28U Set of Gears for operating the unit at 60, 75 or 100 words per minute, respectively.

The features of this base are:

1. The base structure is mounted on posts, two of which are fastened to the rear rail of the cradle assembly and one to the transmitter distributor base.

2. A counter shaft drives the typing reperforator through a cog belt.

→ 3. The base comes equipped with a tape holder, a tape reel mounted at the rear, and a low tape switch.

→ 4. All connections between typing reperforator unit and associated 28D Electrical Service Unit which is mounted in the lower compartment of the cabinet are made through a 16 terminal connector. Connections to the → T.R. are through a 36 terminal connector.

5. Two terminal strips, a power switch, a fuse holder and a male three point twist lock power connector are provided. A matching female power connector is also provided.

(28C. TYP. REPERF. BASE Cont'd on next page)

28 TYPING & NON-TYPING REPERFORATOR UNITS
& ASSOCIATED EQUIPMENT

TYPING REPERFORATOR BASES

➤ 28C TYPING REPERFORATOR BASE (Teletype LRB5) (Cont'd)

6. Mod. Kits TP-161815 (tape chute and base mounting parts) and TP-161825 (panel with exit hole for tape) are necessary for installation of the 28C base in a 28G TTY cabinet and must be ordered separately.

Wiring is in accordance with BSP P34.308.

28D TYPING REPERFORATOR BASE (Teletype LRB21)

This is a receiving only base for mounting typing reperforator units other than 28A or 28B for self contained sets. It is similar to the 28A typing reperforator base except that the 28D base has a separable 36 point connector which mates with a similar connector on the typing reperforator units.

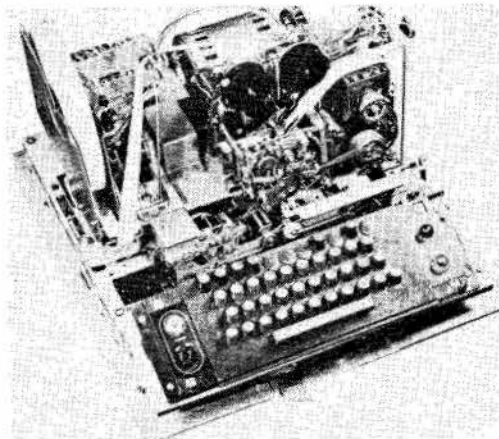

28E TYPING REPERFORATOR BASE

28E TYPING REPERFORATOR BASE (Teletype LTRKLARP)

This is a keyboard send-receive typing reperforator base arranged to mount a standard 28 type typing reperforator unit and a 28A motor unit. Features of this unit are as follows:

- 1. Keytop arrangement "C" with red keys for Keyboard lock, Keyboard unlock, line break, backspace, repeat and tape feedout features. Keyboard is equipped with repeat space feature.

(28E TYP. REPERF. BASE Cont'd on next page)

28 TYPING & NON-TYPING REPERFORATOR UNITS
& ASSOCIATED EQUIPMENT

TYPING REPERFORATOR BASES

28E TYPING REPERFORATOR BASE (Teletype LTRK1ARP) (Cont'd)

2. A Character Counter
3. Visual Indicators for "End of Line", "Motor On", and "Low Tape".
4. On-off Power Switch
5. A Copylight Transformer
6. A tape supply reel with low tape contacts.
- 7. A 16 point amphenol connector plus spare connector for customer's use. (connections may be made through terminal board at rear of base if desired).
8. Operation at 60, 75, or 100 works per minute through use of 28A-1, 28B-1 or 28C-1 set of gears, respectively.
9. A means for locking the cover to the base.
- 10. A 36 point typing reperforator unit connector.

This base may be used in conjunction with an electrical service unit when required.

NOTE: See 28B typing reperforator cover.

↵ 28F TYPING REPERFORATOR BASE

↵ This base, designed for use in the C1 Alarm and Control System is similar to the 28A T.R. Base except for the addition of a 36 point T.R. unit connector and a TP178301 Motor Control Relay. The power switch is wired in series with the motor contacts of the motor control relay.

28 TYPING & NON-TYPING REPERFORATOR UNITS
& ASSOCIATED EQUIPMENT

TYPING REPERFORATOR CABINET

28A45 TYPING REPERFORATOR CABINET (Teletype AC266GA)

This is a typing reperforator cabinet designed primarily as a monitoring cabinet for the 82B System.

The cabinet is a universal type approximately 33" wide by 24" deep by 77" high and is arranged to mount four typing reperforators, each mounted on its own base, and four associated tape winders, on two drawer-type shelves. The arrangements are such that when a drawer holding two typing reperforators is pulled forward, the tape winders associated with the typing reperforators also are carried forward.

Connections within the cabinet are brought to a 6 point AC-DC terminal block and a 120 point terminal block in the upper portion of the cabinet. Power factor correction capacitors of 50 mfd are located behind the blocks. Four 18 point plugs to provide individual circuit connection to each unit and four three point power receptacles are provided. Individual tape-out indicators, power switches, and fuses are provided. Four duplex receptacles provide 3 wire power connections for each tape winder plus four convenience sources.

Wiring is in accordance with B127108 and teletype drawings WD3313 and WD3314.

→ ...
28A-1-45 TYPING REPERFORATOR CABINET (Teletype AC272GA)

This cabinet is similar to the 28A45 typing reperforator cabinet except that it is equipped with means for mounting six typing reperforators on three shelves and is not arranged to mount tape winders. It is designed primarily for torn tape sending.

The tape from the typing reperforators is fed through slots in the front doors. A small bin is provided for tape storage.

Wiring is in accordance with B127712.

28 TYPING & NON-TYPING REPERFORATOR UNITS
& ASSOCIATED EQUIPMENT

TYPING REPERFORATOR TABLE

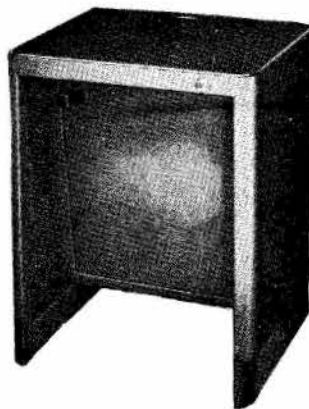

28A45 TYPING REPERFORATOR TABLE (Teletype LT200GA)

This table is similar in size and appearance to the lower portion of a 28 type teletypewriter cabinet. A large hole is provided at the top rear of the table in the center to provide for connection of a cord between the typing reperforator base and an electrical service unit or other apparatus mounted in the cavity of the table. Furnished within the table is a line termination connecting block. Dimensions of this table are 20 1/2" wide, 18 1/4" deep and 25 3/4" high. The bottom shelf is 3 1/2" from the floor and the front opening is 17" wide. The top is flat and covered with linoleum.

28 TYPING & NON-TYPING REPERFORATOR UNITS
& ASSOCIATED EQUIPMENT

TYPING REPERFORATOR COVERS



28A45 TYPING REPERFORATOR COVER

28A45 TYPING REPERFORATOR COVER (Teletype LRC200GA)

This is a small sheet-metal cover for housing a typing reperforator base and unit. It is equipped with a plastic window for observing the printed copy without raising the hinged portion of the cover. Dimensions of this cover are 13 1/2" deep, 13" wide and 9 1/2" high.

28 TYPING & NON-TYPING REPERFORATOR UNITS
& ASSOCIATED EQUIPMENT

TYPING REPERFORATOR COVERS



28B45 TYPING REPERFORATOR COVER

28B45 TYPING REPERFORATOR COVER (Teletype LSRC200GA)

This is a cover designed to fit the 28E typing reperforator base. Its dimensions are 17" wide, 19" deep and 12" high. Features of this cover are a copylight, a character counter light, a copyholder, and an access door in front for changing ribbons and tapes.

END OF SECTION

28 TYPING REPERFORATOR UNIT
& ASSOCIATED EQUIPMENT

TYPING REPERFORATOR COVER

28A45 TYPING REPERFORATOR COVER (Teletype LRC200GA)

This is a small sheet-metal cover for housing a typing reperforator base and unit. It is equipped with a plastic window for observing the printed copy without raising the hinged portion of the cover. Dimensions of this cover are 13 1/2" deep, 13" wide and 9 1/2" high.



28B45 TYPING REPERFORATOR COVER (Teletype LSRC200GA)

This is a cover designed to fit the 28E typing reperforator base. Its dimensions are 17" wide, 19" deep and 12" high. Features of this cover are a copylight, a character counter light, and an access door in front for changing ribbons and tapes.

28 TRANSMITTER DISTRIBUTOR UNITS
& ASSOCIATED EQUIPMENT

TRANSMITTER DISTRIBUTOR UNITS

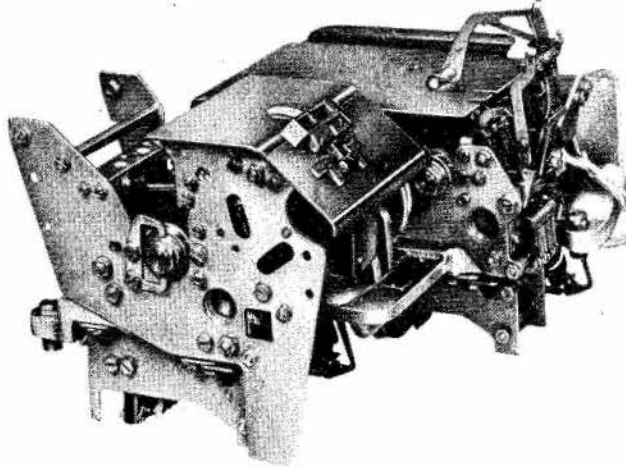

28B Transmitter Distributor Unit

➤ 28B Transmitter Distributor Unit (Teletype LCXD1)

This is a transmitter distributor unit designed for use with the 82B System. This unit consists of a pivoted transmitter, fixed gate transmitter and a multicontact distributor. It has two (2) shafts and three (3) clutches which control independently the three sections of the unit. Operation is in a feed-read-distribute sequence.

The pivoted transmitter is located within the 28F teletypewriter cabinet in line with the punch unit. It has a climbing head which reads the last character perforated in the chadless tape. The pivoted head can swing away from the perforator and allow the tape to feed into a tape storage bin. This transmitter has a contact for each sensing pin, an auxiliary contact, a distributor clutch-magnet contact, a tape out pin contact and a tape available contact which opens when the last character in the tape is sensed. The fixed gate transmitter is used as an auxiliary for sending from prepared tape without removing the tape from the pivoted transmitter. This transmitter has a sensing contact for each element of the code, a transmitter auxiliary contact,

28 TRANSMITTER DISTRIBUTOR UNITS
& ASSOCIATED EQUIPMENT

TRANSMITTER DISTRIBUTOR UNITS

➤ 28B Transmitter Distributor Unit (Teletype LCXD1) (Cont'd)

a distributor clutch-magnet operating contact, a tape-out contact (riding sixth pin) a tape-lid contact and a tangle tape contact. A "Start-Stop-Freewheeling" switch is not provided on this unit.

The distributor is a multiwire unit which operates from either of the transmitters to generate a neutral signal. The distributor shaft is actually a "distributor and sensing shaft" which extends across the width of both transmitters. Two (2) auxiliary contacts are provided in this unit.

Internal wiring of the 28B transmitter-distributor unit is connected to the cabinet terminal block by cabling from the 28C electrical service unit. Connectors mounted on the 28B transmitter-distributor base mate with the connectors of the 28C Electrical Service Unit. This transmitter distributor is not designed for use in a self contained unit. The clutch magnets are designed for 48V DC operation.

➤ Wiring is in accordance with BSP P34.306.

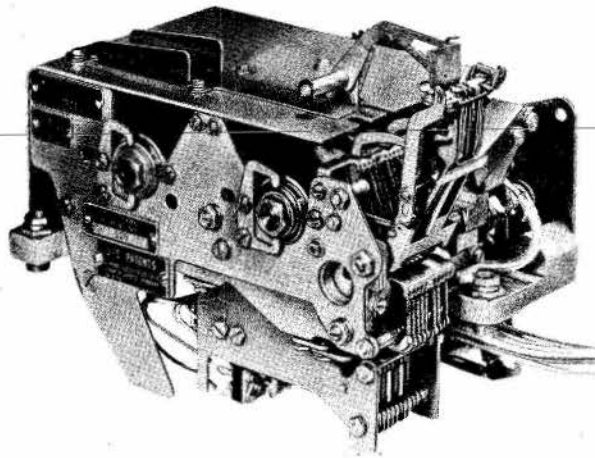

28C Transmitter Distributor Unit

28 TRANSMITTER DISTRIBUTOR UNITS
& ASSOCIATED EQUIPMENT

TRANSMITTER DISTRIBUTOR UNITS

➔ 28C Transmitter Distributor Unit (Teletype LAXD3)

This is a transmitter distributor unit designed for use with the 82 System.

It consists of a pivoted head transmitter and a multiwire distributor similar to these items on the 28B transmitter distributor unit except that the distributor shaft is shortened.

Wiring is in accordance with BSP P34.306.

28E Transmitter Distributor Unit (Teletype LXD3) Manufacture discontinued.

Replaced by 28H T.D. Unit.

This unit is the same as the 28H Transmitter Distributor Unit except that wiring from the 28E is brought out through a foot long cable to a 20 terminal male connector mounted on the 28E, 28E-1, or 28E-2 Transmitter Distributor Base instead of to a 36 terminal male connector mounted on the unit as in the 28H T.D. Unit. For features of this unit see the description of the 28H Transmitter Distributor Unit.

When used in a 28ASR Station the 28E45 or 28H45 T.D. housing must be furnished. It may be used as a self-contained T.D. or on a multiple mounted T.D. Base if it is equipped with a 36 terminal connector.

Wiring is in accordance with P34.315.

28F Transmitter Distributor Unit (Teletype LBXD5) Manufacture discontinued.

Replaced by a 28G T.D. Unit.

➔ This unit is the same as the 28G Transmitter Distributor Unit except that the wiring from the 28F is brought out through three 14 terminal female connectors mounted on the unit which plugs into the 28F T.D. Base instead of to a 36 terminal male connector as in the 28G T.D. Unit. For features

(28F T.D. Cont'd on next page)

28 TRANSMITTER DISTRIBUTOR UNITS
& ASSOCIATED EQUIPMENT

TRANSMITTER DISTRIBUTOR UNITS

→ 28F Transmitter Distributor Unit (Teletype LBXD5) (Cont'd)

of this unit see the description of the 28G Transmitter Distributor Unit.

When used in a 28ASR Station the 28F45 T.D. housing must be furnished.
It is not designed for use as a self-contained T.D.

Wiring is in accordance with P34.315.

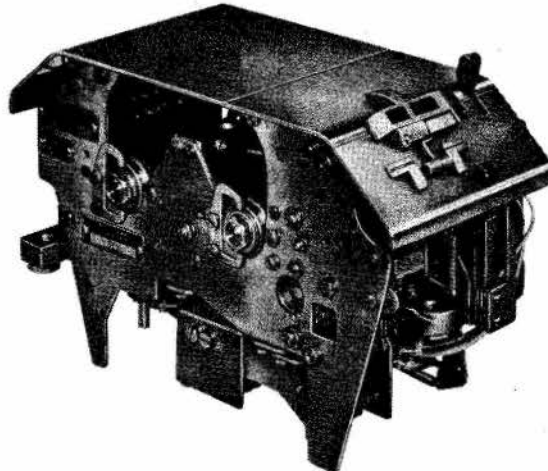

28F OR 28G TRANSMITTER DISTRIBUTOR UNIT

28G Transmitter Distributor Unit (Teletype LBXD7)

This unit is a multi-contact fixed gate transmitter distributor utilized to read perforated tape or an external multi-wire input for sequential transmission. The unit is also capable of reading tape and providing a multi-wire output.

→ The 28G Unit provides two shaft and sleeve assemblies and separate sensing and distributing mechanisms capable of being actuated

(28G T.D. Cont'd on next page)

28 TRANSMITTER DISTRIBUTOR UNITS
& ASSOCIATED EQUIPMENT

TRANSMITTER DISTRIBUTOR UNITS

→ 28G Transmitter Distributor Unit (Teletype LBXD7) (Cont'd)

independently of one another from either a local or remote source. It is the same as the 28F Transmitter Distributor Unit except for the utilization of a 36 terminal male connector instead of three 14 terminal female connectors as in the 28F T.D. Unit.

Features of this unit include a three position control lever with start, stop and free wheeling positions, a taut or tangled tape arm which activates the stop contact, a tape out contact activated by a sixth pin and 186A Networks across the clutch magnets. Also included is provision for modifying the unit for use with 6, 7 or 8 level tape. Auxiliary contacts "A" and "B" operated from the sensing cam sleeve are provided for controlling external circuits and auxiliary contact "C" operated from the distributor cam sleeve is provided for controlling the sensing cam. Storing of the last character sensed for subsequent transmission is provided. The unit features a feed-read sequence of operation. In installations requiring additional contacts on the unit a second 36-terminal connector and cable can be mounted on the transmitter distributor unit. A set of parts is available for this purpose.

The 28G-TD Unit in ASR applications must be used in conjunction with the 28G Transmitter Distributor Base and with the 28G45 or a modified 28F45 Transmitter Distributor housing.

The 28G-TD Unit can be used in an ASR set, as a self-contained TD, or on a multiple mounted TD Base.

→ Wiring is in accordance with BSP P34.315.

28G-1 Transmitter Distributor Unit (Teletype LBXD14)

The 28G-1 transmitter distributor unit is the same as the 28G-T.D. unit except that the three position control lever is omitted on the 28G-1. This unit was designed for use with 81D1 System.

28 TRANSMITTER DISTRIBUTOR UNITS
& ASSOCIATED EQUIPMENT

TRANSMITTER DISTRIBUTOR UNITS

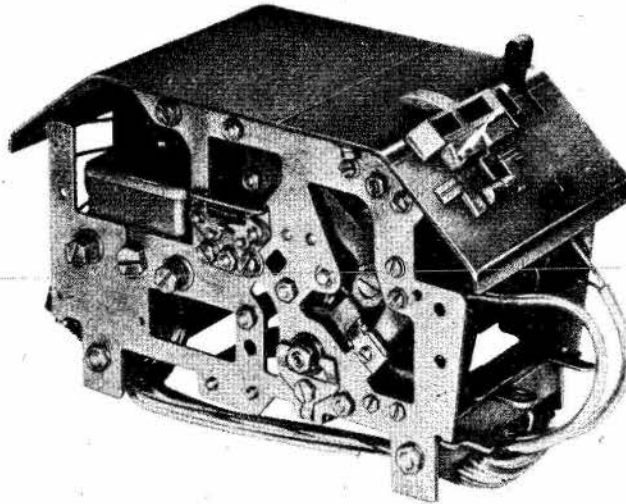

28E OR 28H TRANSMITTER DISTRIBUTOR UNIT

→ 28H Transmitter Distributor Unit (Teletype LXD4)

This unit is a single contact, fixed gate transmitter distributor utilized to read five level perforated tape. It features a single shaft and sleeve assembly which provides completion of both the transmitting and distributing cycles in one revolution of the shaft. The 28H transmitter distributor unit is the same as the 28E transmitter distributor unit except for the addition of a 36 terminal male connector mounted on the unit at which the wiring is terminated in place of the foot long cable that is furnished on the 28E unit.

→ Features of this unit include a three position control lever with start, stop and free wheeling positions, a taut or tangled tape arm which activates the stop contact, a tape out contact activated by a sixth pin and a 185A Spark Suppressor Network across the signal contacts. The single pair of clutch magnets is designed for operation on 115V A.C. but may be utilized on D.C. by limiting the current to 100 milliamperes. This is accomplished by adding a 1000 ohm resistor for 120V D.C. and a 350 ohm resistor for 50V D.C. The unit features a read-feed sequence of operation.

(28H T.D. Cont'd on next page)

28 TRANSMITTER DISTRIBUTOR UNITS
& ASSOCIATED EQUIPMENT

TRANSMITTER DISTRIBUTOR UNITS

28H Transmitter Distributor Unit (Teletype LXD4) (Cont'd)

The 28H-TD unit in ASR applications, must be used, in conjunction with the 28H-TD base and either the 28H45 or 28E45 TD housing.

The 28H-TD unit can be used on an ASR set, as a self-contained TD, or on a multiple mounted TD Base.

Wiring is in accordance with P34.315.

28H-1 Transmitter Distributor Unit (Teletype LXD15)

The 28H-1 transmitter distributor unit is the same as the 28H-TD unit except that the three position control lever is omitted on the 28H-1. This unit was designed for use with 81D1 System.

28H-2 Transmitter Distributor Unit (Teletype LXD5)

This unit is similar to the 28H transmitter distributor unit except that it is equipped with a sensing bail to release the magnet when either "figures" or "letters" is sensed on the tape.

28H-3 Transmitter Distributor Unit (Teletype LXD18)

This unit, designed for use in Dial TWX, is similar to the 28H transmitter distributor unit except that it is equipped with a sensing bail to release the magnet when either "figures" or "letters" is sensed in the tape and the 185A Spark Suppressor Network is removed from across the distributor signal contacts.

➔ 28H-4 Transmitter Distributor Unit (Teletype LXD9)

➔ This unit, designed for use with the 28H-1 T.D. Mtg & Cover Assembly, is similar to the 28H T.D. Unit except for the addition of a TP162490 Mod. Kit to provide parallel code reading contacts.

(Cont'd on Page 7A)

28 TRANSMITTER DISTRIBUTOR UNITS
& ASSOCIATED EQUIPMENT

TRANSMITTER DISTRIBUTOR UNITS

➤ 28H-5 Transmitter Distributor Unit

This unit, designed for use in the 83B3 System, is similar to the 28H T.D. Unit except for the addition of a TP179603 Mod. Kit to provide "Tape-Withhold" Parts.

➤ These parts are used to transmit the character "letters" during tabulation. The magnet operates on 115 volts dc or 48 volts dc when equipped with a 1100 ohm resistor. Wiring of the magnet is brought out through a 4 foot cable which is wired to the "C" terminal strip or 28H T.D. Mtg. & Cover Assembly.

(Cont'd on Page 8)

28 TRANSMITTER DISTRIBUTOR UNITS
& ASSOCIATED EQUIPMENT

TRANSMITTER DISTRIBUTOR UNITS
FOR USE IN LINE SWITCHING SYSTEMS

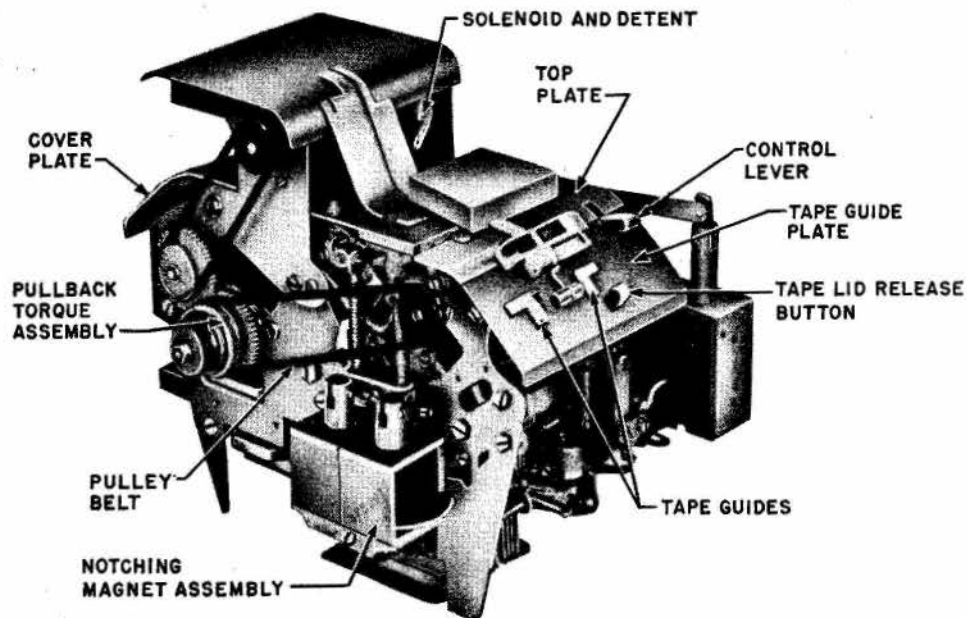

28LA TRANSMITTER DISTRIBUTOR UNIT

28LA Transmitter Distributor Unit (Teletype LFXD1)

This unit is a multi-contact, two shaft, fixed gate transmitter distributor utilized for sensing nine level codes. It may be arranged for multi-wire output, single wire sequential output, or both.

Features of this unit include a "stop-run" control lever, a taut or tangled tape arm which activates the stop contact and a tape out contact. Three cam operated auxiliary contacts separated from the sensing contacts, tape pullback and runout mechanisms which, through externally controlled solenoids, advance and pull back the tape at high speed, two externally controlled, solenoid operated, tape notches which provide for chadless tape perforation in the normal sixth code level, and at the edge of the tape corresponding to the ninth code level are provided. In addition a second tight-tape contact

(28LA T.D. Cont'd on next page)

28 TRANSMITTER DISTRIBUTOR UNITS
& ASSOCIATED EQUIPMENT

TRANSMITTER DISTRIBUTOR UNITS
FOR USE IN LINE SWITCHING SYSTEMS

↳ 28LA Transmitter Distributor Unit (Teletype LFXD1) (Cont'd)

assembly to sense the completion of the pullback operation and a second tape guide which, when latched in position, guides the tape from the reading level to an upper level are provided. One 36 point male and one 36 point female connector are provided for plugging into the 28LA Transmitter Distributor Base.

Wiring is in accordance with BSP P34.315.

28LB Transmitter Distributor Unit (Teletype LFXD2)

↳ This unit is the same as the 28LA Transmitter Distributor Unit except for the addition of a second bank of code reading contacts to provide added reliability.

28 TRANSMITTER DISTRIBUTOR UNITS
& ASSOCIATED EQUIPMENT

TRANSMITTER DISTRIBUTOR BASES



NOTE: Sets of Gears for operating the Transmitter Distributor Units at 60, 75 and 100 words per minute must be ordered separately or are included with the 28ASR Sets of Gears.

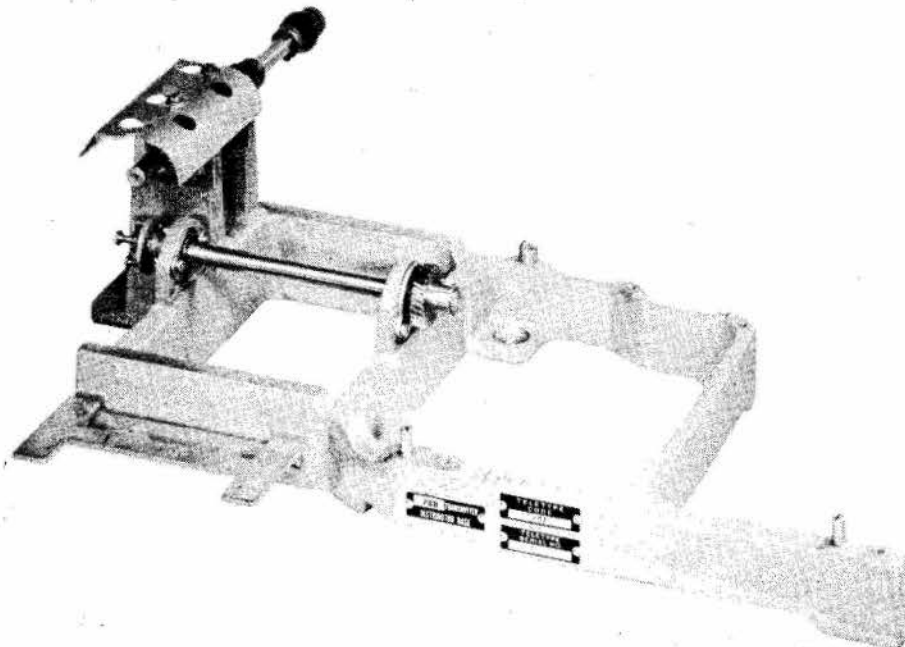

28B Transmitter Distributor Base (Teletype LCXB2)

This is a transmitter distributor base designed for use with the 82B System.

This base is designed to mount a 28B Transmitter Distributor Unit in a 28F Teletypewriter Cabinet.

28C Transmitter Distributor Base (Teletype LCXB3)

This is a transmitter distributor base designed for use with the 82B System.

This base is designed to mount a 28C Transmitter Distributor Unit in a 28F Teletypewriter Cabinet.

10-28-64

Replacing Page 11 dated 6-20-62

28 TRANSMITTER DISTRIBUTOR UNITS
& ASSOCIATED EQUIPMENT

TRANSMITTER DISTRIBUTOR BASES

28E Transmitter Distributor Base (Teletype LCXB1) Manufacture discontinued.

This base, designed for mounting a 28E transmitter distributor unit in a 28G teletypewriter cabinet, is similar to the 28H Transmitter Distributor Base except that the 28E base does not have the 36 terminal female connector. Wiring from the 28E Transmitter Distributor Unit is brought directly to a 20 terminal male connector provided in the base which mates with the electrical service unit connector.

The base is equipped with drillings for mounting a 28A or 28D distributor in addition to the 28E TD Unit.

→ 28E-1 Transmitter Distributor Base (Teletype VCL201-LCXB10+LD6) Manuf. Disc.

This base is similar to the 28H base except that it is equipped with a 28D-2 distributor and connecting cable. Operation is at 100 words per minute.

→ 28E-2 Transmitter Distributor Base (Teletype VCL200-LCXB10+LD5) Manuf. Disc.

This base is similar to the 28H base except that it is equipped with a 28A-2 distributor and connecting cable. Operation is at 60 or 75 words per minute.

28F Transmitter Distributor Base (Teletype LCXB7)

This base assembly, utilized for mounting a 28F transmitter distributor unit in a 28G teletypewriter cabinet, is the same as the 28G Transmitter Distributor Base except that three 14 terminal male connectors which mate with the 28F Transmitter Distributor Unit are provided in place of the 36 point female connector furnished on the 28G Transmitter Distributor Base.

Wiring is in accordance with BSP P34.320.

28G Transmitter Distributor Base (Teletype LCXB9)

This base assembly, utilized for mounting a 28G or similar transmitter distributor unit in a 28G teletypewriter cabinet, features a 36 terminal

(28G T.D. Base Cont'd on next page)

28 TRANSMITTER DISTRIBUTOR UNITS
& ASSOCIATED EQUIPMENT

TRANSMITTER DISTRIBUTOR BASES

→ 28G Transmitter Distributor Base (Teletype LCXB9) (Cont'd)

female connector which mates with the 28F45 or 28G45 housing, and a 20 terminal male connector which mates with the electrical service unit.

To permit operation of the clutch magnets on either 115 or 48 volts d.c. two resistors are mounted on the base, each resistor consisting of 900 ohms in series with 100 ohms. One is wired in series with the distributor clutch magnet, the other in series with the transmitter clutch magnet. Strapping out the 100 ohm section of the resistors allows the operation of the clutch magnets on 48V D.C.

A 28F-TD unit cannot be mounted on a 28G TD base.

Wiring is in accordance with BSP P34.320.

28H Transmitter Distributor Base (Teletype LCXB8)

This base, designed for mounting a 28H or similar transmitter distributor unit in a 28G teletypewriter cabinet, features a 36 terminal female connector which mates with the TD unit and a 20 terminal male connector which mates with the electrical service unit.

Wiring is in accordance with BSP P34.320.

28H-1 Transmitter Distributor Base (Teletype VCL225-LCXB8+LD8)

This base is the same as the 28H transmitter distributor base except that it is equipped with a 28J-1 distributor. A plug, cable and terminal blocks for mounting on the left side wall of the cabinet, are provided with the base.

28H-2 Transmitter Distributor Base (Teletype LCXB16)

→ This base is similar to the 28H transmitter distributor base except that it is wired for DC operation, is equipped with an answerback mechanism, and the base casting is designed to mount the answerback mechanism so it will be recessed approximately 3 1/2 inches.

28 TRANSMITTER DISTRIBUTOR UNITS
& ASSOCIATED EQUIPMENT

TRANSMITTER DISTRIBUTOR BASES

➔ 28H-3 Transmitter Distributor Base

This base, designed for use with Dial TWX, is equipped with the following features:

1. TP-178316 Modification Kit; Answerback Mechanism
2. A cable assembly with a 36 terminal connector on one end which mates with the 28H transmitter distributor connector, and a 20 terminal connector in the other end which mates with an electrical service unit connector.
3. Wiring for A.C. operation.
4. A base casting designed to recess the answerback mechanism approximately 1 inch.

28J45 Transmitter Distributor Base (Teletype LMXB202GA)

This is a multiple transmitter base used for mounting three 28H transmitter distributor units each of which may be operated at either 60, 75 or 100 words per minute through the use of 28W, 28Y or 28AA set of gears, respectively. These gears must be ordered separately.

The base can be used as a self-contained Unit or in a Model 28A-3, 28A-4 or 28A-5 apparatus cabinet. The TD base consists of a dust cover, three TD unit rear cover plates, a main base casting resiliently mounted to a subbase, a power switch, three line shunt switches, three 36 terminal female connectors, terminal boards, provision for circuit designation cards, a countershaft and three intermediate shafts with pinion drive gears and a set of sprocket gears with belt which drives the countershaft. The 28A or 28B motor required to drive the countershaft must be ordered separately. Cabling for connection to the 36 terminal female connectors is to be furnished by customer.

➔ Wiring is in accordance with BSP P34.320.

28 TRANSMITTER DISTRIBUTOR UNITS
& ASSOCIATED EQUIPMENT

TRANSMITTER DISTRIBUTOR BASES

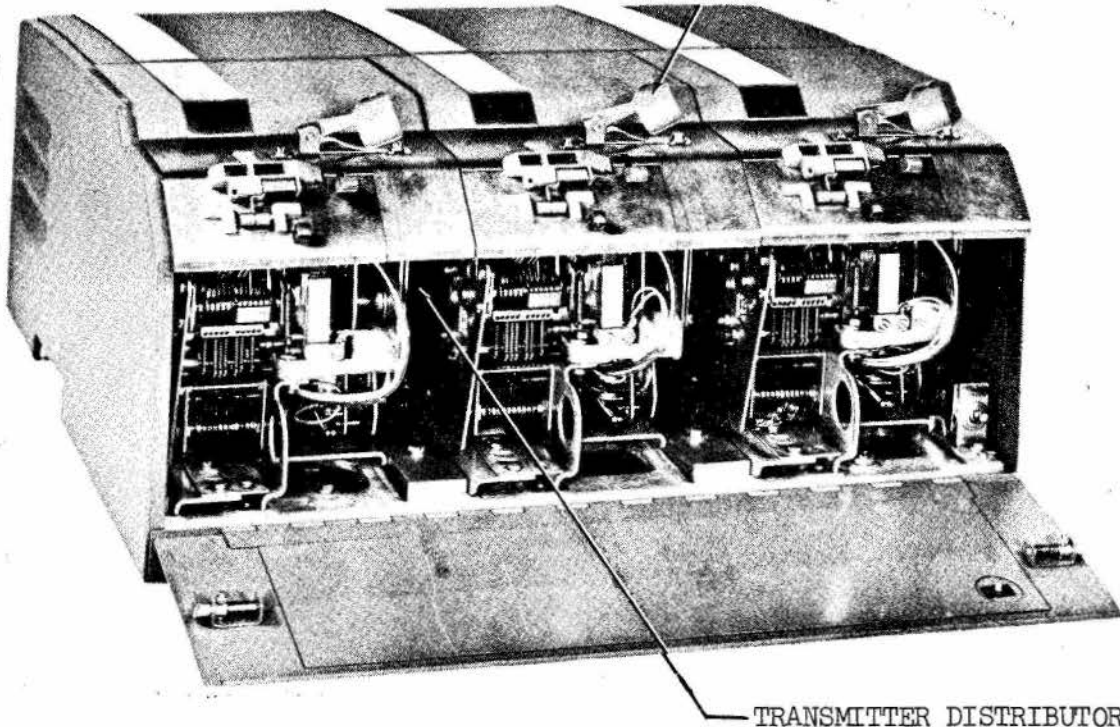

28K45 TRANSMITTER DISTRIBUTOR BASE

↳ 28K45 Transmitter Distributor Base (Teletype LMXB204GA)

This is a multiple transmitter base used for mounting three 28G multi-contact transmitter distributor units each of which may be operated at either 60, 75 or 100 words per minute through the use of 28AB, 28AC or 28AD set of gears, respectively. These gears must be ordered separately.

↳ The base can be used either as a self-contained unit or in a Model 28A-3, 28A-4 or 28A-5 apparatus cabinet. It consists of a dust cover, three TD

(28K45 T.D. Base Cont'd on next page)

28 TRANSMITTER DISTRIBUTOR UNITS
& ASSOCIATED EQUIPMENT

TRANSMITTER DISTRIBUTOR BASES

└─▶ 28K45 Transmitter Distributor Base (Teletype LMXB204AB) (Cont'd)

unit rear cover plates, a main base casting resiliently mounted to a subbase, a power switch, three line shunt switches, three 36 terminal female connectors, terminal boards, provision for circuit designation cards and a countershaft assembly with motor pinion and countershaft driven gear (TP-172778 and TP-172777).

Three (3) TP-161587 modification kits must be ordered to adapt the 28G transmitter distributors to the base. A 28A or 28B motor to drive the three transmitter distributors must be ordered separately. Cabling for connection to the 36 terminal female connectors is to be furnished by the customer. Dimensions of this unit are 17 inches wide, 15 3/4 inches deep and 7 5/8 inches high.

└─▶ Wiring is in accordance with BSP P34.320.

28 TRANSMITTER DISTRIBUTOR UNITS
& ASSOCIATED EQUIPMENT

TRANSMITTER DISTRIBUTOR BASES
FOR USE IN LINE SWITCHING SYSTEMS

↳ 28LA Transmitter Distributor Base (Teletype LFXB1)

This base, designed for use in the sending set of a line switching system, contains a countershaft to connect motor drive to transmitter distributor, one 36 terminal male and one 36 terminal female connector to mate with the transmitter distributor, one 50 terminal female and one 24 terminal female connector to mate with relay logic circuitry and six 186A Networks and two 100 ohm resistors. The 186A Networks are for contact protection across the windings of the run out, reader clutch and distributor clutch magnets and the pull-back and notcher solenoids.

↳ Wiring of this unit is in accordance with BSP P34.320.

28 TRANSMITTER DISTRIBUTOR UNITS
& ASSOCIATED EQUIPMENT

TRANSMITTER DISTRIBUTOR HOUSINGS

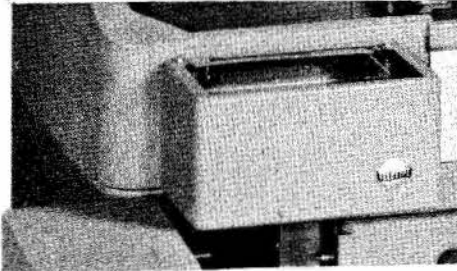

➤ 28B45 Transmitter Distributor Housing (Teletype TP-160889GA S.O.P. LCXD)

This transmitter housing is utilized to provide a cover for the front projecting portion of the fixed gate transmitter of a 28B Transmitter Distributor Unit, when mounted on a 28F Teletypewriter Cabinet.

28C45 Transmitter Distributor Housing (Teletype TP-160890GA S.O.P. LAXD)

This transmitter housing provides a covering for the opening in a 28F Teletypewriter Cabinet when a 28C Transmitter Distributor is used.

28E45 Transmitter Distributor Housing (Teletype TP-160887GA S.O.P. LXD)

This transmitter housing provides a covering for the opening in a 28G teletypewriter cabinet when a 28E Transmitter Distributor is used.

28F45 Transmitter Distributor Housing (Teletype TP-160888GA S.O.P. LBXD)

This is a sheet metal enclosure designed to fit around the front position of the 28F transmitter distributor unit when the unit is mounted in the 28G teletypewriter cabinet. Included with this housing are terminal strips covering terminals C81 to C120 for mounting on the left side of the cabinet, a 32 terminal male TD Base Connector, and necessary cabling.

➤ Wiring is in accordance with BSP P34.320.

28 TRANSMITTER DISTRIBUTOR UNITS
& ASSOCIATED EQUIPMENT

TRANSMITTER DISTRIBUTOR HOUSINGS

➤ 28G45 Transmitter Distributor Housing (Teletype TP-160888GA S.O.P. LBXD)

This is a sheet metal enclosure that fits around the front portion of the 28G-TD unit when the unit is mounted in the 28G teletypewriter cabinet.

The 28G-TD housing is the same as the 28F-TD housing except for the left front crossbar. The opening in the crossbar has been increased to permit the 28G-TD unit to be lifted vertically enough to disengage the cable connector on a 28G-TD unit from its mating connector on the 28G-TD base. The 28G-TD unit is used in the ASR cabinet with the 28G-TD housing or with a modified 28F-TD housing that has the left front crossbar opening increased to conform with the 28G-TD housing left front crossbar.

Wiring is in accordance with BSP P34.320.

28H45 Transmitter Distributor Housing (Teletype TP-160887GA S.O.P. LXD)

This is a sheet metal enclosure that fits around the front portion of the 28E or 28H-TD unit when the unit is mounted in the 28G teletypewriter cabinet.

➤ The 28H transmitter distributor housing is the same as the 28E transmitter distributor housing.

28 TRANSMITTER DISTRIBUTOR UNITS
& ASSOCIATED EQUIPMENT

TRANSMITTER DISTRIBUTOR MOUNTING AND COVER ASSEMBLY

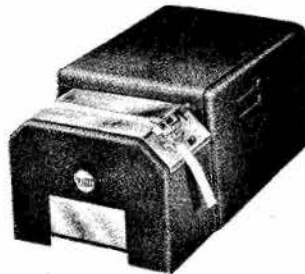

28G SELF-CONTAINED TRANSMITTER DISTRIBUTOR

28G45 Transmitter Distributor Mounting and Cover Assembly
(Teletype VCI210GA-LBxB800+LBXC201GA)

➤ This is an assembly used in conjunction with a 28G-TD unit and a 28A or 28B motor unit to provide a self-contained multicontact transmitter distributor.

The base structure is equipped with an intermediate gear assembly, and cushioned feet to permit setting the self-contained transmitter distributor on a table. It is arranged to mount a motor unit, a 28G-TD unit, and an optional D.C. rectifier (TP-162361) or Electrical motor control assembly (TP-152336 or TP-152351).

Other features include two 9 point terminal blocks, a cable assembly with a 36 terminal female connector which mates with the T.D. unit connector on one end and a 50 terminal output plug on the other end. The cable is wired for 5-8 level code. A ground wire is also wired into the slip connector. A 50 pin male plug which mates with the plug of the cable assembly and a 3 prong female power connector are provided for customers use. A line shunt switch, a power switch, current limiting resistors, a 4 ampere fuse and a 3 prong power connector are provided. The 28F-TD unit cannot be used with the self-contained transmitter distributor due to the difference in the cabling and connector arrangements.

Wiring is in accordance with BSP P34.321.

➤ NOTE: Early models of this assembly had a 32 terminal connector in place of the 50 terminal connector now provided.

28 TRANSMITTER DISTRIBUTOR UNITS
& ASSOCIATED EQUIPMENT

TRANSMITTER DISTRIBUTOR MOUNTING AND COVER ASSEMBLY

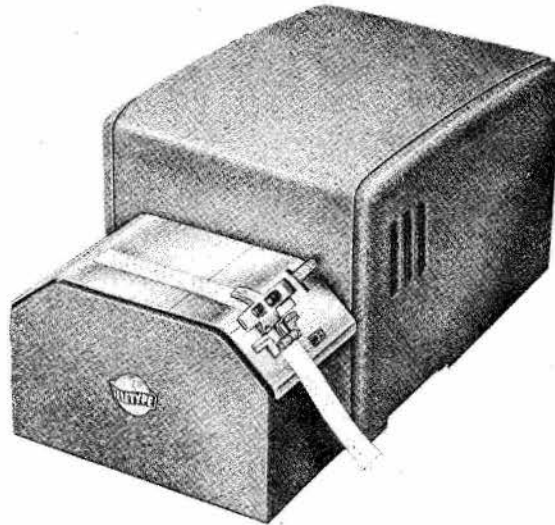

28H SELF-CONTAINED TRANSMITTER DISTRIBUTOR

28H45 Transmitter Distributor Mounting and Cover Assembly
(Teletype VCI211GA-LXD3+LXDC200GA)

This is an assembly used in conjunction with a 28H-TD unit and a 28A or 28B motor unit to provide a self-contained single contact transmitter distributor.

Sets of parts are available to convert initial 28E-TD units to the "plug-in" type. The initial 28E-TD units were used only with the model 28 ASR set and cannot be used for the self-contained application without converting them.

The base structure is equipped with an intermediate gear assembly, and cushioned feet to permit setting the self-contained Trans. Dist. on a table. It is arranged to mount the motor unit and a 28H-TD unit. Gear sets 28G, 28H, and 28J for 60, 75, and 100 WPM operation must be ordered separately.

Other features included are a 36 terminal female TD connector wired to two 9 point terminal blocks mounted at the rear, a line shunt contact that short circuits the line when the TD unit is removed, and a power switch.

Wiring is in accordance with BSP P34.321.

28 TRANSMITTER DISTRIBUTOR UNITS
& ASSOCIATED EQUIPMENT

TRANSMITTER DISTRIBUTOR MOUNTING AND COVER ASSEMBLY

➤ 28H1-45 Transmitter Distributor Mounting and Cover Assembly
(Teletype VCL290GA - LXDB5+LXDC200GA)

This assembly, designed for use with the 28H4 T.D. unit, is the 28H T.D. Mtg. & Cover Assembly equipped with a TP163317 Mod. Kit which provides wiring for use with parallel code reading contacts. Provision is made on the connector mounting plate for mounting a resistor when dc power is used for the clutch magnets.

END OF SECTION

28 TYPE DISTRIBUTORS

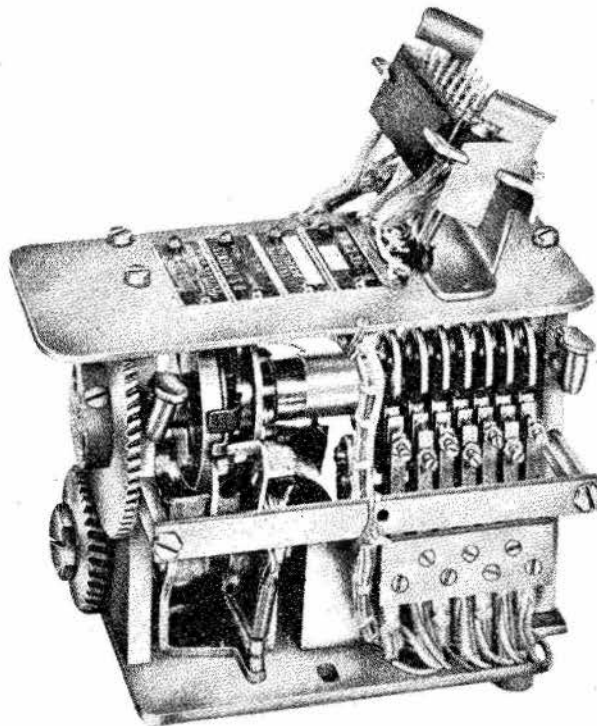

28A DISTRIBUTOR

GENERAL DESCRIPTION

The 28 type multicontact distributor is utilized to transmit one or more control characters such as transmitter start and call directing codes in selective calling systems or to translate parallel input signals into the sequential form required by the teletypewriter selector magnets. The control characters are set up externally by coding the distributor contacts. They are transmitted under external control such as pushbutton or teletypewriter stuntbox. Power to drive the distributor is provided by the motor of the apparatus upon which it is mounted.

The cam operated distributor contacts furnished on all units are five for the code elements and one for start and stop elements. The number of auxiliary contacts provided and their intended use depend on the code of the unit.

28 TYPE DISTRIBUTORS

The following modification kits are either provided as a standard part of the code or may be ordered separately to convert from one code to another.

1. TP-153921 Modification Kit - provides the necessary parts to mount a 28A or 28D distributor on a 28A, 28B or 28C teletypewriter base.
2. TP-159361 Modification Kit - provides the necessary parts to add terminal blocks containing terminals 81 to 120 on the left side wall of a 28B, 28C, 28D or 28E teletypewriter cabinet.
3. TP-173142 Modification Kit - provides the necessary parts to mount a 28A or 28D distributor on a 28D or 28E teletypewriter base.

For installation of Modification Kits, see Specification 5757S.

Wiring of all units is in accordance with BSP P34.303.

→ 28A Distributor (Teletype LD1) Manufacture Discontinued

This is a multicontact distributor designed for accepting 5 level code for distributing at speeds of 60 and 75 words per minute. It is intended to be mounted on a 28A sequence selector base. It may be converted to other codes for mounting on apparatus other than the 28A sequence selector base by providing the required modification kit. Conversion to a 28D distributor may be accomplished by changing the cam-sleeve assembly.

Additional features of this unit not included under the general description are two clutch trip magnets wired in series designed for operation at 0.120 ampere D.C., termination of the internal wiring of the distributor at a 20 terminal male connector and one auxiliary contact.

Dimensions of this distributor are 5 inches wide, 4 inches high and 4 inches deep.

→ 28A-1 Distributor (Teletype LD3) Manufacture Discontinued

This unit, designed for mounting on a 28 type teletypewriter base, is the same as the 28A distributor except that it is furnished with TP-153921, TP-159361 and TP-173142 Modification Kits.

28 TYPE DISTRIBUTORS

→ 28A-2 Distributor (Teletype LD5) Manufacture Discontinued

This is the same as the 28A distributor except it is furnished with mounting details and a TP-162602 Main Shaft assembly (TP-162594 Main Shaft with gear and bearing; TP-156544 Helical Gear 22T) to permit mounting on a 28E or 28H transmitter distributor base.

A TP-159361 Modification Kit for adding terminals 81 to 120 is provided.

The 28A-2 distributor is included is part of the 28E-2 Transmitter Distributor Base.

→ 28D Distributor (Teletype LD2) Manufacture Discontinued

This multiwire distributor, designed for operation at 100 words per minute, is the same as the 28A distributor except for a change in the cam-sleeve assembly.

→ 28D-1 Distributor (Teletype LD4) Manufacture Discontinued

This distributor is the same as the 28A-1 distributor except that it is designed for 100 words per minute operation. The difference consists of a change in the cam-sleeve assembly.

→ 28D-2 Distributor (Teletype LD6) Manufacture Discontinued

This distributor is the same as the 28A-2 distributor except that it is designed for 100 words per minute operation. The difference consists of a change in the cam-sleeve assembly.

28J Distributor (Teletype LD9)

This is a multicontact distributor designed for mounting on a 28 type teletypewriter base in a 28 Keyboard sending and receiving or receiving only set. It is designed for operation at 60, 75 or 100 words per minute.

The 28J distributor is similar to the distributor portion of the 28G transmitter distributor and contains the following features in addition to the features described in the general description:

1. Two auxiliary contacts
2. Provision for accepting 6, 7 and 8 level codes.

(28J Distributor cont'd on next page)

28 TYPE DISTRIBUTORS

28J Distributor (Teletype LD9) (Cont'd)

3. A clutch trip magnet, which may be externally controlled, operable on 120 volts AC or 48 to 120 volts DC (100 milliamperes) with appropriate dropping resistors.
4. A TP-161526 miniature 14 terminal female amphenol receptacle mounted on the unit.
- 5. A TP-173358 Mod. Kit to provide a 14 terminal male plug, a cable and terminal blocks for connecting the unit to the teletypewriter cabinet is furnished.
6. Mounting material for mounting on a teletypewriter base and a bearing and shaft to replace corresponding parts furnished with the teletypewriter base are provided.

Dimensions of this distributor are 5 inches wide, 6 inches high and 3 1/2 inches deep.

28J-1 Distributor (Teletype LD8)

This distributor is the same as the 28J distributor except that it is equipped with mounting material for mounting on a 28H transmitter distributor base instead of on a teletypewriter base. A drive shaft assembly is provided to replace the shaft in the 28H T.D. Base.

The 28J-1 distributor is furnished as part of the 28H-1 Transmitter Distributor Base.

28J-2 Distributor (Teletype LD10)

This distributor is the same as the 28J distributor except that it is designed for mounting on a 28 sequence selector base and does not contain the cable, terminal blocks and mounting material furnished with the 28J distributor.

→ 28J-3 Distributor

→ This distributor is the same as the 28J distributor except for the addition of four 420G diodes and two straps to the distributor's "C" terminal strip.

28 TYPE DISTRIBUTORS

28K Distributor (Teletype LD15)

This distributor, designed for use on a 28A or 28B mounting and cover assembly, accepts 5 level teletypewriter code. Operation is at 60, 75 or 100 words per minute through use of 28G, 28H or 28J Set of Gears, respectively.

Features of this distributor include two auxiliary contacts, a clutch trip magnet operable on 120V A.C. or 120 or 48V D.C. (100 milliamperes) through use of dropping resistors, and the termination of wiring through a cable at a miniature 14 terminal amphenol receptacle which mounts in the 28A mounting and cover assembly.

➤ 28L Distributor (Teletype LD16)

➤ This distributor, designed for use with the Automatic Intertoll Trunk Test Frame, is the same as the 28J distributor except for the timing of the auxiliary contacts. Aux. A contact opens during the start pulse and closes during the stop pulse while Aux. B closes during the start pulse and opens during the stop pulse with a small delay after the Aux. A contact.

END OF SECTION

28 PERFORATOR TRANSMITTER BASES

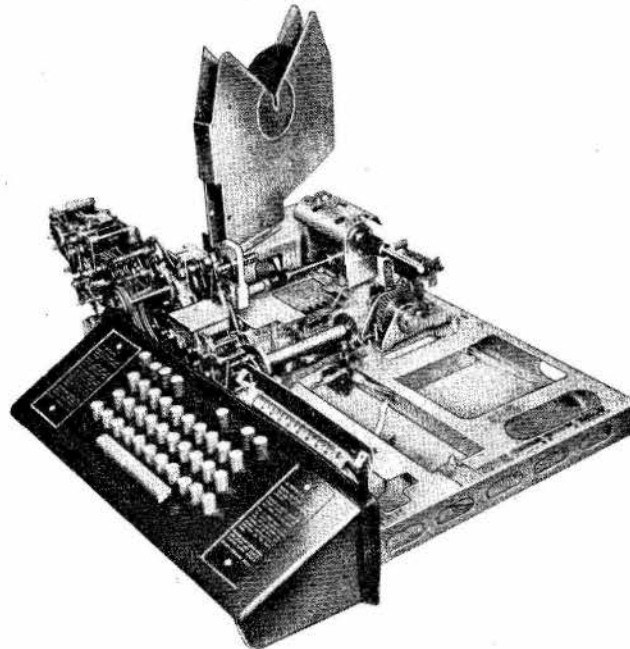

GENERAL DESCRIPTION

The perforator transmitter base is a frame on which the typing unit, keyboard, perforator, tape container and motor unit are mounted, and includes the following features:

- 1) Base - A reinforced sheet-metal box from on which the various parts are mounted.
- 2) Motor Drive - An intermediate gear assembly which drives the typing unit and signal generator. The motor unit, which is mounted on the base, must be ordered separately.
- 3) Keyboard Assembly - An assembly similar to the 28 send-receive keyboard except equipped with a clutch tripbar which permits disabling the signal generator clutch trip feature, serves as a

(Description cont'd on next page)

GENERAL DESCRIPTION

- reset link for the codebar reset bail in the tape position, and permits interconnection to trip the perforator clutch. Also included are the red keytops shown in section 23 and the features activated by them, the repeat space feature and two codebars to operate the character counter. Type arrangement "C" with the addition of a blank key top is furnished as standard unless otherwise specified in description. Other type arrangements may be furnished by equipping with modification kits listed in section 23C.
- 4) Signal Generator - The same as furnished on the send receive keyboard except designed to take a greater mechanical load.
 - 5) Reset Cam - follower Bracket Assembly - An assembly which provides the linkage between the clutch tripbar and the perforator cam assembly in the tape position to permit the keyboard to be reset at high speeds by the tape perforator.
 - 6) Codebar Extension Bracket Assembly - This assembly is mounted between the keyboard assembly and the perforator. It transmits the character information from the keyboard codebars to the perforator, functions in providing the three modes of operation of the perforator-transmitter-base, drives the auxiliary electric switch, and when a selector is used on the perforator, an additional lever operated by the control cam provides the motion for stripping the last selection stored in the selector when switching from K to K-T or T position.
 - 7) Tape Perforator - The tape perforator, according to customer choice, is a basic 28 typing or nontyping perforator, or a typing or nontyping reperforator modified for ASR mounting and use.
 - 8) Tape Container Assembly - The tape container has a capacity of 1000 feet of tape and is mounted on a heavy bracket welded to the base.
 - 9) Gearing and Shafting - Power is supplied to the various mechanisms of the perforator-transmitter-base and the associated transmitter-distributor by means of shafting, flexible rubber couplings, and gearing.
 - 10) Character Counter - the character counter is mounted on the right front of the base and is visible through a window in the cabinet. It is operated by codebars in the keyboard assembly and will step one scale division for any character plus space when the ASR is being operated in the T or K-T positions and will be reset when the CR key is depressed. In the T position the counter operates a switch which in turn operates an end-of-line indicating lamp. A margin indicating switch is also provided.

GENERAL DESCRIPTION (Cont'd)

- 11) Auxiliary Electric Switch and Control - This switch is located under the tape container assembly and consists of a multiple circuit switch contained in a housing which acts as an electrostatic shield as well as a dust shield. The standard switch is a 4-pole, 3-position switch and controls the electrical connections for keyboard, keyboard & tape, and tape only operations.
- 12) Electrical Tape Back Space Mechanism.
- ➔ 13) Lock Bar Switch - this switch is utilized to shunt the signal generator, operate the slow release relay in the 28G Electrical Service Unit, and shut off the transmitter distributor. Operation of the switch is either manually from the keyboard or remotely by the page printer through a modified lockbar in the keyboard.

All electrical wiring for the perforator-transmitter-base is brought in through a receptacle mounted at the rear center of the base. The various electrical components are inter-connected with this receptacle by a main cable, and an auxiliary cable is used between the auxiliary electric switch and a terminal board provided on the metal frame of the perforator-transmitter-base.

28A Perforator Transmitter Base (Teletype VCL202-LAK2BRJ+LPE2)

This is a perforator transmitter base designed for use with the 82B1 Switching System. Included on this base is a non-typing perforator.

The keytops are Arrangement A except that the zero on upper case "P", has the diagonal stroke. (Ø) (TP155700 set of Keytops)

The tape keyboard key is arranged to operate normally in the "Tape" or "keyboard tape" positions but with provision for operation in the "keyboard" position during routining and testing. Normally, however, the key is arranged so that it will not readily shift to the "keyboard" position.

- ➔ In addition to the features included in the general description, this base is equipped with a set of code reading contacts operated by the punch selection fingers plus an auxiliary timing contact and a low tape switch assembly mounted in the tape reel. Not included with this base are the repeat space feature, the lock bar switch, and the send, receive and break keytops.

Wiring of this unit is in accordance with B127106 or WD3261.

➔ 28B Perforator Transmitter Base (Teletype VCL203-LAK4ARP+LPE1)

This base is equipped with a non-typing perforator and contains the features included in the general description.

The perforator operates at line speed in the keyboard-tape position, at a maximum of 150 words per minute in the tape position, and does not operate in the keyboard position.

28C Perforator Transmitter Base (NEVER MANUFACTURED)

Designed for use in the TTY Dataphone system. Never manufactured.

28D Perforator Transmitter Base (Teletype VCL204-LAK4ARP+LPR33ARC)

This base is equipped with a typing reperforator and contains the features included in the general description. In addition, the typing reperforator provides chadless tape, has a bell on upper case "S" contact, unshift-on-space feature with a means for disabling it and a 36 point plug. Included with the base are a matching 36 point connector and cabling for connection to the cabinet terminal blocks.

The typing reperforator operates at line speed in the keyboard and keyboard-tape positions and at a maximum speed of 115 words per minute in the tape position.

28E Perforator Transmitter Base (Teletype VCL205-LAK4ARP+LTPE3ARC)

This base is equipped with a typing perforator and contains the features included in the general description. The typing perforator provides chadless tape, has unshift-on-space feature with a means for disabling it and a tape feed disabling device.

Operation of the typing perforator is at line speed in the keyboard-tape position and at a maximum of 115 words per minute in the tape position. It does not operate in the keyboard position.

28F Perforator Transmitter Base (Teletype VCL206-LAK4ARP+LRPE6)

➔ This base is equipped with a non-typing reperforator and contains the features included in the general description. In addition, the non-typing reperforator provides chadless tape and has a 36 point female connector which mates with a connector and cable assembly furnished with the base. An "S" signal bell contact is not provided.

➔ 28F Perforator Transmitter Base (Teletype VCL206-LAK4ARP+LRPE6) (Cont'd)

The non-typing reperforator operates at line speed in the keyboard and keyboard-tape position and at a maximum speed of 150 words per minute in the tape position.

28G Perforator Transmitter Base (Teletype VCL207-LAK10ARC+LPE3)

This base is equipped with a non-typing perforator and contains the features included in the general description except for the omission of the blank keytop in the keyboard and the arrangement of the auxiliary switch for switching to the tape and keyboard-tape positions only. Operation to the keyboard position may be accomplished during "routining" and testing". The auxiliary switch is equipped with a set of contacts arranged to provide a make-before-break transfer, normally closed in the keyboard-tape position and operated in the tape position.

The non-typing perforator is equipped with a set of code reading transfer type contacts used as a single "make", an "auxiliary" contact used as a break before make, a 20 point male connector and a matching connector and cable assembly. Operation of the non-typing perforator as at line speed in the keyboard-tape position and at a maximum of 150 words per minute in the tape position. It provides chadless tape.

28G-1 Perforator Transmitter Base (Teletype VCL224-LAK10ARC+LTPE4ARC)

This base, designed for use in the 81D1 System, is the same as the 28G P.T. Base except that it is equipped with a typing perforator instead of a non-typing perforator. Features are the same except for the addition of unshift-on-space with a means for disabling it, the reduction of the maximum speed to 115 words per minute in the tape position, and the omission of the 20 point male connector and matching connector and cable assembly.

28H Perforator Transmitter Base (Teletype VCL255-LAK27BRX+LPE4)

This base, designed for use in the Boeing Line Switching System, contains the following features in addition to those included in the general description.

- 1) A non-typing perforator equipped with its' own motor and motor terminal block.
 - 2) Keyboard arrangement modified by a Maltese Cross on U.C. "C" and a red "Here Is" key for answerback trip off.
- ➔

(28H P.T.B. Cont'd on next page)

28H Perforator Transmitter Base (Teletype VCL255-LAK27BRX+LPE4) (Cont'd)

- 3) Magnetically controlled gear shift energized for 60 wpm and de-energized for 100 wpm. (No provision for 75 wpm)
- 4) The control wafer switch has a contact on the "T" position to operate the perforator motor and cabinet lamps.
- 5) Solenoid to permit remote operation of the form feed out mechanism.
- 6) Pinion gear for motor is included.
- 7) Pulsing Keyboard Contacts are provided.
- 8) A nine position motor terminal block and a spark suppressor network in place of the four position block normally furnished.

This base requires the use of a 28A motor unit instead of the 28C.

➔ 28J Perforator Transmitter Base

This base, designed for use in TWX when the answerback feature is required, is a 28B perforator transmitter base modified to provide the following features in addition to those on the 28B.

- 1) Keyboard arrangement modified by "WRU" on U.C. "C", blank on U.C. "N" and a red "Here Is" key and contact assembly.
- 2) A non-contention feature relay for answerback.
- 3) A local Paper Feedout Motor Start Mechanism (TP154147).

28J-1 Perforator Transmitter Base

This base, designed for use in TWX when the answerback feature is not required, is a 28B perforator transmitter base modified to provide the following features in addition to those on the 28B.

- 1) Keyboard arrangement modified by "WRU" on U.C. "C" and blank on U.S. "N".
- ➔ 2) A local Paper Feedout Motor Start Mechanism (TP154147)

➤ 28K Perforator Transmitter Base (Teletype VCL285-LAK4ARP+LPR56BRM)

This base is similar to the 28D Perforator Transmitter Base except that the typing reperforator produces fully perforated tape with printing between the feed holes and a means for suppressing printing when required.

➤ Included with the base is a TP170306 Modification Kit which provides chad chute parts. A TP195391GA Modification Kit to provide a chad container and disposal for the 28ASR Cabinet must be ordered separately.

28LA Perforator Transmitter Base (Teletype VCL235-LAK20BRV+LARP801)

This base, designed for use in the sending set of a line switching system, consists of a keyboard base and a multimagnet reperforator. It mounts in the 28LA Teletypewriter Cabinet.

Features of this unit include:

- 1) Keytop arrangement "A".
- 2) Keytops for local line feed, start of message, end of message, end of address, feed out, rub out, tape backspace, repeat, local carriage return, local area, distant area, pseudomnemonic, and call directing code.
- 3) Power back space.
- 4) Fully perforated, 8-level, 1 inch wide tape.
- 5) Rub out
- 6) Parallel output
- 7) Code Reading and Auxiliary Keyboard Contacts
- 8) Letters and Figures Code Bars and Contacts.
- 9) Special tape container for 1 inch wide tape.

Wiring is in accordance with BSP P34.307.

END OF SECTION

28 REPERFORATOR TRANSMITTER UNIT
& ASSOCIATED EQUIPMENT

REPERFORATOR TRANSMITTER UNITS

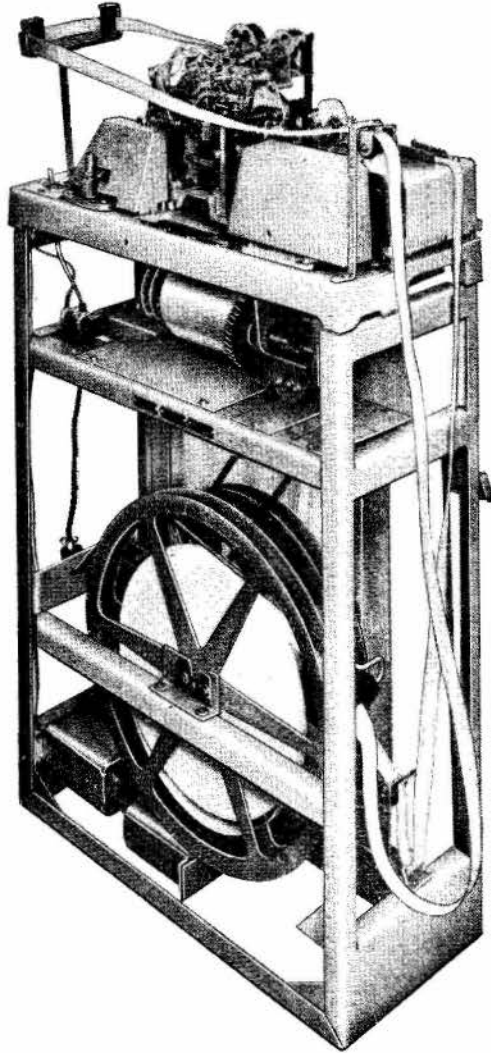

Reperforator Transmitter Unit Mounted on Stand

Note - Type Arrangement "C" modified by a diamond on upper case H
is furnished unless otherwise specified.

➔ 28A REPERFORATOR TRANSMITTER UNIT (Teletype VCL212-LRXB1+LPR3AWA+LAXD2+LMU11)

This unit consists of a casting on which is mounted a typing reperforator, a pivoted head multicontact transmitter distributor, a motor, drive gears, two 2 point recepticals, a 3 prong power plug, a tape winder drive, a 4 point terminal block, an on-off switch, and various tape guides and mounting equipment.

The typing reperforator is equipped with code-reading contacts, auxiliary and universal contacts a 4 point alarm connector, a 32 point reperforator connector and a typewheel providing type arrangement A modified by a slash through zero. A gear shift provides speeds of 60, 75 and 100 words per minute as required.

The transmitter distributor is a pivoted head multicontact type with a climbing head to read the last character punched. Features include a single distributor auxiliary contact, a transmitter auxiliary contact, a transmitter stop switch and a 32 point transmitter distributor connector. Operation is at 200 words per minute for crossoffice service.

Dimensions of this unit including the tape handling stand are 36 inches high, 8-1/2 inches wide and 20 inches deep.

28B REPERFORATOR TRANSMITTER UNIT (Teletype VCL214-LRXB2+LRPE2+LAXD2+LMU11)

This unit is the same as the 28A Reperforator Transmitter Unit except for the replacement of the typing reperforator with a non-typing reperforator and its design for use at 200 words per minute only for cross office sending and receiving.

28C REPERFORATOR TRANSMITTER UNIT (Teletype VCL215-LRXB3+LRPE2+LAXD1+LMU11)

This unit is the same as the 28A Reperforator Transmitters Unit except for the replacement of the typing reperforator with a non-typing reperforator and its design for receiving at 200 words per minute and sending over the transmitter distribution at a speed of 60, 75 or 100 words per minute. The transmitter distributor has an additional distributor auxiliary contact.

28D REPERFORATOR TRANSMITTER UNIT (Teletype VCL213-LRXB12+LPR25ARC+LAXD1+LMU11)

This unit is similar to the 28A Reperforator Transmitter Unit except that a gear shift is provided for both the typing reperforator and the transmitter distributor to allow 60, 75 or 100 word per minute operation and typewheel arrangement "C" is provided in place of "A". In addition, the typing reperforator is equipped with manual interfering letters feed out, "unshift-on-space feature with a means for disabling it, and connectors to the 32 terminal reperforator connector through 36 terminal connections. The transmitter distributor has an additional distribution auxiliary contact.

28D-1 REPERFORATOR TRANSMITTER UNIT (Teletype VCL217-LRXB12+LPR25ARM+LAXD1+LMU11)

This unit is the same as the 28D reperforator transmitter unit except for the typewheel on the typing reperforator. Type arrangement "D" is furnished with symbols for C.R., L.F., LTRS, FIGS, and Bell and the following changes:

-	on upper case	A
X	" " "	C
\$	" " "	D
&	" " "	G
diamond	" " "	H
"	" " "	Z
}}	" " & lower case blank (Crucible Steel)	

28D-2 REPERFORATOR TRANSMITTER UNIT (Teletype VCL220-LRXB12+LPR25AWA+LAXD1+LMU11)

This unit is the same as the 28D reperforator transmitter unit except that type arrangement A, modified with a slash through zero (Ø) on upper case P, instead of type arrangement C is provided. (Northeast Airlines).

28D-3 REPERFORATOR TRANSMITTER UNIT (Teletype VCL222-LRXB12+LPR25AWS+LAXD1+LMU11)

This unit is the same as the 28D reperforator transmitter unit except for the typewheel on the typing reperforator. Type arrangement "A" modified as follows is furnished instead of type arrangement C.

Comma	on upper cases	J
Apostrophe	" " "	F
&	" " "	M
%	" " "	B
Degree Sign	" " "	V
Asterisk	" " "	C
Blank	" " "	G (Alcoa)

28D-4 REPERFORATOR TRANSMITTER UNIT (Teletype VCL223-LRXB12+LPR25AWX+LAXD1+LMU11)

This unit is the same as the 28D reperforator transmitter unit except that type arrangement "C" is modified as follows:

28D-4 REPERFORATOR TRANSMITTER UNIT (Cont'd)

Blank	on upper case	B
#	" " "	C
↓	" " "	H
ç	" " "	J
Blank	" " "	N
Blank	" " "	V (Swift Packing Co.)

28D-5 REPERFORATOR TRANSMITTER UNIT - Cancelled Code

28D-6 REPERFORATOR TRANSMITTER UNIT (Teletype VCL261-LRXB12+LPR25ARJ+LAXD1+LMU11)

This unit is the same as the 28D reperforator transmitter unit except that type arrangement "C" is modified by a number sign (#) on U.C. "H" (Western Electric, Hawthorne).

28E REPERFORATOR TRANSMITTER UNIT (Teletype VCL216-LRXB12+LPR25ARC+LAXD1+LMU13)

This unit is similar to the 28D reperforator transmitter unit except that the unit is driven by a governed motor (28D) and type arrangement "A", modified by a slash through O (Ø) on upper case P, is furnished instead of type arrangement C.

28F REPERFORATOR TRANSMITTER UNIT (Teletype VCL218-LRXB14+LPR25ART+LAXD1+LMU12) ←

This is a typing reperforator transmitter designed to be housed in a 100 type cabinet for use in the 81D1 switching system. It is similar to the 28D reperforator transmitter unit except that the two 2 point recepticals, the four point alarm connector, the 3 point power plug, the tape winder drive and the 4 point terminal block are eliminated and the following features are added: ←
←
←

- 1) Type arrangement "B" modified as follows is provided instead of type arrangement C on the typing reperforator:

Symbols for C.R., L.R., LTRS, FIGS, & BELL

⊕	on upper case	B
○	" " "	C
⊙	" " "	V
⊖	" " "	N
+	" " "	Z
§	" " "	& lower case blank (American Airlines)

(28F R.T.U. Cont'd on next page)

28F REPERFORATOR TRANSMITTER UNIT (Teletype VCL218-LRXB14+LPR25ART+LAXD1+LMU12)
(Cont'd)

- 2) TP152950 rectifier is furnished to provide D.C. current for line relay.
- 3) A reperforator transmitter stand is not required.
- 4) A 6 point terminal block is provided.
- 5) Dimensions are 15" wide by 15-1/2" deep.

28F-1 REPERFORATOR TRANSMITTER UNIT (Teletype VCL226-LRXB14+LPR25ARJ+LAXD1+LMU12)

This unit is the same as the 28F reperforator transmitter unit except that type arrangement "C", modified with # on upper case H, is provided instead of modified type arrangement B (DuPont)

28F-2 REPERFORATOR TRANSMITTER UNIT (Teletype VCL230-LRXB14+LPR25AXD+LAXD1+LMU12)

This unit is the same as the 28F reperforator transmitter unit except that type arrangement D modified as follows is substituted for modified type arrangement B:

Symbols for C.R., L.F., LTRS & FIGS.

-	on upper case	A
&	" " "	G
'	" " "	J
,	" " "	N
#	" " "	C
English Pound Symbol	" " "	H
BELL	" " "	S
"	" " "	Z
}}	" " "	Blank (Republic Steel)

28G REPERFORATOR TRANSMITTER UNIT (Teletype VCL234-LRXB22+LRPE11+LAXD1+LMU11)

This unit is designed for use in a 114B Apparatus Cabinet when an Automatic Address feature is requested for the 81D1 Switching System. It is similar to the 28D Reperforator Transmitter Unit except that it contains a non-typing reperforator, a tape supply container, and four supporting legs that fit into locating holes in the apparatus cabinet.

Western Electric Company, Inc.
Service Division
Distribution Engineering

Specification RS-581.0
Section 23P
Page 6
10-28-64
Replacing Page 6 dated 11-22-61

28 REPERFORATOR TRANSMITTER UNIT
& ASSOCIATED EQUIPMENT

REPERFORATOR TRANSMITTER STAND

28A45 REPERFORATOR TRANSMITTER STAND (Teletype LTHS210GA)

This is an angular bracket type stand for mounting a 28 type reperforator transmitter unit and includes a tape supply reel of 3000 feet capacity, low-tape-supply contacts, a tape winder of 1000 feet capacity, two motor power-factor correction capacitors, and a tape storage bin.

The power factor correction capacitors and tape supply contacts are brought out to separable connectors which mate with connectors on the reperforator transmitter units.

28 REPERFORATOR TRANSMITTER UNIT
& ASSOCIATED EQUIPMENT

REFERFORATOR TRANSMITTER SETS

A 28 type reperforator transmitter set consists of a 28 reperforator transmitter unit and a 28A reperforator transmitter stand. They are given the same code as the unit. Following is a list of the reperforator transmitter sets now coded.

28A45	Reperforator Transmitter Set		
28B45	"	"	"
28C45	"	"	"
28D45	"	"	"
28D-1 45	"	"	"
28D-2 45	"	"	"
28D-3 45	"	"	"
28D-4 45	"	"	"
28D-5 45	"	"	" (Cancelled)
28D-6 45	"	"	"
28E45	"	"	"



28 REPERFORATOR TRANSMITTER UNIT
& ASSOCIATED EQUIPMENT

REPERFORATOR TRANSMITTER ADAPTER UNITS

28A REPERFORATOR TRANSMITTER ADAPTER UNIT (Teletype TP172633 Adapter)

This is a unit designed to provide the features necessary to adapt a 28D and other reperforator transmitter sets having transfer punch reading contacts for use in the 81D1 Switching System. It mounts on the shelf of the 28B apparatus cabinet below the hinged door. The unit is a sheet metal chassis measuring 9" x 9" and contains the following features:

- 1) A terminal strip to provide strapping options for use in either an incoming or outgoing line position.
- 2) Six 295A dry reed relays to provide a substitute for the pullbar contacts on a 14 type reperforator transmitter
- 3) Twenty-one 303F or F-54066 mercury relays to provide a substitute for the maze on a 14 type reperforator transmitter
- 4) Two 303F or F-54066 mercury relays to provide a circuitry for tape-out and universal contact functions.
- 5) Four flexible cords terminating in two Amphenol and two Jones connectors to facilitate removal of the Adapter from the cabinet.

This adapter is included in the 28B apparatus cabinet. It is furnished with the 295A dry reed relays but the 303F or F54066 mercury relays must be ordered separately.

28B REPERFORATOR TRANSMITTER ADAPTER UNIT (Teletype TP176449 Adapter)

This unit was designed for use in a 100 type cabinet to provide features necessary to adapt a 28F reperforator transmitter unit for use in the 81D1 Switching System. The features are the same as the 28A adapter except for the addition of a TP172960 line relay mounting fastened to one end of the chasis to mount a 255A line relay. The 255A relay and 303F or F-54066 mercury relays must be ordered separately.

END OF SECTION

28 APPARATUS CABINETS
& ASSOCIATED EQUIPMENT

APPARATUS CABINETS

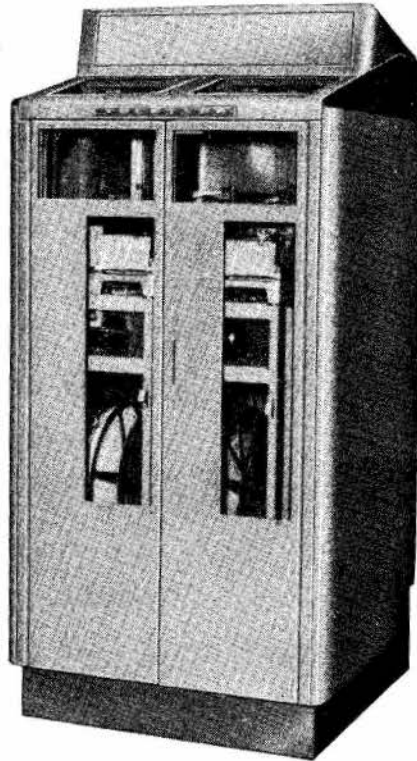

GENERAL DESCRIPTION - The 28 type apparatus cabinets are made of sheet metal and designed to accommodate a variety of 28 type equipment and their associated circuitry for use in teletypewriter switching systems. Noise reduction is accomplished by mounting equipment on inner framework which makes contact with the outer shell at floor level. The top of the cabinet varies in design depending on the units to be housed and the cabinet is equipped with both rear and front doors. End panels must be ordered separately and are to be mounted on the two outer ends when a bank of cabinets are used. A raceway is provided at the bottom rear of the cabinet to keep cabling off the floor. A junction box containing two 3 wire AC convenience outlets, a fuse box with a capacity of four fuses, a hinged relay rack to hold the electrical components, and two 120 point terminal connections are provided.

28A45 Apparatus Cabinet (Teletype LBAC212GA)

This cabinet is designed to house two 28 type reperforator transmitter units and their associated circuitry side by side on separate pull out shelves. A hinged hood with a blank control panel is mounted on the top of the cabinet and the two doors on the front of the cabinet are equipped with plastic panels. This cabinet measures 60 inches high, 25 1/2 inches wide, and 26 1/4 inches deep.

28A-1 45 Apparatus Cabinet (Teletype LBAC215GA)

This cabinet is similar to the 28A apparatus cabinet except it is used to house a multiple reperforator base upon which are mounted three 28 type Receiving Only Typing Reperforators. Room is provided for three gang mounted tape winders on a common sliding shelf. Dimensions of the cabinet are 56 inches high, 25 1/2 inches wide, and 26 1/4 inches deep.

28A-2 45 Apparatus Cabinet (Teletype LBAC216GA)

This cabinet is simialr to the 28A apparatus cabinet except it is designed to house two 28 type multiple typing reperforator bases upon which are mounted six 28 type Receiving Only Typing Reperforators. A tape bin is mounted on the outside of the front doors in a way which allows the doors to be opened. The front doors do not have clear plastic inserts.

28A-3 45 Apparatus Cabinet (Teletype LBAC217GA)

This cabinet is designed to house of multiple transmitter distributor base accomodating three 28 type transmitter distributors and a multiple typing reperforator base mounting three 28 type typing reperforator units. A tape bin is provided for holding tapes before and after transmission.

28A-4 45 Apparatus Cabinet (Teletype LBAC218GA)

This cabinet is similar to the 28A-3 apparatus cabinet except that it is designed to accomodate a three gang tape winder in addition to the transmitter distributors and typing reperforators.

28A-5 45 Apparatus Cabinet (Teletype LBAC219GA)

This cabinet is the same as the 28A-3 apparatus cabinet except it is arranged to house six transmitter-distributors mounted three each on two multiple transmitter-distributor bases.

28B45 Apparatus Cabinet (Teletype LBAC220GA)

This cabinet is primarily intended for use in the 81D1 teletypewriter system. It is similar to the 28A apparatus cabinet except for the following additional features.

- (a) One TP162361 (500 ma) rectifier to supply direct current for the line relays.
- (b) Mountings for two line relays on the hinged panel inside the cabinet.
- (c) Two 28A reperforator-transmitter adapter units and their mountings.
- (d) Wiring and special apparatus features required for the 81D1 system.
- (e) The hinged hood on the top of the cabinet contains lamps, keys and special control features required for the 81D1 teletypewriter switching system.
- (f) Tape storage bin illumination.
- (g) Twenty-three 303H or F54066 mercury relays and two 255A line relays required in this cabinet must be ordered separately.

➤ 28LA45 Apparatus Cabinet (Teletype LBAC227GA)

This cabinet, designed for use in a Line Switching System, is a three tier cabinet which mounts three receiving-only typing units. It is 21 1/2 inches wide, 28 inches deep and 72 inches high. Features of this unit are the following:

1. A key and lamp panel.
2. Local carriage return and local line feed keys for each typing unit.
3. 6 volt copylights.
4. Ball bearing slides to pull the printers forward.
5. A glass access door for each typing unit.
6. Provision for mounting 28LC-1 and 28LD-1 electrical service units.

➤ Wiring is in accordance with BSP P34.354.

28A-5 45 Apparatus Cabinet (Teletype LBAC219GA)

This cabinet is the same as the 28A-3 apparatus cabinet except it is arranged to house six transmitter-distributors mounted three each on two multiple transmitter-distributor bases.

28B45 Apparatus Cabinet (Teletype LBAC220GA)

This cabinet is primarily intended for use in the 81D1 teletypewriter system. It is similar to the 28A apparatus cabinet except for the following additional features.

- (a) One TP162361 (500 ma) rectifier to supply direct current for the line relays.
- (b) Mountings for two line relays on the hinged panel inside the cabinet.
- (c) Two 28A reperforator-transmitter adapter units and their mountings.
- (d) Wiring and special apparatus features required for the 81D1 system.
- (e) The hinged hood on the top of the cabinet contains lamps, keys and special control features required for the 81D1 teletypewriter switching system.
- (f) Tape storage bin illumination.
- (g) Twenty-three 303H or F54066 mercury relays and two 255A line relays required in this cabinet must be ordered separately.

28 APPARATUS CABINETS
& ASSOCIATED EQUIPMENT

APPARATUS CABINET END PANELS

28A45 APPARATUS CABINET END PANEL (Teletype TP164091GA)

This code includes the apparatus cabinet right side end panel and the right side end plate for the cable duct.

28B45 APPARATUS CABINET END PANEL (Teletype TP164092GA)

This code includes the apparatus cabinet left side end panel and the left side end plate for the cable duct.

28 APPARATUS CABINETS
& ASSOCIATED EQUIPMENT

CABLE TURNING SECTION

28A45 Cable Turning Section (Teletype LBAC221GA)

This is a section for use in conjunction with 28B apparatus cabinets in the 81D1 Switching systems. Features of the section are a shelf for storing 3000 foot rolls of perforator tape and a hinged door to provide access to the storage space. Dimensions are 18" wide, 50" high, and 26" deep. End panels must be ordered separately as for the apparatus cabinets.

END OF SECTION

28 TAPE TYPING UNITS
& ASSOCIATED EQUIPMENT

28 TAPE TYPING UNIT

28LA Tape Typing Unit (Teletype LTPLARA)

This unit is similar to a 28 type typing reperforator unit without a perforating mechanism. It mounts on a 28LA tape teletypewriter base and is intended for use in the No. 2 Serviceboard in conjunction with a Line Switching System. Features are as follows:

1. Unshift on letters
2. Selector Mechanism
3. Typewheel printer with type arrangement "A"
4. 3/8 inch wide tape with printing in center of tape.
5. Function bars for figures, letters, and figures S with space available for a fourth optional function bar.
6. Friction type feed wheel.

Dimensions of this unit are 9 1/2 inches wide, 6 1/2 inches deep and 8 inches high.

Wiring is in accordance with BSP P34.355.

28LA-1 Tape Typing Unit (Teletype LTP2AZG)

This unit is similar to the 28LA tape typing unit except that it is equipped with the additional feature of "unshift on Space" with a means for disabling it and has a typewheel with type arrangement "C" modified by a Maltese cross on U.C. "C" and an open diamond on U.C. "H" instead of type arrangement "A".

➔ 28LB Tape Typing Unit

This unit, designed for use in the C1 Alarm and Control System, is similar to a 28 type typing reperforator unit without a perforating mechanism. Features include that the unit shall remain permanently in the letter modes and be equipped with a selector mechanism, a TP173443 Remote Control Non-interfering Feedout, a TP174475 Print Suppressor, a friction type feed wheel and a typewheel for printing characters 0 through 9, Space, S,C,A and dash. Printing is in the center of 3/8 inch wide tape.



28 TAPE TYPING UNITS
& ASSOCIATED EQUIPMENT

28 TAPE TELETYPEWRITER BASES

28LA Tape Teletypewriter Base (Teletype LTPK1BRV)

This is a sending and receiving base designed to mount a 28LA Tape Typing Unit. It has self-contained shock mounts and mounts directly to the framework of the No. 2 Serviceboard for a Line Switching System. The base is equipped with a 28 type keyboard and requires the use of a 28A motor. Features are as follows:

1. Repeat key
2. Keyboard lock and unlock keys
3. Line Break Key
4. Speed changer to provide 60, 75 or 100 wpm with a control knob on the keyboard.
5. Motor on-off switch
6. Tape supply reel with low tape contact
7. End of line and low tape indicator lights
8. Character counter
9. Copy light transformer
10. Pull-out handle to remove base from serviceboard.
11. Nine position terminal block arranged to provide half or full duplex operation.
12. Signal Generator
13. Keytop arrangement "A"

Wiring is in accordance with BSP P34.355.

28LB Tape Teletypewriter Base (Teletype LTPK2BRX)

This is a sending and receiving base designed to mount a 28LA-1 Tape Typing Unit. It has self-contained shock mounts and mounts directly to the framework of the No. 6A serviceboard.

This base is similar to the 28LA Tape Teletypewriter Base except for the following:

1. Designed for 48V D.C. operation.
2. Elimination of 3-speed changer and copylight transformer.

(28LB Tape T.B. Cont'd on next page)

28 TAPE TYPING UNITS
& ASSOCIATED EQUIPMENT

28 TAPE TELETYPEWRITER BASES

28LB Tape Teletypewriter Base (Teletype LTPK2BRX) (Cont'd)

3. Manual speed change is provided.
4. Keytop arrangement "C" modified by "WRU" on U.C. "C" and a blank keytop is provided in place of Keytop Arrangement "A".
5. Equipped with TP-178306 motor control relay coupled with 600 ohm current limiting resistor in series.
6. R-C protection of motor control contacts for 48V D.C. operation is provided.
7. Equipped with 185A Network across motor control winding.
8. Requires a 28E motor instead of a 28A for 48V D.C. operation.

28LC Tape Typing Base (Teletype LTPK3BRX)

This is a sending and receiving base designed to mount a 28LA-1 Tape Typing Unit. It has self-contained shock mounts and mounts directly to the framework of the No. 6A serviceboard.

This base is similar to the 28LA Tape Teletypewriter Base except for the following:

1. Elimination of 3 speed changer.
2. Manual speed changer is provided.
3. Keytop arrangement "C" modified by "WRU" on U.C. "C" and a blank keytop is provided in place of Keytop Arrangement "A".
4. Equipped with TP-178306 motor control relay coupled with 600 ohm current limiting resistor in series.
5. Equipped with 185A Network across motor control winding.
6. Requires a 28C motor instead of a 28A.

28 TAPE TYPING UNITS
& ASSOCIATED EQUIPMENT

28 TAPE TELETYPEWRITER COVER

28LA45 Tape Teletypewriter Cover (Teletype LSRC201GA)

This cover is used in conjunction with a 28LA Tape Teletypewriter Base and 28LA Tape Typing Unit or a 28LB Tape Teletypewriter Base and 28LA-1 Tape Typing Unit. Features of this cover are a copy light, a character counter light and a front access door for changing ribbon and tape. Dimensions are 17 inches wide, 19 inches deep and 10 inches high.

28LB45 Tape Teletypewriter Cover (Teletype LSRC202GA)

This cover is used in conjunction with a 28B Tape Teletypewriter Base and a 28LA-1 Tape Typing Unit. It is similar to the 28LA except that the copylight and character counter light are designed for operation on 48V D.C.

END OF SECTION

28 TYPE RECEIVING SELECTOR &
28 TYPE MOUNTING & COVER ASSEMBLY

28 TYPE RECEIVING SELECTOR

28A Receiving Selector (Teletype LRS2)

This selector, designed for mounting on a 28A Mounting and Cover Assembly, is utilized to convert a 5 level sequential teletypewriter signal into an equivalent parallel output.

Features of this unit include the following:

1. A receiving selector for accepting serial teletypewriter signals.
2. Transfer type code reading contacts with two auxiliary contacts for parallel readout.
3. Termination of internal wiring through a cable at a 36 terminal Amphenol Receptacle which is to be mounted on the 28A Mounting and Cover Assembly.
4. Provision for operation at 60, 75 and 100 words per minute through use of 28G, 28H and 28J Motor to intermediate sets of gears respectively.

28 TYPE RECEIVING SELECTOR &
28 TYPE MOUNTING & COVER ASSEMBLY

28 TYPE MOUNTING & COVER ASSEMBLY

28A45 Mounting & Cover Assembly (Teletype LRSB201GA)

This is a base, cover and motor assembly designed for use in conjunction with a 28A Receiving Selector or 28K Distributor to convert a 5 level serial teletypewriter signal to an equivalent parallel output or a 5 level parallel input to an equivalent sequential teletypewriter output respectively.

Features of this unit include the following:

1. On-Off power switch with an indicator lamp.
2. An Intermediate gear and shaft assembly.
3. A fuse.
4. An A.C. twist type receptacle.
- 5. A synchronous motor - 25 mhp, 3600 rpm.
6. A sheet metal base structure with oil pan, vibration dampners and cushioned feet to permit setting on a table.
7. A cover with a lens for the power indicator lamp, and openings for motor ventilation, power switch, fuse access and cable entrance.
8. A Terminal Block.
9. Provision for operating the selector or distributor at 60, 75 or 100 words per minute through use of 28G, 28H or 28J Set of Gears.

Dimensions of this unit are 8 inches high, 8 inches wide, and 10 inches deep.

→ 28B45 Mounting & Cover Assembly

→ This assembly, designed for use in the C1 Alarm and Control System, is the same as the 28A except for the addition of a TP178306 motor control relay. It is used in conjunction with a 28K Distributor and a 28J set of gears.

END OF SECTION