

HIGH-LEVEL OPERATION

LOW-LEVEL OPERATION

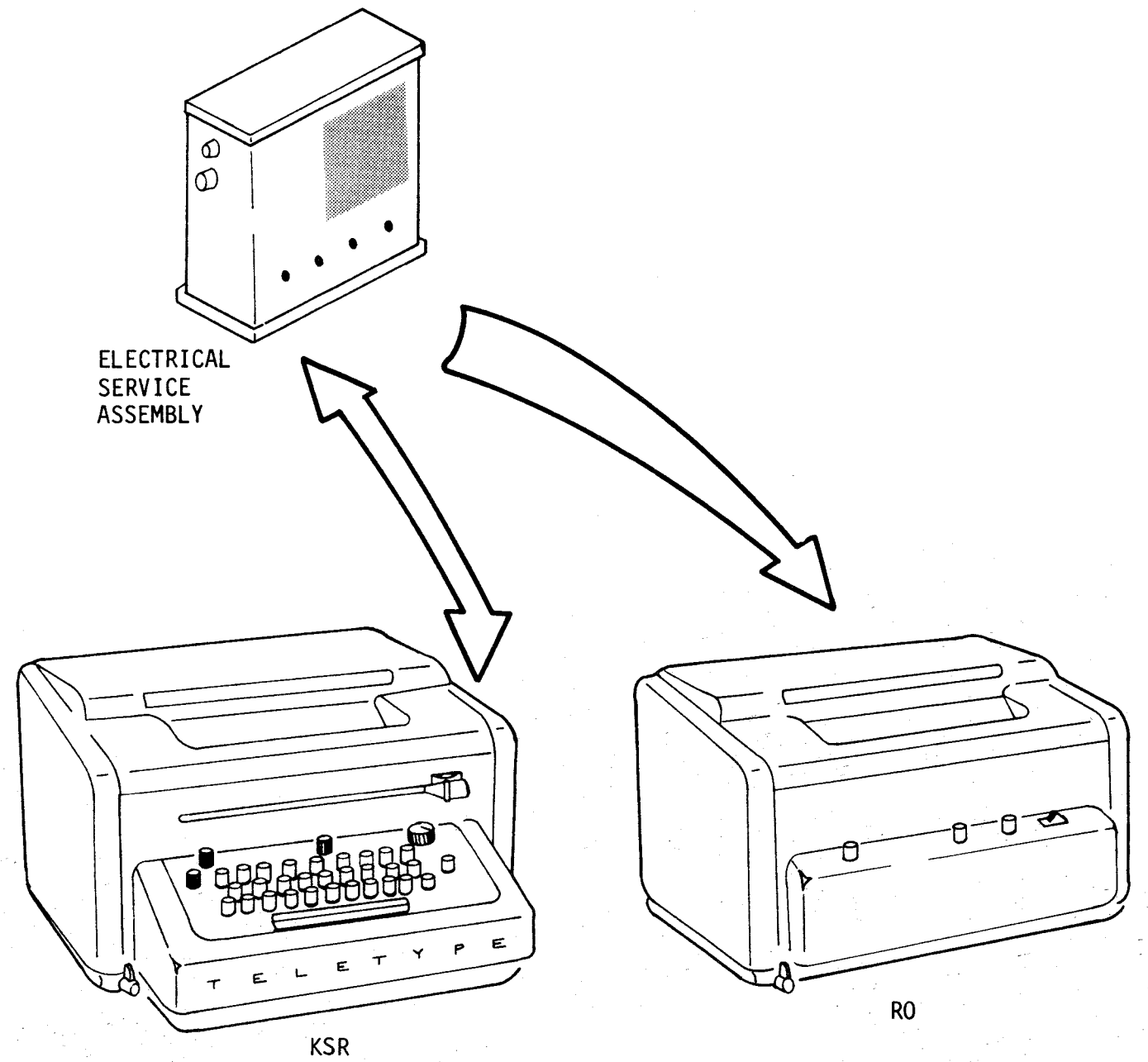
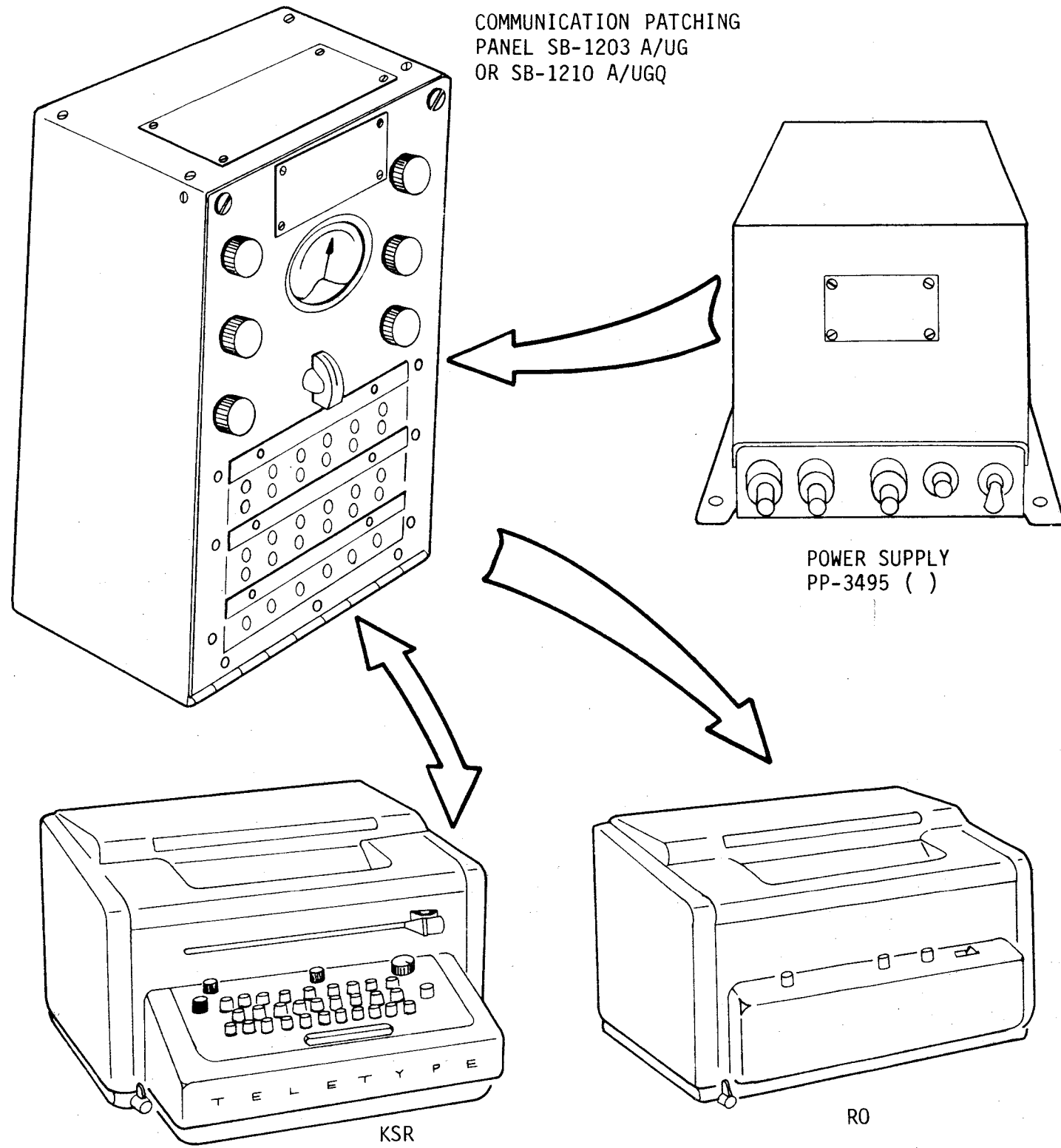

Figure 1-1. Model 28 Compact Page Printers KSR and RO

CHAPTER 1
GENERAL INFORMATION
AND SAFETY PRECAUTIONS

1-1. SAFETY PRECAUTIONS. To stress the importance of employing proper safety techniques while performing maintenance procedures on the equipment involved, the user of this manual is directed to thoroughly familiarize himself with the safety precautions described in Chapter 4, paragraph 4-4. Specific CAUTIONS concerning possible damage to equipment and WARNINGS concerning danger to personnel are referenced below (by paragraph) and should be strictly observed.

CAUTIONS

1-3.1d
4-5a
4-5a(4)
4-5d(2)
4-8b(1)(e)
4-8b(3)(b)
6-3.1b(2)
6-3.1f(15)
6-5d(1)
6-5f(19)(c)
6-5r(1)(f)
6-5r(2)(e)
6-7.1b(3)(e)
6-12j(13)
6-12l(9)(f)
6-12l(20)(f)
6-12l(21)(d)
6-12l(22)(c)
6-12w(3)
6-12w(7)(d)
6-12w(28)(b)

WARNINGS

4-6b
4-8a
5-2.2d(2)

1-2. INTRODUCTION. This manual provides information and instructions for installation, operation, and maintenance of Model 28 Compact Page Printer (CPP) Keyboard Send-Receive (KSR) and Receive-Only (RO) Teletypewriter Sets (figure 1-1). Maintenance information includes instructions for testing, performing preventive maintenance and adjustments, troubleshooting, and repairing. A parts list is also included. CPP configurations covered by this manual are described in matrices referenced in paragraph 1-6.

1-3. EQUIPMENT DESCRIPTION. The Model 28 Compact Page Printer (CPP) KSR and RO Sets are designed to provide normal teletypewriter service in mobile and fixed stations where minimum equipment size is desired. Interfacing equipment is shown in figure 1-1 for information only and is not a part of CPP teletypewriter equipment. Refer to paragraph 1-4. Equipment size has been reduced by using a modified 32 keyboard and a 28 typing unit.

a. General. The CPP KSR and RO teletypewriter sets originate and monitor messages in a telegraphic network. The characters or functions which form a message are originated by depressing individual keys on a KSR set. The resulting message is monitored by the local and selected typing units in the network. A RO set primarily monitors the telegraphic network to print the characters or interpret the functions.

(1) The KSR and RO sets are similar in appearance but differ in the number of mechanisms. The KSR is equipped with a keyboard transmitter mechanism and a distributor mechanism to originate and distribute coded information on the signal line. The RO has a control hood with power switch, local function keys, and break switch.

(2) Intelligence for the CPP teletypewriter sets is transmitted and received serially by means of a five level, binary permutation code. In addition to the five code bits, there is a start bit and a stop bit, always spacing and marking, respectively. The start bit precedes the code bits to initiate operation of the typing unit, and a stop bit follows the code bits to secure the typing unit. Variations of the KSR generate 7.00 and 7.42 units per character. The first bit (1 unit) is always spacing; the next five bits (5 units total) are either marking or spacing code levels, and the final bit (1 or 1.42 units) is always marking. The signal line remains energized by a remote dc power source during marking intervals, and becomes deenergized by local electrical contacts during spacing intervals.

b. High- and Low-Level.
This manual covers both high-level and low-level configurations of CPP teletypewriter sets. High-level teletypewriter sets are used in applications wherein radio frequency interference (rfi) does not present a problem. Low-level teletypewriter sets have rfi suppression features incorporated. One of the rfi suppression features is the use of a low-level signaling code

from which the term low-level is derived. The low-level signaling code is the +6-volt (mark) and -6-volt (space) polar code levels versus that of the 0.060 amperes (mark) and 0 amperes (space) neutral code levels used in the high-level sets. High-level teletypewriter equipment is described in paragraph 1-3.1 and low-level equipment is described in paragraph 1-3.2.

1-3.1 EQUIPMENT DESCRIPTION (HIGH-LEVEL). The KSR set (figure 1-2) consists of a keyboard unit, typing unit, motor unit, and cover. The RO set (figure 1-3) consists of a base unit, typing unit, motor unit, and cover.

a. Keyboard Unit (KSR).
The keyboard unit provides transmission facilities for originating coded characters, and a base for mounting the motor unit, typing unit, and cover. The keyboard unit (figure 1-4) consists of a mounting base, keyboard transmitter, distributor, 3-speed gear shift assembly, local function mechanisms, margin indicator switch, and electrical cable assemblies. The margin indicator switch (not visible in the photo) is attached to the mounting base behind the keyboard transmitter, and is operated by the typing unit. When operated, it illuminates a neon indicator lamp on the cover. The local function mechanisms respond to the deflection of their keys on the keyboard transmitter. The keys mechanically control line feed and carriage return on the typing unit.

(1) Mounting Base.
The mounting base includes the inner base and outer base pan. The inner base is isolated from

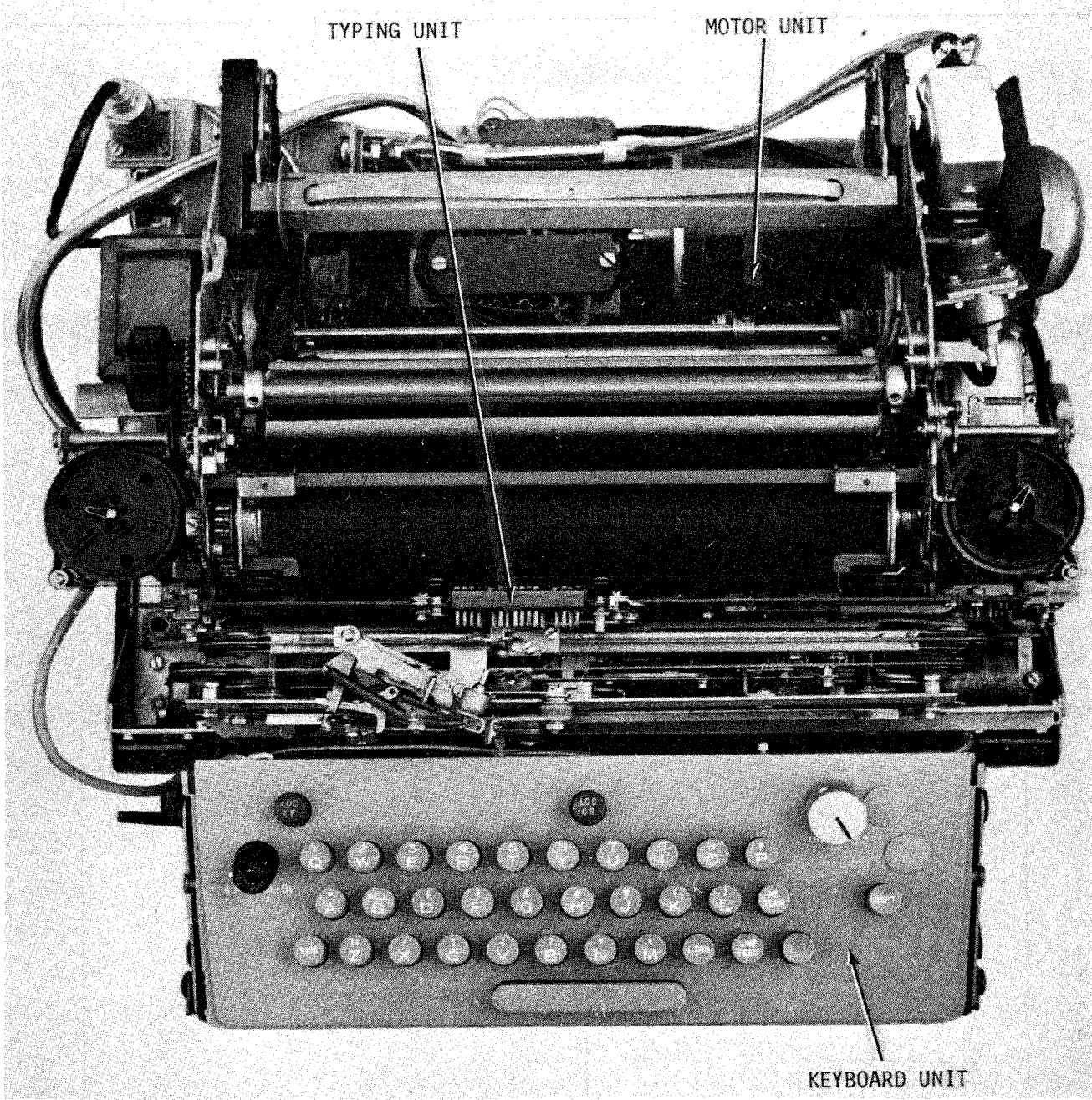

Figure 1-2. Model 28 Compact Page Printer (KSR)
(Cover Removed)

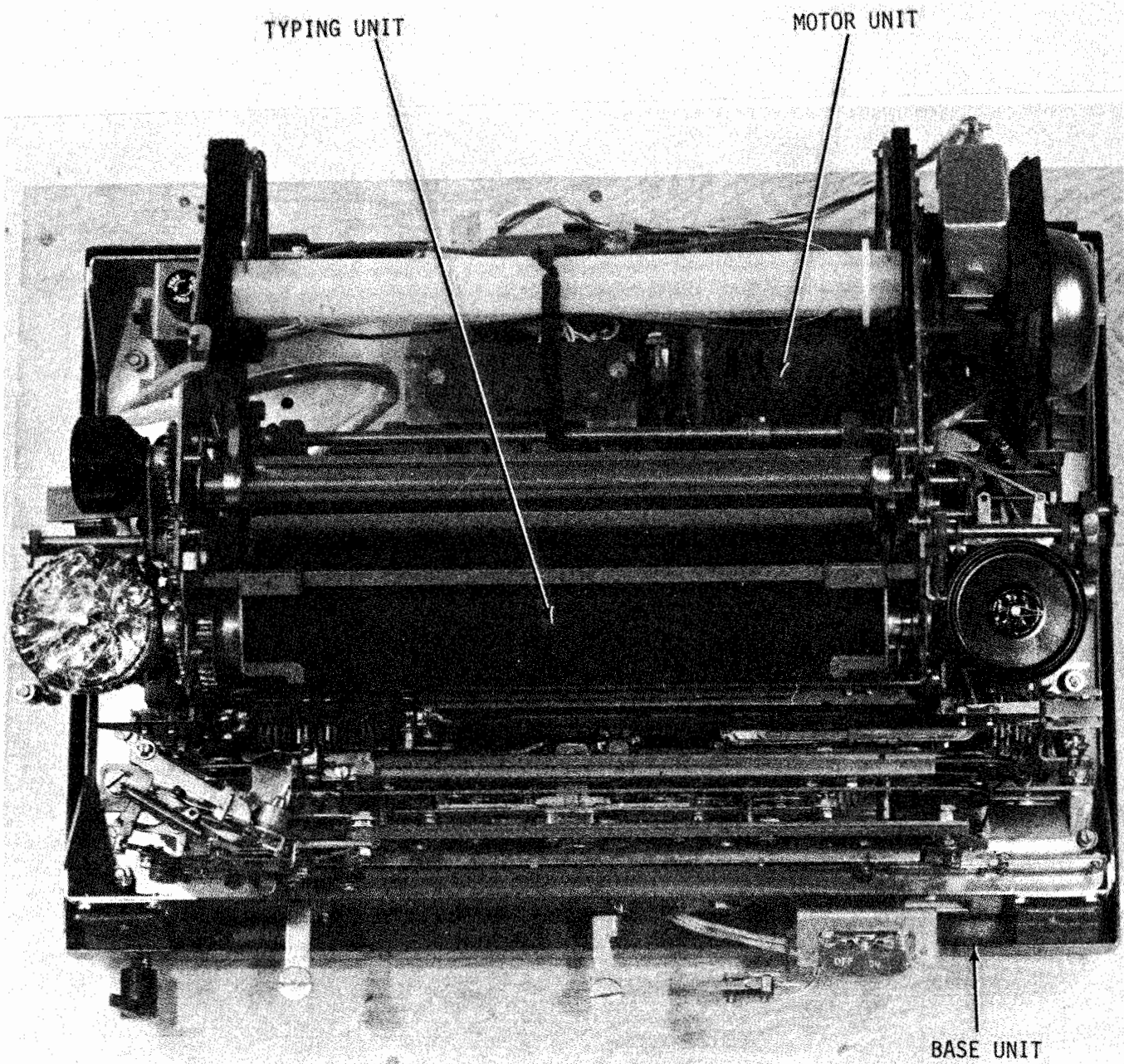

Figure 1-3. Model 28 Compact Page Printer (RO)
(Cover Removed)

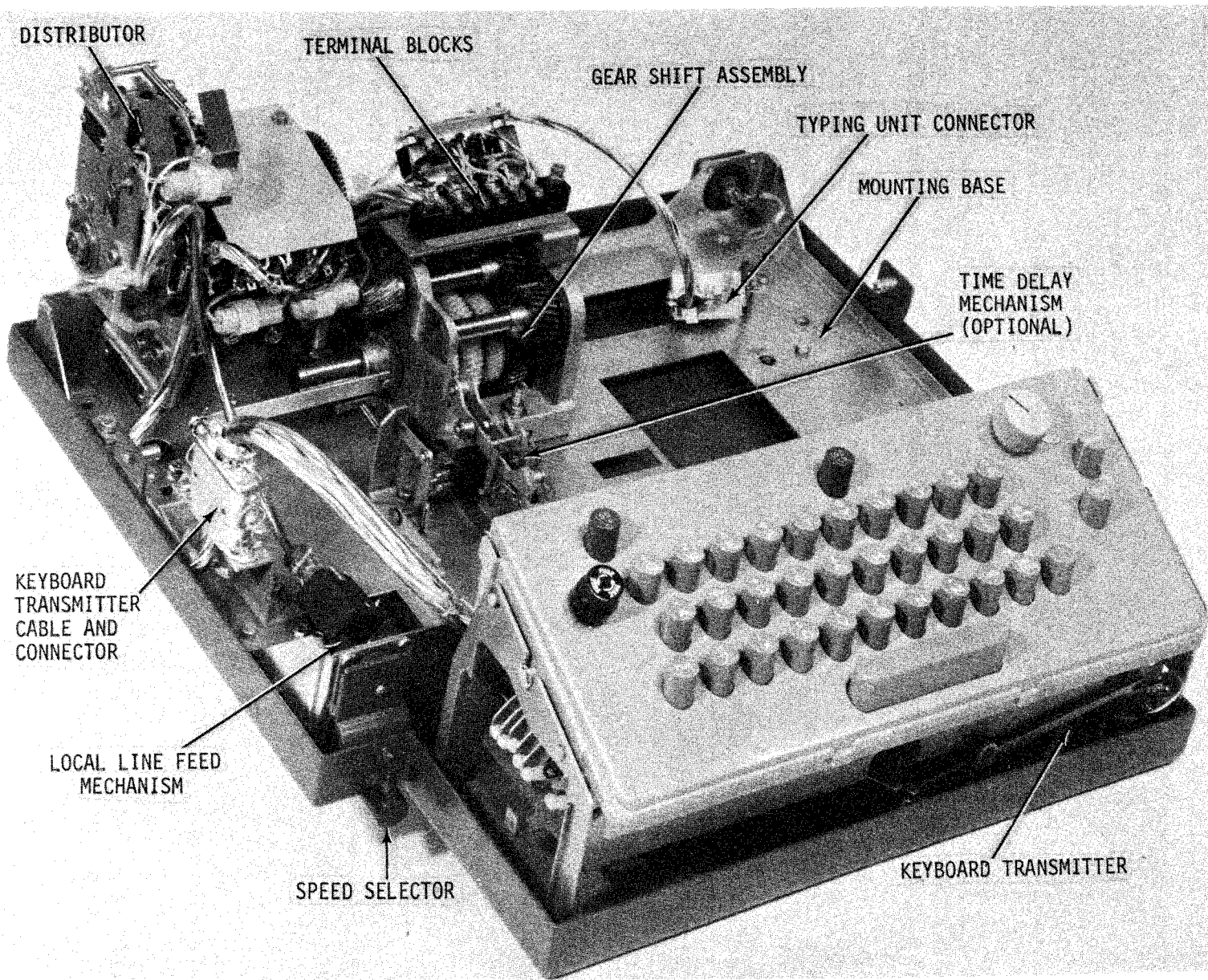

Figure 1-4. Keyboard Unit

the outer base pan by four, vertically positioned, vibration mounts. The outer base pan provides mounting facilities for the keyboard transmitter and cover unit.

(2) Keyboard Transmitter. The keys on the keyboard transmitter (figure 1-5) are arranged in a conventional manner with numerals, punctuation marks, and special symbols in upper case positions. Standard keys for local line feed and local carriage return are located above the character keytops. Line break and repeat keys are located to the right of the character keys. Power to the electrical components in the set is initially routed through the switch in the upper right corner and through the fuse in the upper left corner. When a character key is depressed, the wire contacts on the right side of the keyboard transmitter are simultaneously positioned in marking and/or spacing conditions, and the universal lever is released. The universal lever is reset by a solenoid reset mechanism. The solenoid is attached to the rear of the keyboard transmitter. With the exception of local function mechanisms, all functional connections between the keyboard transmitter and the rest of the set are made through the cable and connector. The repeat key when depressed operates a miniaturized switch to maintain current in the distributor magnet and open the solenoid reset circuit.

NOTE

To prevent loss of characters during repeat operation, the repeat key should be depressed in conjunction

with the character key. However, if the keyboard transmitter is inadvertently reset while the repeat key is depressed, a series of blanks will be transmitted.

The break key simply opens the signal line circuit by pushing the break contact wire away from the terminal strip.

(3) Distributor. The distributor (figure 1-6) is located in the left rear corner of the keyboard unit. The distributor consists of a trip magnet assembly, cam-clutch assembly, contact block, and mounting frame. The electrical cable from the keyboard transmitter merges with the distributor wiring harness through a 24-point connector.

(4) Gear Shift Assembly. The 3-speed gear shift assembly is located in the rear center of the keyboard unit (figure 1-7). The speed selector is located in the front left corner of the base pan. The speed selector and gear shift assembly are mechanically linked between the front and rear of the base. Each position of the selector will engage one of three gears with the variable speed shaft of the gear assembly. The operating speed may be changed with the motor unit in the running or idle condition.

b. Base Unit (RO). The receive-only base provides mounting facilities for the motor unit, typing unit, and cover. The base consists of a mounting base, 3-speed gear shift assembly, local function mechanisms, and signal line break key. The mounting base includes an inner base and outer base pan. The inner and outer

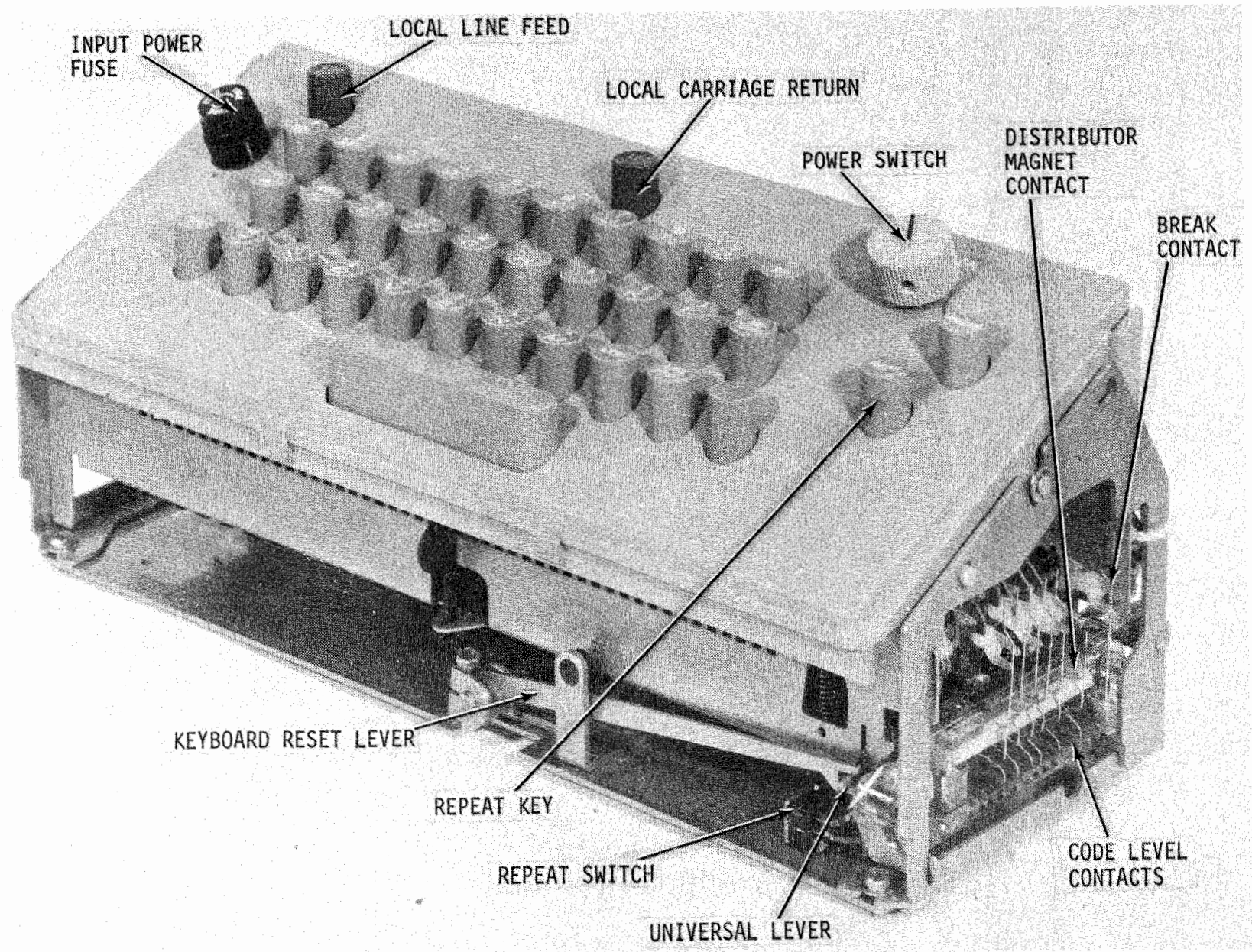

Figure 1-5. Keyboard Transmitter

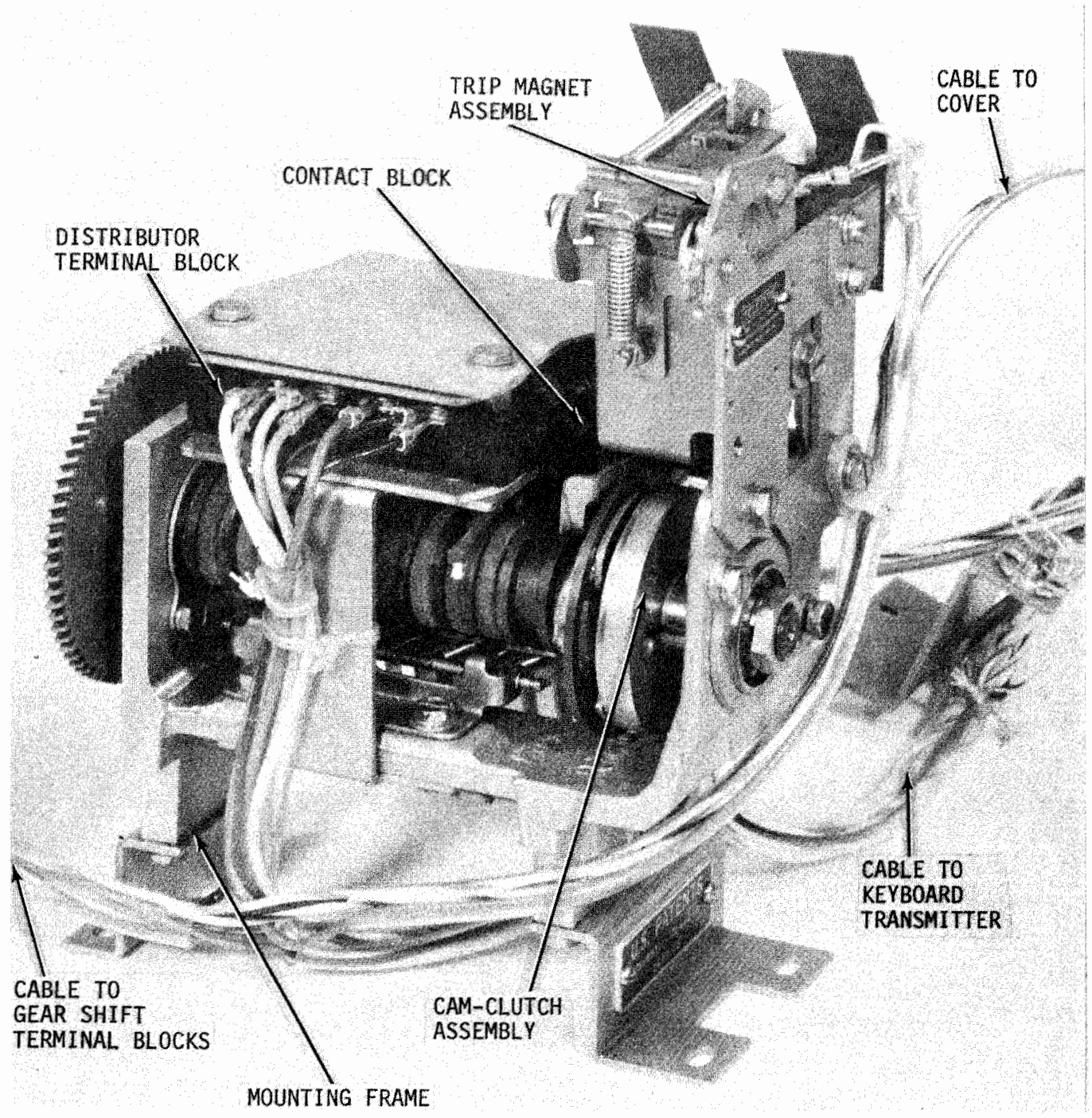

Figure 1-6. Distributor (Rear View)

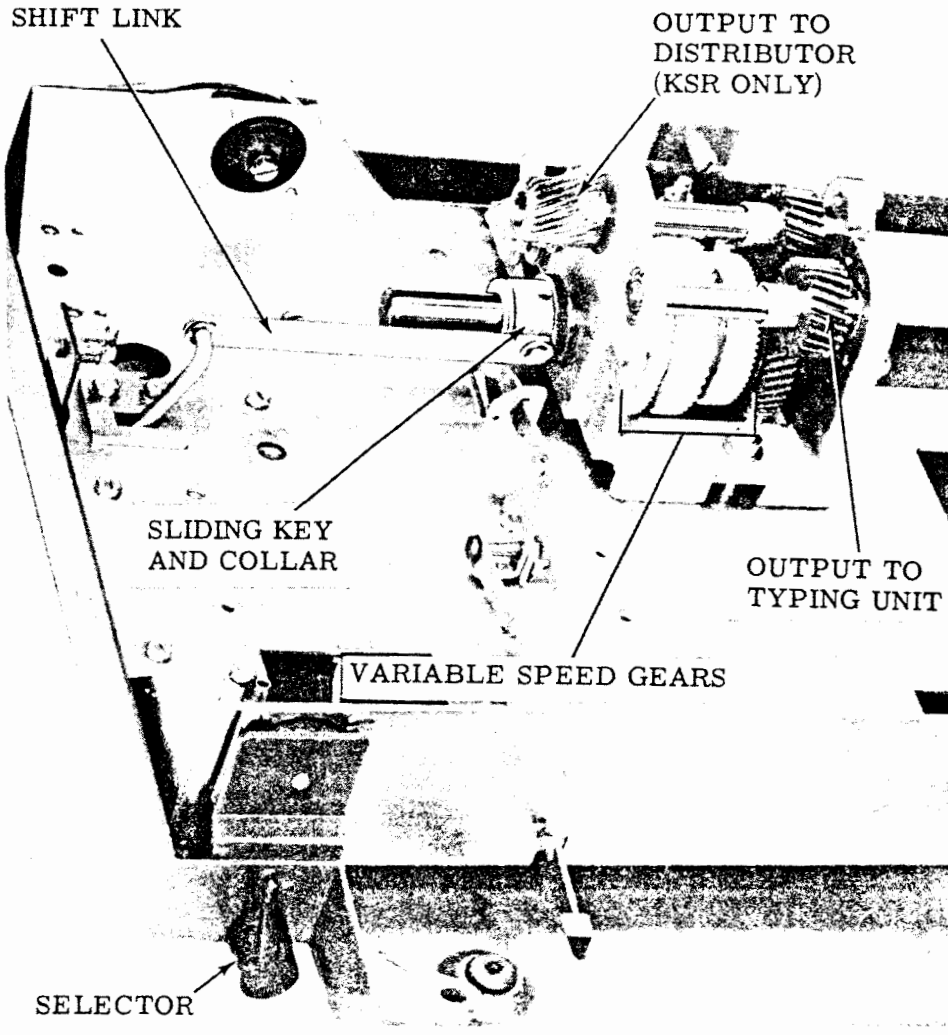

Figure 1-7. 3-Speed Gear Shift Assembly

base elements are isolated from each other by four vertically mounted vibration mounts. The local line feed, local carriage return, signal line break, and ON-OFF power switch are attached to the base unit, and extend through the control hood on the cover (figure 1-8). When turned ON, the power switch illuminates an indicator lamp on the cover. Power to the electrical components in the set is initially routed through the switch and through a fuse in the left rear corner of the base.

c. Typing Unit (KSR and RO). The typing unit (figures 1-9 and 1-10) is composed of mechanisms interconnected to perform a function or to type a character.

The major mechanisms are the selector mechanism, code bar mechanism, function mechanism, and printing and spacing mechanism. A main shaft accepts rotational motion and, through a series of cams, clutches, and gears, distributes the motion to operate the typing unit mechanisms. The motion is extended to each mechanism as the typing unit proceeds through its operating cycle. The typing unit is mounted on a keyboard base (KSR) or a base (RO). Rotary mechanical motion for its operation and information in the form of a signaling code come from an external source. A front plate and side plates provide mounting facilities for the various assemblies and

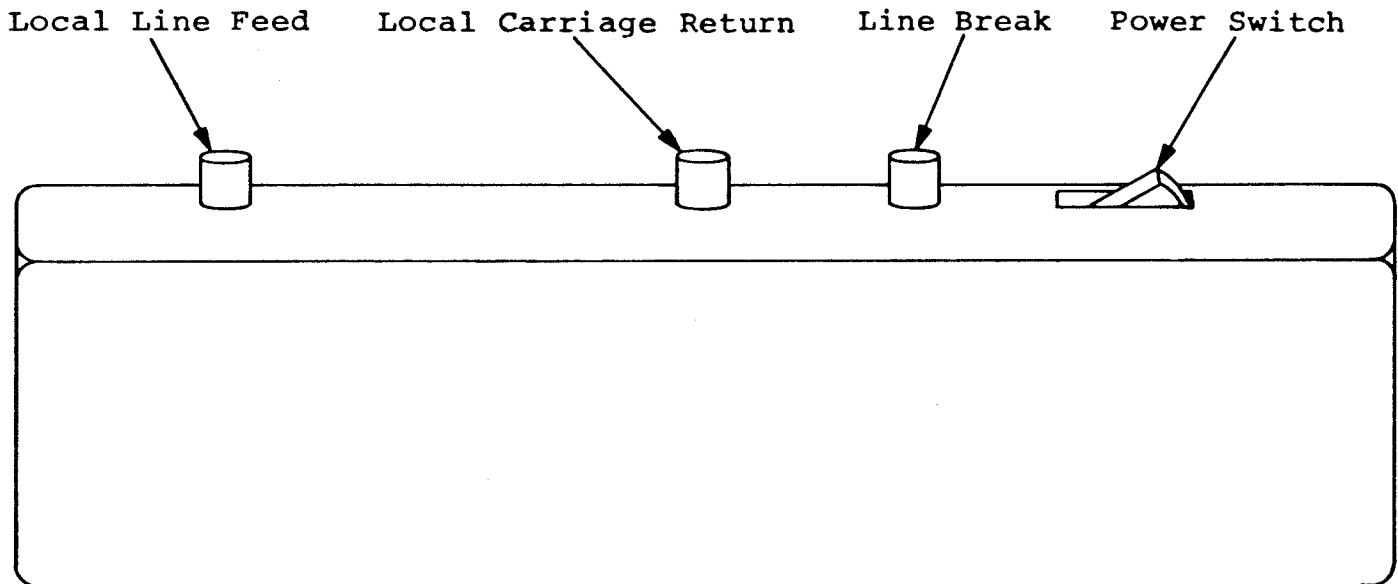

Figure 1-8. Control Hood (RO)

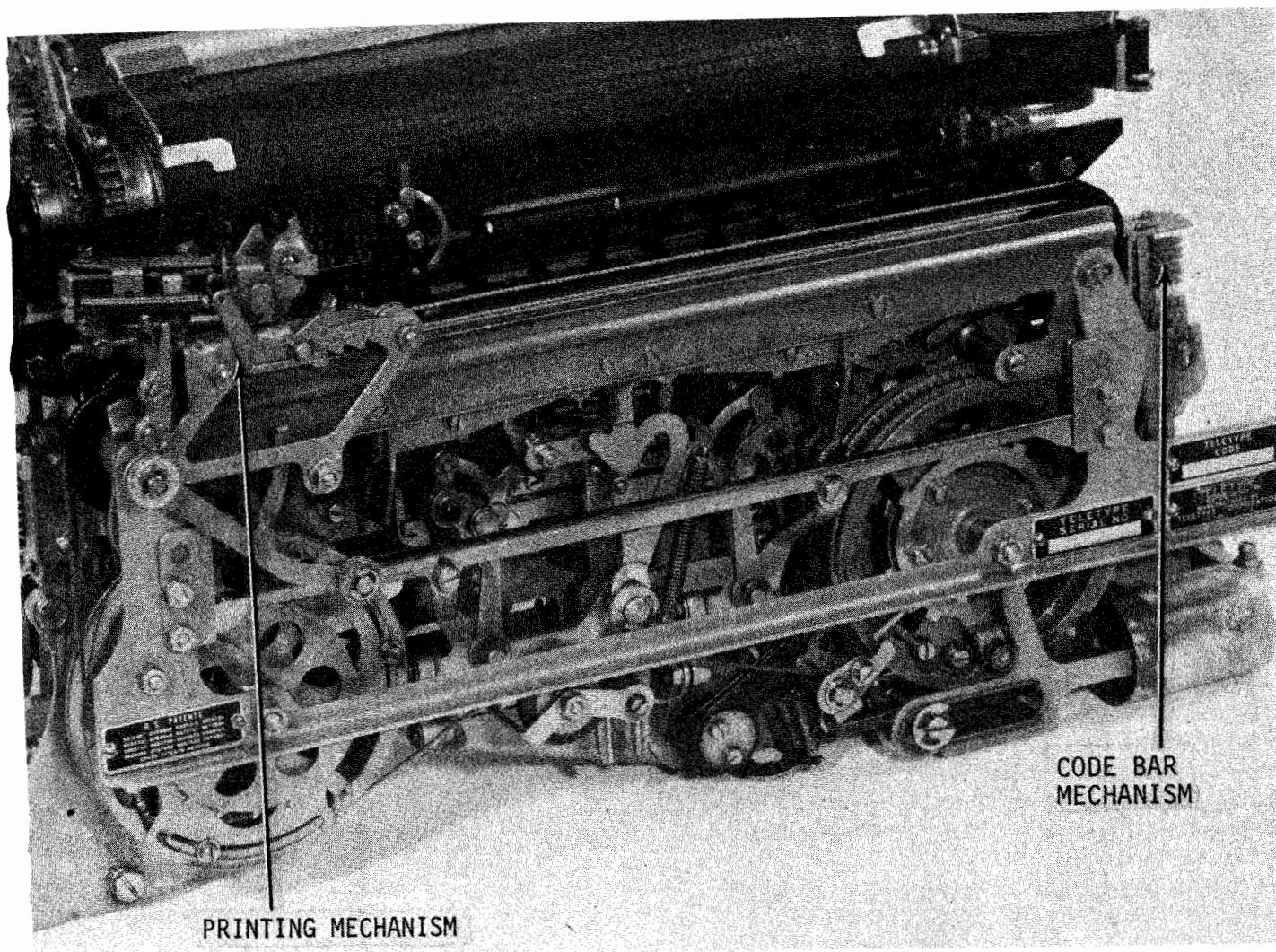

Figure 1-9. Typing Unit (Front View)

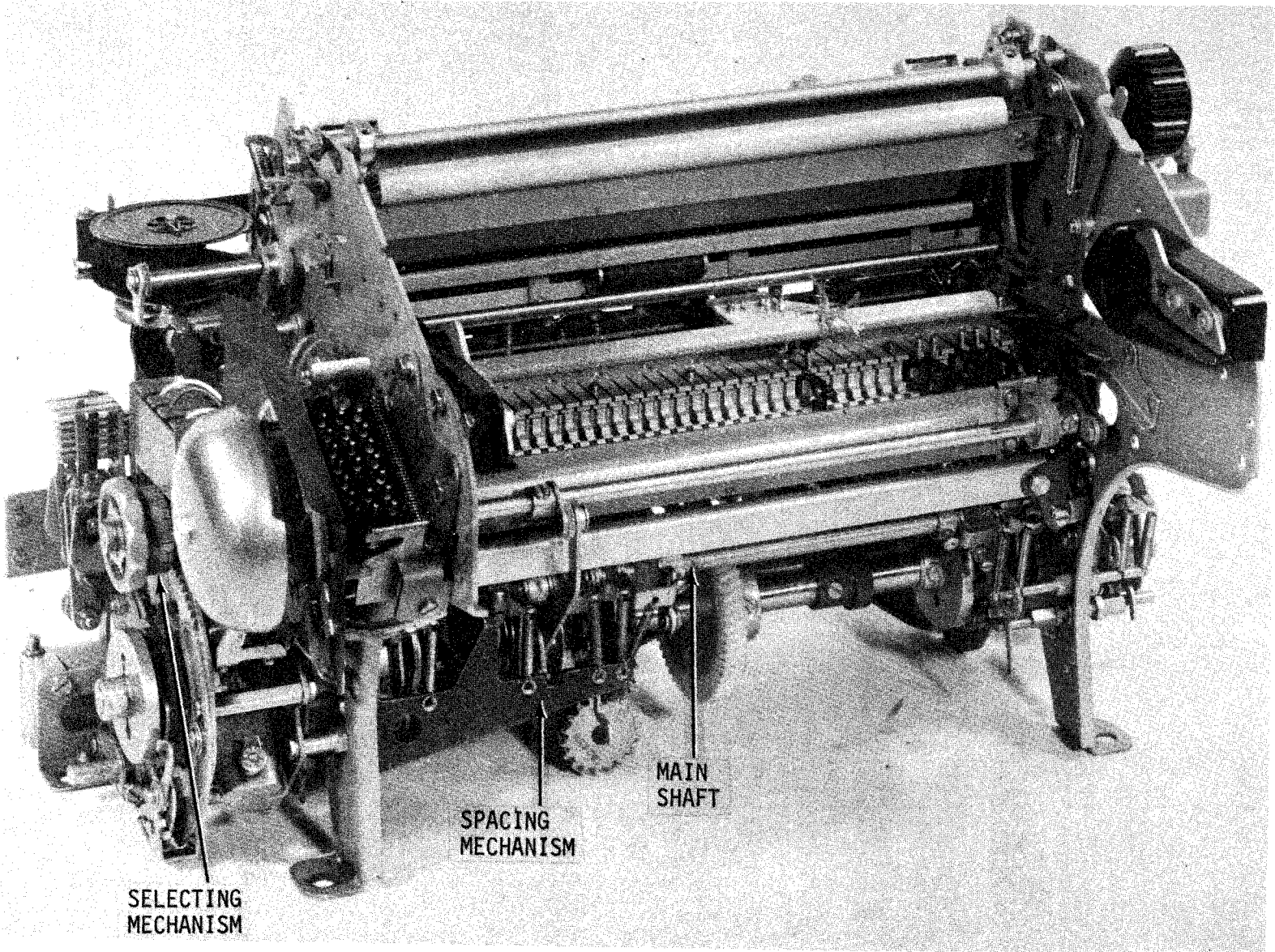

Figure 1-10. Typing Unit (Rear View)

mechanisms that make up the unit.

d. Motor Unit (KSR and RO). Mechanical motion for driving the distributor (KSR only) and typing unit is provided by a 1/20 horsepower, two pole, single phase, synchronous motor unit. The motor unit (figure 1-11) operates from a 115 $\pm 10\%$ VAC source. Both 50 $\pm 0.75\%$ Hertz, 3000 rpm or 60 $\pm 0.75\%$ Hertz, 3600 rpm motors are available. The motor rests in the cradle of a mounting bracket and is held in place by a strap at each end. The cradle is isolated from the motor by resilient mounts to reduce vibration. A small fan is mounted at each end of the rotor within the motor housing, and a combination handwheel and fan is mounted on the rear of

the shaft. A start relay and start capacitor are mounted in front of the motor. A thermal cutout switch is located in the rear of the motor. The thermal cutout switch provides protection against overload.

CAUTION

If motor becomes blocked for several seconds, the thermal cutout switch will break circuit. Allow motor to cool at least 5 minutes before depressing red reset button.

e. Cover Unit (KSR and RO). The cover provides a protective enclosure for the KSR (figure 1-12) and RO (figure 1-13) teletypewriter

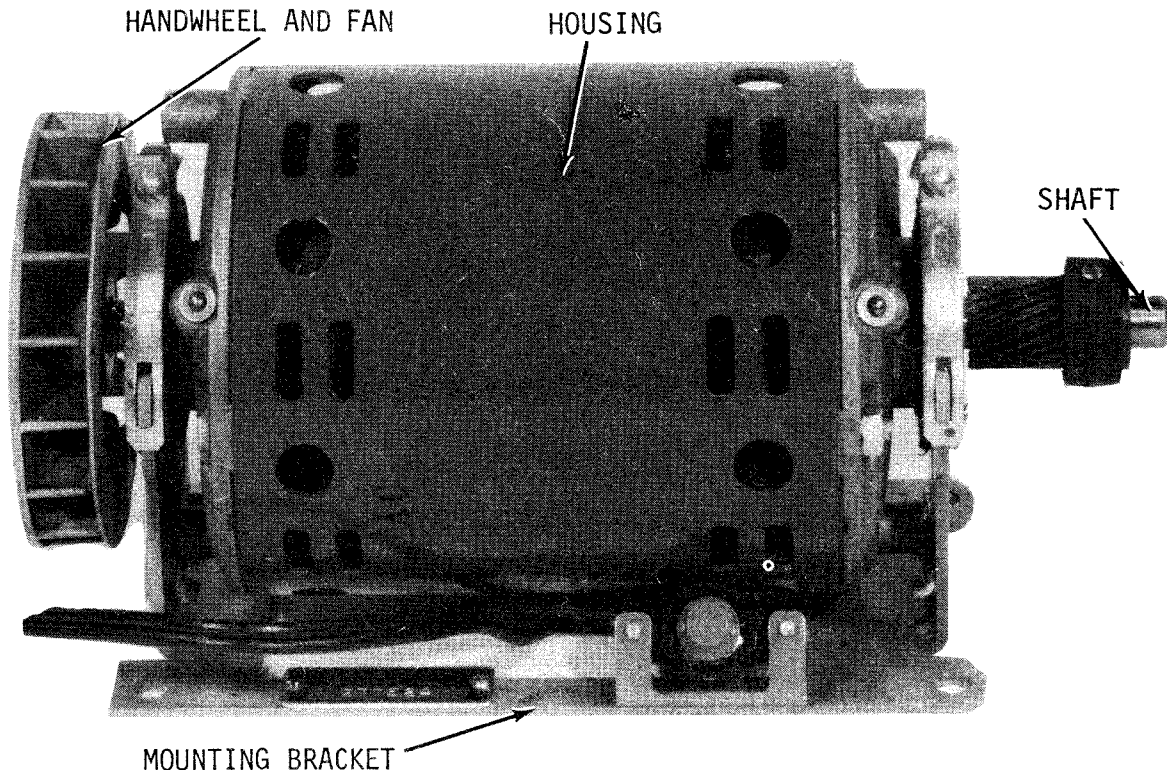

Figure 1-11. Motor Unit (Rear View)

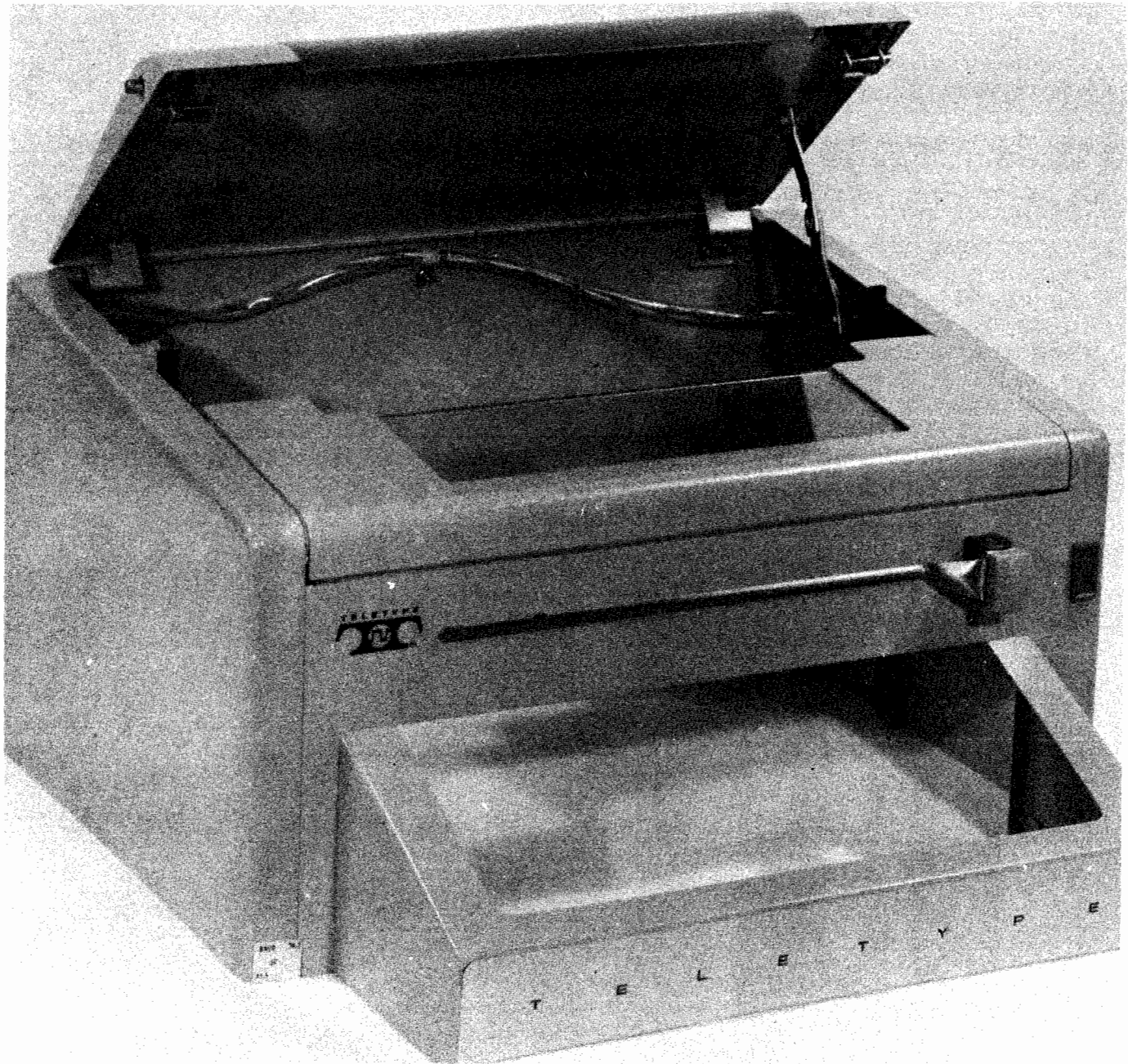

Figure 1-12. Cover Unit (KSR)

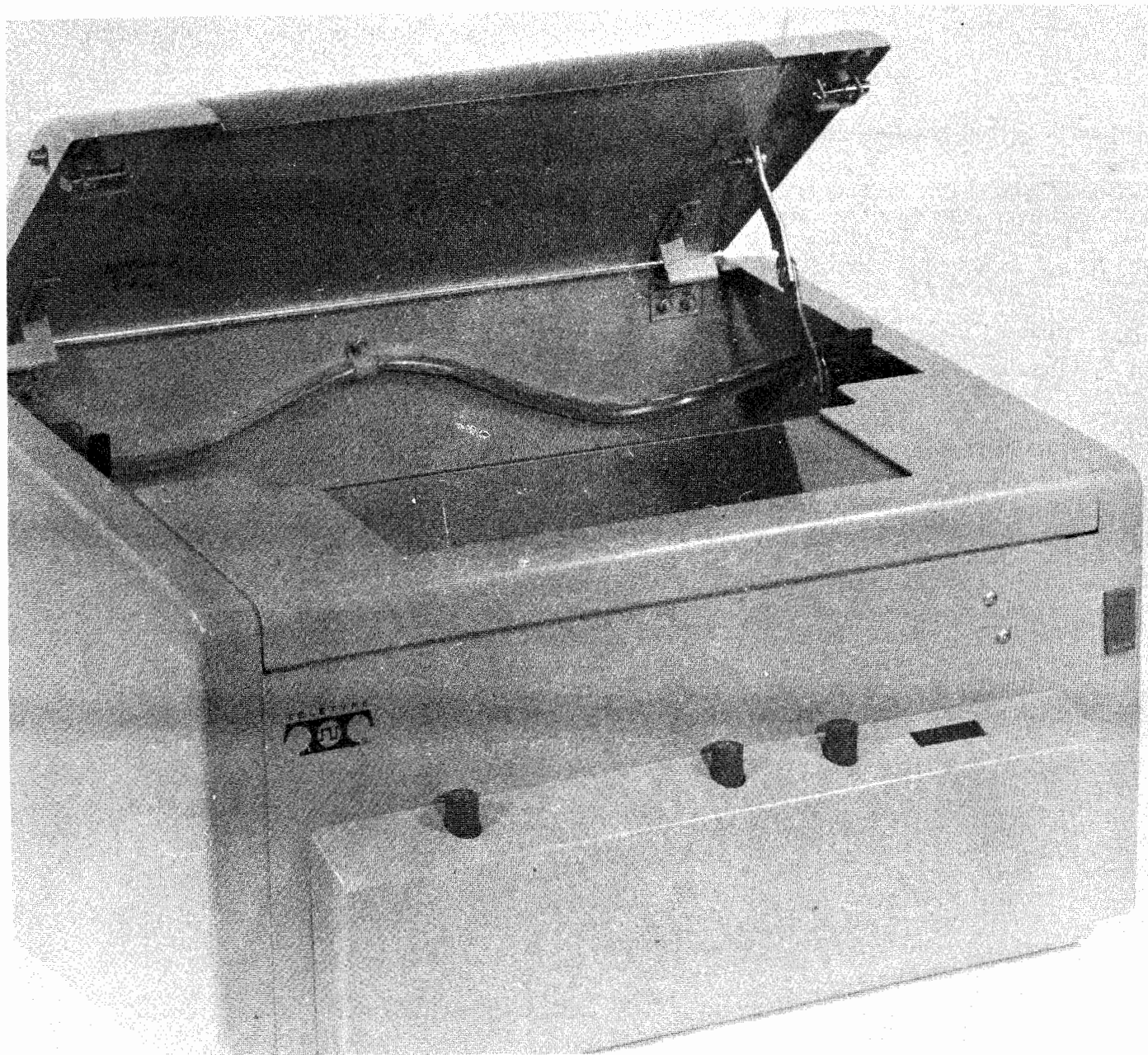

Figure 1-13. Cover Unit (RO)

sets. The cover is positioned on the base by three retainers and is locked to the base by two spring loaded latches. The latches are attached to the inside surfaces of the cover and are accessible through the dome. The dome is released by depressing the plungers on the left and right sides. When raised, the dome is supported in an open position by the stop arm. Power circuits are extended to the cover through a six point connector. A step down transformer is attached to the inside surface of the cover. Line voltage is reduced for the copylights in the cover. The power indicator lamp for the RO set is located on the cover unit. The lamp is illuminated when power is applied. The margin indicator lamp for the KSR set is illuminated when the switch on the keyboard unit is tripped by the typing unit. The margin indicator contains a neon bulb which is illuminated from line voltage. The lamp circuit is routed through the six point connector. The window at the top of the cover permits visual observation of the printed copy. A copy holder and line guide is provided on KSR sets.

f. Variable Features. A motor stop time delay mechanism (figure 1-4) is available as an optional feature and is used in conjunction with a separate electrical service unit. The motor stop time delay mechanism consists of a time delay mechanism and a stop magnet assembly. The stop magnet assembly, located in a separate service unit, requires an electrical pulse to open the power circuit to the set. The pulse originates from a time delay mechanism on the keyboard or base unit. Upon receipt of a pulse, the motor is stopped and the signal line is shunted. The

pulse occurs after the signal line has remained continuously energized from 756 to 1512 revolutions of the typing unit main shaft. A cam on the typing unit main shaft drives a ratchet mechanism on the base. The motor is restored to its running condition when the signal line current is interrupted by a start pulse or line break.

1-3.2 EQUIPMENT DESCRIPTION (LOW-LEVEL). Low-level KSR and RO CPP teletypewriter equipment differs from high-level equipment in that radio frequency interference (rfi) suppression features have been incorporated in several of the low-level components. The following paragraphs describe the rfi suppression features and point out the areas of difference between high and low-level equipment.

a. RFI Suppression. RFI suppression as applied to teletypewriter equipment is accomplished by means of shielding and wave shaping a low level electrical telegraph signal throughout the equipment. The installations vary with each set, but produce the same results of ensuring signal line privacy.

(1) Signaling. The code is transmitted by means of a +6-volt polar signal through a network of shielded cables to the shielded container of an electrical service assembly (ESA). A +6-volt signal is mark; a -6-volt signal is space.

(2) Electrical Service Assembly (ESA). The ESA is an electrically shielded container in which shielded cables terminate. It also serves as a housing for certain components such as plug-in selector magnet driver circuit

cards, clutch magnet driver circuit cards, keyer circuit cards, power supply circuit cards, and relays. Electrical service assemblies which house low level keyers (LLK) and selector magnet drivers (SMD) have double shielded containers and double shielded cables with appropriate connectors for LLK and SMD connections to external equipment.

(3) Cabling. The shielded cabling varies with each set according to need. Each component unit of a set is equipped with sufficient shielding, in the form of metallic enclosures and shielded cables, to suppress signal radiation. All signal generators and magnet assemblies in the signal circuitry are shielded by means of metal containers attached to their respective cables. Interconnecting cables join the component units to the electrical service assembly by means of metal connectors which screw together for a tight shielded connection.

b. Keyboard Unit (KSR). The rfi application for low-level keyboard units consists of shielded line signal cable and photoelectric signal generating devices instead of contact mechanisms in the keyboard transmitter and the distributor.

(1) Mounting Base. The high-level mounting base description in paragraph 1-3.2a(1) is also applicable to the low-level mounting base.

(2) Photoelectric Keyboard Transmitter. A lamp assembly in the keyboard transmitter photoelectric assembly (figure 1-14) provides the necessary light source to

activate the photocells. A mechanical shutter assembly, linked with the keyboard transmitter code bar mechanism and located between the photocells and lamp assembly, provides windows to either allow light from the lamp assembly to pass and activate the photocells (mark) or to block the light and not activate the photocells (space). The photocells generate a parallel electrical signal of approximately 300 microamperes. The generated signal travels along a shielded cable to the photoelectric distributor.

(3) Photoelectric Distributor. The photoelectric distributor (figure 1-15) serializes the signal, and by means of a shielded cable, routes it to the input of a polar line keyer.

(4) Gear Shift Assembly. The gear shift assembly in low-level equipment is identical to that used in high-level equipment. Refer to paragraph 1-3.1a(4).

(5) Synchronous Pulse. Synchronous pulsed transmission is accomplished by the keyboard reset mechanism and pulsed operation of the photoelectric distributor clutch magnet.

c. Base Unit (RO). The high-level base unit description in paragraph 1-3.1b is also applicable to the low-level base unit.

d. Typing Unit (KSR and RO). RFI suppression of the typing unit is achieved by means of an rfi selector mechanism. The rfi selector mechanism (figure 1-16) mounts on the upper right side frame of the typing unit. The selector

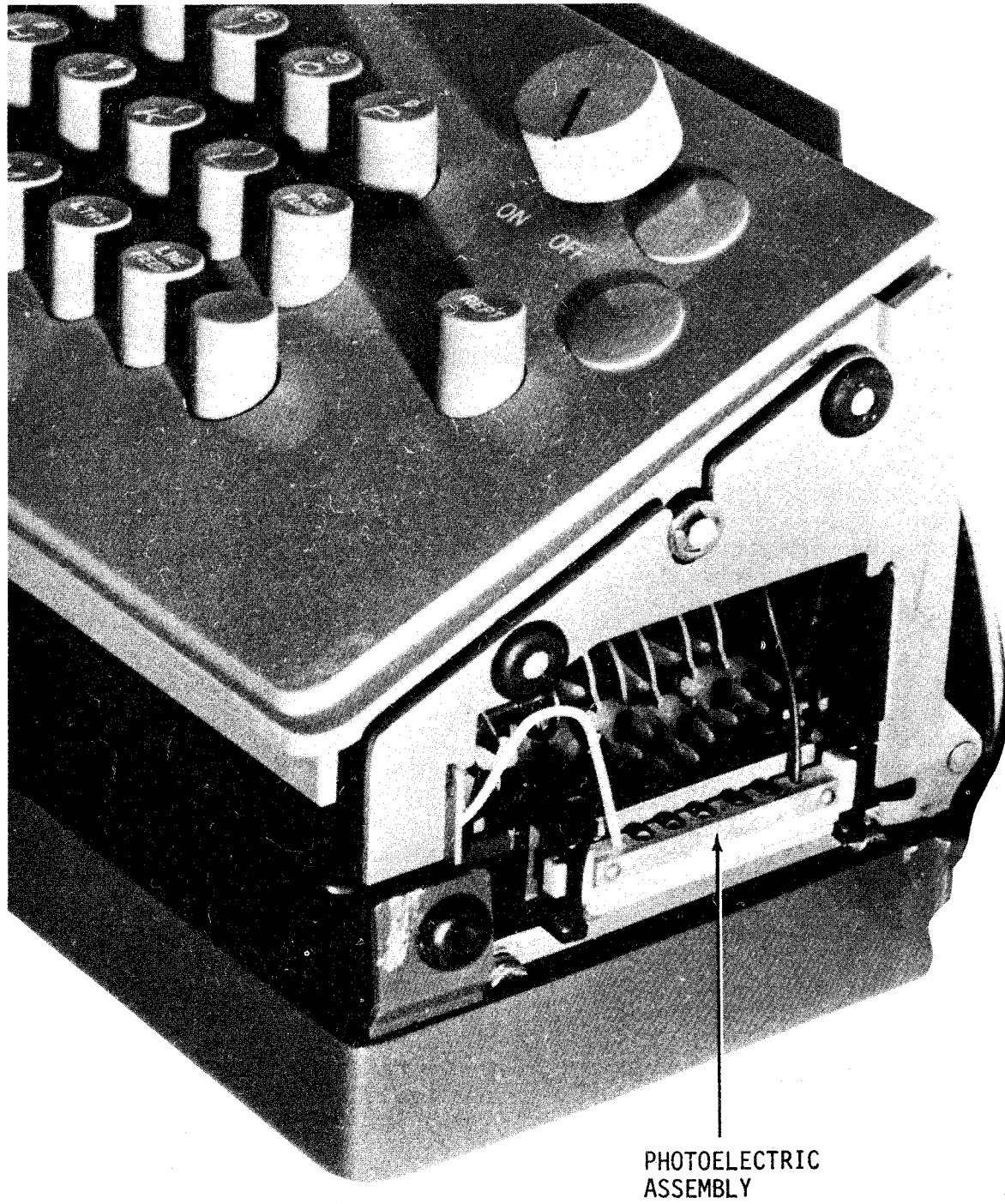

PHOTOELECTRIC
ASSEMBLY

Figure 1-14. Keyboard Transmitter Photoelectric Assembly

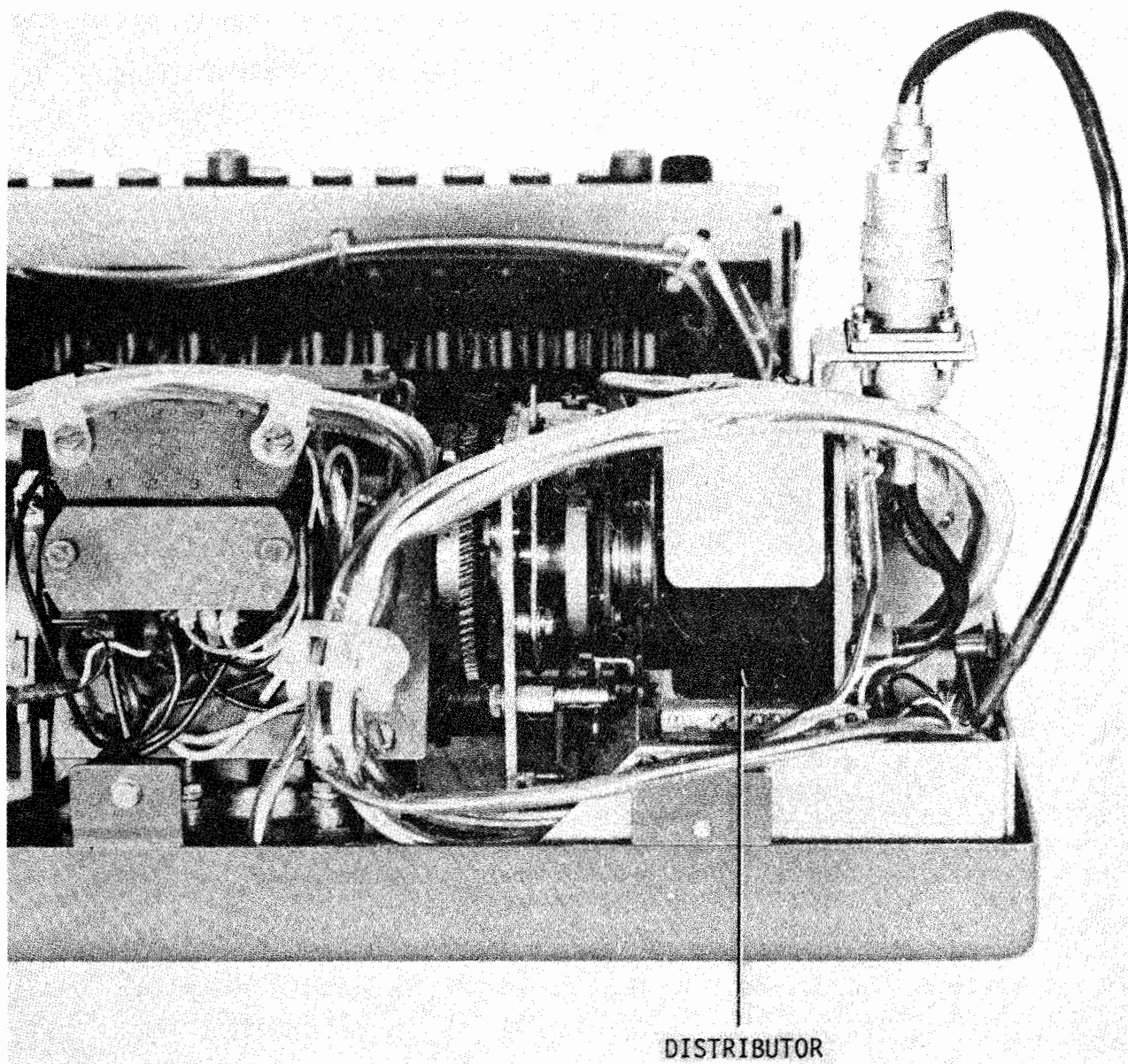

Figure 1-15. Photoelectric Distributor

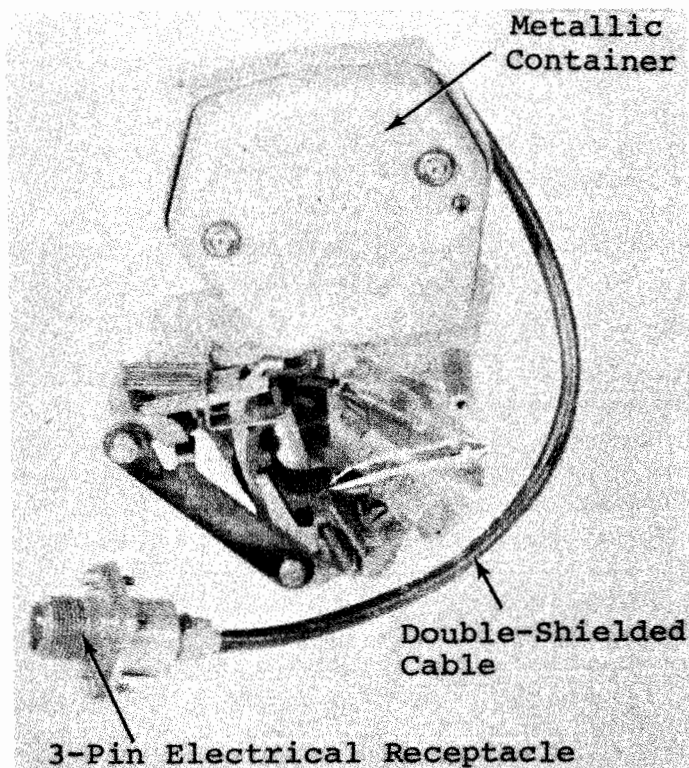

Figure 1-16. RFI Selector Mechanism

consists of a special three-pin electrical receptacle, double shielded cable, and metallic container. The three-pin electrical receptacle ensures a secure and shielded electrical connection to other associated apparatus. The double shielded cable electrically connects the three-pin electrical receptacle to the selector magnets. The shielded cable is composed of three electrical conductors encircled by braided inner and outer shields. The inner and outer braided shields are electrically separated from each other and the three electrical conductors by flexible solid dielectric. The metallic container functions as a shielded enclosure for the selector magnet assembly. Enclosed within the metallic container are the selector

magnet coils, coil mounting bracket, and selector armature. Each selector magnet coil contains an electrostatic shield which surrounds the coil windings. The selector coil mounting bracket provides mounting facilities for the coils, armature, and biasing spring. The receptacle, shielded cable, metallic container, and selector coils provide rfi suppression when used with associated rfi equipment.

e. Motor Unit (KSR and RO). The motor unit used in low-level equipment is identical to that used in high-level equipment. Refer to paragraph 1-3.1d.

f. Cover Unit (KSR and RO). The high-level cover unit

descriptions in paragraph 1-3.1e also apply to the low-level cover units with one exception; the step-down transformer for the copy lights is mounted in the cover in high-level equipment, and mounted on the typing unit in low-level equipment.

g. Electrical Service Assemblies. Electrical service assemblies (ESAs) are metal shielded containers which vary for different applications. A typical ESA is shown in figure 1-17. ESAs house electronic components which serve to suppress radio frequency interference (rfi) and provide low-level transmission of telegraph signals. The three types of ESAs used with low-level CPP teletypewriter sets are listed in table 1-1 along with the number of connectors provided for associated LLK, SMD, and CMD circuit cards (figure 1-18). All three of the ESAs are table mounted. ESAs which house LLK and/or SMD circuit cards require double-shielding. An inner aluminum box functions as an electrostatic shield and is electrically isolated from an outer box which serves as a magnetic shield. CMD circuit cards do not require double box construction. Single box construction is adequate for the CMD and serves as a combined electrostatic-magnetic shield. The inner box contains a mounting plate with printed circuit board connectors to accommodate a power supply with printed circuit board assembly and the required number of CMD, SMD, and LLK circuit cards. A screw terminal strip is provided for connecting the signal line. The inner box also contains the power supply rectifier filter capacitor. The outer box contains the inner box, power

supply transformer, power line filter, and screw terminal block for ac power connections. A power switch and fuse are located on one side of the outer box. The power supply transformer and rectifier filter capacitor form an assembly which, when used with an ESA Power supply card, will meet power supply requirements.

1-4. RELATIONSHIP OF UNITS.

Figure 1-1 shows the relationship between a CPP teletypewriter set and external interfacing equipment. The communication patching panel (SB-1203A/UG or SB-1210A/UGQ) is for shipboard use to facilitate interconnection of teletypewriter sets and various types of terminal equipments. Refer to NAVSHIPS 0967-LP-874-1010. The power supply (PP-3495()) is used as a dc loop current supply for high-level operation of teletypewriter sets. (Refer to NAVSHIPS 0967-LP-425-1010.) For low-level CPP operation, the electrical service assembly (ESA) is required.

1-5. REFERENCE DATA. Reference data pertinent to Model 28 CPPs, both high and low level, are provided in table 1-2. Data for the ESA 0.5-Ampere Power Supply applies only to low-level equipment.

1-6. EQUIPMENT SUPPLIED. The matrices in tables 1-3 and 1-4 list the family of Model 28 CPP Teletypewriter equipment by official NAVY nomenclature versus Teletype Corporation code numbers for major assemblies comprising each configuration.

1-7. EQUIPMENT REQUIRED BUT NOT SUPPLIED. Table 1-5 lists tools and test equipment not supplied but required for maintenance and troubleshooting procedures.

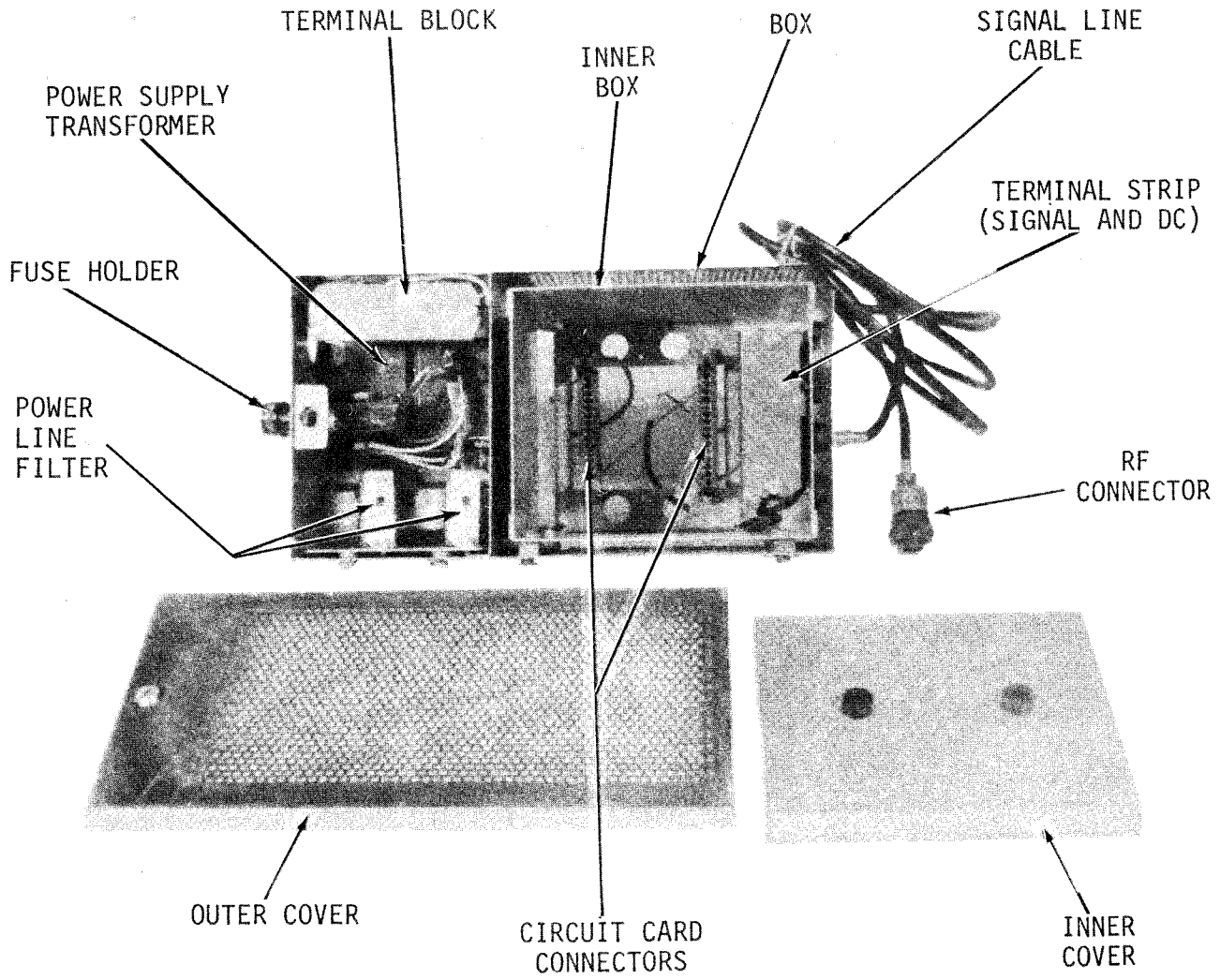

Figure 1-17. Typical ESA (Top View)

Table 1-1. Electrical Service Assemblies Used in
Low-Level CPP Teletypewriter Sets

Electrical Service Assembly	Circuit Card Connectors			
	0.5A Power Supply	LLK	SMD	CMD
TP321231	1		1	
TP323120	1			1
TP323121	1	1	1	

LLK = Low Level Keyer
SMD = Selector Magnet Driver
CMD = Clutch Magnet Driver

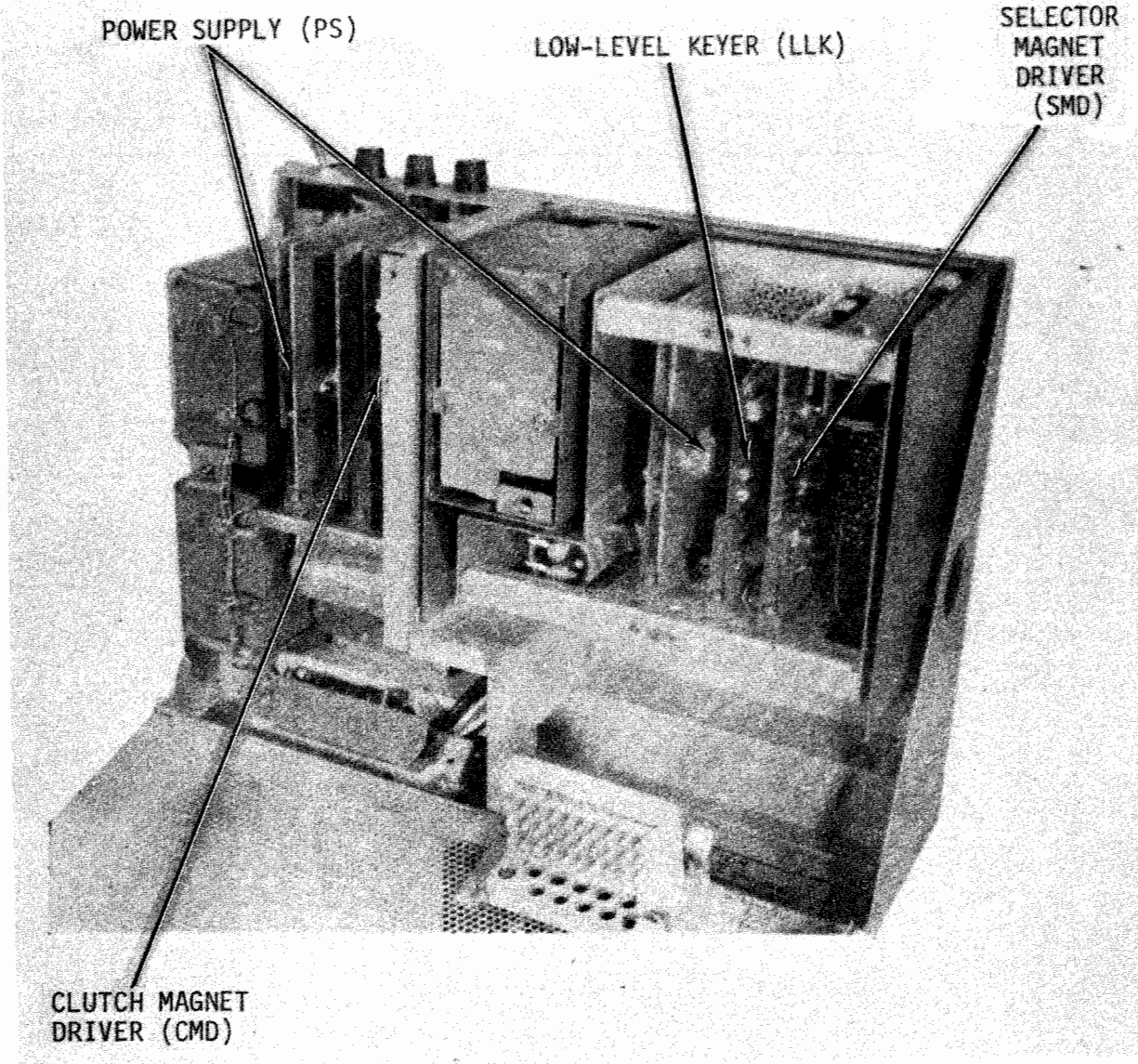

Figure 1-18. ESA - Circuit Cards Installed

Table 1-2. Reference Data

<u>Description:</u>	
Nameplate data:	Model 28 CPP (KSR and RO) Teletypewriter Sets
Manufacturer:	Teletype Corporation
Weight: KSR: RO:	59 lbs. 50 lbs.
Depth: KSR: RO:	16 inches 12 inches
Width: (KSR and RO)	16-1/2 inches
Height: (KSR and RO)	10 inches
<u>Functional Characteristics:</u>	
Power requirements:	
<u>50-Hertz Synchronous Motor</u>	
Input Voltage	115 VAC; Single-Phase
Input Current - Starting Running	9 amps 2.4 amps
Power Output	1/20 HP @ 3000 RPM
Power Consumption	107 Watts
Heat Dissipation	70 Watts
Protection	Thermal Cutout
<u>60-Hertz Synchronous Motor</u>	
Input Voltage	115 VAC; Single-Phase
Input Current - Starting Running	9 amps 1.9 amps
Power Output	1/20 HP @ 3600 RPM
Power Consumption	65 Watts
Heat Dissipation	50 Watts
Protection	Thermal Cutout

Table 1-2. Reference Data - Continued

Operating Speeds:

Unit Code;	7.00
Baud (bits per second);	45.5, 50.0, 75.0
Words per minute (wpm)	65.0, 71.4, 107
Unit Code;	7.42 (60 Hz motor)
Baud (bits per second);	45.5 50.0 74.2
Words per minute (wpm);	61.3 67.4 100
Unit Code;	7.42 (50 Hz motor)
Baud (bits per second);	45.5, 50.0, 74.2
Words per minute (wpm)	61.3 67.4 100

Signal line requirements:

0.020 - 0.060 amps

ESA 0.5 Amp Power Supply

Input	100 to 130 VAC, 45 to 66 Hz. Nominal Power: 55 watts at 115 VAC for 25 watts output.
Output	(a) +47 to +53 VDC at 0.5 amp max (b) +6.6 to +7.8 VDC at 0.018 amp max (c) -6.6 to -7.8 VDC at 0.018 amp max
Operating Temperature	+40° to +100°F with cooling fan in cabinet
Fusing	(a) ac-0.8 amp slow-blowing (TP162360) (b) dc-0.5 amp fast-blowing (TP131807)

Table 1-3. Equipment Matrix - Model 28 Compact Page Printer (CPP) Teletypewriter Sets - High-Level

NAVY DESIGNATION		COVER		KBD/BASE			TYPING UNIT			MOTOR		GEARS					(CONFIGURATION IDENTIFICATION)		
MANUFACTURERS DESIGNATION		LPC400BR (KSR)	LPC401BR (RO)	LLK2CRL (KBD)	LLK2CRM (KBD)	LLB (RO)	LP111RE/AJF	LP111RN/AJG	LP111RN/AY	LP111WY/AJG	LMU37 (60 Hz)	LMU51 (50 Hz)	145365 (60 Hz MTR)	145366 (60 Hz MTR)	304668 (50 Hz MTR)	304669 (50 Hz MTR)	198576 (DISTRIBUTOR)	198580 (DISTRIBUTOR)	
WIRING AND SCHEMATIC DIAGRAMS		FIG. 5-3	FIG. 5-3	FIG. 5-4	FIG. 5-4		FIG. 5-6	FIG. 5-6	FIG. 5-6	FIG. 5-6	FIG. 5-7	FIG. 5-7							
EQUIPMENT																			
KSR	AN/UGC-20	X		X					X			X	X				X	X	(VSL500BR)
	AN/UGC-20A	X		X				X			X	X	X				X	X	(VSL529BR)
	AN/UGC-20X	X		X					X			X	X	X	X		X	X	(BSL510BR)
	AN/UGC-43(WX)	X			X		X			X		X	X	X			X	X	
RO	AN/UGC-25		X			X			X			X	X						(VSL501BR)
	AN/UGC-25A		X			X			X			X	X						(VSL530BR)
	AN/UGC-25AX		X			X			X			X	X	X	X				(VSL509BR)
	AN/UGC-25X		X			X			X			X	X	X					
	AN/UGR-4(WX)		X			X			X			X	X	X					

Table 1-4. Equipment Matrix - Model 28 Compact Page Printer (CPP) Teletypewriter Sets - Low-Level

NAVY DESIGNATION		COVER	ESA/CIRCUIT CARD										KBD/BASE		TYPING UNIT		MOTOR		GEARS				(CONFIGURATION IDENTIFICATION)			
			WDP	LPC403BR (KSR)	LPC402BR (RO)	323120 (KSR)	323121 (KSR)	321231 (RO)	321290 (PS)	323810 (SMD)	333069 (CMD)	323130 (LLK)	LLK4 (CRM) (KBD)	LLK4 (CRS) (KBD)	LLB5 (BR) (RO)	LP139RE/AJF	LP139WY/AJG	LP156RE/AJG	LP156WY/AJG	LMU 37 (60 Hz)	LMU 51 (50 Hz)	145365 60 Hz MTR		145366 60 Hz MTR	304668 50 Hz MTR	304669 (50 Hz MTR)
EQUIPMENT		FIG. 5-12	FIG. 5-11	FIG. 5-19 5-20	FIG. 5-23 5-24	FIG. 5-13 5-14	FIG. 5-15 5-16	FIG. 5-17 5-18	FIG. 5-21 5-22	FIG. 5-25			FIG. 5-26	FIG. 5-27	FIG. 5-27	FIG. 5-29	FIG. 5-29	FIG. 5-7	FIG. 5-7							
KSR	AN/UGC-77	0123	X		X	X		X	X	X	X	X					X	X			X	X		X	X	(28RFH8001A/003/AAA/BR) 8728WD-A(4), 8719WD-S(a)
	AN/UGC-91(WX)	0123	X		X	X		X	X	X	X	X					X	X			X	X		X	X	(28RFH8001A/001/AAA/BR) 8728WD-A(4), 8719WD-S(a)
RO	AN/UGR-9	0029		X			X	X	X				X		X			X			X	X				(28RFH8000B/003/AAA/BR)
	AN/UGR-9X	0029		X			X	X	X				X		X			X			X	X				(28RFH8000B/003/AAA/BR)
	AN-UGR-16(WX)	0029		X			X	X	X				X		X			X			X	X				(28RFH8001B/001/AAA/BR)

Table 1-5. Equipment Required But Not Supplied

Category	Recommended Equipment	Alternate	Equipment Test Parameters	Application
Telegraph Signal Generator	Test Set, Telegraph AN/UGM-8B(V).	Equivalent	Provides controlled signals, both distorted and undistorted, at all commonly used transmission speeds and code formats. Refer to NAVSHIPS 0967-378-4010	Maintenance, Troubleshooting
Telegraph Signal Analyzer	Test Set, Telegraph TS-2616/UGC	Equivalent	Measures timing distortion in start/stop and synchronous data telegraph signals. Refer to NAVSHIPS 0969-125-8010.	Maintenance, Troubleshooting
Volt-ohm-milliammeter	Multimeter AN/USM-311	Equivalent	AC voltage - 115, 5.6 DC voltages - 120, 6.0 Direct Current - 60 mA Resistance - Continuity measurements	Maintenance, Troubleshooting
Tools	Teletype Repair Kit TK-188/U	Equivalent		Maintenance, Repair

