

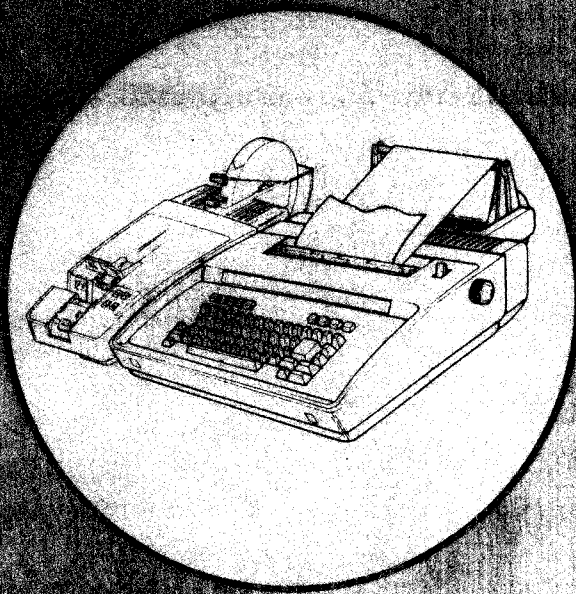

TELETYPE
CORPORATION



TELEX BASIC
KSR and ASR

the **42** teleprinter

SUPPLEMENTARY-HOW TO OPERATE



TELETYPE CORPORATION
5555 Touhy Avenue, Skokie, Illinois 60077
Telephone: (312) 982-2000

SUPPLEMENTARY-HOW TO OPERATE MANUAL 516
Issue 1, March 1982

INTRODUCTION

This manual provides detailed information about your Model 42 Telex Teleprinter. It includes information on connections, power turn on, and off-line operation such as all the keyboard, punch and reader controls and indicators, explanation of options, option programming and some trouble analysis. This manual is supplemental to the Introductory How to Operate manual.

The Introductory How to Operate, Manual 517, provides information on how to perform the basic communication functions of the teleprinter. The procedures in that manual are presented in an easy to follow, step by step format and should be performed by the new operator as an introduction to the teleprinter.

For infrequent use, a Simplified Reference Guide, Manual 572 is provided for both new or experienced operators.

Your 42 Teleprinter Keyboard Send Receive (KSR) or Automatic Send Receive (ASR) Terminal for Telex application is compatible with domestic and international Telex systems.

The ASR Teleprinter provides character-at-a-time keyboard-printer send-receive operation and has the capability of preparing punched paper tape off-line, for later transmission on-line from the paper tape reader. In the on-line mode, the punch along with the printer can copy all received data. The punch and reader can also be controlled on-line by character sequences.

Transmission speeds are 45, 50, 56, 75, 100, 200 or 225 baud. Different speeds can be optioned by the attendant to match the remote station. Transmitted alphabetic characters will print as upper case characters and received alphabetic characters will print as slightly larger upper case characters.

TABLE OF CONTENTS

INTRODUCTION	1	KEYBOARD	23
CONNECTIONS AND POWER OPERATION	3	Printer Operation	23
Teleprinter	3	MOUNTING	24
PT Unit	4	INSTALLATION	25
KEYBOARD - CONTROLS AND INDICATORS DESCRIPTION	5	INSTALLING PAPER (Friction Feed)	26
PAPER TAPE (PT) - CONTROLS AND INDICATORS (ASR)	10	OPTIONS	27
Punch Controls and Indicator	10	Prepare Options Mode	27
Reader Controls and Indicator	12	Auto String Chaining	28
Paper Tape Controls	14	Option Descriptions	29
Auxiliary Controls	14	User Programmable Option Table	35
TAPE PREPARATION	15	Installer Programmable Option Table	36
Keyboard Entry	15	Customer Installed Option Chart	38
Reader Entry	17	WHEN TROUBLE OCCURS	39
TAPE REPLACEMENT	20	Tape Punch Troubles	40
Loading Prepared Tape in Reader	20	Tape Reader Troubles	40
Installing Paper Tape	21	TELEPRINTER SUPPLIES AND MAINTENANCE	41
CHAD CONTAINER REMOVAL	22	TELETYPE CORPORATION PRODUCT SERVICE AND EDUCATIONAL SERVICES	42

INTRODUCTION (Contd)

The keyboard is used for dialing or call origination. Calls are answered automatically.

Operator training is recommended for the Telex Terminals in addition to instructions in this manual.

On the friction feed printer, messages up to 80 characters per line are printed on 8-1/2 inch wide roll type paper. The roll is held in a support attached to the rear of the teleprinter.

A table describing the user programmable options, prompt mnemonics that are used throughout this manual, and procedures on how to change these options are given in the **OPTIONS** section of this manual.

The Paper Tape (PT) Unit may be located up to 50 cable feet from the teleprinter.

The chad resulting from punching approximately one-half roll of randomly punched tape will fill the small chad collection box.

The ribbon is part of a cartridge that can be readily replaced with the cover open. Replacement ribbon cartridges should be obtained from Teletype Corporation.

Refer to the **TELEPRINTER SUPPLIES AND MAINTENANCE** section of this manual for paper, ribbon, and paper tape (ASR) replacement information.

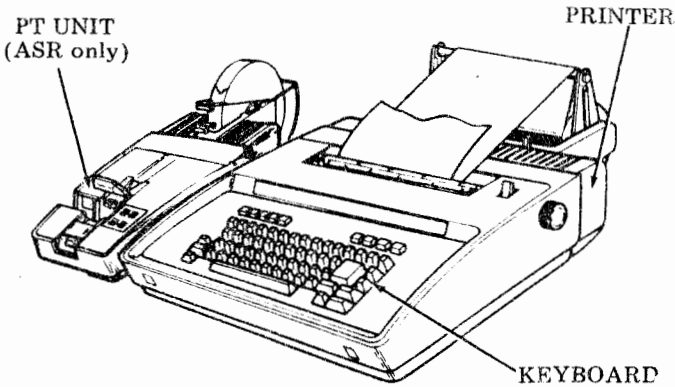

2

CONNECTIONS AND POWER TURN ON

Teleprinter

- Make sure ac power cord, cord to any external communications device, and cord to PT Unit are connected as shown before turning on power.

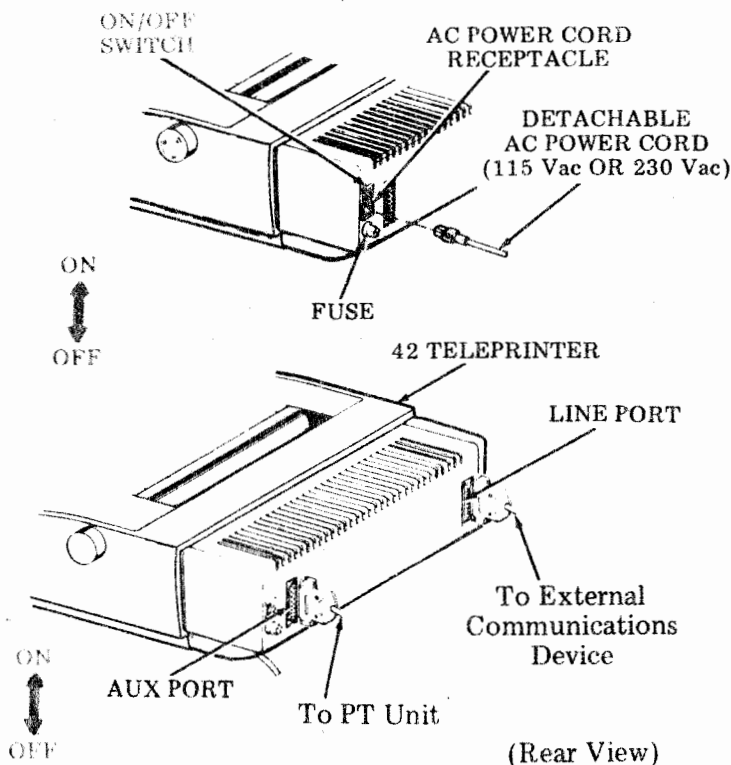

- Turn on power to teleprinter by depressing upper half of ON/OFF switch.

- When power is first turned on, the print head will move fully left and the STOP key on the operator console will light. During normal operation one or more keys should always be lit indicating power is on.

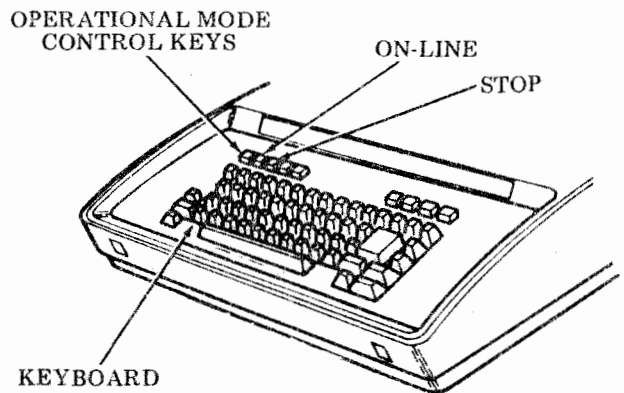

- Power must be left on to automatically answer incoming calls.

3

PT Unit

- Make sure ac power cord and cable to KSR Teleprinter Auxiliary Port are connected as shown before turning on power.

To 42 Teleprinter

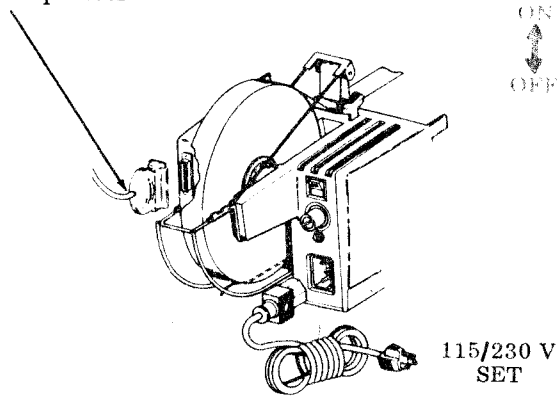

- Power should normally be left on for automatic punch and reader operation on sets so equipped.
- The ASR arrangement will revert to normal KSR operation when the PT Unit power is turned off or the cable is disconnected.
- Telephone calls in the Data mode may be disconnected if power to the PT Unit is turned on or off.

Note: Each time power is turned on, the motor starts. It continues to run for a minimum of 30 seconds if no data is sent or received during that interval.

- Turn on power to PT Unit by depressing upper half of ON/OFF switch.

4

KEYBOARD CONTROLS AND INDICATORS DESCRIPTION

This section describes the purpose and operation of all controls and indicators on the 43 Telex KSR and ASR (KP) set. Most of the operating controls are across the top of the keyboard.

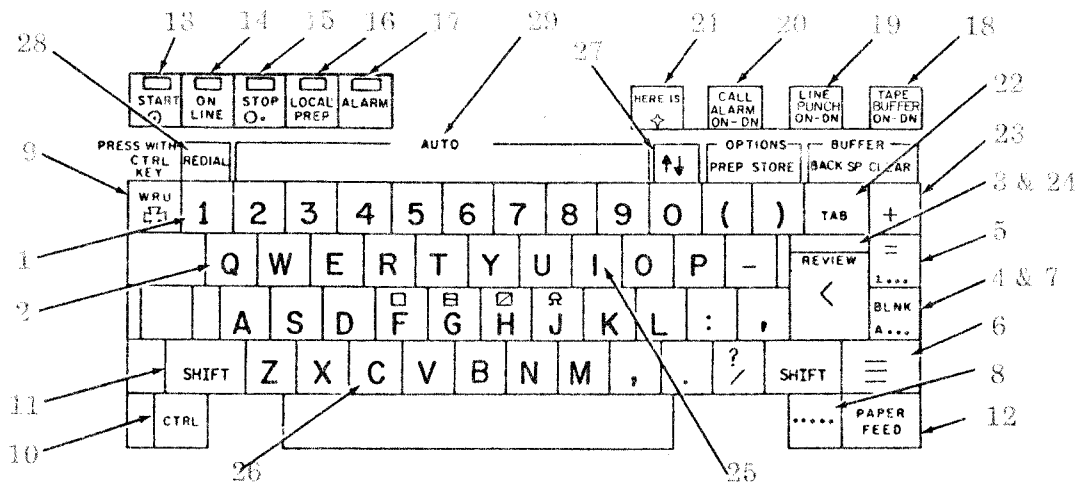













Keyboard Arrangement

1. Numeric Character — Depressing key generates the numeric associated with the key. If in the Alpha mode, the controller will precede the numeric character with a figures shift. If on-line, figures and character will be sent.
2. Alpha Character — Depressing key generates the alpha character associated with the key. If in the Figures mode, the controller will precede the alpha character with a letters shift. If on-line, letters and character will be sent.





3.  Returns printer carriage to the left margin of the current line unless otherwise optioned (< KEY?). Character is sent on-line. Pressing this key will cause the contents of the tape buffer to be punched followed by the reader loading the tape buffer with the next line of data (stopping on a carriage return character) if in the Tape Buffer mode.

KEYBOARD CONTROLS AND INDICATORS DESCRIPTION (CONT.)

4.  (LTRS) — Generates 5-level code for letters. Character is used to precede alpha characters to shift remote device to Alpha mode. Character is sent on-line. Can be used for rubout if punching on paper tape (ASR).
5.  (Figs) — Generates 5-level code for figures. Character is used to precede numeric characters to shift remote device to Numeric mode. Character is sent on-line.
6.  Advances the paper one line for each depression depending on option. Two options effect this key, (≡ KEY?) and DOUBLE LINE FEED. This character is sent on-line.
7.  (SHIFT BLNK) — Generates 5-level code for blank. Can be used to prepare a leader on punched tape (ASR). Character is sent on-line, does not print, but is stored in memory.
8.  (REPT) — This key provides the attendant the ability to cause any key on the keyboard, to repeat by holding the REPT key and the desired key depressed at the same time.
9.  (CTRL WRU) — Figs WRU is sent on-line and  symbol prints locally.
10.  Depress and hold while selected key is depressed to perform special control function on-line. This key is also used during local operations for setting margins, options preparation and load and answer-back.
11.  Used for keyboarding seven shift characters only.

Shift F	<input type="checkbox"/>	sends \$
Shift G	<input type="checkbox"/>	sends &
Shift H	<input checked="" type="checkbox"/>	sends #
Shift J		sends y (will print if optioned y)
Shift /		sends ?
Shift 1 . . .	=	sends =
Shift A . . .		BLNK sends BLANK on line but no symbol is printed.
12.  When key is depressed, printer will perform a local new line. No character is transmitted or stored.

6



13.  Depressing initiates a request to dial. Lamp flashes until a proceed signal is returned from exchange. Lamp lights continuously when proceed signal is received for pulse dialing. If ON-LINE key turns on, wait for the "GO AHEAD" message before Character dialing.
14.  Indicates that the terminal is on-line. In pulse dialing systems this lamp remains OFF until the remote connection has been made. In Character dialing systems this lamp will turn ON before the "GO AHEAD" message is printed. In Private Line systems, this lamp remains ON. This lamp will flash while a request for disconnect is being sent. If the CALL ALARM key is latched down, this lamp will flash while the alarm is being sounded. Pressing the ON-LINE key silences the alarm and turns the lamp ON continuously. If the remote break-in option is selected, this lamp along with the ALARM lamp will flash when a remote break-in is detected. Pressing the key turns the lamp ON continuously and turns the ALARM lamp OFF.
15.  Press to disconnect call or to abort a request for a line. ON-LINE lamp will flash while a call disconnect is being requested. Lamp flashes when in the Prepare Options mode. Press to exit Prepare Options mode, if the changes made are not to be used (AUTO 2 and AUTO 3, will maintain their changes).
16.  Press to enable the Local Preparation mode. Lamp will light. Keyboard, reader, printer and punch will be enabled for local use. Press again to clear the mode. If the machine is in the Local mode when a call is answered, the LOCAL PREP lamp flashes to indicate "seizure" has occurred. The printer will feed out several LF's and will then copy all incoming traffic. Several letter characters are punched if the punch is active. The keyboard and reader will be disabled. Seizure is cleared by pressing the LOCAL PREP key.
17.  Lamp lights due to an alarm condition (ie, low tape, printer self-test, low paper or KP cover open). Clearing alarm conditions turns the lamp OFF. The alarm conditions prevents auto answer (if the low paper and low tape options are set), but will not prevent call initiation.



18.  When this key is down, all data for the punch is placed into a one-line buffer where it can be corrected before it is released to the punch. Entry of a carriage return, line feed, blank, figures or letters shift (from the keyboard) causes the buffer to be emptied to the punch. Entry of a bell character into the buffer requires the print bell option be enabled unless the buffer is empty. Entry of a bell character into an empty buffer when the print bell option is disabled outputs the bell directly to the punch.



19.  When the key is latched in the DOWN position the punch will be allowed to copy an incoming call. If the terminal is seized by the incoming call, the punch will be sent 24 letter characters, followed by the data received from the line. If the call is dropped while the terminal is still seized, an additional feed out of 24 letter characters will be sent to the punch. When this key is latched in the UP position the punch will be kept off all the time the terminal is on-line.



20.  When this key is latched in the DOWN position an incoming call will cause a timed call alarm to be generated until the user silences it by pressing the ON-LINE key (or the LOCAL PREP key if the terminal was seized). Also the external call alarm output (pin 19 of the main EIA connector) will be activated. Dropping the call does not silence the alarm.



21.  Pressing this key causes the answer-back to be generated. Up to 31 characters can be coded in the answer-back option.



22.   When preparing the message using the on-line tape buffer, pressing these keys causes the printer to line feed once and backspace the print head so that the silver line on the print head points to the first character to be corrected. Pressing the backspace additional times backs up the print head without any additional line feeds. When the print head reaches the left boundary, pressing backspace will cause the bell to ring.



23.   Pressing these keys causes the buffer to be cleared and causes the printer to carriage return and line feed.

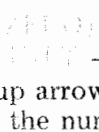

24.   Pressing these keys will cause the contents of the buffer to be printed out up to the current position of the print head. The print head will point to the next position to be entered in this buffer.

25.   Pressing these keys will cause the contents of the tape buffer to be punched, carriage return and line feed will be punched, and the reader will be prevented from loading the next line of data. This allows the addition of one line of characters when editing a previously prepared tape. Pressing this key with an empty tape buffer causes a CR/LF to be sent to the punch.

26.   Pressing these keys causes the buffer to be cleared, the printer to carriage return and line feed, the reader will be prevented from loading the next line of data. This allows the changing of one line of characters when editing a previously prepared tape.

27.    This is shown as an up arrow and a down arrow on the strip between the number row and the control row. Pressing these keys changes the sense of all the shift flags in the machine. This can be used while on-line to attempt to read incoming garble due to a missed shift code or can be used to read a tape with a missing shift code.

28.   Pressing these keys will cause the set to dial the last number called.

29.   through  (AUTO) — These keys can be used for automatic dialing or automatic message generators depending how they are optioned. AUTO 2 and 3 can be coded for up to 63 characters but these characters will be lost if power is turned OFF. AUTO 4 through 9 can be coded for up to 19 characters and are stored in memory. AUTO 9 can be used for message numbering and referred to from the message reader option. Also the last character may point to another AUTO string.

PT Unit indicator when lit indicates power is applied to the PT Unit.

Punch Controls and Indicator

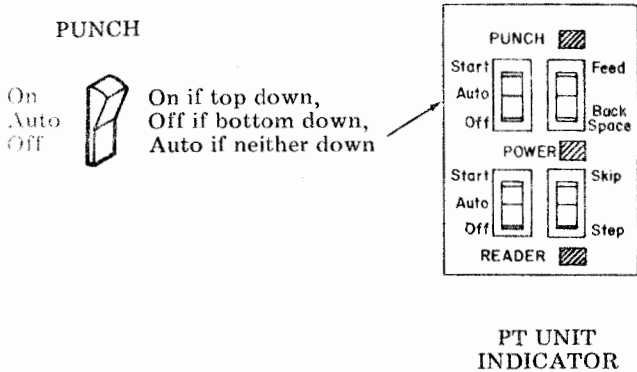

ON
The punch functions as an extension of the printer. In the ON position, the punch responds (perforates tape) to all data outputted to the printer whether on-line or local. In the ON position, the punch will not respond to punch OFF sequence option.

AUTO
In the AUTO position, the punch will automatically start upon receipt of the punch ON sequence option (CCCC is the default value). In the term On-Line mode, the punch will start on receipt of the ON sequence received from the line or from the keyboard. If the KP is in the Local Prep mode (terminal off-line), the keyboard or reader can start the punch (punch ON sequence).

If the punch receives a OFF sequence (FFFF is the default value), while operating on-line, from the line, keyboard or reader, the punch will stop on receipt of a punch OFF sequence from the keyboard or reader.

Note: The punch will not respond to character sequences keyboarded into the buffer.

● **OFF**

Operation of the OFF position stops the punch if it is operating. Any data received while the switch is off will not be punched. Punch will not respond to punch ON sequence.

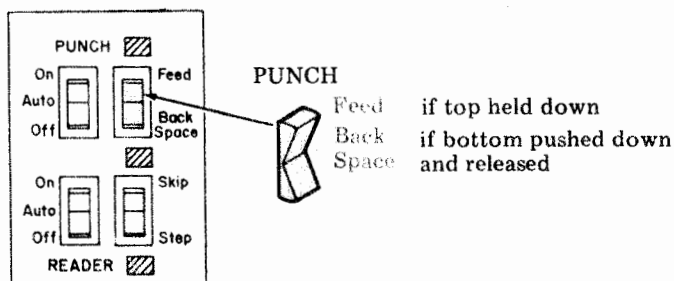

● **FEED**

Operation to the FEED position causes the punch mechanism to continuously perforate only the sprocket hole and to advance the blank tape as long as the switch is held operated. This operation may be used to prepare "leaders" for separating messages in the tape, or for initiating tape feed when a new supply of tape is entered into the punch. Cannot be operated with punch in AUTO position.

Note: Data may be lost if the switch is operated to feed while data is being received and punched.

● **BACKSPACE**

Operation to the BACKSPACE position causes the tape to be reverse feed one space position for each

operation. No code holes are punched. More than ten successive operations are not recommended. Cannot be operated with punch in AUTO position.

Note: The tape may be damaged and/or data lost if the switch is operated to backspace while data is being received and punched.

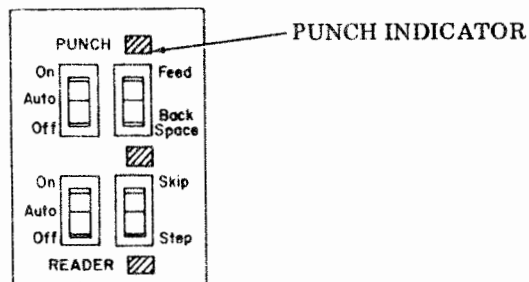

Indicator is lit steadily whenever the punch is conditioned to perforate tape.

- ON/AUTO/OFF switch in ON position.
- ON/AUTO/OFF switch in AUTO position and after receipt of the punch ON sequence but before receipt of the punch OFF sequence.

Indicator blinks on and off

- If the tape supply is low with the punch control switch in either the ON or AUTO position.

READER



On if top down,
Off if bottom down,
Auto if neither down

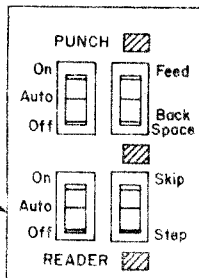

mode, the reader will start on receipt of the reader ON sequence received from the line or from the keyboard.

If the KP is in the Local Prep mode the keyboard can start the reader (reader ON sequence). The reader will transmit locally.

When running, the reader will stop on a tight tape or tangled tape condition and will restart upon removal of the condition. The reader will stop upon sensing the reader OFF sequence option (AAAA is default value) in its tape. Up to six additional characters may be read after the reader OFF sequence, therefore six blank characters should be placed on the tape following the reader stop code. If a WRU character is encountered in the tape in the On-Line mode, the reader will stop. Six blank characters should be placed after a WRU character in the tape. The reader will also stop when tape runs out or tape lid is opened. If tape lid is opened while reader is running, loss of characters may occur.

OFF

Operation to the OFF position stops the reader if it is operating, and prevents further response to control signals. Restarting is possible in the middle of a message, without loss of data, if the reader gate is not opened.

ON

Operation to the ON position causes the reader to continuously step and sense tape (provided tape has been properly placed in reader). When running, the reader will stop wherever and as long as a tight or tangled tape condition occurs, and will restart upon correction of the condition. It will stop completely if the tape lid is opened or the tape runs out or fails to advance. To restart, see Note below.

Note: Operate switch to the OFF position before opening tape lid to correct condition. Opening of the reader tape lid while transmission is temporarily interrupted may cause loss of characters so the tape should be backed up and restarted at the beginning, the tape lid should be closed and switch operated to the ON position.

AUTO

In the AUTO position, the reader will automatically start upon receipt of the reader On sequence option (SSSS is default value). In the term On-Line

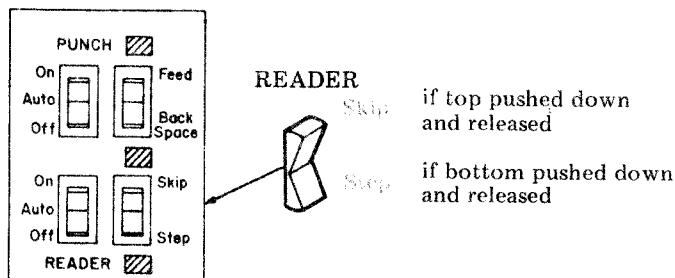

SKIP

With the reader control switch OFF operation to the SKIP position causes the tape to advance one character space, but the character will not be transmitted.

STEP

With the reader control switch OFF operation to the STEP position causes the reader feed mechanism to advance one character space, and if tape is present and has moved, causes the transmission of the character in the gate locally or on-line. No action will occur if the reader gate is open, no tape is present in the gate, or tight or tangled tape is present. If tape is in the gate but does not move, due to torn-feed holes or improper insertion, the feed mechanism will operate once, but no character will be transmitted.

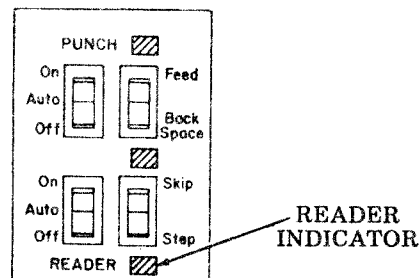

Indicator is lit steadily whenever the reader is conditioned to read tape.

ON/AUTO/OFF switch in ON position and with tape being sensed.

ON/AUTO/OFF switch in AUTO position and after receipt of reader ON sequence but before sensing the reader OFF sequence in the tape.

Indicator blinks on and off when:

ON/AUTO/OFF switch is in the ON position, and the tape gate is opened, the tape becomes tight or tangled, runs out, or fails to advance.

ON/AUTO/OFF switch is in the AUTO position, after receipt of reader ON sequence but before sensing the reader OFF sequence in the tape and the tape gate is opened, the tape becomes tight or tangled, runs out, or fails to advance.

READER TAPE SENSING ARM
(Provides detection of the tight-tape or tangled-tape condition.)

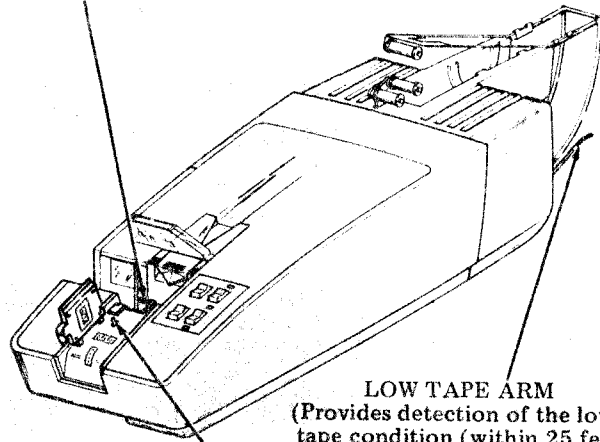

LOW TAPE ARM
(Provides detection of the low-tape condition (within 25 feet of being exhausted).)

READER TAPE SENSING PIN
(Provides detection of the tape-out or open tape-lid condition.)

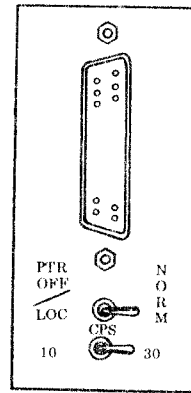





REAR OF UNIT

- PTR OFF/LOCAL/NORMAL SWITCH — Must be in NORMAL position.
- CPS SWITCH — Must be in 30 position.







TAPE PREPARATION

Keyboard Entry

● Non-Buffered





1. Depress  key to turn lamp ON.
2. Depress  key if the DOWN position (must be UP).
3. Load paper and paper tape.
4. Turn ON punch.
5. Depress  and  keys simultaneously for a letters leader in the tape.
6. Keyboard the message.
7. If an error is made, manually depress the back-space switch on the punch the number of times required, so the tape can be over punched.
8. Depress  key for letters to over punch the message in the tape. Continue keyboarding the message.
9. When finished verify the tape by placing it in the tape reader and send to the printer.

● Buffered







1. Depress  key to turn lamp ON.
2. Depress  key to latch in the DOWN position.
3. Turn ON punch.
4. Hold the repeat  key down and depress the LTRS  key for a leader on the tape.
5. Type in the message, checking each line before entering a carriage return. (The contents of the one line buffer is not punched on the tape until a carriage return, line feed, or nonprinting character is entered).
6. If an error is made, hold the  key down and depress the  key to line feed and back-space to the mistake. (This is a destructive back-space function). Retype the remainder of the line. The print head marker will point to the character being changed.

Keyboard Entry

● Non-Buffered

1. Depress  key to turn lamp ON.
2. Depress  key if the DOWN position (must be UP).
3. Load paper and paper tape.
4. Turn ON punch.
5. Depress  and  keys simultaneously for a letters leader in the tape.
6. Keyboard the message.
7. If an error is made, manually depress the back-space switch on the punch the number of times required, so the tape can be over punched.
8. Depress  key for letters to over punch the message in the tape. Continue keyboarding the message.
9. When finished verify the tape by placing it in the tape reader and send to the printer.

● Buffered



1. Depress  key to turn lamp ON.
2. Depress  key to latch in the DOWN position.
3. Turn ON punch.
4. Hold the repeat  key down and depress the LTRS  key for a leader on the tape.
5. Type in the message, checking each line before entering a carriage return. (The contents of the one line buffer is not punched on the tape until a carriage return, line feed, or nonprinting character is entered).
6. If an error is made, hold the  key down and depress the  key to line feed and back-space to the mistake. (This is a destructive back-space function). Retype the remainder of the line. The print head marker will point to the character being changed.

15



Reader Entry

● Non-Buffered

● To delete from a tape:

1. Depress  key to turn lamp ON.
2. Depress  key if in the DOWN position (must be UP).
3. Place tape in reader.
4. Turn punch ON.
5. Stop reader just before area to be deleted.
7. Single step to last good character.
8. Press Skip for each character to be deleted.
9. Repeat until tape is fully duplicated.

● To insert data into a tape:



1. Depress  key to turn lamp ON.
2. Depress  key if in the DOWN position (must be UP).
3. Place tape in reader.
4. Turn punch ON.
5. Turn reader ON.
6. Stop reader just before insert point by depressing reader switch OFF.
7. Single step to the last character before insert by depressing Step switch.
8. Keyboard inserted data.
9. Repeat until tape is fully duplicated.

17

Reader Entry (Contd)



⊙Buffered

●To edit a previously prepared tape using buffer (for advanced users).



1. Depress  key to turn lamp ON.
2. Depress  key to latch in the DOWN position.
3. Place the tape in the reader.
4. Turn reader ON, the first line of data will print out.
5. Turn punch ON.

6. If the line of data is all right, depress  key.

This key should be programmed for CR as its first character in the (< KEY?) option to transfer to the punch. The next line of data will automatically be sent from the reader to the printer and buffer. Blank characters and extra letter and figure characters not at the beginning of a line will be stripped away. If they are necessary, they must be reinserted. Lines with a line feed only do not allow for one line editing. Reading a tape which contains bell characters does not ring the sets bell in this mode.



If the entire line is to be removed, depress  and  key simultaneously to clear the buffer. The reader will automatically read the next line to the printer and buffer.

18

8. If the line is to be changed, hold the  key down and depress the  key to line feed and backspace to the first incorrect character and retype it and the rest of the line. Depress



 key to punch the line. The reader will

automatically read the next line to the printer and buffer.

9. If one or more lines of data is to be inputted to the tape, depress  and  keys simultaneously. The line of data in the buffer will be punched and the reader will stay off so that data can be entered into the buffer from the key-

board. When all the inputting is complete, depress

 key to punch the data. The reader will automatically read the next line to the printer and buffer.

10. If the entire line is to be changed, depress  and  keys simultaneously. The line of data in the buffer will be cleared and a new line can be typed in. Depress the  keys when the

line is completed which sends the buffer to the punch. The reader will automatically read the next line to the printer and buffer.

TAPE REPLACEMENT

Loading Prepared Tape in Reader

To place prepared message tape in the tape reader for transmission, proceed as follows:

- Open tape gate by lifting up on right side.
- Hold tape so pointed end faces you and two larger punch holes are to be left of small feed holes.
- Place tape so that feed holes are over teeth of feed wheel, and so the series of letters or the first character of message is over sensing window.

Note: It is possible to insert the tape upside down and wrong end out. This would cause a completely garbled message.

- Align tape and close gate. Make certain that tape is free to feed into gate without tangling. If tape is tight, transmission will not be possible.

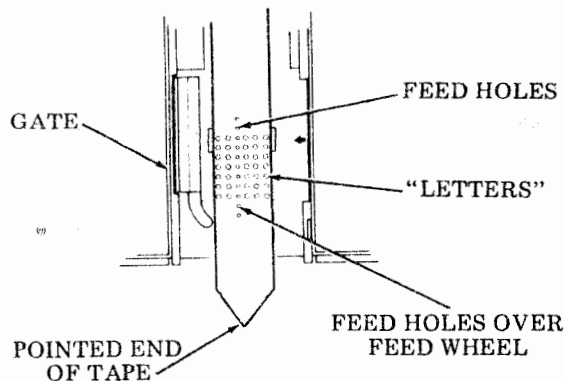
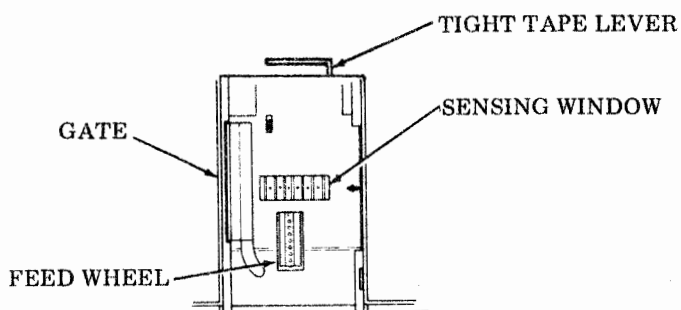

Note: When feeding tape directly from punch to reader, tape must be routed under tight tape arm and enough slack must be left in tape to prevent lever from closing tight tape contact.

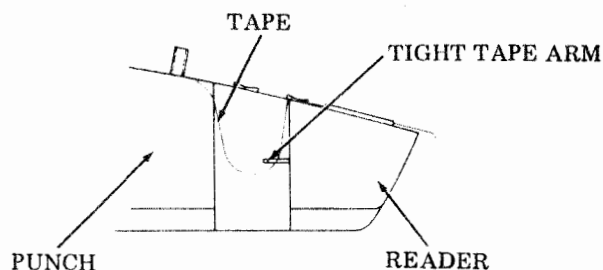

20

Installing Paper Tape

When the tape is low, the punch indicator will flash and the paper tape will change color.

- Operate left punch control switch to OFF position.
- Tear off old tape (if present) at entrance to punch.
- Feed out tape in punch (if present) by operating and holding right punch control switch to feed position.

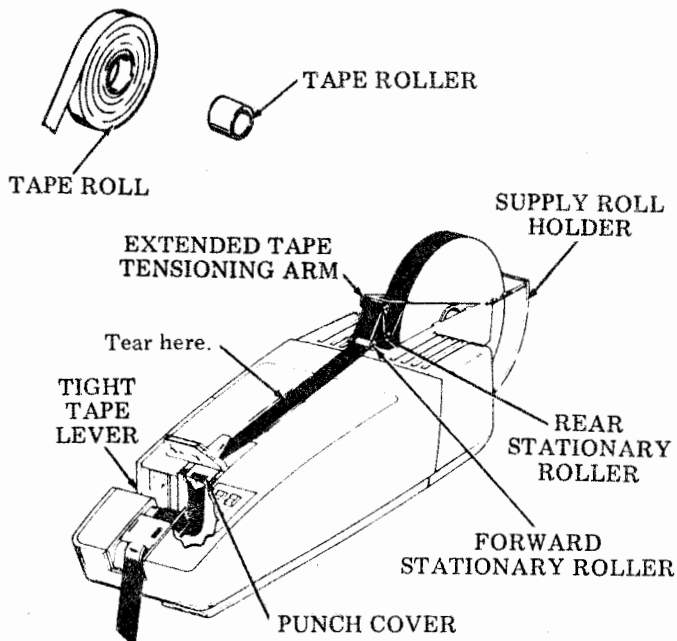

- Lift used roll out of supply roll holder. Remove but do not discard tape roller from core of old roll.

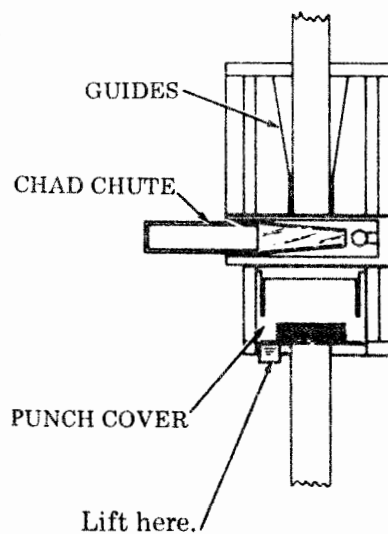

- Insert tape roller in new roll of tape and place roll in holder that tape feeds from top of roll toward the front of set.
- Insert tape under and around the rear stationary roller, over the extended tape tensioning arm, and around the forward stationary roller.
- Open the punch cover and feed the paper tape through the punch. Check to make sure the tape is straight and between the guides. Close the cover.

21

CHAD CONTAINER REMOVAL

- A plastic chad container is located under and to the left of the punch. It catches the chad (paper particles) punched out of the tape as the message tape is prepared.
- Periodically, remove the chad container by pulling the top of the container to the left and lifting up. Empty out the chad and replace the container. The tabs on the bottom of the container fit into the slots of the cabinet.

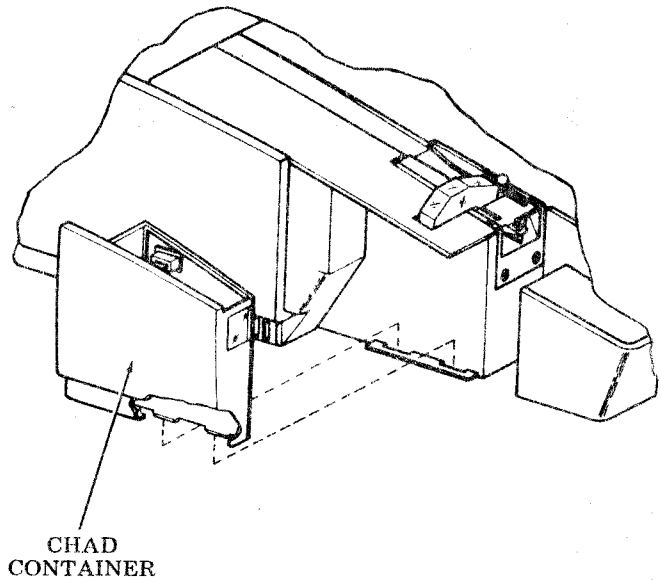

22

KEYBOARD

Printer Operation

- The keyboard-printer can be operated locally with the LOCAL PREP key lit or on-line with the ON-LINE key lit.
- Signal Bell

The signal bell sounds when characters are entered seven characters before and at the right margin.

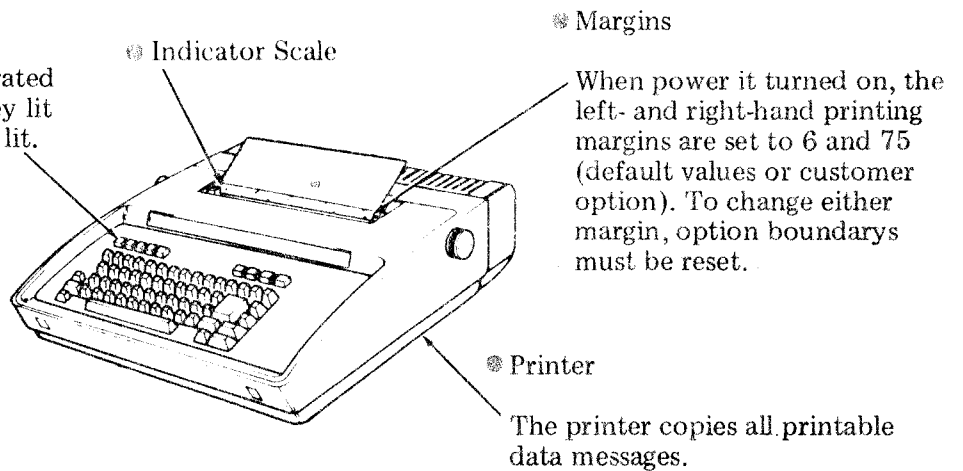

• Margins

When power is turned on, the left- and right-hand printing margins are set to 6 and 75 (default values or customer option). To change either margin, option boundaries must be reset.

• Printer

The printer copies all printable data messages.

The next printing location of the print head and the position for setting left- and right-hand margins is indicated by the print head marker at the print indicator scale. The print head moves back when printing resumes after one second delay. When back spacing (making a correction to the buffer) it points to the character being changed.

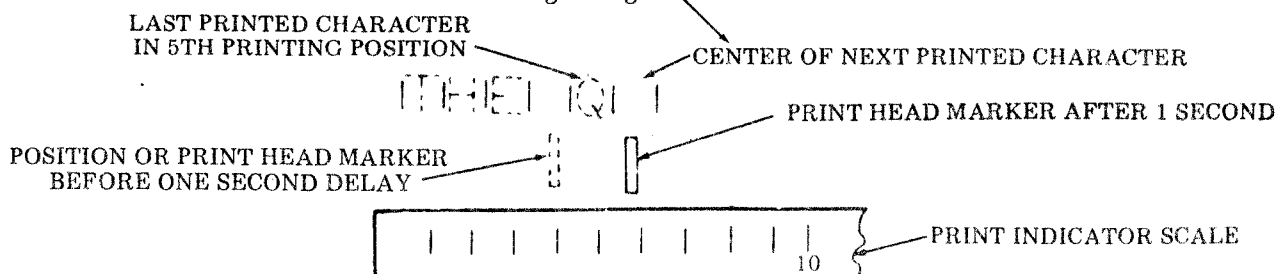

23

ANSWER-BACK

The answer-back feature is a user programmable option. When entered, a message of up to 31 characters can be sent manually or automatically.

The answer-back may be sent automatically in response to receipt of the WRU character.

The answer-back can be generated manually by

depressing  :

• If the terminal is on-line the answer-back is transmitted on-line and prints locally.

• If the  key is on, the answer-back will print locally.

24

INSTALLING RIBBON

- ① Center print head and open cover. ALARM lamp lights.
- ② Remove and discard cartridge with used ribbon by grasping and lifting the cartridge. This applies only when changing a ribbon.
- ③ Pull print head locking lever back (towards keyboard) as far as it will go.
- ④ Place new ribbon around the outside of rollers.
- ⑤ Pull on cartridge to the right and pass ribbon between print head and rollers (see Routing Diagram below).
- ⑥ Place ribbon cartridge on the right-hand bracket and allow magnet to pull cartridge down into place. Make sure it is down.
- ⑦ Position print head against ribbon. With thumb on top of the print head, push the print head toward the platen, then move locking handle fully to the rear.
- ⑧ Using thumb, push locking lever toward platen until it snaps into place.
- ⑨ Close cover.

430035
CARTRIDGE
WITH RIBBON

COVER RELEASE
(2 Places)

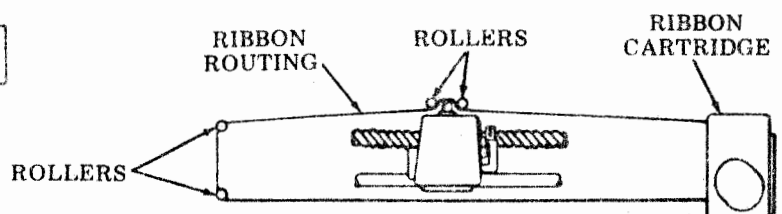

Note: Make sure ribbon is fully seated on all four rollers before closing cover.

Routing Diagram

INSTALLING PAPER (Friction Feed)



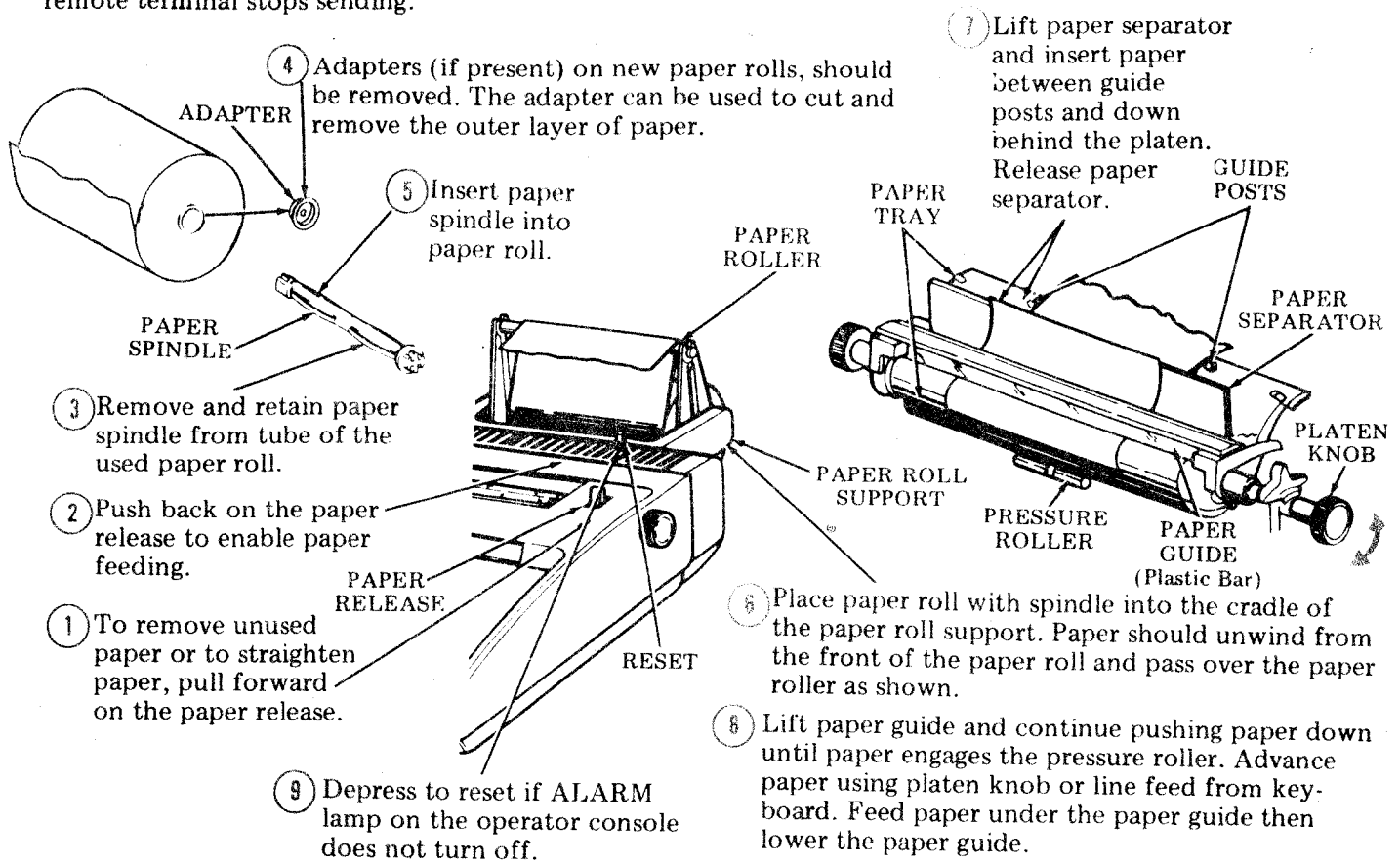









- Install paper as shown after removing the unused paper from the printer. It is not necessary to turn off power or open the cover when replacing the paper but to avoid loss of data, paper should be replaced after the remote terminal stops sending.



26

OPTIONS

Prepare Options Mode:

1. Take the terminal off-line and out of the Tape Buffer mode by depressing the  key and the  key if in the DOWN position.
2. Depress the  key while holding the  key down to put the terminal into prep options.
3. Depressing the  key while holding down the  key (NEXT) advances to the next option.
4. Depressing the  key while holding down the  key (UP) returns to the previous option.
5. Depressing the  key while holding down the  key returns to the beginning of the list.
6. The editing features of the tape buffer are available for preparing options (REVIEW, BACKSPACE, CLEAR).
7. The option can be changed by simply typing in the new value for the option. (Error messages help you if any mistakes are made.)
8. Load the options by depressing the  key while holding down the  key. (Depressing the  key will abort the Options mode without changing the options that are stored in the nonvolatile memory. AUTO 2 and AUTO 3 will be updated.)

Auto String Chaining

The last character of an auto string may be a pointer to another auto string which will cause the 2nd auto string to be printed, ie, depressing the key for the first auto string will cause the first string and the second one to be printed. The pointer will not be printed. More than two auto strings may be chained. An auto string may only call another auto string whose number is greater than the calling auto string's number. Procedure to chain auto string:

1. Enter prep options.
2. Type desired text for auto string. Save on character space.

3. Press CTRL key and number of the desired auto string at the same time. The printer will print "number backspace one". (eg, **2, 3**). This is a visual pointer to the auto string which will be "chained" to the auto string just entered.

4. Proceed to the auto string selected above and type in desired text. This auto string may also be "chained" to another, whose auto string number is higher.

5. Load prep options.

28

Option Descriptions

AUTO 9 (Message Numbering)

AUTO 9 can be used for message numbering. When AUTO 9 is activated, the first number in the string is incremented before the string is printed or transmitted. The number can be up to five digits in length. Any nonnumeric character in the string after the first numeral indicates the end of the message number. Numerals later in the string are not effected.

When the message number is four digits or less, it will reset to one on the next increment when each of the digits reaches nine. For five digit numbers, this reset operation occurs after the number reaches 65530. Throughout the message numbering operations, the number retains the same number of digits it was initialized to with leading zeros used whenever necessary.

To initialize the message number, enter a numeral anywhere within AUTO 9 in the Prep Options mode using leading zeros when necessary to set the number of digits. Any of the other strings can be chained to AUTO 9 to provide a variable format. Only the first number in AUTO 9 will be incremented.

If AUTO 9 has no number in it or if the first number is greater than five digits in length, no number incrementing is performed.

Send Header Sequence

When a character sequence is entered for this option, the terminal will stop the reader and transmit the message header (if that option is enabled) and then restart the reader, if this sequence was transmitted on-line.

Message Header

This option has three accepted values (8 or 9 or 0). An entry of 8 or 9 enables the option and specifies the auto string sent when the auto header sequence has been transmitted on-line. The main application of this option is to send the message number format. To allow for variable message number formats, AUTO 8 chained to AUTO 9 or AUTO 9 alone can be used for message numbering. Therefore both these strings can be used as the message header. If AUTO 8 is enabled for this option and AUTO 9 is chained to AUTO 8, both strings will be sent.

A fixed message can be configured by setting the option to 8 and not using the message number feature of AUTO 9.

Setting this option to "0", disables the option.

< KEY?

Specifies a character or character sequence that is generated when the oversize key with the carriage return symbol is depressed. One, two or three characters may be specified for this key. The two or three character sequence will be generated in the same order as specified.

≡ KEY?

Specifies the single character which is generated when the key with the line feed symbol is depressed.

HZTAB

The printer will tab the number of spaces coded in this option starting at the left boundary setting and are evenly spaced across the page to the last stop before the right boundary setting.

Double Line Feed

A "Y" response enables the printer to generate two line feed characters for every single line feed character that is to be printed.

Speed

The printer can be optioned to operate at the following baud rates - 45, 50, 56, 75, 100, 200 or 225. The upspeed rate is always 200 baud.

Upspeed Sequence

This is a character sequence option of up to four characters. The option is enabled when any sequence is entered in the option list. When on-line, if the sequence is detected by the terminal from either a remote or local source (but no combination of the two), the terminal will switch to 200 baud.

Downspeed

This is a character sequence option of up to four characters. The option is enabled when any sequence is entered in the option list. When on-line, if the sequence is detected by the terminal from either a remote or local source (but no combination of the two), the terminal will switch to the baud rate specified in the speed option of the option list.

Print Bell Symbol

When "Y", the bell symbol will be printed for the "Bell" code. When "N", the bell sounds but the symbol is not printed.

Receive Only

When the option is "Y", the terminal can only be used on-line to receive messages. The terminal will auto answer if all criteria are met. It is not able to initiate calls.

Reader Pacing

When "Y", the terminal will permit external control of the R/T when on-line.

Remote Break In

When "Y", enabled, all received characters are compared to transmitted characters from the reader. If 15 characters do not agree, the reader is disabled, and the ON-LINE and ALARM lamps are flashed. Pressing the ON-LINE key reenables the reader.

Send Blind

When "Y", enabled, on-line transmission is not printed locally. All received characters are printed. This option permits full duplex operation on-line with the terminal. The S/R distinction option should be set to "N" (no) for correct paper copy of the received message in full duplex operation.

Automatic CR/LF

When "Y", enabled, a carriage return and line feed is automatically generated at the right margin on all locally generated characters. This option is not functional during an answer-back message.

Auto Disconnect Sequence

When a character sequence is entered for this option, the terminal will request a disconnect after this sequence is transmitted on-line.

Punch, Reader, ON-OFF Sequence

When a four character sequence is entered for these options, the reader and punch will be controlled ON-OFF whenever these codes sequences are transmitted or received and the punch and/or reader is in the AUTO mode.

Left Boundary

The option value is the number of nonprint columns to the left of each line. This number is independent of margin settings and is the number used when margins are cleared. Maximum value allowed is 79.

The value for the left boundary must be less than the right boundary.

Right Boundary

The option value is the print column which is the right limit for printing. Maximum value allowed is 80.

Break On Out Of Service

When "Y", the terminal will send continuous break (open loop) on the line when it is in an out of service condition. Out of service is defined as a condition when the terminal is in the Prep Option mode.

PRVT Line

When "Y", the terminal does not respond to a connect or disconnect on the line. The user depresses the START key on power up to put the terminal on-line. To access the Local modes of operation, the user depresses the STOP key to put the terminal off-line. (The SD and DTR leads remain in the idle on-line state). Now the user can access the Local modes in the usual fashion by depressing the LOCAL PREP key. After finishing local preparation, the user depresses the START key to place the terminal back on-line.

Depressing the START key sends the terminal directly to the connect state bypassing the usual dialing states. With this option enabled, transmission of the auto disconnect sequence updates the message header and character meter instead of disconnecting the line. It is also updated when the terminal is taken off-line by depressing the STOP key or going into prep options. Note also for proper private line operation, the send break option should be set to zero so no break on the line occurs by going into the Local modes by depressing the STOP key.

Low Paper

When "Y", a low paper condition will prevent answering calls. This option does not affect the ALARM lamp operation by low paper.

Low Tape

When "Y", a low tape condition on an associated paper tape set with the punch on will cause the same alarm condition as low paper.

S/R Distinction

When "Y", the sending printing will be slightly smaller than the receive printing. When "N" both send and receive printing will be the same size.

Connect Delay

The decimal value up to 9999 for the time in milliseconds that the transmitter is disabled after a valid connect. Default value is 1700 (1.7 seconds).

Disconnect Delay

The decimal value up to 9999 for time in milliseconds for the minimum break (space hold) that defines a disconnect. The minimum value allowed is 150 ms. Default value is 1000 (1 second).

Busy Pulse Width

The decimal value up to 999 for the maximum on time of DR in milliseconds to be recognized as a busy signal. Default value is 300. If the busy pulse is longer than 999 ms. the busy signal will not be generated.

Send Back Timer

The decimal value up to 9999 for the time in milliseconds SD will go spacing on a send break signal. Default value is 3000 (3 seconds).

Option Descriptions (Contd)

Protocol

Any one of six protocols can be used. The most commonly used and default value is one. This is a system requirement.

- 1 - Neutral Loop
- 2 - RCA Neutral Loop
- 3 - Modem or Polar Line
- 4 - RCA Modem or Polar Line
- 5 - Peoples Republic of China
- 6 - Cable and Wireless

Answer-Back

A character sequence of up to 31 characters may be specified and must contain all the LTRs And FIGs shift codes along with CR and LF. A sample format is as follows:

$\begin{matrix} S \\ I \end{matrix} < = A B C D E F G \wedge X Y \begin{matrix} S \\ O \end{matrix} 1 2 3 4 5 \begin{matrix} S \\ I \end{matrix} < =$

When \wedge = Space

$\begin{matrix} S \\ I \end{matrix}$ = LTRs Shift

$\begin{matrix} S \\ O \end{matrix}$ = FIGs Shift

< = Carriage return

\equiv = Line Feed

ABC. . = Subscriber Name

123. . = Call Number of Subscriber

XY = Telex Network Identification Code

Character Meter

This meter prints out a number at the end of the options list. It is a read only value and cannot be changed. The number indicates how many print cycles the machine has completed. The meter will return to zero every 327.68 million characters.

User Programmable Option Table

<u>PROMPT</u> <u>MNEMONIC</u>	<u>PRINTED</u> <u>DEFAULT</u> <u>VALUE</u>	<u>OPTION</u>	<u>DESCRIPTION</u>
AUTO 2	None	Code for CTRL 2 Key	Up to 63 Characters
AUTO 3	None	Code for CTRL 3 Key	Up to 63 Characters
AUTO 4	AUTO 4	Code for CTRL 4 Key	Up to 19 Characters
AUTO 5	AUTO 5	Code for CTRL 5 Key	Up to 19 Characters
AUTO 6	AUTO 6	Code for CTRL 6 Key	Up to 19 Characters
AUTO 7	AUTO 7	Code for CTRL 7 Key	Up to 19 Characters
AUTO 8	AUTO 8	Code for CTRL 8 Key	Up to 19 Characters
AUTO 9	AUTO 9	Code for CTRL 9 Key	Up to 19 Characters
		Can be Used for Message Numbering.	0 through 00000 will be Incremented (First Set of Digits Only)
NONE	0	Message Header - will SEND AUTO 8, AUTO 9 or nothing (if 0)	8, 9 or 0
< KEY?	CR	Codes for Return Key	1, 2 or 3 Characters
\equiv KEY?	LF	Codes for Line Feed Key	1 nonprinting Character
HZTAB	10	Horizontal Tab Spacing	2 Numerals
NONE	N	Double Line Feed	Y/N

Installer Programmable Option Table

<u>PROMPT NMEMONIC</u>	<u>PRINTED DEFAULT VALUE</u>	<u>OPTION</u>	<u>ENTRY</u>
NONE	50	Speed (Baud)	45, 50, 56, 75, 100, 200 or 225
NONE	06	Left Boundary	2 Numerals
NONE	75	Right Boundary	2 Numerals
NONE	N	Continuous Break Sent On-Line When Out-of-Service	Y/N
PRVT	N	Private Line	Y/N
NONE	Y	Low Paper (prevent answering calls)	Y/N
NONE	N	Low Tape (prevent answering calls)	Y/N
NONE	Y	S/R Distinction	Y/N
NONE	Y	Print Bell Symbol	Y/N
NONE	N	Receive Only	Y/N
NONE	N	Reader Pacing (external control of the P/T when on-line)	Y/N
NONE	N	Remote Break-In	Y/N
NONE	N	Send Blind	Y/N
NONE	N	Automatic CR/LF	Y/N
NONE	Not Enabled	Send Header Sequence	Up to 4 Characters
NONE	Not Enabled	Auto Disconnect Sequence	Up to 4 Characters

36

Installer Programmable Option Table (Contd)

<u>PROMPT NMEMONIC</u>	<u>PRINTED DEFAULT VALUE</u>	<u>OPTION</u>	<u>ENTRY</u>
NONE	FFFF	Punch OFF Sequence	Up to 4 Characters
NONE	AAAA	Reader OFF Sequence	Up to 4 Characters
NONE	CCCC	Punch ON Sequence	Up to 4 Characters
NONE	SSSS	Reader ON Sequence	Up to 4 Characters
NONE	Not Enabled	Upspeed Sequence	Up to 4 Characters
NONE	Not Enabled	Downspeed Sequence	Up to 4 Characters
NONE	1700	Connect Delay (1.7 seconds)	4 Numerals (0 to 9999)
NONE	1000	Disconnect Delay (1.0 seconds)	4 Numerals (150 to 9999)
NONE	300	Busy Pulse Width (0.30 seconds)	3 Numerals (0 to 999)
NONE	3000	Send Break Timer (3.0 seconds)	4 Numerals (0 to 9999)
NONE	1	Protocol	1, 2, 3, 4, 5 or 6
NONE	<≡↓ Teletype Model ↑ 42	Answer-Back	Up to 31 Characters
-	-----	Character Meter (Not an option - Just indicates how many print cycles has been completed).	

Tape Punch Troubles

If tape punch does not operate properly, check for the following conditions:

- ⊛ Is the chad box completely filled so that chad cannot leave chad chute?
- ⊛ Is tape piled up and jammed at tape punch exit?
- ⊛ Is tape feeding properly into punch guides without getting jammed at entry point?
- ⊛ Is tape routed properly through tape supply rollers?
- ⊛ Has the roller been left out of the tape supply roll causing roll to drag or bind?

Tape Reader Troubles

If tape reader does not operate properly, check for the following conditions:

- ⊛ Is tape properly threaded into reader according to instructions?
- ⊛ Is tape tangled or snagged preventing free entry into reader?
- ⊛ Is tape torn, wrinkled, or of incorrect width?
- ⊛ Report as local trouble in tape reader.

TELEPRINTER SUPPLIES AND MAINTENANCE

Ribbon

The ribbon cartridges provided by Teletype Corporation utilize ribbon material chosen for its physical stability and nonabrasive inks which have a lubricating quality. The use of ribbon cartridges without these required properties may reduce print head performance and life in addition to shorter ribbon life.

The ribbon cartridge should be replaced whenever the ribbon becomes frayed or print density becomes light. Ribbons obtained from Teletype Corporation should produce 5 million legible printed characters.

A package of six ribbon cartridges (Part No. 430484) can be ordered from Teletype Corporation, using the order form furnished with each teleprinter.

Friction Feed Paper

Paper for the 42 friction feed teleprinter should be standard 8-1/2 inches wide, single-ply, furnished in 5 inch maximum diameter rolls with a 1 inch diameter spindle hole.

Paper Tape

Paper tape for the PT set must be 11/16 inch wide oiled paper furnished in 8 inch maximum diameter rolls with two inch diameter spindle hole.

This .004 inch thick, 50 pound basic paper may be obtained from suppliers listed below or other suppliers:

Eastern Specialties Co.
287 Northfield Road
P O Box 181
Northfield, Illinois 60093
Cat. No. I 4001
312-446-8780

Moore Business Forms
36 S. Wabash Ave.
Chicago, Illinois 60603
Cat. No. 60016
312-346-4214

On the following page is a list of Teletype Corporation Product Service locations which provide maintenance service and repair on all Teletype Corporation products. For more information call toll free (US 800-323-4226) (IL 800-942-4192) 7:00 A.M. — 4:00 P.M. CST.

In addition, Teletype Corporation provides Customer Technical Training at its headquarters at 5555 W. Touhy Avenue, Skokie, IL in the northwest suburban area of Chicago. The training covers the installation, maintenance and repair of all Teletype Corporation products. Arrangements can also be made for training to be conducted at customer-selected field sites.

For information about class schedules, enrollment, tuition, on-site training or any special training needs, please contact:

Education Services
 Teletype Corporation
 5555 W. Touhy Avenue
 Skokie, Illinois 60077
 Telephone (312) 982-3940
 TLX 25-4051
 TWX 901-223-3611

ALABAMA	BIRMINGHAM	230 OXMOOR CIRCLE SUITE 1113, HOMEWOOD, AL 35209	(205) 942-2574
	MOBILE	3207 INTERNATIONAL DR., SUITE B, MOBILE, AL 36606	(205) 473-8888
ARIZONA	PHOENIX	2113 S. 48TH ST., SUITE 104, TEMPE, AZ 85282	(602) 894-9891
	TUCSON	2015 N. FORBES BLVD., TUCSON, AZ 85705	(602) 623-6419
ARKANSAS	LITTLE ROCK	7501 INTERSTATE 30, SUITE 43, LITTLE ROCK, AR 72209	(501) 562-0266
CALIFORNIA	▲ LOS ANGELES	5445 SHEILA, CITY OF COMMERCE, CA 90040	(213) 728-2222
	OAKLAND	7305 EDGEWATER, SUITE C, OAKLAND, CA 94621	(415) 430-0202
	ORANGE COUNTY	11552 KNOTT, SUITE 9, GARDEN GROVE, CA 92641	(714) 891-2628
	SACRAMENTO	4221 NORTHGATE BLVD. NO. 4, SACRAMENTO, CA 95834	(916) 924-1933
	SAN DIEGO	7283 ENGINEER RD., SUITE B, SAN DIEGO, CA 92111	(714) 565-4375
	SANTA CLARA	3285 KIFER RD., SANTA CLARA, CA 95051	(408) 730-9083
	VENTURA COUNTY	2696 LAVERY COURT, SUITE 1, NEWBURY PARK, CA 91320	(805) 498-9655
COLORADO	▲ COLORADO SPRINGS	905 GARDEN OF THE GODS RD., SUITE B, COLORADO SPRINGS, CO 80907	(303) 593-1222
	DENVER	7100 BROADWAY, BUILDING 3-J, DENVER, CO 80221	(303) 429-9555
CONNECTICUT	▲ HARTFORD	441 GOVERNORS HWY., SOUTH WINDSOR, CT 06074	(203) 568-9610
DIST. OF COLUMBIA	▲ LORTON, VA	9022 TELEGRAPH RD., LORTON, VA 22079	(703) 550-7507
FLORIDA	FT. LAUDERDALE	6858 N.W. 20TH AVE., FT. LAUDERDALE, FL 33309	(305) 974-4660
	JACKSONVILLE	6002 BOWDENDALE AVE., JACKSONVILLE, FL 32216	(904) 739-1170
	MIAMI	12802 S.W. 122ND AVE., MIAMI, FL 33186	(305) 252-1370
	ORLANDO	102 LIVE OAKS BLVD., CASSELBERRY, FL 32707	(305) 834-3818
	TAMPA	5474 JETPORT INDUSTRIAL BLVD., TAMPA, FL 33614	(813) 885-7413
GEORGIA	▲ ATLANTA	2520 PARK CENTRAL BLVD., DECATUR, GA 30035	(404) 981-7267
IDAHOO	BOISE	172 S. COLE RD., BOISE, ID 83709	(208) 343-3629
ILLINOIS	▲ CHICAGO NORTH	2330 EASTERN AVE., ELK GROVE VILLAGE, IL 60007	(312) 860-5602
	▲ CHICAGO SOUTH	2900 21ST AVE., BROADVIEW, IL 60153	(312) 845-7920
	DECATUR	3501 RUPP PKWY., DECATUR, IL 62526	(217) 875-1092
INDIANA	INDIANAPOLIS	6240 LAS PAS TRAIL, INDIANAPOLIS, IN 46268	(317) 255-4566
IOWA	DES MOINES	8345 UNIVERSITY BLVD., DES MOINES, IA 50311	(515) 223-8444
KANSAS	KANSAS CITY	6339 W. 110TH ST., OVERLAND PARK, KS 66211	(913) 383-3370
KENTUCKY	LOUISVILLE	3600 CHAMBERLAIN, SUITE 348, LOUISVILLE, KY 40222	(502) 426-4312
LOUISIANA	NEW ORLEANS	5626 JEFFERSON HWY., HARAHAN, LA 70123	(504) 733-4823
	SHREVEPORT	5150 INTERSTATE P.O. 9128, SHREVEPORT, LA 71109	(318) 636-7104
MARYLAND	BALTIMORE	8980 ROUTE 108, COLUMBIA, MD 21045	(301) 796-1166
MASSACHUSETTS	BOSTON	131 FLANDERS RD., P.O. BQX 566, WESTBORO, MA 01581	(617) 366-8881
MICHIGAN	DETROIT	12916 FARMINGTON RD., LIVONIA, MI 48150	(313) 525-5356
	KALAMAZOO	126 E. KILGORE RD., KALAMAZOO, MI 49001	(616) 344-1944
	LANSING	3202 S. PENNSYLVANIA AVE., LANSING, MI 48910	(517) 394-6250
MINNESOTA	DULUTH	HWY 61 & CANOSIA RD., ESKO, MN 55733	(218) 879-1225
	MINNEAPOLIS	8824 SEVENTH AVE., NO., GOLDEN VALLEY, MN 55427	(612) 546-0808
MISSISSIPPI	JACKSON	137 TURN-POWE PLAZA, PEARL, MS 39208	(601) 932-1273
MISSOURI	ST. LOUIS	117766 WESTLINE INDUSTRIAL DR., ST. LOUIS, MO 63141	(314) 567-5910
NEBRASKA	OMAHA	13415 B STREET BAY 2, OMAHA, NE 68144	(402) 330-3606
NEVADA	RENO	23 GLEN-CARRAN CIRCLE, SPARKS, NV 89431	(702) 356-8022
NEW JERSEY	▲ FAIRFIELD	90 CLINTON ROAD, FAIRFIELD, NJ 07006	(201) 575-8240
	EDISON	1245 ROUTE 1, EDISON, NJ 08817	(201) 494-8288