

TELETYPE *28* STUNT BOX

 the big PLUS factor in Teletype Model 28 equipment

Federal Aviation Agency Typical Airways Traffic Control Station

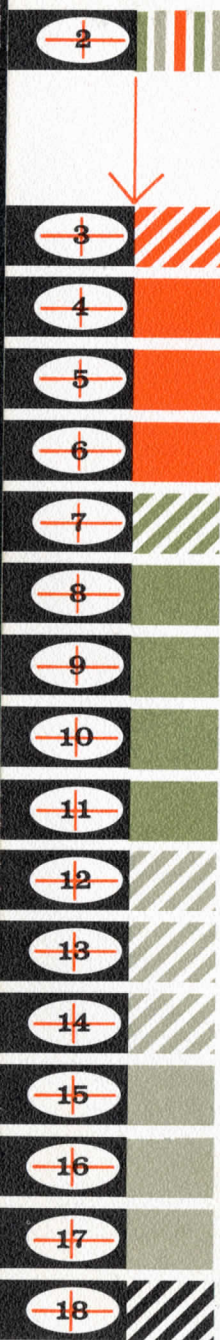

PAGE SELECTOR KEY

		THE BIG PLUS
<i>introduction</i>		SELECTIVE CALLING
<i>applications</i>		EQUIPMENT APPLICATIONS
		REMOTE CONTROL
<i>functions</i>		BASIC FUNCTIONS
<i>basic operation</i>		ELECTRICAL PULSES
		STUNT BOX LOCATION
		FUNCTION MECHANISM (basic components)
		FUNCTION MECHANISM (cycle of operation)
<i>components detailed</i>		FUNCTION BARS
		PAWLS and LEVERS
		COMPLETE STUNT BOX
<i>detailed operation</i>		FORKS, SLIDES, SWITCHES (latching—unlatching)
		SELECTIVE CALLING (terminology)
		SELECTIVE CALLING (in action)
<i>conclusion</i>		OUTLOOK

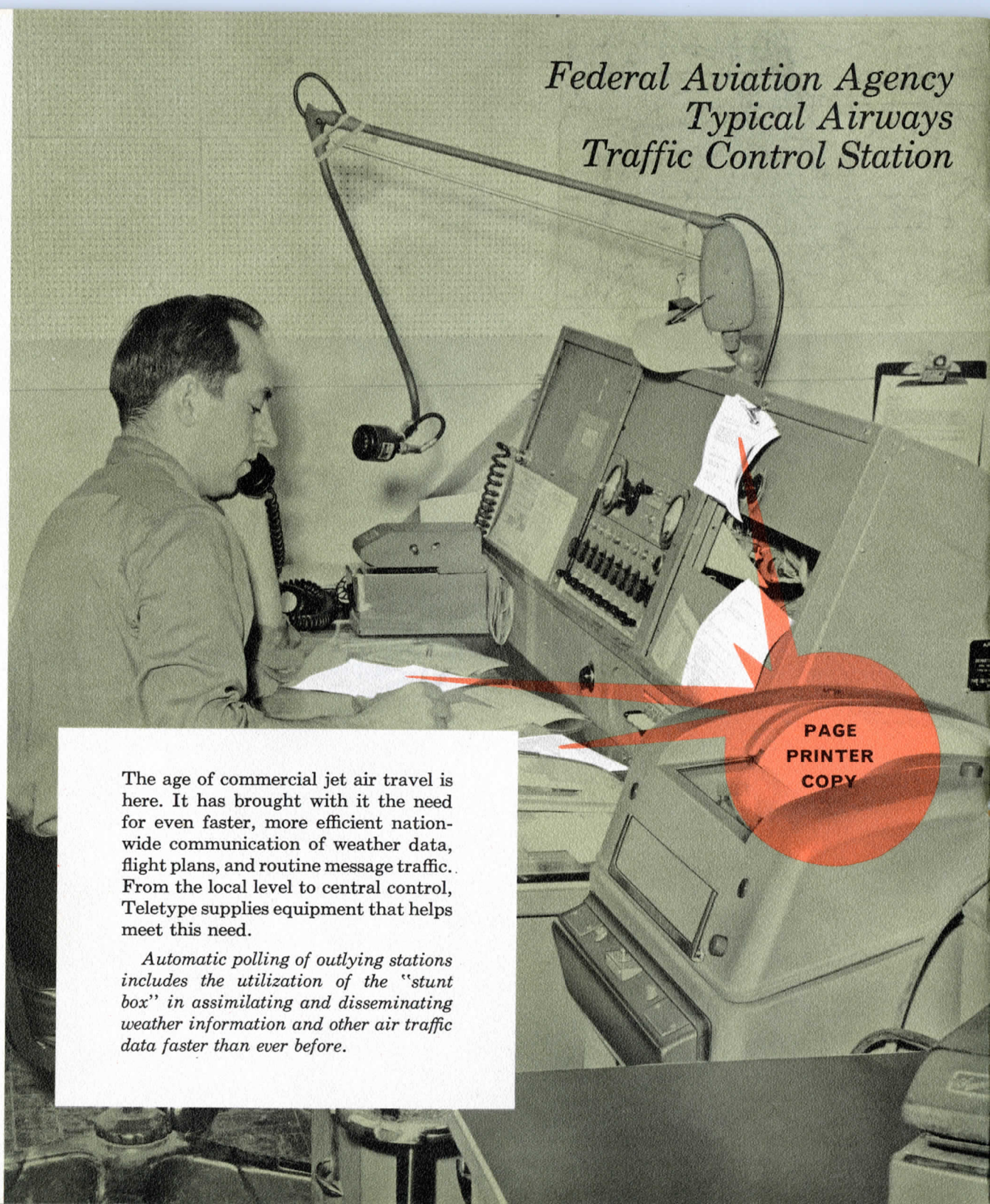

The age of commercial jet air travel is here. It has brought with it the need for even faster, more efficient nationwide communication of weather data, flight plans, and routine message traffic. From the local level to central control, Teletype supplies equipment that helps meet this need.

Automatic polling of outlying stations includes the utilization of the "stunt box" in assimilating and disseminating weather information and other air traffic data faster than ever before.

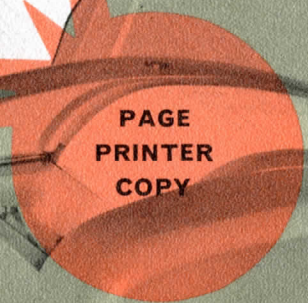



THE BIG PLUS *what it is, what it does . . .*

This brochure is the story of "more value" . . . a "BIG PLUS" feature of Teletype Model 28 equipment. It is the factual story of a "futuristic," component assembly called the STUNT BOX.

One of the most outstanding characteristics of 100 word-per-minute, Teletype Model 28 equipment is its *versatility* . . . achieved to a great degree by this stunt box.

Contained in a lightweight aluminum housing within the typing unit, the stunt box is 9¼" long, 4½" wide and 2¾" high. Compactly arranged, it is the key to an entirely *new control concept* in the field of record communications.

How does the stunt box affect page printer operation?

Early teletypewriters had two shift positions. One was the "Letters" case, which allowed the operator to use 32 combinations of the conventional, 5-level, Baudot, telegraphic code for printing 26 letters of the alphabet and performing 6 related functions. The other was the "Figures" case, or shift position, for printing numbers, symbols and performing functions—also utilizing the same 32 code combinations.

Early equipment, however, was limited in scope of operation because among other things, when additional special non-printing functions were required, it was often necessary to sacrifice printed characters.

To overcome this inadequacy, the Teletype Model 28 page printer stunt box provides a "BIG PLUS" *third shift* feature, which enables the 32 combinations of the "Letters-Figures" shift conditions to be again reused to perform special non-printing functions, without ever sacrificing a single printed character.

Also with early equipment, only one character could be assigned to perform a single function. With the Model 28 stunt box, a single character can be used or several characters can be combined

into a code sequence to perform a single function.

These aids to printer operation, while important, are only a small part of the capabilities of this unique assembly. Serving as an automatic control device for local and remote operations, responding to keyboard or line signals, the stunt box is actually a built-in sequential selector.

Literally, this means the stunt box serves as a memory storage medium, with a mechanism for translating discrete electrical pulses into mechanical motion. This motion, in turn, further initiates mechanical or electrical actions to perform desired operations.

The remote control applications of the Model 28 stunt box alone are becoming so popular that a special self-contained, sequential selector unit has been perfected just for this purpose.

Major use of this dynamic unit is concerned with "selective calling" and "integrated data processing" applications. In any situation requiring remote control, the Teletype Model 28 typing unit with its stunt box can perform tasks usually assigned to costly, more complex, larger equipment.

Utilizing the stunt box, operational procedures in both large and small communication networks can be simplified, equipment bulk can be reduced

. . . money can be saved.

How the stunt box got its name

In the early days of printing telegraphy, "stunts" was the term applied to nonprinting functions. These functions were actuated by function or "stunt" bars in the function assembly of printing telegraph equipment.

Early use of the term "stunts" has been carried forward to our present



day designation of the function assembly as a "stunt box."

What can the stunt box do?

New uses have been found for this flexible, versatile unit faster than we've been able to list them. From present indications, the variety of applications for this control mechanism will continue to be limitless.

Basically, the stunt box will perform the following operations:

- 1 Mechanically initiate internal functions within the typing unit of the page printer set.
- 2 Electrically control functions within the page printer set.
- 3 Electrically control external equipment.

What does this mean?

Let's consider a hypothetical situation:

Suppose you were a midwesterner who liked to drink hot coffee in the morning just after arrival at your office.

You could arrange to have your New York operator (who, due to time differences would begin an hour earlier than you) send a signal at a specified time daily. This signal would cause the programmed stunt box in your Teletype printer to operate a switch controlling a coffee percolator.

Upon arrival at the office, you could begin your business day with hot coffee, cup in hand.

We mention this seemingly whimsical example only to point out the fact that . . . utilizing the stunt box . . . anyone can do anything from turning on a coffee percolator at a remote location, to calling in an entire network of stations from coast to coast.



SELECTIVE CALLING . . . *inter-plant or intra-plant*

INTER-PLANT

The most popular application of the stunt box in communications and data processing is its use as a sequential selector for message directing.

Consider a nationwide inter-plant network consisting of Teletype Model 28 equipment. Circuits for this system can be established through the stunt box in a variety of ways. One city can call all other cities simultaneously . . . individually . . . or in groups of 2, 3, 4, etc. A detailed description of how this is accomplished is found in a special section of this brochure devoted to SELECTIVE CALLING functional operations. (See pages 16 and 17.)

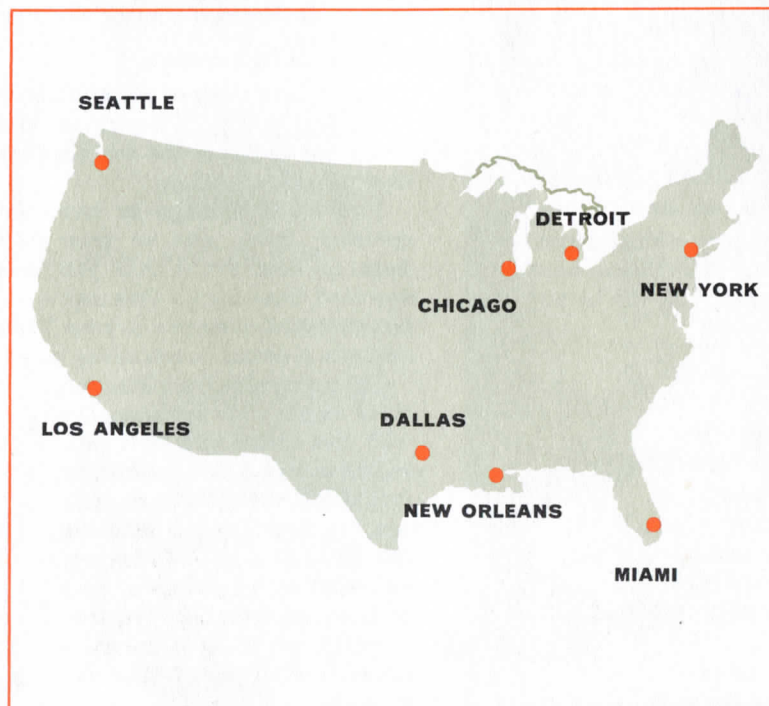

INTRA-PLANT

The same procedure can be applied to an intra-plant operation with page printers or automatic send-receive sets located in specific departments, such as:

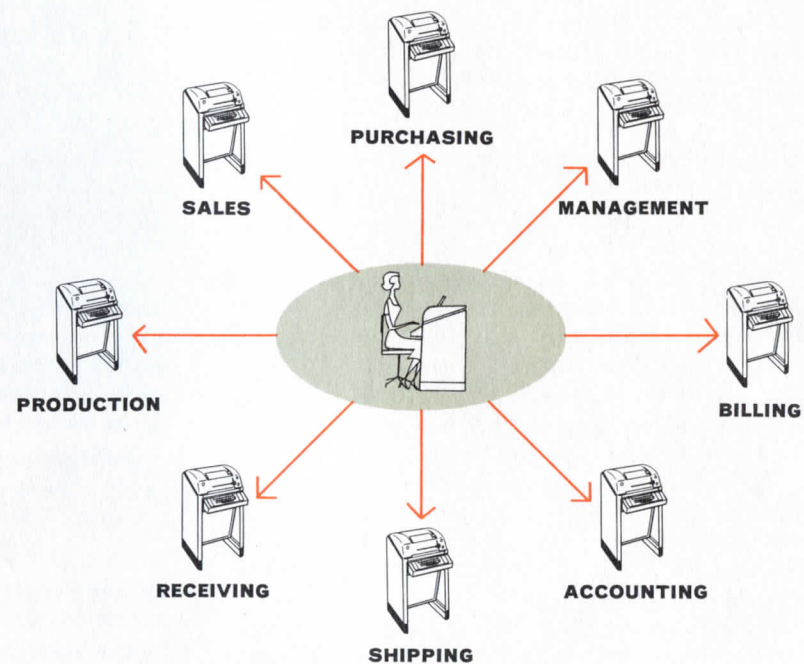

The principal advantage of these systems is that message traffic can be selectively directed only to those printers actually concerned with the information being transmitted. Printers in the system that are not called in are always "alert", their stunt boxes continually "riding-the-line," waiting for specific information to be directed to them. When the stunt box recognizes a control signal directed to its printer, a "lightning" chain of events begins, allowing the selected printer to start operations.

EQUIPMENT APPLICATIONS . . . *all involve stunt box use*

To illustrate an example of selective calling in actual business practice, let us consider an integrated data processing system. An operator at the keyboard of a Teletype Model 28 page printer or automatic send-receive set, completely fills out a SALES order. As she enters information onto the form, the stunt box automatically and selectively directs pertinent information to those specific departments concerned with the particular information being entered. For example . . . every department would get the order number, while cost information would be received only by ACCOUNTING, BILLING and MANAGEMENT.

In conjunction with IDP applications . . . when a Teletype

printer is equipped with a sprocket feed platen for multi-carbon forms . . . the stunt box activates the operation of such required functions as horizontal tabulator, vertical tabulator and form feed-out.

Other equipment applications include automatic switching, code conversion (sequential signals to multi-wire output), digital telemetering, control of mechanical production in the "automatic factory," error checking and a variety of special uses. A typical example of a special use is an application where the stunt box is used to "trigger" an answer back unit that sends a message verification character to the sending unit.



SALES

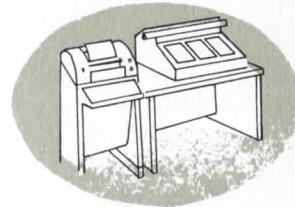

ACCOUNTING



BILLING



MANAGEMENT

AUTOMATIC SWITCHING

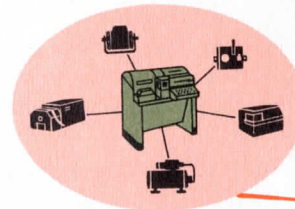

MECHANICAL PRODUCTION CONTROL

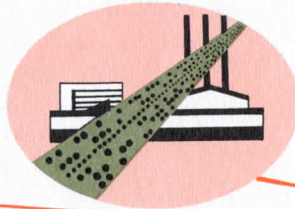

CODE CONVERSION

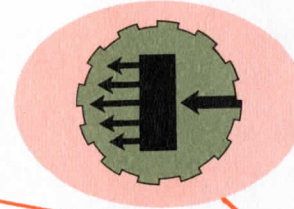

POPULAR APPLICATIONS

The selective capabilities of the stunt box as well as all of its other operations can be tailored to your individual needs. You have only to define what you would like it to accomplish . . . Teletype engineers will be pleased to show you how the stunt box can fulfill your requirements.

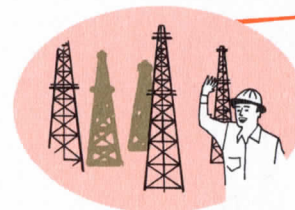

DIGITAL TELEMETERING

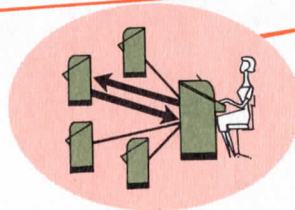

ANSWER BACK

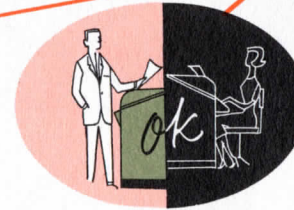

ERROR CHECKING

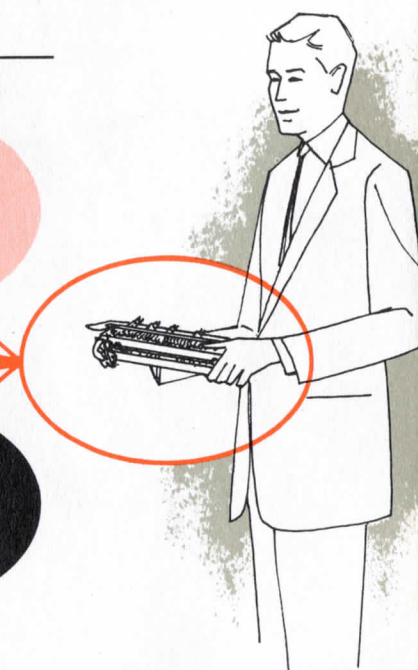

REMOTE CONTROL . . . *controls electrical equipment anywhere*

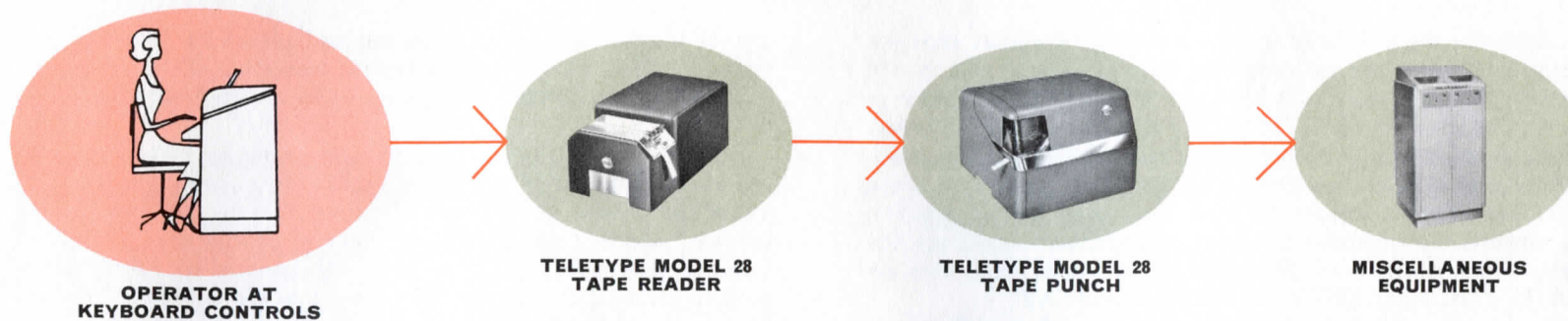

In addition to its use in selective calling and integrated data processing, another major application of the stunt box is controlling auxiliary apparatus. In this category is the control of Teletype tape punches, readers and business machines of all kinds. Stunt box action can tell one machine to record on tape, another to record on a form, and others to "listen" but not record.

Unlimited applications of the stunt box are possible through its ability to close and open electrical contacts for equipment such as alarms, signal lamps, signal bells, and motor controls in remote locations. Illuminate an area, increase pumping pressure, start a computer . . . all these, and many more, actions can be accomplished at the same time, on the same circuit—with each machine responding only to its own instruction through stunt box control.

In conjunction with remote control as related to various business machines . . . through stunt box use, sequential signal input to the printer can be converted to multi-wire output for use by auxiliary equipment. An enormous field of application is opened by combining systems when this feature is employed with available commercial data processing equipment.

When considering remote control equipment it should be remembered that the Teletype Model 28 stunt box can start or stop any electrical operation controlled by a switch.

The stunt box is considered the "robot brain" of the units shown here.

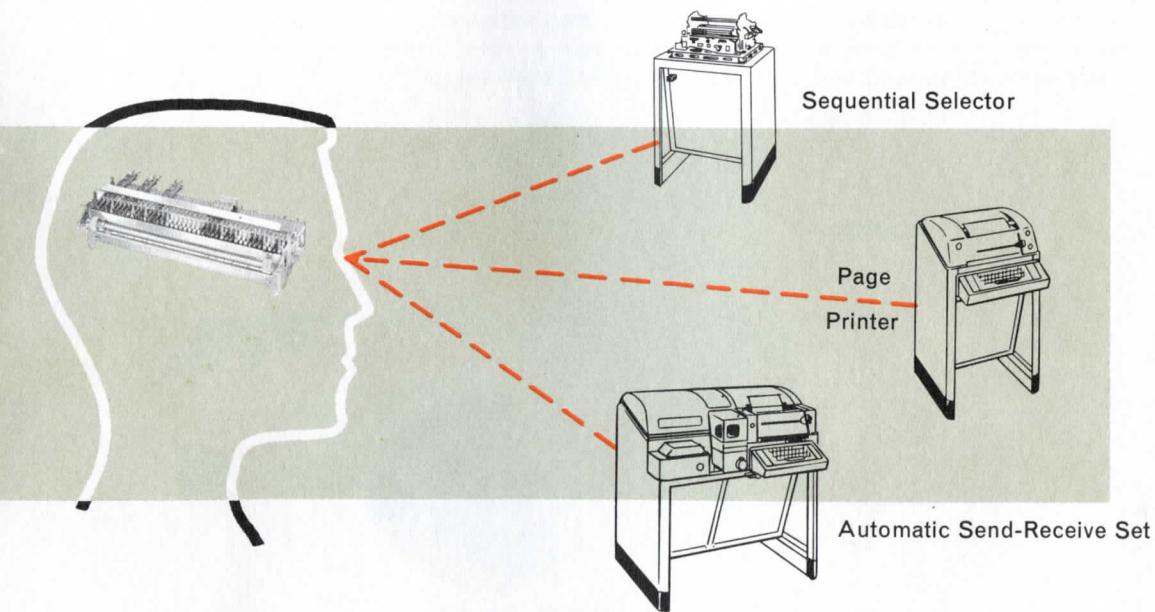



BASIC FUNCTIONS . . .

*make possible a variety
of applications*



Physically surrounded by the framework of its aluminum housing, the stunt box is provided with forty two code slots. Each of these slots will accommodate a function mechanism that is designed to perform a specific function.

As stated earlier, the stunt box will perform three basic function operations—internal mechanical . . . internal electrical . . . and external electrical. These operations can be accomplished individually or simultaneously, depending on how the stunt box function mechanism has been coded, “set up,” or programmed.

Normally, six of the stunt box's code slots are assigned to standard nontyping printer functions . . . they are:

- | | |
|--------------------------|--|
| 1 Letters Shift | 4 Line Feed |
| 2 Figures Shift | 5 Blank |
| 3 Carriage Return | 6 Space Suppression for Line Feed |

Besides the six basic essential nonprinting functions, a number of additional functions may be introduced. With modifications to the basic function mechanisms, and with additional parts placed in the remaining open code slots, the following functions may be performed:

- | | |
|--|-------------------------------------|
| 1 Automatic Carriage Return and Line Feed | 6 On-line, Reverse Line Feed |
| 2 Unshift on Space | 7 Form Feed-out |
| 3 On-line Backspace | 8 Signal Bell Contact |
| 4 Horizontal Tabulation | 9 Busy Light Contact |
| 5 Keyboard Lock | 10 Motor Stop Contact |
| | 11 Vertical Tabulation |

The necessary parts can be supplied to equip your Teletype units for handling any desired additional functions. *To increase versatility, field conversions may be made in which completely different stunt box arrangements are interchanged.*

The Sequential Selector

The popularity of utilizing the stunt box as a control unit even where the page printer is not required, brought about the development of the Teletype Model 28 sequential selector. This unit is similar to the page printer typing unit except that the printing and paper handling mechanisms have been removed. It is exclusively used in remote control operation.

Illustrated is the sequential selector. This unit is activated by incoming sequential signals.

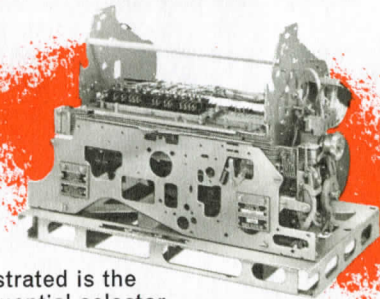
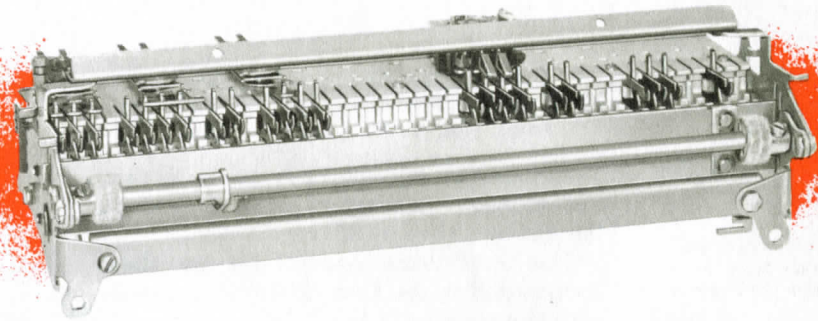

Pulses originate at keyboard

ELECTRICAL PULSES . . . *how a message is sent electrically*

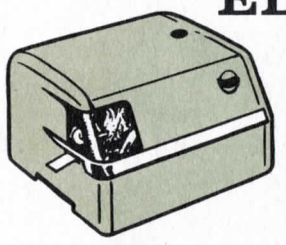

Pulses received and converted to tape intelligence

Teletypewriter equipment is unique in that it permits the instantaneous delivery of printed messages regardless of the distance they must travel.

This is of course possible because these messages are transmitted in the form of electrical pulses—which travel with the speed of light.

A pulse is simply a unit of time during which the flow of current in the signal line is either permitted to continue—or is interrupted—by the operation of a contact.

Messages originate with keyboard action or transmission from a tape reader. Mechanical actions are converted into electrical pulses for transmission over telephone or telegraph lines and through radio facilities.

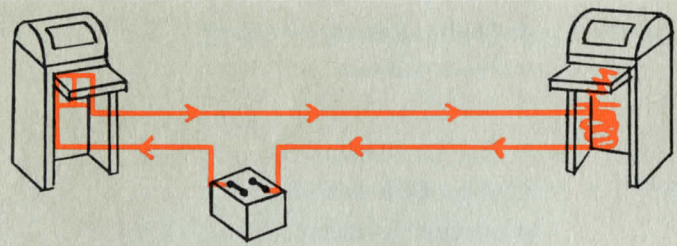

When the contact in the signal line is closed, current flows and the line is said to be "marking." A MARKING PULSE is generated when the contact is held closed for a fixed length of time.

Before finding out how the STUNT BOX operates we should have some understanding of how a message is sent electrically

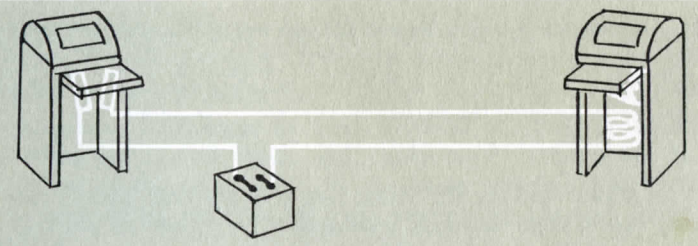

When the contact is opened, no current can flow and the line is said to be "spacing." A SPACING PULSE is generated when the contact is held open for a fixed length of time.

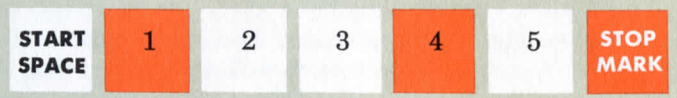

Each character in a typical code consists of five electrical pulses which may be either marking or spacing. Red indicates a marking pulse, white a spacing pulse.

Using the letter "D" as an example, pulses one and four are marking while pulses two, three, and five are spacing.

In addition to the code pulses, (which transmit the message) each combination is preceded by a start pulse (always spacing) and followed by a stop pulse (always marking) for synchronization.

One of a Variety of Teletype Equipment Coding Arrangements

FIGURES LETTERS	-	?	:	\$	3	!	&	=	B	'	()	.	,	9	0	1	4	BELL	5	7	;	2	/	6	"	Z	BLANK	LETTERS	FIGURES	C.R.	L.F.	SPACE		
1	1	1	1	1	1				1	1	1	1					1	1	1		1	1	1	1	1	1		1	1						
2									2	2	2	2					2	2	2		2	2	2					2	2						
3									3	3	3	3					3	3	3		3	3	3					3	3						
4									4	4	4	4					4	4	4		4	4	4					4	4						
5									5	5	5	5					5	5	5		5	5	5					5	5						

Numbers Indicate Marking Code Pulses

Illustrated at left is a typical coding arrangement as used in punched paper tape. "FIGURES" refers to the character indicated on the upper portion of a Model 28 key top. "LETTERS" refers to the character indicated on the lower portion of the key top. RED DOTS indicate marking pulse transmission. WHITE DOTS indicate spacing pulse transmission. (Black dots are feed holes).

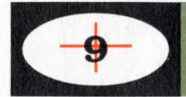

STUNT BOX LOCATION . . . *relationship to typing unit code bars*

We already know that the seemingly magic-like stunt box is a compact control mechanism measuring 9¼" by 4½" by 2¾" over-all.

Now let us relate the stunt box to the position it occu-

pies when performing all of its "magicianly" tasks.

The stunt box extends across the full width of the Teletype Model 28 typing unit of the page printer, automatic send-receive set and sequential selector.

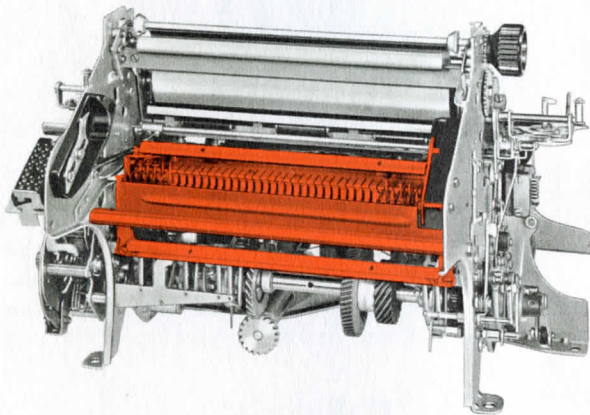

Rear view of Teletype Model 28 typing unit with area occupied by stunt box shown in red.

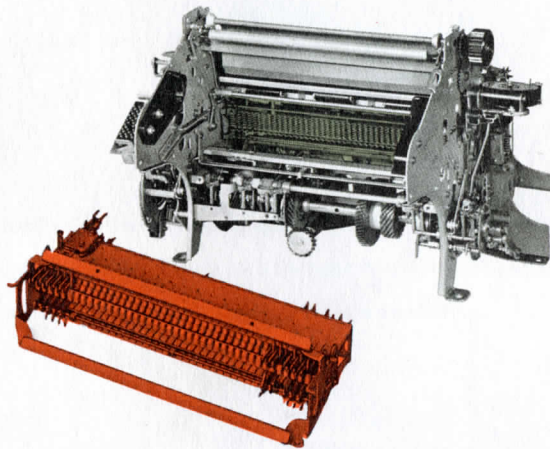

Rear view of typing unit with stunt box removed. Code bar assembly is shown in green.

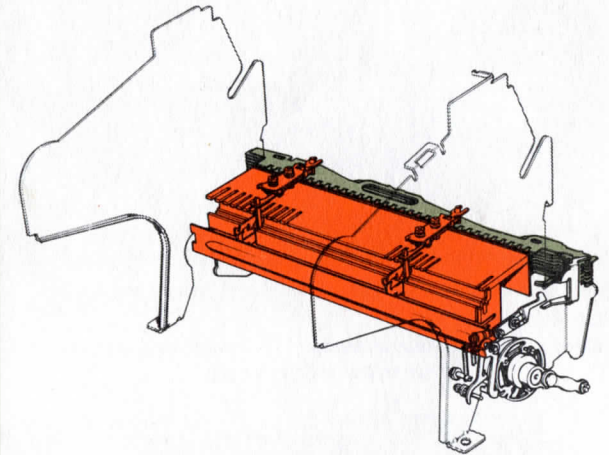

Partial section of typing unit in perspective shows stunt box in red and code bars in green. The two fork-like projections on top of the stunt box are called "shift forks." Shift forks position Suppression, Zero, and Figures—Letters Shift code bars through studs.

Actual Operation

With an understanding of the relationship of the stunt box to the code bars we can proceed with the mechanics of actual operation.

All operation begins with the receipt of a signal . . . i.e., series of pulses—"marking," or—"spacing." This signal is received by the selector mechanism of the typing unit. It is converted into mechanical action within the typing unit. Linkages activated by this action, position five equally notched bars, called code bars, to the left if the pulse is marking or right if the pulse is spacing.

Actually there are nine code bars, five for intelligence others for functions. From top to bottom they are identified in the illustration at right.

The rear portions of the code bars are identically notched. Because some code bars will be positioned to the left and others to the right, the vertical alignment of both projections and slots will present a staggered pattern. This over-all pattern changes with the receipt of each variation in signals received.

Let us now determine how this action affects actual stunt box operation.

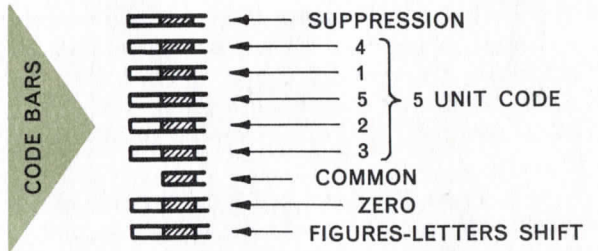

FUNCTION MECHANISM . . . *basic components*

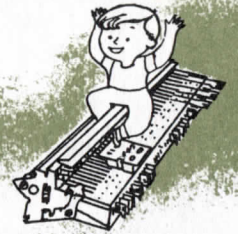

As previously stated, the stunt box has forty-two code slots. They are marked at 10-20-30 and 40 slot intervals as viewed from the rear.

Consider one opening or code slot in the stunt box . . . let's see how its function mechanism is affected by the code bars.

This is a Function Bar

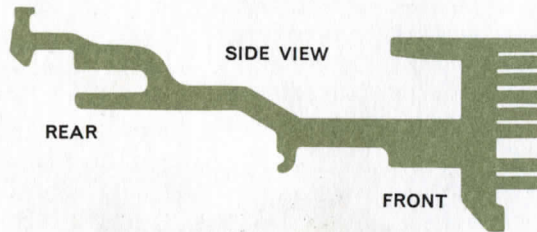

The projections at the front of the function bar are called tines. The illustration below shows a partial top view of the code bars and two function bars.

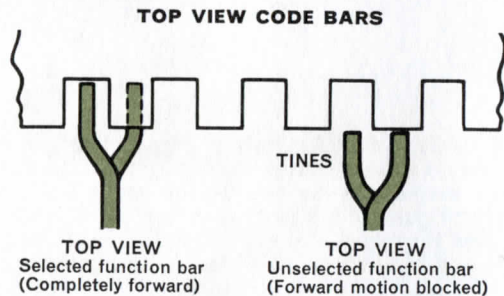

The motion of the function bar is initially forward and then to the rear. If *code bar* projections do not block function bar tines, the function bar moves completely forward. If code bar projections block function bar tines, forward movement is stopped.

A function bar front end as viewed from the rear of the code bars will show tines angled to the left and to the right. Tines angled to the left

are called marking tines, those to the right are called spacing tines.

A fully loaded or "universal" function bar contains sixteen tines (eight "marking" and eight "spacing"). Tines can easily be removed from the universal function bar so that it will operate on any desired code.

This is a Function Pawl

The function pawl is engaged by the rear upper projection of the function bar.



This is a Function Lever

The function lever is engaged by the function pawl.



Viewed from the side, in a cut-away drawing of the stunt box code slot . . . the function bar, pawl and lever are related to each other as follows:

This view illustrates a typical function box mechanism in a disengaged position.

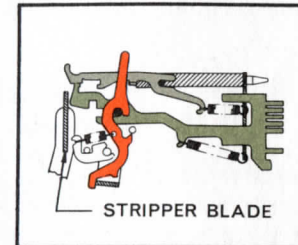
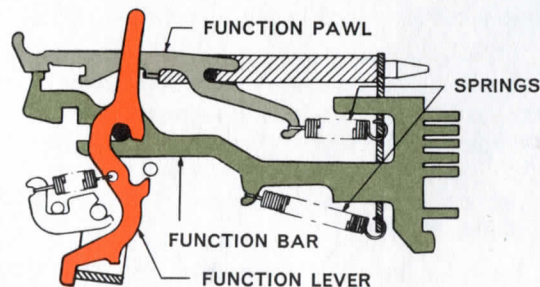

Stripper Blade

To this view we shall add the STRIPPER BLADE which extends along the rear length of the stunt box. The motion of the stripper blade is first down and then up.

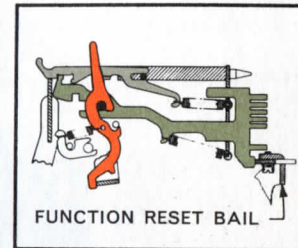

Function Reset Bail

To this view we shall also add the FUNCTION RESET BAIL which moves forward and to the rear, making contact with the lowest forward projection of the function bar.

Movements of the stripper blade and the function reset bail are controlled by linkages to the main shaft of the typing unit. Their complete cycle of operation is based on one revolution of the main shaft.

This view illustrates a typical stunt box mechanism in an engaged position.

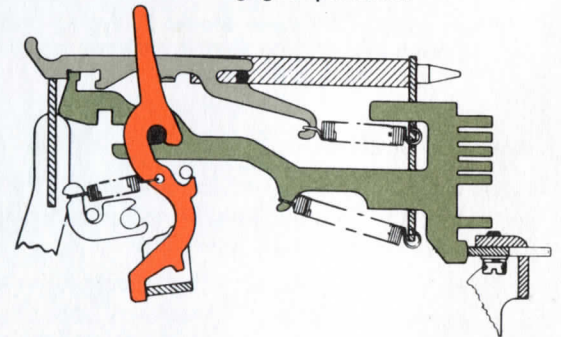

We know that the code bars are positioned depending on the signal received. Now let us follow the simple operation of the stunt box mechanism from a disengaged position to an engaged condition and back again to a position of rest.



FUNCTION MECHANISM . . . *cycle of operation*

- 1 The function reset bail holds the function bar in the disengaged position.
- 2 As the typing unit main shaft revolves, pressure from the function reset bail is released from the lower projection of the function bar.
- 3 The "spring-loaded" function bar begins to move to the front.
- 4 If the code combination in the typing unit code bars is such that the tines of the function

bar are not blocked by the code bar projections, then the function bar will move far enough forward to let the function pawl fall into engagement.

- 5 As the function bar is returned to the rear by the backward movement of the reset bail, the function pawl also is carried to the rear.
- 6 The function pawl engages the function lever which pivots with its top portion moving to the rear. **IT IS THIS MOTION OF THE**

FUNCTION LEVER THAT INITIATES THE OPERATION OF A FUNCTION.

- 7 The function pawl in its most rearward position, still in the engaged condition, is returned to the disengaged position by the upward movement of the stripper blade.
- 8 When the function pawl is raised, its spring pulls forward. The function pawl's lower projection then rests on the upper rear projection of the function bar.

CYCLE OF OPERATION *illustrated* Reviewed in graphic form the operation cycle is illustrated below:

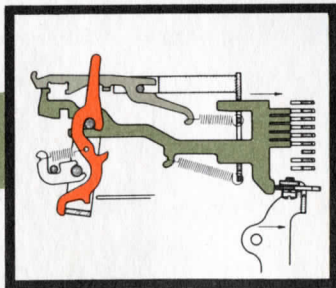

A Function bar moves forward . . . tines feel for opening in code bars.

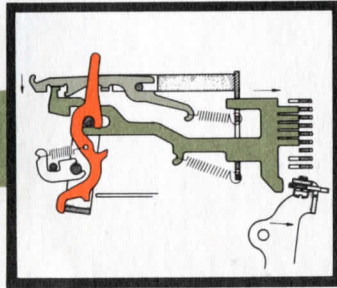

B If function bar tines find opening, function bar moves completely forward . . . function bar upper rear projection is engaged by falling function pawl.

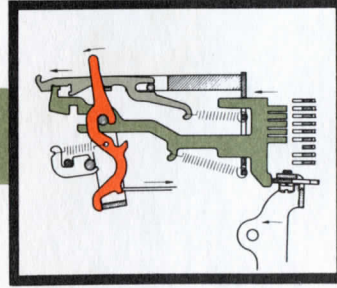

C Function reset bail forces function bar and engaged pawl to rear. Pawl engages function lever . . . **function lever initiates operation of function.**

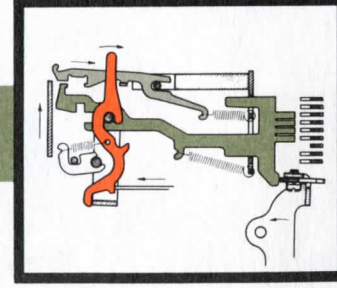

D Stripper blade removes function pawl from function bar.

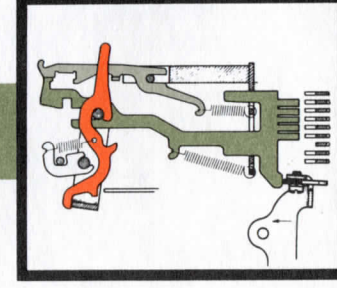

E Function mechanism returned to disengaged position.

Basically this cycle describes the complete operation of the function mechanism in one code slot. The following pages go into detail regarding each part of the mechanism with information as to how numerous stunt box functions are performed.

FUNCTION BARS . . . *how they are coded*

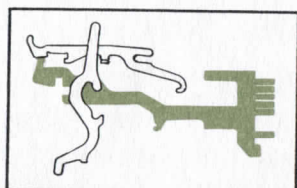
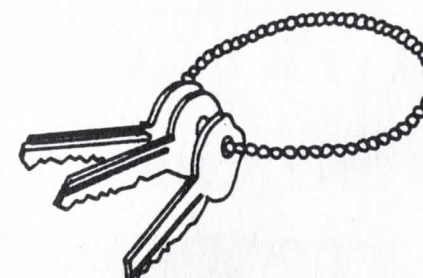

Function bars are literally the "passkeys" to the performance of functions. In their forward motion into the "lock-like" code bars—they search for an opening.

Like keys . . . function bar projections vary . . . and they vary in several ways. The number of tines and the way they

are angled . . . left, for marking and right, for spacing usually varies from one function bar to the next.

Shown below in front views are function bars with tine arrangements corresponding to the 5-level signal characters that will allow these function bars to move completely forward.

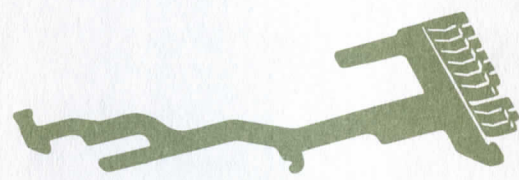

Universal Function Bar

Illustrated above is a side view of the fully loaded bar called the "universal" function bar. At left is the front view of this bar with tines identified as to the level of typing unit code bars they contact.

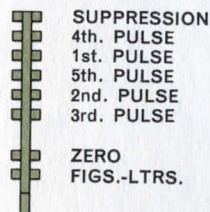

Front View

Coding Function Bars

As indicated in this diagram . . . by snapping off tines, "universal" function bars can be coded for any one of the code characters.

KEY
Snap out Tine
Leave in Tine

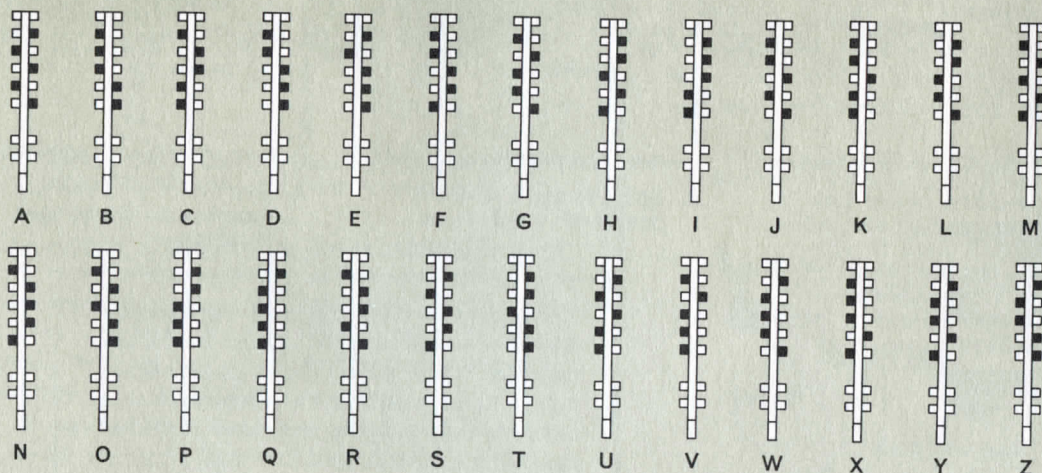

FIGS BLANK LF CR LTRS SPACE UNIVERSAL
 OR
 (COMMON) PRINT*

NON PRINT* SELECT* NON SELECT* FIGS* LETTERS*

***Note:** A function bar coded for a particular character can be coded in addition for print or non-print, select or non-select, figs or ltrs., or any combination thereof.

FUNCTION PAWLS and LEVERS . . . *what they are, what they do*

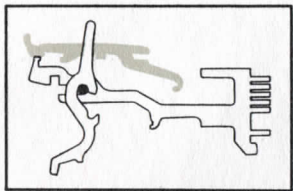

Function Pawls

The function pawl is the simplest of the principal parts of the function mechanism. There are three pawls available.



Standard Pawl

Special Pawl

Accessory Pawl

The special pawl operates its own function lever and the lever in the adjacent higher numbered stunt box code slot.

When this special pawl is used, an accessory pawl must be used in the higher numbered slot.

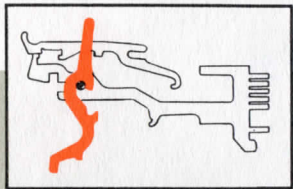

Function Levers

The motion of the function lever initiates the actual operation of a function.

Projections of the function lever move slides, bails, operate electrical contacts, block other levers and engage latches. Studs and bails can be mounted on certain lever projections.

As a result of these actions, all of the operations of the stunt box can be performed.

Illustrated at right are twelve function levers. Letters identify various projections. The purpose of each projection is explained in the copy block below the levers.

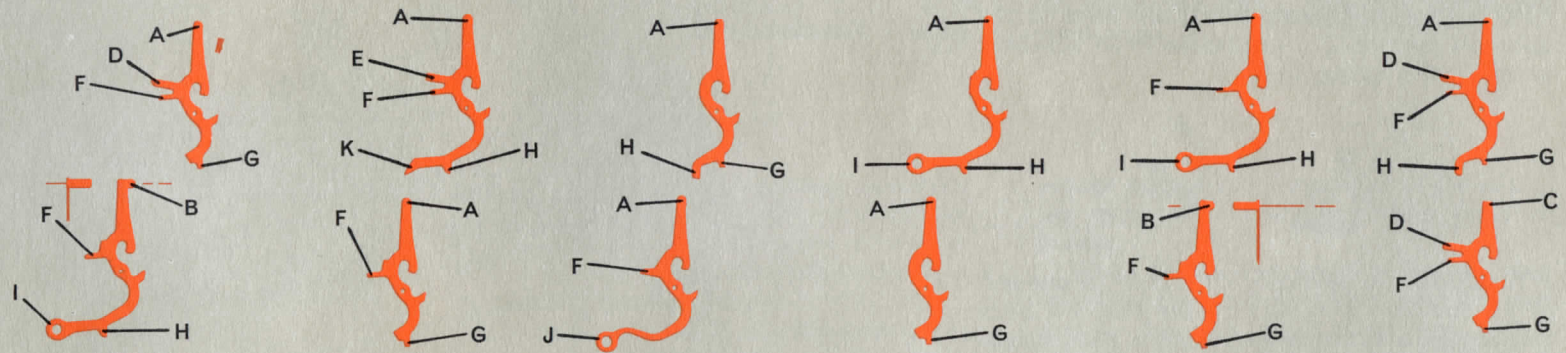

- A** Used to operate a shift slide or an electrical contact.
- B** Used to operate an electrical contact which is installed in line with the function lever and, in addition, an electrical contact installed in line with the next lower numbered slot.
- C** This extension is for use in the next lower numbered slot adjacent to the slot in which a function lever with extension "B" is used.
- D** Used to block the operation of the function bar in the adjacent higher numbered slot.
- E** Used to block the operation of the function bar in the same slot.
- F** Used if the function lever is to be latched in the operated position.
- G** Used to operate a slide arm associated with the operation of such functions as carriage return, line feed, horizontal tabulation, page feed-out, etc.

- H** Used to operate the space suppression bail.
- I** Used to mount a stud or one end of a shaft.
- J** This extension is similar to extension I, except that it is used when spacing is not suppressed. The curve in the extension permits operation of the function lever without operating the space suppression bail.
- K** This extension is required when the function lever has extension E. A function lever with extension E can be operated only by the release bail shaft (or by a stud in extension I or J of a function lever in an adjacent slot) engaging the extension K.

Because stunt box applications are ever increasing, modifications of the levers shown here and additions to the total number may occur.

THE COMPLETE STUNT BOX... *additional components detailed*

Spring Plate

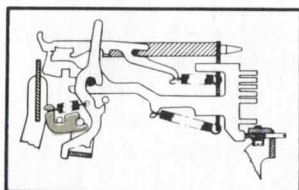

As illustrated, the spring plate provides an anchor for one end of the function lever spring.

Function Latches

If it is desirable to keep a function lever in the operated position . . . a function latch is substituted for the spring plate.



In addition to providing an anchor for one end of the function lever spring—the function latch will engage a function lever with a latch extension, and hold the lever in the operated position until released by the stripper blade during the next cycle of operation.

The function lever can be kept in the latched position for any required length of time. Three additional methods of unlatching are available.

The first method is to have a single stud on an adjacent lever release the latch when required. A lever with a double stud will operate latches in adjacent slots on both sides. A latch release bail shaft is also available for unlatching.

Function lever latch release bail shafts span code slots at varying intervals from 4 to 35 slots. Shaft lengths extending across the following consecutive code slots are available: 4, 6, 8, 9, 12, 14, 17, 22, 25, 27, 32 and 35.

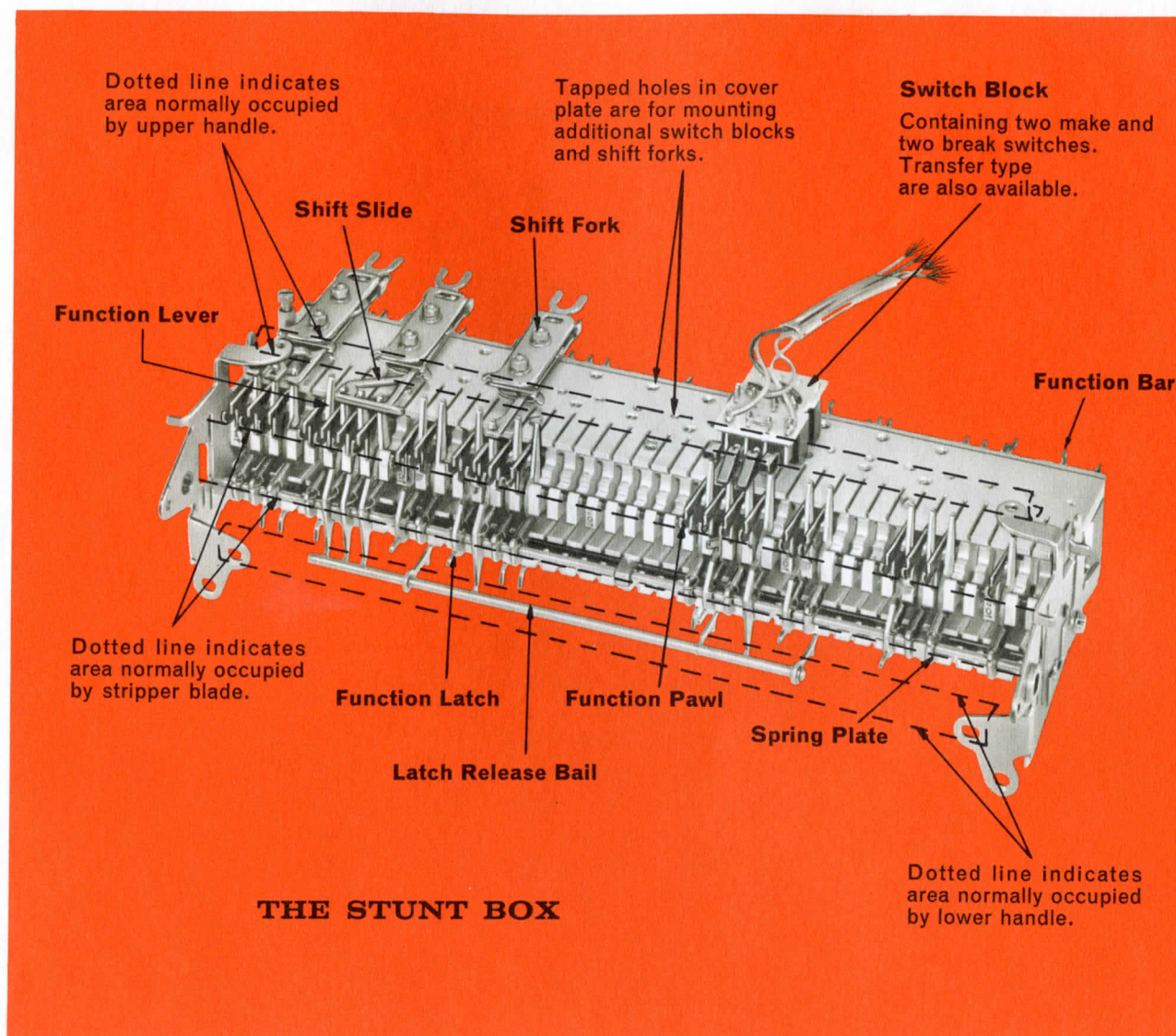

FORKS, SLIDES, SWITCHES . . . *also . . . latching . . . unlatching*

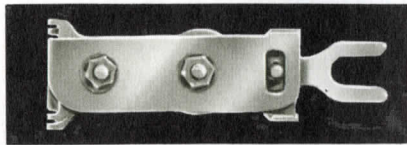

Shift Fork

The shift fork engages the vertical posts that move the zero, Figures-Letters shift and suppression code bars from the marking to the spacing position.

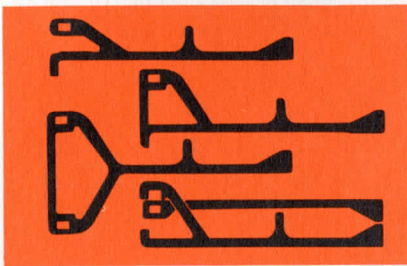

Shift Slide

Shift slides operate the shift fork. Shift slides are operated by function levers. From one to six function levers can operate a single slide. Illustrated at left are typical shift slides.

Switches

Switch blocks for mounting on function lever guide plate are available. Each block can be equipped with up to four arms for "make", "break" or transfer contact operation. With stunt box programming these arms can be set for momentary operation of the contacts, for one cycle of operation, or for a sustained condition of closed or open contacts.

- A. Shows "make" or contact switch arm with rearward action of top of function lever.
- B. Shows "break" or no contact switch arm with rearward action of top of function lever.

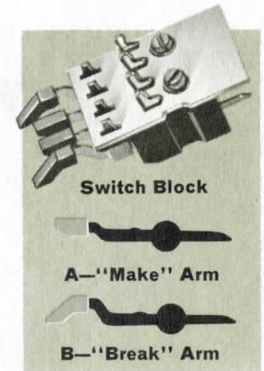

LATCHING—UNLATCHING . . . *key to sequential selection*

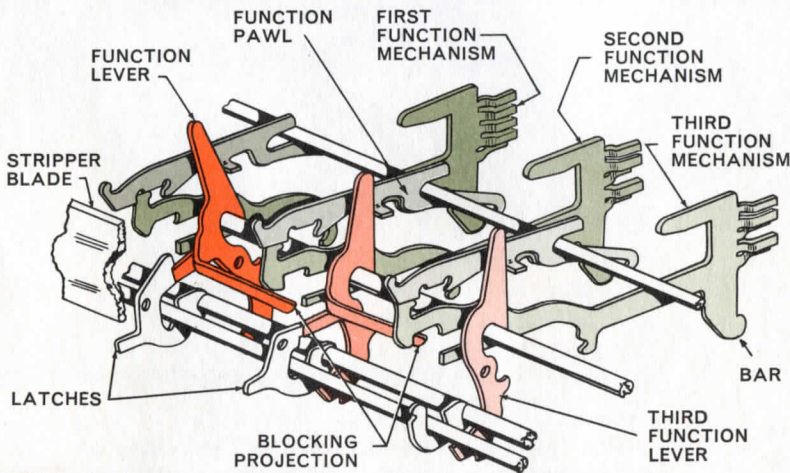

Cutaway of Stunt Box
Three Function Mechanisms Detailed

COLOR CODE

- ● ● FIRST FUNCTION MECHANISM
- ● ● SECOND FUNCTION MECHANISM
- ● ● THIRD FUNCTION MECHANISM

(Note: Not in true scale. Projections and distances are exaggerated for greater clarity.)

Let us now follow the sequential operation of the function mechanisms in a stunt box that has been coded to perform a function on the receipt of the third character in a sequence of three characters.

The first character of the three character sequence is received by the selector, processed by the typing unit linkages and code bars, and then interpreted by the first function bar.

The function pawl of the selected (first) function bar pivots the first function lever, around its pivot point. This movement removes the blocking projection of the first function lever that has been preventing the forward motion of the second (or adjacent) function bar.

The first function lever is latched up in its operated position by a latch lever. The stripper blade rises to disengage the first function pawl from the first function bar.

The second function bar is selected by

receipt of the second character of the selecting sequence, initiating a similar chain of events.

While the second function bar is being selected, the stripper blade descends and strikes the first latch lever arm which releases the first function lever. Should a character be interposed between the first and second character of the selecting sequence, the projection blocking forward movement of the second function bar will be restored, and will prevent selection of this function bar by the second character of the selecting sequence.

While the second function lever is latched in the operated position, the third consecutive character of the selecting sequence will position the code bars to allow operation of the third function lever, which through its function lever activates a switch, slide, lever, bail, etc., to perform the desired function.

SELECTIVE CALLING... *terminology*

Teletype Model 28 Keyboard consists of four rows of keys; top row of "red" function keys . . . and three rows of "green" printing character keys.

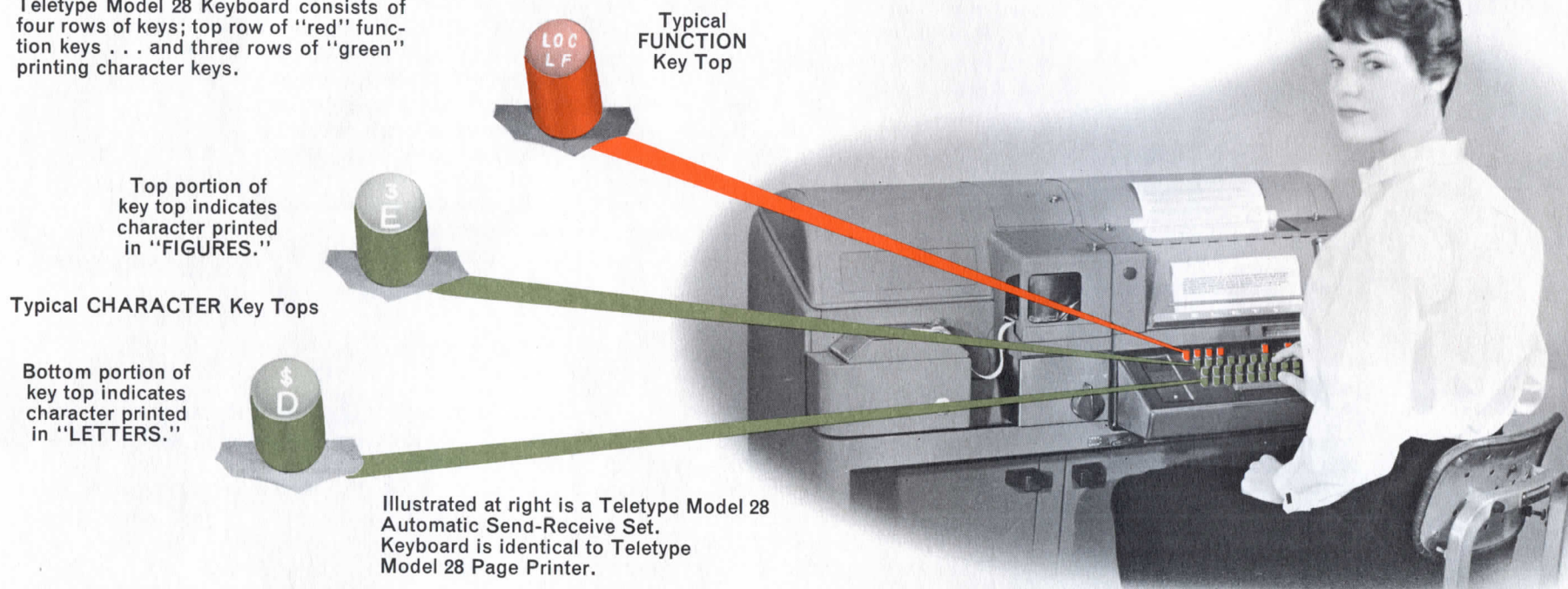

Top portion of key top indicates character printed in "FIGURES."

Typical CHARACTER Key Tops

Bottom portion of key top indicates character printed in "LETTERS."

Illustrated at right is a Teletype Model 28 Automatic Send-Receive Set. Keyboard is identical to Teletype Model 28 Page Printer.

introduction to selective calling

Before illustrating and describing a typical selective calling operation in detail, we should first be acquainted with some general information about the page printer and what it will do.

Specifically the Teletype Model 28 page printer will perform in *three basic operational areas*.

- 1 The first of these areas is referred to as "Letters." In this condition the printer types alphabetical characters and performs func-

tions as indicated on the lower portion of the printer's green keytops.

- 2 When the typebox shifts to "Figures" the second area, symbols and numerical characters as indicated on the upper portion of the keytops will be printed.
- 3 In the third area, "Select-Non Print," direct printing is suppressed while the signal selector and stunt box remain active. The printer is always awake, its stunt box always

riding the line, waiting for information to be directed to it.

The detailed description of selective calling at right, applies to a method that one specific customer has elected to use.

This system provides for the assignment of an identification code to every printer on the circuit. This code can be made up of any character or sequence of characters.

SELECTIVE CALLING . . . *sequential selection in action*

CONDITIONING CODE



SELECT—NON PRINT

CALL DIRECTING CODE



SELECT—PRINT

END OF ADDRESS

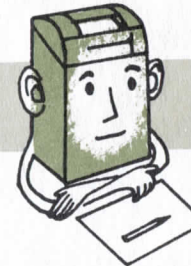

NON SELECT—NON PRINT

END OF MESSAGE

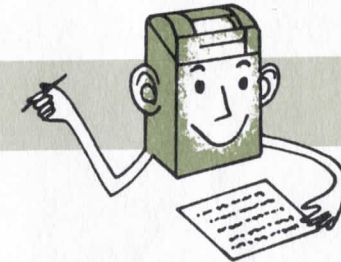

SELECT—NON PRINT

We already know that various function levers, pawls and bars along with other parts of the function mechanism can *perform* functions, *block* functions and *control* time intervals of make or break electrical contacts. With this knowledge, we can in detail show how the systems illustrated on page four can operate.

Identification Codes, or call directing characters (CDC's), are assigned to each printer in the system. The following four basic steps are in this plan:

1 Conditioning Code—With the transmission of a sequence conditioning code such as "Figs-H-Ltrs," the printers will respond to the three characters in the following manner:

The "Figs" function mechanism unlatches the "H" function mechanism. The "H" mechanism will operate if selected. The "H" function lever activates the latch release bail which trips off function levers with shift forks that return the zero and suppression code bars from the spacing to the marking position. This means all of the printers on

the circuit are now in what is called the SELECT-NON PRINT condition. The "Ltrs" signal is used to compensate for mechanical time lag.

2 Call Directing Code—With the reception of the identification code or call directing character or characters (CDC's) that are assigned to specific printers in the system—selected stunt box function mechanisms move the suppression code bar to the spacing side, unblocking the type box clutch of the typing unit. All of the printers that have been selected are now in the SELECT PRINT condition. These printers are in the "Letters" print position and they are now ready to receive and type a message.

(In calling printers, when more than one character is used as a CDC, the function lever of the first character is latched up to permit the 2nd function lever to operate. See "LATCHING . . . UNLATCHING," page 15.)

3 End of Address—After calling in the printers which are to receive a message, a sequence of characters such as "Carriage Return-Line Feed-Letters," is transmitted by the originating printer. This is known as the end of address code and causes the zero code bars of all printers to shift to the NON-SELECT position.

The purpose of the "END OF ADDRESS" sequence of characters is to prevent un-called printers from receiving the message accidentally should their CDC be transmitted during normal message traffic.

4 End of Message—After the messages have been transmitted, it is desirable to place all of the printers in the select-non print condition. This is accomplished by transmitting the conditioning code, "Figs-H-Ltrs." Being in the SELECT-NON-PRINT condition, the printers are standing by . . . their stunt boxes alert to line transmission.

OUTLOOK . . . *what of the future?*

Teletype equipment, accepted as an important economic tool of business and industry, serves the nation in many ways.

Military and civilian governmental agencies tie in their far flung outposts directly to control centers for fast dissemination, evaluation and disposition of information. With Teletype printed communications there is no misunderstanding.

Major transportation users of Teletype equipment . . . air lines, railroads, and over-the-road carriers . . . maintain schedules, handle reservations, record manifests . . . use Teletype units to communicate in every way.

Automobile manufacturers use the selective aspects of this equipment to produce "custom styling" for your automobile.

Press associations use Teletype units to get news to all member papers simultaneously.

The list is practically endless . . . police, brokerage firms, hotels, chemical manufacturers, hospitals, Red Cross, steel companies, pipe lines, oil and gas refineries, universities, research organiza-

tions, mines . . . radio, electronic and computer systems manufacturers . . . wholesalers, retailers, distributors in every field . . . telephone, telegraph and cable companies . . . these and many more, all use Teletype equipment.

The stunt box plays an important role for these users of Teletype products. The proven dependability and accuracy of precision made, lab and field-tested Teletype equipment, augmented by the versatile stunt box, assures maximum operating flexibility and efficiency.

Every potential purchaser or lessee of communications, automation or data processing equipment should investigate thoroughly . . . determine not only current, but consider future needs before making an equipment choice.

Whatever the extent and complexity of the task ahead . . . Teletype Model 28 equipment is better equipped to do the job.

The acknowledged world leader in printed communications . . . equipment that bears the trademark "Teletype" . . . has more "BIG PLUS" features to offer.

Operator at keyboard of Teletype Model 28 Send-Receive Page Printer.

complete TELETYPE Model 28 product line of equipment is available

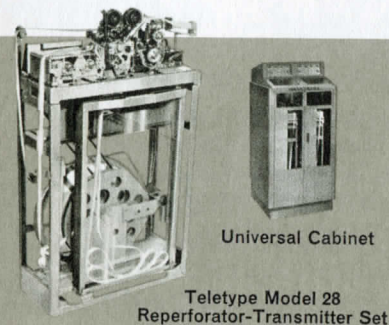
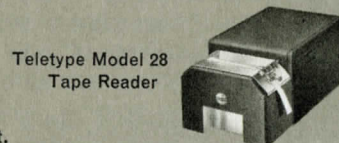

LITERATURE FREE

Descriptive literature concerning this equipment is yours for the asking. Please indicate the units that most interest you. Address below.

. . . to answer your specific questions Teletype application engineers will be pleased to help you to most efficiently apply Model 28 units to your communication problems. Why not contact Teletype today!

TELETYPE CORPORATION GENERAL OFFICES

5555 Touhy Avenue
Skokie, Illinois
Phone: Area Code 312
676-1000

TWX: 910-223-3611
(24-hour automatic answering service)
W.U. service on premises
TELEX: 02-5451

GOVERNMENT LIAISON OFFICE

425 13th Street, N.W.
Washington 4, D.C.
Phone: METropolitan 8-1016

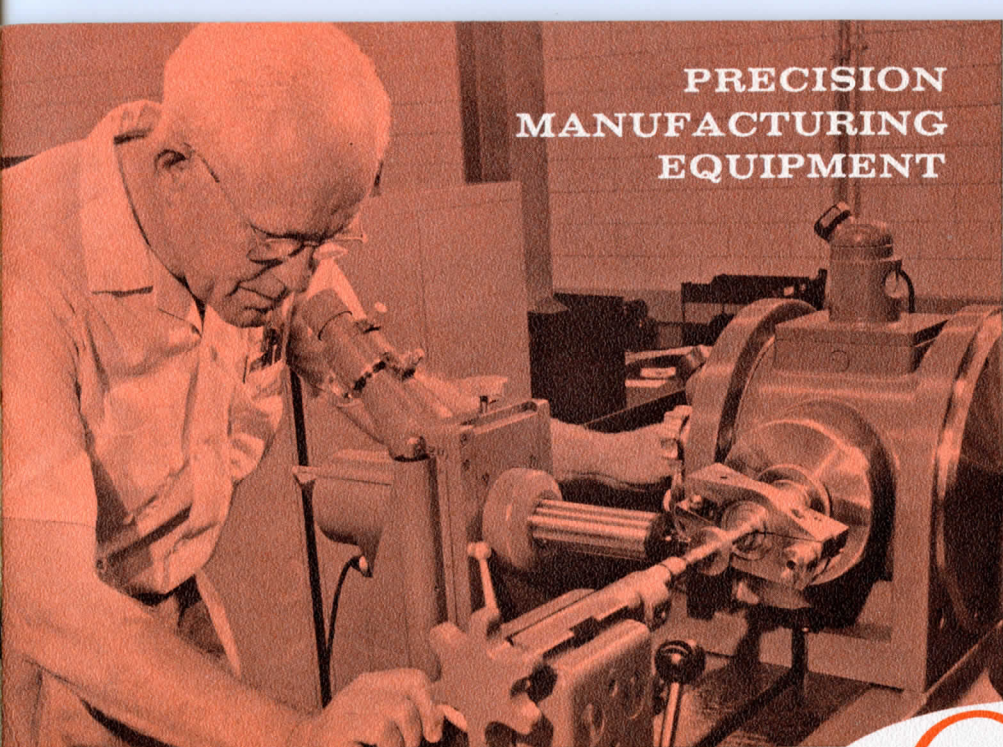

PRECISION
MANUFACTURING
EQUIPMENT



MODERN
MANUFACTURING
METHODS



QUALITY
ASSURANCE

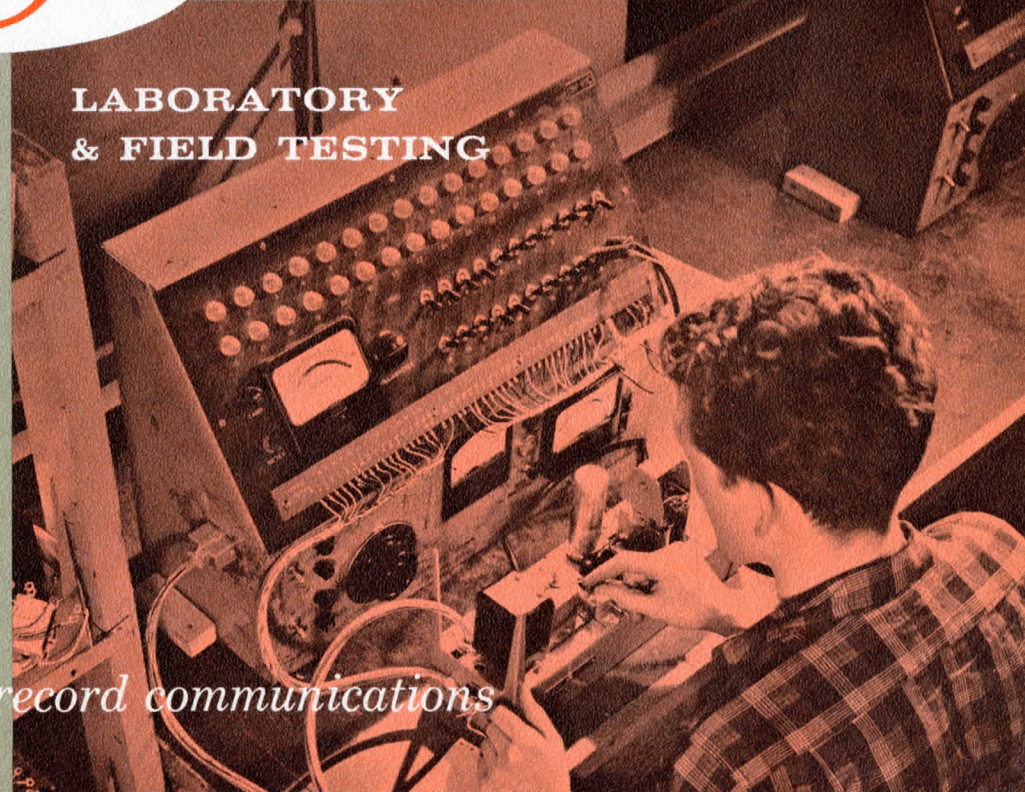

LABORATORY
& FIELD TESTING

over 50 years of acknowledged leadership in record communications

TELETYPE

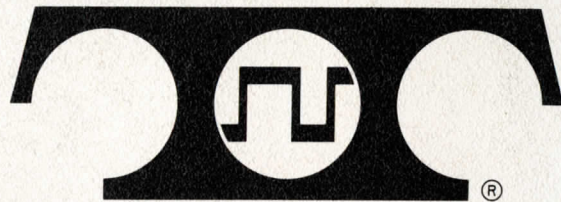

THE ACKNOWLEDGED LEADER

IN DATA COMMUNICATIONS

model **28** PRODUCT LINE