

CONTENTS

Page

Dedication	i
Preface	ii
Foreword	iii
Introduction	v

I GENERAL

Comments on Preparing a Teletypewriter Machine for Use with an Acoustical Coupler	G-1
Procedure for General Checkout of a Teletypewriter Station	G-2
Adjusting the Range Finder	G-3
Comments on Maintenance and Trouble Shooting	G-4
The Baudot Code	G-6
Publication and Supply References	G-7

II THE MODEL 15 (Refer to the M15 subcontents)	M15-1
---	-------

III THE MODEL 28 (Refer to the M28 subcontents)	M28-1
--	-------

IV THE MODEL 32 (Refer to the M32 subcontents)	M32-1
---	-------

V NOTES

TELETYPEWRITERS MADE EASY!

A Manual on Teleprinters Commonly
Used in the Telephone Network for the Deaf

Compiled by a staff of
teletypewriter devotees who, themselves,
are very much a part of the deaf network.

Paul L. Taylor, Editor
Frederick N. Stewart, Assistant Editor
Robert H. Weitbrecht, Model 15
Dan Skinner, Model 28
J. Thomas Rule, Model 28
Eugene L. McDowell, Model 32
Thomas R. Schwarz, Model 32

Teletypewriters for the Deaf, Inc.
Indianapolis, Indiana
May 1974

Copyrighted 1974 by "Teletypewriters For The Deaf, Inc."

THE WORKSHOP GANG



From left to right: Dan Skinner, Tom Schwarz, Gene McDowell,
Paul Taylor, Fred Stewart, Bob Weitbrecht, and Tom Rule.

To those dedicated servicemen who have devoted thousands of hours acquiring, transporting, rebuilding and rewiring ancient machines encrusted with grease and filth, and replete with broken, damaged, and worn parts; men who have hauled hundreds of pounds of equipment up and down rickety stairs and through dark passages to deliver these precious teletypewriters to their deaf recipients who never knew any other form of telephonic communications.

PREFACE

The preparation of these manuals was admittedly a crash program instituted to fulfill a pressing need. Perfection and completeness in the first printing was not expected. This is why the printing was done on standard loose leaf notebook paper... to facilitate corrections, revisions, and additions as feedback from field use dictates. An open forum will be maintained, with addendums issued in order of their pertinence or demand.

Paul L. Taylor

Frederick N. Stewart

FOREWORD

The teletypewriter (TTY) system with which deaf people communicate over the regular telephone lines with each other, with hearing relatives, and with organizations serving them, has been largely based on old equipment which has been discarded by the telecommunications industry as not worth repairing. One consequence of using such old machines is that the service manuals which provide instruction in reconditioning and maintaining the equipment are not easily decipherable by the layman.

Requests have been received from time to time by Teletypewriters for the Deaf, Inc. (TDI) for such service manuals, but unfortunately we have been unable to do more than provide a referral to individuals who possess such manuals and who are willing to photocopy them. Such a solution has not proven to be very satisfactory for one reason or another. The complexity of the manuals and the technical language therein tends to limit their usefulness to most deaf people who might be interested in reconditioning and maintenance.

TDI is pleased to present herewith a set of service manuals designed specifically for deaf people. They cover the basic types of equipment used by most stations in the system. Such equipment consists of the Model 15, the Model 28 KSR, and the new Model 32 KSR. A section is devoted to each model; there are three sections altogether in the manual. No attempt has been made to include other types of equipment such as the Western Union 100 series, the Kleinschmidt, the Mite, and the Model 26 since they are relatively scarce in the deaf network. The Lorenz machines

are basically an adaption of the Model 15.

This manual is designed and written not only for the serviceman, but also for those individuals who are interested in simple maintenance of their own equipment. To make it as useful as possible to the largest audience, the pictorial or illustrative approach has been emphasized with technical language reduced to a minimum.

The preparation of this service manual was carried out during a seven-day workshop in St. Louis, Missouri the week of May 5-11, 1974. Organized by Paul L. Taylor, Vice-President of TDI, the workshop brought together a group of men possessing expertise and experience in the various types of equipment. This group included Eugene McDowell, Thomas Schwarz, Dan Skinner, J. Thomas Rule, and Robert Weitbrecht. The photography was done by Tommy Joe Markham. Fred Stewart assisted Paul Taylor in the editing and overall supervision of the workshop. The typing was done by Sally Taylor and Peggy McLaughlin. The members of TDI, as well as other individuals, are grateful to them for their contributions.

The workshop and the publication of the service manuals were made possible through a loan from TDI which drew upon a revolving fund established by a grant made by the Lilly Endowment, Inc. in 1973. The repayment of the loan is expected to come from sales of the manuals to interested parties.

TDI hopes that all users of the service manuals will find them useful and that a need has been fulfilled. Comments from readers are most welcome.

H. Latham Breunig, President
TELETYPEWRITERS FOR THE DEAF, INC.

INTRODUCTION

The Model 15 Teletype machine was manufactured by Teletype Corporation of Chicago, Illinois, during the years between the late twenties and the early fifties. It is a reliable heavy duty teletypewriter, in use for years by news agencies, Bell System's Teletypewriter Exchange (TWX), Western Union Telegraph Company, the railroads, and the armed services - especially during WW II. Hundreds of thousands of such M15 units have been produced.

The Model 28 Teletype machine, manufactured since the 1950's, and still in production (also part of Model 35), is a modern version of the earlier machines. It is fitted with a versatile "stunt box"--which permits control of outside accessories such as reperforators, call sequencers, even a coffee pot, or anything--upon receipt of certain signals placed thereto. Hundreds of thousands of such Model 28's exist.

The Model 32 Teletype machine is a low-cost, light-duty type, made with many plastic parts. It is fairly reliable, and should serve well for years on a 60-wpm network such as TDI has. A similar machine, called the Model 33, is in wide use by computer users, and parts are quite interchangeable.

This Manual concerns only the above three types. There are other types, perfectly compatible, communications-wise with all these types. Such include the Model 14 Teletype tape printers, the Model 19 Composite Set (Automatic Send and Receive = ASR), the Model 26 Teletype page printer, the Kleinschmidt 100, the Western Union 100-series, the MITE Corp. teleprinter, the Creed,

the Lorenz, the Siemens, and the Olivetti. Thus, many makes of machines are to be found in use in the TDI network. However, Model 15 and 28 Teletype machines continue to be widely available, with possible future availability of quantities of Model 32 units.

The Baudot Code was originated by Emile Baudot, a French telegraph engineer, some 100 years ago. It is a 5-level code, with $2^5 = 32$ different combinations available. The modern 5-level code is somewhat different in character assignments from the original Baudot. Murray devised the present code, with start and stop elements added to permit what is called "start-stop telegraphy"--a distinct advance over the original Baudot which required a multiplex scheme. Hence, some engineers call this code a "seven element code". Actually, the code contains five intelligence elements. Hence the term 5-level. It is one of the simplest and most efficient signaling codes known, and universally used to recent times by teleprinter manufacturers around the world. No wonder there are so many different makes of machines, all compatible to each other when geared to the same speed, 60 wpm nominal, 45.45 Baud, as employed in our TDI network.

Monsieur Emile Baudot would be proud to know that his machines are making thousands of deaf people happy, in being able to telecommunicate with each other. Indeed, we are grateful to all the makers of equipment, such as the Teletype Corporation, in particular, for generous contributions to the welfare of Teletypewriters for the Deaf, Inc. and its network.

GENERAL

COMMENTS ON PREPARING A TELETYPEWRITER
MACHINE FOR USE WITH AN ACOUSTICAL COUPLER

Used teletypewriter machines come in a variety of conditions. Some (such as those from Western Union) may be immediately usable upon receipt. Bell System machines usually require rewiring, along with installation of new power and signal plugs and cords. Machines may come with tables or consoles, or without either. For our purposes, it is well to recondition each machine so that it will render satisfactory service for a long period of time. In this way, each teletypewriter owner is assured of the best possible setup for his needs.

Each machine will have three cords and plugs, all of suitable length to easily reach an acoustical coupler unit placed near a telephone. A suggested length is 8 feet. In this way, the cords can be cabled together and placed out of the way.

Two of the cords look alike, ending in red and black phone plugs; the red indicated MAGNET LINE while the black indicates KEYBOARD LINE. The third cord ends in a safety 115 VAC plug usually having an U-shaped grounding pin for eliminating shock hazards.

Specific instructions are given in the various sections referring to Models 15, 28, and 32 teletypewriters.

PROCEDURE FOR GENERAL CHECKOUT OF A TELETYPEWRITER STATION

1. Dial the telephone number of a news station known to have an accurate (zero bias) signal.
2. With the news coming in, take range finder measurements. Move the range finder lever towards lower numbers, and watch the printing. When it starts to garble, move the lever up slightly - try to find a setting at which printing is just barely garbling. Read the number. It may be 21, for example. Now do this on the other end of the range finder - higher number. It may be 105, for example. The machine is found to have a range span of $105 - 21 = 84$ points.
3. With the news shut off, the keyboard can now be checked. Send various words like THE QUICK BROWN FOX....., and you find a low number and a high number at which your TTY starts to misprint. Read the numbers. They might be 25 and 98; thus the keyboard has some distortion; $98 - 25 = 77$ points.
4. In general, if a given installation has a range span of 70 points or better, it is in good adjustment. Note that this is an overall check on both typing unit and keyboard systems.
5. FINALLY, when all range measurements are completed, center the range finder of your machine, thus halfway between 105 and 21. An easy way to find the center is to add 105 and 21, then divide by 2, thus $126/2 = 63$. The range finder lever is moved to 63 and clamped there.

ADJUSTING THE RANGE FINDER

The range finder usually looks something like a drawing compass with a pointer clamped to the semi-circle with a knurled screw.

With the cover removed, turn your TTY on and loosen the knurled screw on the range finder pointer.

While hitting RYRYRYRYRY....repeatedly, slowly move the pointer in one direction until the printing just begins to garble. Stop and note the number on the semi-circle.

Now again, hit RYRYRYRYRY...repeatedly and slowly move the pointer in the opposite direction until the printing just begins to garble again. Note the new pointer position number.

If the difference between the two numbers is less than 40, check lubrication, magnet adjustment, contact spacing and cleanliness, and look for slipping clutches, worn bearings on the mainshaft, improper gear meshing (binding or backlash), etc.

After remedying any indicated service needs, finally clamp the range finder midway between the two positions where garbling starts.

COMMENTS ON MAINTENANCE AND TROUBLESHOOTING

After the teletypewriter has seen some service, it may sooner or later require some attention. The best advice concerning preventive maintenance is to leave the machine alone as long as it is giving satisfactory service. An exception is the annual oiling of the machine, but even that ritual is not absolutely mandatory, mainly due to the low number of hours the machine is in service among the deaf in comparison to its normally high usage in the communications industry.

If your machine looks dry, it probably needs oiling. From experience, the best oiling procedure is to apply a drop or two of oil and no more wherever moving parts slide over one another, especially rotating parts. Excessive oil can absorb dirt and become gummy. Locations of oiling places are easily observable by typing with the cover removed. Particularly, the gears, bearings, oil cups, and felt cloth washers (in clutches) should be oiled.

When your machine does not work properly, the first thing to do is to keep calm about it. Try to be methodical in your attempts to locate the trouble. Keep in mind that your communication station not only involves your teletypewriter but also the acoustical coupler and the telephone. It is very possible that your teletypewriter is perfectly all right and that the problem exists elsewhere.

Below is a suggested order of troubleshooting sequence to isolate your problem:

1. Check your acoustical coupler. If you are not sure, borrow one from a friend.
2. If the above step does not remedy your problem, then the problem exists either in the keyboard unit or the typing unit of your teletypewriter. It is unlikely the problem is in both units at the same time.
3. To determine which unit is not working properly, perform the following receiving and transmission tests:
 - a) Receiving - make arrangements to have a friend type messages from his station or call an automatic message station such as the news or weather station if one exists in your area. If your copy is good and clear, then your typing unit is working satisfactorily.
 - b) Transmission - make arrangements to have a friend read your messages at his station. If your messages are clear on his copy, then the keyboard unit is working satisfactorily.
4. If you are able to isolate the malfunctioning unit, then your search will be made simpler.
5. Refer to the appropriate section in this manual according to your teletypewriter model for further helpful hints.

BAUDOT CODE

○ SPACE

● MARK

	BIT # → 1	2	3	4	5
A -	●	●	○	○	○
B -	●	○	○	●	●
C -	○	●	●	●	○
D -	●	○	○	●	○
E -	●	○	○	○	○
F -	●	○	●	●	○
G -	○	●	○	●	●
H -	○	○	●	○	●
I -	○	●	●	○	○
J -	●	●	○	●	○
K -	●	●	●	●	○
L -	○	●	○	○	●
M -	○	○	●	●	●
N -	○	○	●	●	○
O -	○	○	○	●	●
P -	○	●	●	○	●

Q -	●	●	●	○	●
R -	○	●	○	●	○
S -	●	○	●	○	○
T -	○	○	○	○	●
U -	●	●	●	○	○
V -	○	●	●	●	●
W -	●	●	○	○	●
X -	●	○	●	●	●
Y -	●	○	●	○	●
Z -	●	○	○	○	●
BLANK -	○	○	○	○	○
CAR. RE. -	○	○	○	●	○
L. FEED -	○	●	○	○	○
SPACE -	○	○	●	○	○
LTRS. -	●	●	●	●	●
FIGS. -	●	●	○	●	●

REFERENCES

There are at least three books, of main interest to amateur radio teletypewriter operators; however, they contain much useful information relating to Teletype machines. The first two books listed below are of more interest to those having Models 15, 28, and 32 units; the third book, from Radio Society of Great Britain, cater more to Creed machines, with a rather sketchy description on the Teletype Model 15. It is a fabulous book for those wishing to explore more thoroughly the theory behind radio teletypewriter operations.

1. RTTY FROM A TO Z, by Durward Tucker
Cowan Publishing Corp.
14 Vanderventer Ave. \$5.00
Port Washington, N. Y.
2. The New RTTY Handbook, by Byron Kretzman
Cowan Publishing Corp.
14 Vanderventer Ave.
Port Washington, N. Y. \$3.95
3. The Teleprinter Handbook (RSGB Publication)
Ham Radio Books
Greenville, New Hampshire 03048 \$14.95

Some information relating to hardware as used in the Teletypewriters for the Deaf network may be found in the "Green Book":

First National Conference of Agents of
Teletypewriters for the Deaf, Inc.
November 13-14, 1971
Gallaudet College, Washington, DC.

Obtainable through various TDI agents or
from Teletypewriters for the Deaf, Inc.
P. O. Box 622, Indianapolis, Ind. 46206.

TELETYPE CORPORATION BULLETINS

There are many bulletins, some old, some new, on the Teletype Corporation Models 15, 28, and 32. Some may be found through friends connected with the Telephone Company or with Western Union. Others may be procured through some of the suppliers, such as BVE Enterprises.

Bulletin 138B	Adjustments Model 15
Bulletin 216B	Description and Principles Model 28
Bulletin 217B	Adjustments and Lubrication Model 28
Bulletin 273B	Vols. 1 and 2: Technical Manual Model 32 and 33
Bulletin 1037B	Parts Catalog Model 15
Bulletin 1149B	Parts Model 28
Bulletin 1164B	Keytops and Pallets
Bulletin 1184B	Parts Model 32 and 33
Bulletin 1210B	Parts Model 32

SUPPLIERS

These dealers handle surplus teletypewriter equipment, parts, and other related items. Other makes of TTYs, such as Lorenz, Kleinschmidt, and Siemens, may be found at such places, as well as Teletype Corp. equipment. This is only a short list; undoubtedly, there are other surplus dealers, out West, who handle such items.

Andy Electronics
6319 Long Drive
Houston, Texas 77017

BVE Enterprises
Box 73
Paramus, N. J. 07052

Typetronics
P. O. Box 8873
Fort Lauderdale, Fla. 33310

Van's W2DLT Electronics
302 Passaic Avenue
Stirling, N. J. 07980

THE MODEL 15 TELETYPE ^R

Registered trademark of the Teletype Corporation

CONTENTS

	Page
A. Rewiring a Model 15 Teletype Machine	M15-5
B. Oiling the Model 15 Teletype	M15-19
C. Contacts on the M15 Keyboard	M15-39
D. Procedure for Adjusting Contacts on a M15 Keyboard	M15-47
E. Modification of a Model 15 Keyboard for Easy Action	M15-51
F. Gears on Certain Western Union Model 15 Keyboards	M15-53
G. The Selector Mechanism on a M15 Teletype	M15-55
H. Two Different Types of Selectors on Model 15	M15-59
I. Motor Gearing on Model 15 Teletype	M15-61
J. Baud Rate in Telegraph Systems	M15-66
K. Left Margin Adjustment on Model 15 Teletype	M15-69
L. Unshift-on-Spacebar-Model 15 Teletype	M15-71
M. Western Union Model 15-19 Teletypewriters	M15-72
N. Miscellany - Model 15	M15-76

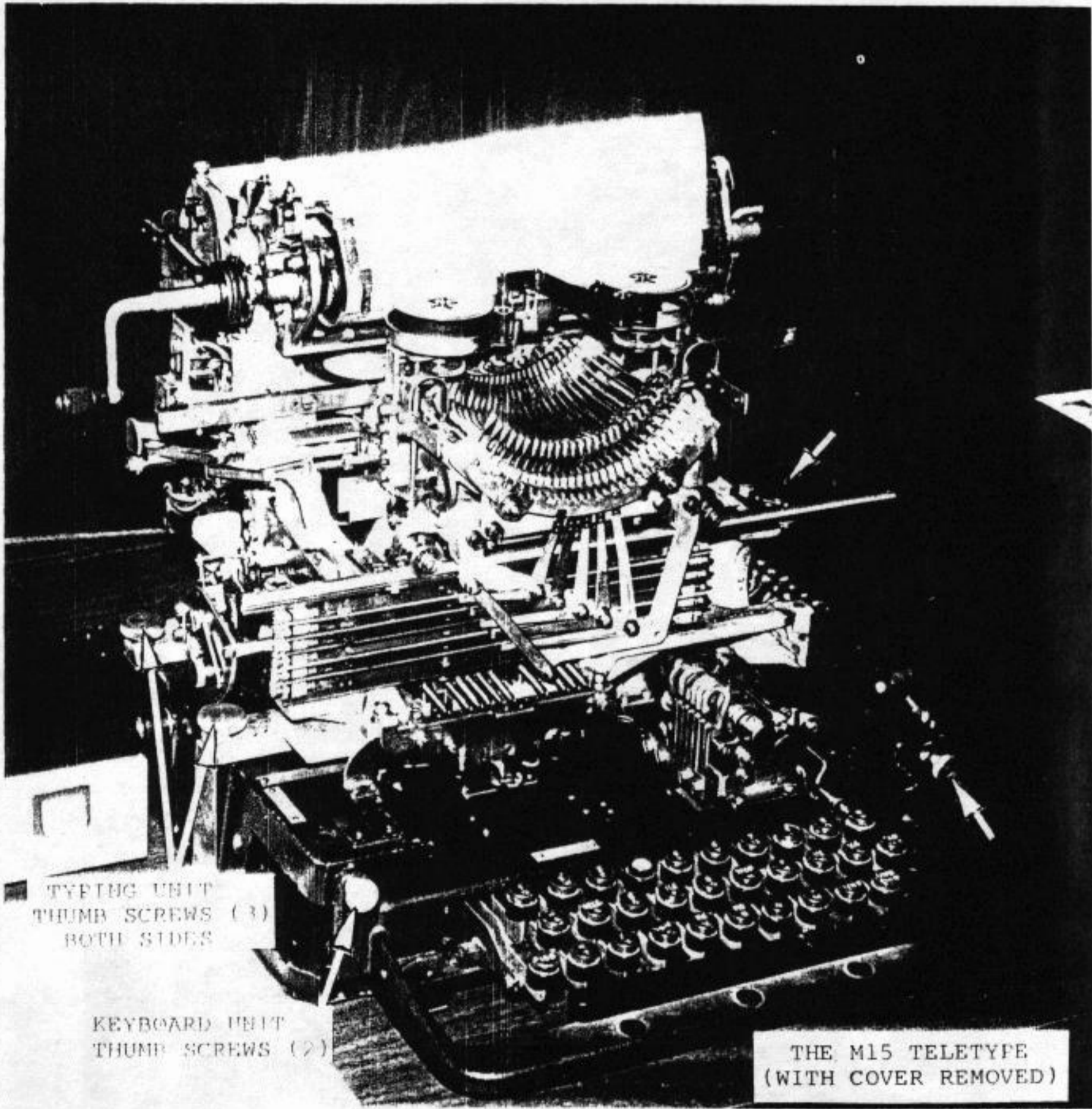

TYPING UNIT
THUMB SCREWS (3)
BOTH SIDES

KEYBOARD UNIT
THUMB SCREWS (2)

THE M15 TELETYPE
(WITH COVER REMOVED)

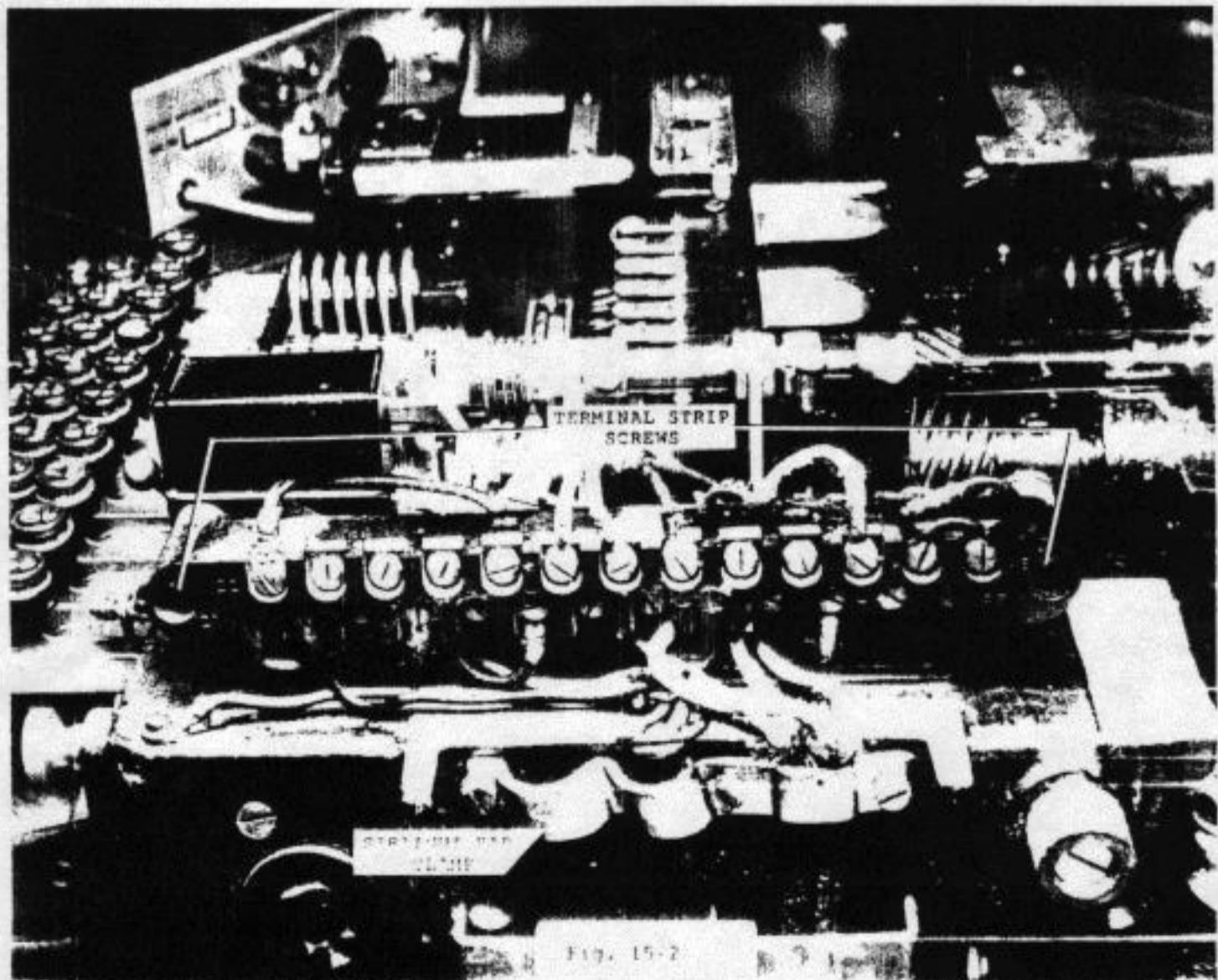
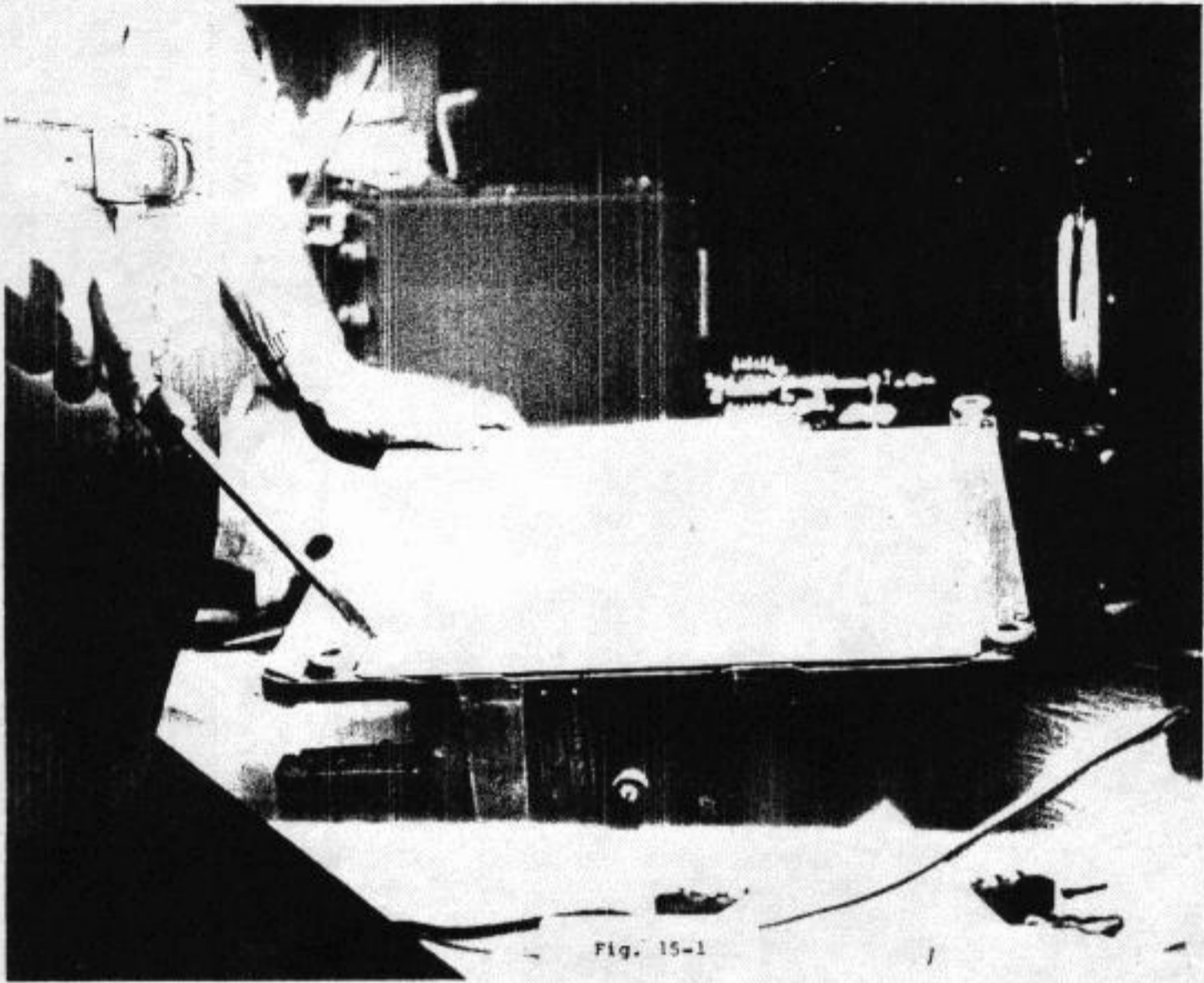

A. REWIRING A MODEL 15 TELETYPE MACHINE

Model 15 machines have a lot of wiring, usually in poor condition, in their bases. Such wiring should be stripped out and discarded. After all, only six wires are required to provide complete connections. An hour or so of work should provide neat electrical installation.*

In preparation for such work, the TTY machine is placed on a workbench. No power connections this time; do not plug the TTY into any wall power outlet. The TTY cover is lifted straight up and out, it is set aside. After removing three large thumb screws (two on the left side and one on the right), the typing unit is lifted off and set aside. Next, the keyboard unit is pulled out (after loosening two small thumb screws, one on the left and the other on the right). Finally, the bottom plate of the TTY base is removed; just take out the four corner screws. Save these screws, including all loose parts, as most of them are usable. Fig. 15-1.

1. Remove all old power and signal cords from the terminal strip on the right side of the base. Loosen the straight-bar clamp (three screws) in order to release the cord. Fig. 15-2.
2. Remove two long screws holding the terminal strip to the TTY

* The rewiring is optional. Some people may prefer to leave the original base wiring alone, if it appears in good condition, in spite of the complexity.

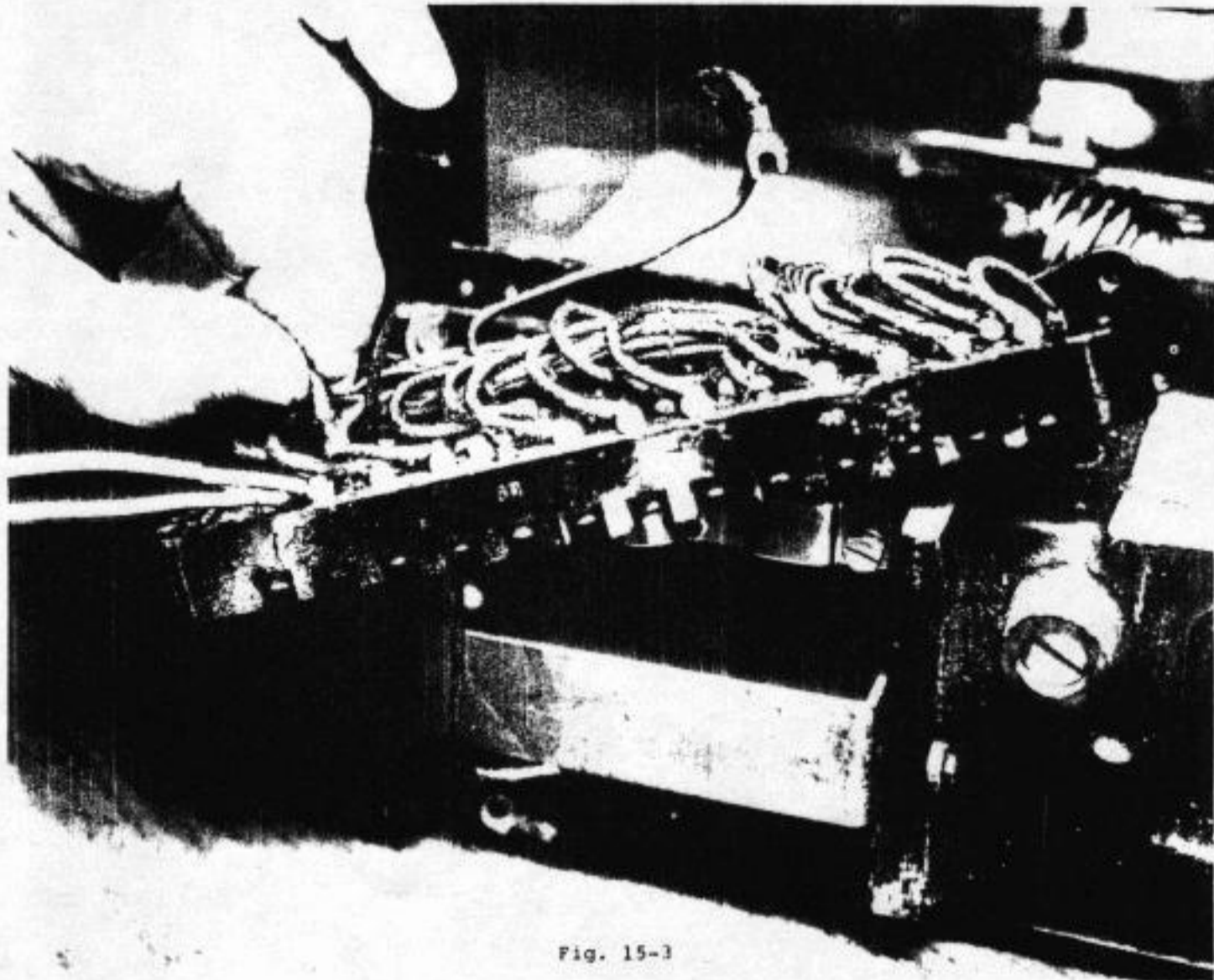
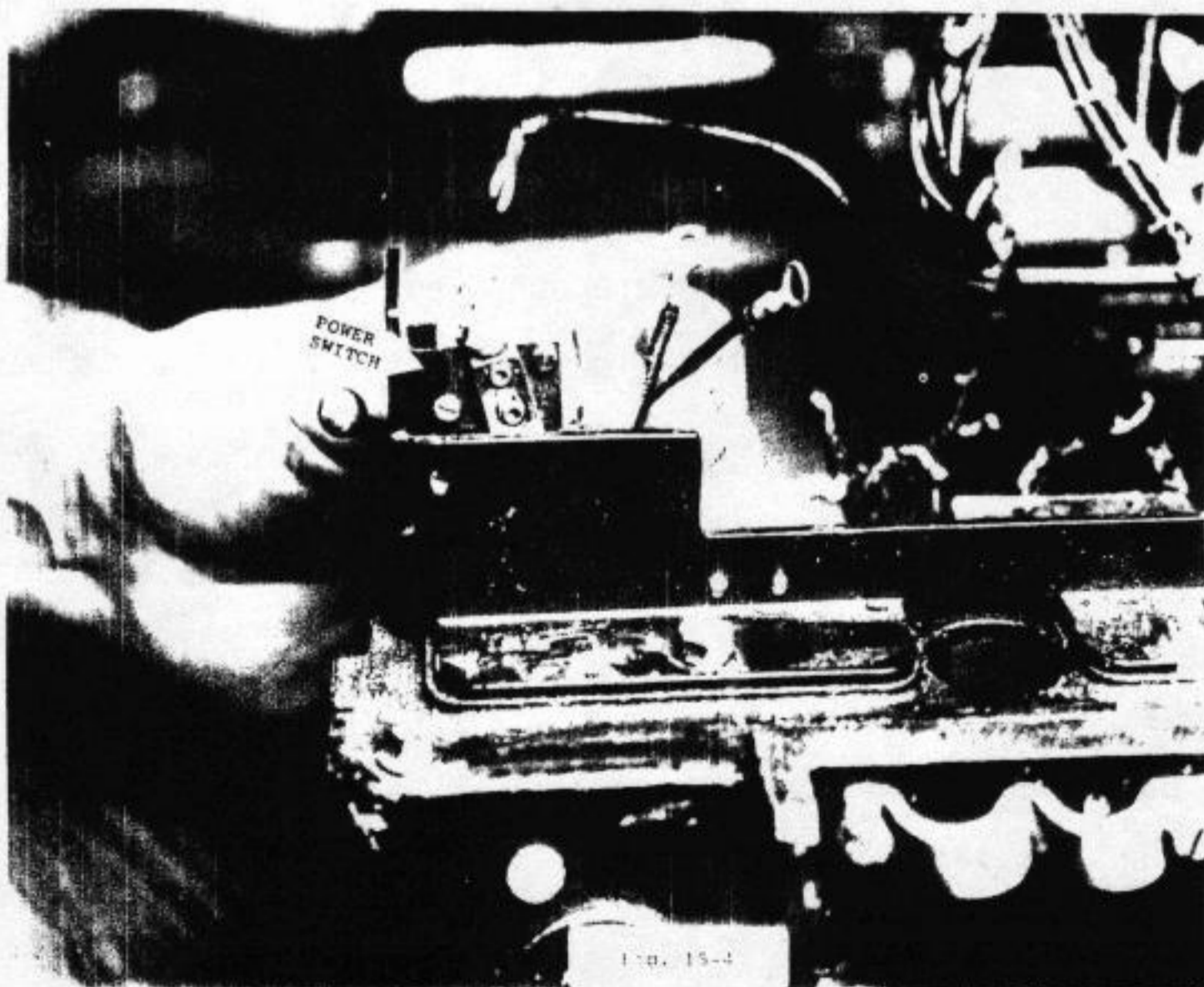

Fig. 15-3



M15-6

- base. Save these screws, along with the two metal spacers.
3. Using a hot (100-watt size) soldering iron, unsolder all connections from the pins on the back side of the terminal strip. Using a pair of long nose pliers, pull each wire off each pin, after it has been heated well enough to assure easy unsoldering and pulloff. After all wires have been removed, set the terminal strip aside. Fig. 15-3.
 4. Uncover the power switch (remove the black cover, after loosening two screws just behind the cover. DO NOT LOSE THE INSULATING FIBERBOARD WHICH IS INSIDE THE COVER BOX. Remove the old wires from this switch. Fig. 15-4.
 5. On the left front corner of the base there is a Send-Receive-Break switch assembly. Unsolder all wires going to this part. If desired, the assembly can be removed and discarded. It is, however, recommended that it be left on the base, for possible future use.
 6. Turn the base upside down. There is a maze of old wires inside. TAKE IT ALL OUT. Remove the wire clamps. Unsolder all connections going to the keyboard and motor slip-contact assemblies. Pull the old wires out through the various holes. Cut through the cabling going through a large hole to the rear deck of the base. Fig. 15-5.

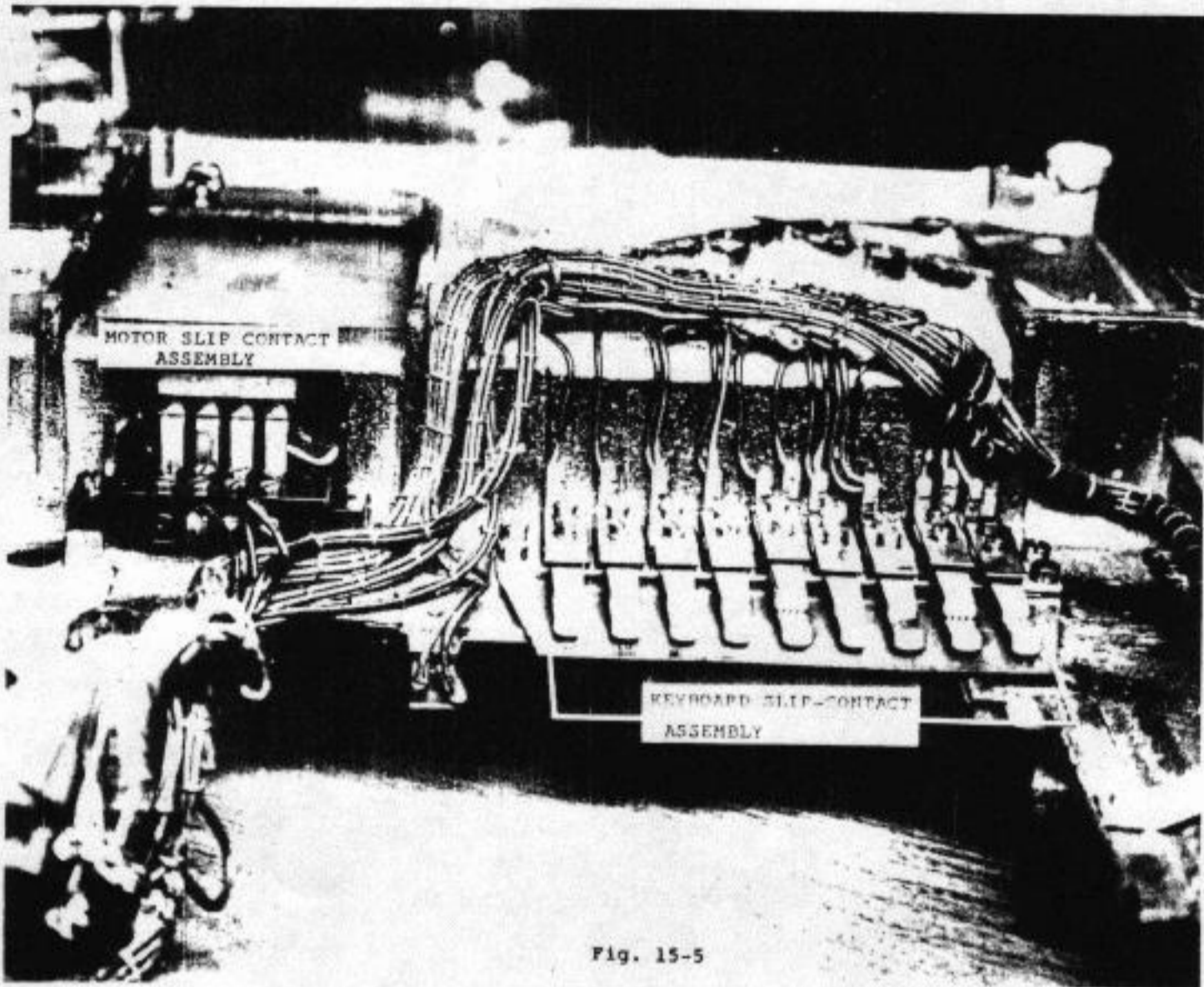

Fig. 15-5

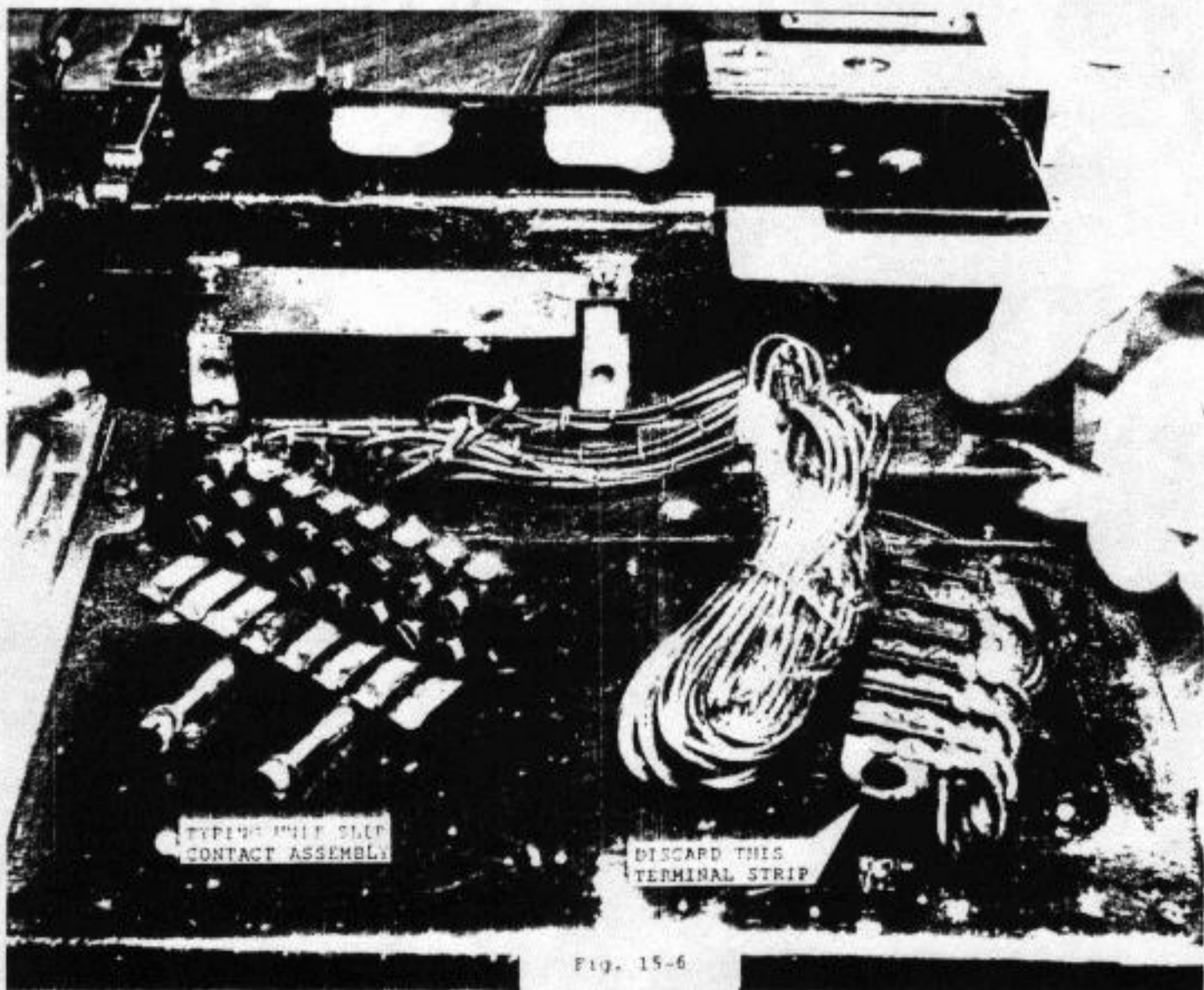

Fig. 15-6

7. With the base topside up, remove two screws holding the typing-unit slip-contact assembly. Unsolder and pull all old wires. Discard the small terminal strip which is on the left rear corner of the base deck, but save the typing-unit slip-contact assembly. Fig. 15-6.
8. You should have a base completely bare of all old wiring. Clean it up, with a rag, going after all oily spots and areas. A little naphtha will help. Fig. 15-7.

The base is now ready for installation of new wires. We will use good quality insulated wire; do not use rubber covered wire, because oil causes rubber to deteriorate. Obtain some Number 18 gauge stranded wire from a hardware store; it should be well covered with plastic insulation. Obtain, also, some No. 6 solder lugs, as we will be needing them to make certain connections. VACO has a stack of plastic boxes containing solder lugs; get the lug that has a hole to pass a No. 6 screw; this style is preferable to the spade lugs also available.

9. Wiring the Motor Power Connections...

- a) Take a length of plastic-insulated wire and solder one end on Pin 23 on the terminal strip (which, by this time, has been remounted on the base). Fig. 15-13. Run this wire through the hole in the base and downward underside to the motor slip-contact assembly. Solder the wire to one slip contact as shown in Fig. 15-8.

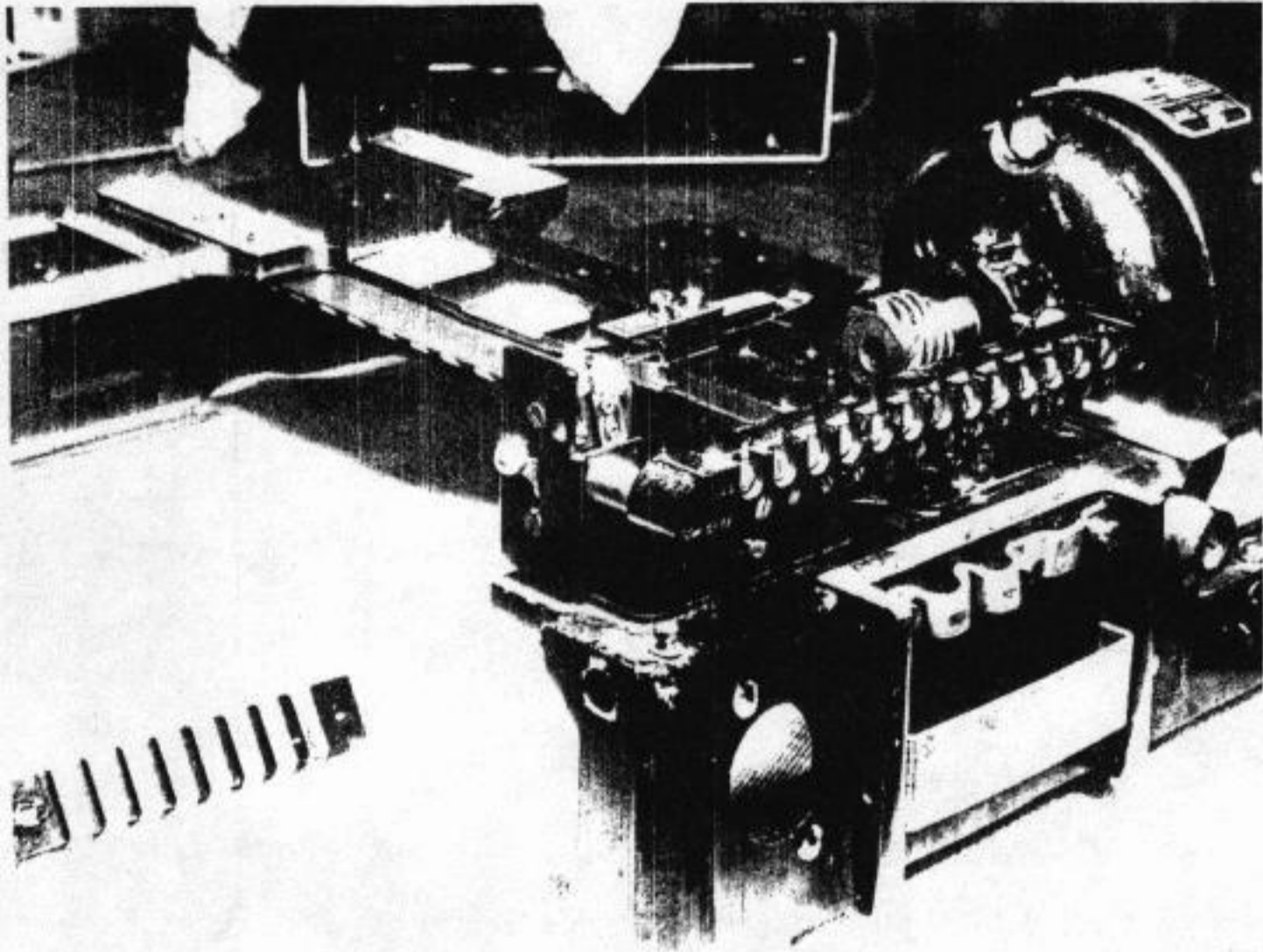

Fig. 15-7

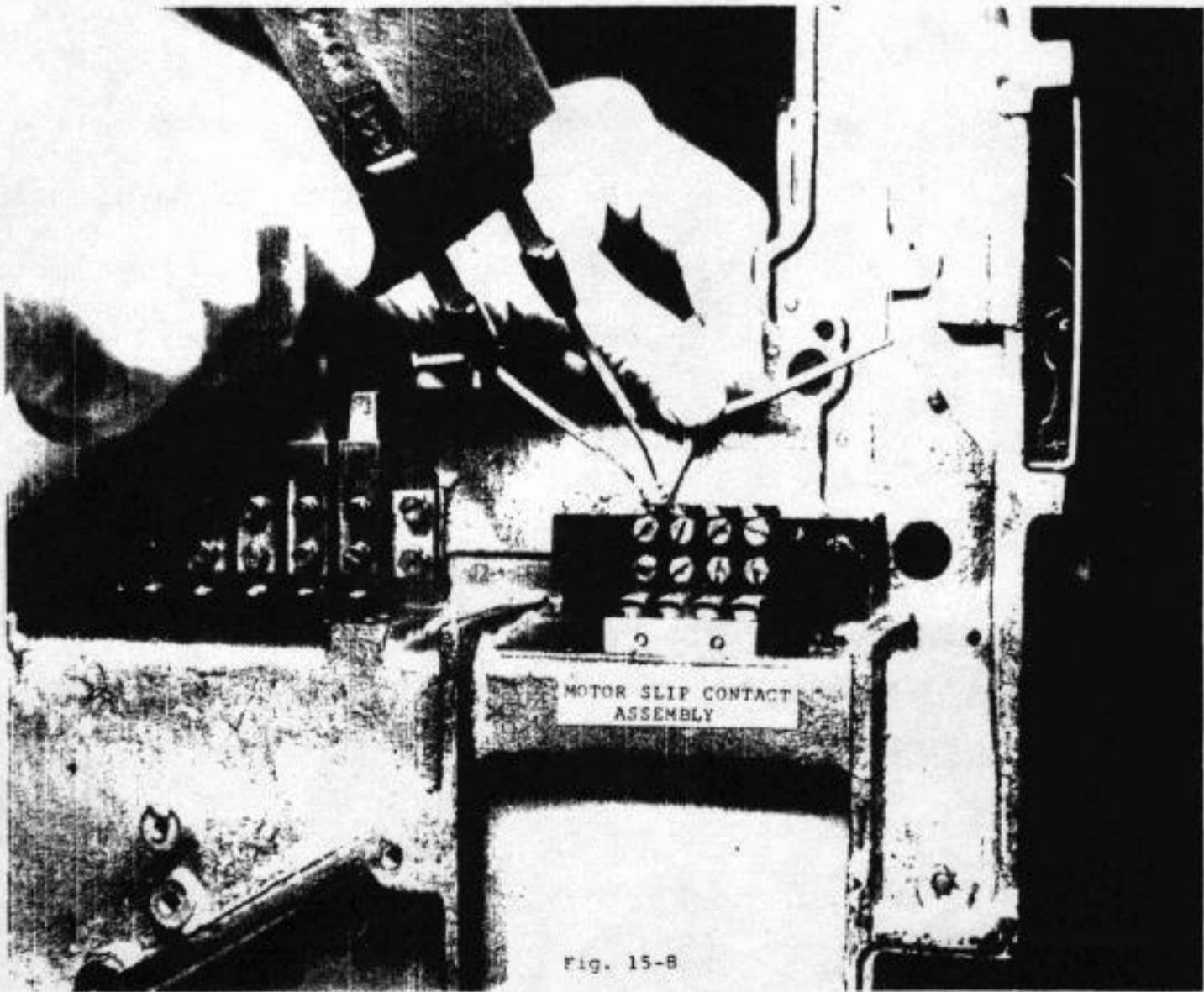

Fig. 15-8

M15-10

b) Attach another length of wire to Pin 21 on the terminal strip; run this wire through the base to the power switch. Mount a solder lug on the end of this wire, and screw it on one side of the switch. Attach a new piece of wire (with solder lug mounted) to the other side of the power switch; run this wire out and attach it to another slip contact on the motor slip-contact assembly. See Fig. 15-9. This completes the motor power connections.

10. Wiring the Keyboard Connections...

- a) Take a length of plastic insulated wire; solder one end on Pin 31 on the terminal strip. (Fig. 15-13). Run this wire through the base to #4 slip contact on the keyboard slip-contact assembly. Be sure to route the wire close to the inside corners in the base, as the keyboard will fit into this confined space.
- b) Using a short piece of wire, make a jumper connection from #4 slip contact to shorting contact on #5 slip contact.
- c) Run a wire from #5 slip contact to pin 33 on the terminal strip. This completes the keyboard connections in the base. (Fig. 15-10).

11. Wiring the Magnet Connections...

- a) Take a length of plastic insulated wire; solder one end on Pin 43 on the terminal strip. (Fig. 15-13). Run this wire through the base, going through two holes, to the rear deck of the base. Attach this wire to the #3 slip contact

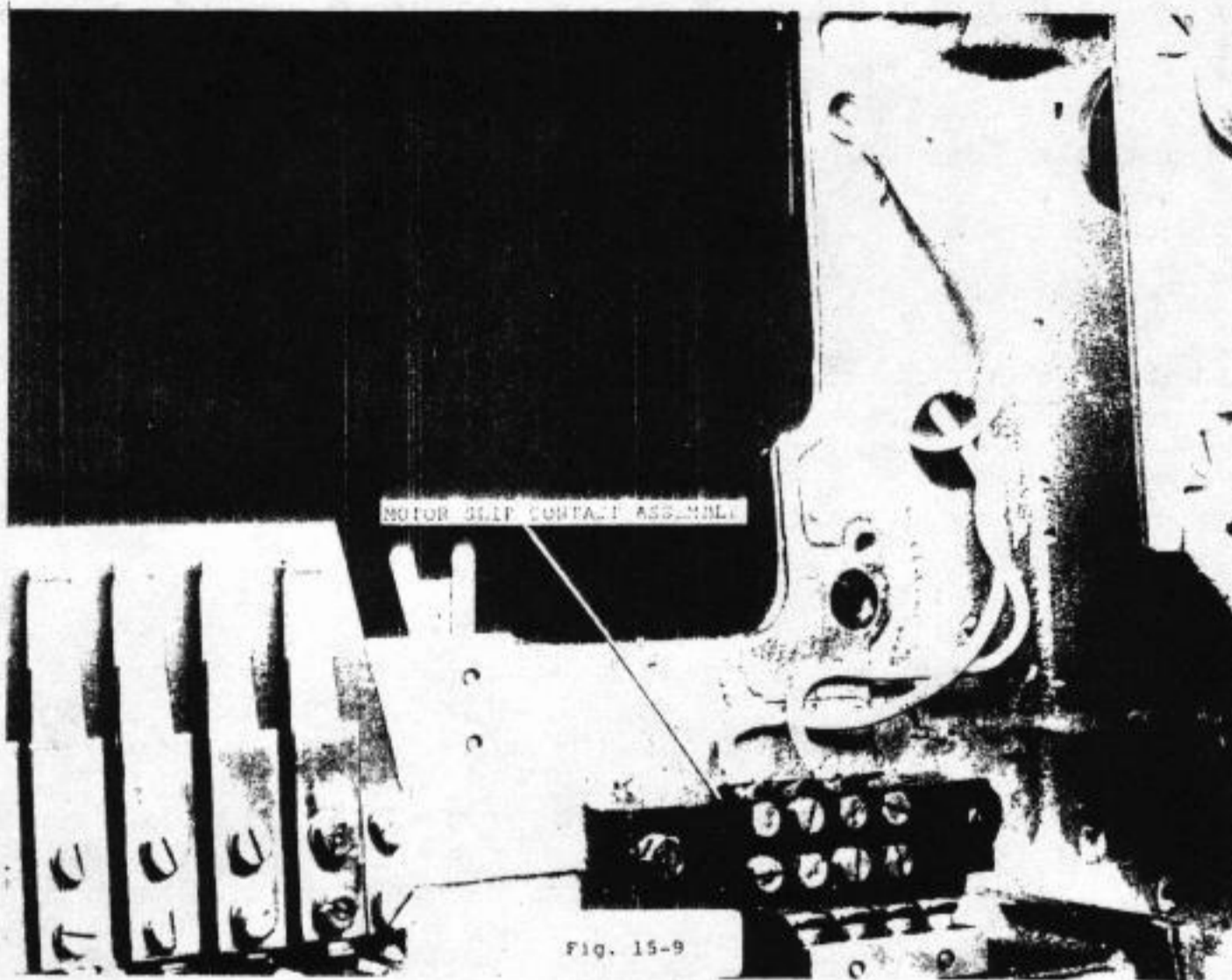

Fig. 15-9

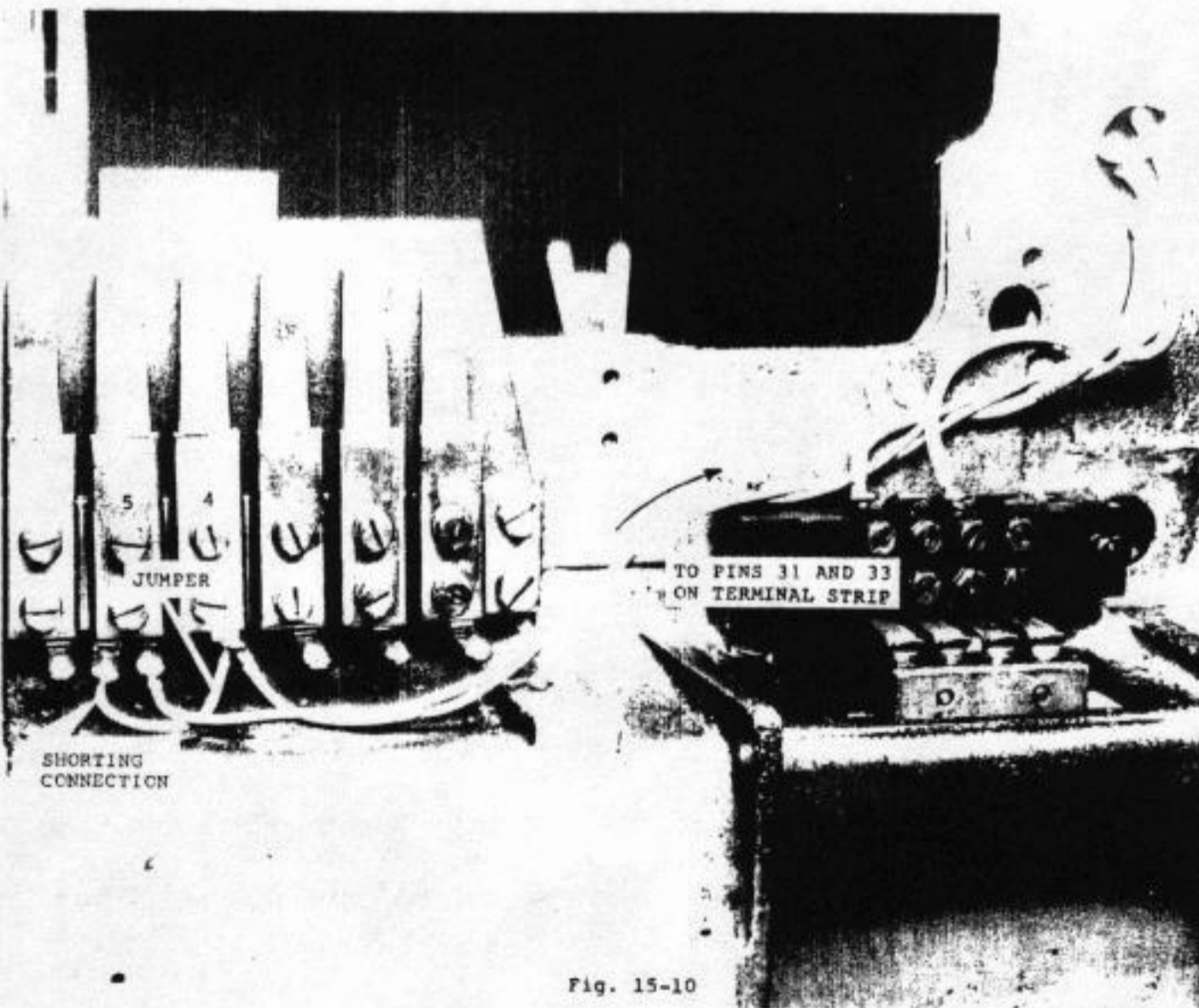

Fig. 15-10

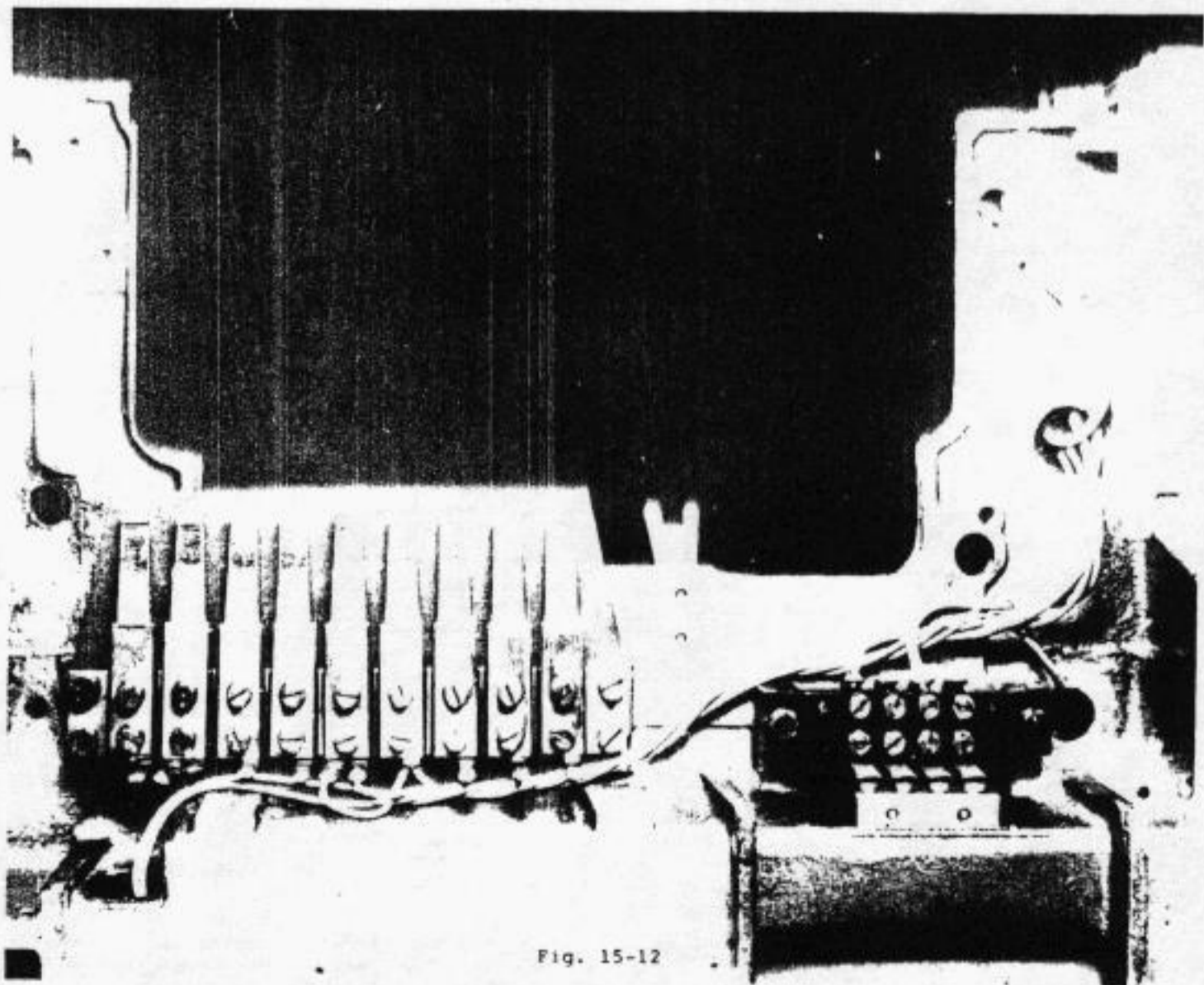
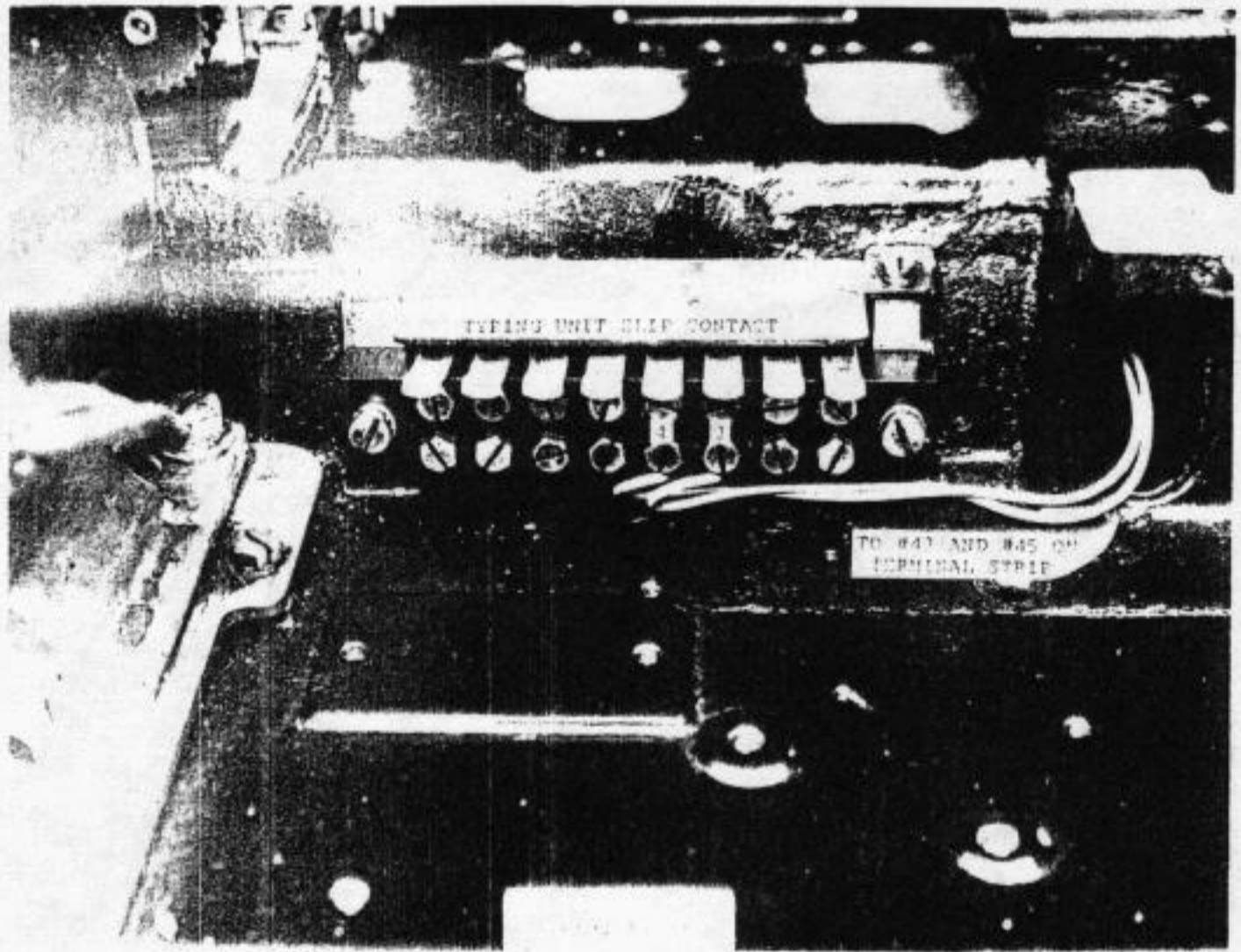
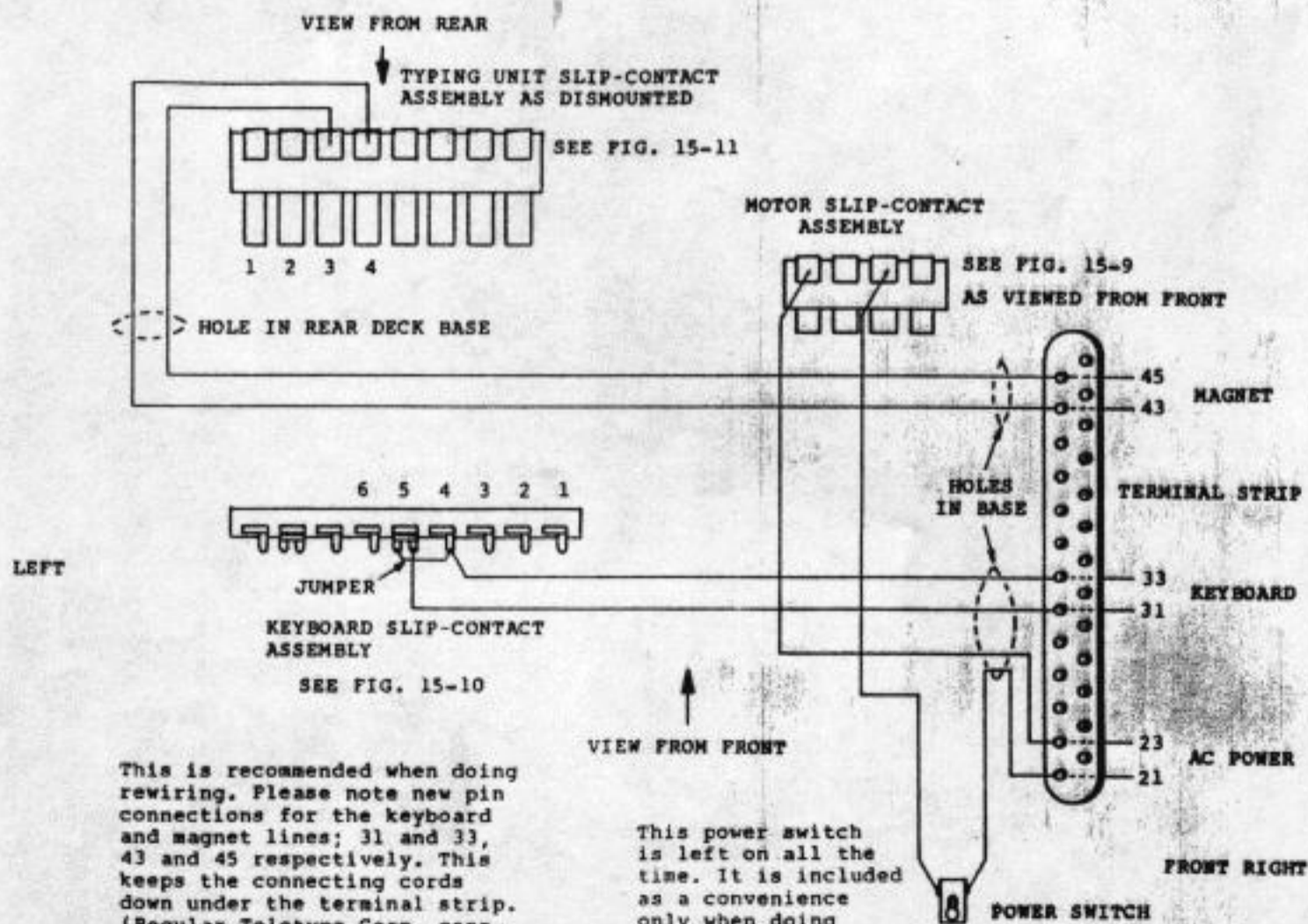
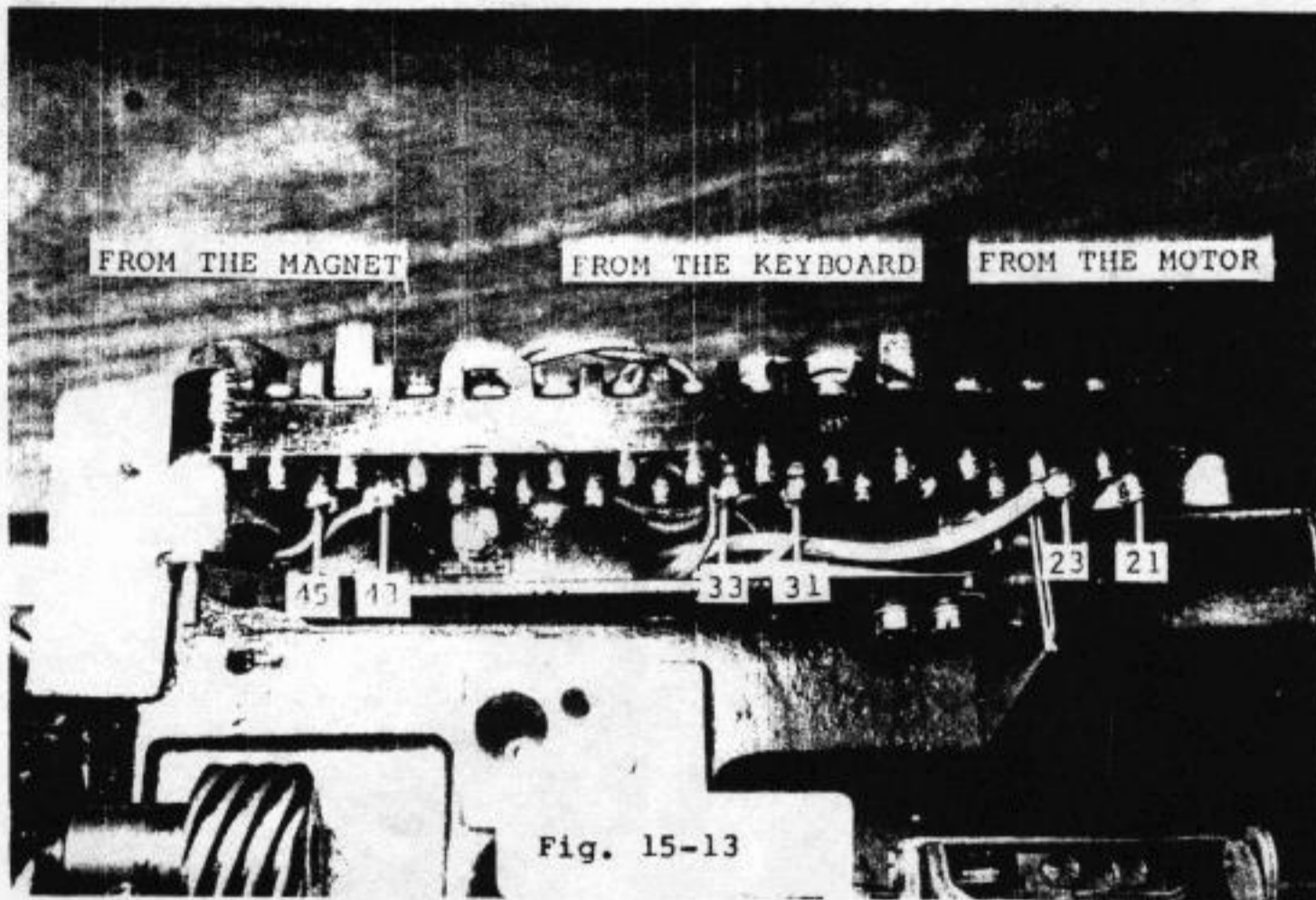

Fig. 15-12



This is recommended when doing rewiring. Please note new pin connections for the keyboard and magnet lines; 31 and 33, 43 and 45 respectively. This keeps the connecting cords down under the terminal strip. (Regular Teletype Corp. connections are 32 and 34, 45 and 46 respectively.)

Fig. 15-14

This power switch is left on all the time. It is included as a convenience only when doing adjustments to the machine during which the TTY motor must be turned off. The Acoustic Coupler has a power switch which is always used to turn power on or off to the entire installation.

on the typing-unit slip-contact assembly.

b) Run another piece of wire between Pin 45 and #4 slip contact on the typing-unit slip-contact assembly. Fig. 15-11.

12. Be sure to bundle all wires so they will lay close to the deep corners and recesses inside the base. If necessary, use some linen string or nylon fish line to lace the wires together into a cabling. This will provide a neat installation. See Fig. 15-12. Also, see Fig. 15-13. The M15 base wiring diagram is in Fig. 15-14.

This completes the clean up and rewiring of the M15 base.

Now, all we need to do, to make connection to the Acoustic Coupler box, is to make up a set of three cords and plugs. Depending on the TTY installation, the distance may be 3 ft. between the M15 machine and the coupler, or it might be 6 or 8 feet. In general, 6 feet would be about right.

Procure two 6-ft. lengths of two-wire black vinyl-covered lampcord, size 18 wire stranded; one 6-ft. length of three-wire black vinyl-covered power tool cord, size 18 wire stranded; one 3-pin safety-ground power plug; and two phone plugs--one to be red and the other to be black. Switchcraft plugs are available from an electronic supply store; quite likely all materials can thereby be obtained. Be sure to buy some VACO solder lugs (crimp type) although soldering wires into lugs is recommended. #6 lugs will have holes; no spades.

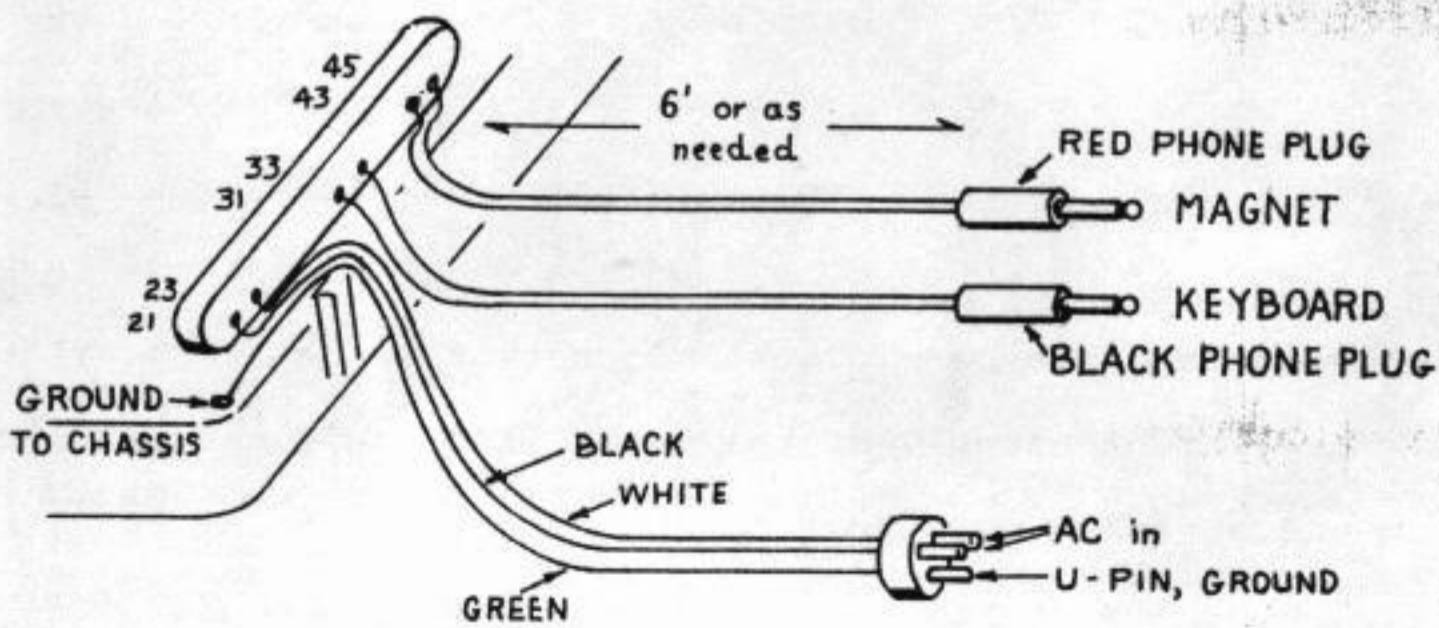
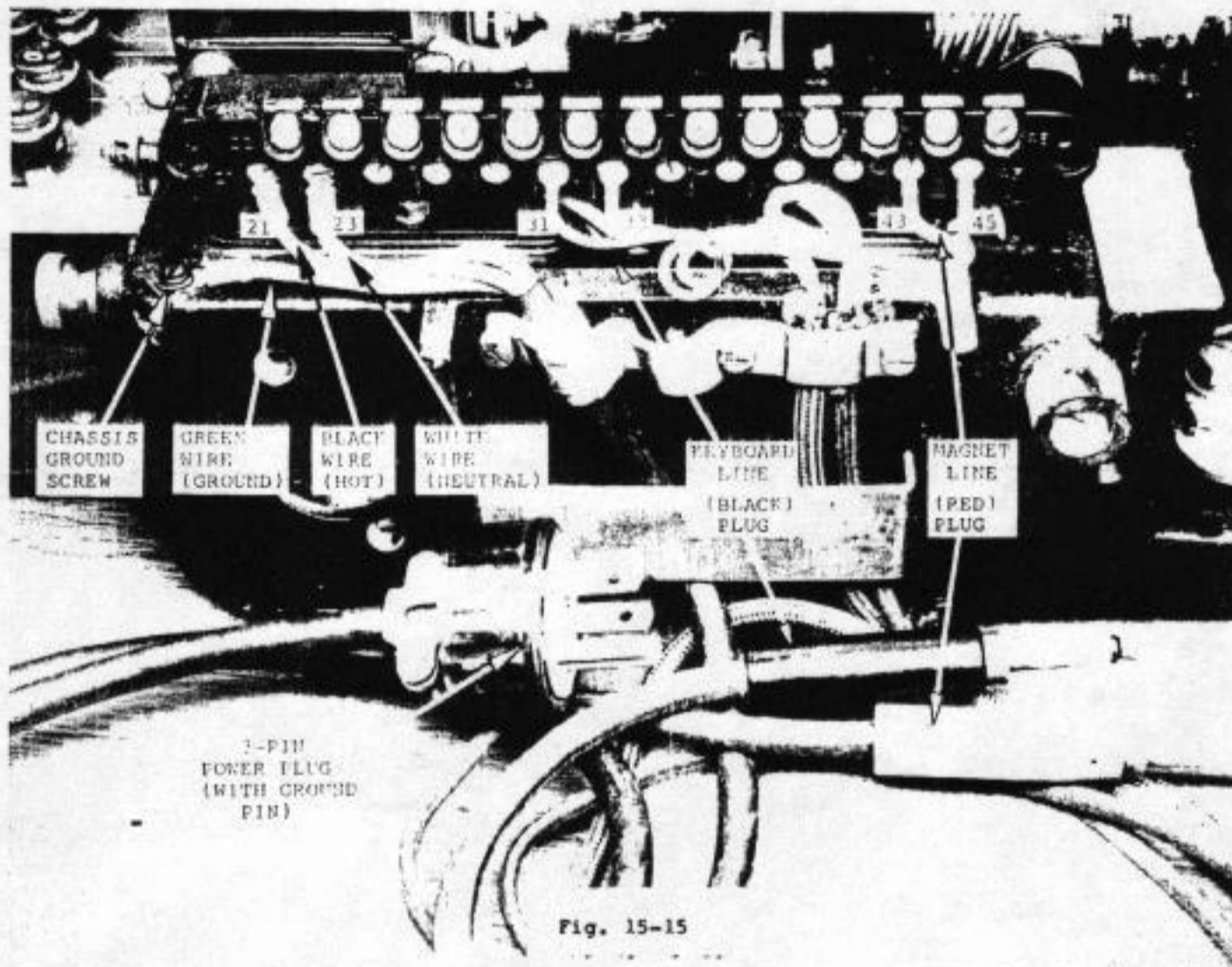

If existing cords and plugs, which came with the M15 machine, are in good condition, they can be used. Fig. 15-15 shows the complete plug and cord sets, attached to the M15, ready for use with an Acoustic Coupler. Fig. 15-16 shows the connections and arrangement of the plugs and cords. Be sure to clamp the cords to the side of the M15 base, using the bar clamp.

ATTENTION:

Note carefully the green ground wire from the machine base's ground screw to the U-shaped grounding pin on the power plug. This is important to assure a safe TTY installation. (Again, see Figs. 15-15 and 15-16.)

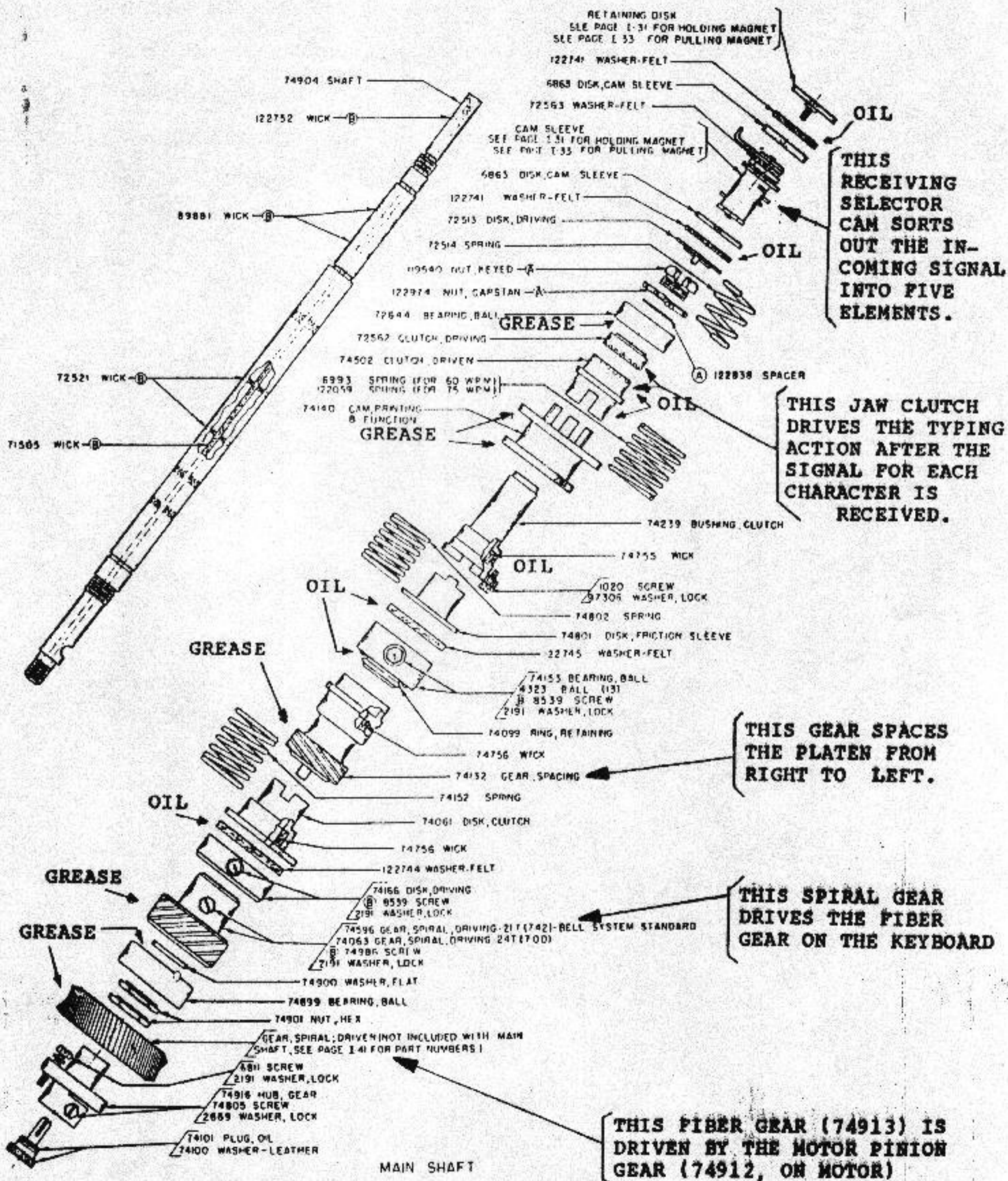

Fig. 15-17

B. OILING THE MODEL 15 TELETYPE

Like any machine, the teletypewriter requires periodic oiling, greasing, and other maintenance. Usually this is done at least once a year, especially if the equipment is in occasional service. One must judge for himself as to how often the lubrication should be done. There are several areas where oil is definitely required from time to time; other areas can "get by" and need only drops of oil if they appear dry. In general, rotating parts demand careful attention; sliding parts are not so critical. Rotating parts include shafts, clutches, gears, bearings, cams, and the like. Sliding parts are such items as levers, plungers, rods, etc.

A recommended oil is SAE10 machine oil, obtainable from Montgomery Ward Co. (Cream-separator machine oil) or from dealers who sell machine tools. Try an industrial hardware store. Do not use automobile oil, as it contains additives. As for grease, for lubricating cams, gears, and sliding parts, obtain some front-wheel axle grease from an automobile service station. A small jar will hold plenty, and should keep for years.

To do a lubrication job on the Model 15, we must uncover the machine and disassemble it into several parts. In this way, we can easily get at all the points needing oil or grease. The typing unit, as mentioned, is removable; just remove three thumb screws, and it can be lifted off.

Remove the ink-ribbon spools, and lay them aside. Turn the typing unit upside down on some secure surface, such as a work

bench. Place a block of wood underneath so as to support the moveable type carriage and to protect its sensitive parts. In this way, the upside down machine will be secure, and its main shaft will be easily accessible.

The Model 15 has a main shaft. It does the hardest work in the machine; hence it demands proper lubrication. See Fig. 15-17. This is an exploded diagram showing the parts relationship; in particular, note the fiber gear (74913) at the bottom. Apply grease to this gear, also to its associated motor gear (74912). Apply grease to the several cams, right on their top surfaces, spreading a thin layer around. Meanwhile, apply dabs of grease to the rollers bearing on these cams. If the two ball bearings appear dry, put some grease there. You can use your finger to apply grease to the various parts concerned. A little grease is sufficient on the cams and bearings; the gears should be well greased.

The main shaft has four clutches, composed of metal discs bearing on felt washers. Those parts particularly must be kept oiled. If the felts go dry, they tend to heat up more and thus wear out faster. Actually, felt type clutches will last many years, even in 24-hour service, provided they are kept oiled. It is simple to oil the felts; all that is needed is an oilcan, filled with SAE10 machine oil.

Now, in order to do a good oiling job in a felt clutch, the opposing metal discs must somehow be pried apart. We use a screwdriver, having a 1/4-inch wide blade; however this screwdriver should be specially modified for the job. New screwdrivers have

sharp-cornered edges; such could bite into the metal discs, thus causing nicks. One screwdriver (an old one will do fine) should have its corners filed smooth. See Fig. 15-18. With this screwdriver placed in position and twisted slightly, the metal discs can be separated, permitting some oil squirted into the felt. Ten drops, more or less, should result in a saturated felt. Better to have a slight excess of oil, as the felt takes time to absorb it completely. Fig. 15-19.

The four felt clutches are given this treatment. Incidentally, there is a fifth clutch, of a different type; this has serrated teeth - used for driving the typing action. This jaw clutch does heavy work, hence be sure to put some oil in between the teeth. See Fig. 15-22. Pry the clutch apart, using the screwdriver, to allow the oil to work its way in. Figs. 15-20, 15-21.

There are three springs coiled around the main shaft. Be sure to put a few drops of oil through each of these springs, in order to lubricate the splines of the clutches involved. Fig. 15-23.

Now, upend the typing unit in its (left side) selector end. Pull the oil plug (See end of mainshaft in Fig. 15-17) off the end of the mainshaft, and fill it with as much oil as it will take. Fig. 15-24. Allow it to stand for half an hour or so, then refill if necessary. Put the oil plug back on. This should suffice. Teletype servicemen use a special pressure type oil can to oil this shaft - which has a long piece of felt inside.

Place the typing unit right side up, in normal position. There are various other points for oiling and greasing. Looking into the front, there are two oil cups, on the ends of an

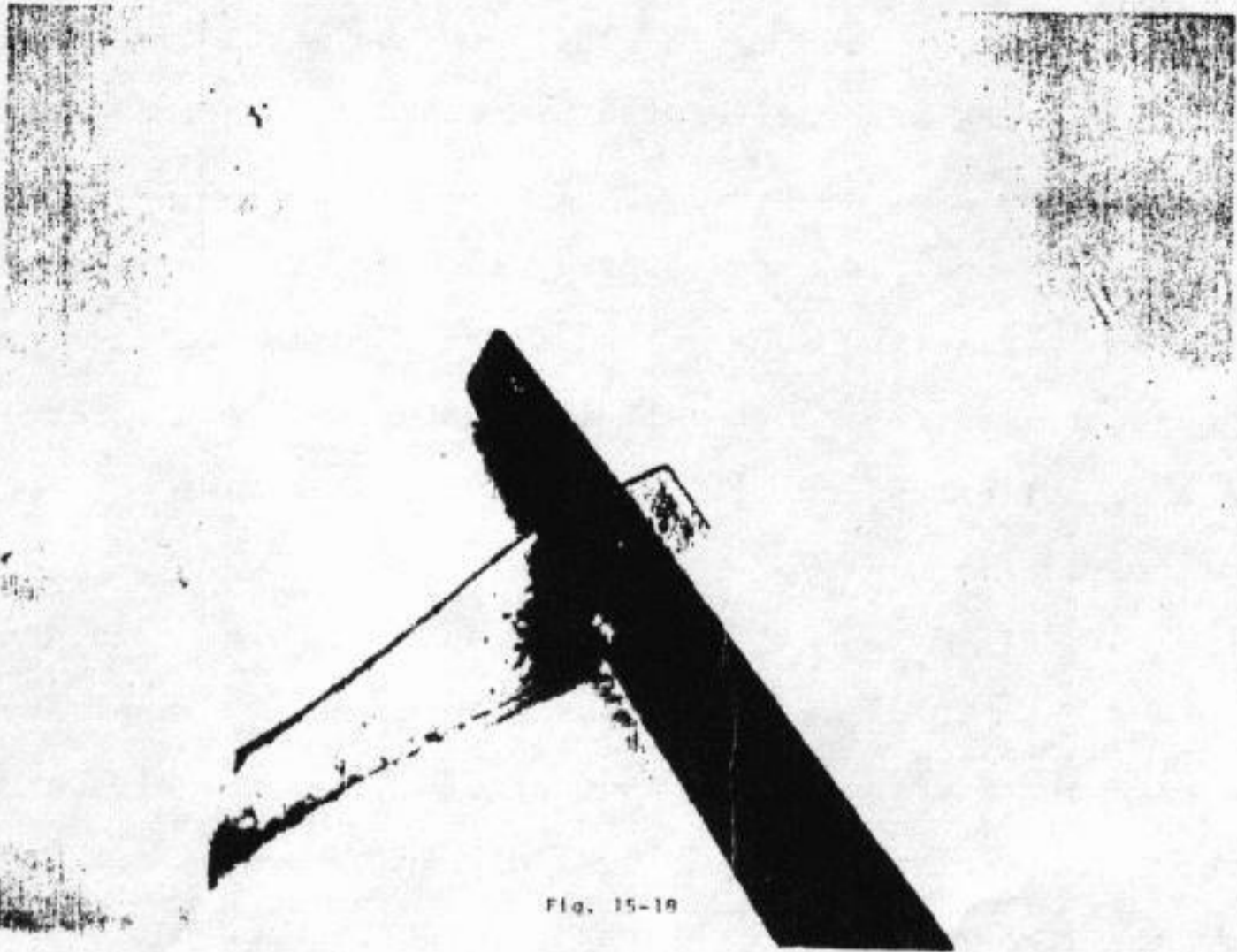

Fig. 15-19

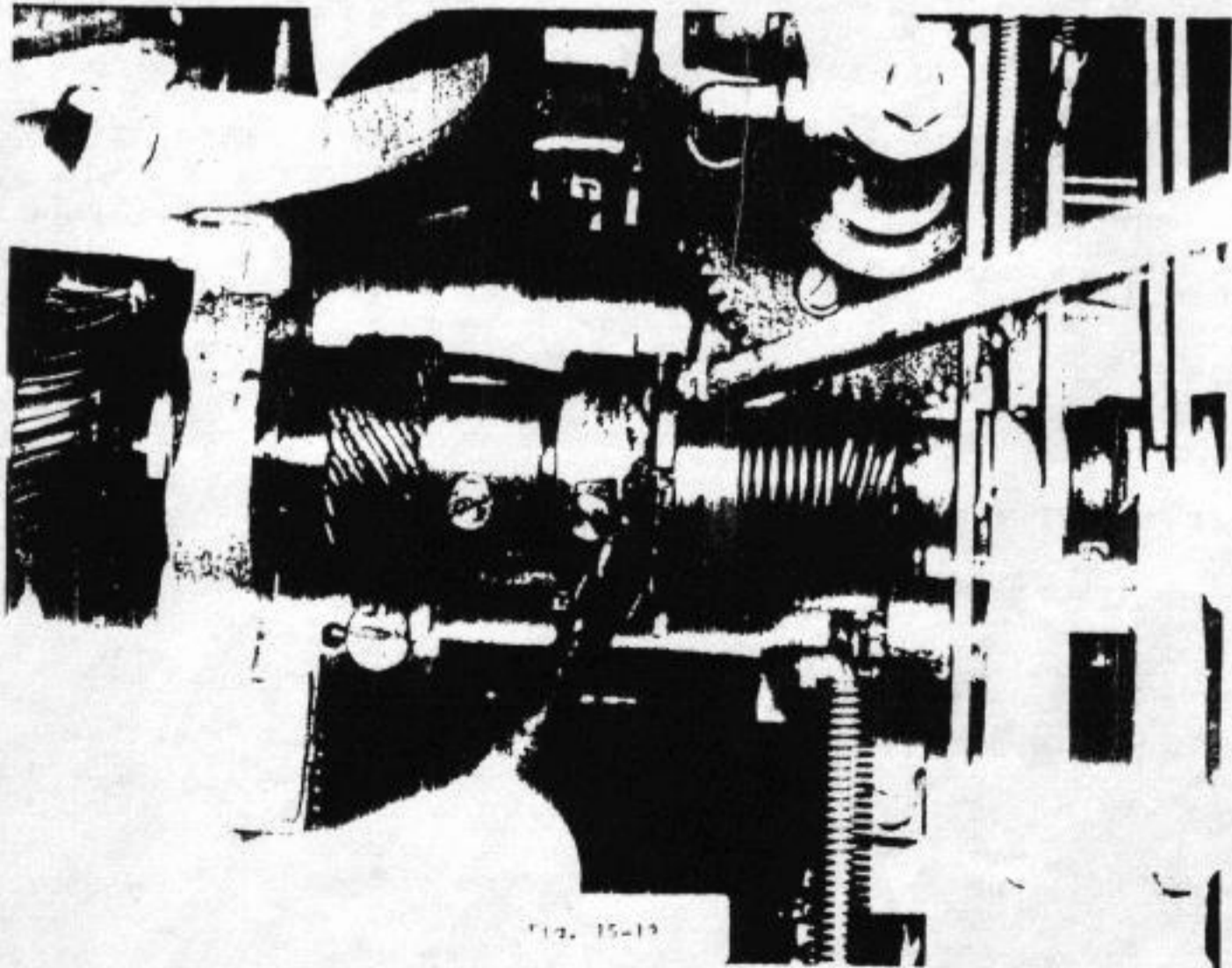

Fig. 15-19

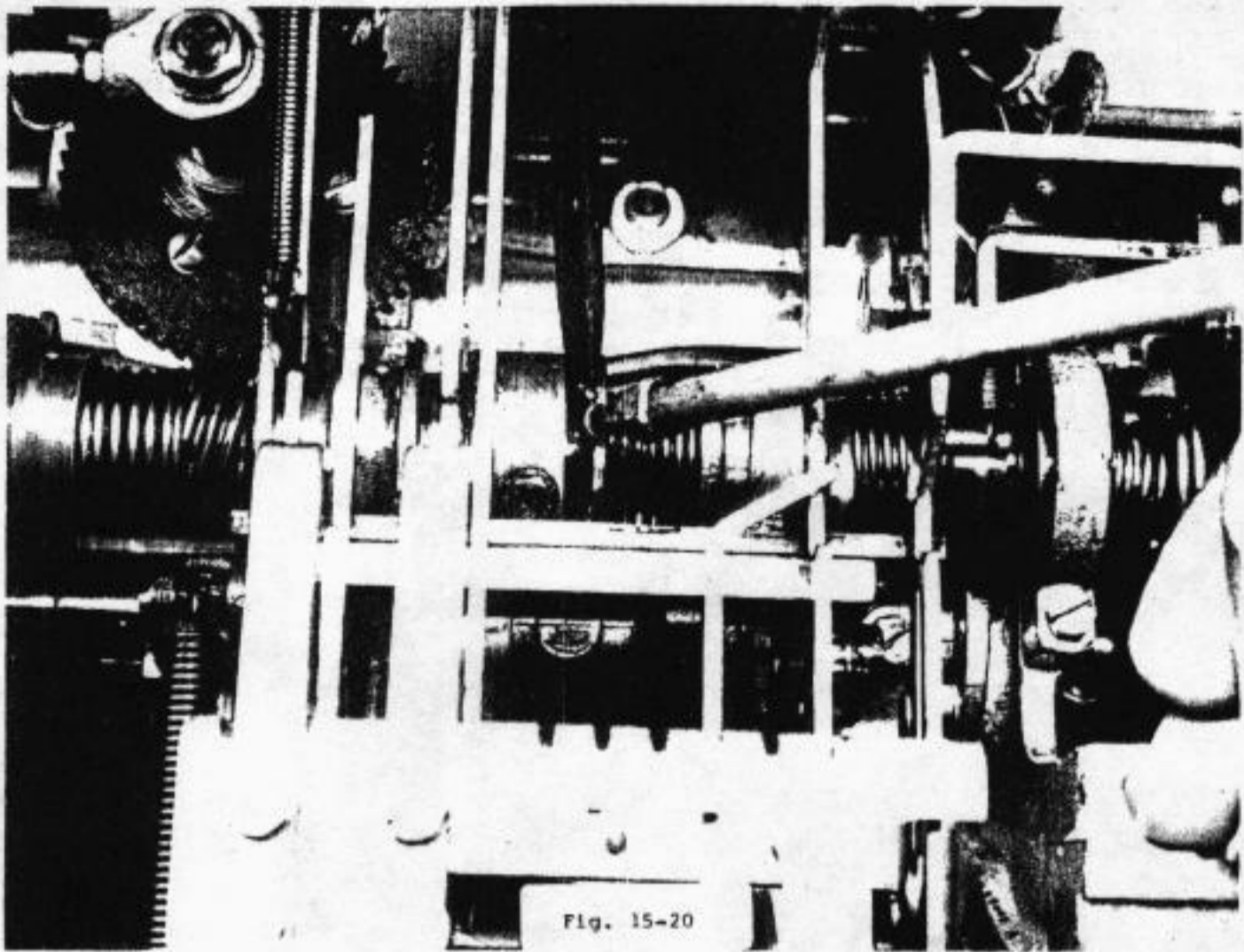
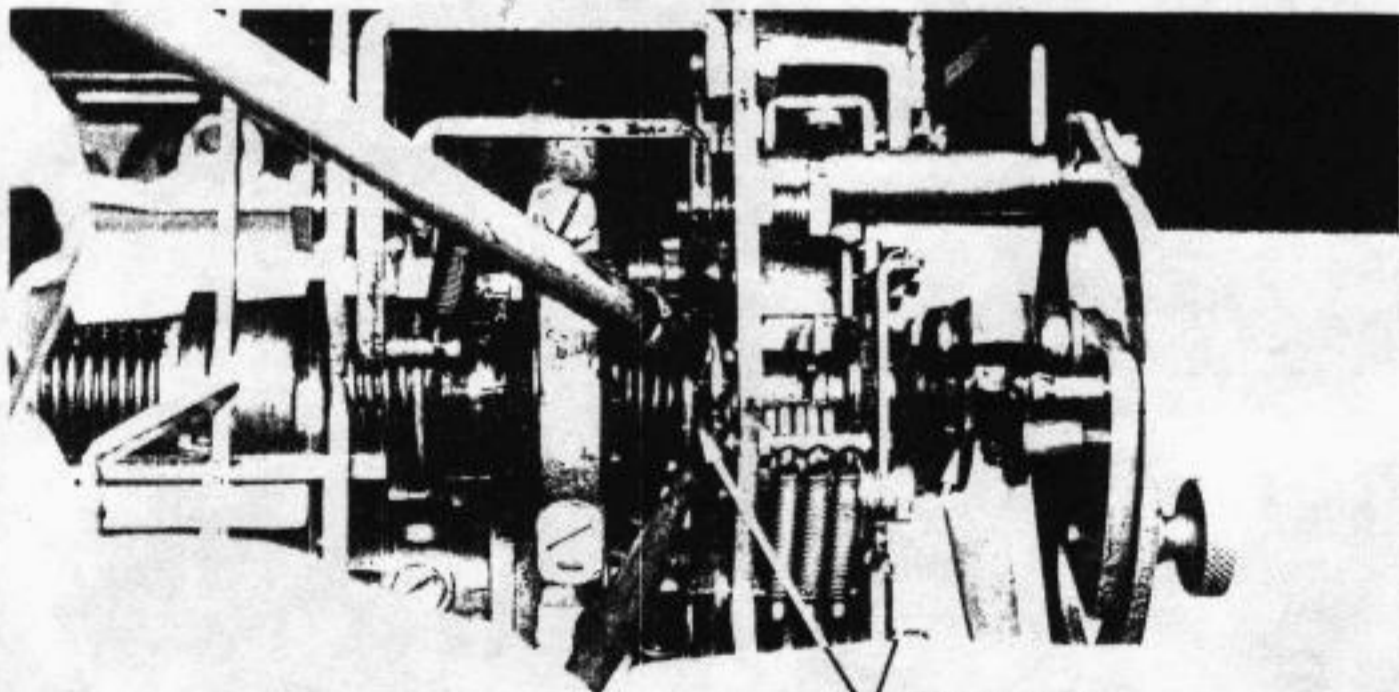

Fig. 15-20



FELT WASHERS
TO BE OILED

Fig. 15-21

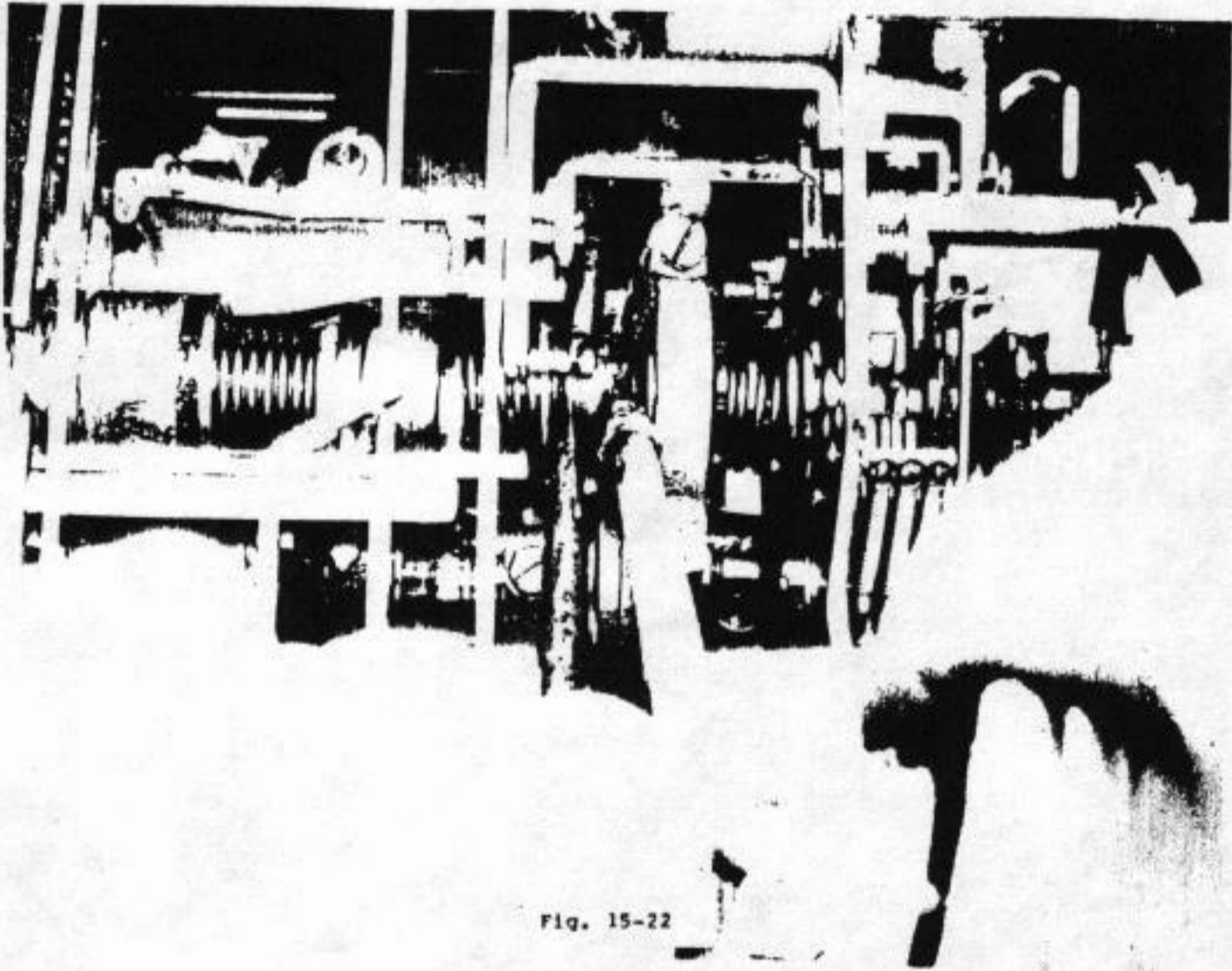

Fig. 15-22

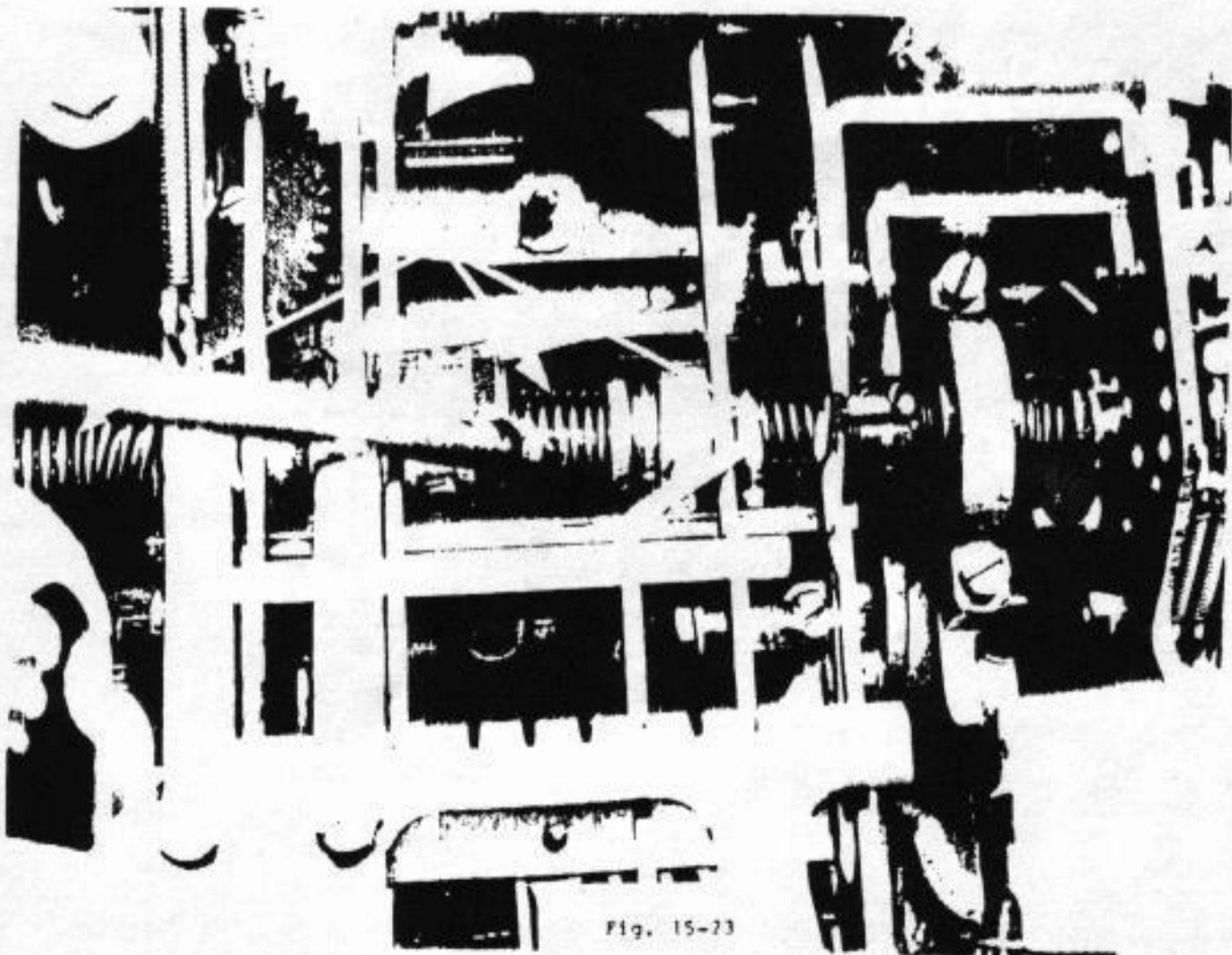

Fig. 15-23

oscillating shaft. They are close between the frames. Fill these cups with oil. Fig. 15-24A and Fig. 15-24B.

The typing carriage must be removed for further lubrication attention. It is quite easy to get it off the track, by following the procedure given below:

- 1) Push the flat ended lock bar on the left to release the carriage return. Fig. 15-25.
- 2) Push the carriage unit about half way to the right, and hold it there. Fig. 15-28.
- 3) Pull the dashpot lever all the way to the left. This will lock the carriage in place. Fig. 15-25.
- 4) Note a small lever, holding a (right margin) adjusting screw. Push this lever slightly to the rear. Fig. 15-26.
- 5) Holding the carriage, release the carriage return. (See Step 1)
- 6) Push the carriage almost off the track, then lock it in place. (See Step 3)

There is a strong carriage return spring wheel in the typing unit. In order to avoid having it unwind by itself, it is necessary to hold this spring wheel by hand, while unhooking the carriage return strap from the carriage and hooking the strap to a convenient anchor point.

- 7) Place your thumb on the end of the strap, so that its end won't fall off the spring wheel's circumference. Fig. 15-27. (This is a view of the rear of the typing unit.)
- 8) Now, grasping the spring wheel firmly, turn it slightly to the right so as to slacken the strap. You will see that the wheel is quite strong, so keep a hold on it. Fig. 15-27.

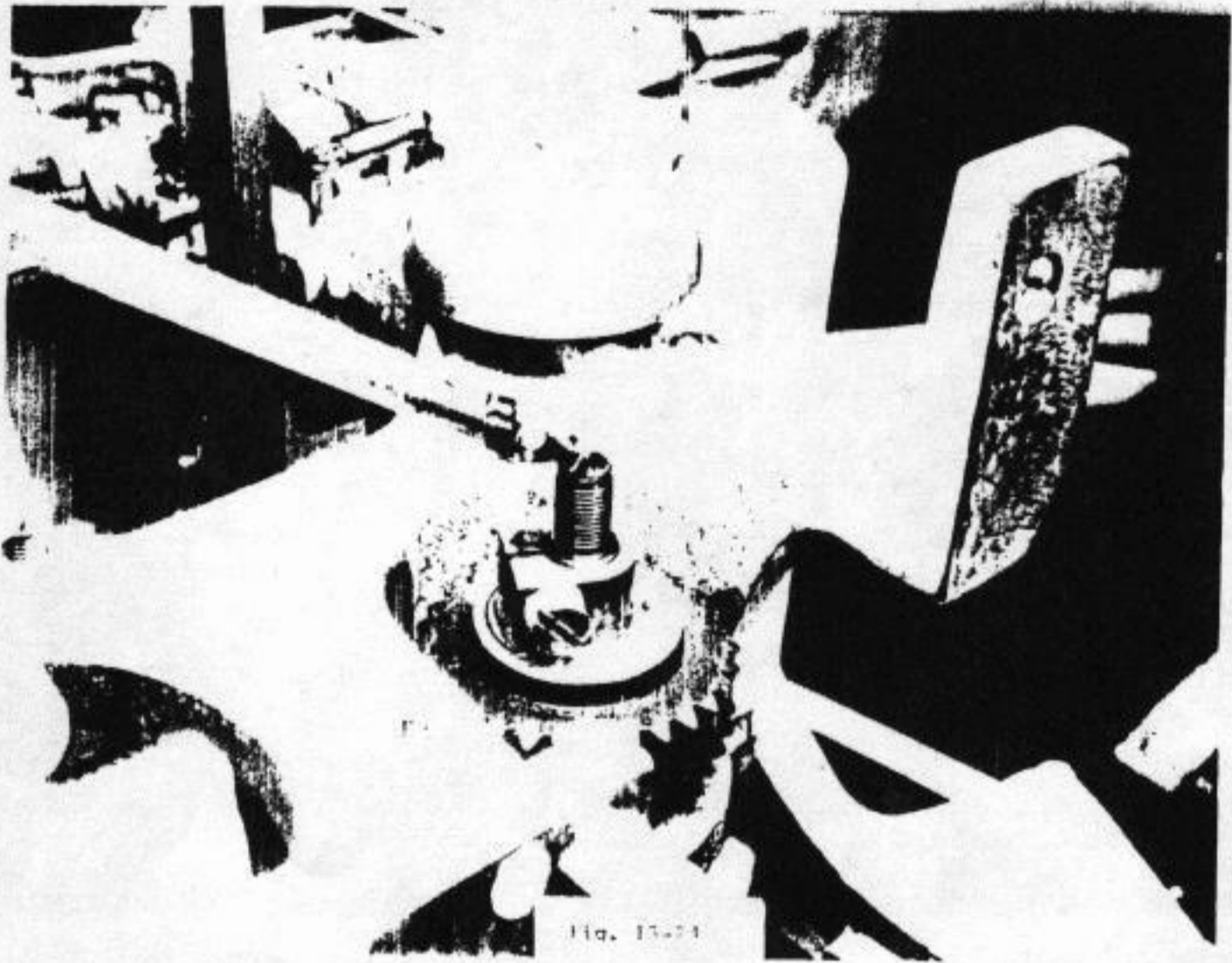
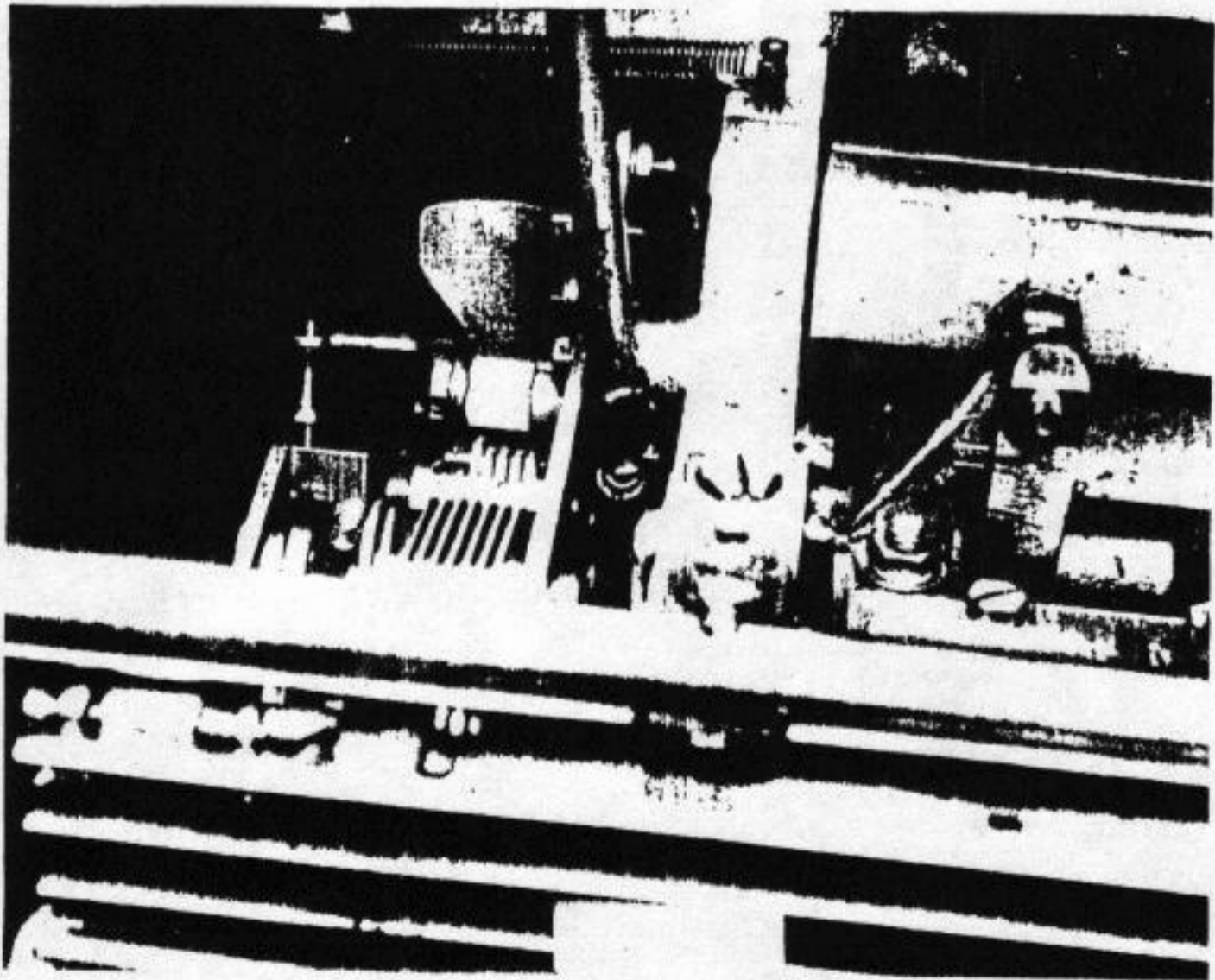

Fig. 15-24



M15-26

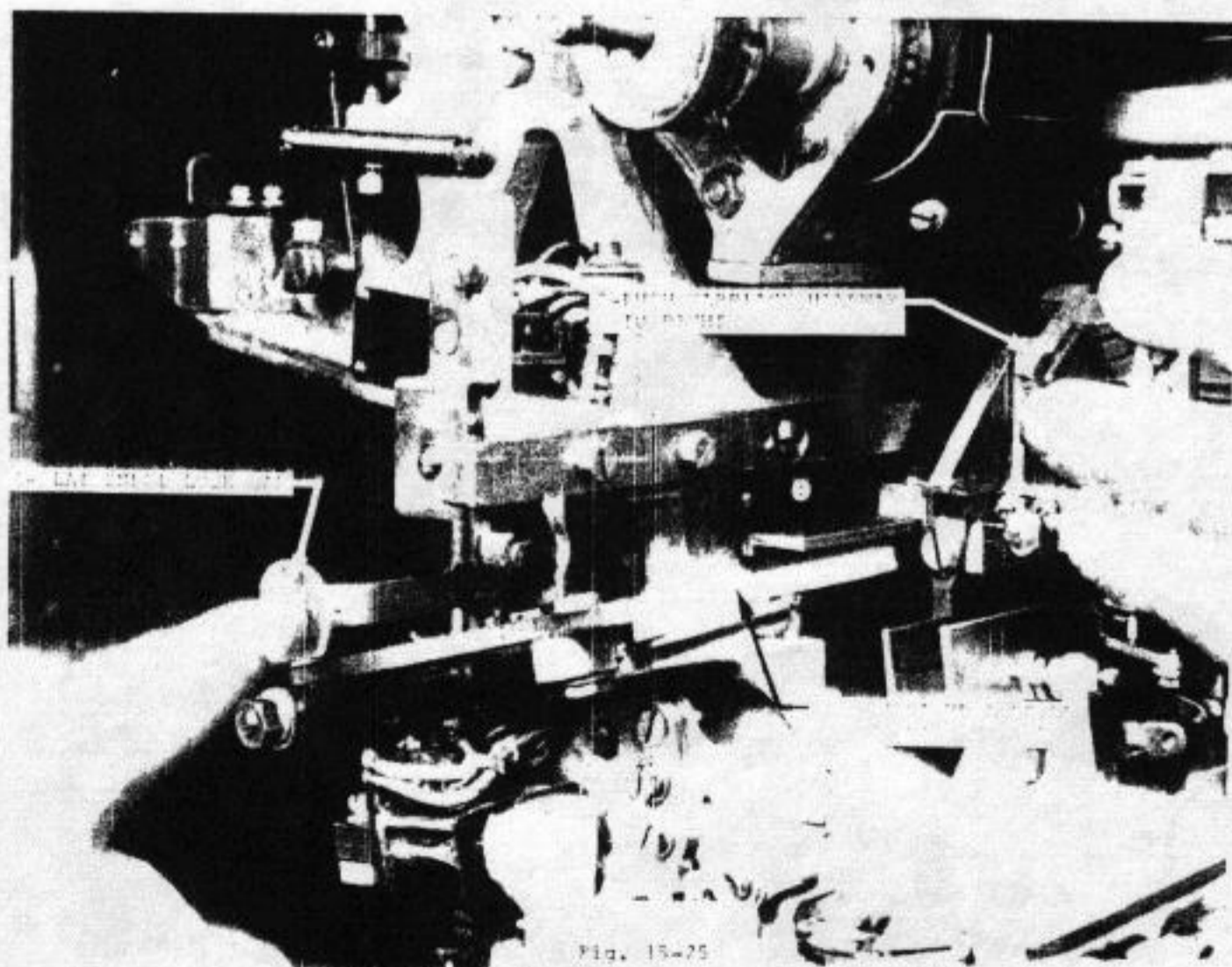
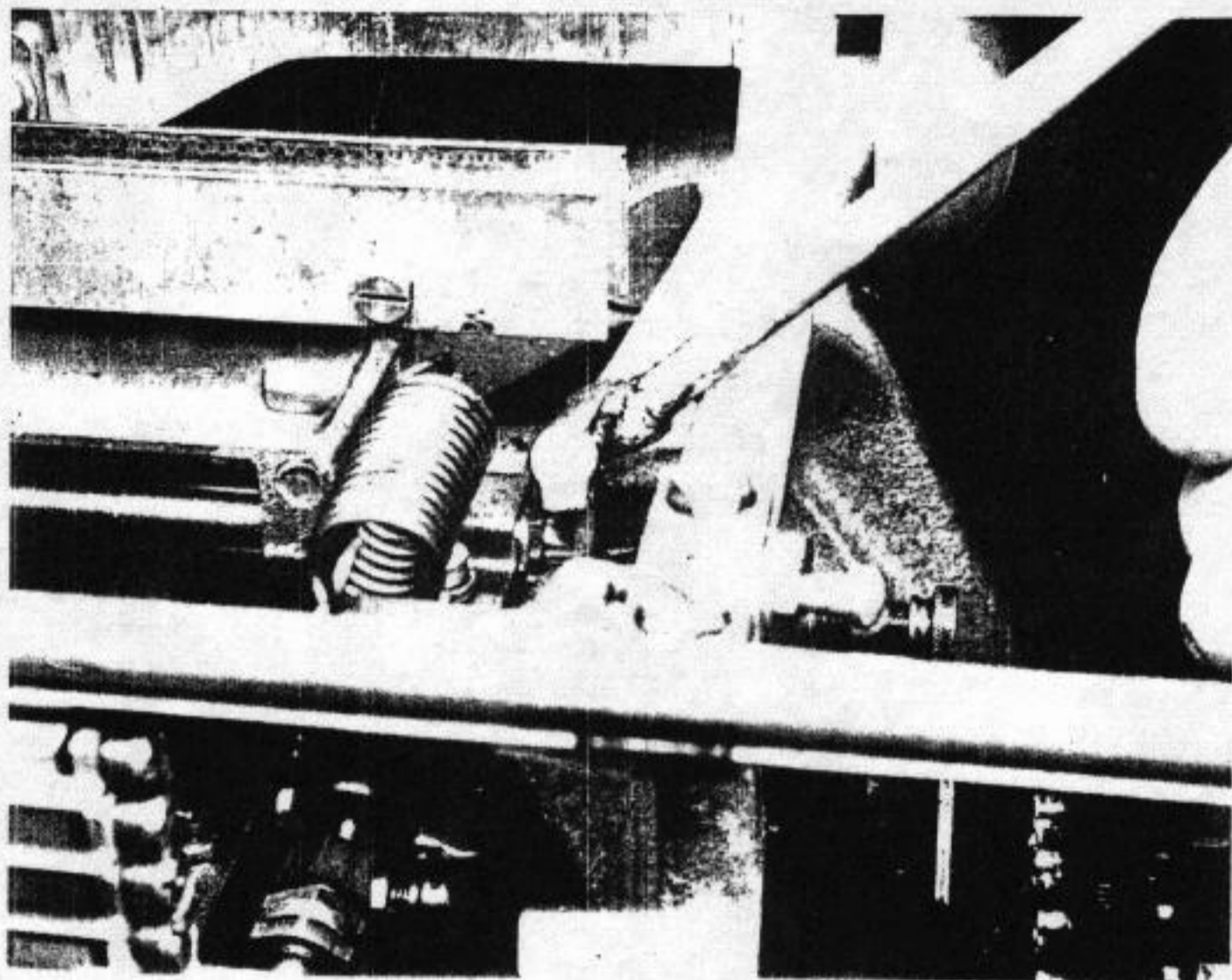
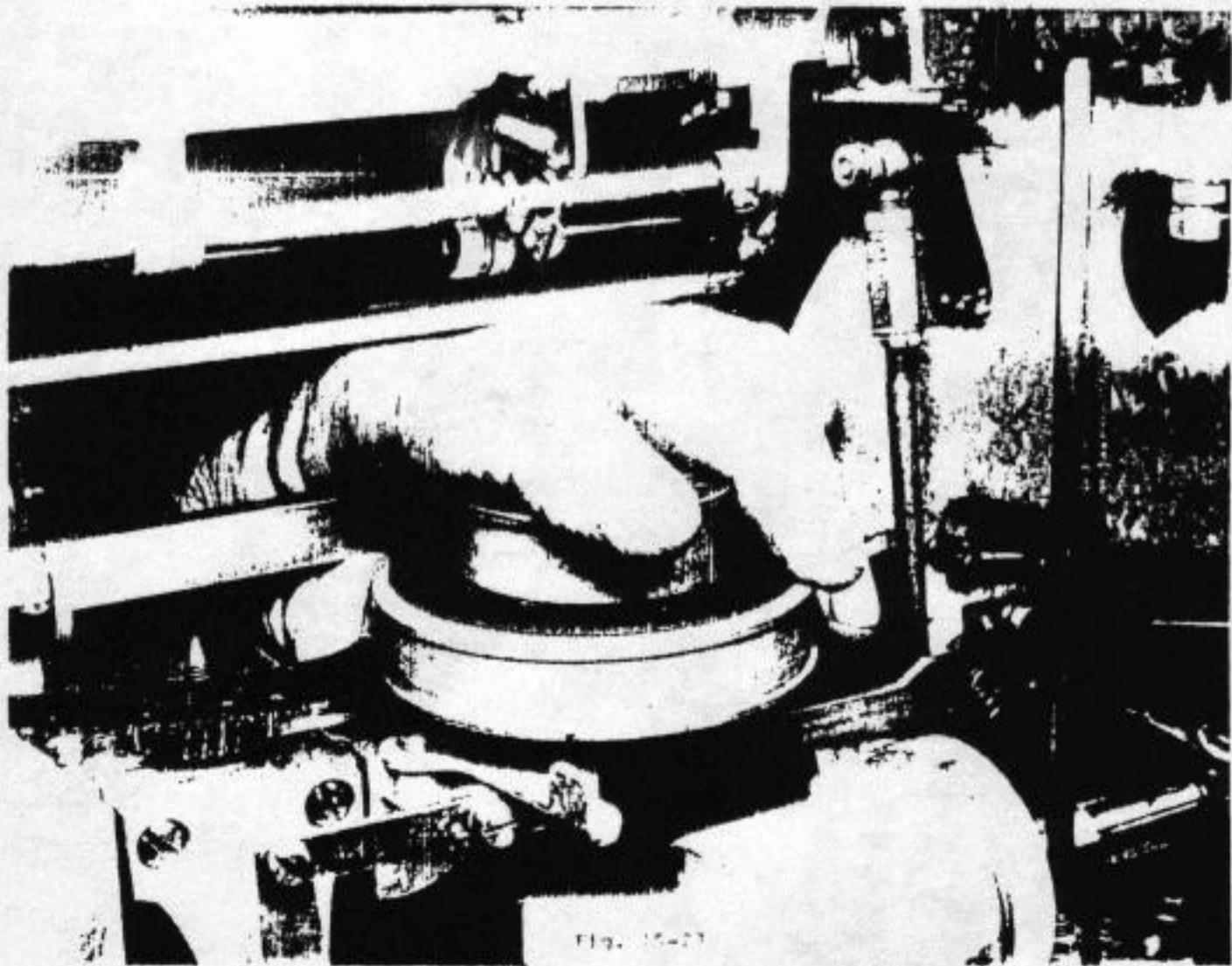
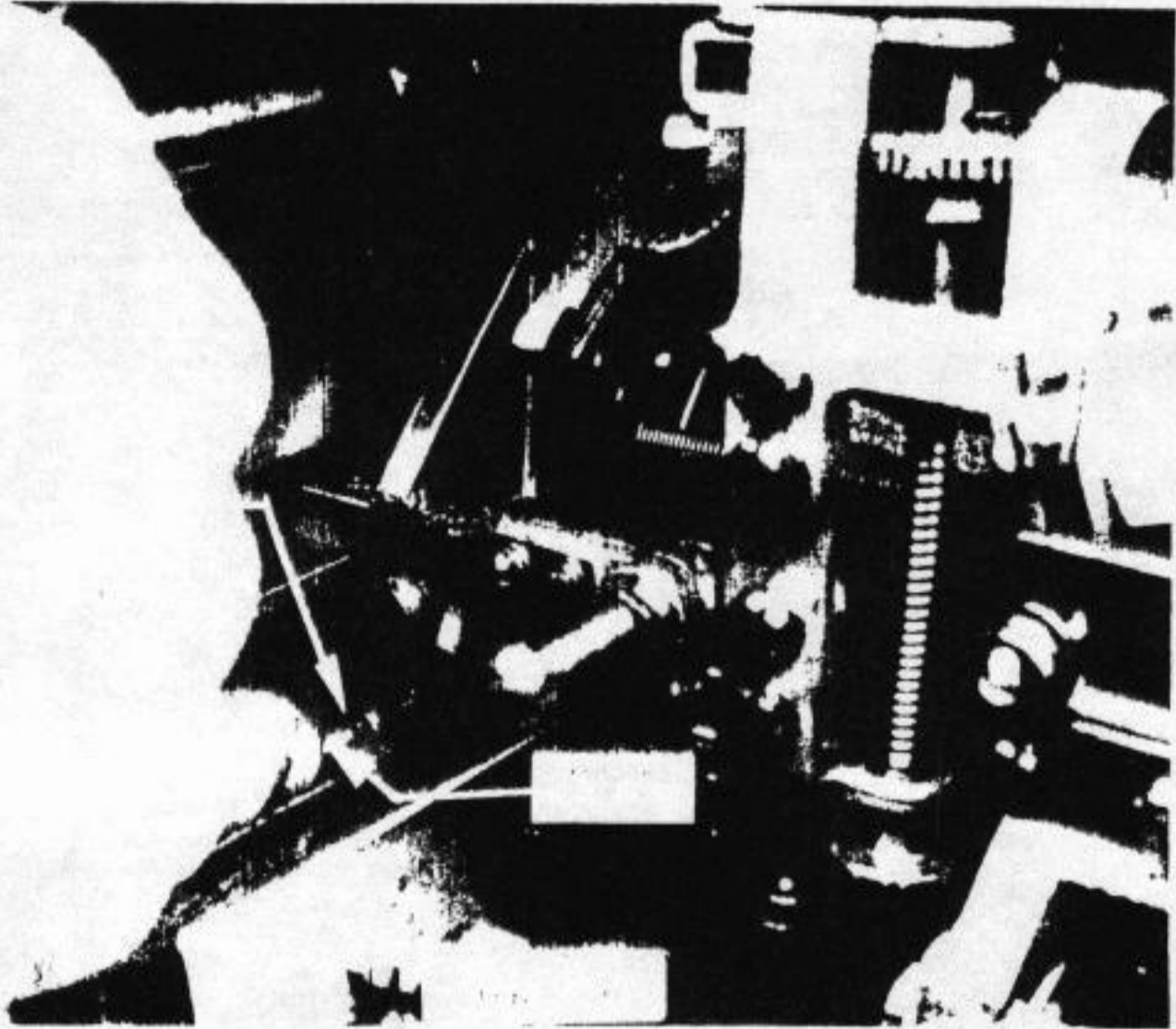

Fig. 15-25



- 9) Unhook the other end of the strap and place it over a suitable anchor point. Fig. 15-28 and Fig. 15-29.
- 10) Making sure the strap is hooked, you can then allow the spring wheel to move to the left by itself. Take it easy while releasing the wheel! The strap will be held safely.
- 11) The carriage is now free and can be slid to the right, off the track.

Remounting the carriage is essentially a reverse of the above procedure. Just to be clear, we will describe the following steps.

- 12) Place the left roller on the track, and take note that the retaining bolt enters the track slot. Fig. 15-30.
- 13) Move the carriage gently, and keep it in a near normal position. It should glide in. Use a slight pressure, if necessary.
- 14) You will note that the ends of the bell cranks (the L shaped levers) approach the ends of the vanes - those six parallel bars on the front of the typing unit. Fig. 15-31. Engage the upper vane with the upper ball crank.
- 15) Continue engaging the bell cranks on the vanes.
- 16) You will engage only two or three vanes. Now you must look underneath the typing unit from the right end. There is a ball-wheel (Fig. 15-32); it must be pushed forward in order to get it in between the two blades of the printing bail.

(The two long parallel bars are just below the platen.)

Oftentimes, it is easy to get the ball wheel in between the blades. A little patience may be necessary, sometimes, and at the same time, be gentle in getting the carriage back into position.

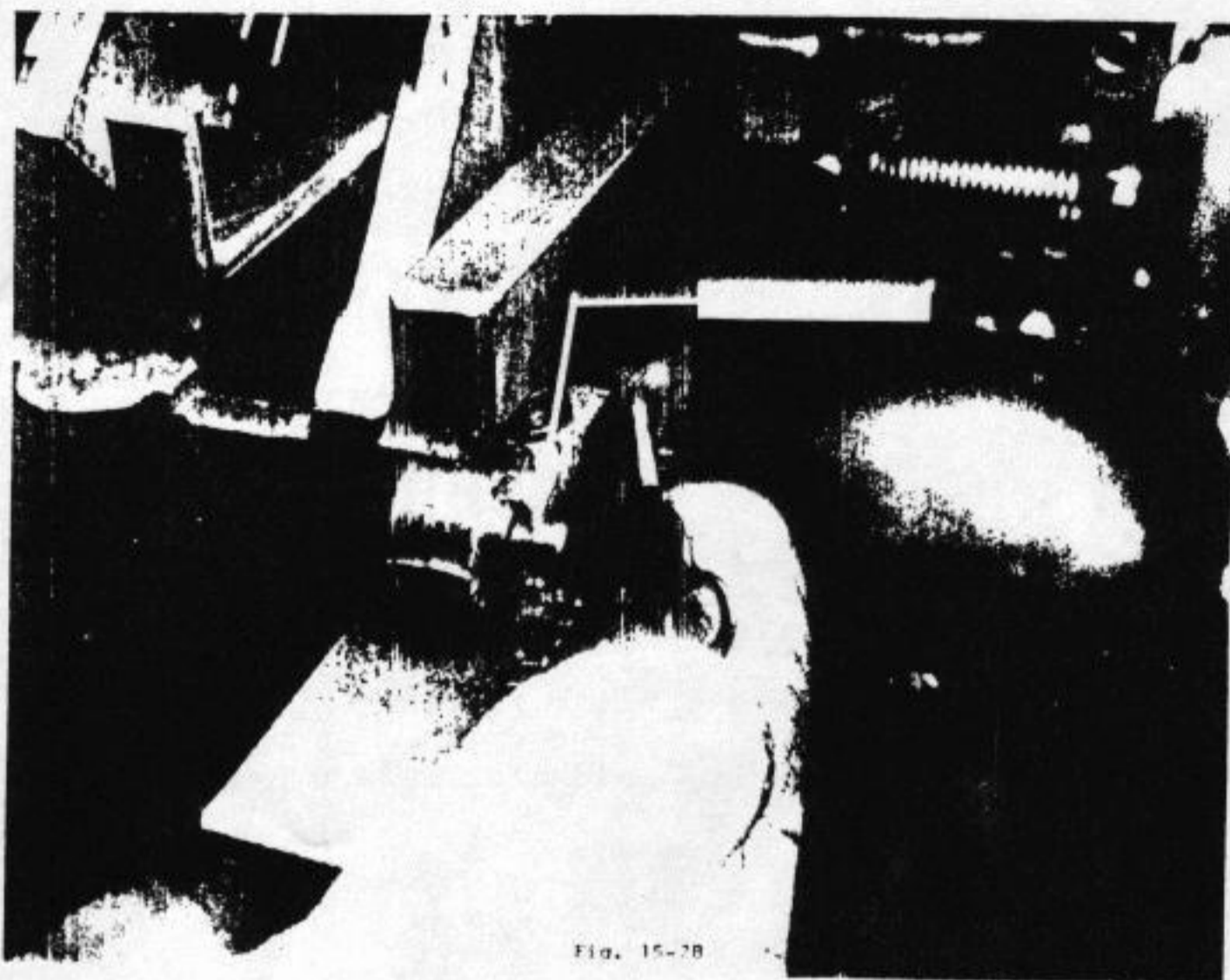

Fig. 15-28

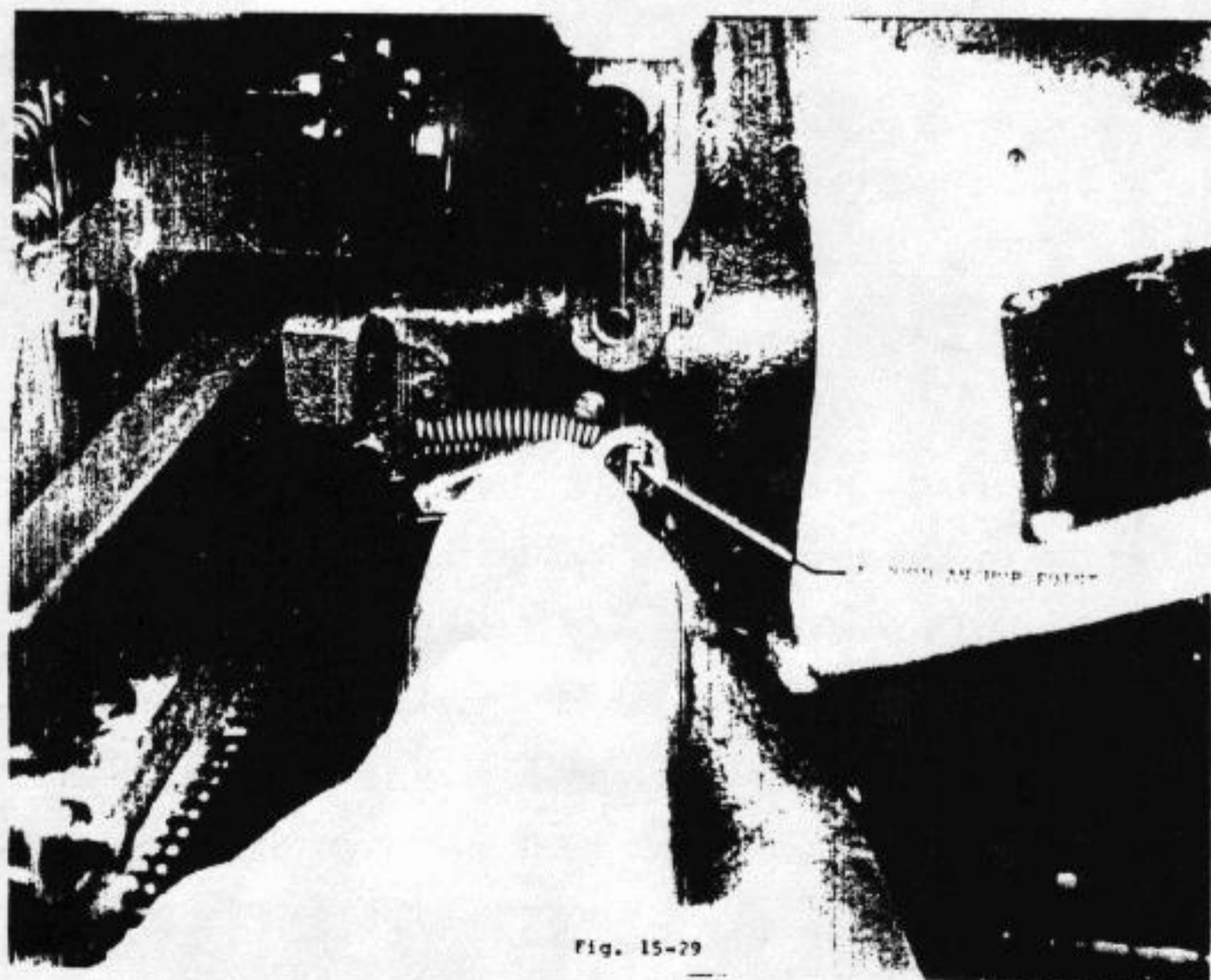
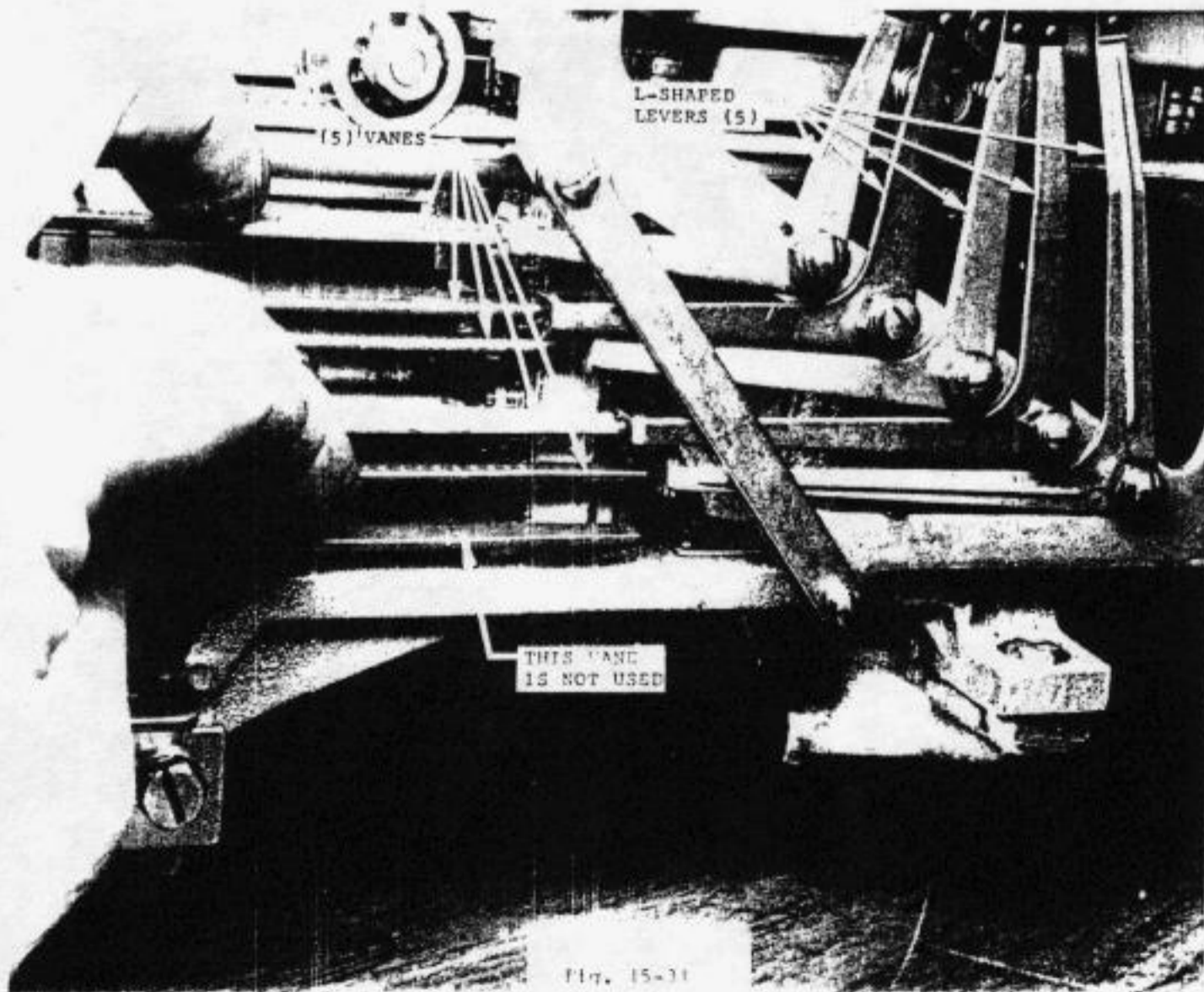
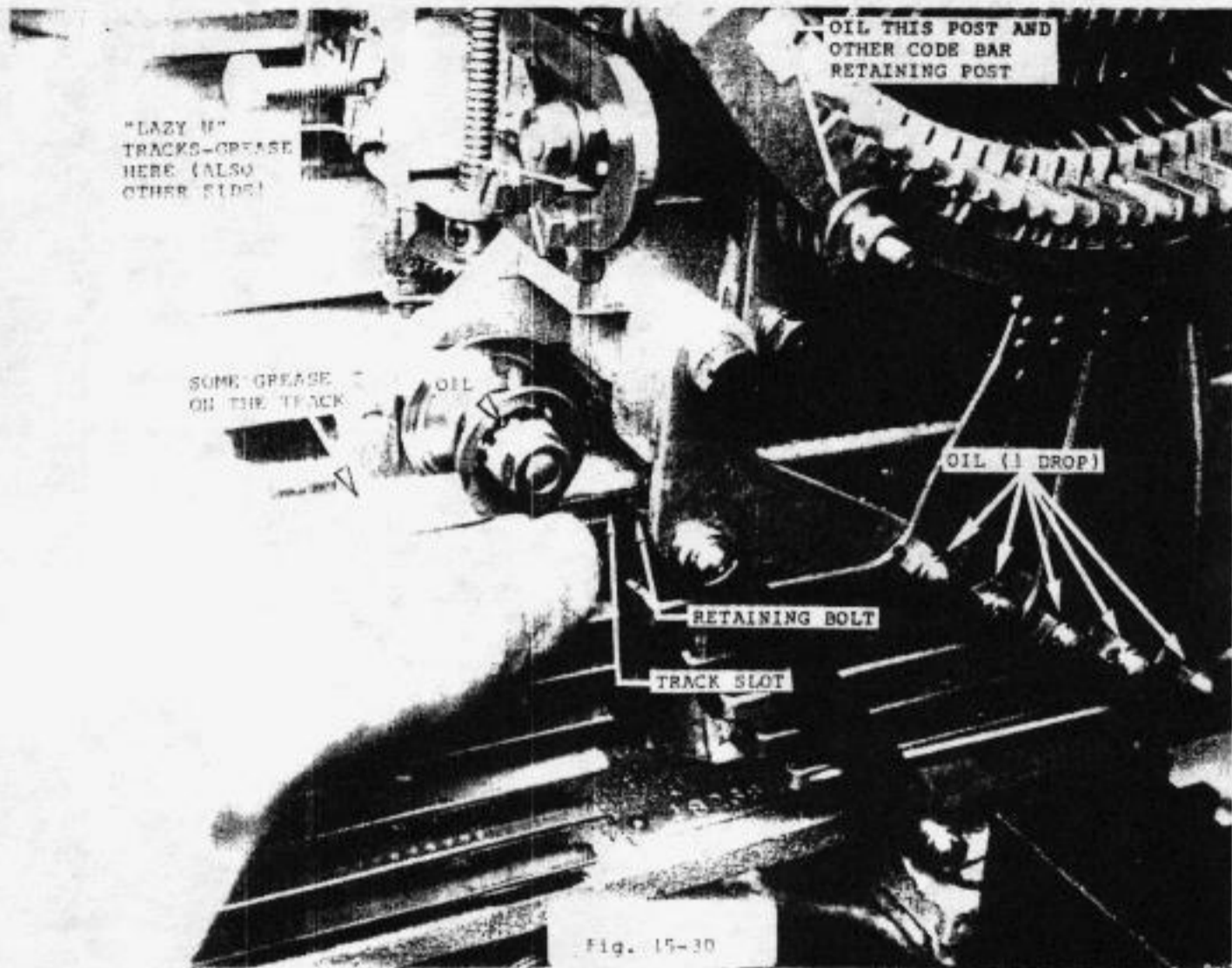

Fig. 15-29



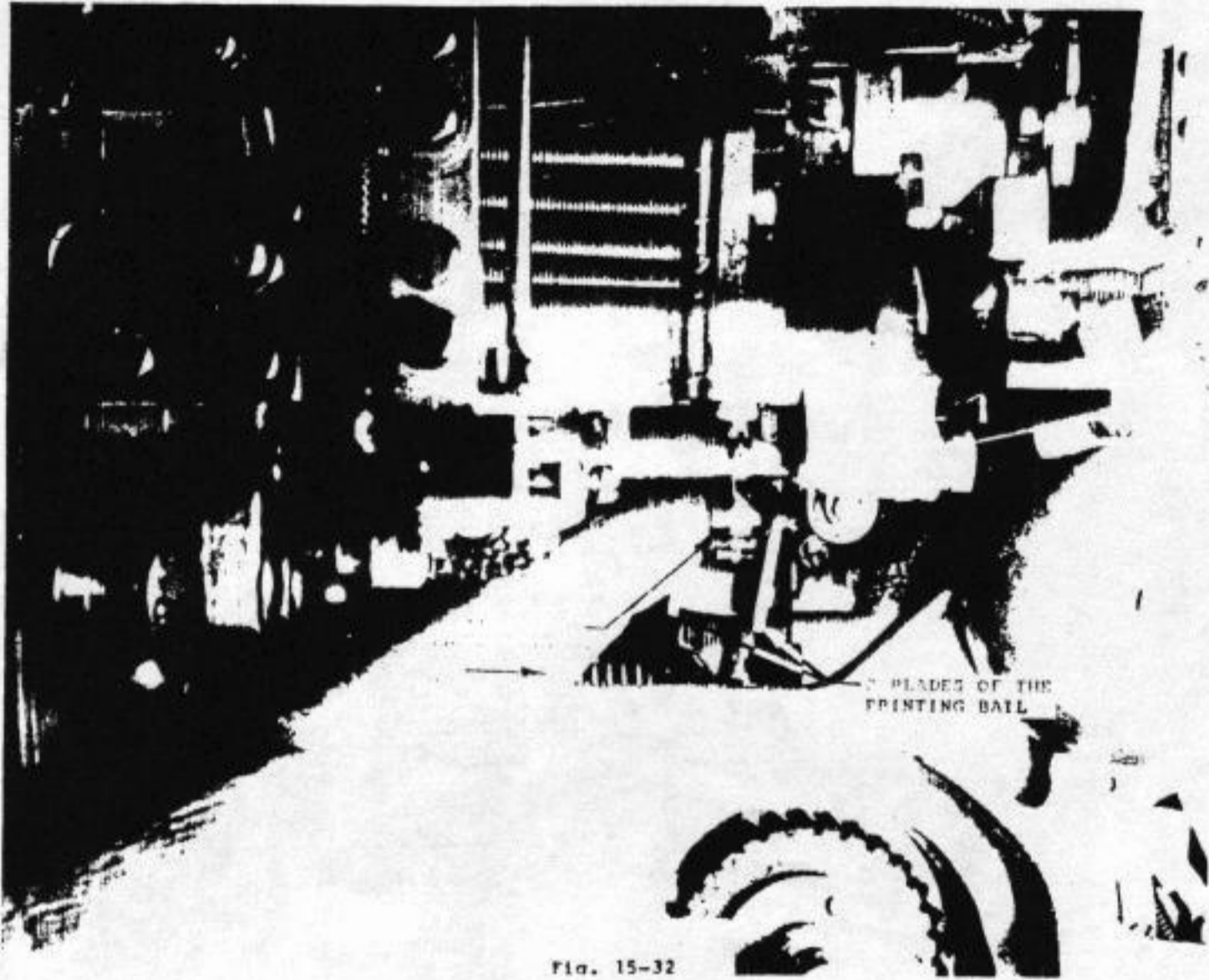

Fig. 15-32

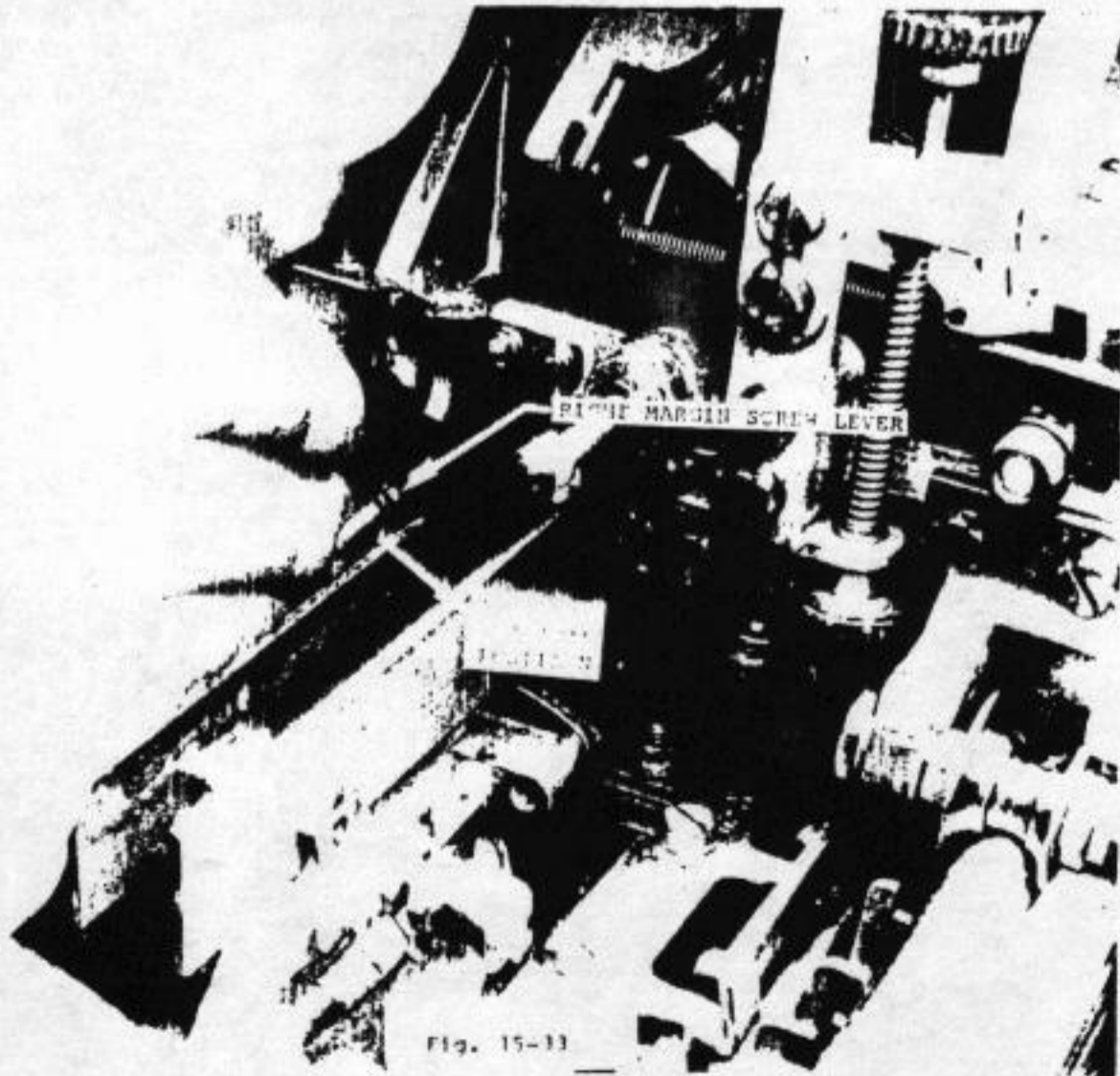

Fig. 15-33

Be sure that the right roller go upon the track with its adjacent retaining bolt slipping into the track's slot.

It may be easier, if the motor's fan is turned so as to rotate the mainshaft slightly. When doing this, always rotate this shaft in a counter clockwise direction - never clockwise (viewed from the right side of the typing unit). The printing bail should move forward; then the ball wheel can slip in between the blades.

- 17) Complete loading the bell cranks onto the vanes. You may have to press the carriage return lever (the flat ended lever on the left of the typing unit) to release the carriage return. The carriage should now move to the left in a smooth manner.
- 18) With the carriage moved to the right, almost off the vanes but not quite, lock the carriage return by pushing the dash pot lever all the way to the left.
- 19) Grasp the carriage return spring wheel firmly, as in step (7). Rotate it slightly to the right to slacken the carriage return strap.
- 20) Unhook the other end of the strap from its anchor post and place the strap's end on the carriage's strap holding bolt.
- 21) You can gently release the spring wheel. Take care, grasp the carriage so it does not slam to the left. It can however be locked in place by operating the dashpot lever first (Step 18).
- 22) Release the carriage, by pressing the carriage return lever (the flat ended lever on the left of the typing unit).
- 23) Now, push the carriage about half way to the right, reach in

the back to reset the right margin screw lever to a vertical position. Fig. 15-33.

This completes the mounting of the carriage on the typing unit. A little patience, with strict following of the above steps, should inspire confidence on the part of the person doing service work on this mechanism.

The Carriage Itself...

With the carriage out of the typing unit, we will see about lubrication, along with necessary adjustment as may be needed (See Fig. 15-34).

If the ribbon spools are on the carriage, remove them and lay them aside. Turn the carriage upside down to inspect the ball wheel (which goes between the blades of the printing bail in the typing unit). Move this ball wheel forward and backward to see that the action is smooth. Put a little grease on the sliding parts, and a little oil on the rollers. You might as well check the various small parts to see that they have oil.

Sometimes the ribbon reversing mechanism gets out of adjustment. Operate one of the ribbon reversing "ribbon slots" by moving it to the rear, and at the same time push the ball wheel rearward. You should see to it that the horizontal shaft moves to one side. Try the other ribbon slot and see that the horizontal shaft moves to the other side. In this way, you can be sure that the ribbon reversing system is operating properly. At least, take note how the system operates, so you will be in a good position to make an adjustment if ever necessary.

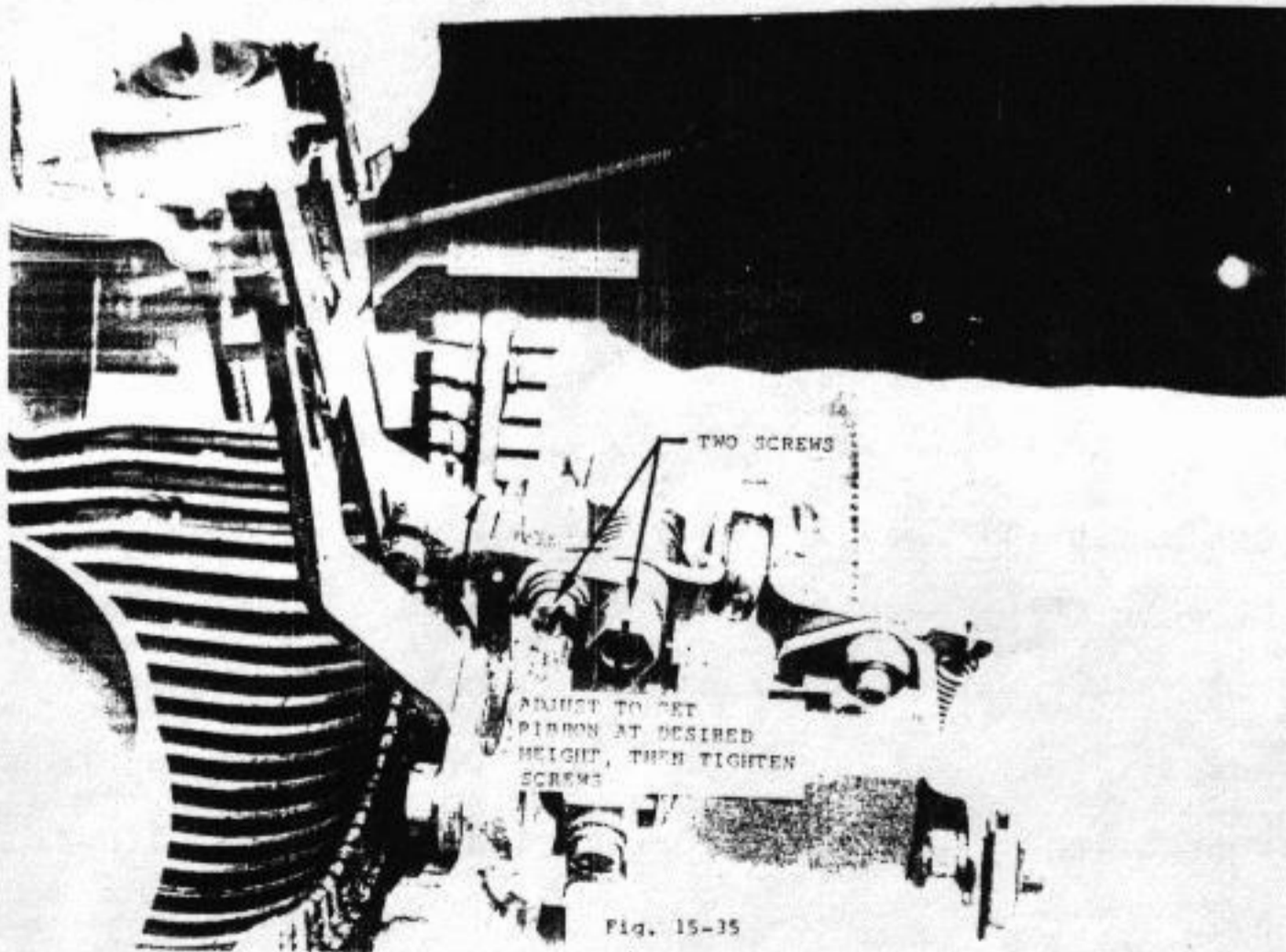
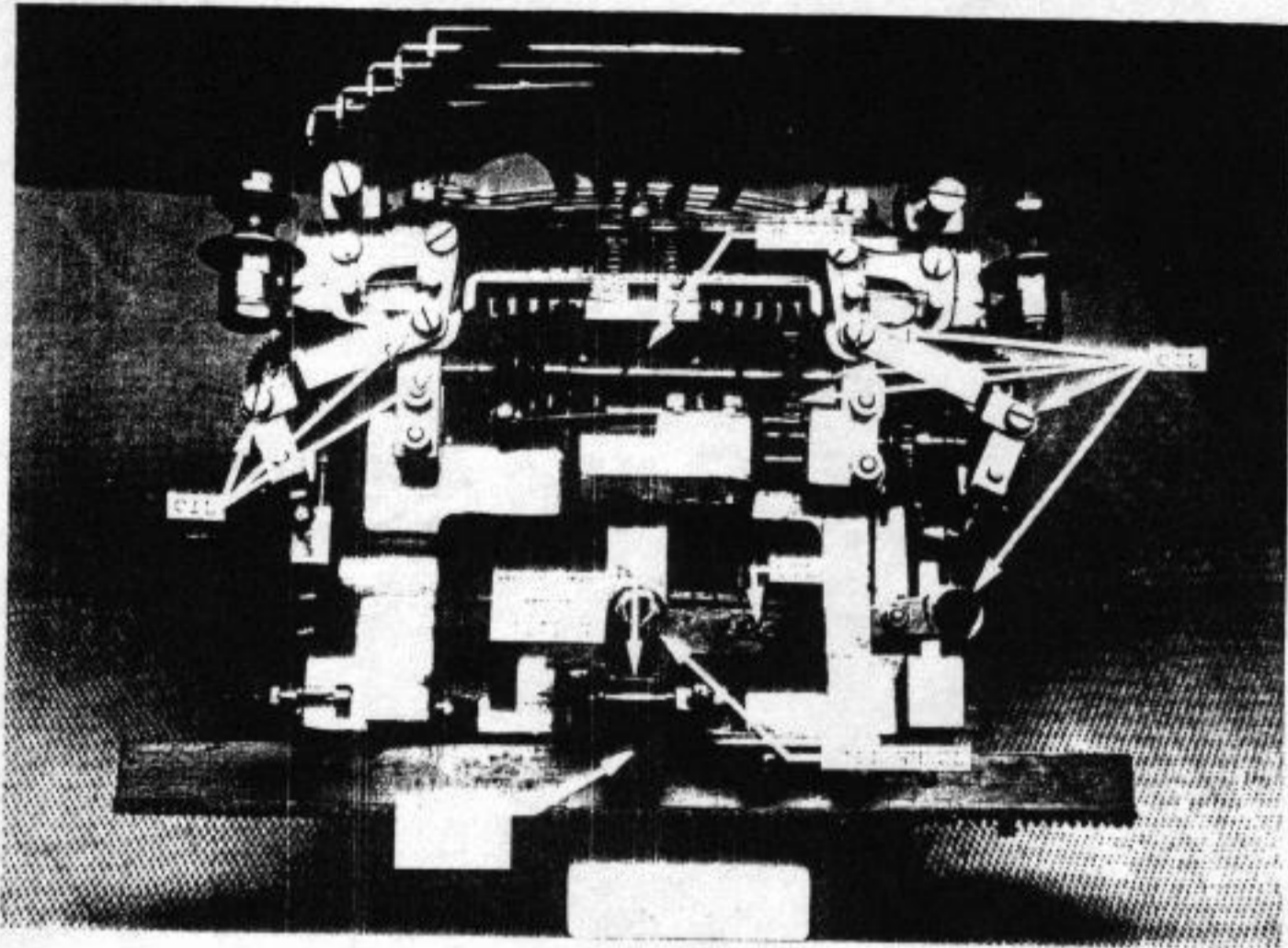

Fig. 15-35

Place some grease on the little gears on the underside of the carriage.

Run a little oil along the curved rod which holds all the type bars. This rod is at the rear, just in the area where the type bars enter their slots. Wipe off the excess oil.

Sometimes the oscillating ribbon holder does not lower itself far enough to permit reading the message. There is an adjustment (this adjustment can be reached without removing the carriage from the typing unit. Set platen in FIGS position and use a long screw driver) to permit lowering the oscillating ribbon holder. Fig. 15-35 shows two screws; both are loosened, then the ribbon holder is pushed down a little, then clamp the screws. A little patience in doing this should arrive at a good adjustment.

Place some grease on the sliding ways on both sides of the carriage. (See Fig. 15-30). These ways are the "lazy U's" with roller wheels inside.

The type faces can be cleaned, using a rag dampened with naphtha. Be sure to wipe over and around each type face. (Fig. 15-36)

Lubricating the M15 Keyboard...

There are relatively few parts to be oiled on the keyboard. Slide it out of the TTY base. Apply some oil to the front and rear oil cups on the transmitting shaft. Be sure to apply a few drops of oil in between the jaws of the clutch, forced apart by finger pressure. Next, put in a few drops of oil in the spring just in front of the clutch, in order to lubricate the splines. (Fig. 15-37).

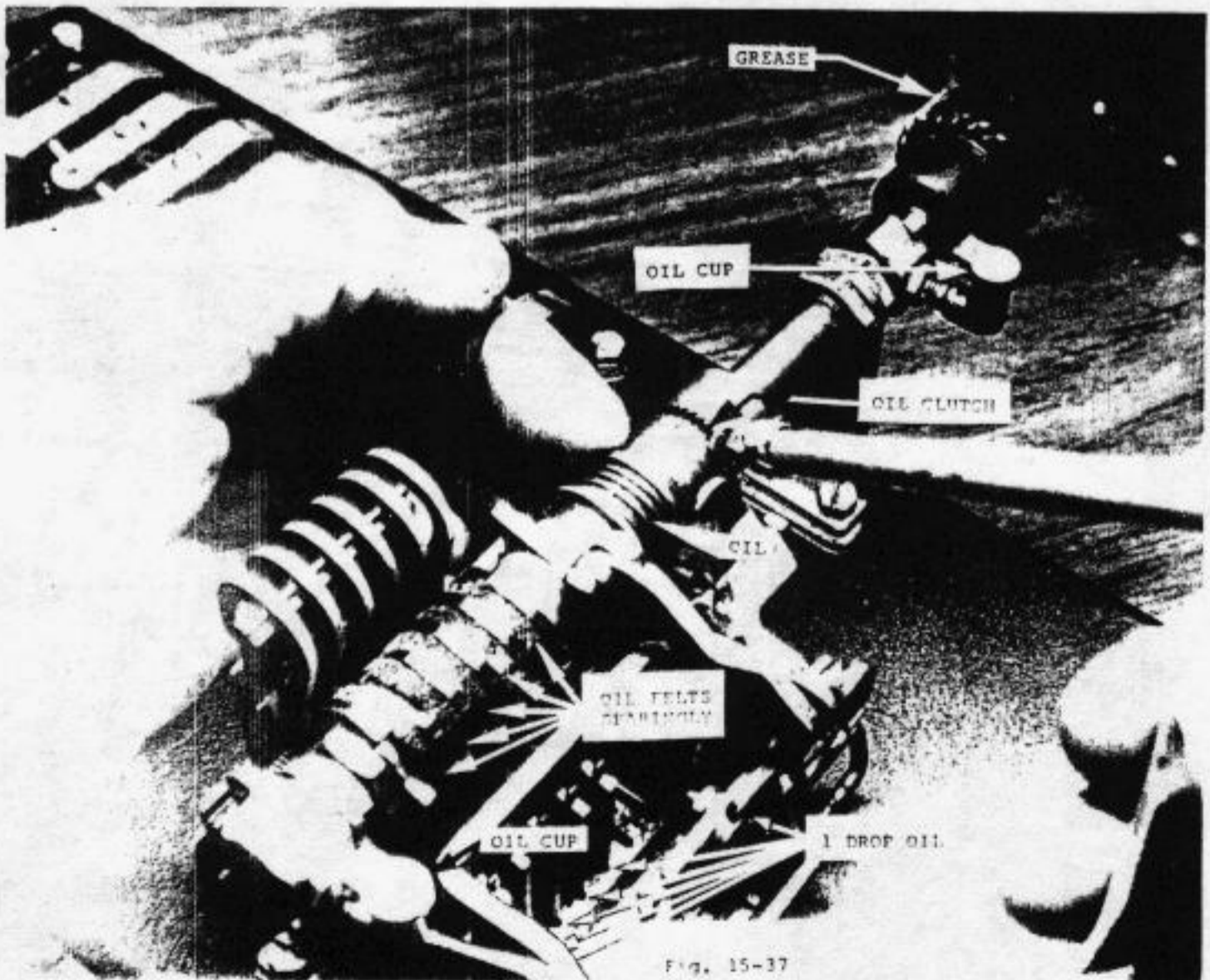
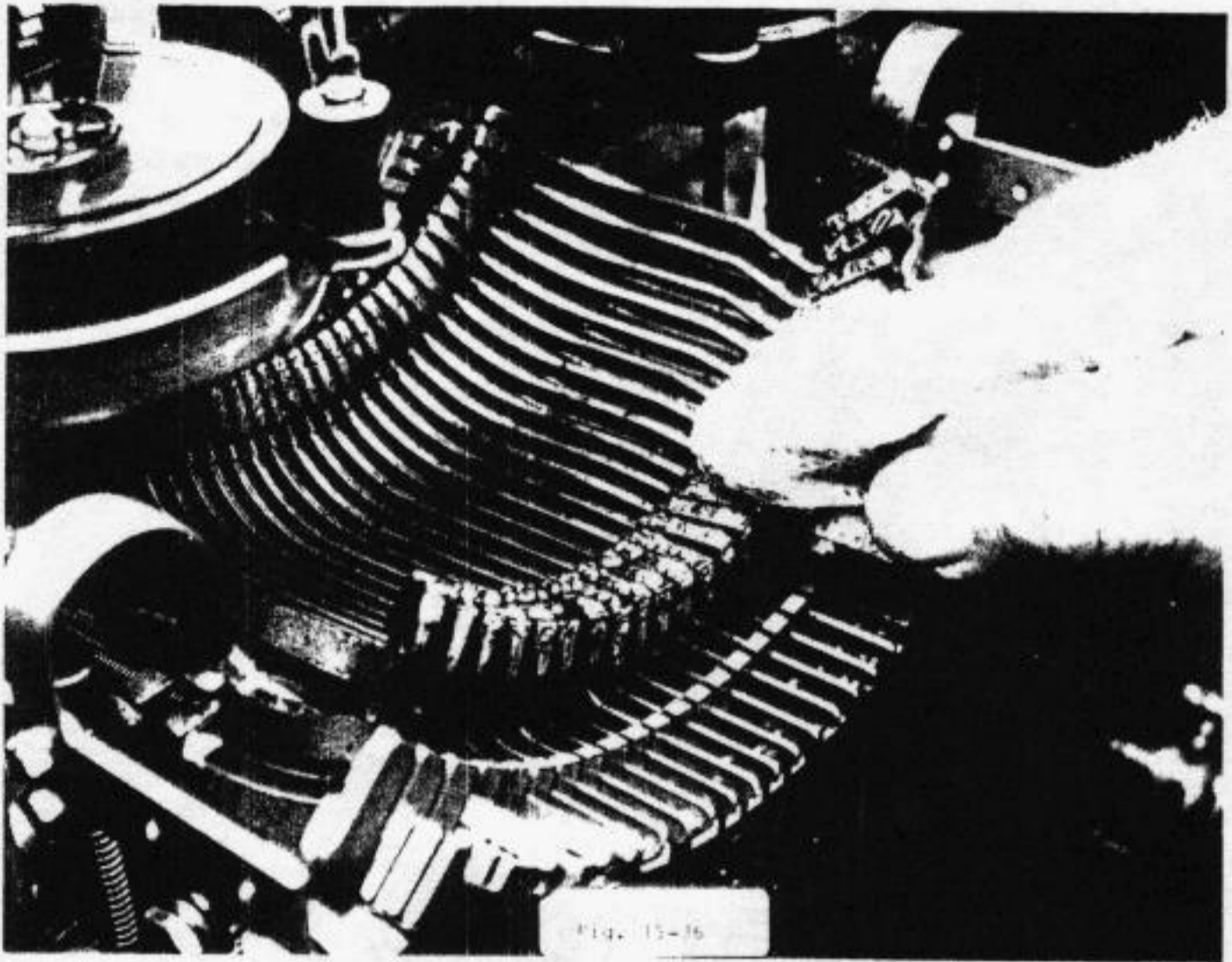

Turn the keyboard over, and you can put some oil on the code-bar rollers at both ends. (Fig. 15-38)

Place a few drops of oil on the felts in between the cams on the cam assembly. (See Fig. 15-37). If there are no felts, a little grease spread thinly on the cams will serve.

Keep the keyboard levers clean. Use a small paintbrush to wipe dust and dirt from the key levers, particularly from the slots where the key levers enter the keyboard base.

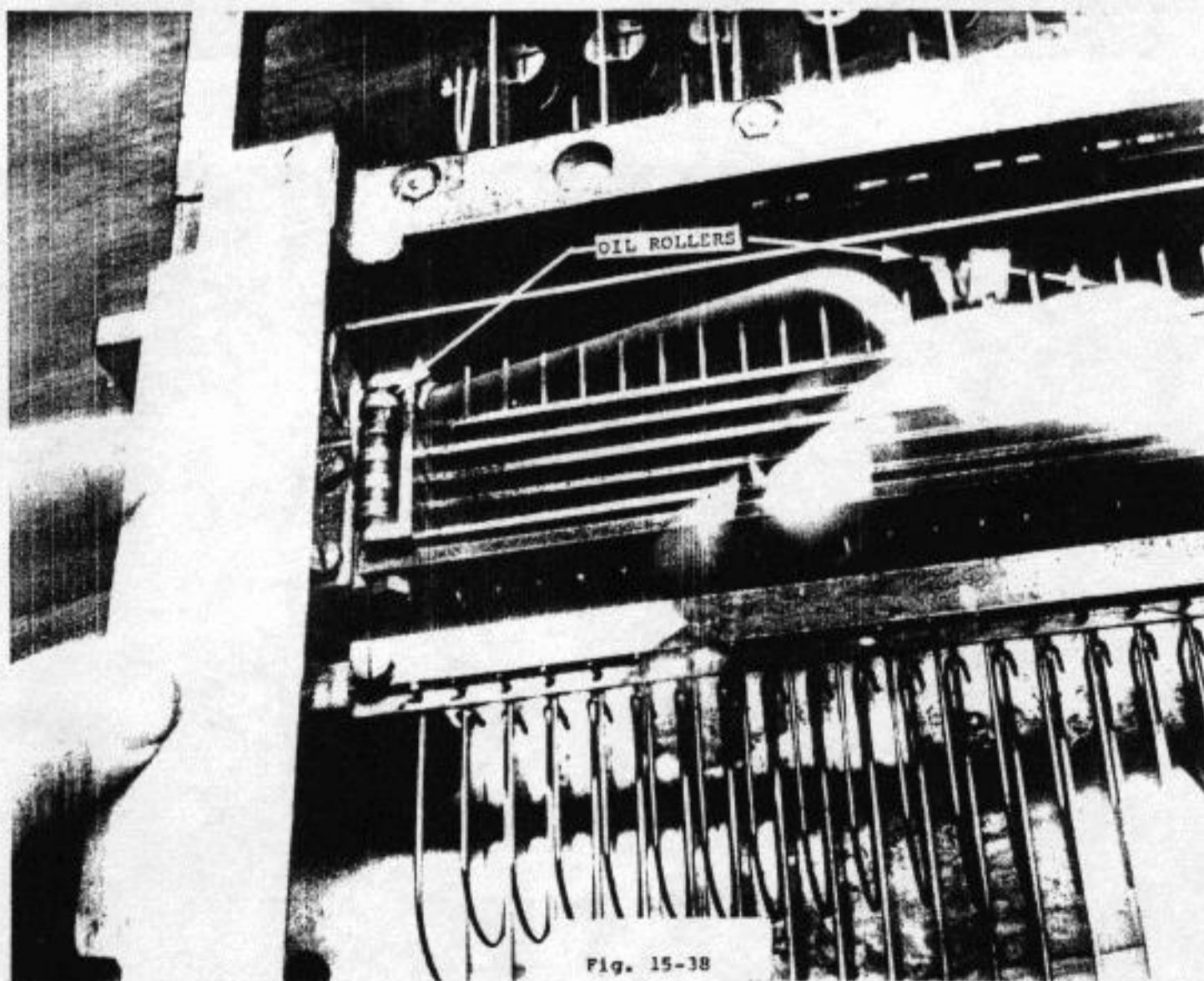

C. CONTACTS ON THE M15 KEYBOARD

Most communication troubles can be traced to poor contacts in keyboards. They may be dirty or be improperly gapped. Either or both, they result in distorted signals. In other words, we want properly adjusted contacts to assure clean, bias-free generation of TTY signals.

The contacts are the row of six vertical strips of metal showing on the left side of the transmitting cam assembly under the "question-mark" contact levers (Fig. 15-39).

The contact assembly can be taken apart for cleaning. Removal of two outer screws takes the assembly off the transmitting cam frame; removal of the two inner screws permits disassembly of the contact assembly. Unsolder the two wires from the contact plates (Fig. 15-39).

Place the disassembled contact parts (Fig. 15-40) in a bowl of naphtha for a few minutes to dissolve oil and dirt. Wipe the parts clean, and reassemble. If necessary, install new wires between terminals 4 and 5 and the contact plates.

Be gentle in replacing the contact assembly under the question-mark contact levers. Incidentally, it is well to know that these levers, like most parts in the Teletype machines, are made of hardened material - quite brittle and breaks off easily if bent over. Hence, do not bump or force these parts.

An alternative method of cleaning contacts is to use tobacco pipe cleaners. As shown in Fig. 15-41 and 15-42, this method is quite a time saver when on a customer call. A piece of tobacco

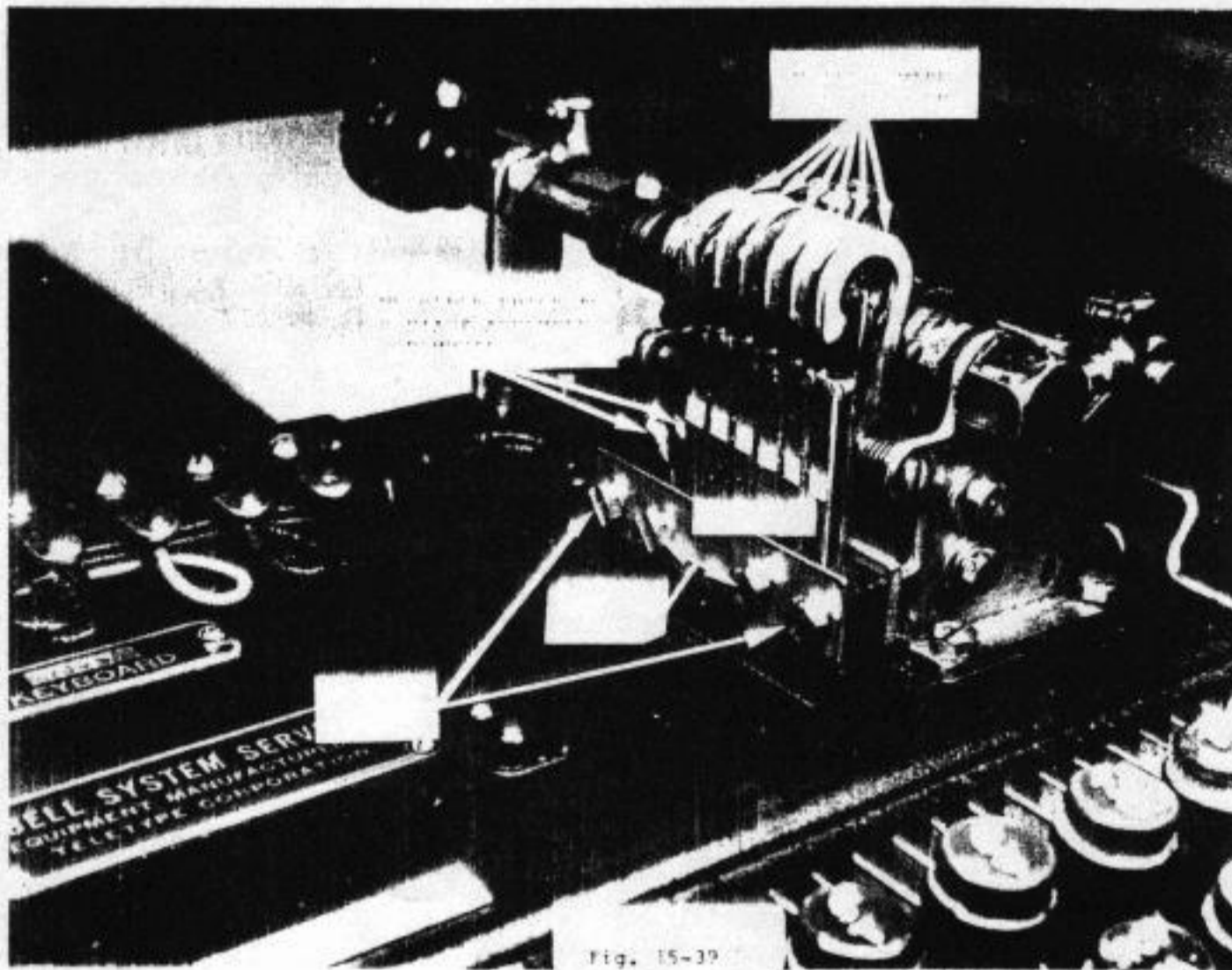

Fig. 15-39

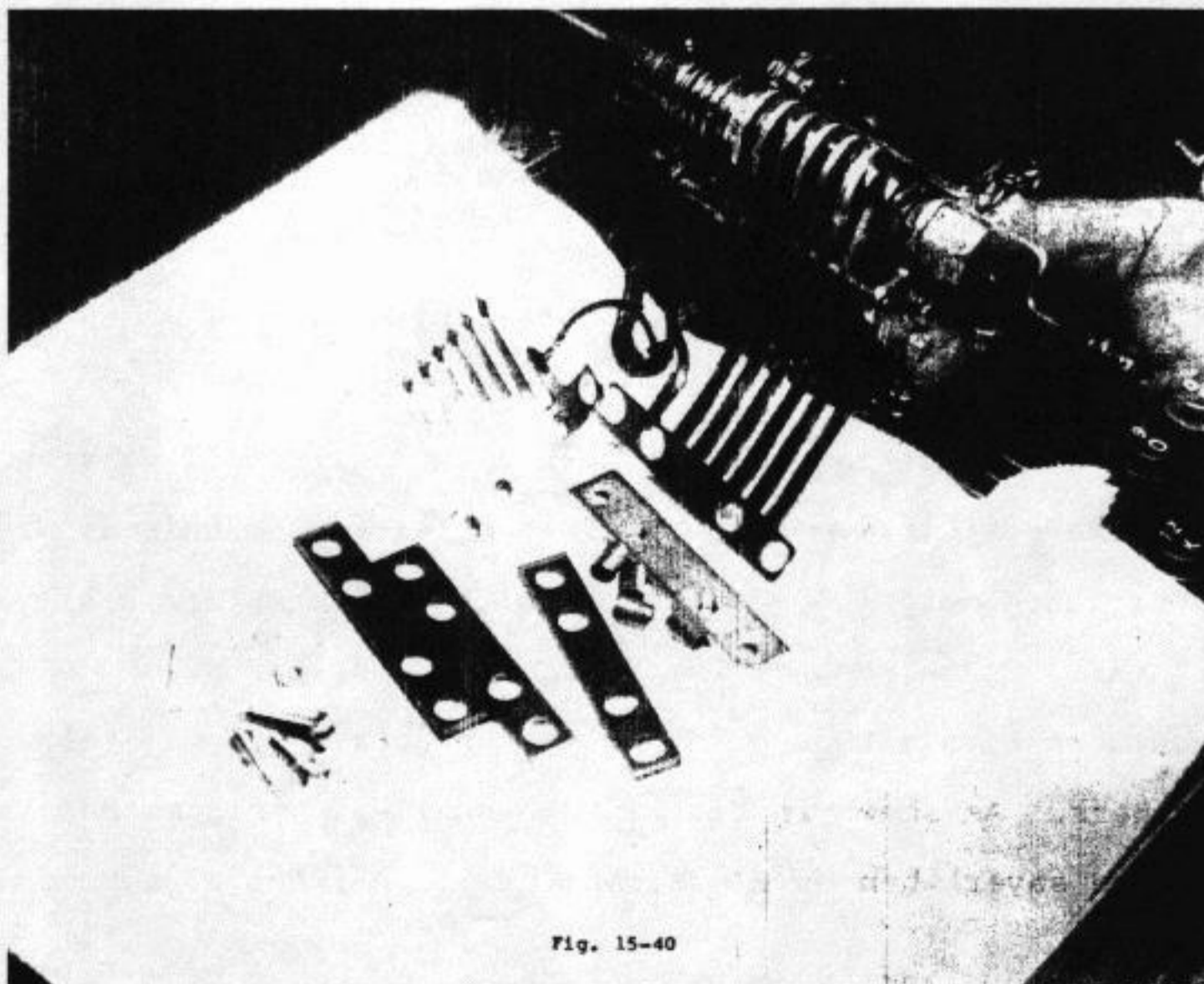
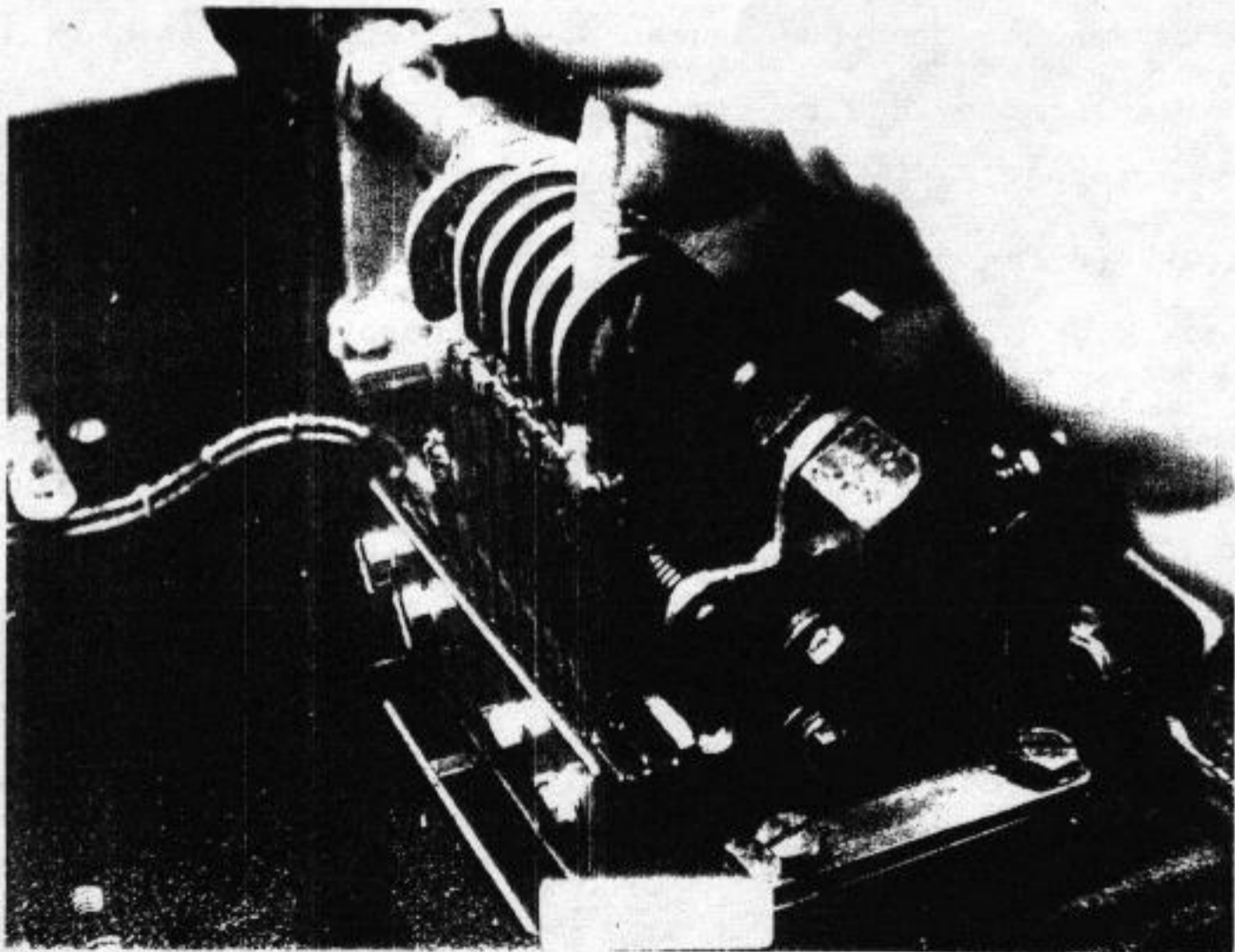
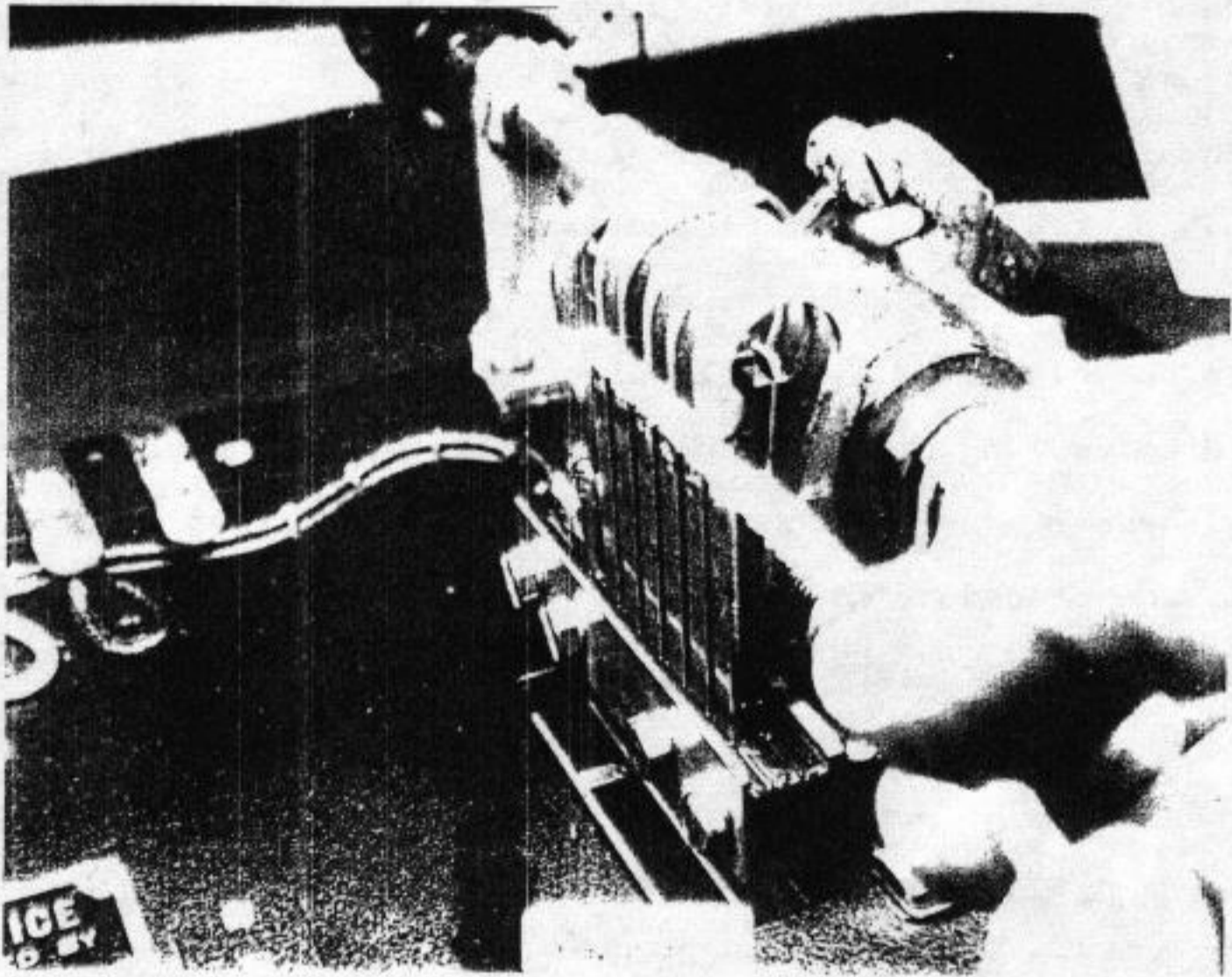

Fig. 15-40



M15-41

pipe cleaner is dipped into a bowl of naphtha or "Energine", then the wet cleaner is passed through the contact assembly, above and below the contacts. Very likely, it will come out dirty. Use fresh pieces of tobacco pipe cleaner, and keep swabbing all over, top, bottom, and sides of the contacts, until the cleaners finally come out clean. A final cleaning job is given the contact faces, by dipping long pieces of bond paper into the Energine, then passing these pieces through between the contact faces (Fig. 15-43).

The procedure is best done with the TTY machine running. The paper strips are repeatedly passed between the contacts, while LTRS key is being tapped. After the cleanup work is done, the keyboard may misprint, due to lint in between some contacts. Keep sending RY until the signal finally clears itself up. Blow on the contacts, if necessary, to get rid of lint.

Rather frequently, the M15 keyboard develops distorted signals, due to improper gapping between some of the contacts. This can be a source of annoyance to TTY receivers in the TDI network. Most TTY receivers are tolerant of moderate degrees of signal distortion. However, it is well to describe some simple adjustments which would improve keyboard performance and thus improve the overall reliability of communications.

As mentioned, there are six contacts in the M15 keyboard. The rearward contact is called the start-stop contact, while the next five contacts, coming forward, are for bits 1, 2, 3, 4 and 5 respectively (See Fig. 15-39).

Gaps between contacts are quite critical. Too wide a gap (over .02 inch, say) introduces spacing bias as well as possible

transition clicks. Too short gaps (less than .015 inch) introduces marking bias. Our experience indicates that the average gap lies between .015 and .020 inch. Many keyboards seem to generate the best possible averaged signal with .017 inch gap between all contacts including the start-stop contact.

There have been quite a few keyboards with the start-stop contact having too wide a gap - even as much as .030 inch. This leads to a bouncing contact and "double action" in the typing unit, that is, a character is received, followed immediately by a LTRS selection. Hence, the affected keyboard must be operated at below 30 WPM, on account of double action.

Naturally, a properly-gapped contact system results in a clean TTY signal, one having zero bias. This gives the TTY receiver the best possible chance of receiving a character properly, in spite of distortions along the line. This of course assumes that the TTY receiver has been found to be in good condition; has a wide range measurement of say 80 points, and is centered in the range.

The range finder scale on the M15 machine is calibrated to read from 0 to 120. A reading of 100 points corresponds to perfect selection of a precise 22-millisecond bit, from leading edge to following edge. However, the mechanical selector requires a finite time to sample over the entire 22 millisecond bit. Best we can do is to ascertain whether the mechanical selector provides a range span of at least 80 points. Thus, if the teletypewriter receives correctly on any range-finder setting between say 20 points (low end) and 100 points (high end), we find that the selector is

operating very well, and we are sure that the (receiving) TTY is in good adjustment.

A good signal source for checking TTY range is to receive a signal from a known zero-bias transmitter-distributor, having a message tape such as THE QUICK BROWN FOX JUMPS OVER THE LAZY DOG'S BACK. This also checks all the letters of the alphabet and some of the functions as well. If one gets range-finder readings of 20 to 100 with errorless printing, he is fairly certain of a good typing unit. He can use it to check its keyboard, and thus be certain, at least roughly, how much bias the keyboard may have. In other words, if the keyboard reads 20 to 100 on the range finder, the keyboard's bias is quite close to zero, and it can be depended upon to be close enough for all practical purposes.

This is a long story, but some mention has been made to indicate to the TTY owner a need for a careful check on his keyboard, with what available test equipment he may have. A Stelma TDA-2 Distortion Analyzer would be an ideal instrument to check keyboards, but such specialized equipment is hard to find, let alone difficult to use except by those with much experience.

At any rate, if a TTY owner uses his range finder to test his keyboard, he won't be far from perfectness if he finds a range span of 70 or 80 points from a low reading to a high reading. Low might be 10 and high might be 80, or low = 25 and high = 105 - at least 70 or 80 points difference indicates a good keyboard contact adjustment.

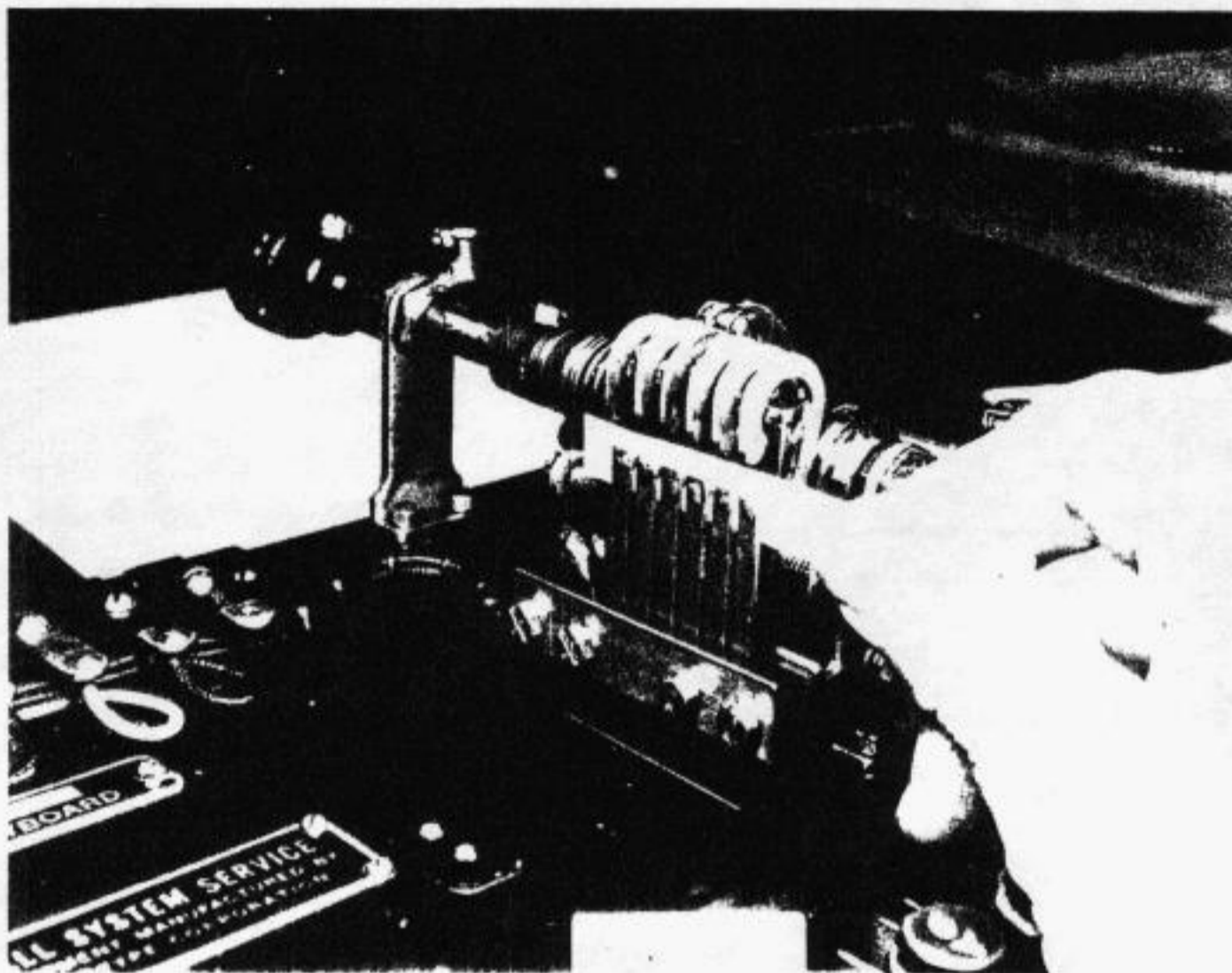

M15-45

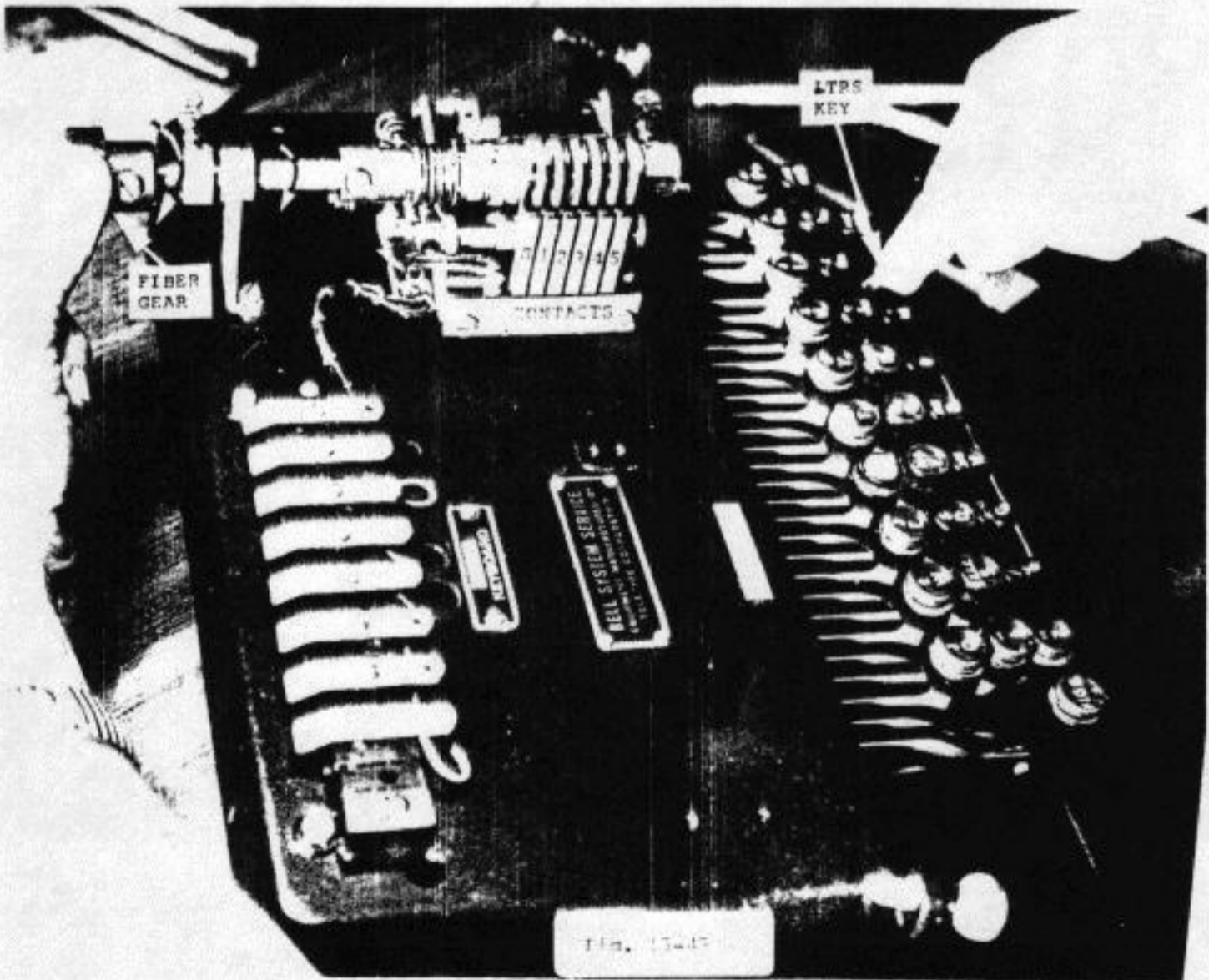
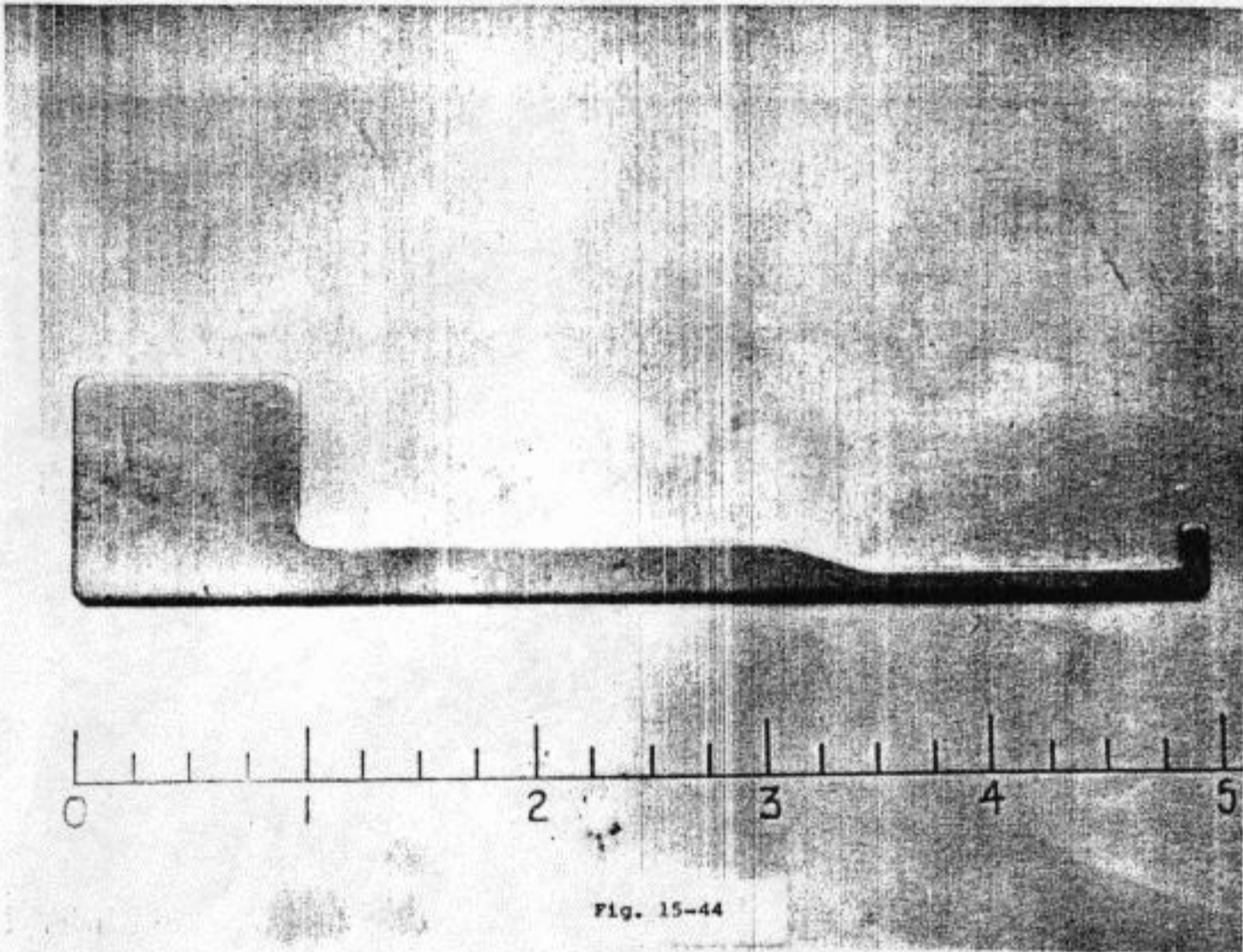

D. PROCEDURE FOR ADJUSTING CONTACTS ON A M15 KEYBOARD

A special tool is convenient for adjusting the individual contacts on the keyboard. It is shown in Fig. 15-44. It is available from Teletype Corp.; however it might be made up out of a piece of galvanized iron sheet, 1/16-inch thick. It should be hardened. However, a piece of coat hanger wire could be bent to a similar shape.

Further, a gauge will be needed to indicate a .020-inch gap. A suitable spark plug gap gauge will do satisfactorily.

1. Take the keyboard out of the M15 base, and place the keyboard on a workbench, with good lighting overhead.
2. As shown in Fig. 15-45, turn the fiber gear over and forward to yourself. Give it a spin to make sure the transmitting cam is properly latched.
3. Press LTRS key, then turn the fiber gear slightly up, over, and towards you until the start-stop contact opens. This is the first contact on the left of the row of six contacts. When this is done, all six contacts will be open, ready for inspection and gauging (See Fig. 15-45).
4. Take the .020-inch gauge (a spark plug gauge) and feel the gap between each contact and its opposite mate. This should give a good indication as to gap settings in the keyboard (See Fig. 15-46.)
5. Should a given gap be too wide, take the special tool and insert it as indicated in Fig. 15-47. Turn the handle gently, and see that that contact is bent in towards a correct gap.

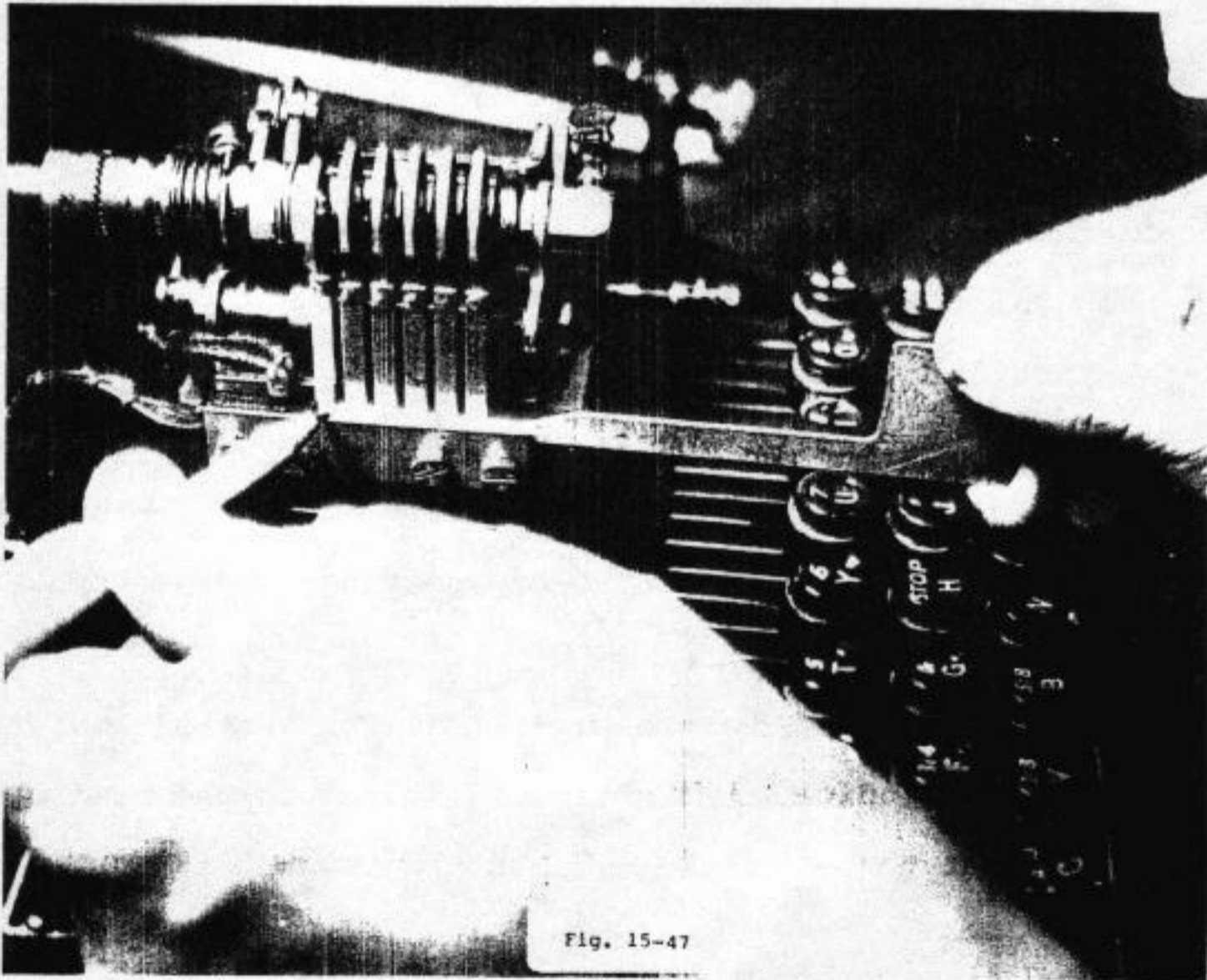
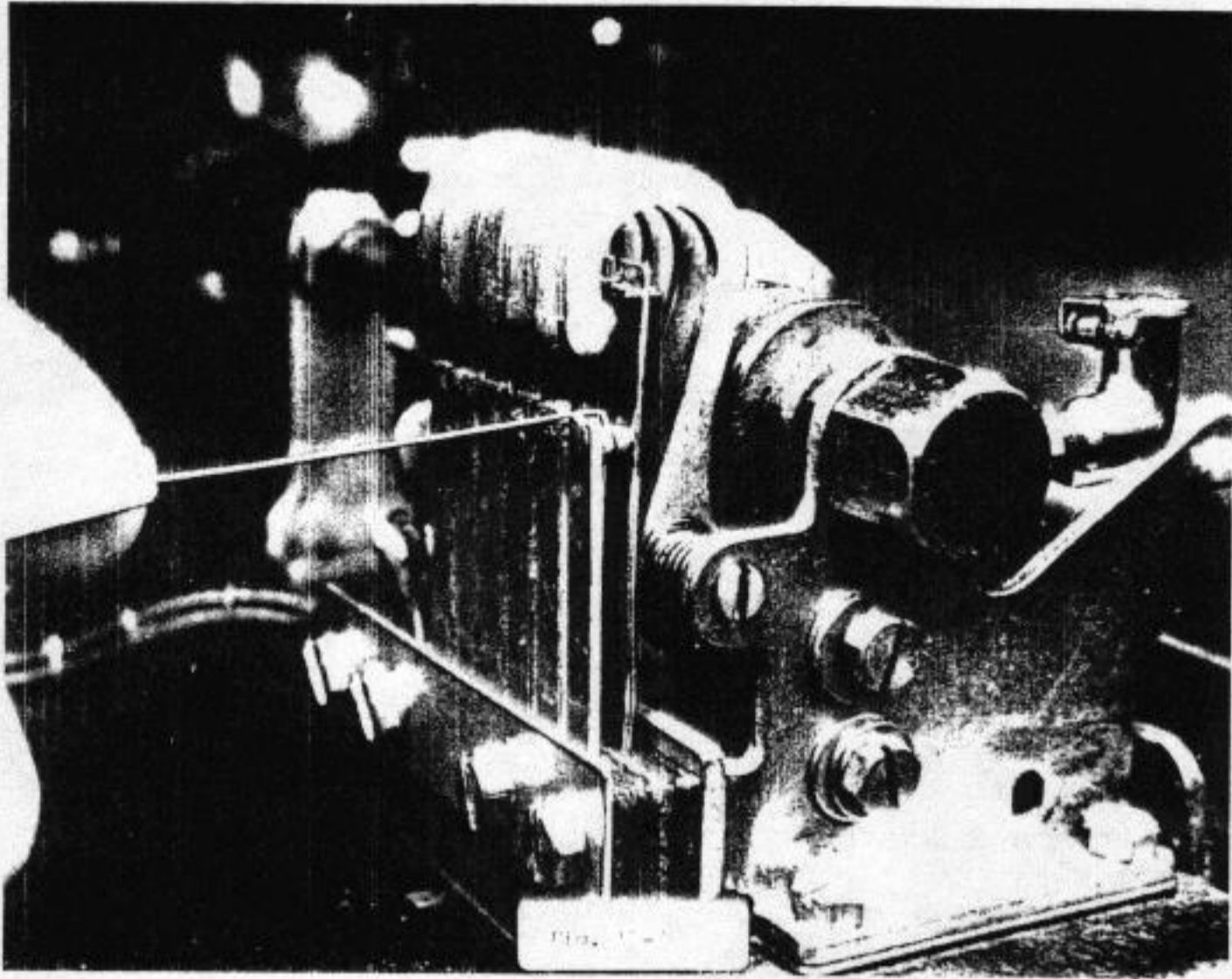

M15-48

6. If the gap is too narrow, insert the tool in between the rows of contacts and bend outward the contact in question. Fig. 15-48 shows this.

In general, take it easy on the tool. Each contact is rather easily bent, so a little finger pressure on the tool goes quite a ways.

The procedure described above should provide close-to-optimum contact gaps. Range finder measurements can of course, be taken as a check on keyboard contact adjustment. At any rate, the keyboard should have less than 5% bias. For instance, a range finder low point may be 20 on a known perfect signal, and it becomes 25 on the keyboard signal - the 5 difference reflects as a percentage of bias from a supposedly zero bias reference.

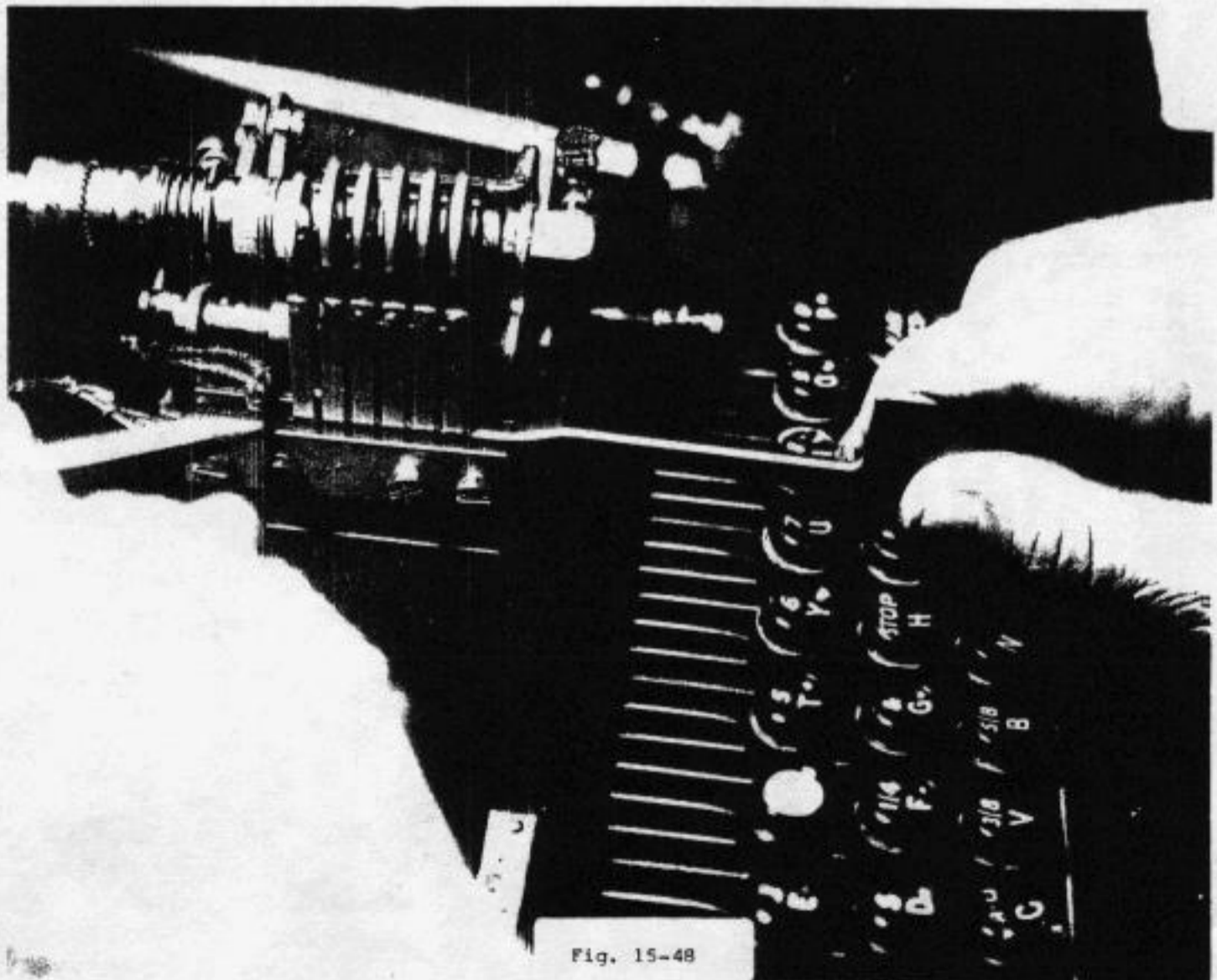

Fig. 15-48

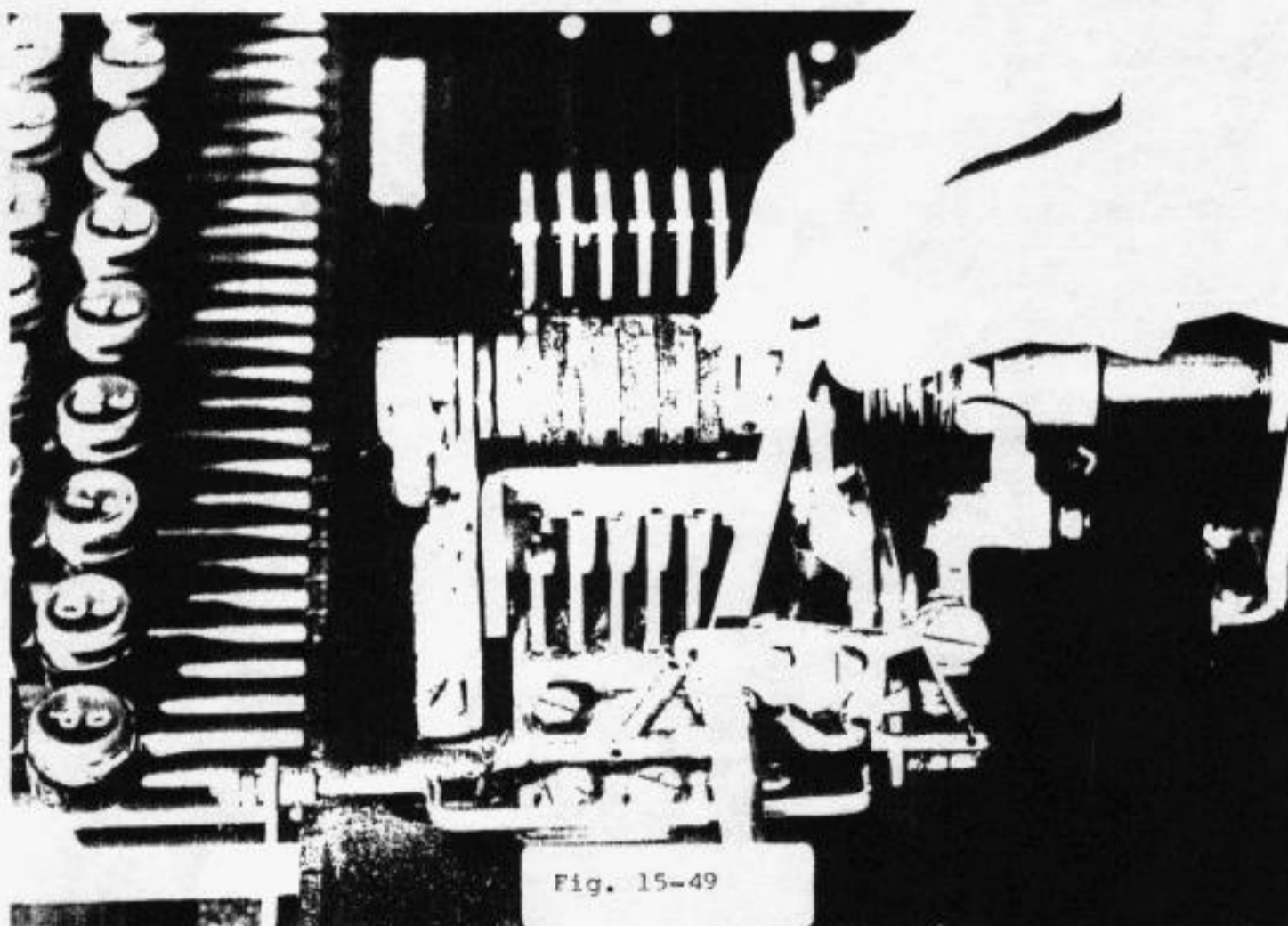
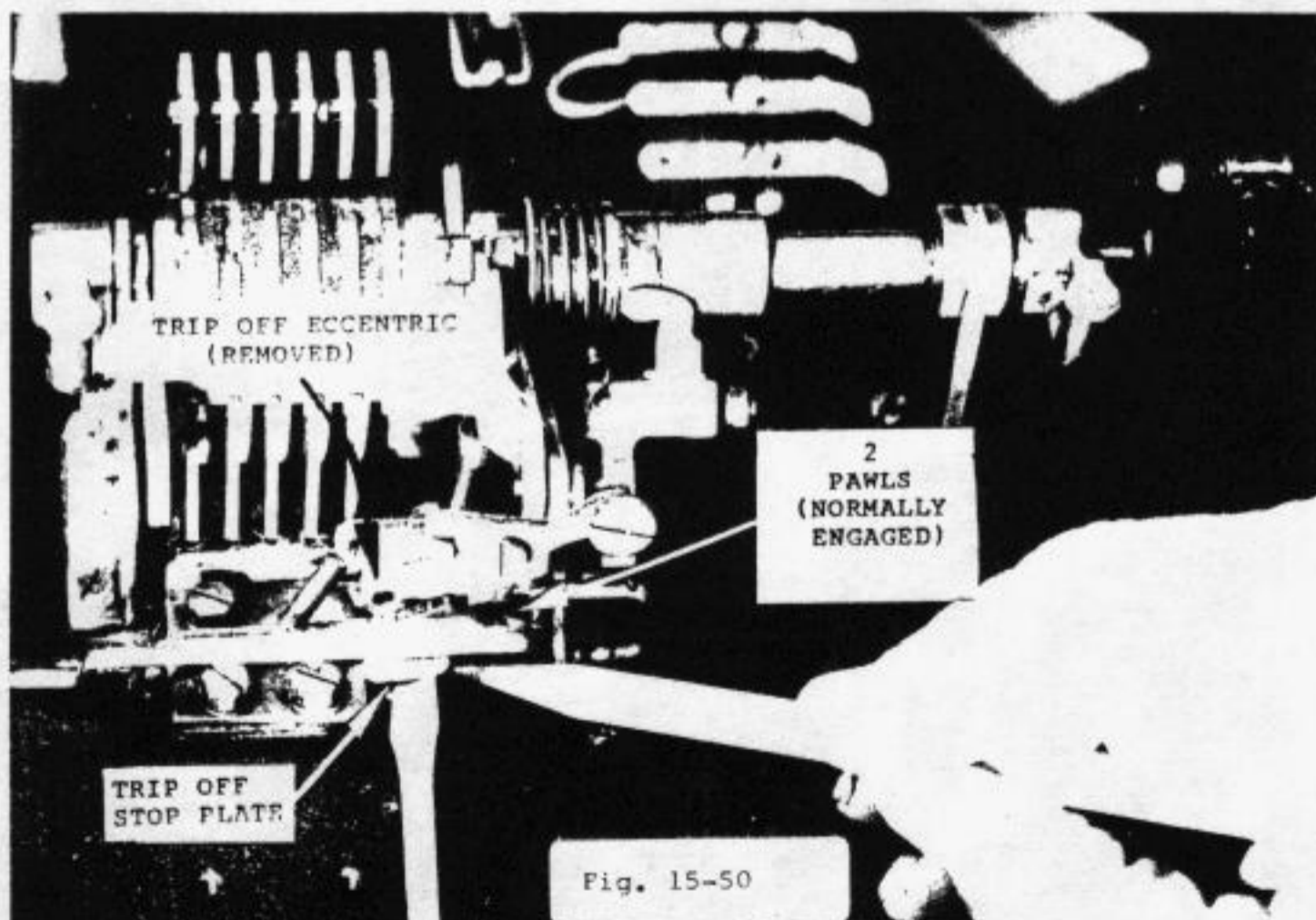

Fig. 15-49



TRIP OFF ECCENTRIC
(REMOVED)

2
PAWLS
(NORMALLY
ENGAGED)

TRIP OFF
STOP PLATE

Fig. 15-50

E. MODIFICATION OF A MODEL 15 KEYBOARD FOR EASY ACTION

For a fast typist, the Model 15 keyboard is sometimes a source of frustration. That is, unless he is good at rhythmical typing, the keyboard tends to kick back, thus resulting in dropped letters. This means that the typist has to go at about 45 to 50 WPM at maximum.

Here is a procedure for converting a M15 keyboard to repeat action. Two simple adjustments are involved. A cam-headed screw is removed from an indicated location (See Fig. 15-49). Further, a metal projection is bent up (see Fig. 15-50). The latter part is called the trip-off stop plate.

What has been done is to eliminate the trip-off pawl eccentric, which formerly slipped the trip-off pawl off the intermediate pawl. In other words, both pawls are continuously engaged. Repeat action is obtained on any one key. The typist will now find that he can "synchronize" his fingers to the keyboard and be able to type at a maximum 60 words per minute for long periods of time without skipping or dropping letters.

This modification will make many Model 15 owners and operators quite happy. The resulting feel is very good, considering the keyboard as it stands.

Figs. 15-51 shows the parts involved.

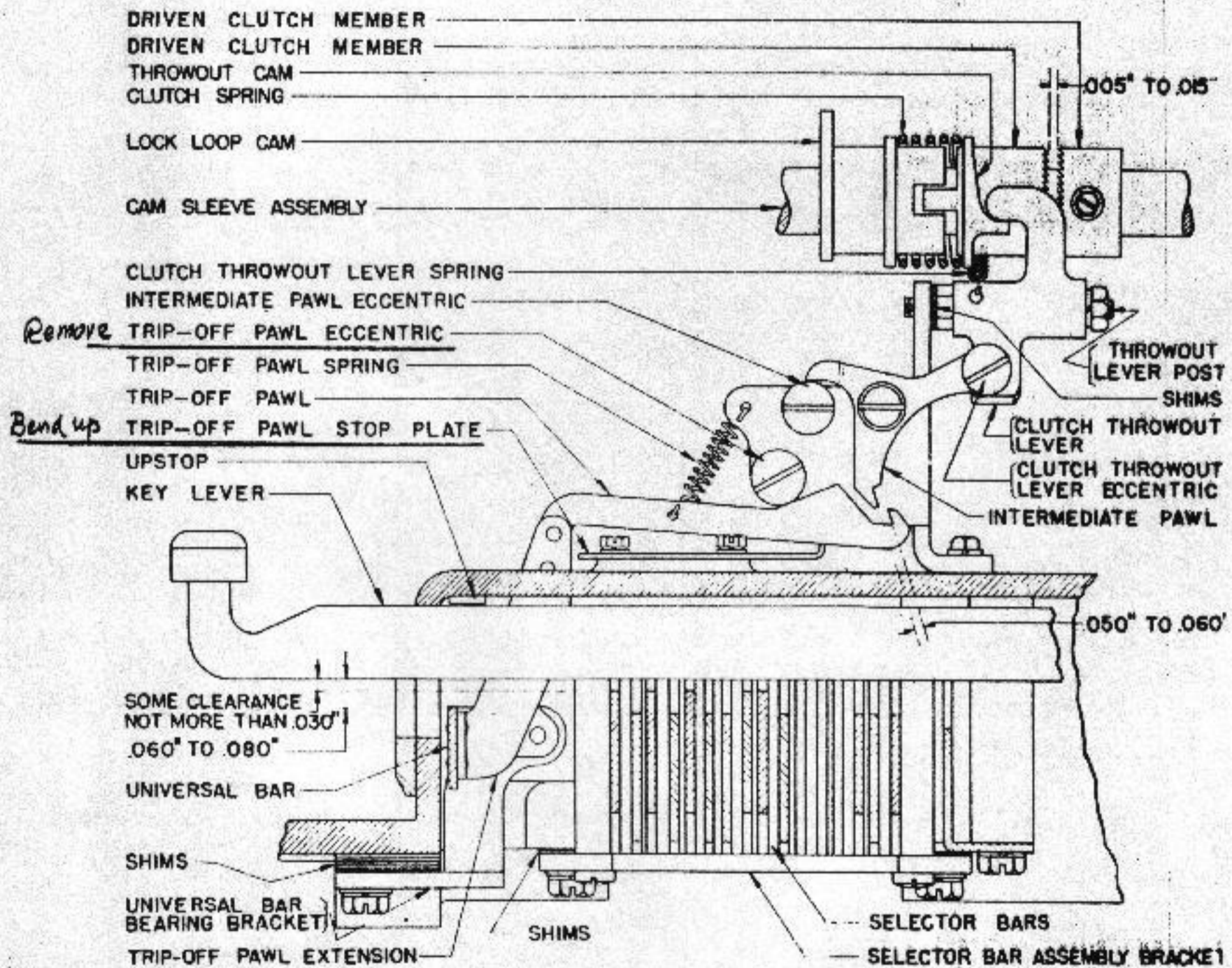

Fig. 15-51

F. GEARS ON CERTAIN WESTERN UNION MODEL 15 KEYBOARDS

It is known that there exist two styles of keyboards, as in use on Teletype Model 15 machines, coming from Western Union sources. Briefly speaking, the gears on the end of the keyboard cam shaft differ in size.

Care is needed to be sure that each such keyboard mates correctly with the typing unit involved. Should a certain keyboard be placed with an incorrect typing unit, one of two things will result: (1) the keyboard shaft will not be properly driven, or (2) the fiber gear will not fit correctly and is indicated by that the keyboard is difficult to push into the machine base.

DO NOT FORCE THE KEYBOARD IN!!

There exist two "signaling code patterns"; they are commonly referred to as the Bell System Standard 7.42-unit pattern and the Western Union 7.00-unit pattern. As far as signaling is concerned in the nationwide telephone-teletypewriter network for the deaf, either pattern is quite compatible, with absolutely no problems inasmuch as they both generate the basic 45.5 Baud signal. As a matter of interest, the 7.42-unit system operates at about 61 words per minute, while the 7.00-unit system operates at about 67 words per minute. They can still intercommunicate very well, as mentioned. It is just that the 7.00-unit keyboard feels a little bit faster in use.

As indicated on the attached copies out of the Model 15 parts book, the part numbers for the gears involved are as follows:
(See Fig. 15-52).

7.42-UNIT CODE (Bell System Standard)	Gear Size
Transmitting Keyboard Shaft Gear is #74595	1.100 in. dia.
Main Shaft (Typing Unit) Gear is #74596	1.407 in. dia.
7.00-UNIT CODE (Western Union)	
Transmitting Keyboard Shaft Gear is #74064	1.197 in. dia.
Main Shaft (Typing Unit) Gear is #74063	1.301 in. dia.

Take note that the keyboard cams are different on both 7.42 and 7.00 unit setups. Hence, if a cam is taken out to replace another, be sure that their type numbers correspond. Should different cams be swapped, they will result in incorrect signaling patterns, with confusion on all concerned. Needless to say, do not swap fiber gears, unless their numbers are the same.

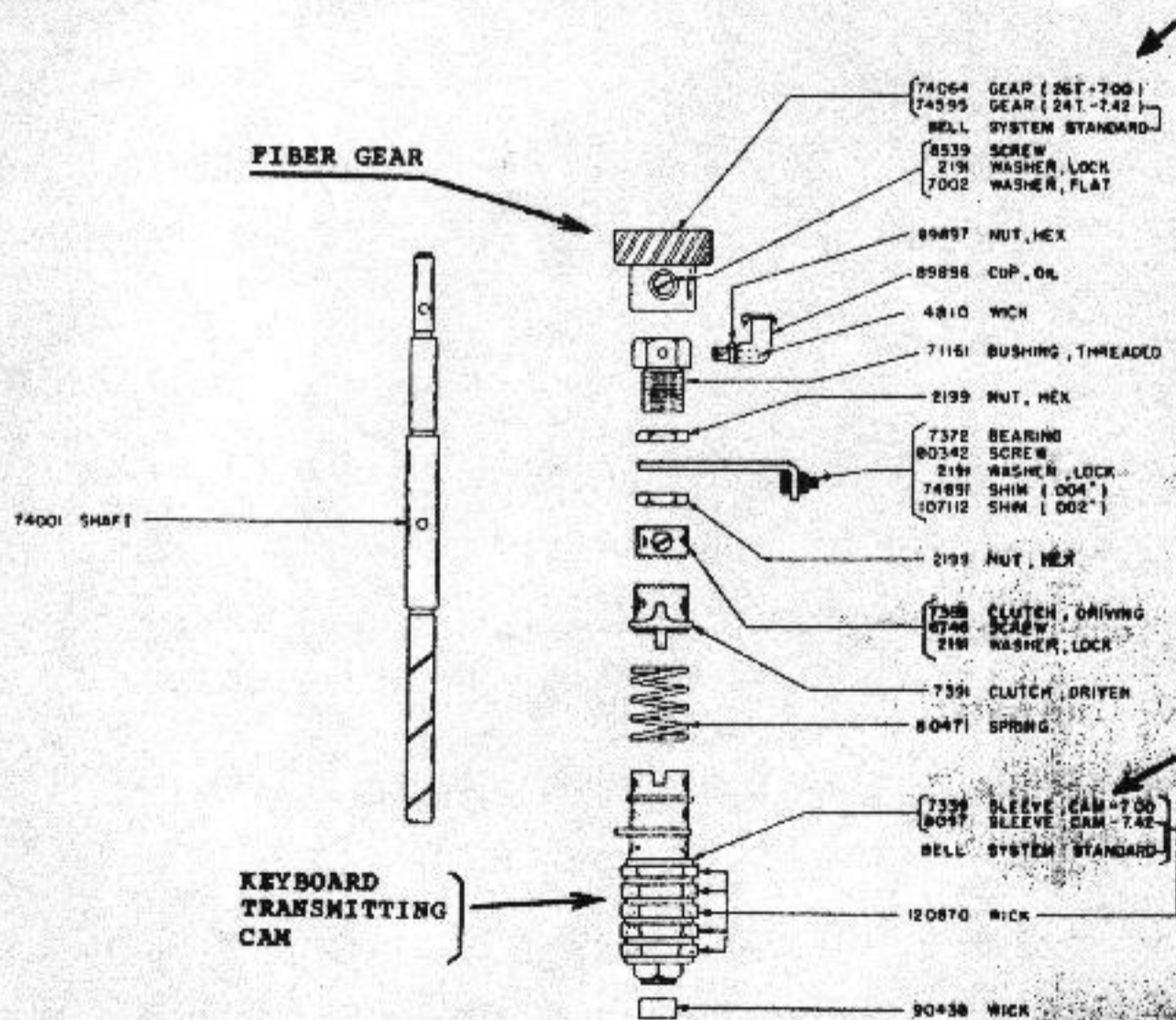

TRANSMITTING SHAFT PARTS
TELETYPE MODEL 15 KEYBOARD PARTS
 (Note the 7.00 and 7.42 unit cams
 and gears; do not mix them.)

Fig. 15-52

G. THE SELECTOR MECHANISM ON A M15 TELETYPE

This is one of the two most critical areas in the Teletype machine; the other being the keyboard contacts. The selector mechanism is on the left side of the typing unit; it is the one with a range finder scale (Fig. 15-53). We will describe it very briefly.

The incoming Teletype signal has a series of pulses, coming one-after-the-other in a certain time interval. When no signal is coming in, the machine is resting in a MARK condition. During this time, the magnet holds the armature to its pole faces because of a 60 mA MARK current flow. When a signal comes in, the very first pulse is a no-current condition, called SPACE. The magnet releases the armature during this time; an extension of this armature hits the pin on the top of the range finder assembly. The receiving cam is unlatched, and it rotates. During the subsequent cycle, the incoming five pulses, 1, 2, 3, 4, 5, of either MARK or SPACE, are sensed and transferred through "swords" to the "T" levers, which then actuate the upper five vanes on the front of the typing unit to set up the selection for the character just received. Near the end of the selection cycle, a jaw clutch is tripped to cause the mechanical printing cycle to take place - resulting in a typing out of a character (letter or number) on the paper.

In general, the selector mechanism is full of critical adjustments, best left to an experienced Teletype serviceman. Our experience thus far has been that the selector mechanism - and, for that matter, the entire typing unit - has been one of the most

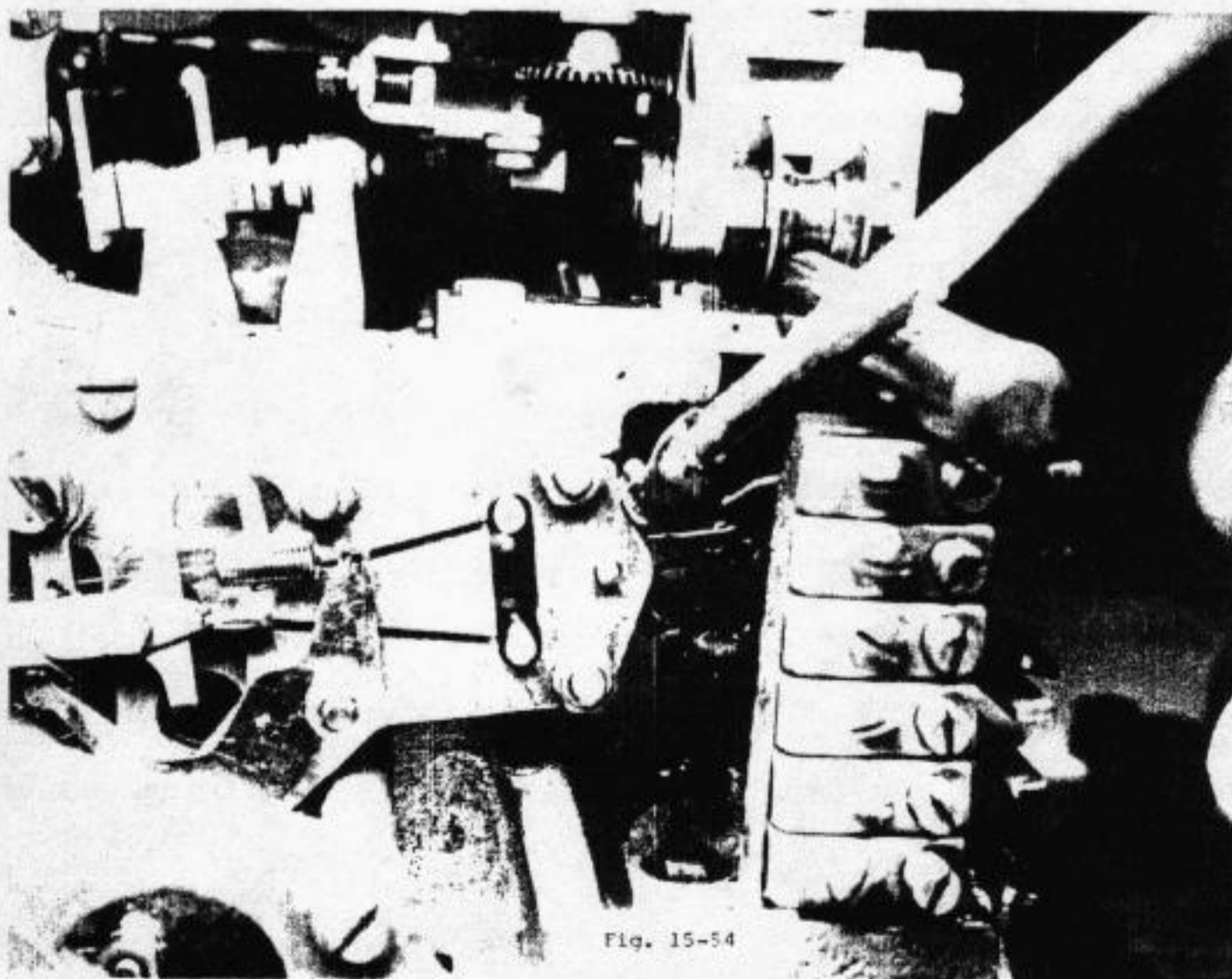
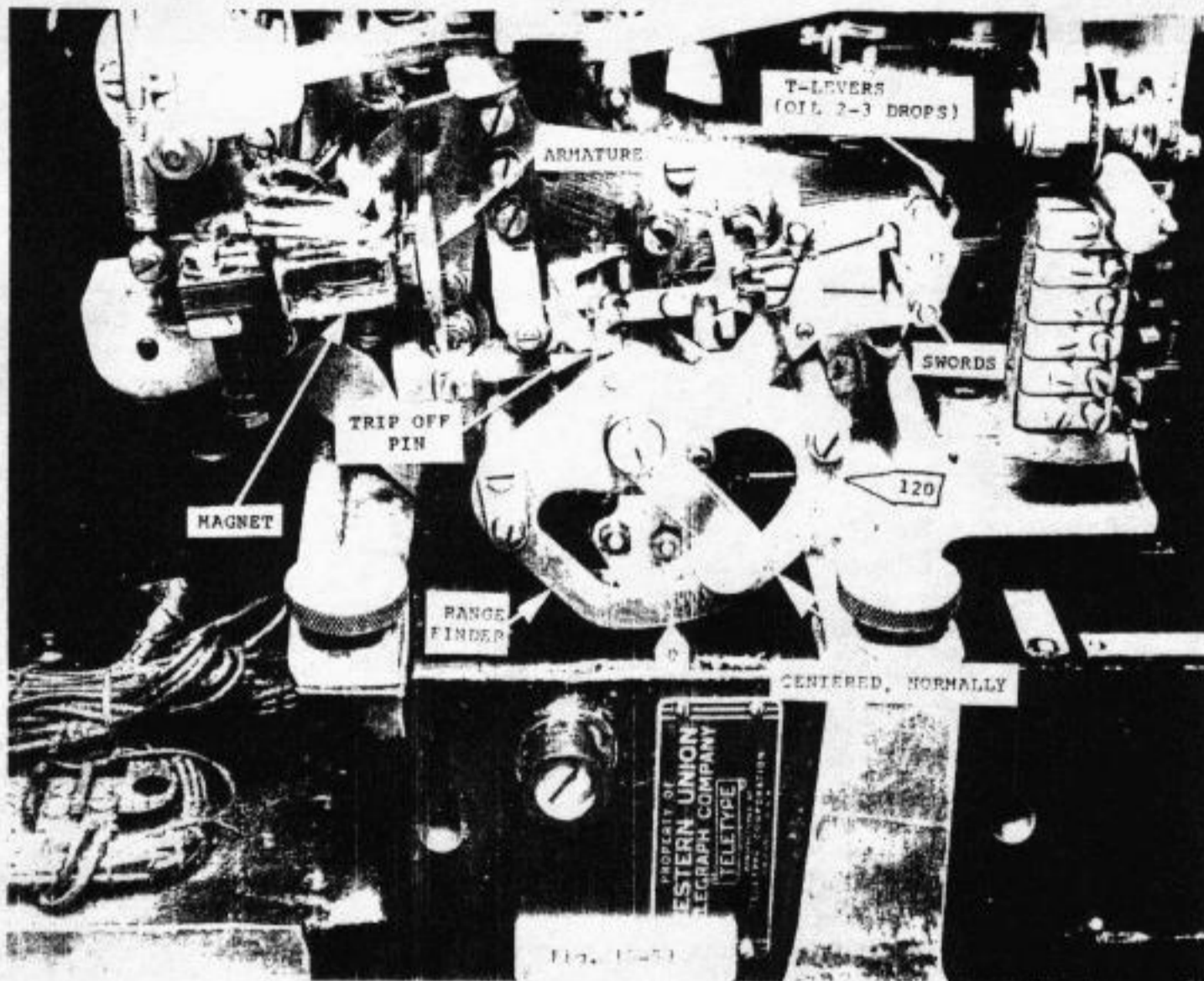

reliable portions of the Teletype machine. That is, the average TTY machine, as in use in the TDI network, should be in good operating condition. As explained before in the Keyboard Contact Adjustment section, the range finder will provide an indication as to the performance of the selector mechanism.

Tips on Proper Care of the Selector Mechanism...

1. Keep the felts oiled on the selector cam.
2. DO NOT ALLOW OIL ON THE SELECTOR MAGNET ARMATURE.
3. Apply a little oil, very little only, to the "T" lever area; this will provide optimum lubrication to the selector mechanism area. See Fig. 15-54.

The reason for the admonition in step 2 is that oil on the surface of the armature is quite upsetting to the timing in the selector area. Oil causes the armature to stick to the pole faces of the magnet. Should this ever happen, or if the selector has "gone bad", take a piece of bond paper and pass it in between the armature and the pole faces of the magnet. This should remove any oil film from the armature area. See Fig. 15-55. The TTY should be running; operate any key on the keyboard while passing the piece of paper in between the magnet and the armature.

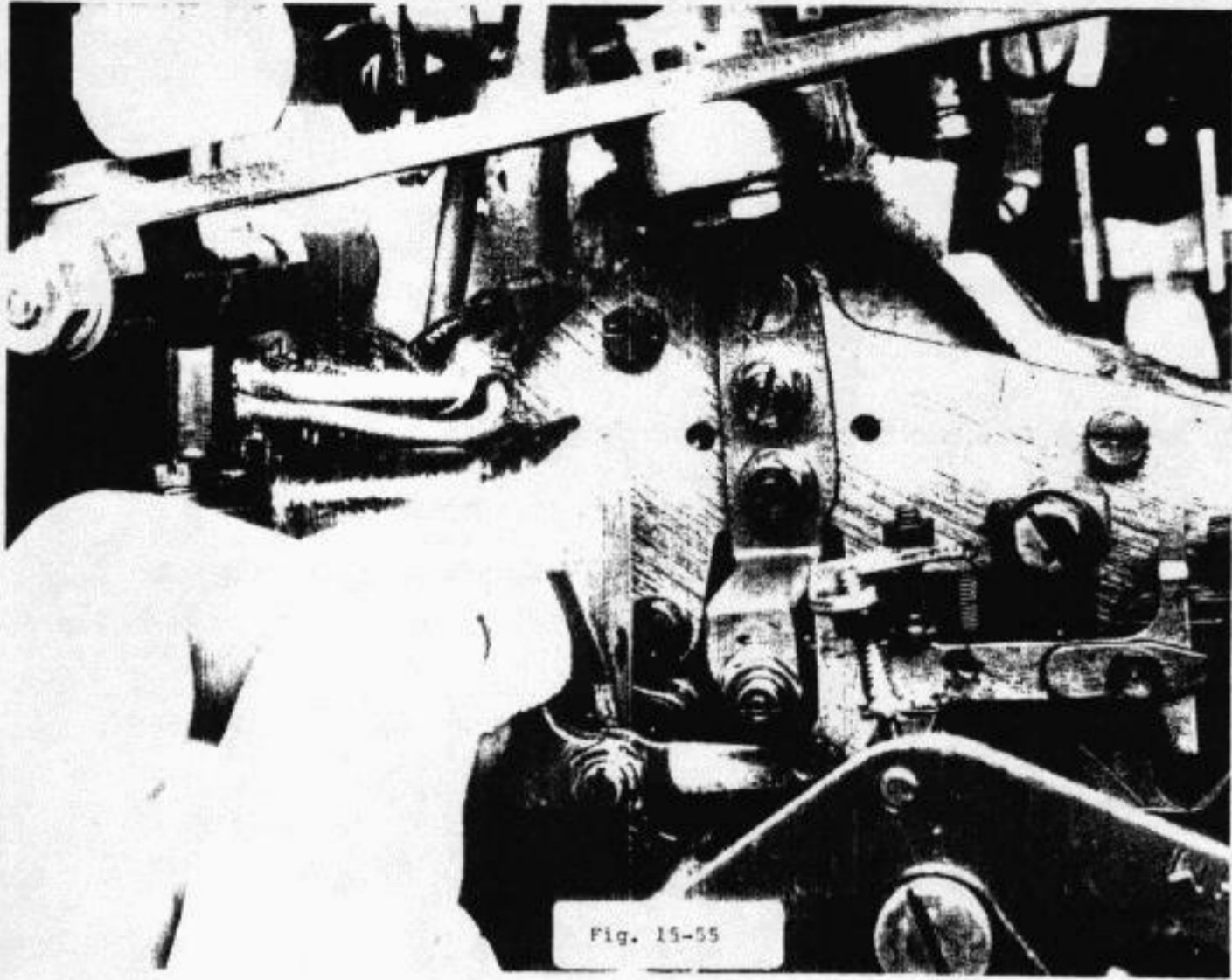

Fig. 15-55

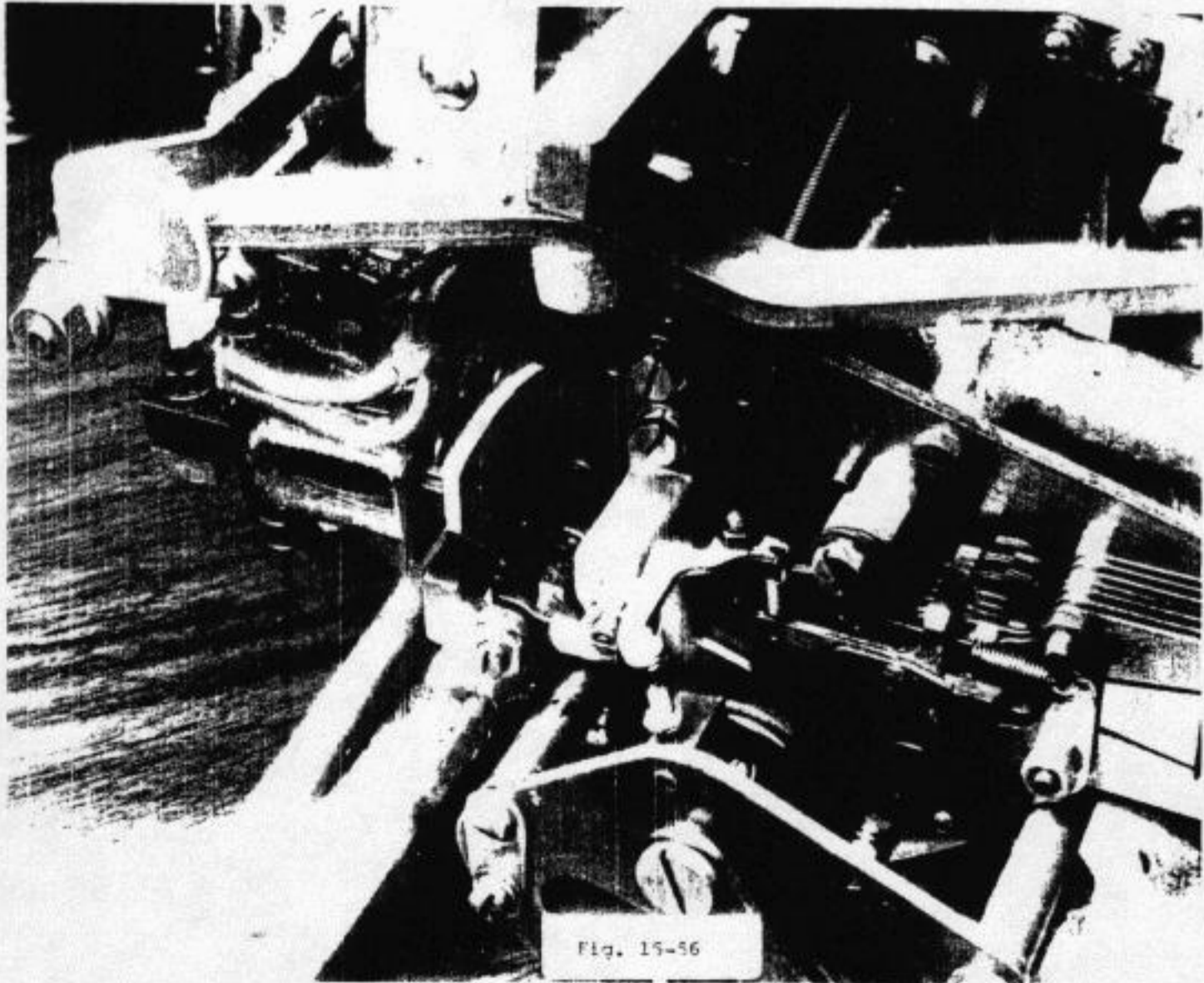

Fig. 15-56

M15-58

H. TWO DIFFERENT TYPES OF SELECTORS ON MODEL 15

As a matter of reference, M15 machines have two different types of selectors - one is called Pulling Magnet (Fig. 15-56), and the other is called Holding Magnet (Fig. 15-57). As far as performance is concerned, either will work as well as the other. However, they call for different adjustments; also they are somewhat dissimilar in electric drive requirements.

The Pulling Magnet System uses two 105-ohm coils in series (total resistance 210-ohms) and is always operated on a 60-70 mA magnet-line current basis.

The Holding Magnet System can be used on either a 20 mA or a 60 mA magnet-line current basis. The set up is arranged as follows: the two coils (each 100-ohms resistance) are placed in series for operation on a 20 mA line; a 5000-ohm resistor is connected across the seriesed coils for surge absorption. On a 60 mA line, the coils are placed in parallel, and the 5000-ohm resistor is not required. Typing units, having holding-magnet selectors, usually have switches to select parallel (P) or series (S) as necessary, so coil wires need not be manipulated. Fig. 15-58. Incidentally, the measured resistance of a 60 mA holding-magnet setup is 50-ohms; this is for information when doing continuity tests using an ohmmeter.

Acoustic couplers, in use in the TDI network, provide 60-70 mA magnet-line currents - suitable for either pulling-magnet or holding-magnet selectors. Just be sure the latter selector is set up to have its coils in parallel; (P) position on switch.

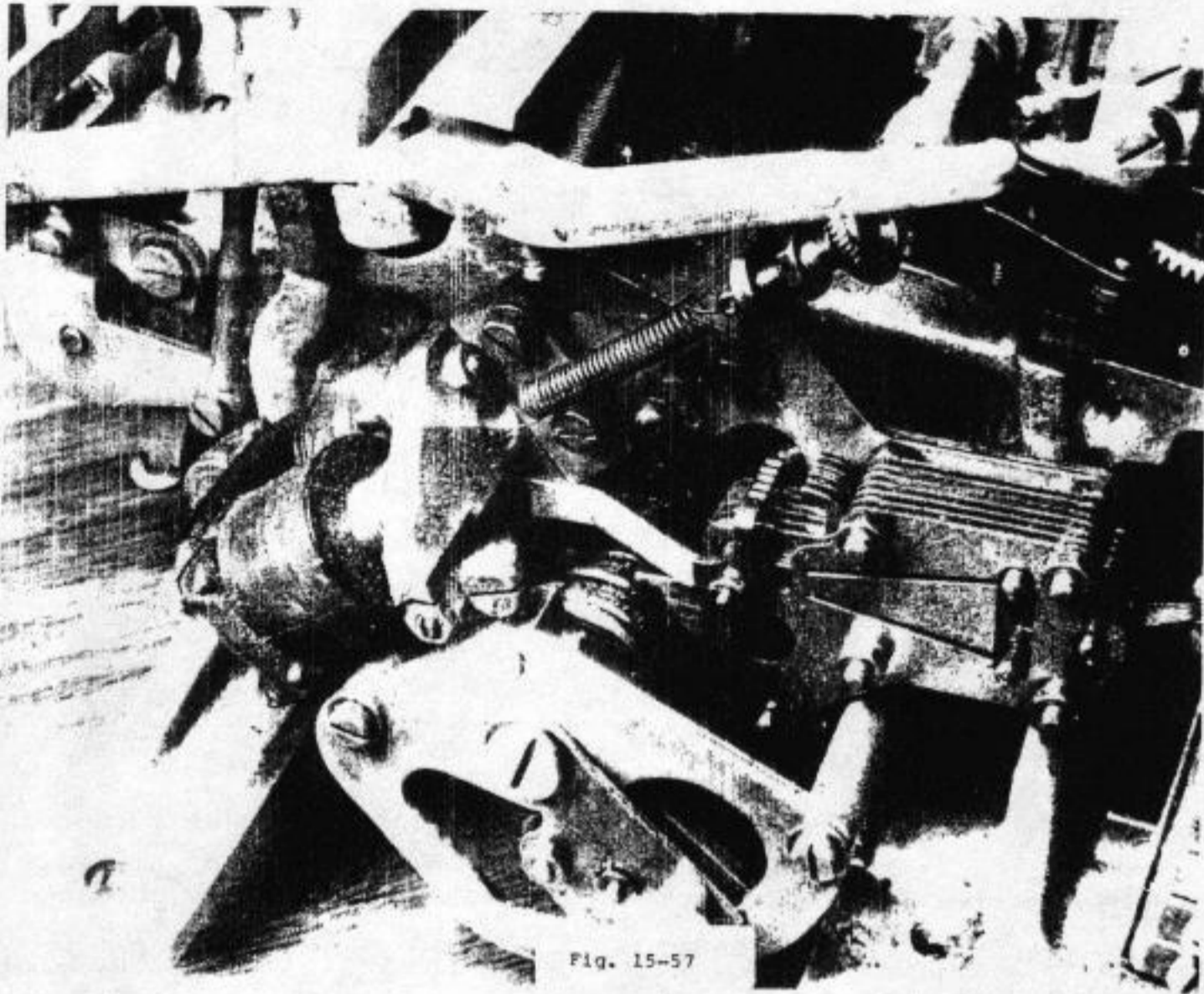

Fig. 15-57

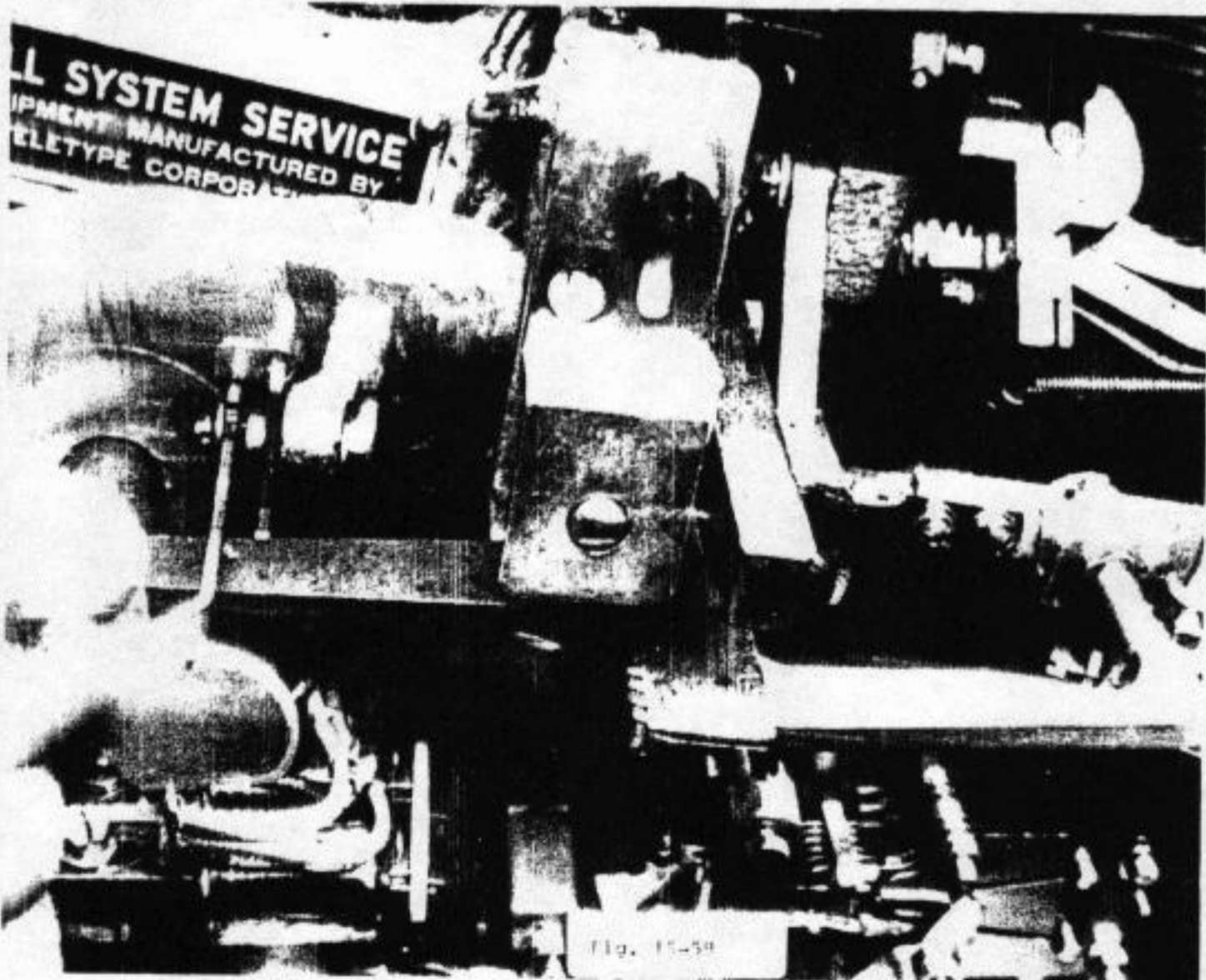

Fig. 15-58

I. MOTOR GEARING ON MODEL 15 TELETYPE

Inasmuch as the TDI network is on a 60-wpm nominal speed rating (also referred as 45.45 Baud), all teletypewriter machines must conform to this standard speed, so that anyone can communicate with another.

M15 machines from most places arrive with the proper 74912 pinion, 74913 fiber gear combination already installed. Such machines are ready to use on the TDI network. However, there are many recent Bell System M15 units having 75-wpm gearings. These units must be fitted with new 60-wpm gears in order to conform to the TDI standard. The required 74912 and 74913 gears are obtainable from several sources at reasonable prices - around \$10 a pair.

It is very easy to change gears. On the motor, the pinion gear can be removed simply by taking out a set screw and then pulling the old gear off. See Fig. 15-59. It may be necessary to loosen the motor base by unscrewing two screws, one on each side of the motor (Fig. 15-60) so that the motor base can be tilted upwards to clear the top of the M15 base. As for the typing unit, it is upended so that its left side sits on the workbench top. The fiber gear is accessible (Fig. 15-61); all that is needed is to take its clamp screw out, and then the fiber gear (along with its hub) will slip off (Fig. 15-62). Remove the hub from the old fiber gear by taking out three long screws. Install this hub on the new 74913 gear, and tighten all three screws securely thereupon. Remount the new gear on the end of the M15

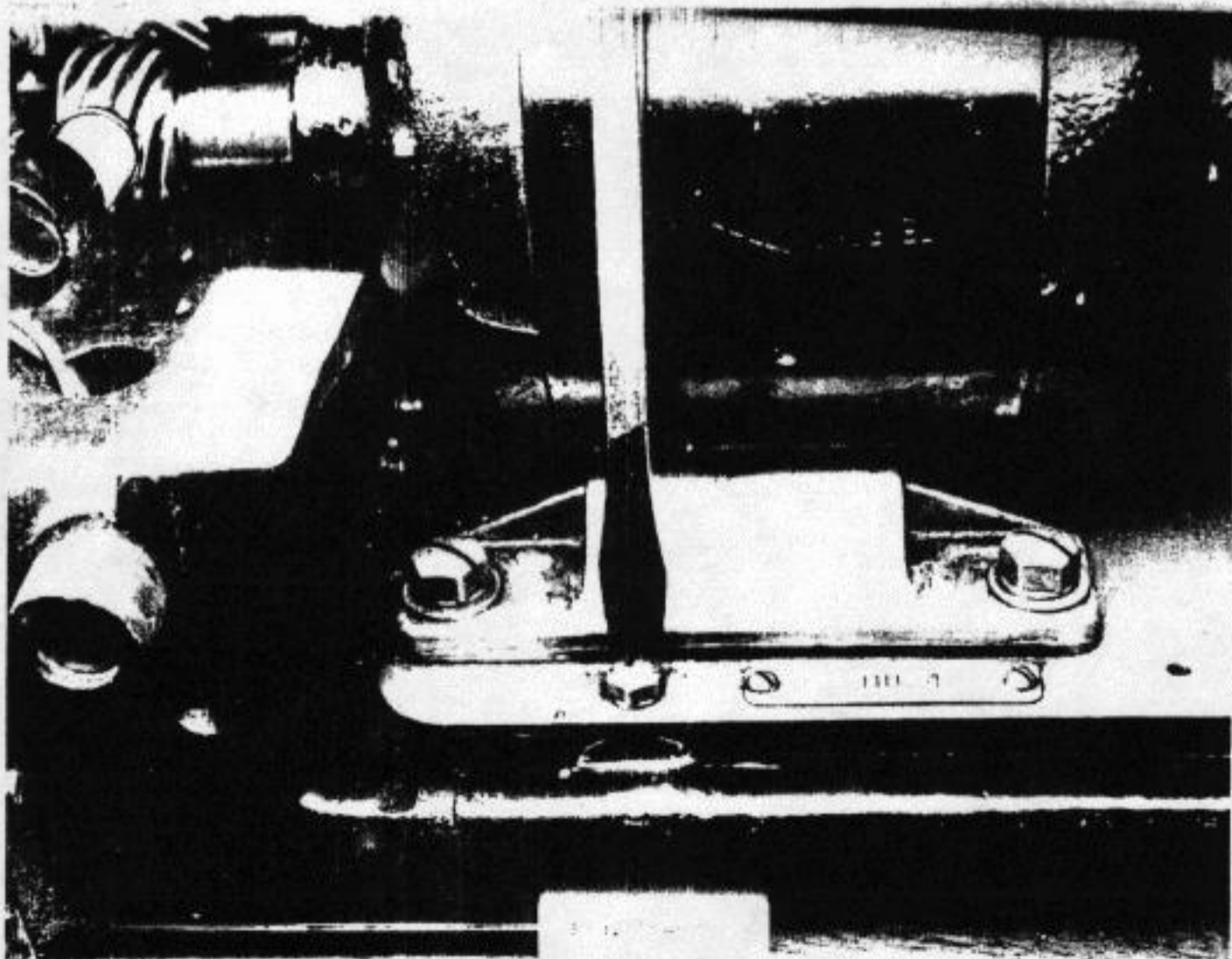
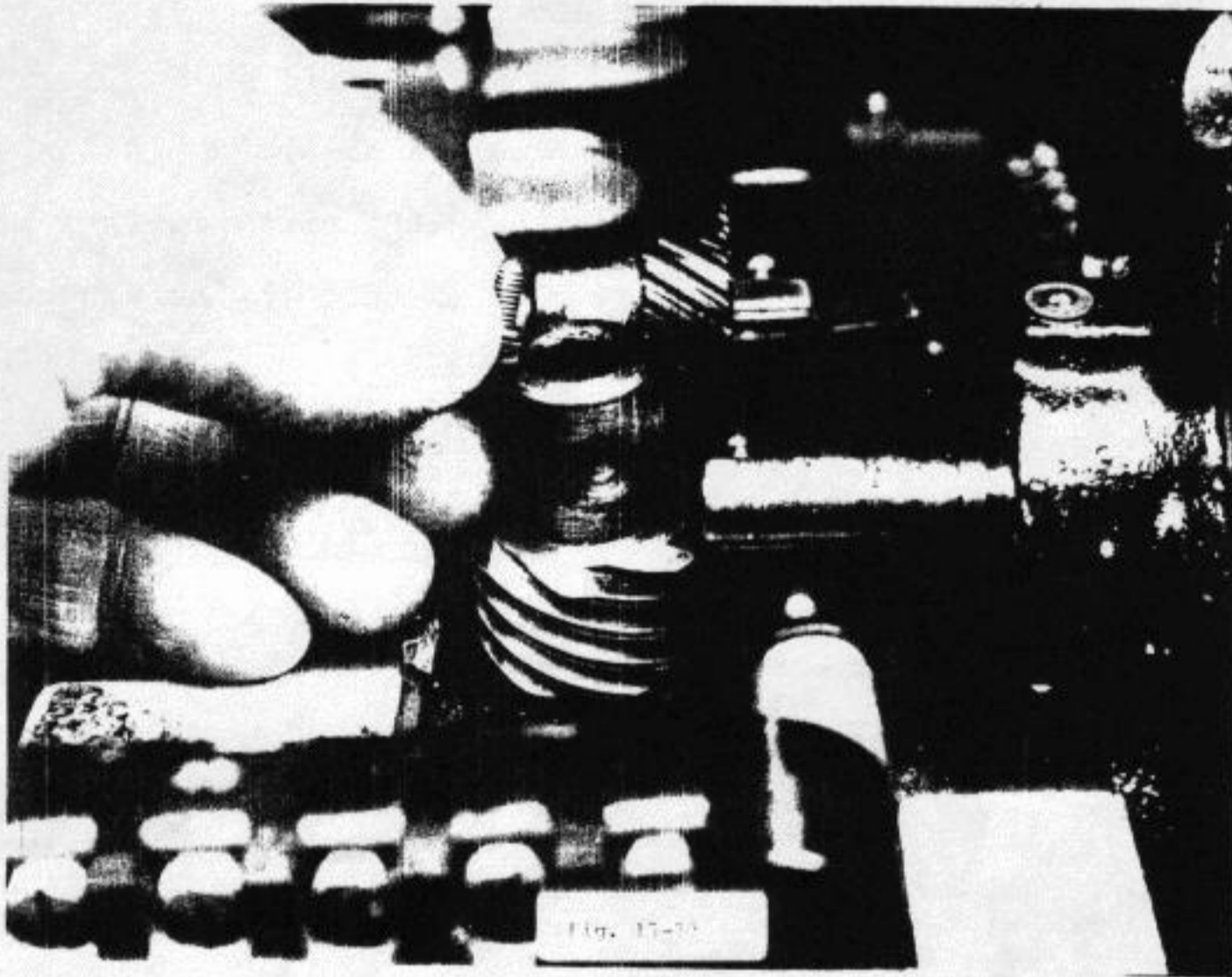

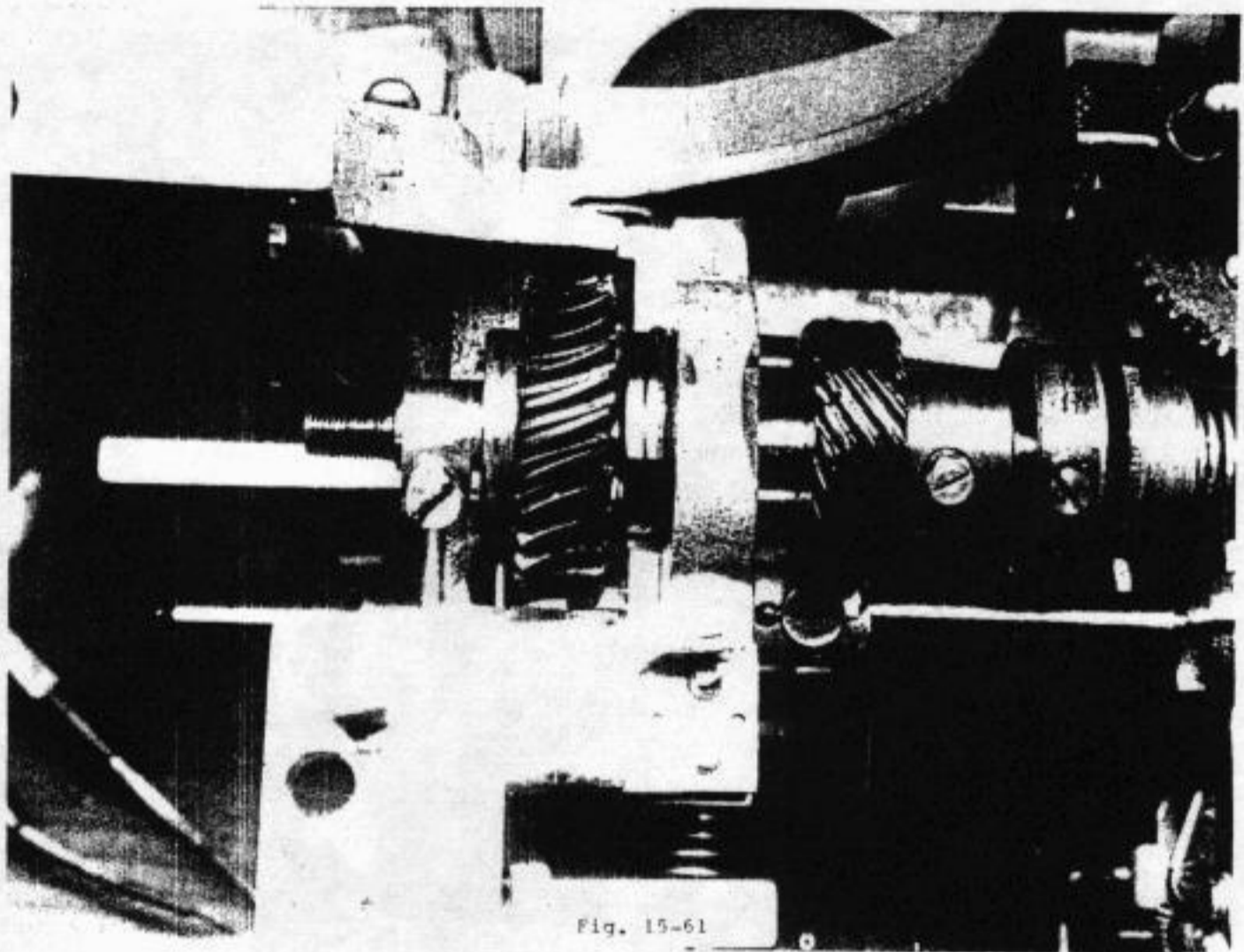

Fig. 15-61

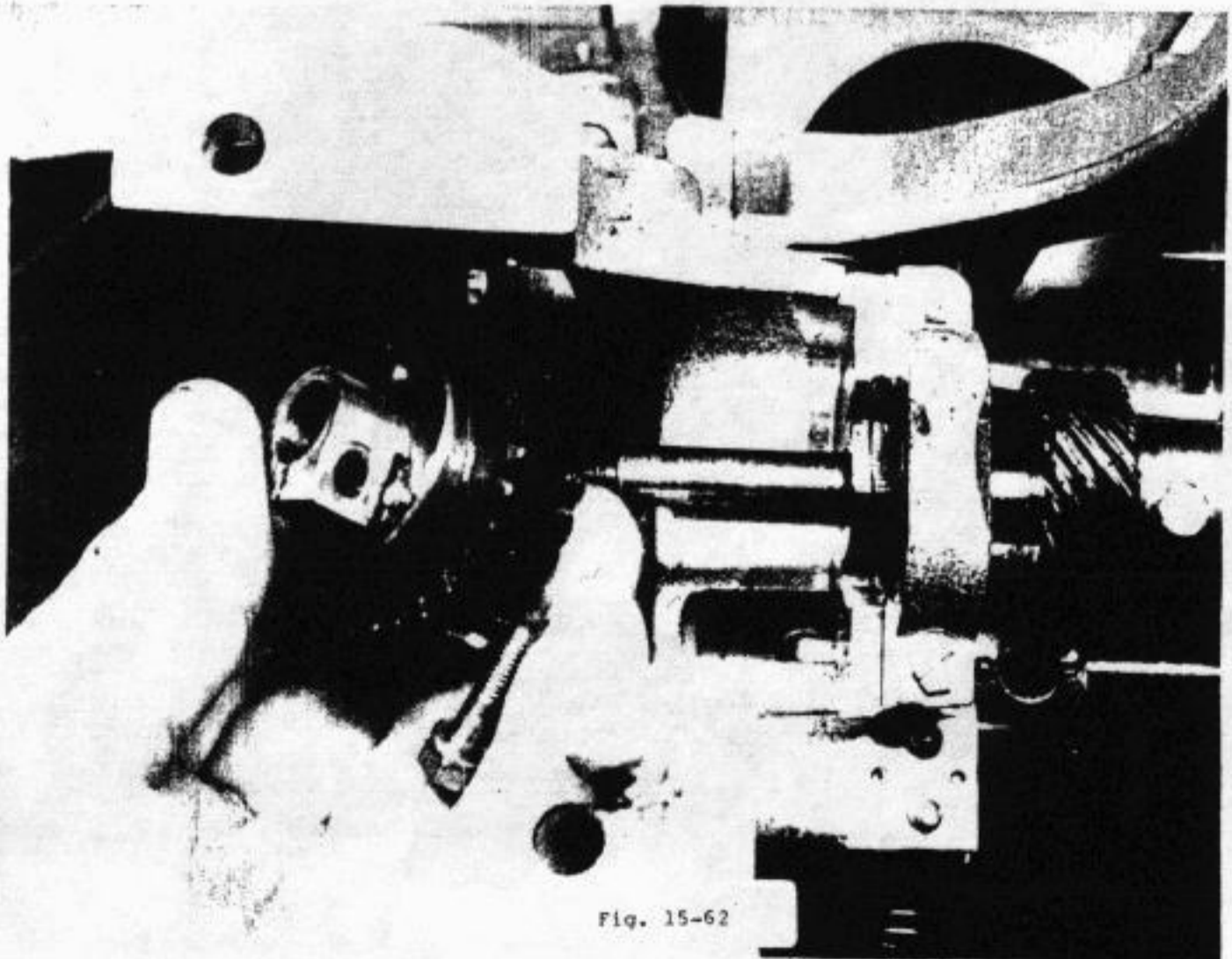
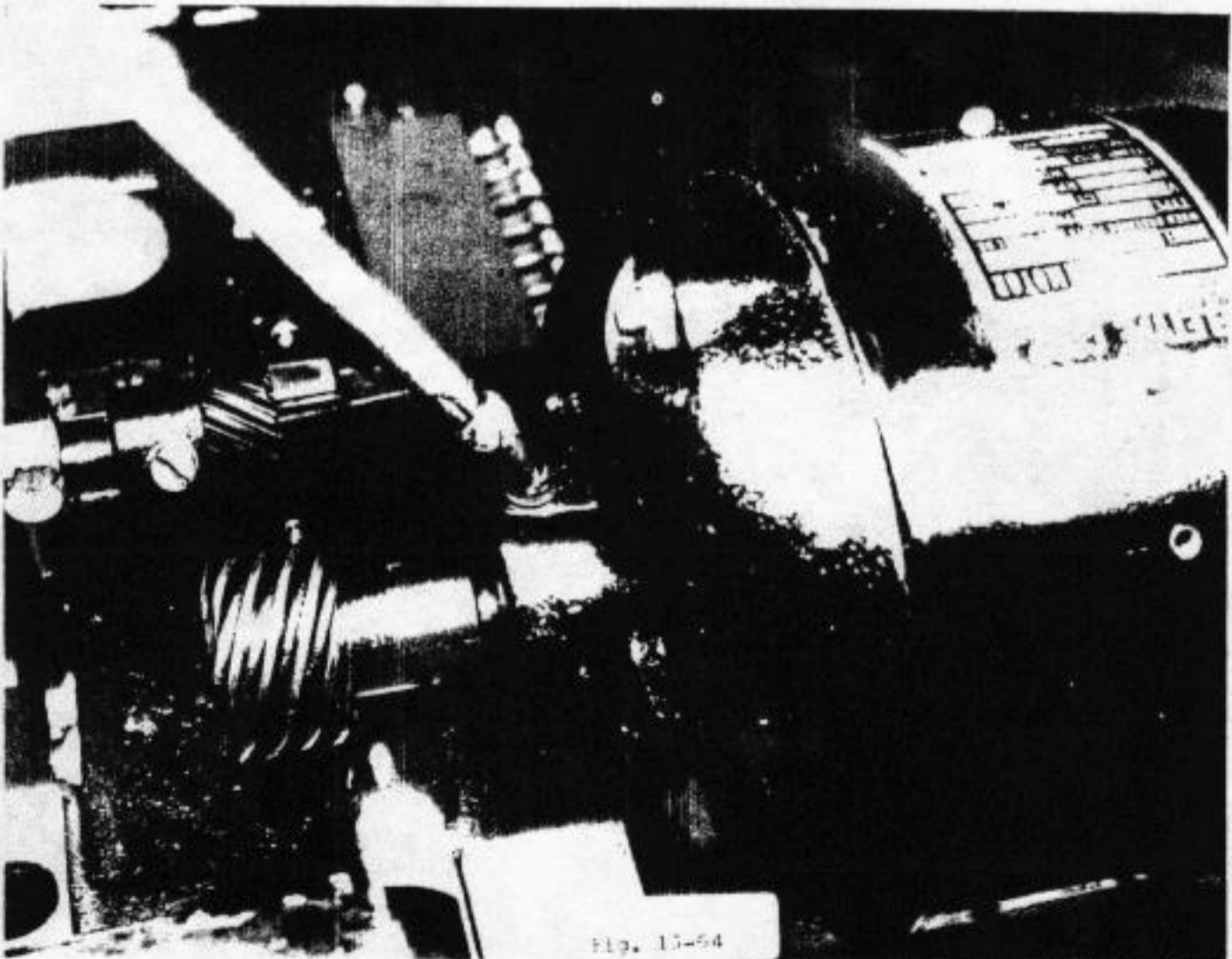
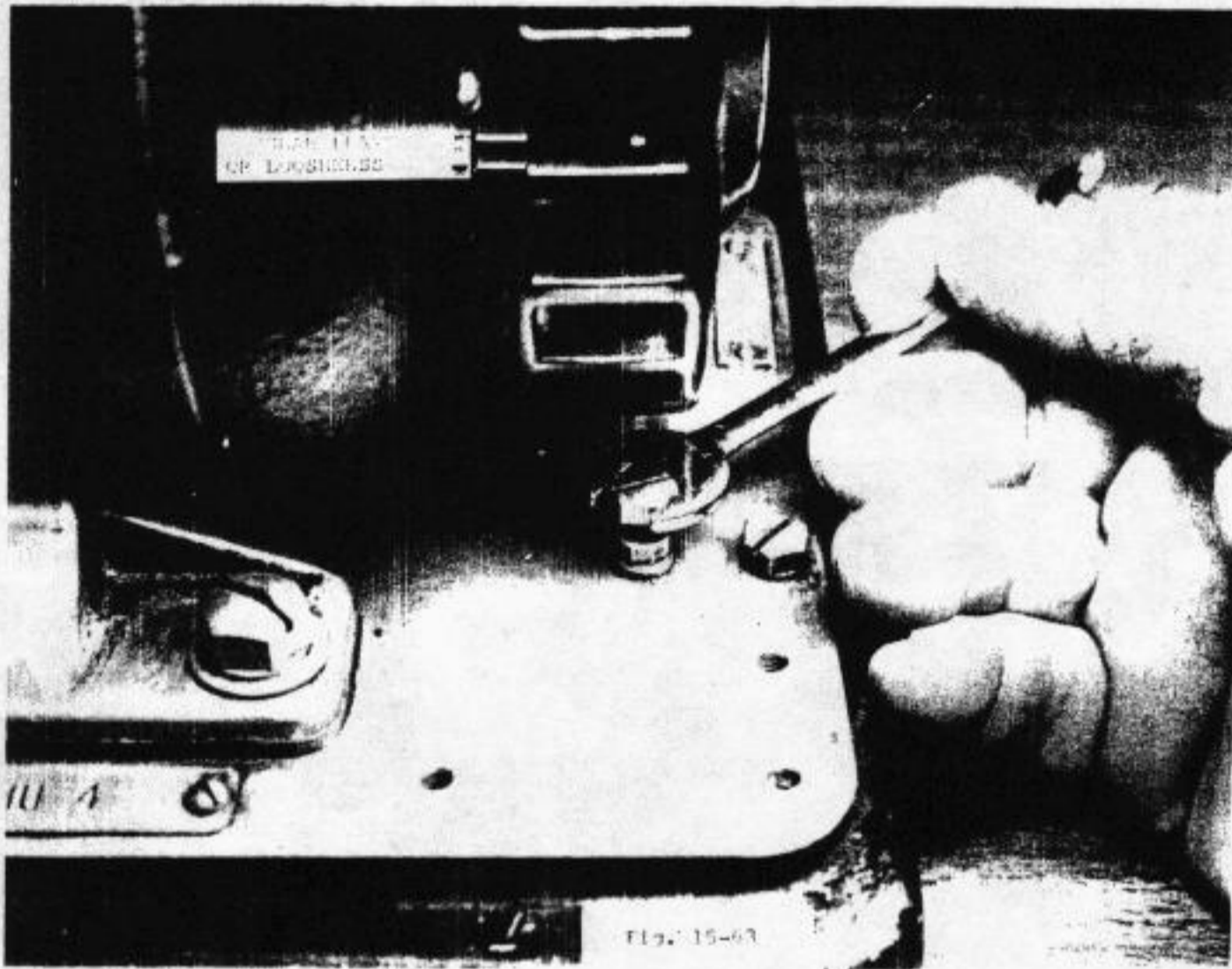

Fig. 15-62



M15-64

mainshaft. See that the notch on the shaft lines up through the clamp screw hole. Insert the clamp screw and tighten it securely. This completes the gear change.

Even though the gears have been changed, there should be little need for adjustment of "gear play" or looseness between the two gears. In general, there should be a slight play - not too tight - this can be checked for by turning the motor fan wheel by hand. About 1/8 inch movement on the circumference before the fiber gear moves will be the right amount of play.

If the new gears need adjustment, this is quite easily done by tilting the motor base forward or backward so as to open up or reduce the looseness between the gears. There are two push-pull screws at the rear of the motor base; one screw is loosened, the other screw (with its jam nut free) is turned clockwise to increase the looseness, or counter-clockwise to decrease the looseness (See Fig. 15-63). After the required 1/8-inch movement on the fan wheel is obtained, tighten the first screw and then set the jam nut firmly on the second screw. Recheck the looseness afterwards. Naturally, the side screws, holding the motor base to the M15 base, must be kept tight.

Oiling the motor bearings can be done using an oilcan. One or two drops only to each bearing; place the oilcan spout on the oil cup and put in one drop (Fig. 15-64). Do this to the other oil cup, accessible through the fan wheel circumference. BE SURE TO GREASE THE MOTOR PINION GEAR AND THE FIBER GEAR. Use auto front axle grease or Vaseline. Keep the motor base screws tight, also be sure the pinion set screw is tight, likewise the hub clamp screw.

J. BAUD RATE IN TELEGRAPH SYSTEMS

Teletypewriter systems have several "wpm" speeds, also customarily referred to as baud speeds. For the 5-level code system, there exist several speeds, as listed below:

60 wpm = 45.45 Baud	Bell System, many years	TTY M15
66 wpm = 50 Baud	Telex, international, WU	TTY M15
75 wpm = 56.8 Baud	Bell System, recent	TTY M15
100 wpm = 74.2 Baud	Bell System, newer	TTY M28, 32

Western Union has many Teletype units running at 50-Baud (66 wpm) speed; hence they are available and must be changed to 60 wpm by means of appropriate gears.

(SAVE THE 66 wpm GEARS FOR POSSIBLE INTERNATIONAL USE)

(Change gears on both TD and Printer Units)

On the M19 units, the transmitter distributor units have gears sized to match the required speed in use with such M19 sets. Using calipers, measure the diameter of the fiber gear on the vertical shaft of the TD in question. The dimension of such gear for each speed is given below:

	60 wpm = 45.45 Baud	Fiber Gear dia. 1-7/8 inch.	
	66 wpm = 50 Baud	Fiber Gear dia. 1-13/16 inch.	7.42
M14	75 wpm = 56.8 Baud	Fiber Gear dia. 1-3/4 inch.	UNIT
TD's			CODE
	100 wpm = 74.2 Baud	Fiber Gear dia. unknown	ONLY

There have been some special M15's designed to run 100 wpm. I have never seen such units.

Western Union also may have some 7-unit TD's, besides the 7.42 unit things described above. Fiber gear diameters are

altogether different. Be sure to note that the STOP segment is appreciably longer than the other segments on the TD faceplate. For the 7.42-unit code, the correct type number for the faceplate is 77070.

WPM and BAUD rates are "the same" for both 7-unit and 7.42-unit patterns. Gear ratios differ, however, so be sure that you have the correct pattern before ordering new gears for replacement purposes. This applies only to Transmitter Distributors.

KSR Printer units are completely compatible with 7-unit and 7.42-unit patterns, adhering to the WPM-BAUD rating. It is just that the 7-unit keyboard/TD is slightly faster (65-wpm) compared to the 7.42-unit keyboard/TD (61-wpm).

K. LEFT MARGIN ADJUSTMENT ON MODEL 15 TELETYPE

Sometimes, the left margin is uneven, as shown in Fig. 15-65. It is easy to correct this; there is a left margin screw on the left side of the typing unit. The screw is held in place by a jam nut. Loosen this jam nut first before turning the left margin screw; see Fig. 15-66. As much as two turns either way may be required to even up the left margin. In general, rotate the screw two turns clockwise (screwing in); this will clean up the margin, although it may permit an extra letter added to the total line = 73 characters instead of the normal 72-characters line. Or just unscrew the left margin screw two turns or as required to even up the left margin, and have a total of 72 characters to the line. Be sure to tighten the jam nut after the adjustment has been made.

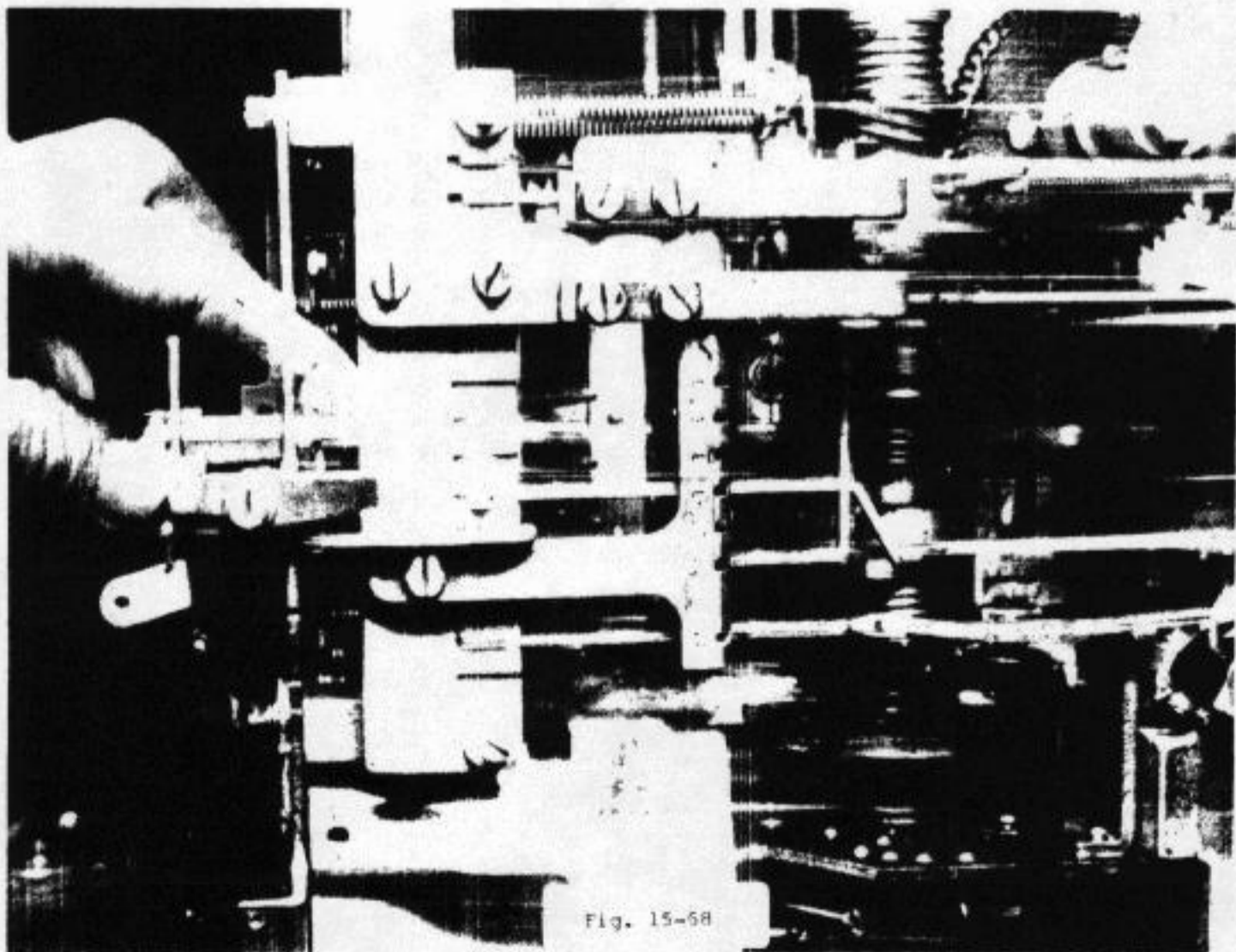
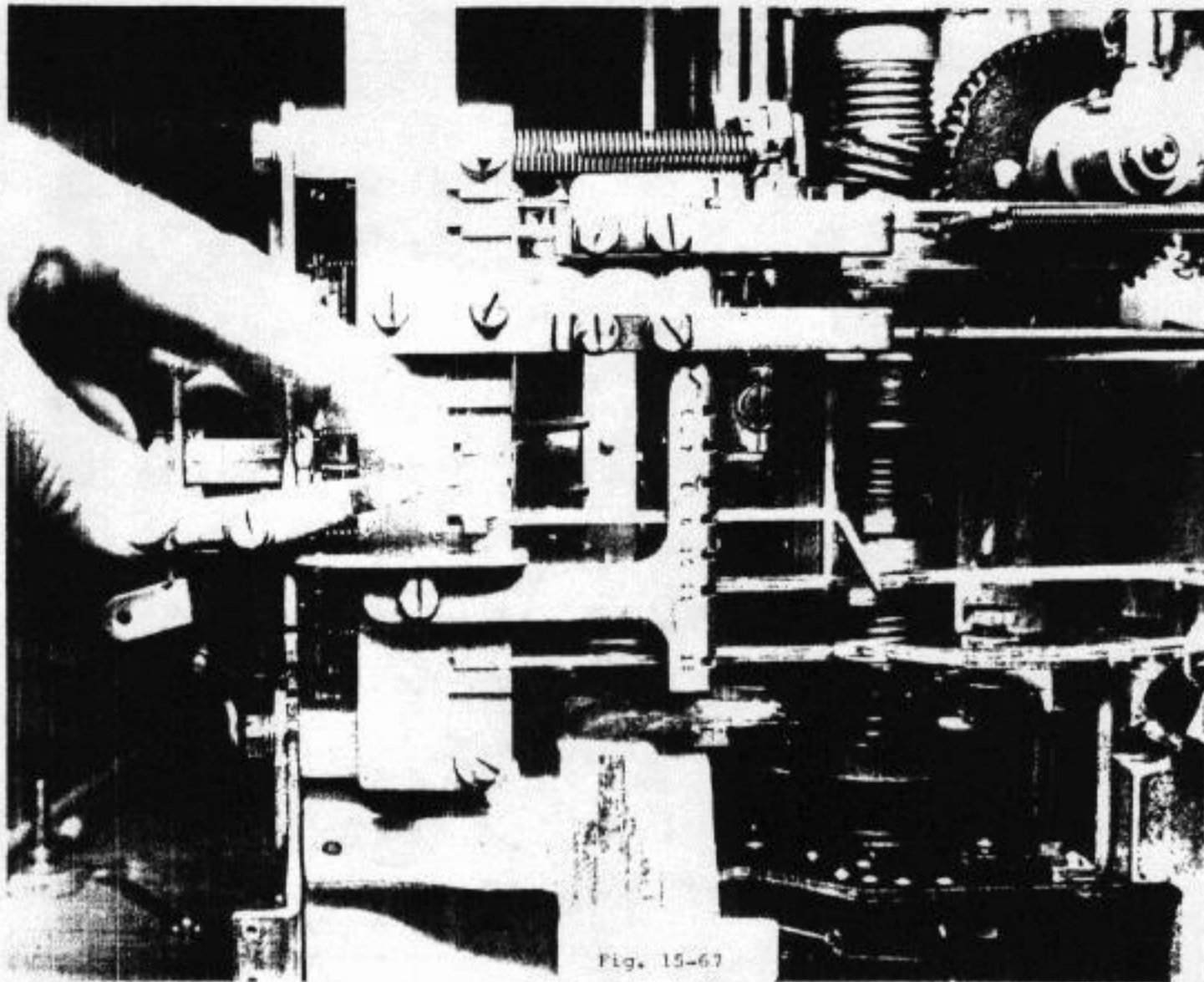

L. UNSHIFT-ON-SPACEBAR - MODEL 15 TELETYPE

Teletype machines can be arranged for unshift on spacebar operation. This means that typing in FIGS position will be unshifted down to LTRS on hitting the spacebar. This means that some operators depend on the spacebar to downshift their machines instead of using the LTRS key. This is inconvenient to TTY receivers not having this feature; that is, resulting printout at the other end is in numbers instead of words. This is an undesirable condition, leading to annoyance on the far end.

The machine can have its unshift on spacebar feature disabled. This is accomplished by moving a certain lever under the typing unit. In order to get at this lever, it is well to remove the typing unit in order to get at this lever. Fig. 15-67 shows the lever retracted, for unshift-on-spacebar feature. To take it out, merely push the lever into position to engage a pin, see Fig. 15-68. The lever has a screw which may require loosening and then tightening.

M. WESTERN UNION MODEL 15-19 TELETYPEWRITERS

Nowadays, increasing numbers of Teletype Model 15 and 19 sets are coming out of Western Union sources. Many of them are "handovers" from Bell System, when the latter sold its Teletype-writer Exchange (TWX) network to Western Union some two years ago. Hence, such TWX equipment will be found to be quite standard, albeit some operate at 75 wpm, and others operate at 60. Virtually all such TWX machines have holding-magnet selectors, wired for 60 mA operation.

However, there exist other Model 15-19 types, as used in Telex service. A number of such units have been released and they have been found to be appreciably different in some characteristics from the Bell System machines. For instance, Telex, an European innovation, operates at 66 wpm, and, as a result, the Western Union Telex machines are geared for such speeds. Even the Telex Model 19 table is quite differently wired, as compared to the TWX Model 19.

Further, the Telex machines use pulling-magnet selectors. There have been some 60 mA units; however there do exist certain units having "low resistance" selector magnets, requiring high current for operation. As an illustration, we can measure the DC resistance of a typical Bell System TWX pulling magnet selector; it is 200 ohms. For the Western Union Telex pulling magnet selector, it is 1.4 ohms! These coils are otherwise identical in dimensions; hence it is possible to swap coils to convert a Telex machine to 60 mA operation, if that should be necessary.

In the event that no suitable 60 mA replacement coils are available, we are faced with the problem of providing power to the 1.4 ohm coils in a given Western Union Model 15-19 machine. It has been determined that one must run at least 600-700 mA to operate those coils! The usual terminal unit loop does not provide such current; hence a "Selector Magnet Driver" circuit is needed. Essentially, what is required is a magnet-line current amplifier.

While the magnet current is high, it is a fortunate fact that the driving voltage can be low. Hence we can design a very simple selector-magnet driver circuit, using commonly available parts. All that is needed is a 12-volt, 1-ampere centertapped transformer, a pair of silicon diodes, a 2000-mF, 12 volt capacitor, and a RCA-40022 germanium power transistor. Further we shall require a 10-ohm, 12-watt resistor, for series current limitation. Figure 15-69 shows the circuit diagram of the entire selector magnet driver.

Delivering 600 mA on Mark, the power supply provides 7 volts. The 10-ohm series current-limiting resistor appears to be about right, working into the 1.4-ohm selector coils, so there results a full 80-point range (from 20 to 100) on the teletypewriter.

As a matter of fact, a 6-volt centertapped transformer was tried, resulting in 4 volts DC. This voltage was found too low, as it raised the low end of the range, resulting in a span of only about 60 or 65 points, instead of the desirable 80 points. This is a consequence of the damping effect of a too-low series resistance value on the teleprinter magnet coils.

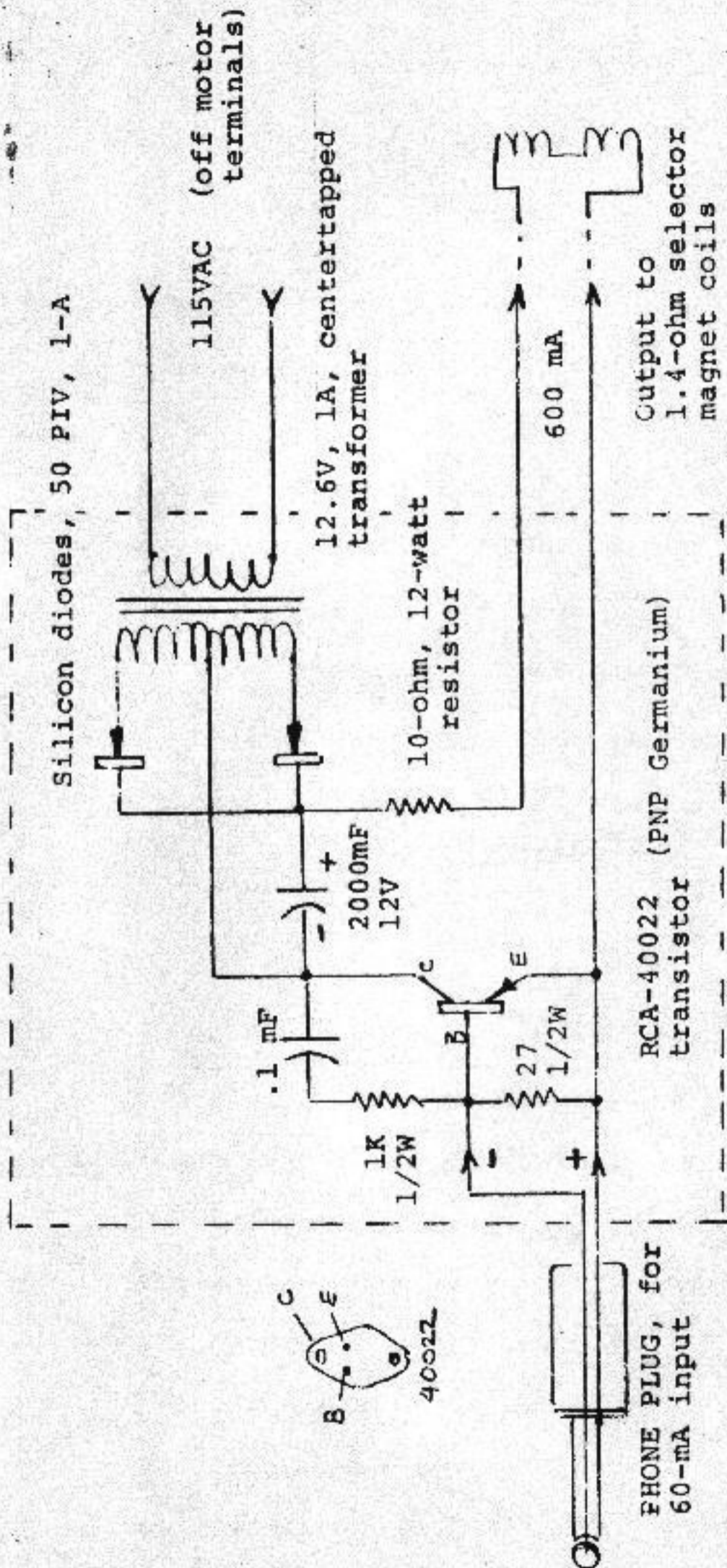

NOTES: Phone plug input is polarized negative on tip with respect to ring positive. Since the circuit is left floating, polarity can be reversed if necessary.

Or, wire the input wires to the usual points (45 and 46) on the 15-19 base strip. Observe input polarity.

Mount these parts on a suitable board which can then be fastened on the rear surface of the Model 15-19 base. Power is obtained from off the motor terminals, under the base. Wire the magnet line wires direct to the selector magnet coils, to minimize lead resistance.

The transistor need not be heatsinked. Can design a printed circuit to hold all parts, or else mount on a piece of wood, using tie points as needed.

Fig. 15-69

SELECTOR MAGNET DRIVER FOR W-U 1.4-ohm SELECTORS

The 1K resistor and .1 mF capacitor form a spike limiting network, in order to protect the transistor insofar as inductive surges are concerned.

As far as the Telex machine is concerned, its gears will have to be changed in order to adapt it to 60-wpm operation. Use 74912 and 74913 gears, obtainable from Teletype Corp., or from any one of the numerous amateur RTTY sources.

PARTS LIST

1-	Transformer, 12.6 VAC, 1 AMP (CALRAD)	\$2.79
2-	Diodes, 100 PIV, 1 AMP (SARKES or IR)	1.10
1-	2000 mF, 12V Capacitor (SPRAGUE, etc)	2.10
1-	Transistor, Type 40022 (RCA)	.75
1-	10-ohm, 12-watt Resistor (OHMITE)	.74
1-	1,000-ohm, 1/2 watt resistor	.10
1-	27-ohm, 1/2-watt resistor	.10
1-	.1 mF, 100-V capacitor	.20

Prices given are approximate only; judicious shopping should result in much lower costs. All parts are common type; for instance the transistor could be any germanium power type, rated at about 10 watts, as used in automobile radios. Look at the blister packs as found in Radio Shack or similar electronic emporium.

N. MISCELLANY - MODEL 15

This section will serve to round up some odds and ends lying around the M15 story. For instance, lubricants should be applied to various other unmarked parts on the machine; this will be left to the judgement of the serviceman. Apply a thin film of grease to the vanes, for instance; also a thin film to the rear track supporting the carriage. Also, some grease inside the two blades of the printing bail (Fig. 15-32).

Adjusting the Typing Impressions on Paper...

Fig. 15-70 shows how one may vary the typing impression on paper, from light to heavy. On the right side of the typing unit, there is a screw, held by a lock nut. The latter nut is loosened first, then the screw is turned clockwise to get a heavier impression, counter-clockwise to get a lighter impression. In general, though, the impressions should not be too heavy, in interest of keeping platen rubber life as long as possible, not to mention wear on the typing pallets. You will very likely need a new ribbon or a re-inked ribbon if your printing becomes faint.

New Window Glass for M15 Teletype Cover...

In the event that the window glass is cracked, a new piece can be obtained from various places handling Teletype parts. Or, a new piece can be ordered made at a local glass shop. Be sure to take the old window to the shop for an exact measurement. Specify SAFETY glass (laminated), 1/8-inch thick. Line the left and right

edges with black plastic tape, then trim it off with a razor blade after installation has been made.

Painting and Preparing the M15 Cover and Table...

You can paint the cover any color you like. A restful color is beige - a sort of light tan. Use enamel paint, obtainable anywhere. Be sure to wash the surfaces with naphtha and wipe well, before applying paint. A rubber kneeling pad can serve to cushion the underside of the M15 base, to make the installation less noisy to nearby hearing people.

A Special Note on Gears...

When remounting the typing unit on the base of the M15, be sure to turn the motor fan wheel by hand back and forth just a tiny bit to make sure that the gears mesh. This includes not only the motor pinion and fiber gear but also the two other gears working into the keyboard. This will prevent damage to gears as the typing unit is being fastened down with the thumb screws.

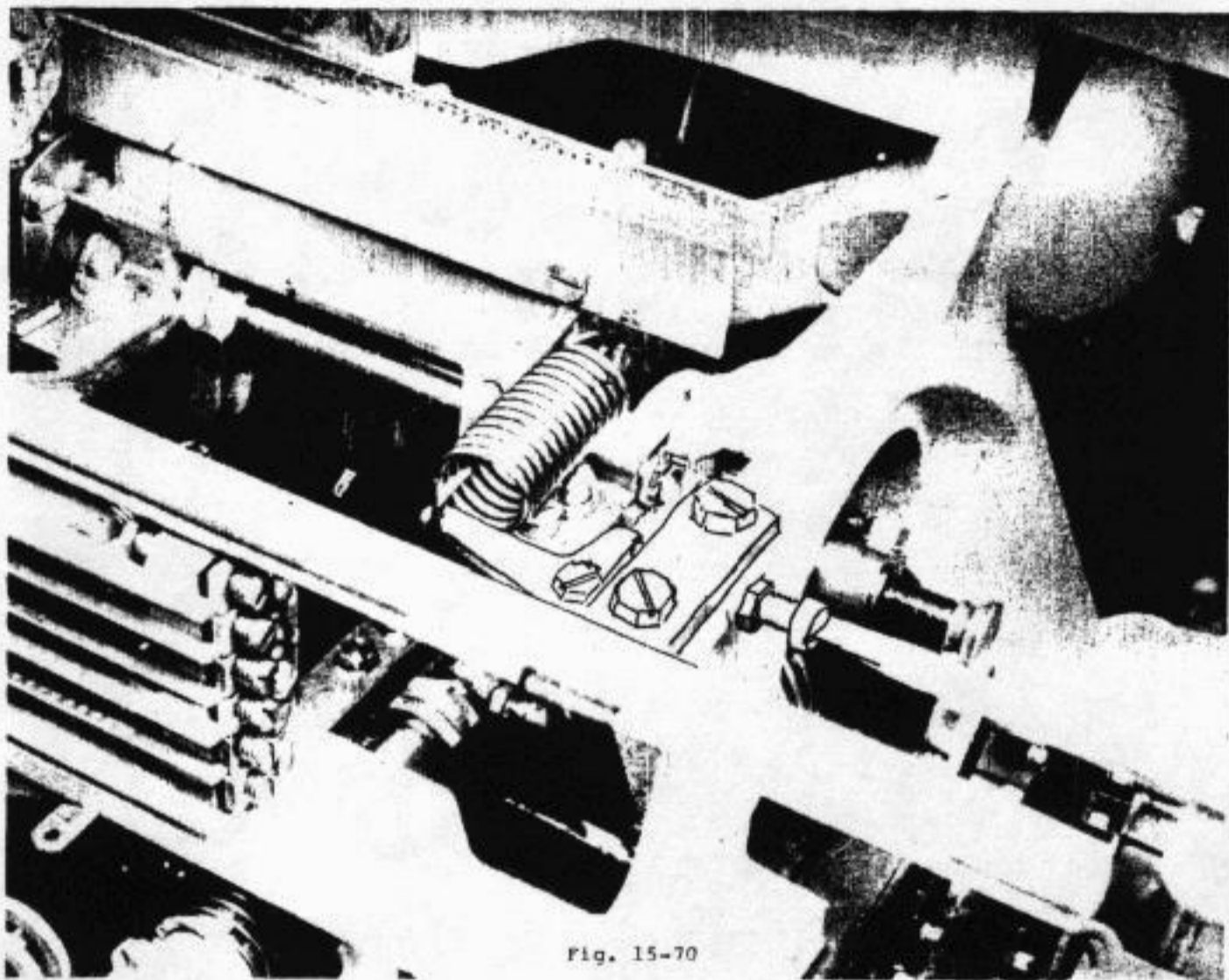

Fig. 15-70

THE MODEL 28 TELETYPE ^R

Registered trademark of the Teletype Corporation

CONTENTS

	Page
A. Preparation for Connection to an Acoustical Coupler	M28-3
B. Wiring Diagrams	M28-7
C. Typing Unit Preparation	M28-11
D. Most Frequently Ordered Parts	M28-16
E. Some Common Troubles	M28-19
F. Keyboard Contact Adjustment	M28-23
G. Front Plate Disassembly	M28-25
H. Stunt (Function) Box Removal	M28-29
I. Platen Removal	M28-31
J. Main Shaft Disassembly	M28-33
K. Descriptions of Various Clutches	M28-35
L. Common Adjustments	M28-36

Fig. 28-1

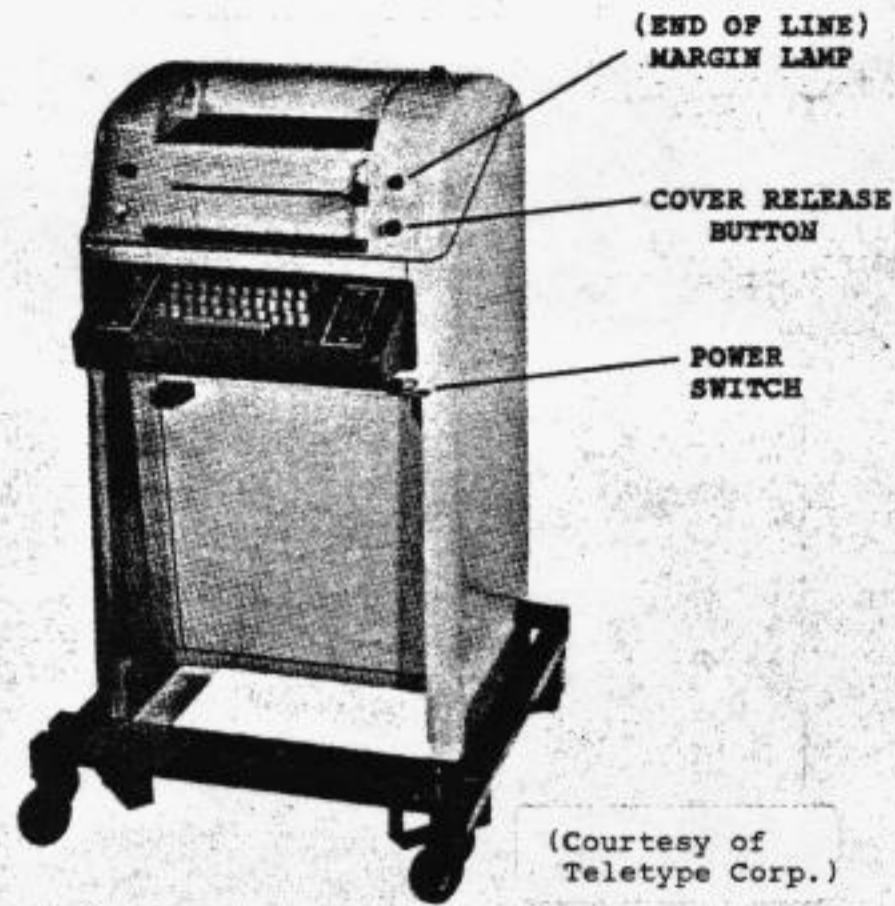

KEYBOARD SEND-RECEIVE (KSR) SET
(On Dolly)

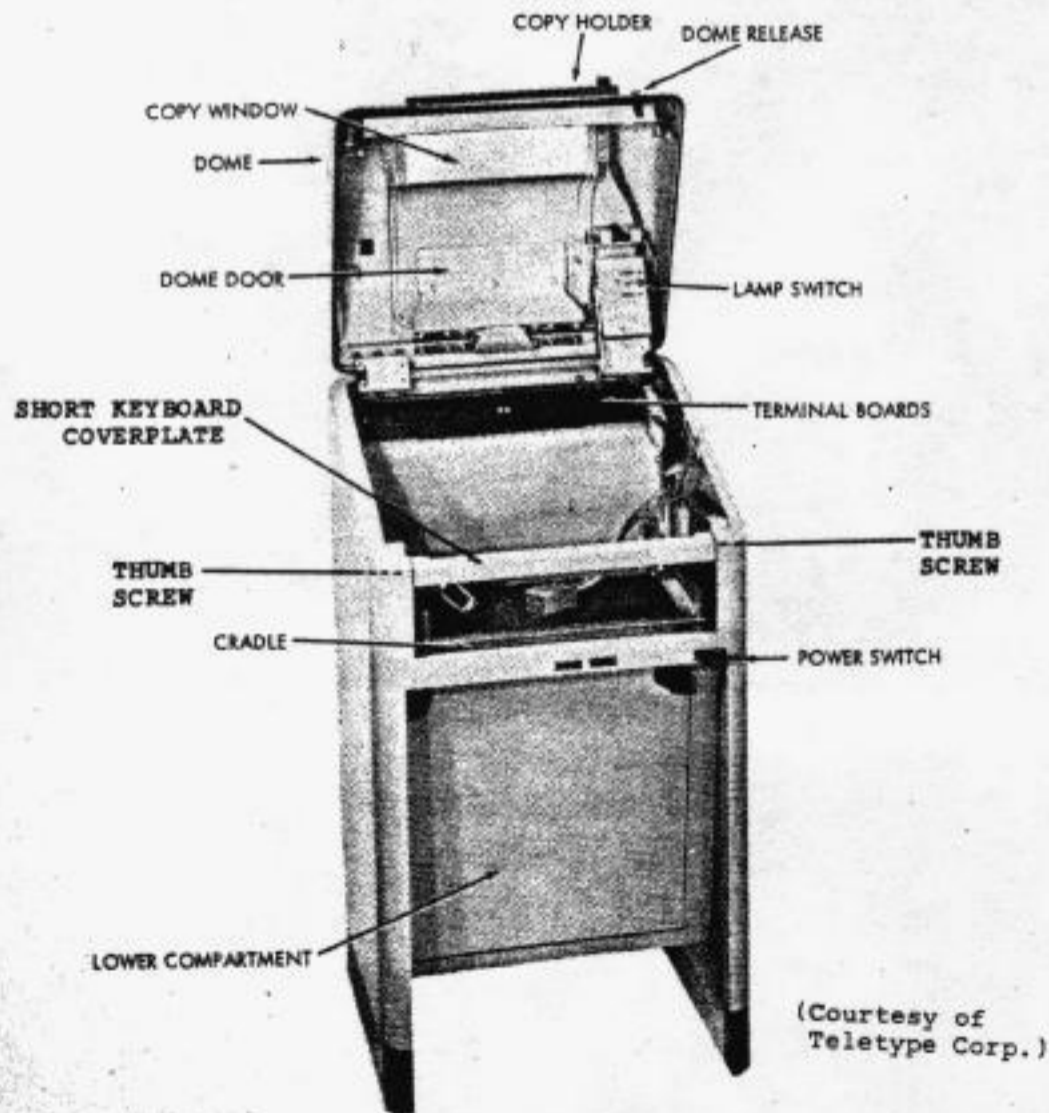

Fig. 28-2

Cabinet LAC214BR (Dome Open)

MODEL 28

A. PREPARATION FOR CONNECTION TO AN ACOUSTICAL COUPLER

1. Make sure power cord is unplugged.
2. Raise cover by pushing in button located on right hand side of cover (Fig. 28-1).
3. Unscrew two thumb screws behind short keyboard cover plate and remove the plate (Fig. 28-2).
4. Remove the keyboard and typing unit as a complete unit, as follows:
 - a) Remove the four screws that hold the keyboard to the cabinet (Fig. 28-3).
 - b) Remove the keyboard plug and the typing unit (female) plug (Fig. 28-4,5).
 - c) Lift the keyboard and typing unit upward from the cabinet. (some oil may drip out!)
5.
 - a) Notice the Electrical Service Assembly (ESA) in the rear of the cabinet (Fig. 28-4).
 - b) Disengage the metal power switch rod from the ESA by pulling the rod out of the hole (Fig. 28-2).
6.
 - a) Remove the two post screws which fasten the ESA to the cabinet base (Fig. 28-4).
 - b) Remove the four assemblies indicated (Fig. 28-6).
 - c) Lift out the ESA and turn it upside down for rewiring.

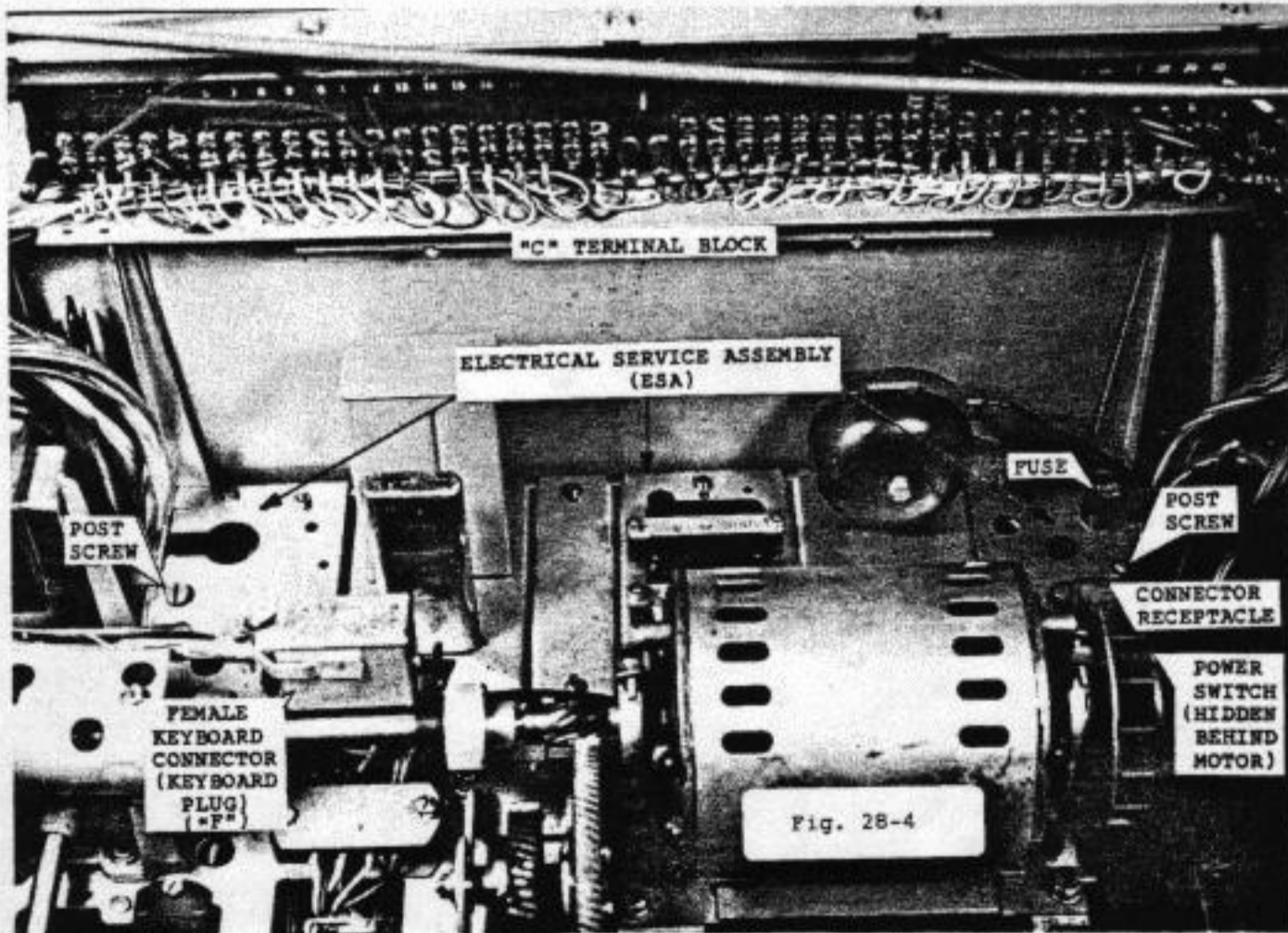
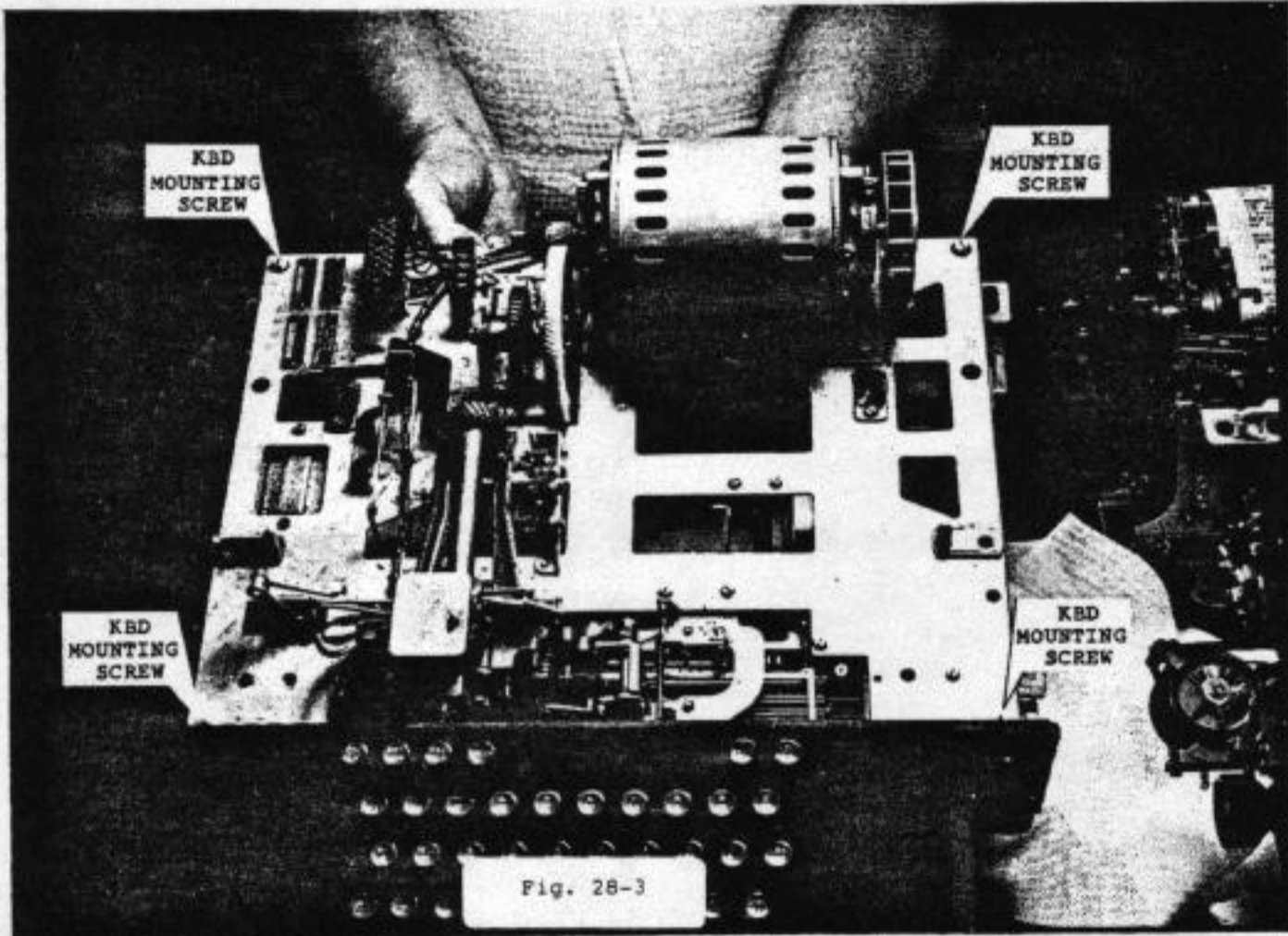

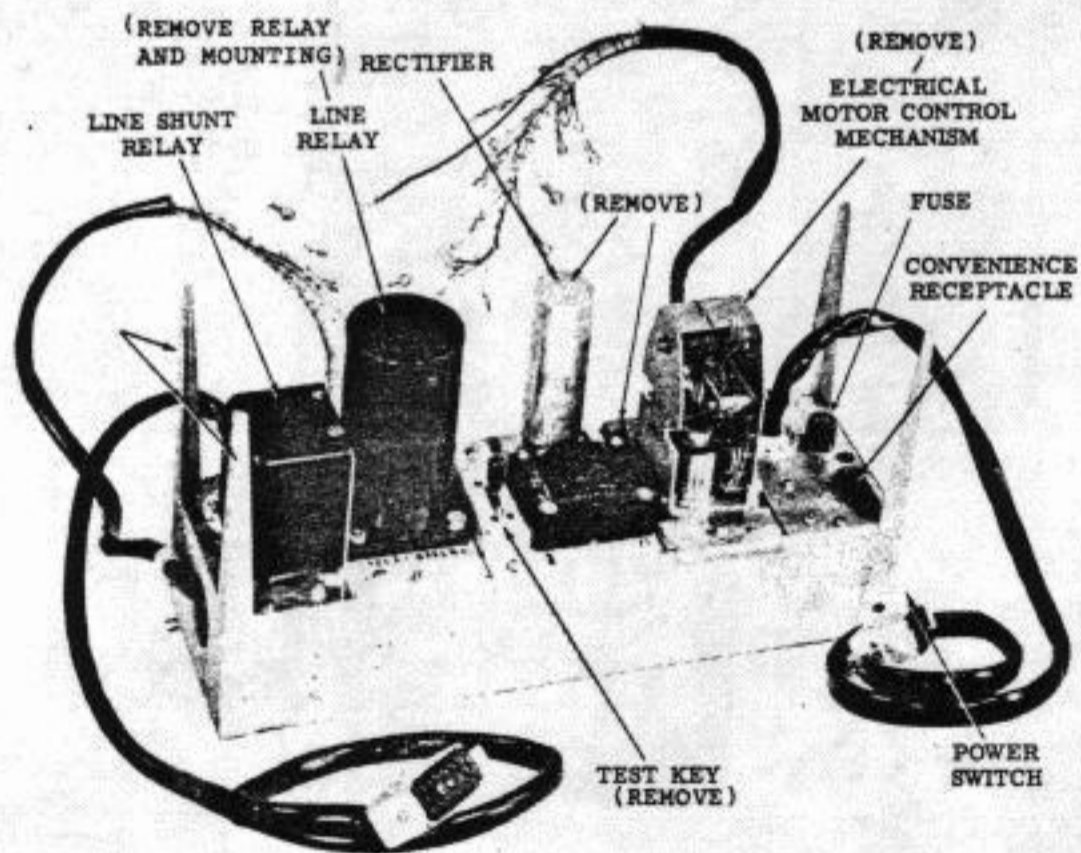
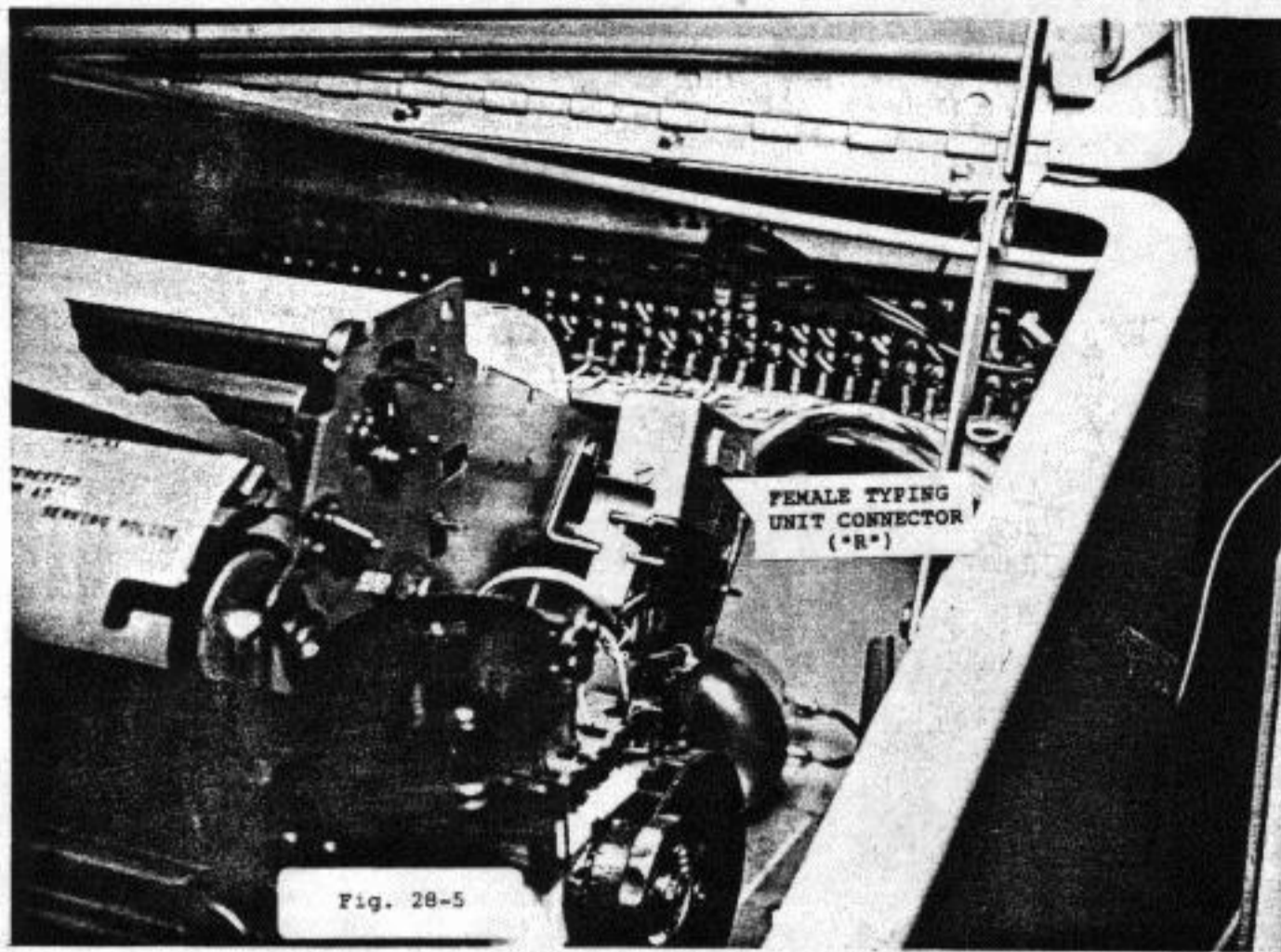
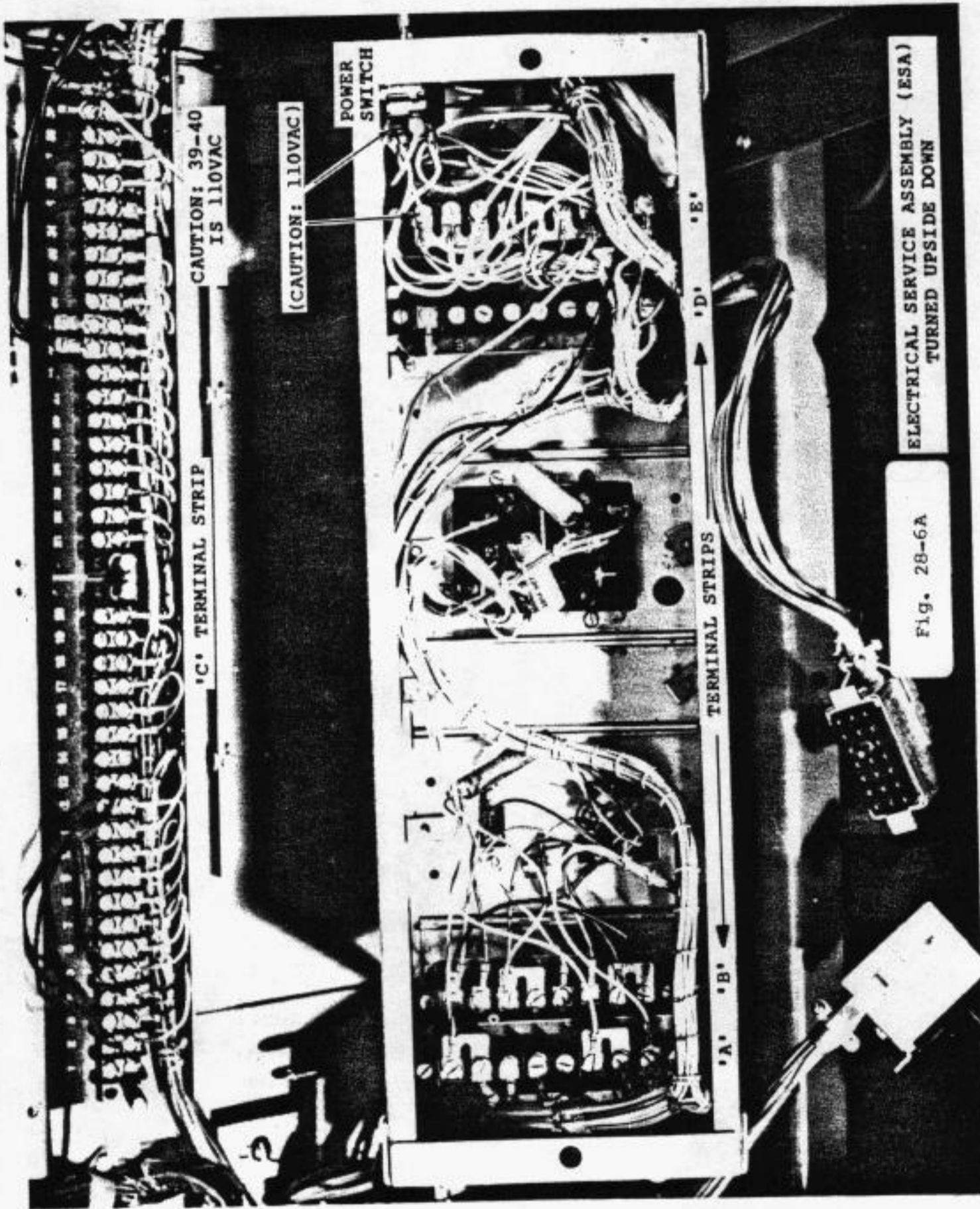

Fig. 28-6

(Courtesy of Teletype Corp.)

Typical 28 Electrical Service Unit



B. WIRING DIAGRAMS

The following six pages illustrate the wiring diagrams which were redrawn for simplicity. Reference to photographs for easy location is made whenever possible.

1. Model 28 Signal Circuit (Before adaption to acoustical coupler)
2. Model 28 Signal Circuit (After adaption to acoustical coupler)
3. Model 28 Motor Circuit
4. Model 28 Selector Magnet Circuit
5. Model 28 Keyboard Circuit
6. Model 28 Margin Indicator

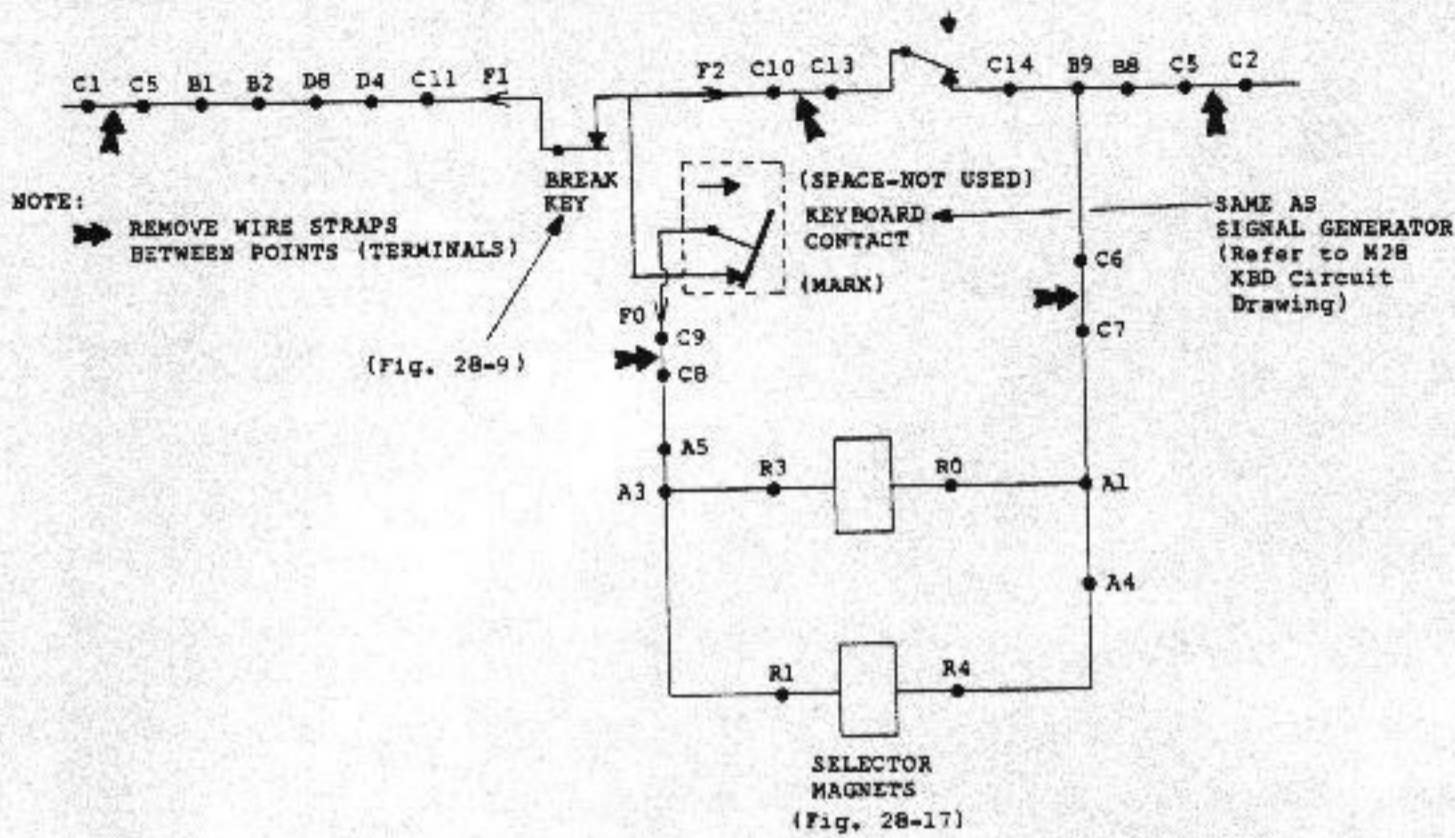

1. Model 28 Signal Circuit (Before Adaption to Acoustical Coupler)

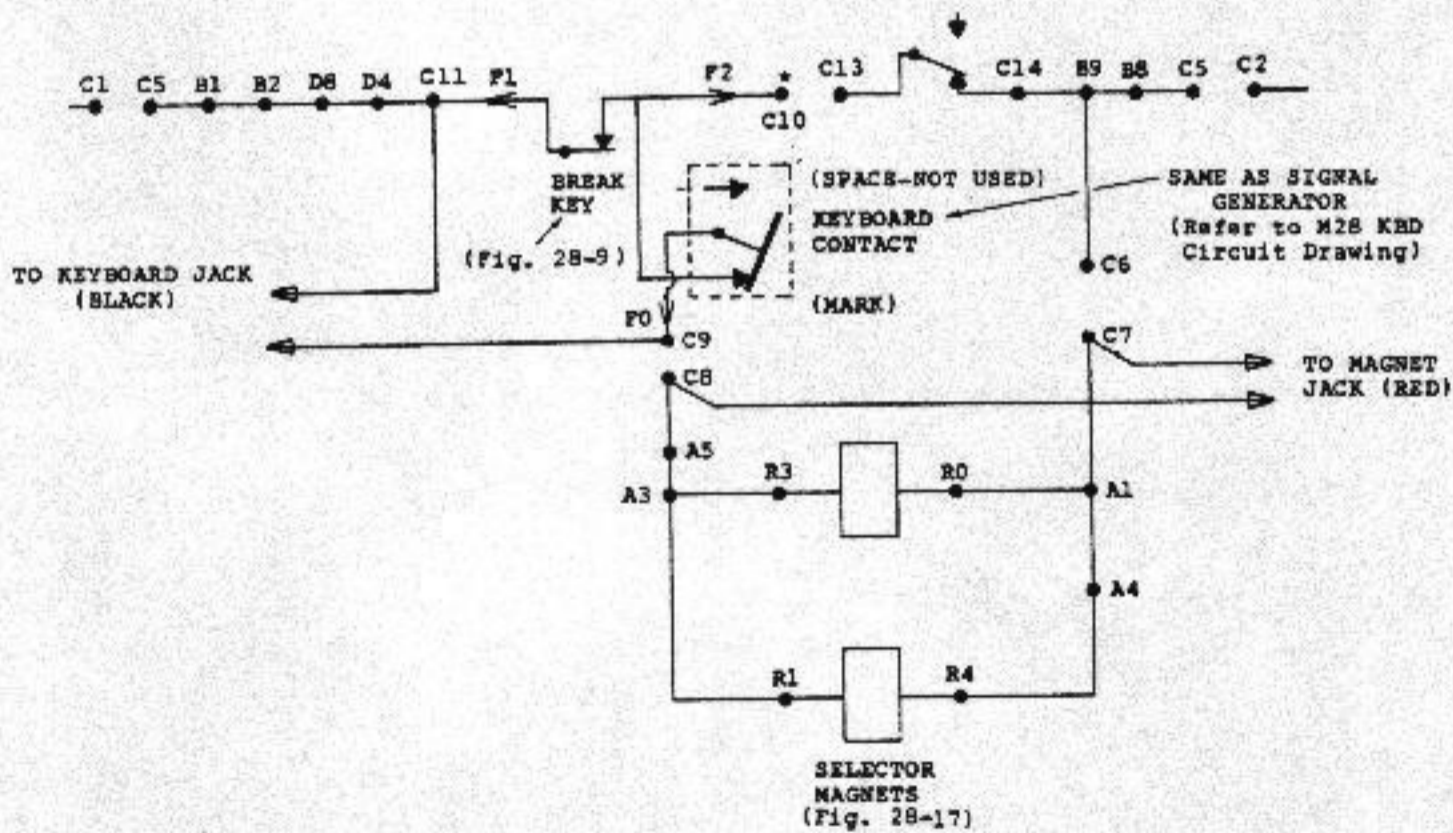

*NOTE: Should the TTY lack the break key, it will be necessary to connect to C10 rather than C11.

2. Model 28 Signal Circuit (After Adaption to Acoustical Coupler)

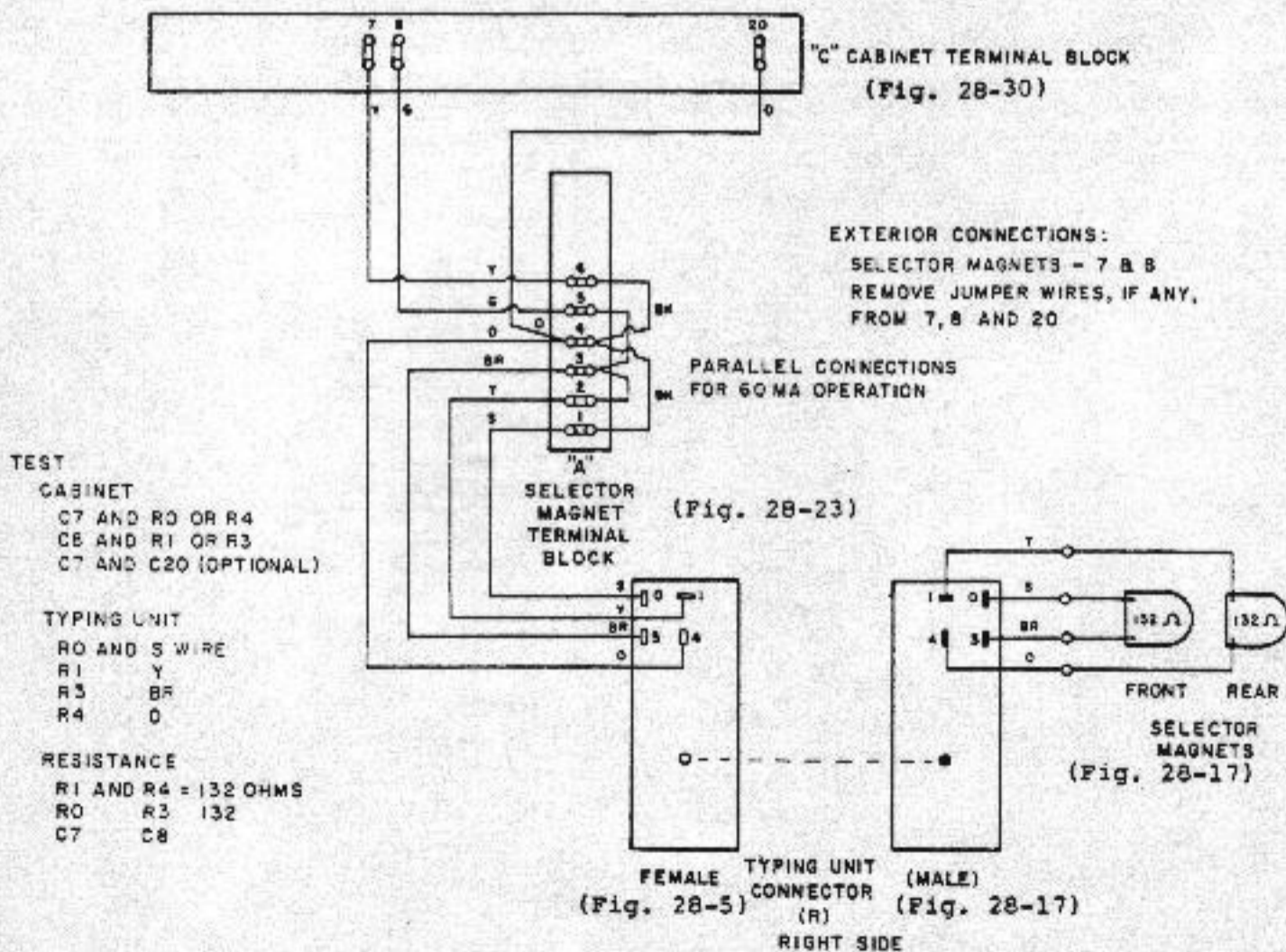
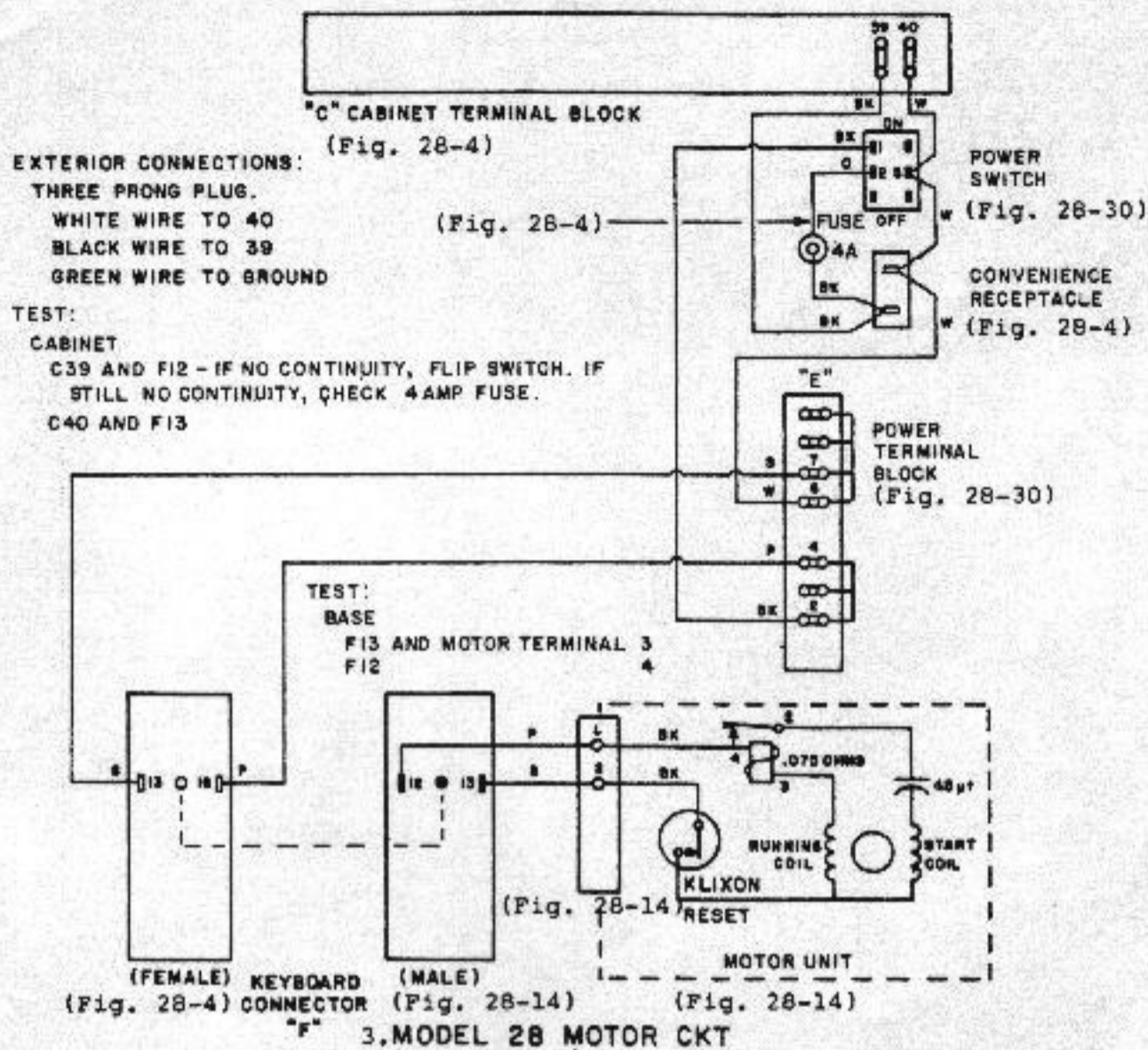

4. MODEL 28 SELECTOR MAGNET CKT

EXTERIOR CONNECTORS:

KBD WITHOUT BREAK KEY - 9 B 10
 KBD WITH BREAK KEY - 9 B 11
 REMOVE JUMPER WIRES, IF ANY,
 FROM THESE POINTS.

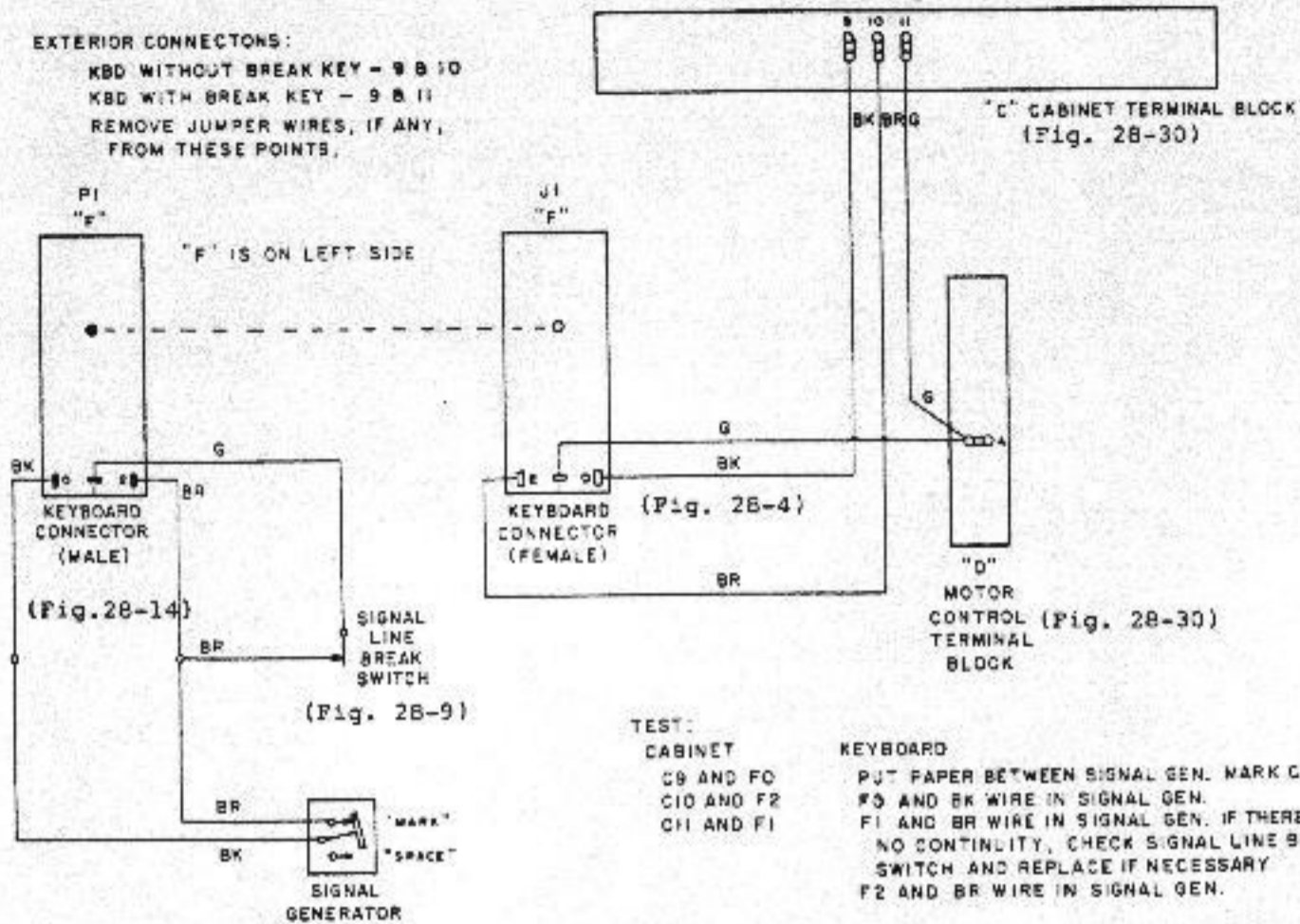

OLD STYLE: Fig. 28-9
 NEW STYLE: Fig. 28-19

5. MODEL 28 KEYBOARD CKT

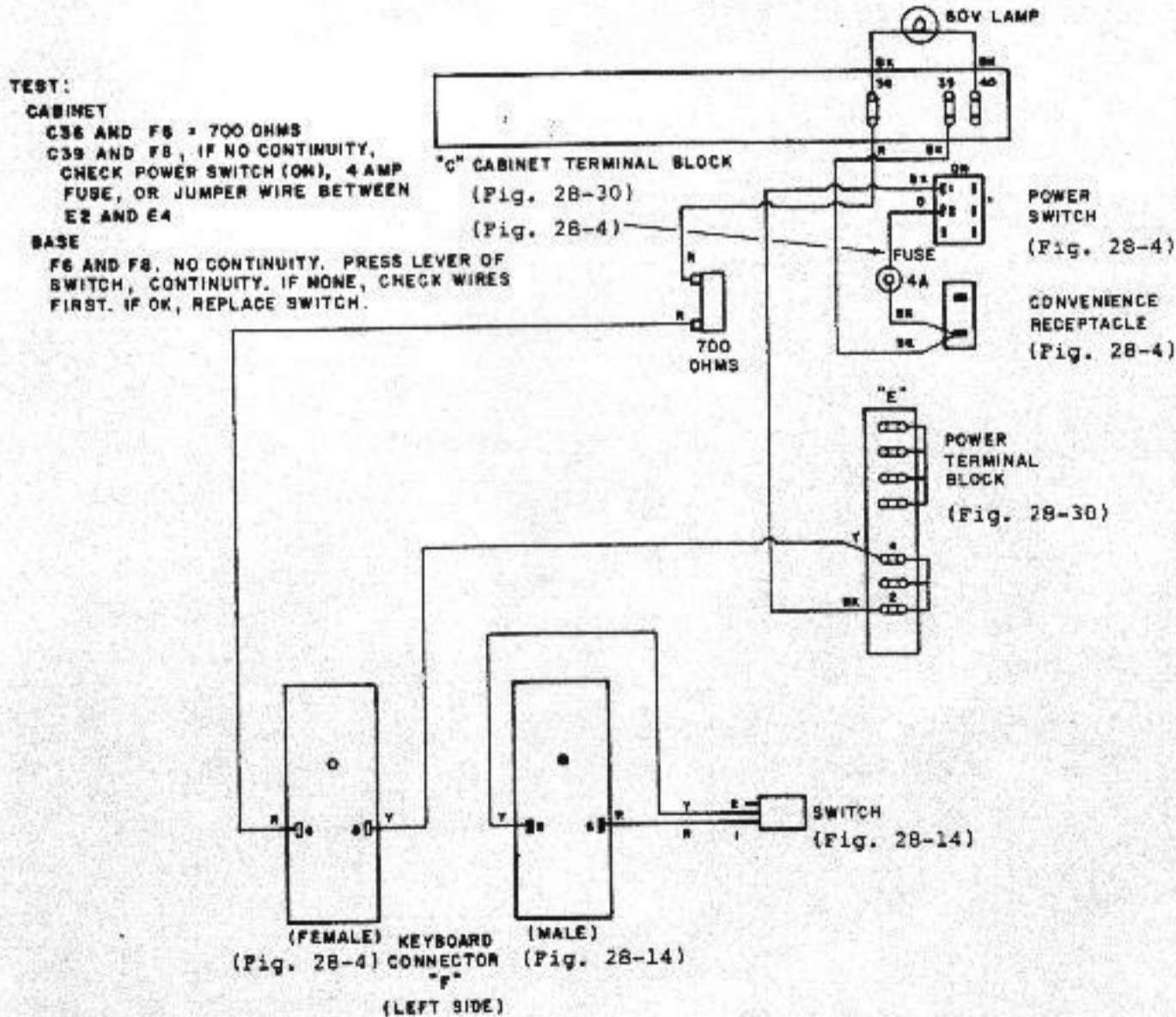

6. MODEL 28 MARGIN INDICATOR

MODEL 28

C. TYPING UNIT PREPARATION

1. To remove "unshift on space" feature, loosen locknut located at left hand side of stuntbox as viewed from the rear (Fig. 28-7). Turn screw downward towards bottom of the unit. Tighten locknut afterwards. This will enable unshift to occur only when the LTRS key is hit.
2. Check to see if the unit is equipped with:
 - a) A spacing drum with horizontal tabs (Fig. 28-8).
 - b) A spacing drum without horizontal tabs (Fig. 28-9).
 - c) Vertical tab and form out (wheel on left typing unit frame that looks like drum in Fig. 28-8).
3. Block the Function Pawls for any of the above parts in the Stunt Box as in Fig. 28-10, using wire clips as in Fig. 28-11, which can be made out of paper clips if necessary.

Note: Slots for blocking are numbered from left to right as viewed from the rear of the Typing Unit, with every 5th location stamped on the casting as in Fig. 28-12. The slots that will have to be blocked are 17, 35, 41, and 42. (Slot 35 disables the keyboard lock.)
4. If the unit is equipped with Selective Calling, clip the suppression code bar as in Fig. 28-13.

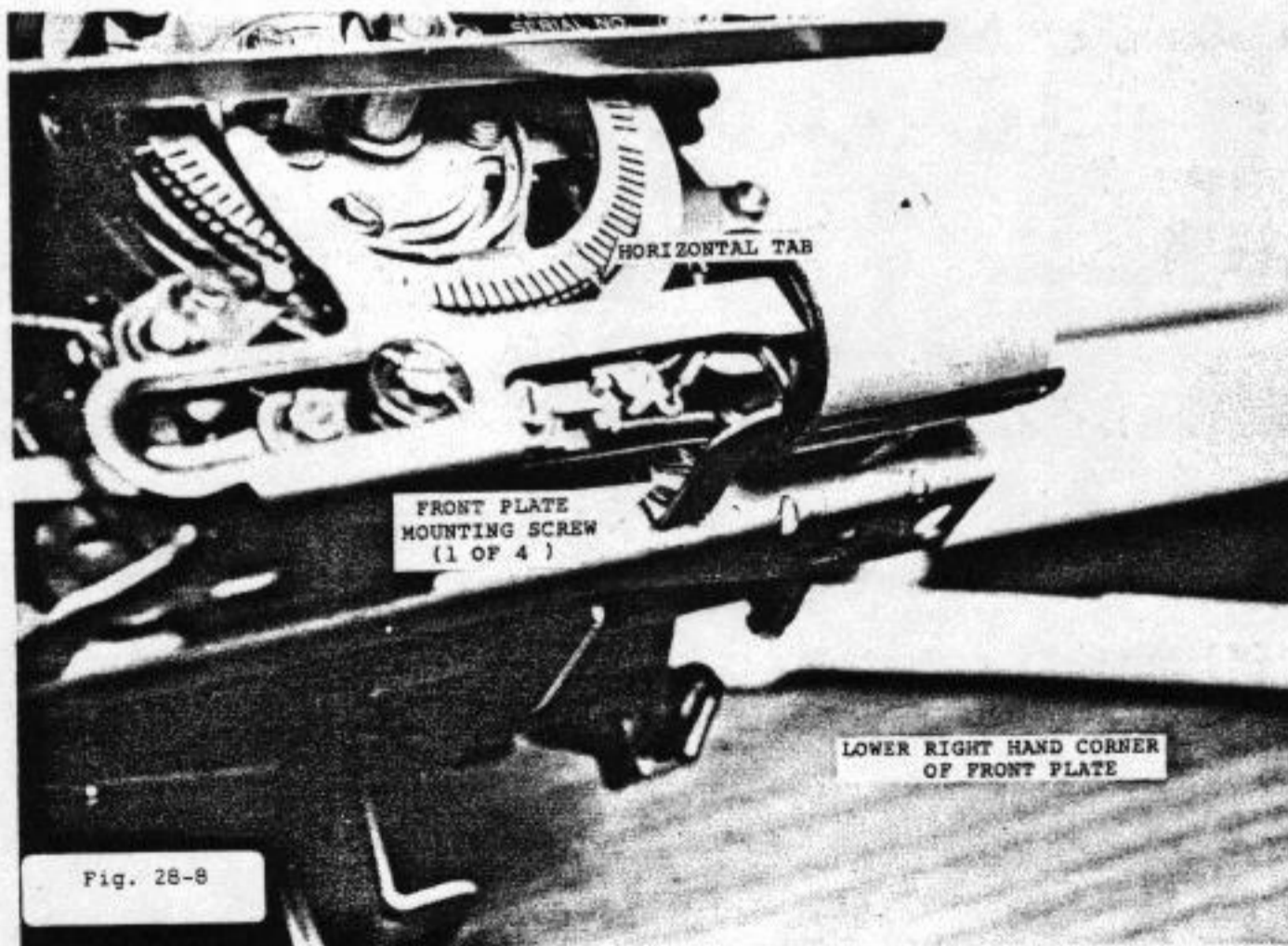
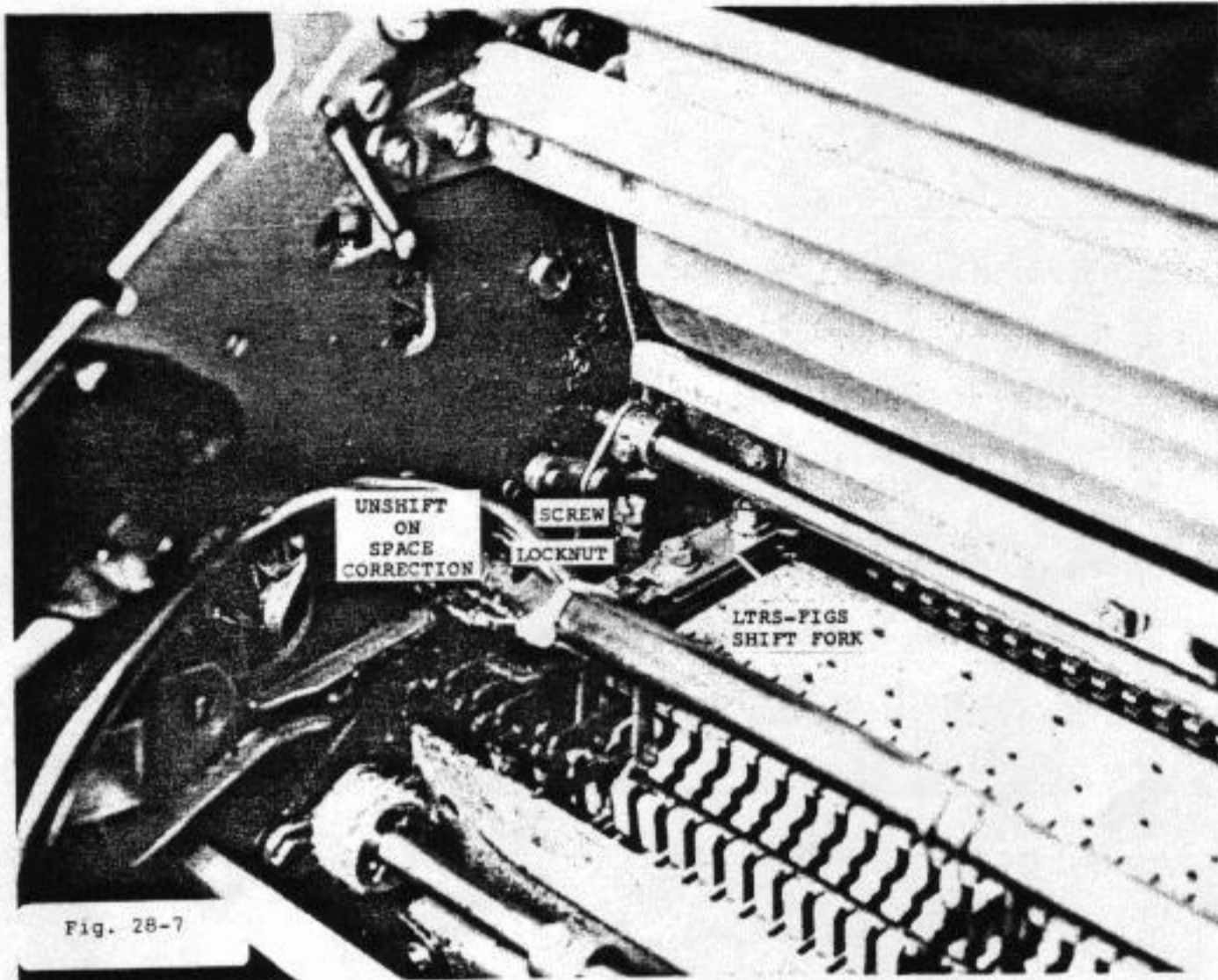

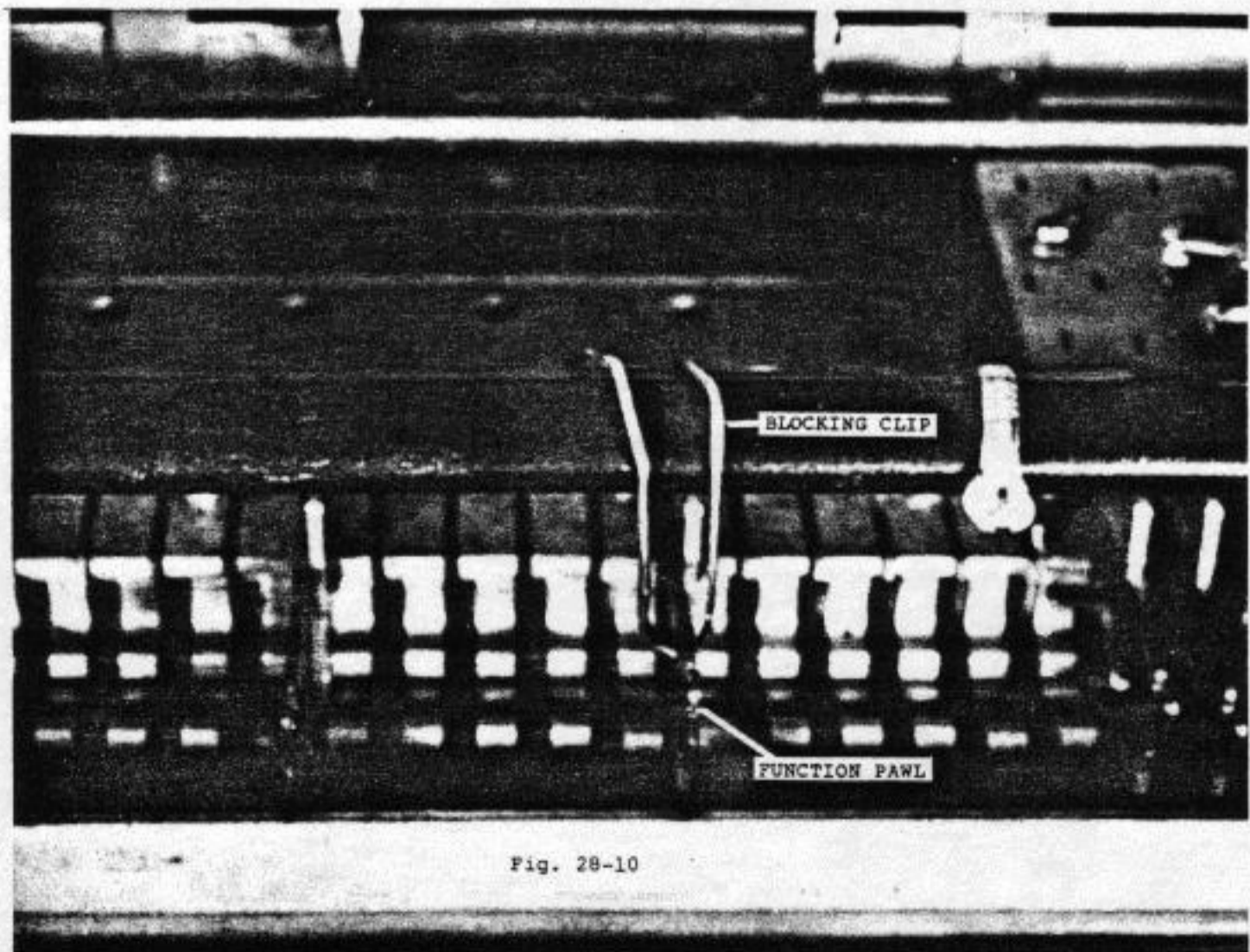
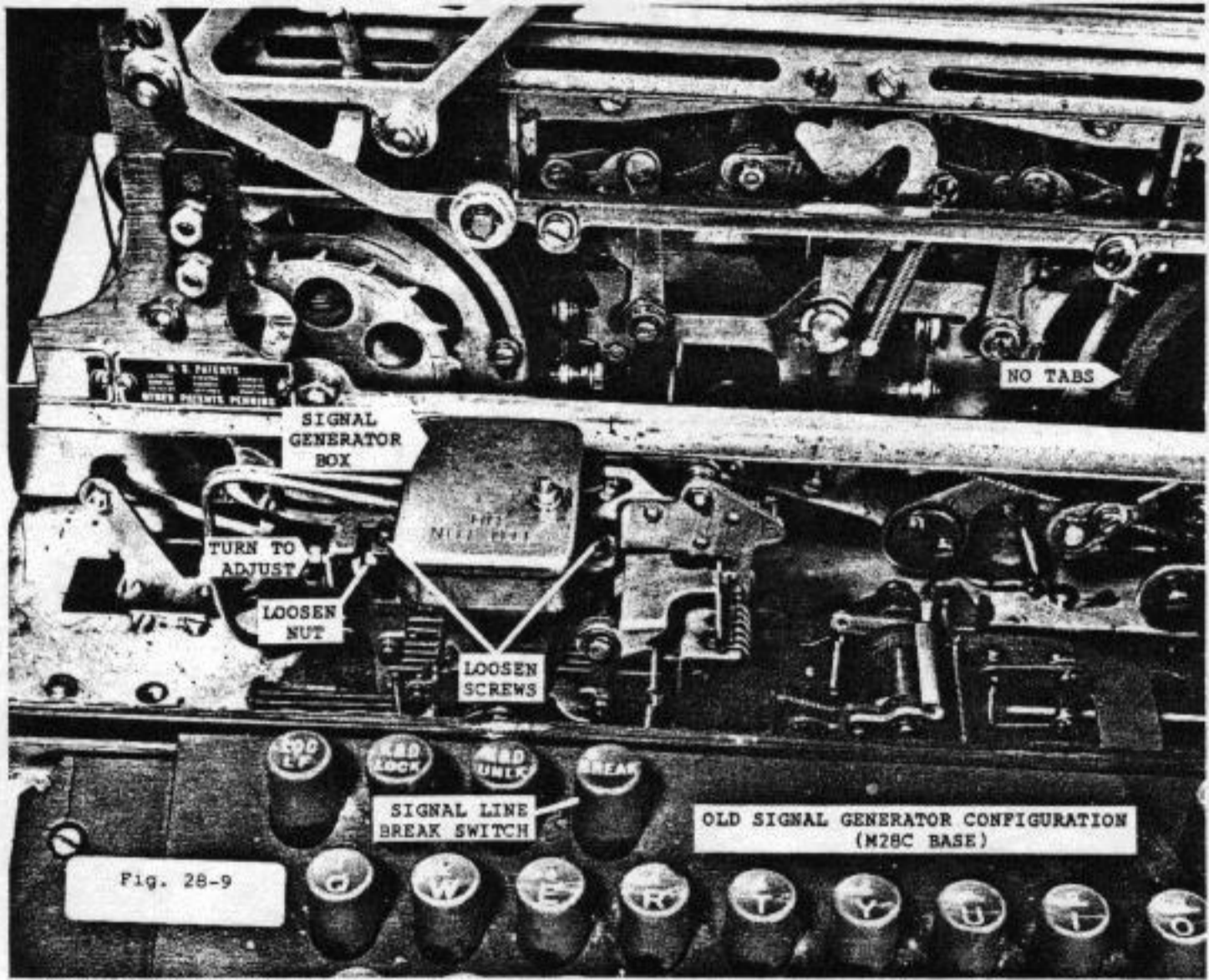



Fig. 28-11

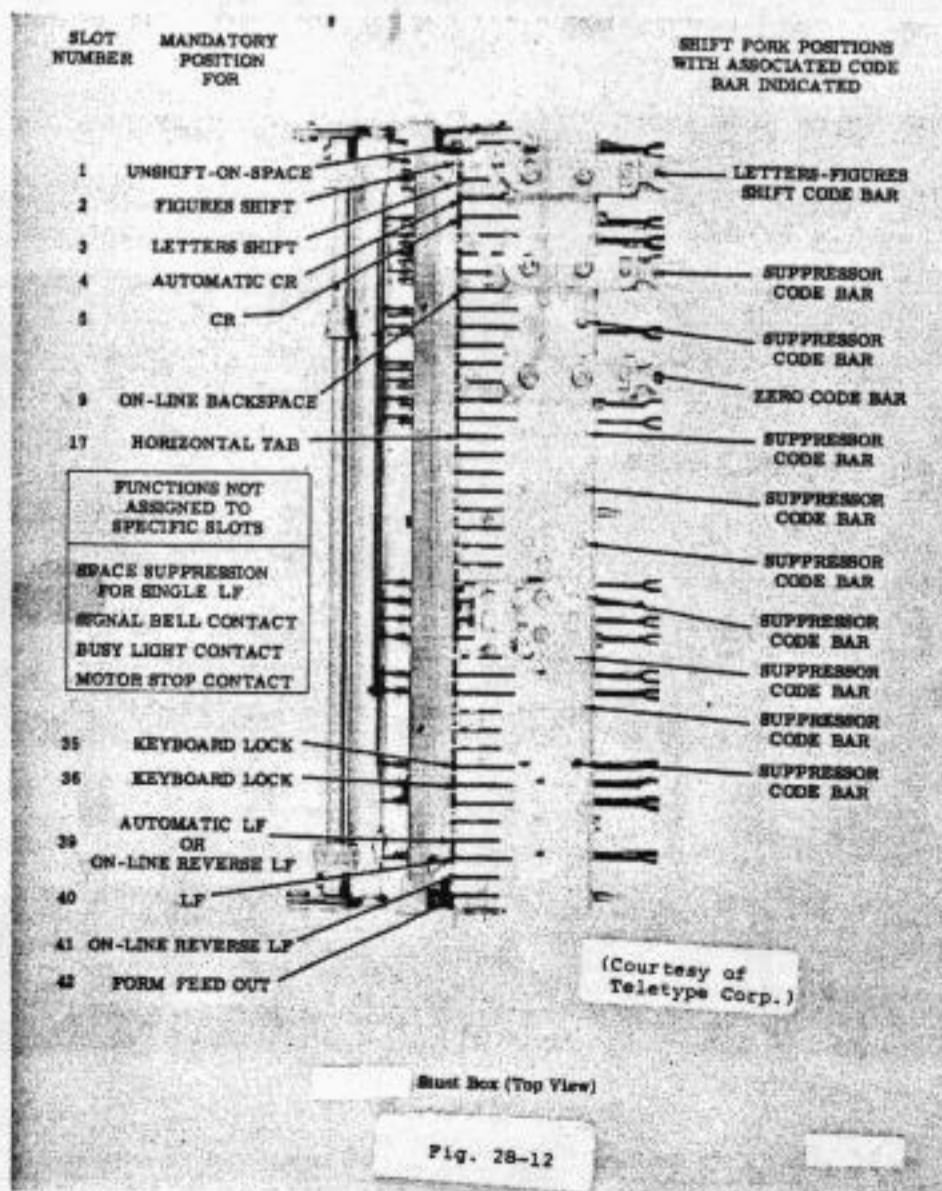

Fig. 28-12

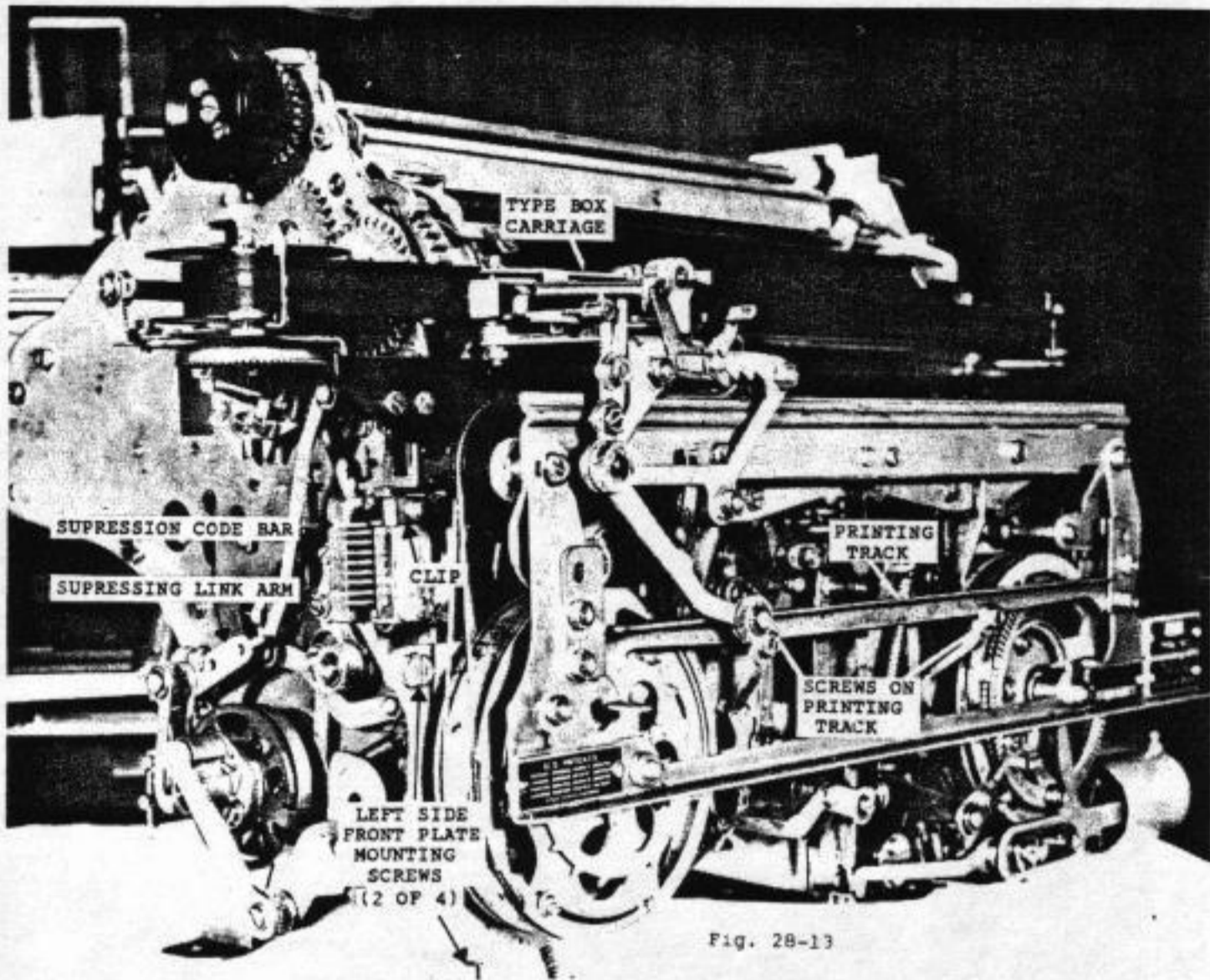
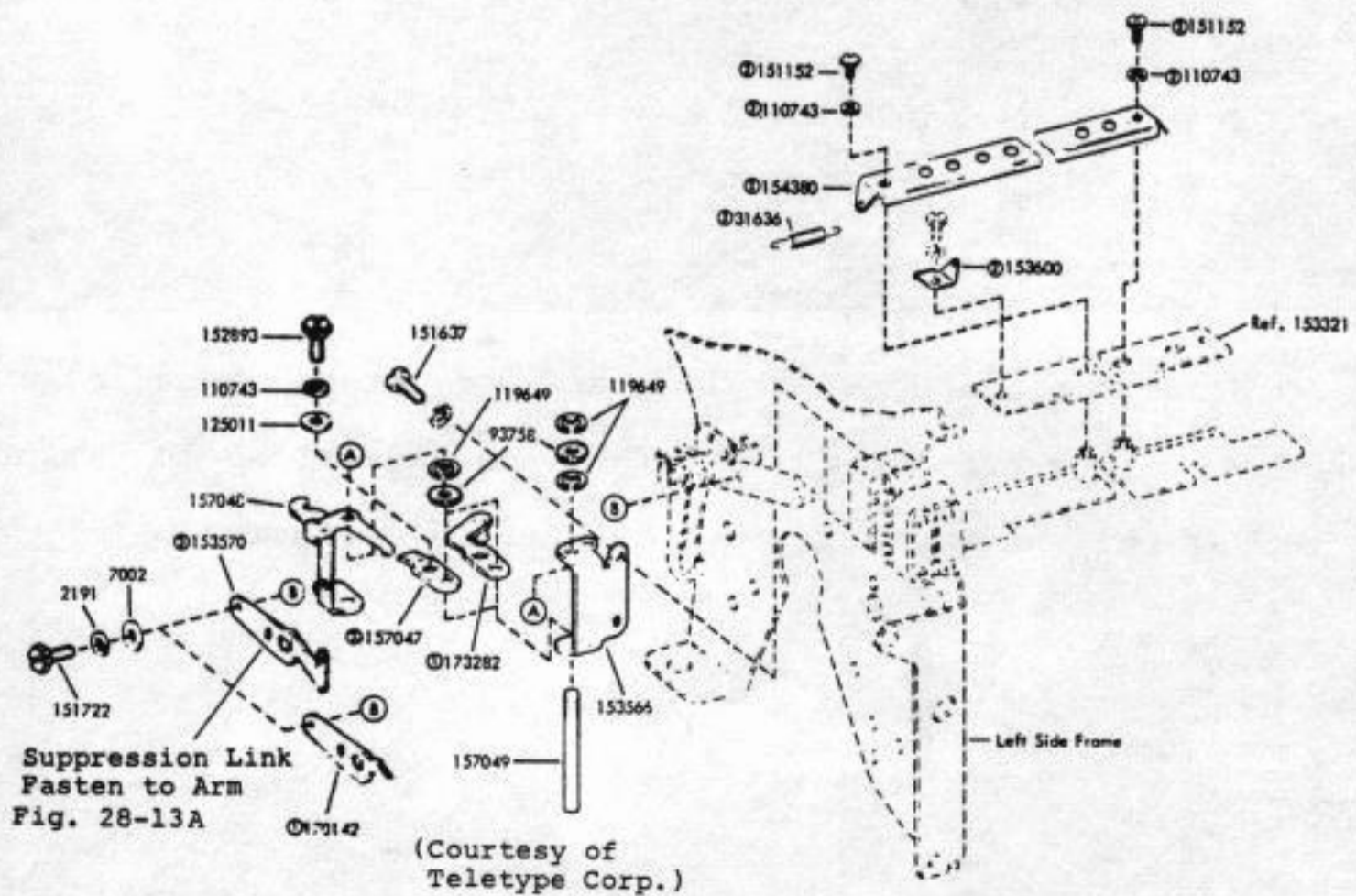

Fig. 28-13



MODEL 28

D. MOST FREQUENTLY ORDERED PARTS

1. Check that the gears as in Fig. 28-14 are for 60 words per minute:

<u>OLD STYLE</u>	<u>TELETYPE PART NO.</u>
Motor Pinion	151130
Driven Gear	151131
Both	151060
 <u>NEW STYLE</u>	
Motor Pinion	159278
Driven Gear	159279
Both	161293

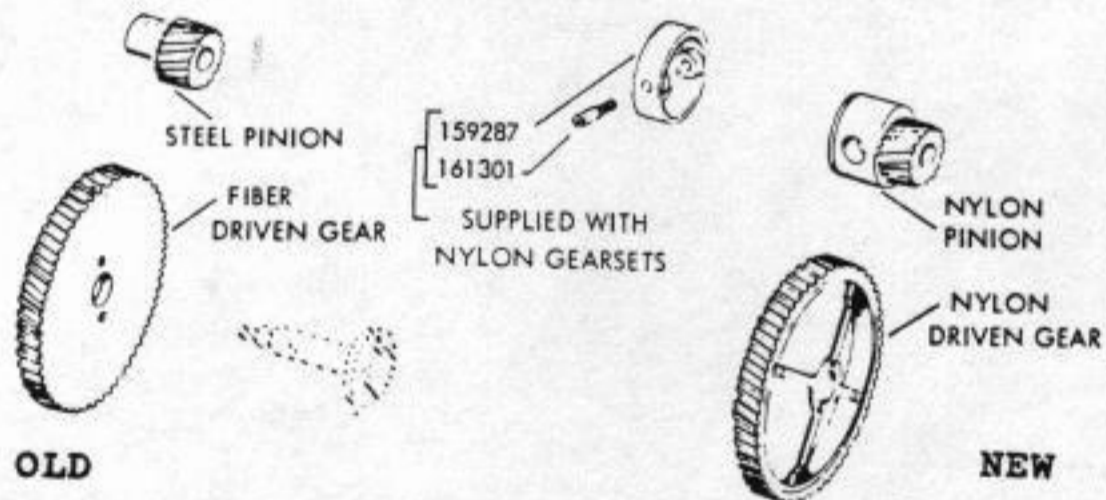

NOTE: Both old and new style gears are interchangeable as long as they are for 60 WPM. They are indential in performance; the new style is just quieter in operation.

MODEL 28

2. Check that the Signal Generator is in good condition
(that it has clean contacts and an easy working toggle).

OLD STYLE - 28C BASE - Fig. 28-9

Contact 151173

Toggle 151171

NEW STYLE - 28D BASE - Fig. 28-14

Contact 154045

Toggle 151171

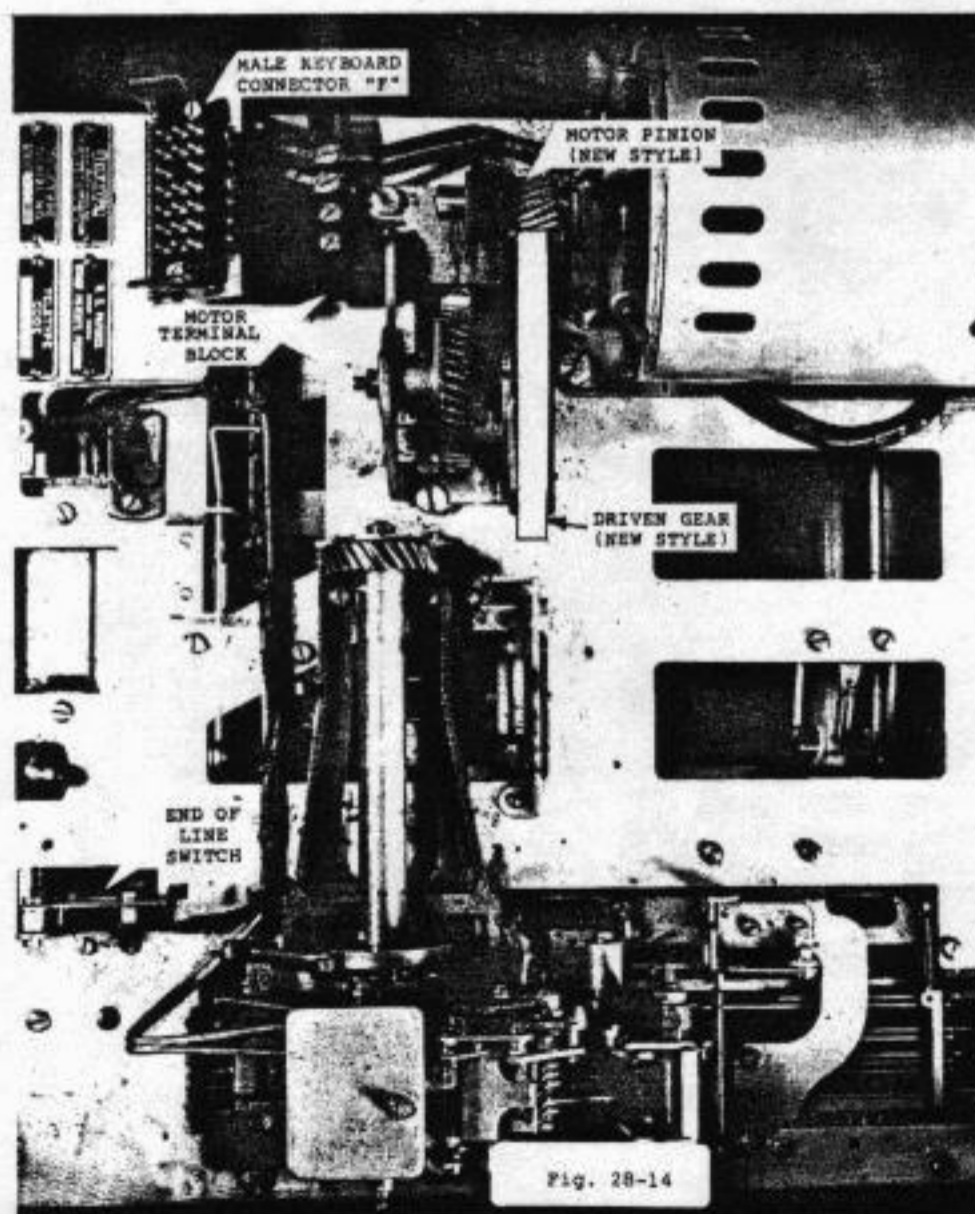

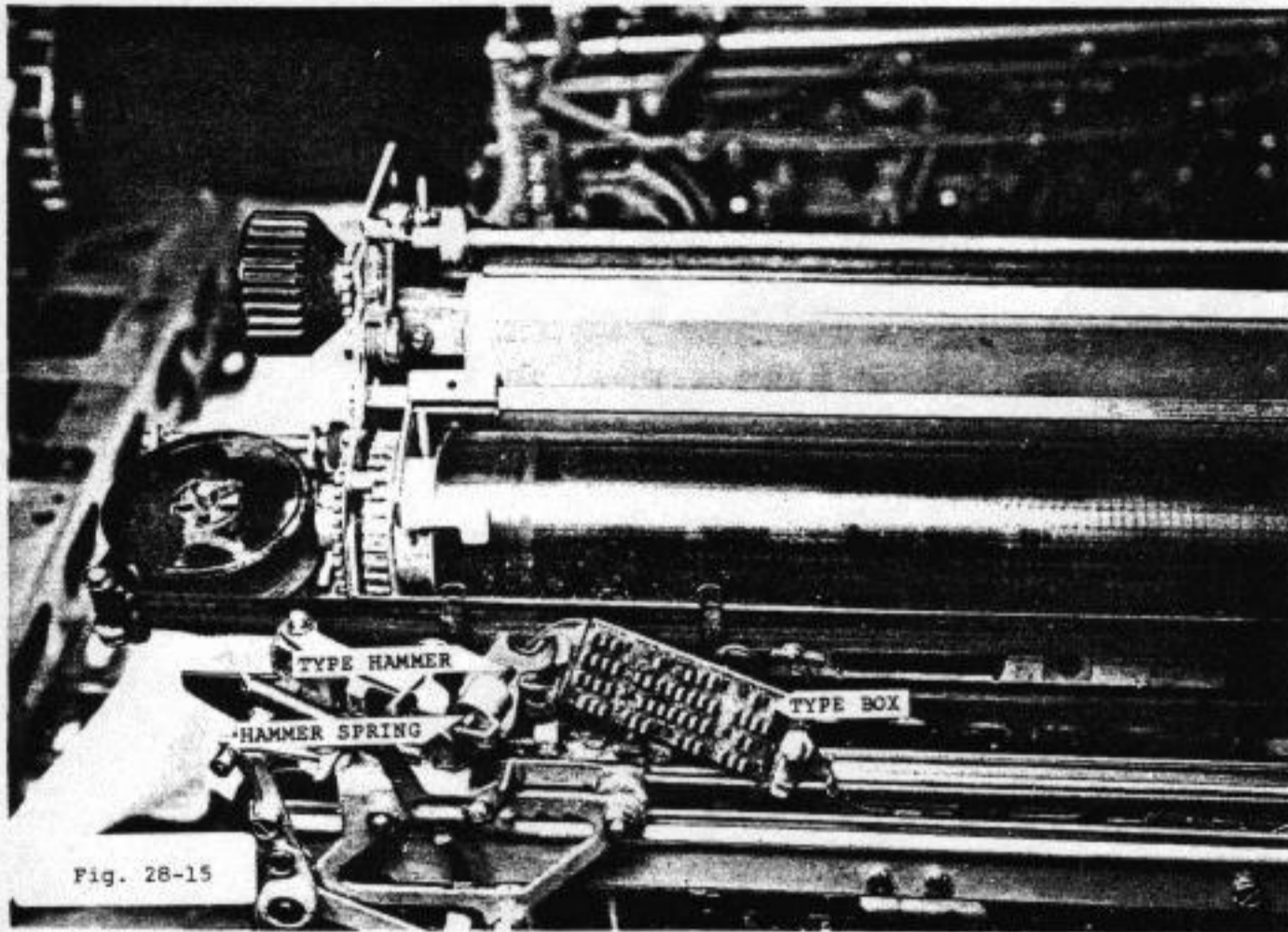

Fig. 28-15

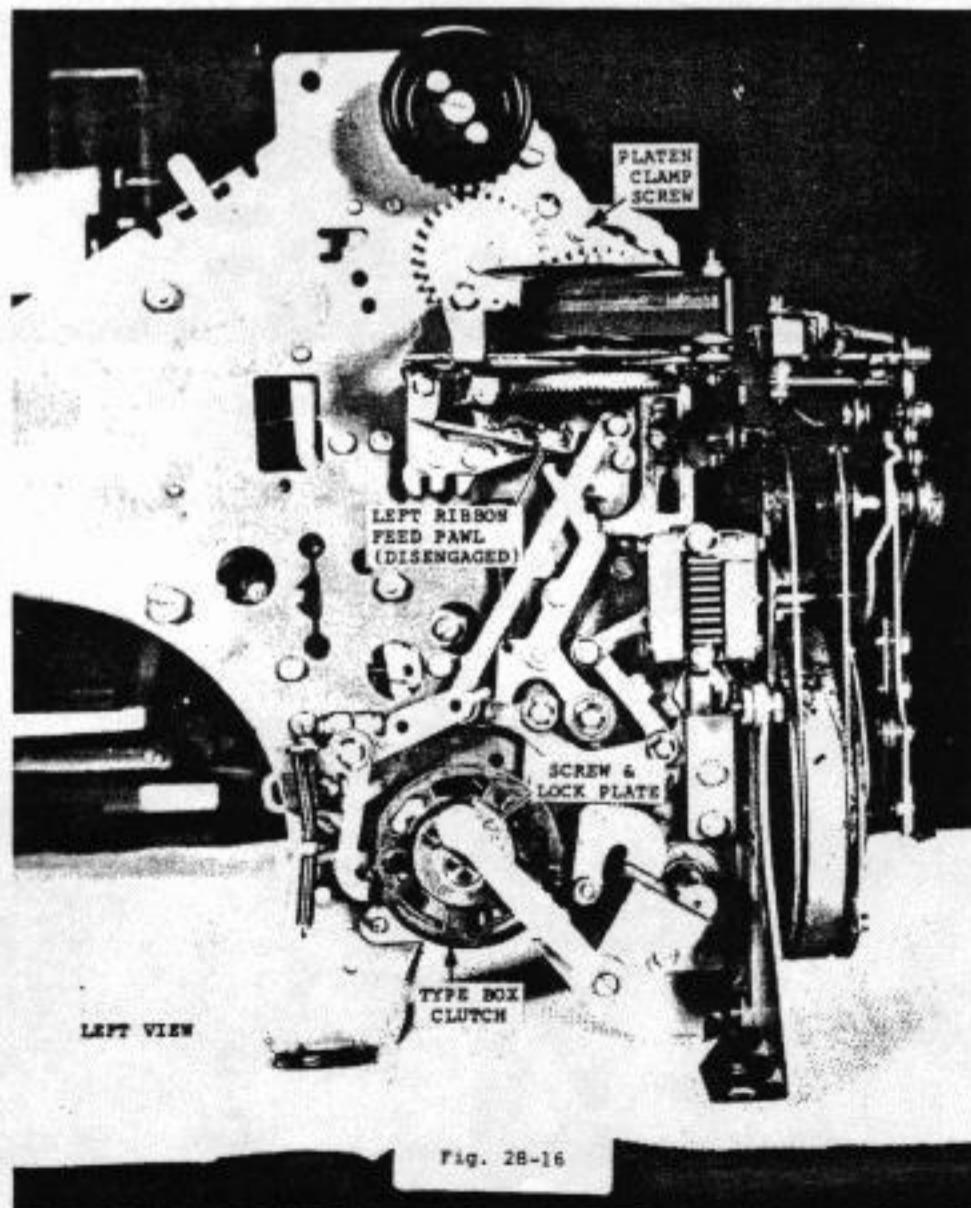

Fig. 28-16

MODEL 28

E. SOME COMMON TROUBLES

1. Motor is not running.

- a) Check the fuse. (Fig. 28-4)
- b) Check the keyboard plug to see if it is connected fully. (Fig. 28-4)
- c) Push the red reset button on the Motor base. It is a thermal cut-out resettable fuse.
- d) Check the power switch. (Fig. 28-1)

2. Printing does not occur.

- a) Type box may have come off if it was not latched. (Fig. 28-15)
- b) Check hammer spring and type hammer. (Fig. 28-15)
- c) Check the screws on the printing track for tightness. Also check for printing track levelness. (Fig. 28-13)
- d) E-type box may not be centered as it should be.

Note: If printing does not occur because the unit is running open (type carriage shifting rhythmically up and down):

- e) Keyboard contact hit accidentally and is now off normal, i.e., the toggle is not on Mark contact. To correct this, hit any key on the keyboard so it will reset.
- f) Typing unit connector is not attached properly.
- g) Black keyboard plug or red magnet plug not pushed into acoustical coupler jack all the way.

MODEL 28

h) Open transistor or other element in acoustical coupler.

3. Ribbon does not feed properly.

Feed pawls may not be engaged on either the left or right ribbon spool. Note that only one side should be engaged at a time. Refer to the following illustrations:

Left side spool (disengaged): Fig. 28-16

Right side spool (engaged): Fig. 28-17

4. Paper does not feed properly.

a) Check paper release lever for proper position (Fig. 28-17)

b) Check for proper installation of paper roll.

c) Platen is hard and slick from years of use. Either replace platen or rough up old platen with emery cloth. Refer to Section I for platen removal instructions.

5. Typing is garbled after teletypewriter is turned off for a long time.*

Oil may have accumulated between selector magnet armature and pole pieces (Fig. 28-17). Insert a dry piece of paper between the armature and pole to absorb and wipe off the oil film.

6. Typing is garbled due to dirty keyboard contact.*

Remove cover from signal generator contact box (Fig. 28-19) and clean contact on right side (marking contact) with a cloth impregnated with naphtha or an electrical contact cleaner according to Fig. 28-18. (Note that the left side contact is not wired into the circuit and can

MODEL 28

be ignored.)

* Garbles are due to a malfunction in either the keyboard or typing unit or both. No. 5 refers to the typing unit and No. 6 refers to the keyboard.

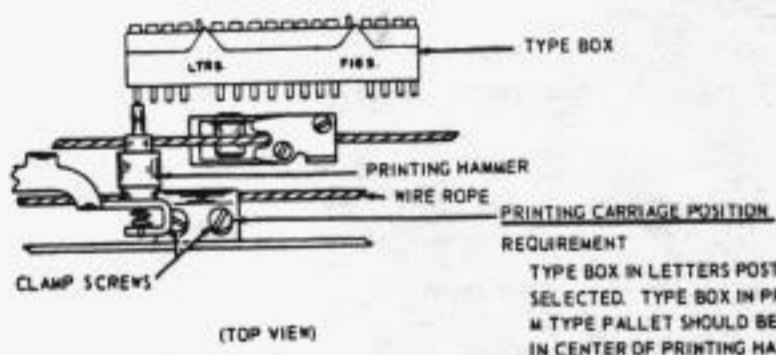
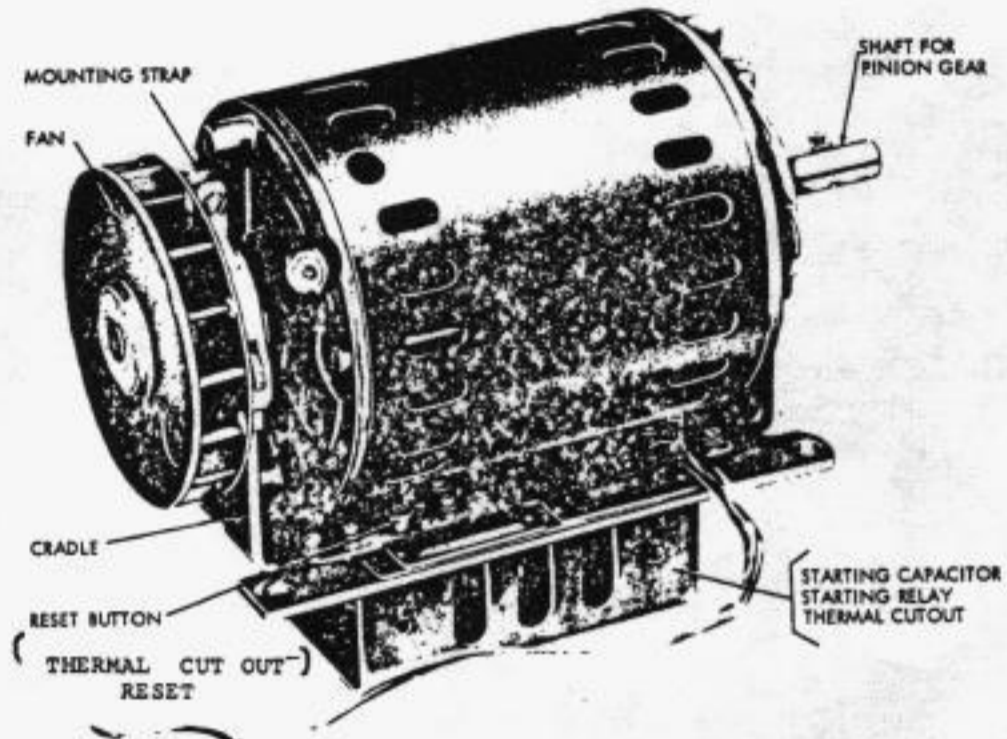

(Courtesy of Teletype Corp.)

PRINTING CARRIAGE POSITION REQUIREMENT
 TYPE BOX IN LETTERS POSITION, M TYPE PALLET SELECTED. TYPE BOX IN PRINTING POSITION, M TYPE PALLET SHOULD BE APPROXIMATELY IN CENTER OF PRINTING HAMMER WHEN HAMMER IS JUST TOUCHING M TYPE PALLET. TAKE UP PLAY IN TYPE BOX CARRIAGE IN EACH DIRECTION AND SET HAMMER IN CENTER OF PLAY
TO ADJUST
 POSITION PRINTING CARRIAGE ON WIRE ROPE WITH CLAMP SCREWS LOOSENED.

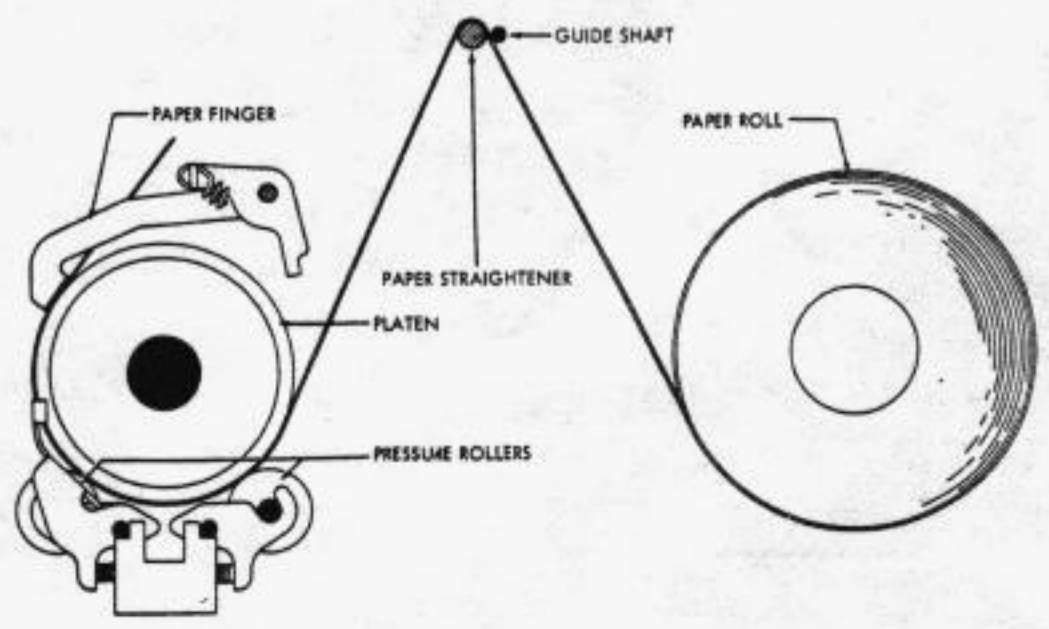

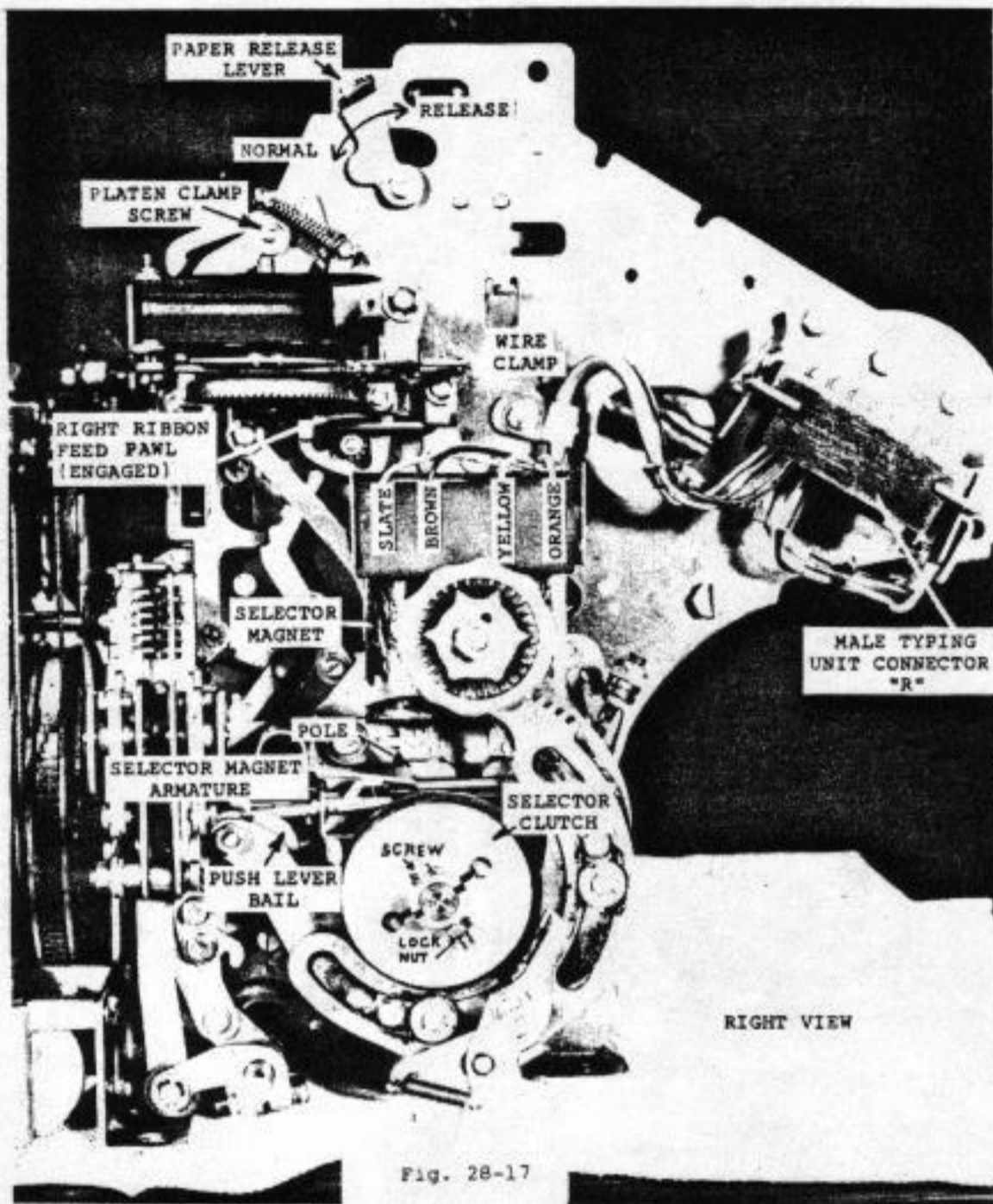

Fig. 28-17

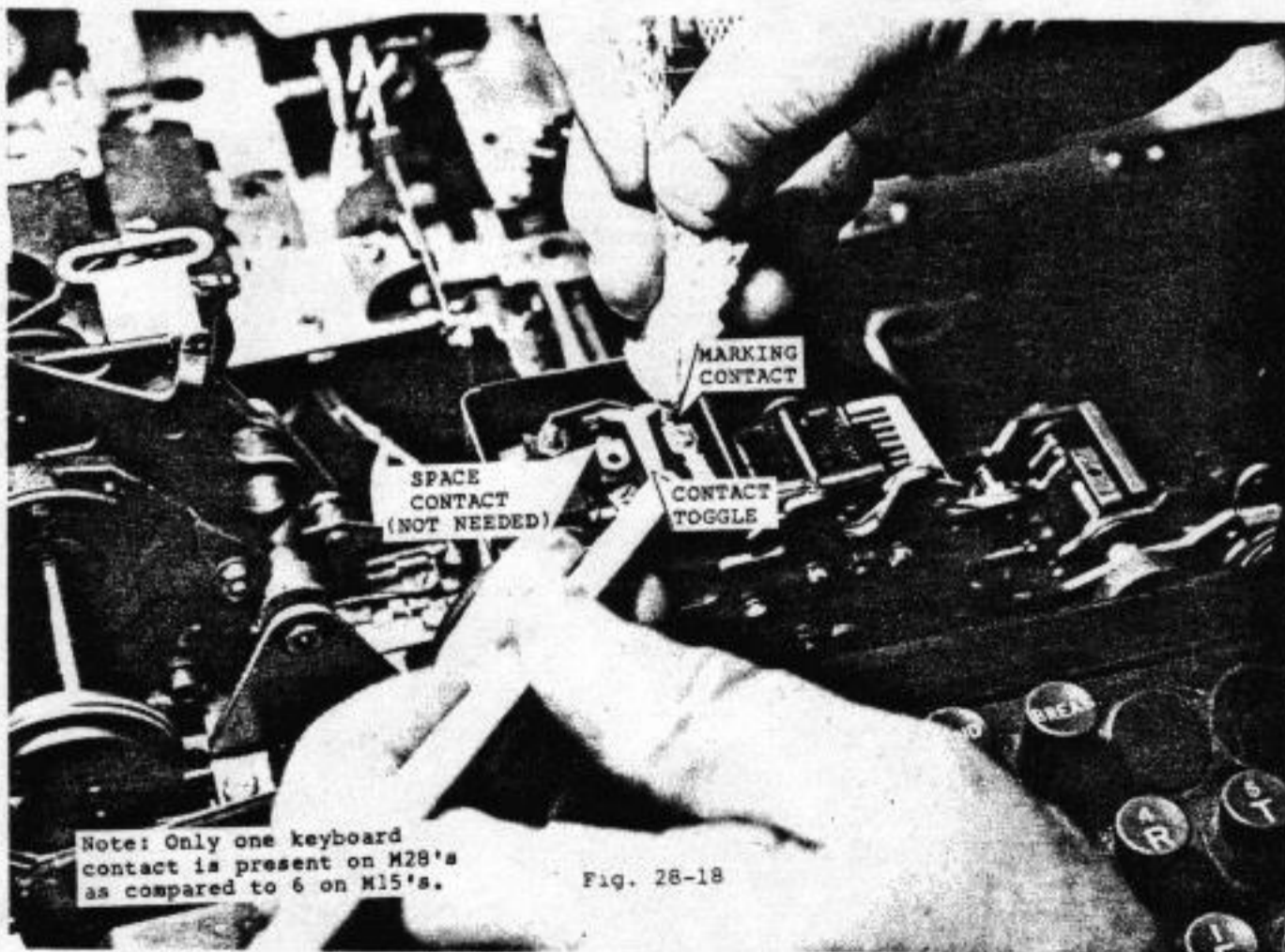

Fig. 28-18

MODEL 28

F. KEYBOARD CONTACT ADJUSTMENT

Note: Unless you have an appropriately connected oscilloscope, transmission measuring set, or distortion meter, it is not advisable to attempt this adjustment.

OLD STYLE - 28C BASE - Fig. 28-9

1. Loosen Contact Box mounting screws.
2. Loosen adjusting screw lock nut.
3. Turn adjusting screw to adjust keyboard contacts for the least amount of distortion as indicated by one of the above noted instruments.
4. Tighten the lock nut.
5. Tighten Contact Box mounting screws.

NEW STYLE - 28D BASE - Fig. 28-19

1. Loosen Contact Box mounting screws.
2. Turn the eccentric screw to adjust keyboard contacts for the least amount of distortion as indicated by one of the above mentioned instruments.
3. Tighten Contact Box mounting screws.

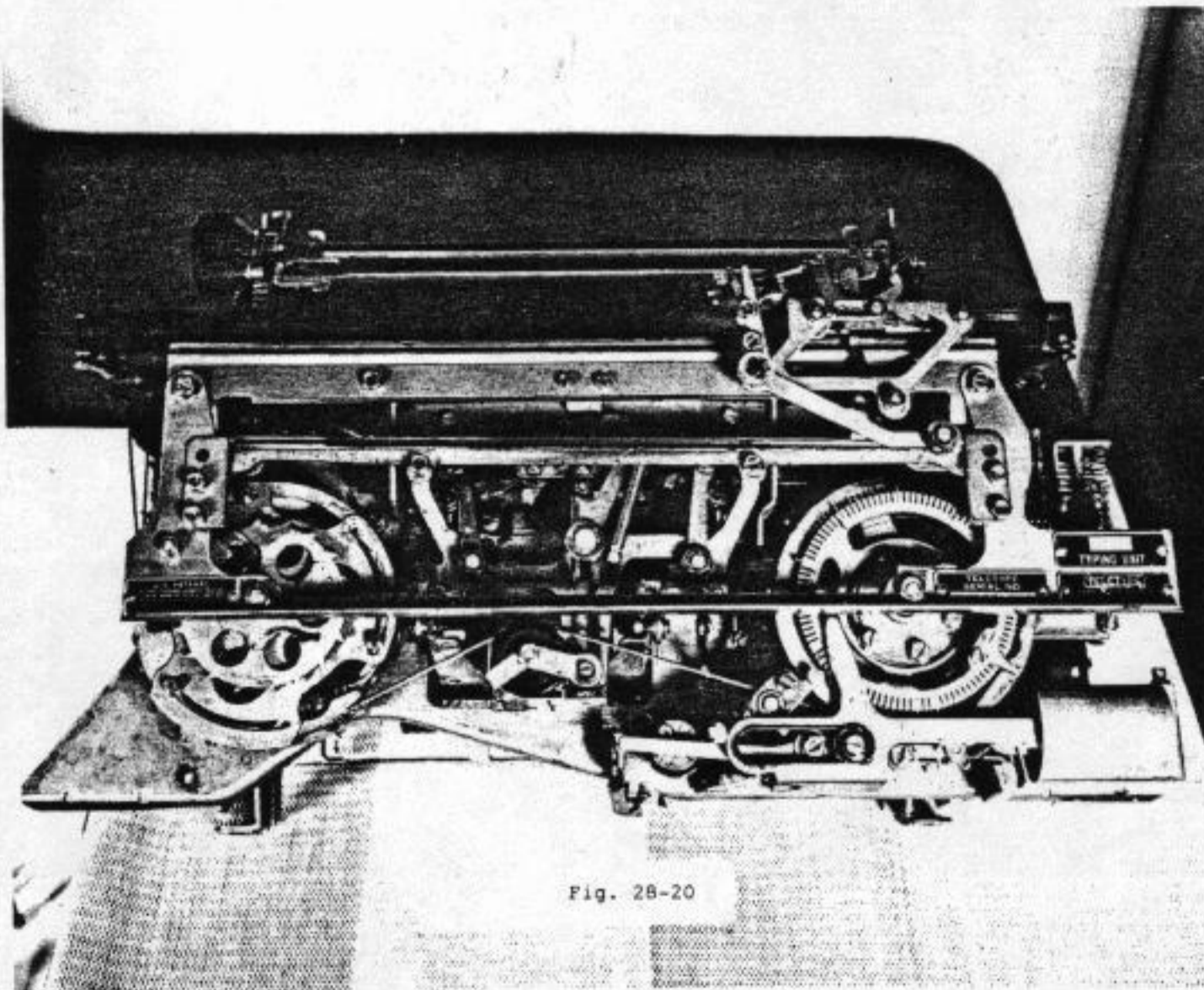
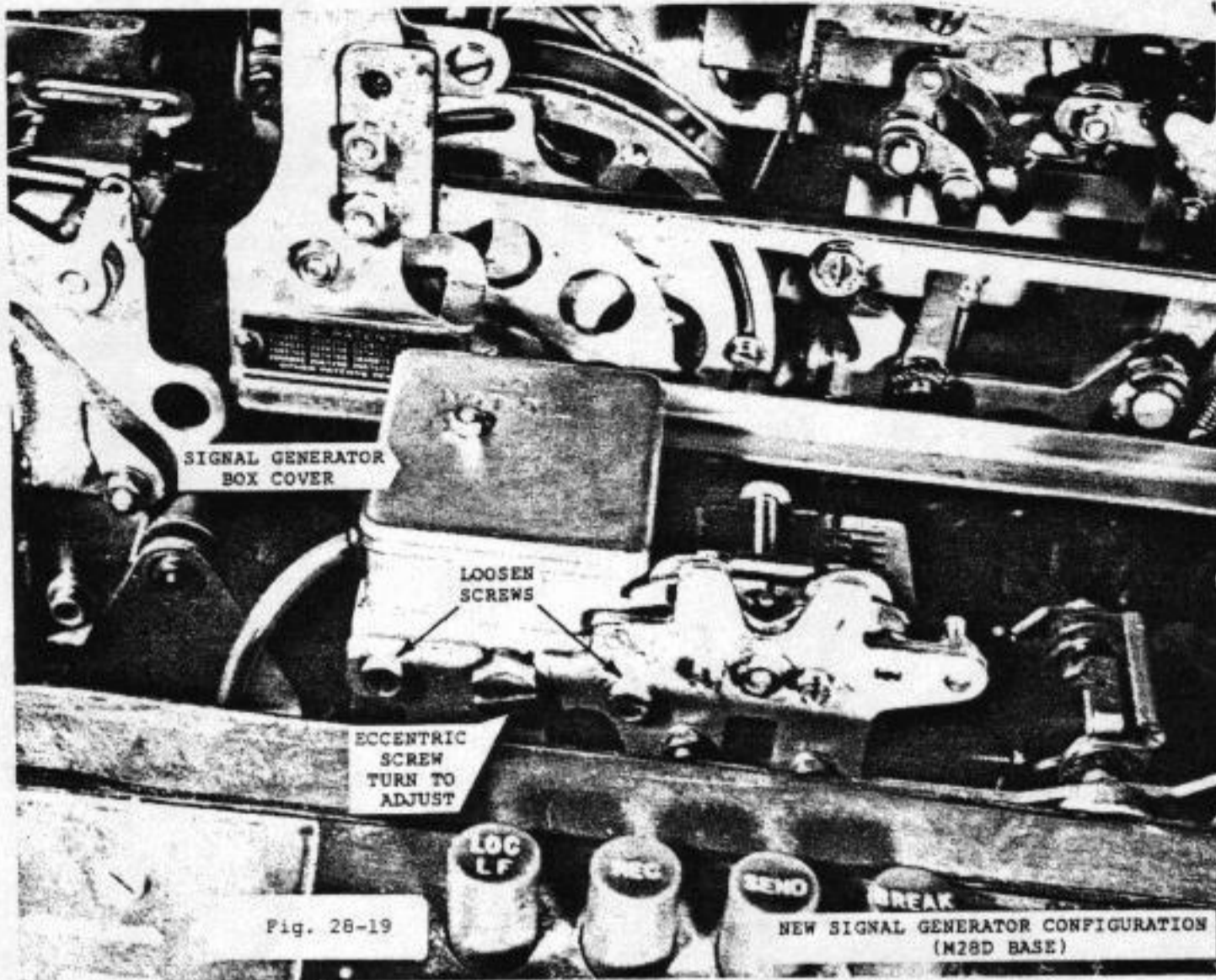

MODEL 28

G. FRONT PLATE (Fig. 28-20) DISASSEMBLY

Note: This procedure is to be used only to tear down the unit for repair.

1. Remove the two mounting screws indicated in Fig. 28-13, and the other two indicated in Fig. 28-21 and Fig. 28-8, respectively.
2. Push the Type Box carriage to the extreme right of the print track (Fig. 28-13).
3. Remove the snap ring from the Type Box carriage link and pull the link arm out of the hole in the Type Box carriage (Fig. 28-22).
4. Remove two screws from the rocker shaft (Fig. 28-23).
5. Now pull the Front Plate up and it will lift off as a complete unit.

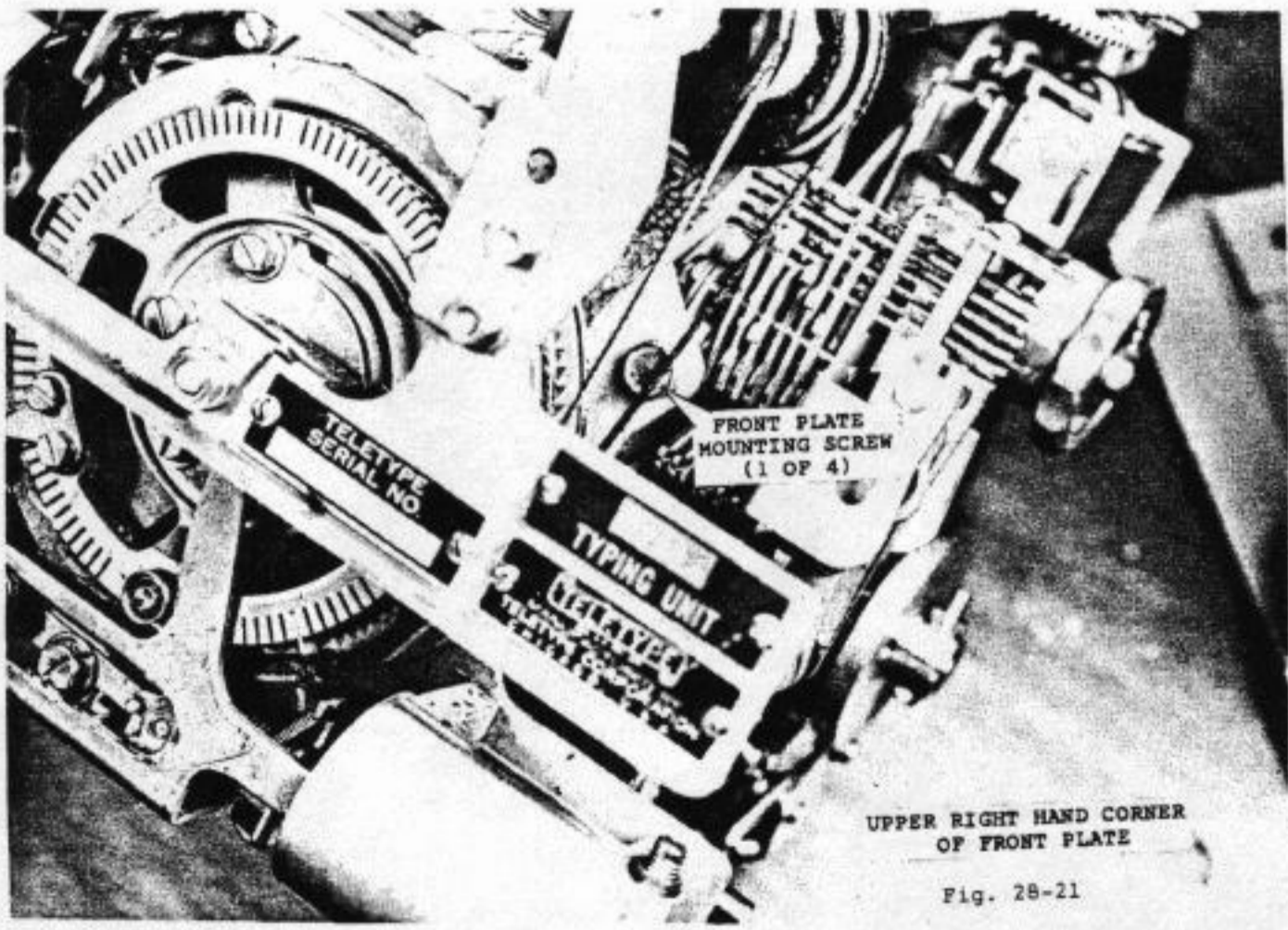
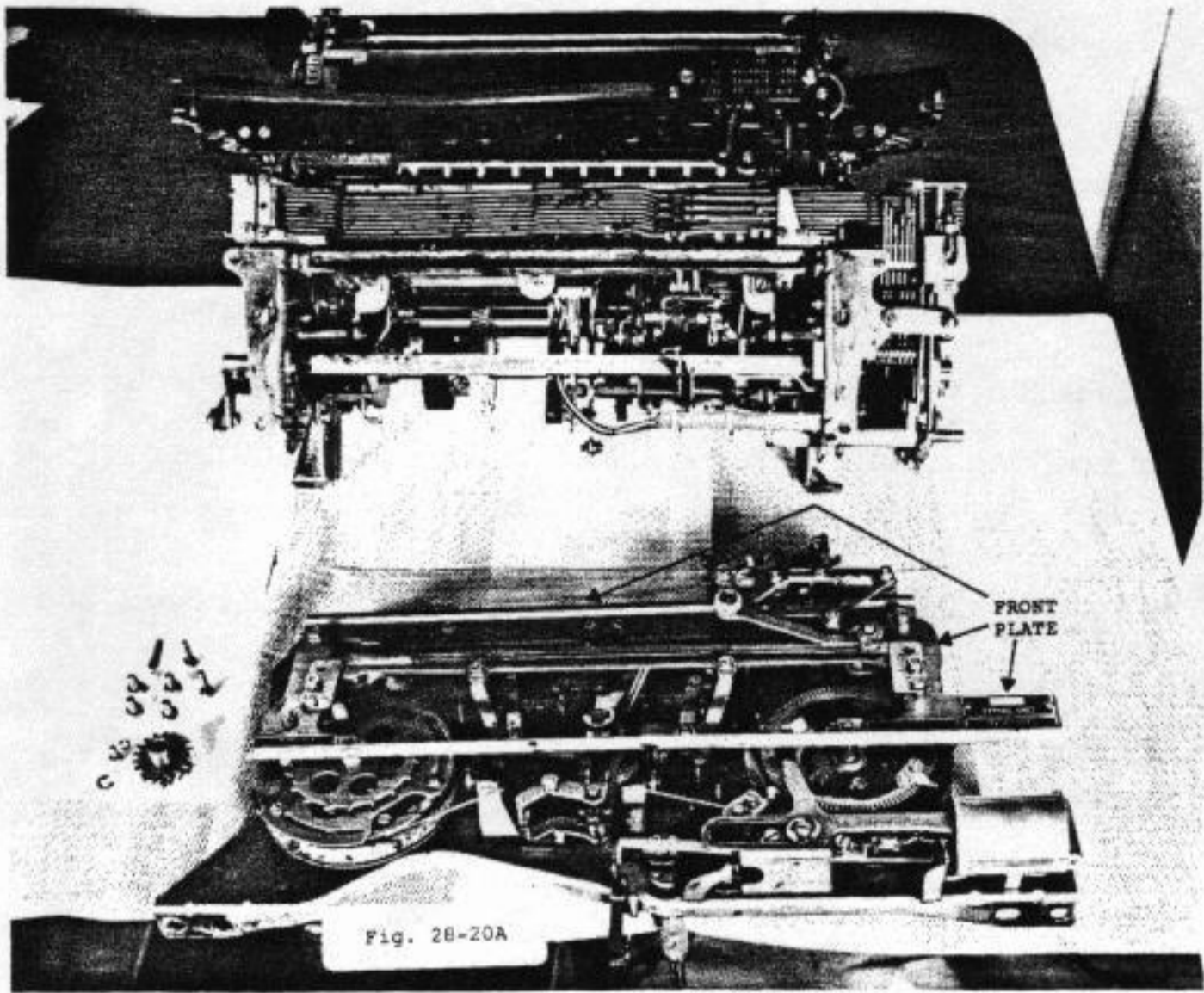

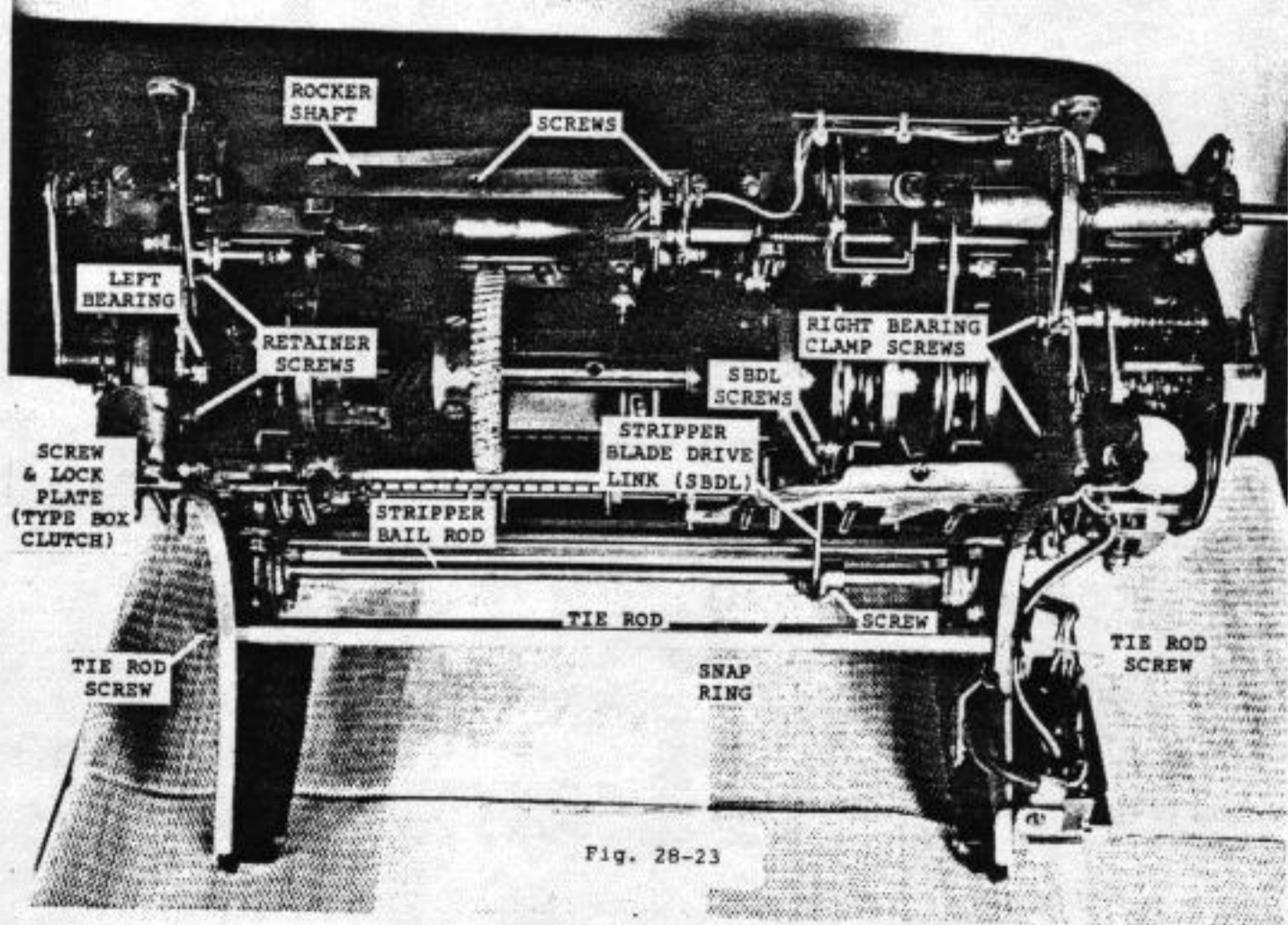
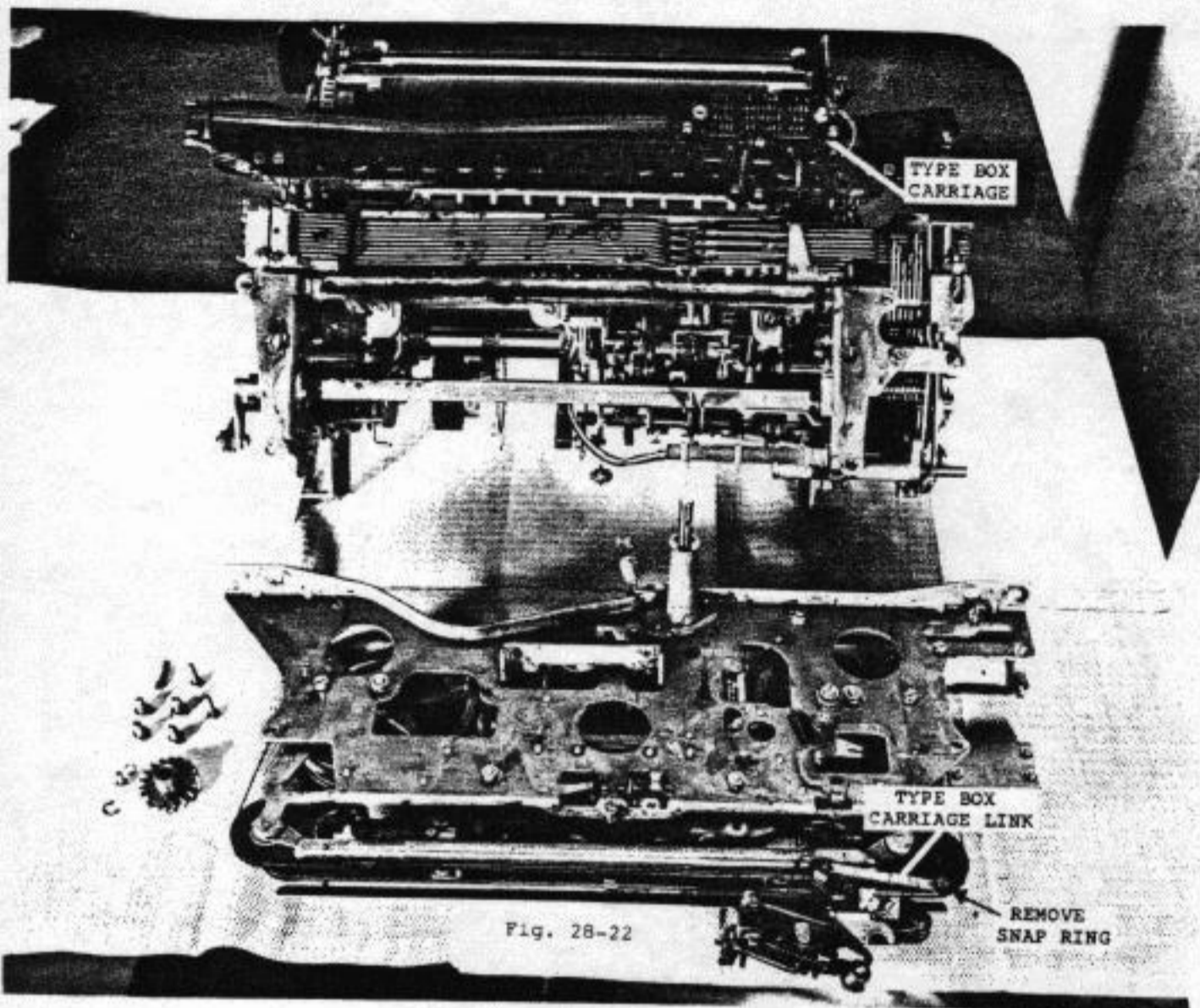

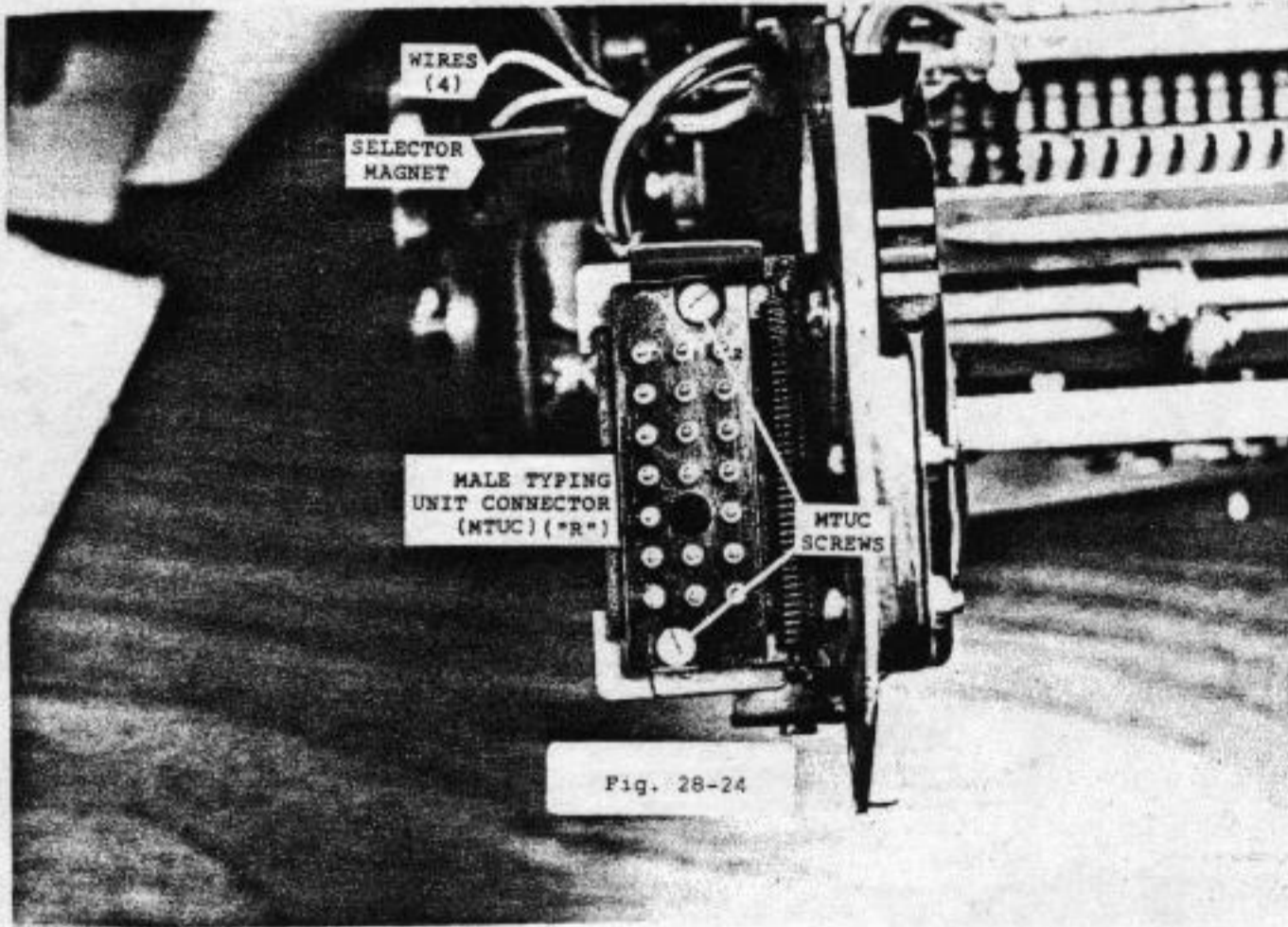

Fig. 28-24

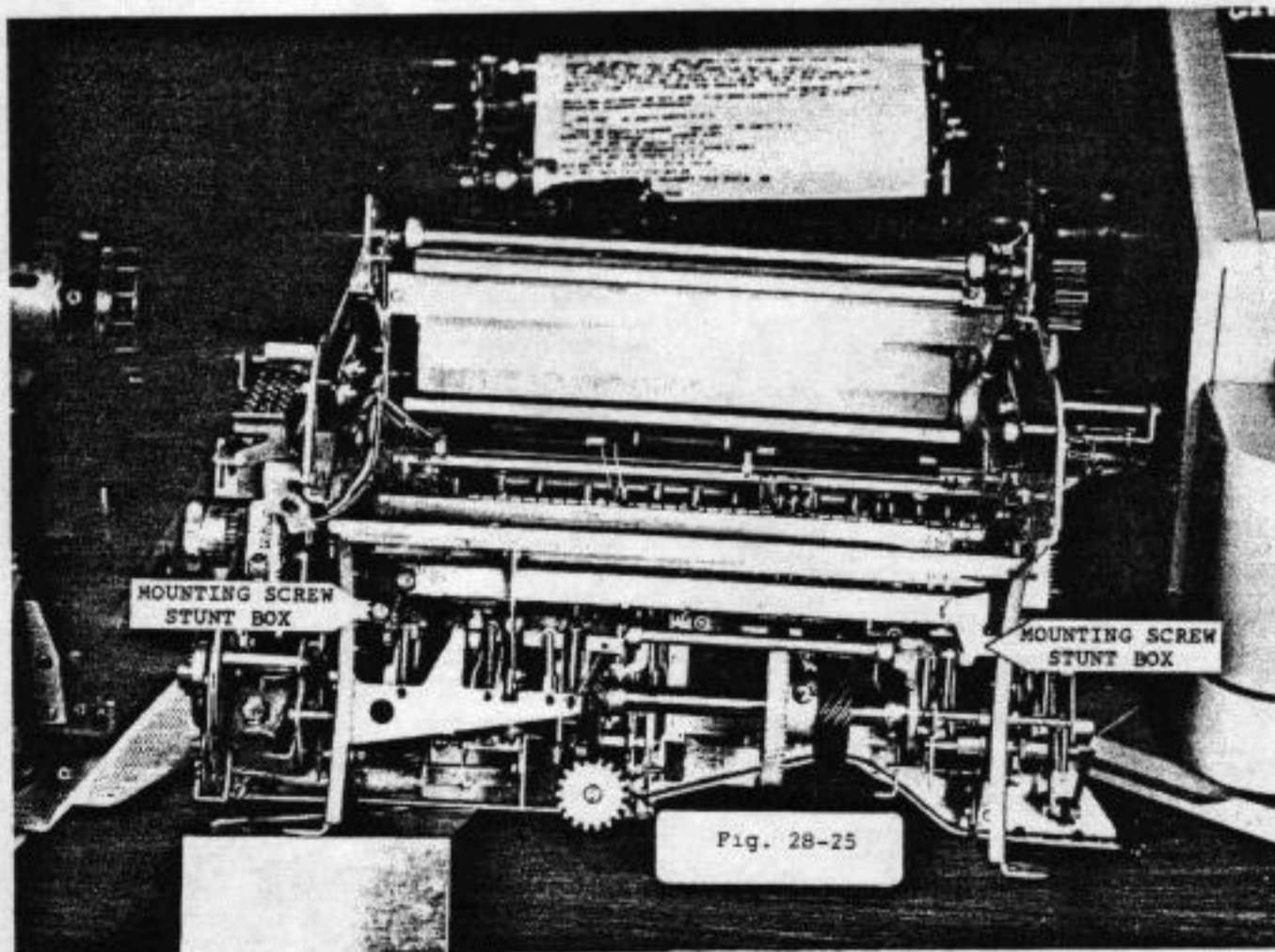
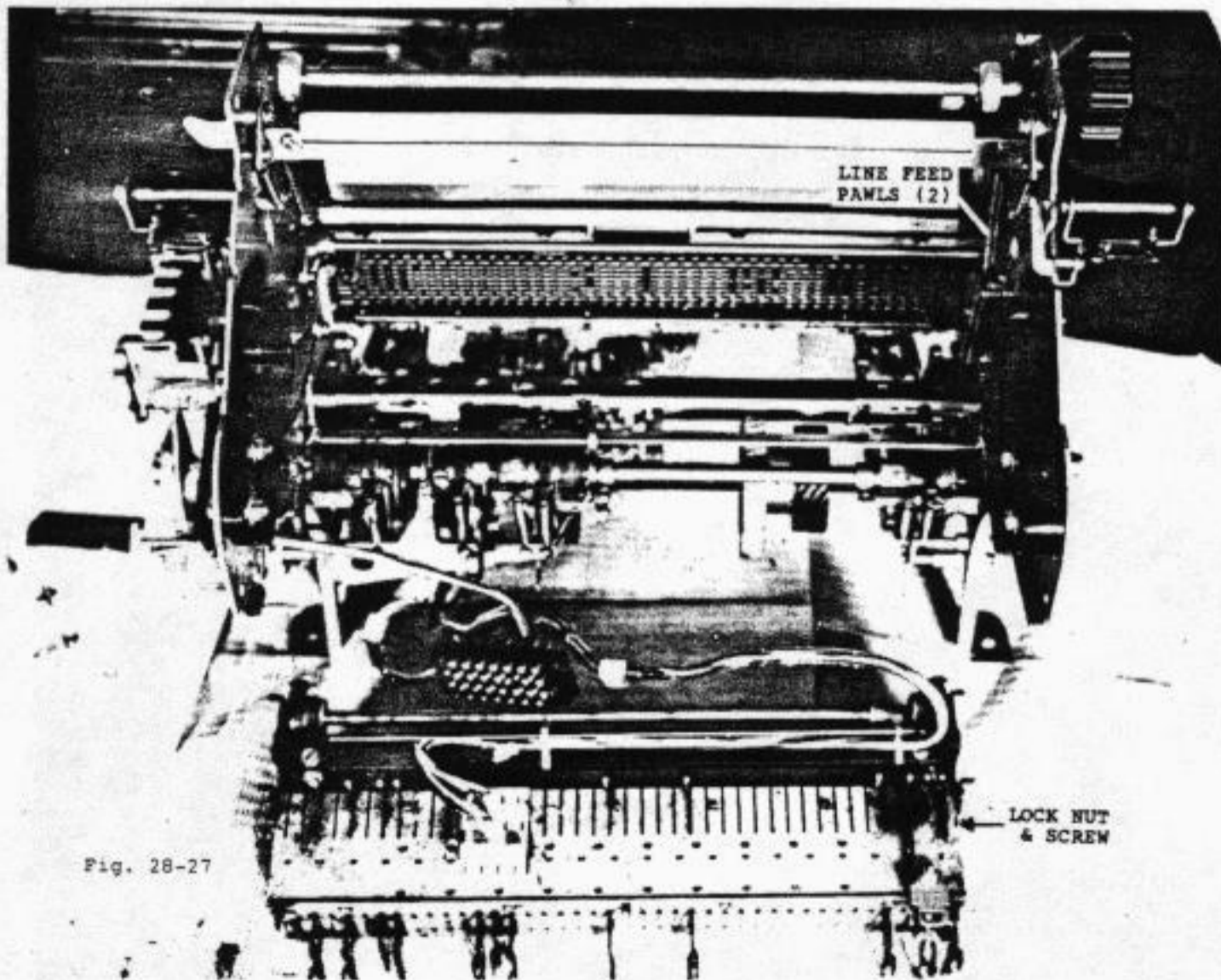
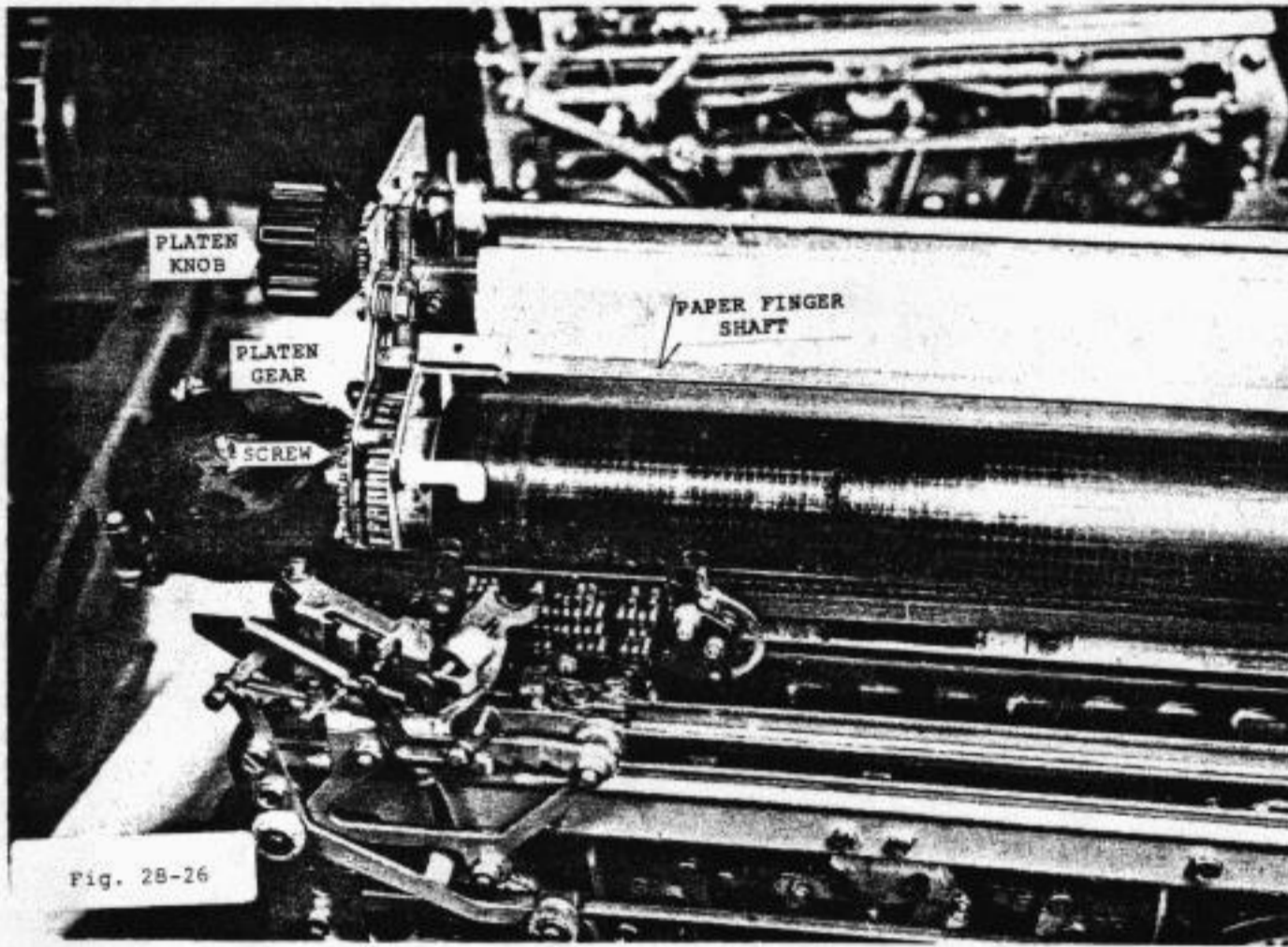

Fig. 28-25

MODEL 28

H. STUNT (FUNCTION) BOX (Fig. 28-12) REMOVAL

1. Remove wires that are connected to the selector magnets (Fig. 28-24).
2. Remove screw in clamp that holds wiring to the Right frame (Fig. 28-17).
3. Remove the two screws that mount the connector to the typing unit (Fig. 28-24).
4. Remove the two screws holding the tie rod. (Fig. 28-23).
5. Remove the screw and snap ring from the stripper bail rod and push link to the left.
6. Remove the two screws mounting the Stunt Box to the typing unit (Fig. 28-25).
7. Now pull the Stunt Box rearward and it will release from the typing unit.



MODEL 28

I. PLATEN REMOVAL

1. Remove the Platen clamp screw (Fig. 28-17 - right view).
2. Remove the other Platen clamp screw (Fig. 28-16 - left view).
3. Remove paper finger shaft by pulling out to the Right (Fig. 28-26).
4. Remove Platen gear and mounting screw (Fig. 28-26).
5. Push down on the Platen knob to disengage the line feed pawls (Fig. 28-26 and 28-27).
6. Lift the Platen out of the unit.

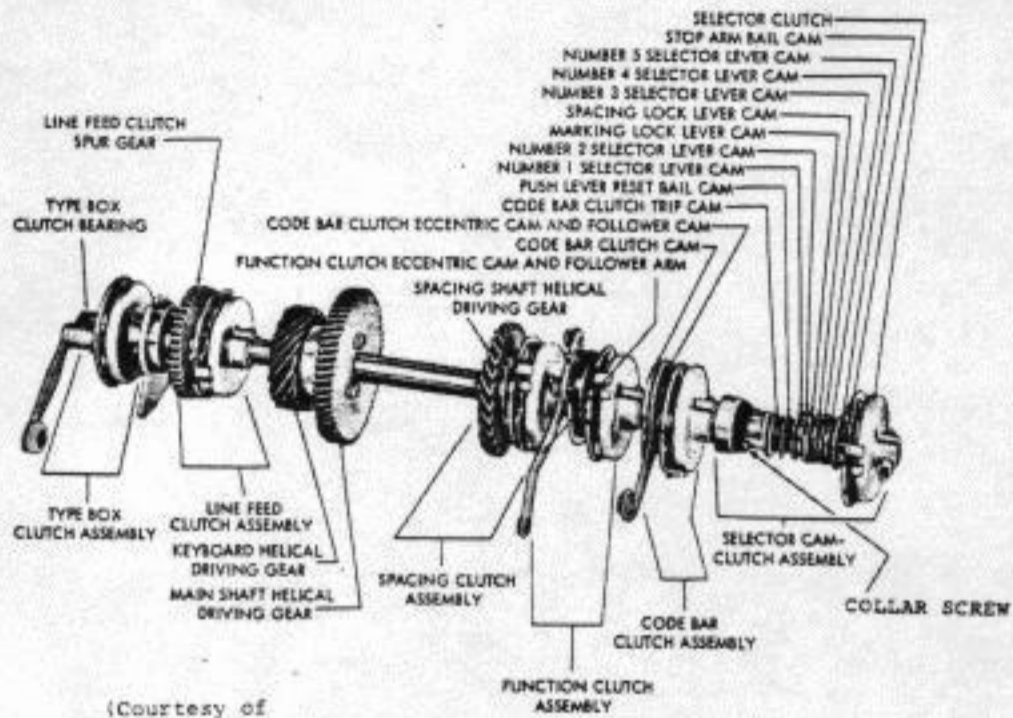

(Courtesy of Teletype Corp.)

FACING FRONT

Typing Unit Main Shaft

LEFT

Fig. 28-28

RIGHT

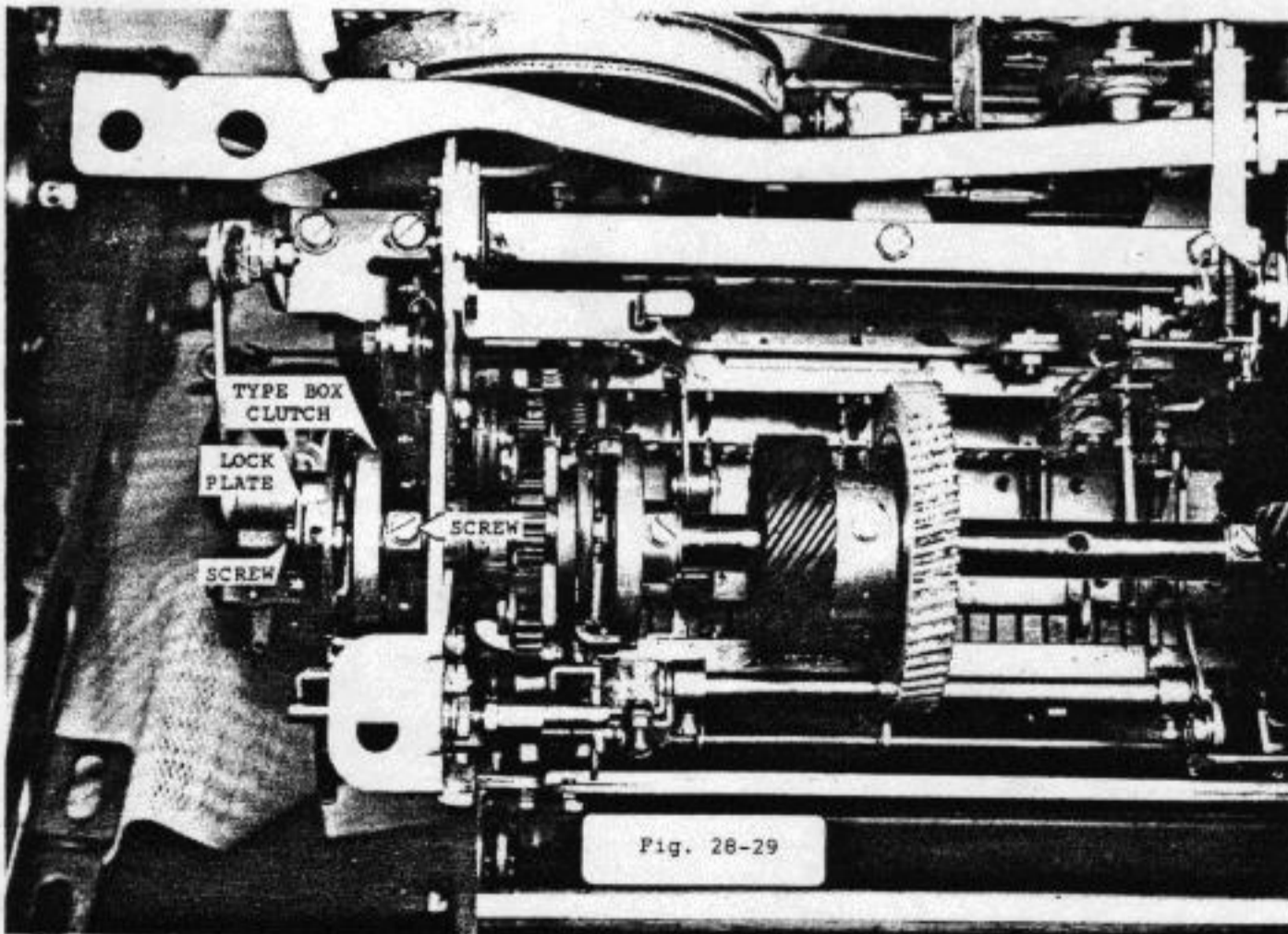

Fig. 28-29

MODEL 28

J. MAIN SHAFT (Fig. 28-28) DISASSEMBLY

Note: This procedure is to be used only to tear down the unit for repair.

1. Raise the push lever bail up and push inward on the bail (Fig. 28-17).
2. Remove screw and lock nut from the selector clutch, then rotate the clutch and pull it toward you to remove the clutch and cam sleeve (Fig. 28-17).
3. Remove screw from the collar, then remove the collar from the shaft (Fig. 28-28).
4. Remove two screws from the right bearing clamp (Fig. 28-23).
5. Remove the screw and snap ring from the stripper bail rod (Fig. 28-23).
6. Remove the left bearing retainer screws (Fig. 28-23).
7. Remove the type box clutch drive link by removing the screw and lock plate (Fig. 28-29).
8. Remove the two screws holding the stripper blade drive link to the function clutch (Fig. 28-23).
9. Remove the screw which mounts the type box clutch to the main shaft; then pull the type box clutch off the main shaft (Fig. 28-29).
10. Pull the main shaft to the left while rotating it at the same time, to remove it from the typing unit.

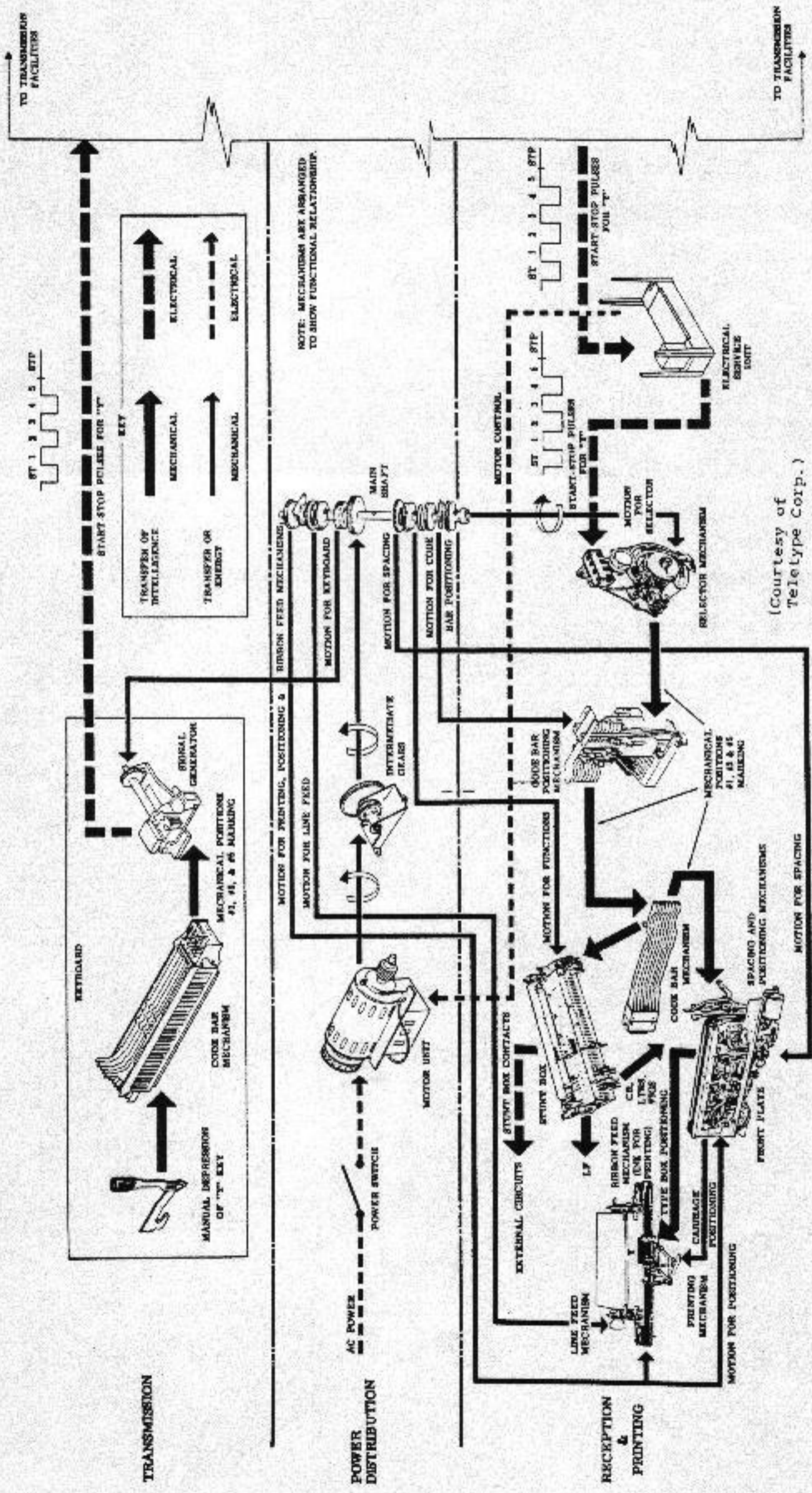

(Courtesy of
Teletype Corp.)

28 Typing Unit, Schematic Diagram

K. DESCRIPTIONS OF VARIOUS CLUTCHES

1. SELECTOR CLUTCH - Converts incoming signals into mechanical marking or spacing pulses.
2. CODE BAR CLUTCH -
 - a) Positions the code bars.
 - b) Prepares the stunt box for functions which can be selected, i.e., a cam on the code bar clutch operates the function clutch and the type box clutch.
3. FUNCTION CLUTCH - Causes operation of the function bail, and of the stunt box stripper bail.
4. SPACING CLUTCH - Advances the type box across the page.
5. LINE FEED CLUTCH - Operates the linkage that feeds the paper.
6. TYPE BOX CLUTCH -
 - a) Prepares the unit for vertical positioning.
 - b) Activates the ribbon feed.
 - c) Prepares the unit for horizontal positioning.

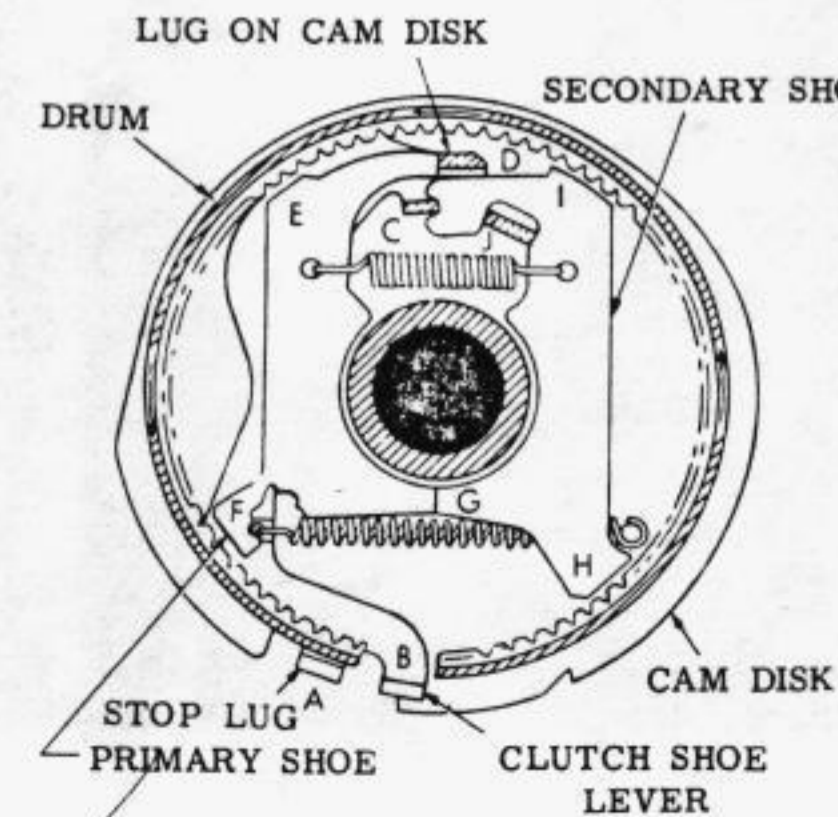

- One Stop Clutch (Disengaged)

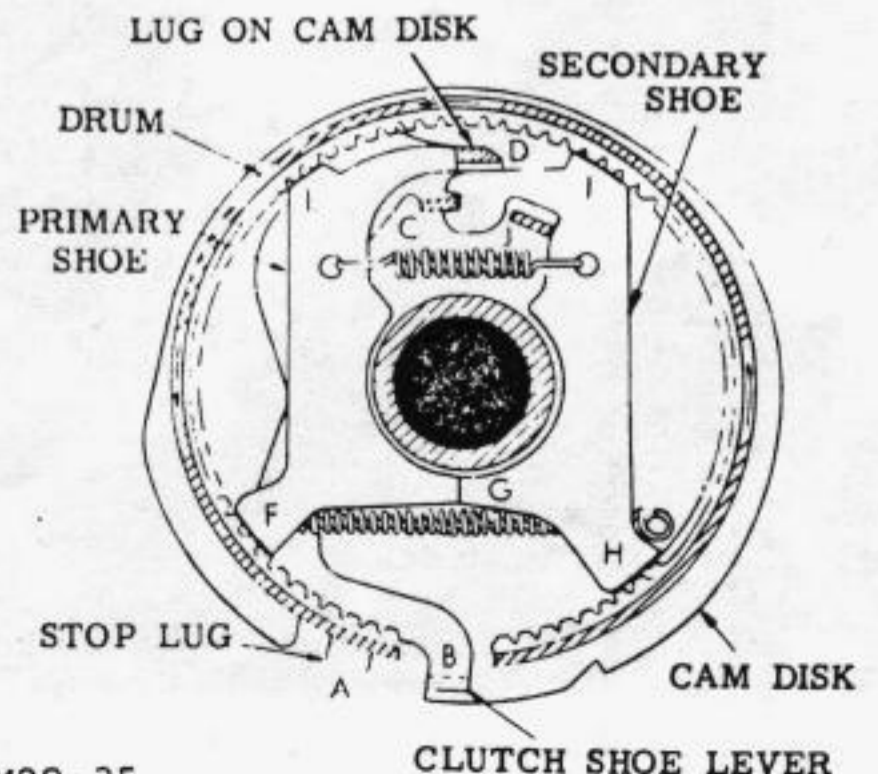

M28-35

One Stop Clutch (Engaged)

L. COMMON ADJUSTMENTS

The following pages of this section contain reproductions of selected procedures from manuals issued by the Teletype Corporation. Included are a few Keyboard adjustments, followed by Typing Unit adjustments, which, in the experience of the authors, have required most frequent attention. Contingent upon demand, this approach will be applied to future additions, with abridgement or clarification of instructions if necessary.

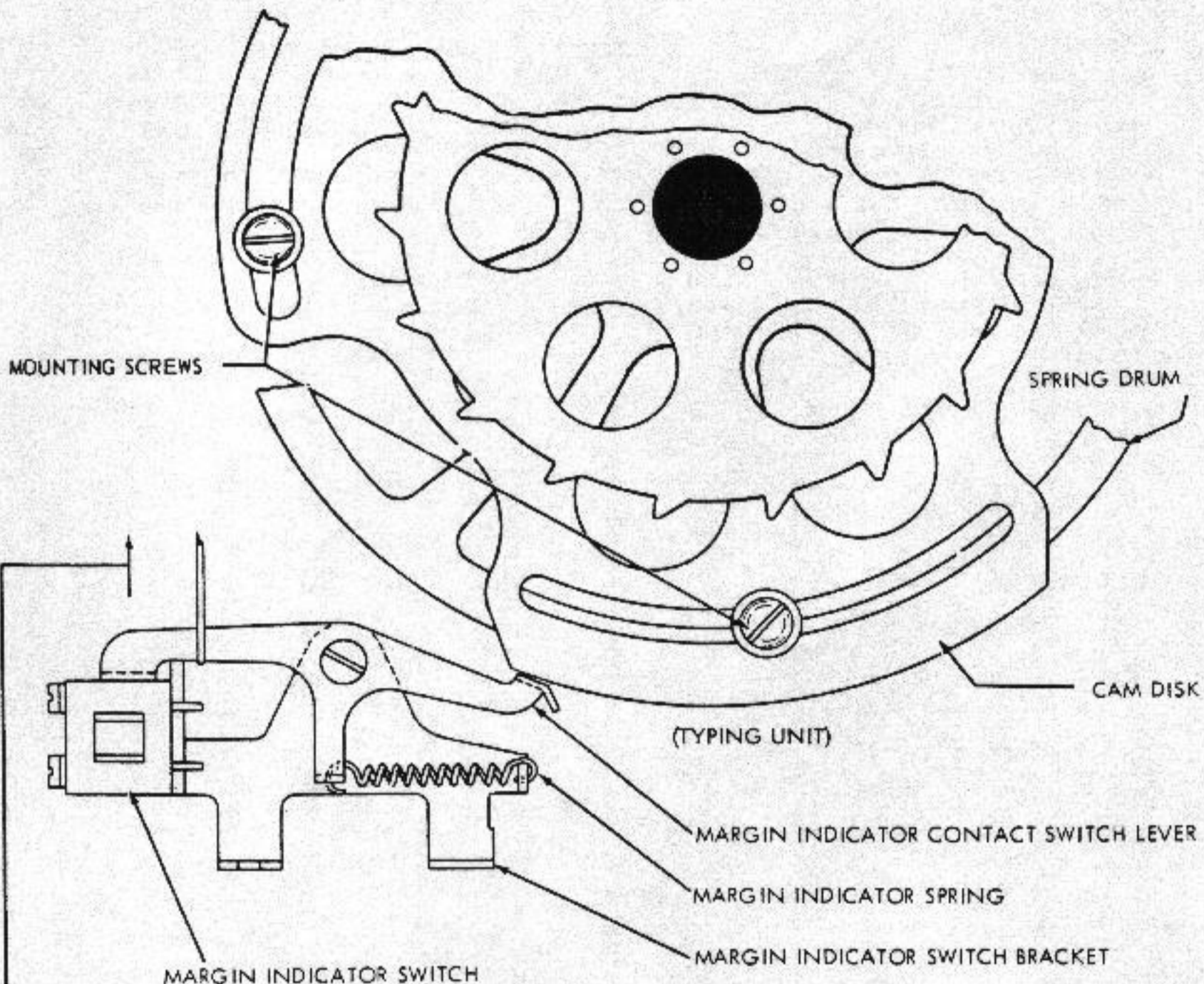

MARGIN INDICATOR LAMP

REQUIREMENT

OPERATING UNDER POWER, THE LAMP SHOULD LIGHT ON THE DESIRED CHARACTER

TO ADJUST

SET THE TYPE BOX CARRIAGE TO PRINT THE DESIRED CHARACTER AND POSITION THE CAM DISK COUNTERCLOCKWISE ON THE SPRING DRUM WITH ITS THREE MOUNTING SCREWS LOOSENED SO THAT THE SWITCH JUST OPENS.

MARGIN INDICATOR SPRING TENSION

REQUIREMENT

MIN. 7 OZS.
 MAX. 11 OZS.
 TO START LEVER MOVING.

(Courtesy of Teletype Corp.)

Typing Unit and Keyboard, Margin Indicating Mechanism

(2) REQUIREMENT

THERE SHOULD BE A BARELY PERCEPTIBLE AMOUNT OF BACKLASH BETWEEN THE INTERMEDIATE DRIVING GEAR AND THE INTERMEDIATE DRIVEN GEAR AT THE POINT WHERE THE BACKLASH IS THE LEAST.

TO ADJUST

RAISE OR LOWER THE FRONT END OF THE INTERMEDIATE GEAR BRACKET BY MEANS OF THE FILLISTER HEAD ADJUSTING AND CLAMPING SCREWS LOCATED AT THE FRONT END OF THE BRACKET. REFINE REQUIREMENTS IF NECESSARY.

INTERMEDIATE GEAR BRACKET

(1) REQUIREMENT

THERE SHOULD BE A BARELY PERCEPTIBLE AMOUNT OF BACKLASH BETWEEN THE TYPING UNIT DRIVEN GEAR AND THE TYPING UNIT DRIVING GEAR AT THE POINT WHERE BACKLASH IS THE LEAST.

TO ADJUST

POSITION THE COMPLETE INTERMEDIATE GEAR MECHANISM BRACKET BY UTILIZING THE ADJUSTING SLOTS WITH THE THREE HEXAGON HEAD SCREWS LOOSENED. ALIGN THE GEARS AT THIS TIME

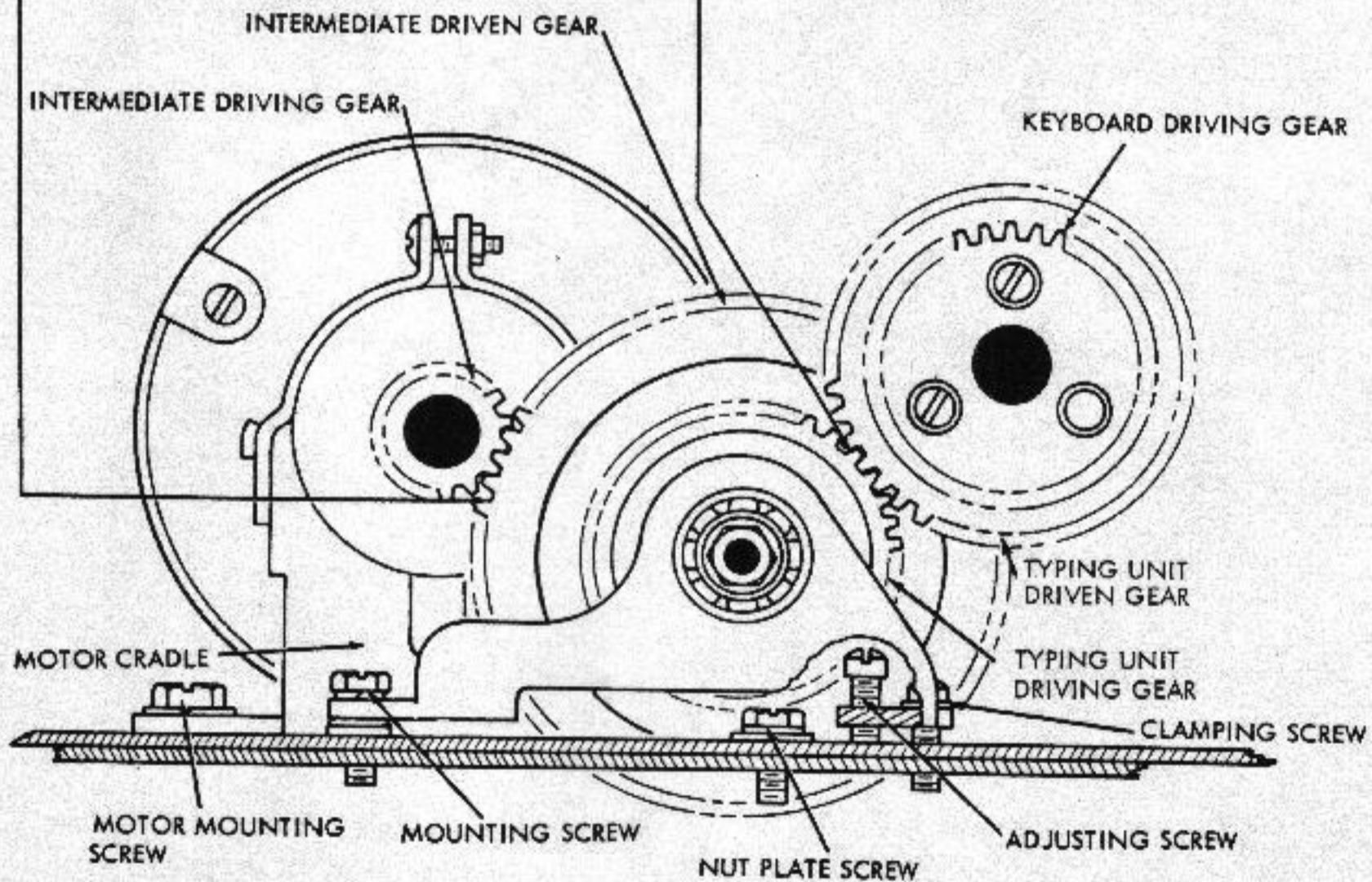

(Courtesy of Teletype Corp.)

Keyboard or Base, Intermediate Gear Assembly

(A) SIGNAL GENERATOR FRAME
REQUIREMENT
 WITH TYPING UNIT MOUNTED IN POSITION, THERE SHOULD BE A PERCEPTIBLE AMOUNT OF BACKLASH BETWEEN THE SIGNAL GENERATOR DRIVEN GEAR AND THE SIGNAL GENERATOR DRIVING GEAR AT THE POINT WHERE BACKLASH IS THE LEAST.
 TO ADJUST
 REMOVE THE SIGNAL GENERATOR FRAME REAR MOUNTING SCREW AND LOOSEN THE SHIM SCREW. ADD OR SUBTRACT SHIMS AS REQUIRED.

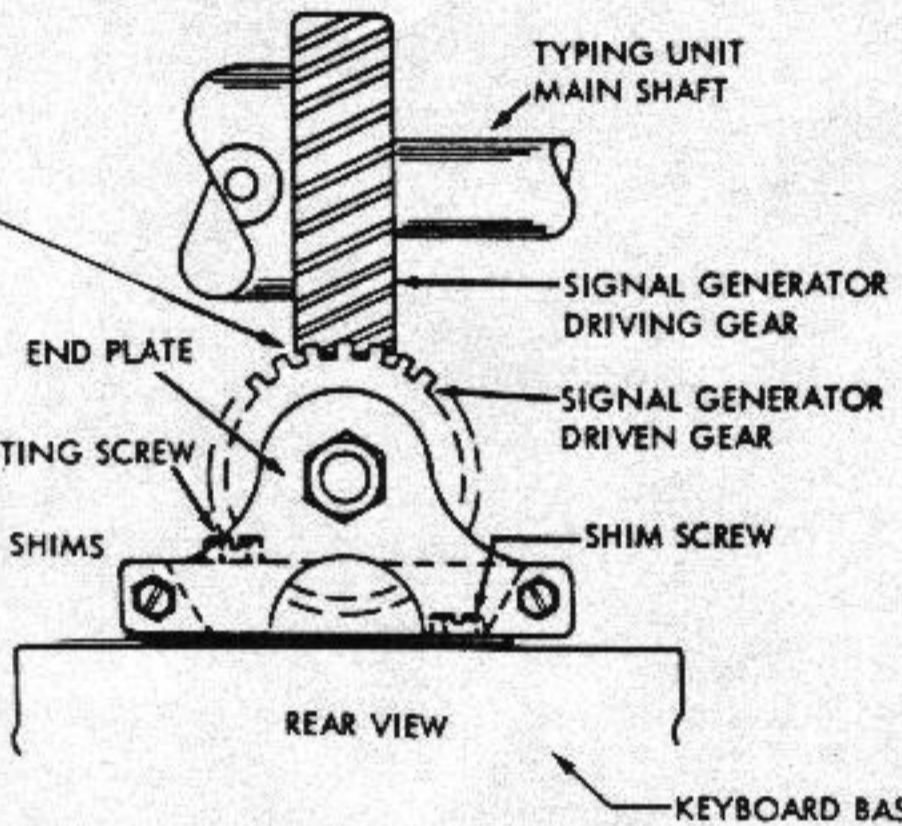

(C) CLUTCH STOP LEVER SPRING TENSION
REQUIREMENT
 CLUTCH ENGAGED AND ROTATED 1/4 TURN.
 MIN. 2 OZS.
 MAX. 3 OZS.
 TO START LEVER MOVING.

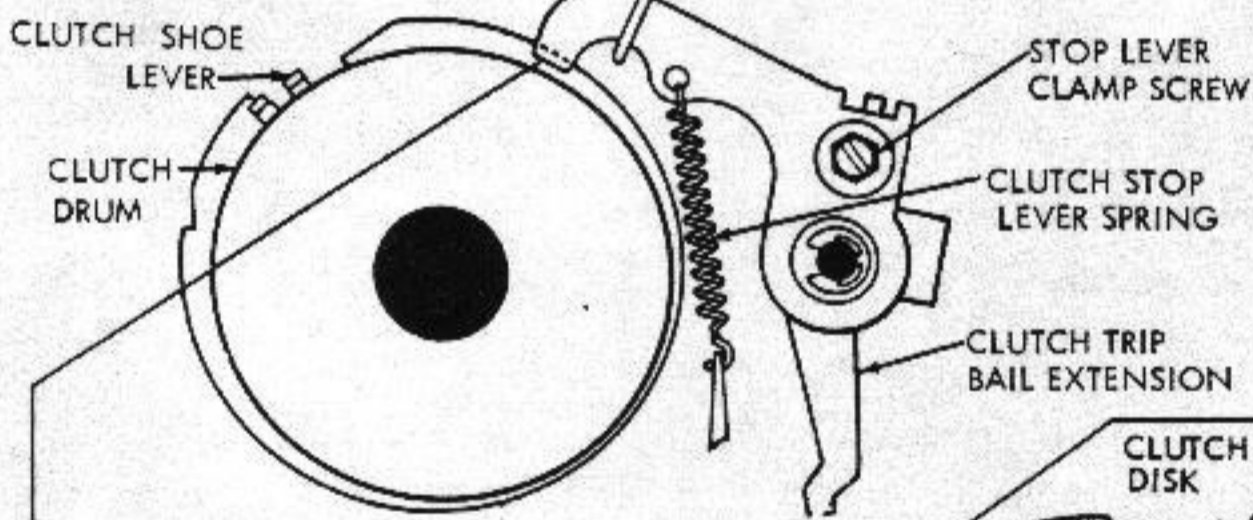

(B) CLUTCH STOP LEVER
REQUIREMENT
 SHOULD FULLY ENGAGE CLUTCH SHOE LEVER. DURING ROTATION, THE LEVER SHOULD NOT TOUCH THE CLUTCH DRUM AT ANY POINT.
 TO ADJUST
 POSITION STOP LEVER WITH ITS CLAMP SCREW LOOSENED.

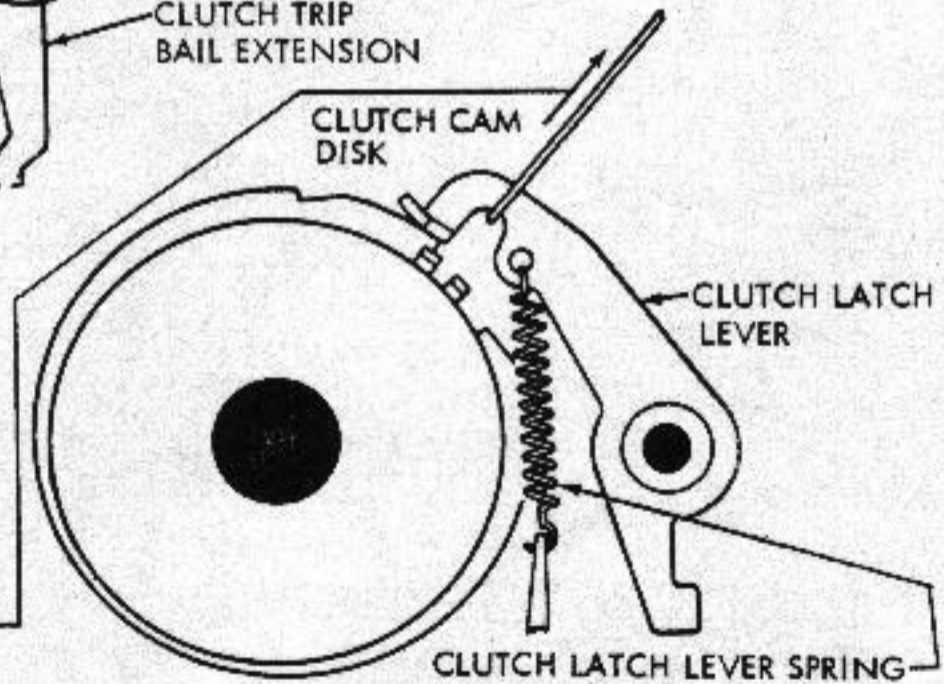

(D) CLUTCH LATCH LEVER SPRING TENSION
REQUIREMENT
 CLUTCH LATCH LEVER RESTING ON THE HIGHEST POINT OF CLUTCH DISK.
 MIN. 2 OZS.
 MAX. 3 OZS.
 TO START LATCH LEVER MOVING.

CLUTCH DRUM POSITION SEE FIGURE 5-19
CLUTCH SHOE LEVER SPRING TENSION SEE FIGURE 5-19
CLUTCH SHOE SPRING TENSION SEE FIGURE 5-19

(Courtesy of Teletype Corp.)

Keyboard, Signal Generator Clutch

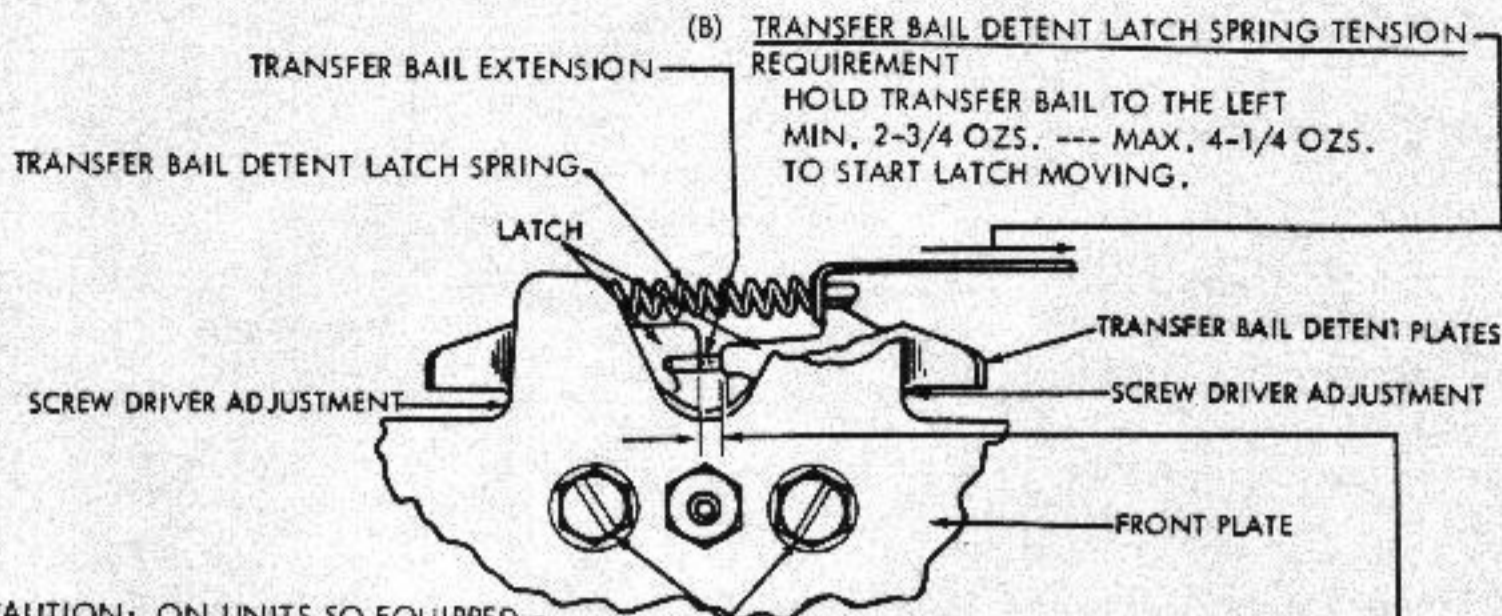

(B) TRANSFER BAIL DETENT LATCH SPRING TENSION REQUIREMENT
 HOLD TRANSFER BAIL TO THE LEFT
 MIN. 2-3/4 OZS. --- MAX. 4-1/4 OZS.
 TO START LATCH MOVING.

CAUTION: ON UNITS SO EQUIPPED -
 CLEAN GOLD CONTACTS BY PULLING
 TWILL JEAN HALF WAY THROUGH THE
 CLOSED CONTACTS, OPEN CONTACTS
 AND REMOVE TWILL JEAN.
 USE NO OTHER CLEANING OR
 BURNISHING METHODS. AVOID PITTING OR
 CHIPPING THE CONTACTS.

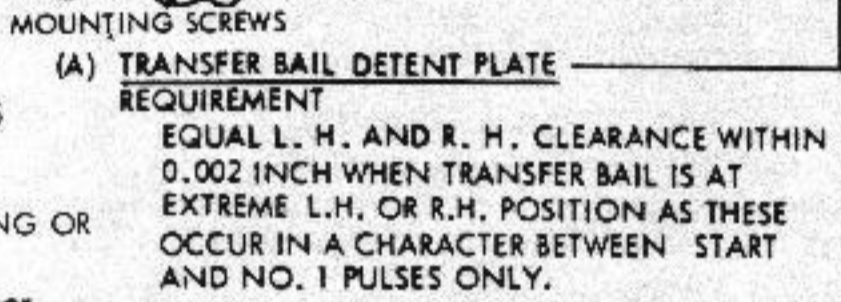

(A) TRANSFER BAIL DETENT PLATE REQUIREMENT
 EQUAL L. H. AND R. H. CLEARANCE WITHIN
 0.002 INCH WHEN TRANSFER BAIL IS AT
 EXTREME L.H. OR R.H. POSITION AS THESE
 OCCUR IN A CHARACTER BETWEEN START
 AND NO. 1 PULSES ONLY.

(C) CONTACT BOX CONTACT CLEARANCE REQUIREMENT
 MARKING AND SPACING GAPS SHOULD BE EQUAL WITHIN 0.001 INCH.
TO CHECK
 DEPRESS Y KEYLEVER AND ROTATE SIGNAL GENERATOR CAM SLEEVE UNTIL EACH CONTACT HAS FULLY OPENED.
TO ADJUST
 LOOSEN MOUNTING SCREWS AND MOVE CONTACT BOX BY MEANS OF ECCENTRIC.
NOTE
 CHECK BY MEANS OF SIGNAL CHECKING DEVICE WHERE POSSIBLE, AND CAREFULLY RE-FINE THE ADJUSTMENT TO ELIMINATE ALL BIAS FROM THE SIGNALS BY EQUALIZING THE CURRENT-ON AND CURRENT-OFF INTERVALS.

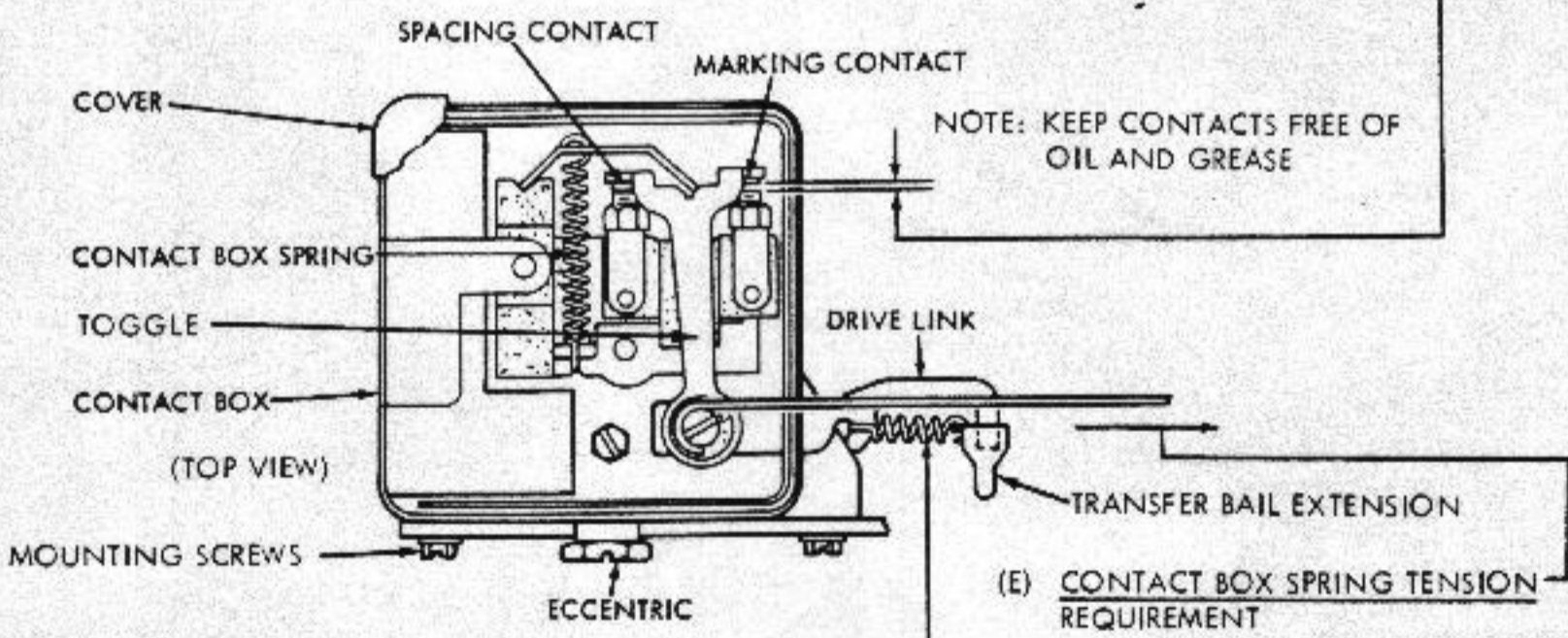

NOTE: KEEP CONTACTS FREE OF OIL AND GREASE

(D) CONTACT BOX DRIVE LINK SPRING TENSION REQUIREMENT
 WITH MAINSHAFT IN STOP POSITION AND TRANSFER BAIL DETENT LATCH SPRING UNHOOKED (SEE FIG. ABOVE) MOVE LATCHES AWAY FROM TRANSFER BAIL EXTENSION. HOLD THE TOGGLE FIRMLY AGAINST CONTACTS.
 MIN. 6 OZS. --- MAX. 9 OZS.
 TO START TRANSFER BAIL EXTENSION MOVING.

(E) CONTACT BOX SPRING TENSION REQUIREMENT
 WITH MAIN SHAFT IN STOP POSITION AND COVER OF CONTACT BOX REMOVED, UNHOOK THE DRIVE LINK SPRING AND HOLD TRANSFER BAIL CLEAR OF DRIVE LINK
 MIN. 2 OZS.
 MAX. 3 OZS.
 TO START LINK MOVING.

d. TYPING UNIT - LP77YD/AGM, LP77YD/AJV AND LP124YD/AJU

NOTE: TO FACILITATE MAKING THE FOLLOWING ADJUSTMENTS, REMOVE THE RANGE FINDER AND SELECTOR MAGNET ASSEMBLIES. TO INSURE BETTER OPERATION, PULL A PIECE OF BOND PAPER BETWEEN THE ARMATURE AND THE POLE PIECES TO REMOVE ANY OIL OR FOREIGN MATTER THAT MAY BE PRESENT. MAKE CERTAIN THAT NO LINT OR PIECES OF PAPER REMAIN BETWEEN THE POLE PIECES AND ARMATURE.

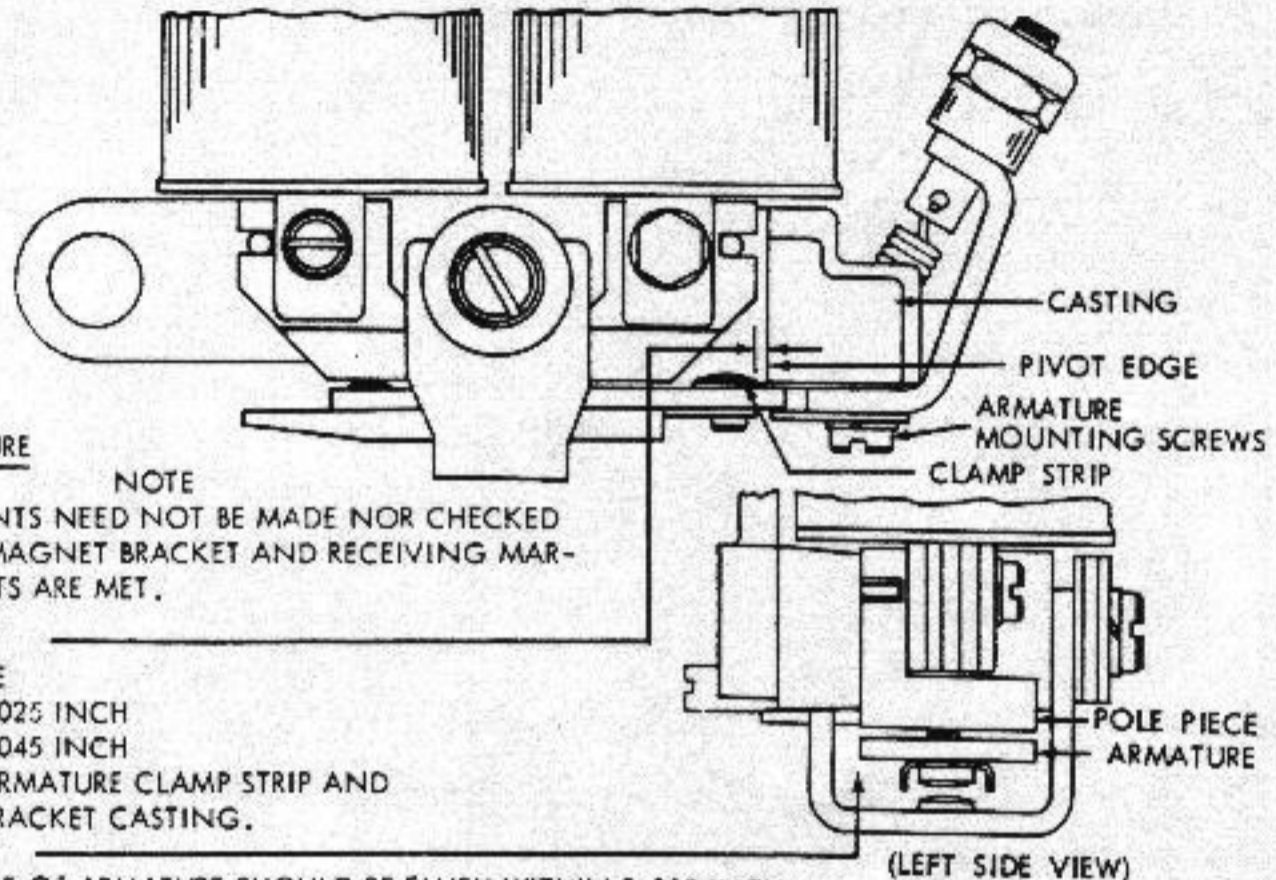

SELECTOR ARMATURE

NOTE

THESE REQUIREMENTS NEED NOT BE MADE NOR CHECKED IF THE SELECTOR MAGNET BRACKET AND RECEIVING MARGIN REQUIREMENTS ARE MET.

(1) REQUIREMENT
CLEARANCE

MIN. 0.025 INCH
MAX. 0.045 INCH

BETWEEN ARMATURE CLAMP STRIP AND
MAGNET BRACKET CASTING.

(2) REQUIREMENT

OUTER EDGE OF ARMATURE SHOULD BE FLUSH WITHIN 0.015 INCH
WITH OUTER EDGE OF POLE PIECES.

(3) REQUIREMENT

START LEVER SHALL DROP FREELY INTO ARMATURE EXTENSION SLOT.

TO ADJUST

POSITION ARMATURE SPRING ADJUSTING NUT TO HOLD ARMATURE FIRMLY AGAINST PIVOT
EDGE OF CASTING. POSITION ARMATURE WITH MOUNTING SCREWS LOOSEMED.

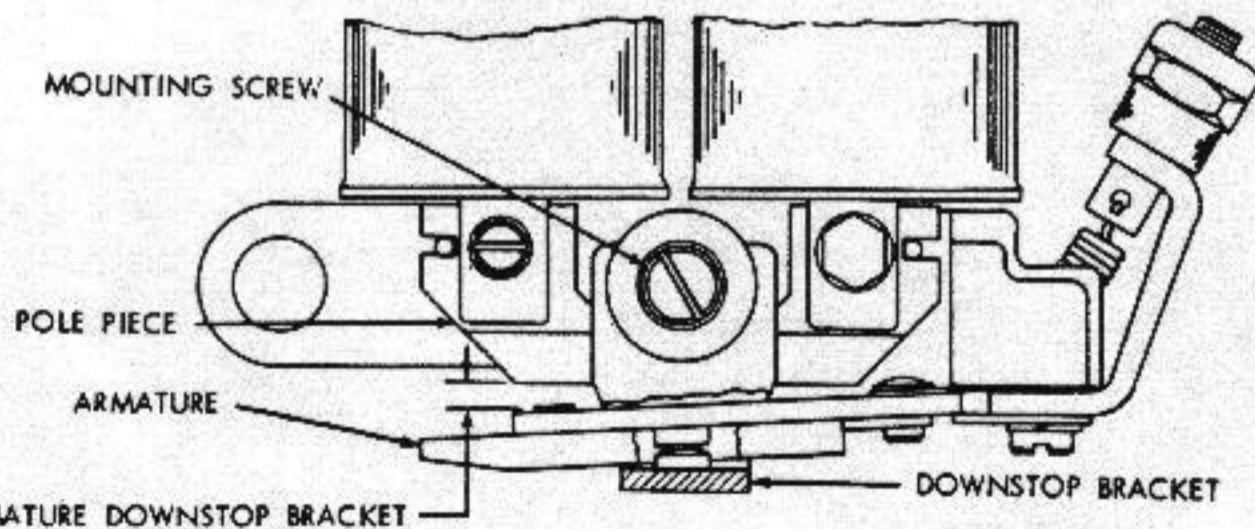

SELECTOR ARMATURE DOWNSTOP BRACKET

REQUIREMENT

REMOVE OIL SHIELD. WITH MAGNET DE-ENERGIZED, LOCK LEVERS ON HIGH PART OF
THEIR CAM, AND ARMATURE RESTING AGAINST ITS DOWNSTOP, CLEARANCE BETWEEN
END OF ARMATURE AND LEFT EDGE OF LEFT POLE PIECE.

MIN. 0.025 INCH
MAX. 0.030 INCH

TO ADJUST

POSITION DOWNSTOP BRACKET WITH MOUNTING SCREW LOOSEMED.

(Courtesy of
Teletype Corp.)

SELECTOR ARMATURE SPRING

(FOR UNITS EMPLOYING SELECTOR ARMATURE WITH SINGLE ANTI-FREEZE BUTTON ONLY).

REQUIREMENT (PRELIMINARY)

WITH LOCKING LEVERS AND START LEVER ON HIGH PART OF THEIR CAMS, SCALE APPLIED AS NEARLY VERTICAL AS POSSIBLE UNDER END OF ARMATURE EXTENSION. IT SHALL REQUIRE THE FOLLOWING TENSIONS TO MOVE ARMATURE TO MARKING POSITION:

0.035 AMPERES

MIN. 1-1/2 OZS. --- MAX. 2 OZS.

NOTE

THIS SPRING CAN BE ADJUSTED FOR MAXIMUM SELECTOR PERFORMANCE ONLY WHEN PRINTER IS CONNECTED TO THE SPECIFIC CIRCUIT OVER WHICH IT IS TO OPERATE UNDER SERVICE CONDITIONS. SINCE THERE ARE SEVERAL OPERATING SPEEDS AND SINCE CIRCUITS VARY WIDELY, IT IS IMPOSSIBLE TO ADJUST SPRING FOR MAXIMUM PERFORMANCE AT THE FACTORY. THE FOREGOING SPRING TENSION REQUIREMENT IS GIVEN TO PERMIT OPERATION PRIOR TO MEASUREMENT OF RECEIVING MARGINS. READJUSTMENT MADE TO OBTAIN SATISFACTORY RECEIVING MARGIN SHOULD NOT BE DISTURBED IN ORDER TO MEET REQUIREMENTS OF THIS ADJUSTMENT.

TO ADJUST
POSITION ADJUSTING NUT.

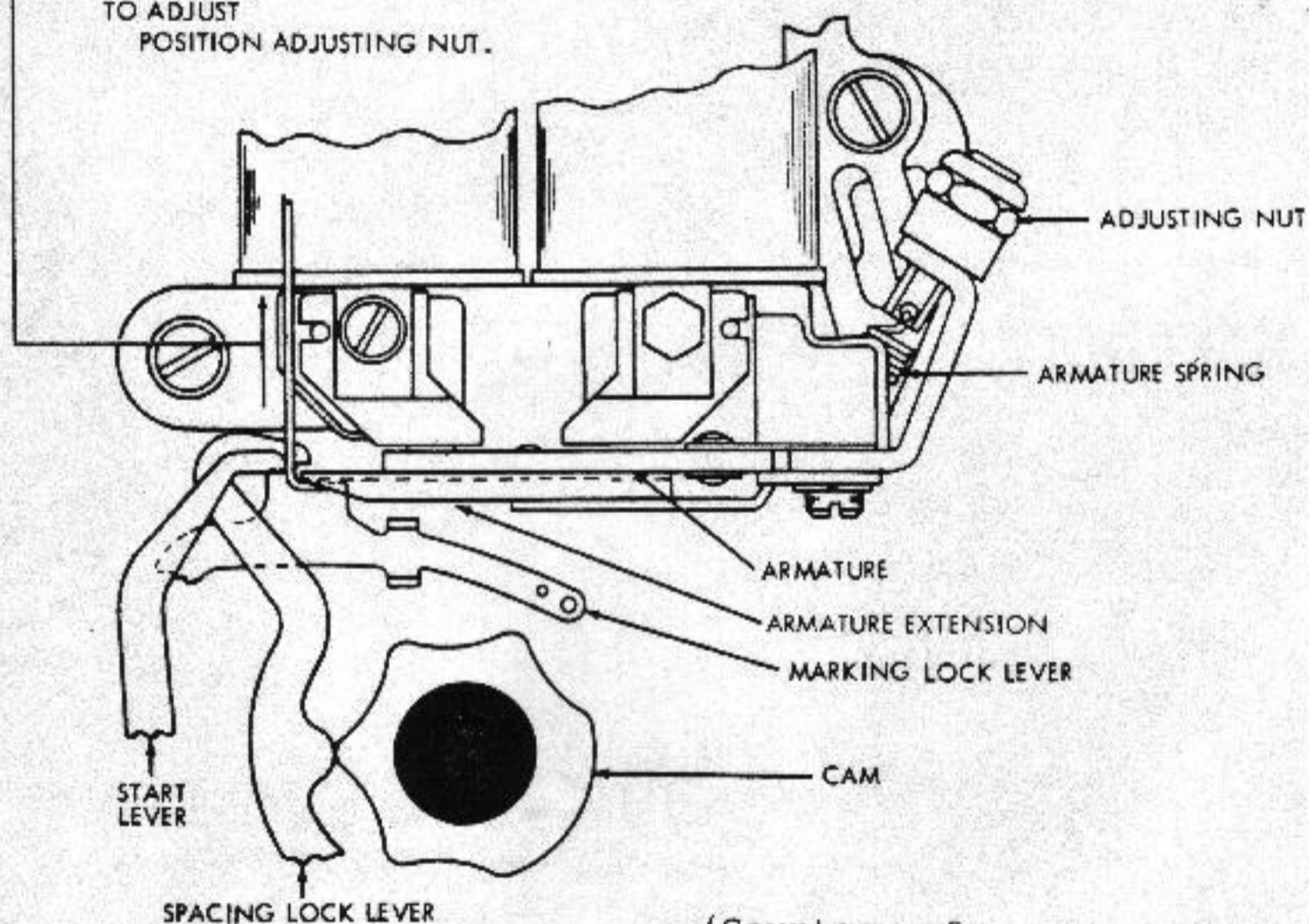

(Courtesy of
Teletype Corp.)

REQUIREMENT (FINAL)

SEE SELECTOR RECEIVING MARGIN ADJUSTMENT
FIGURE 5-9.

Typing Unit, Selector Spring Tension

SELECTOR ARMATURE SPRING
 (FOR UNITS EMPLOYING SELECTOR ARMATURE WITH TWO ANTI-FREEZE BUTTONS ONLY).
 REQUIREMENT (PRELIMINARY)
 WITH LOCKING LEVERS AND START LEVER ON HIGH PART OF THEIR CAMS, SCALE APPLIED
 AS NEARLY VERTICAL AS POSSIBLE UNDER END OF ARMATURE EXTENSION. IT SHALL REQUIRE
 APPROXIMATELY THE FOLLOWING TENSIONS TO MOVE THE REAR ANTI-FREEZE BUTTON AGAINST
 THE MAGNET CORE:
 0.035 AMPERES
 APPROXIMATELY 5/8 OZ.

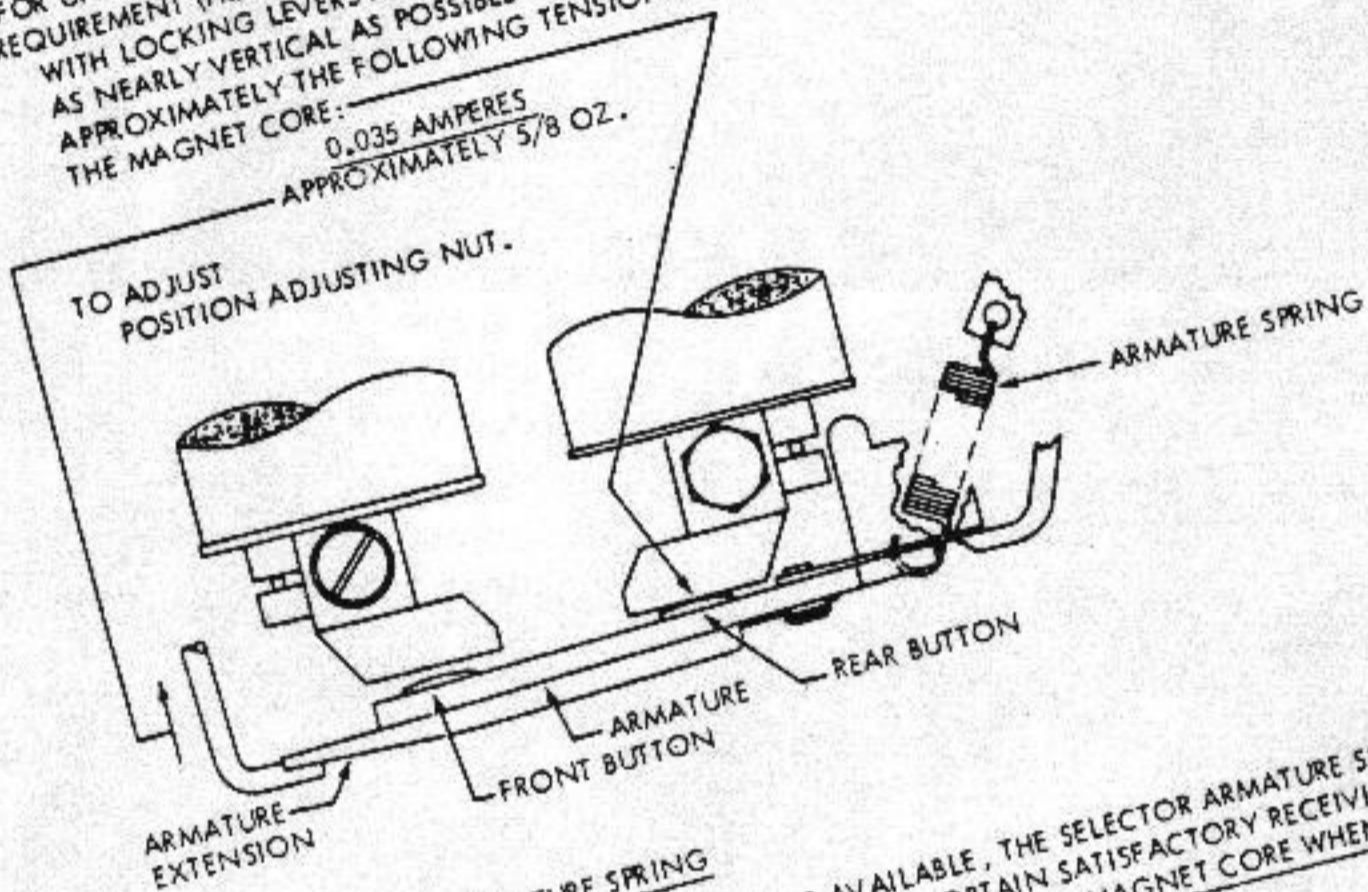

SELECTOR ARMATURE SPRING
 REQUIREMENT (FINAL)
 WHEN A DISTORTION TEST SET IS AVAILABLE, THE SELECTOR ARMATURE SPRING TENSION
 SHOULD BE REFINED, IF NECESSARY, TO OBTAIN SATISFACTORY RECEIVING MARGINS. THE
 FRONT ANTI-FREEZE BUTTON MUST CONTACT THE MAGNET CORE WHEN THE MAGNET COILS
 ARE ENERGIZED.

(SEE SELECTOR RECEIVING MARGIN
 ADJUSTMENT FIGURE 5-9)

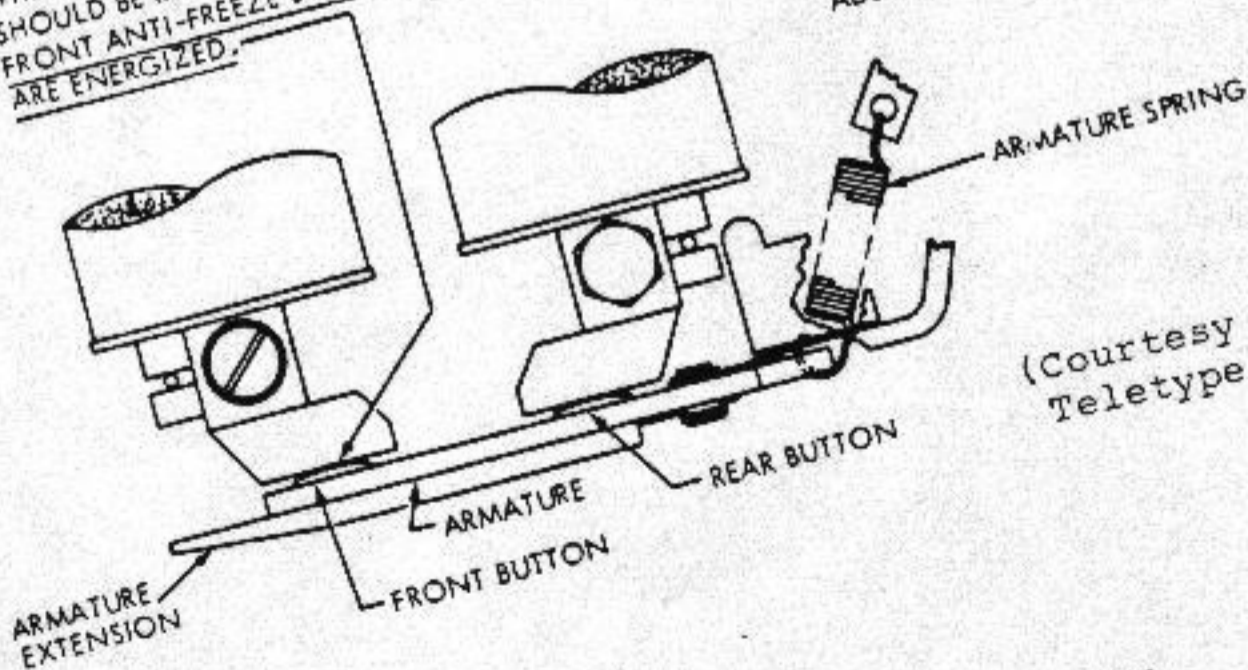

(Courtesy of
 Teletype Corp.)

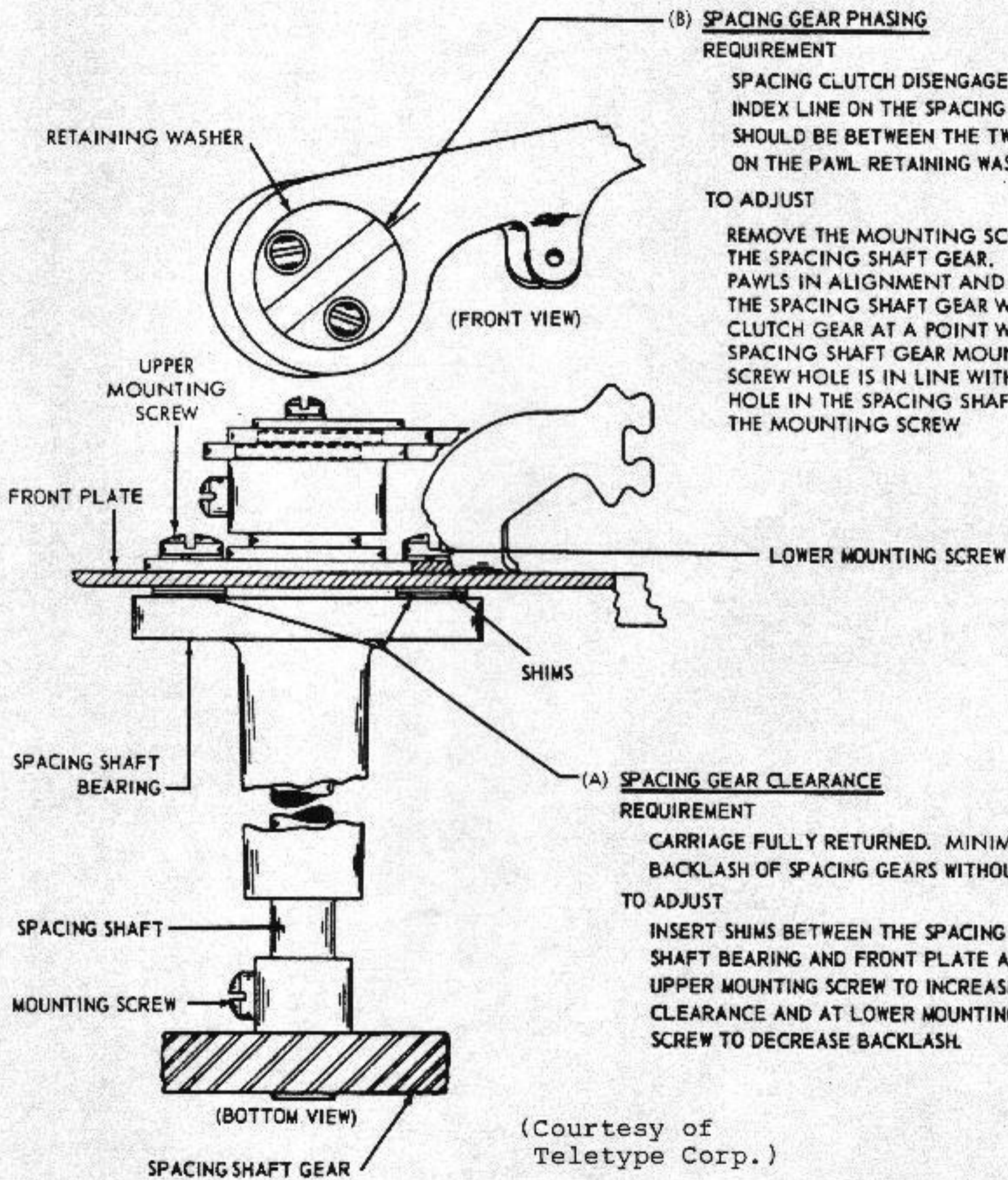

(Courtesy of Teletype Corp.)

LINE-FEED BARS ENGAGED

LINE FEED CLUTCH PHASING

REQUIREMENT

LINE FEED CLUTCH DISENGAGED, BOTH LINE-FEED BARS SHOULD ENGAGE TEETH OF LINE FEED SPUR GEAR.

TO ADJUST

LOOSEN ASSEMBLY BEARING POST, MESH LINE FEED ECCENTRIC SPUR GEAR WITH CLUTCH GEAR.

LINE FEED SPUR GEAR

ECCENTRIC BEARING

ASSEMBLY BEARING POST

LEFT SIDE FRAME

LINE FEED ECCENTRIC SPUR GEAR

ROCKER SHAFT LEFT BRACKET

REQUIREMENT

ROCKER SHAFT LEFT BRACKET FIRMLY SEATED AGAINST INNER BEARING RACE.

TO ADJUST

HOLD ROCKER SHAFT IN EXTREME LEFT POSITION AND POSITION THE BRACKET AGAINST THE INNER BEARING RACE WITH MOUNTING SCREWS LOOSENED

INNER BEARING RACE

MOUNTING SCREWS

ROCKER SHAFT

BALL BEARING

LEFT SIDE FRAME

ROCKER SHAFT LEFT BRACKET

(Courtesy of Teletype Corp.)

Typing Unit, Line Feed and Rocker Shaft Mechanisms

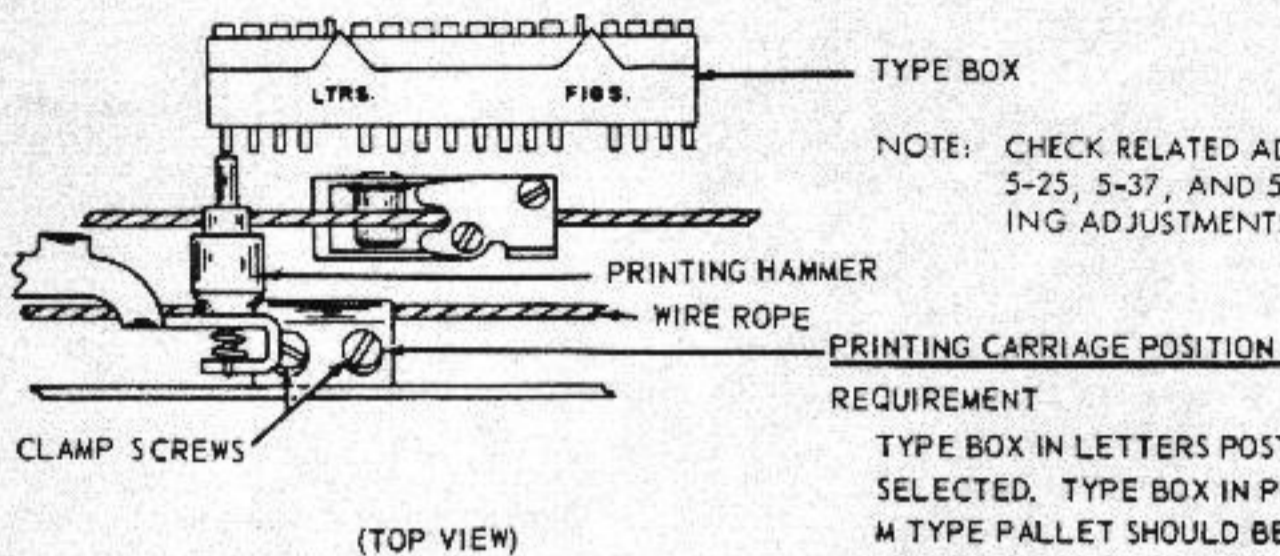

TYPE BOX

NOTE: CHECK RELATED ADJUSTMENTS, FIGURES 5-25, 5-37, AND 5-38, IF THE FOLLOWING ADJUSTMENTS ARE REMADE.

PRINTING HAMMER

WIRE ROPE

PRINTING CARRIAGE POSITION

CLAMP SCREWS

REQUIREMENT

TYPE BOX IN LETTERS POSITION. M TYPE PALLET SELECTED. TYPE BOX IN PRINTING POSITION. M TYPE PALLET SHOULD BE APPROXIMATELY IN CENTER OF PRINTING HAMMER WHEN HAMMER IS JUST TOUCHING M TYPE PALLET. TAKE UP PLAY IN TYPE BOX CARRIAGE IN EACH DIRECTION AND SET HAMMER IN CENTER OF PLAY

TO ADJUST

POSITION PRINTING CARRIAGE ON WIRE ROPE WITH CLAMP SCREWS LOOSENED.

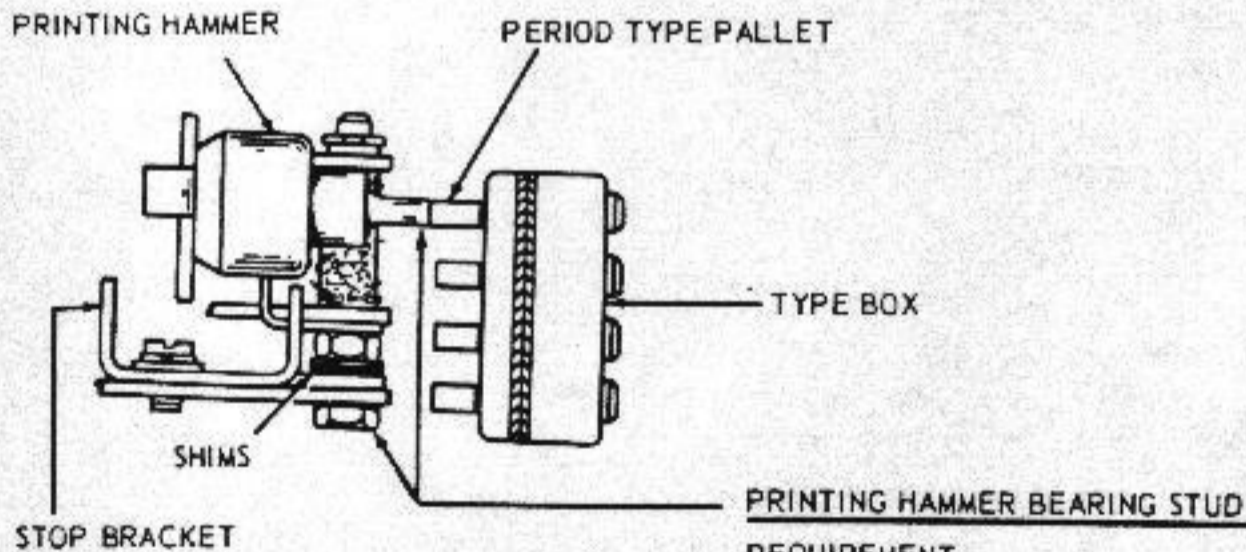

REQUIREMENT

TYPE BOX AT MIDPOINT OF PLATEN AND IN POSITION TO PRINT PERIOD. PRINTING HAMMER IN CONTACT WITH TYPE PALLET AND PRESSED DOWNWARD AT BEARING POST. FACE OF HAMMER SHOULD BE FULLY ON END OF TYPE PALLET.

TO ADJUST

ADD OR REMOVE SHIMS BETWEEN SHOULDER ON BEARING POST AND STOP BRACKET.

(RIGHT SIDE VIEW)

(Courtesy of Teletype Corp.)

SHIFT LINKAGE

REQUIREMENT

CARRIAGE NEAR MIDPOINT OF PLATEN. TYPE BOX IN POSITION TO PRINT LETTER "O". MANUALLY BUCKLE RIGHT SHIFT LINKAGE. SHIFT TYPE BOX TO LEFT. FIGURE "9" TYPE PALLET SHOULD BE APPROXIMATELY IN CENTER OF PRINT HAMMER WHEN HAMMER IS JUST TOUCHING "9" TYPE PALLET.

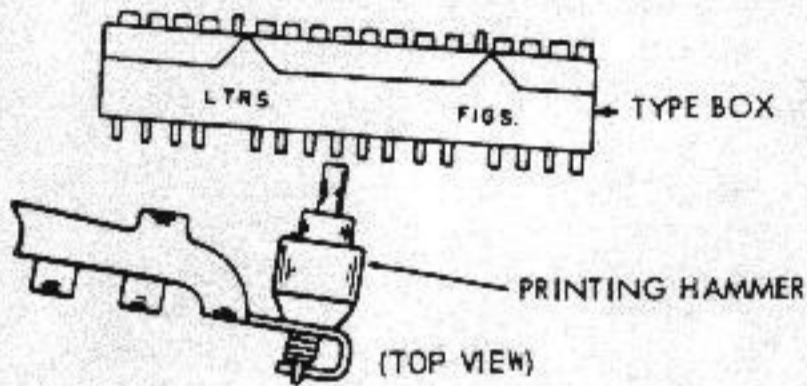

TO ADJUST

POSITION LEFT SHIFT LINKAGE ON OSCILLATOR RAIL WITH TWO CLAMP SCREWS LOOSE

TO RECHECK

SHIFT ALTERNATELY FROM "O" TO "9". TAKE UP PLAY IN EACH DIRECTION. REFINE ADJUSTMENT IF NECESSARY.

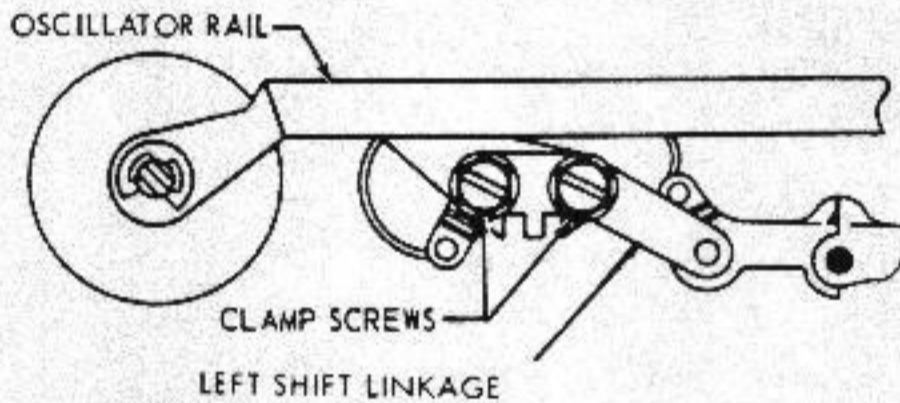

(FRONT VIEW)

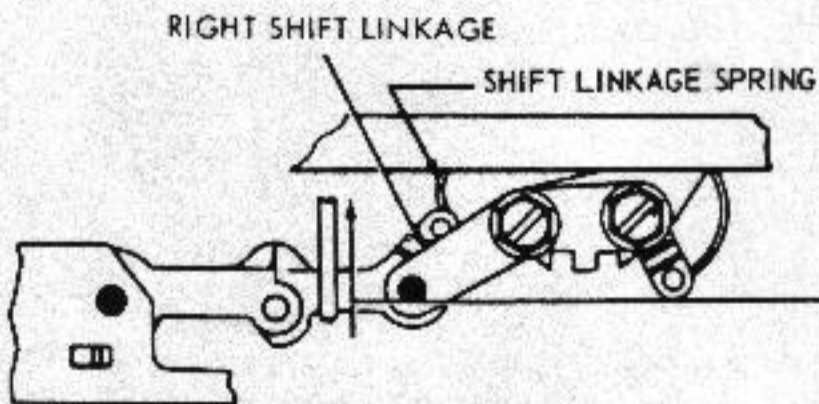

SHIFT LINKAGE SPRING TENSION

REQUIREMENT

LINK IN STRAIGHT POSITION

MIN. 6 OZS.

MAX. 14 OZS.

TO START EACH LINK MOVING.

(Courtesy of
Teletype Corp.)

(A) PRINTING TRACK

REQUIREMENT

PRINTING TRACK IN ITS EXTREME DOWNWARD POSITION. BLANK SELECTION IN FIGURES. PRINTING HAMMER OPERATING BAIL LATCHING EXTENSION HELD WITH LEFT FACE IN LINE WITH THE LATCH SHOULDER. PRINTING ARM SLIDE POSITIONED ALTERNATELY OVER EACH TRACK MOUNTING SCREW. PRINTING BAIL RESET EACH TIME. CLEARANCE BETWEEN LATCHING EXTENSION AND OPERATING BAIL LATCH SHOULD BE

MIN. 0.015 INCH MAX. 0.040 INCH

TO ADJUST

POSITION THE PRINTING TRACK UP OR DOWN WITH ITS MOUNTING SCREWS LOOSENED.

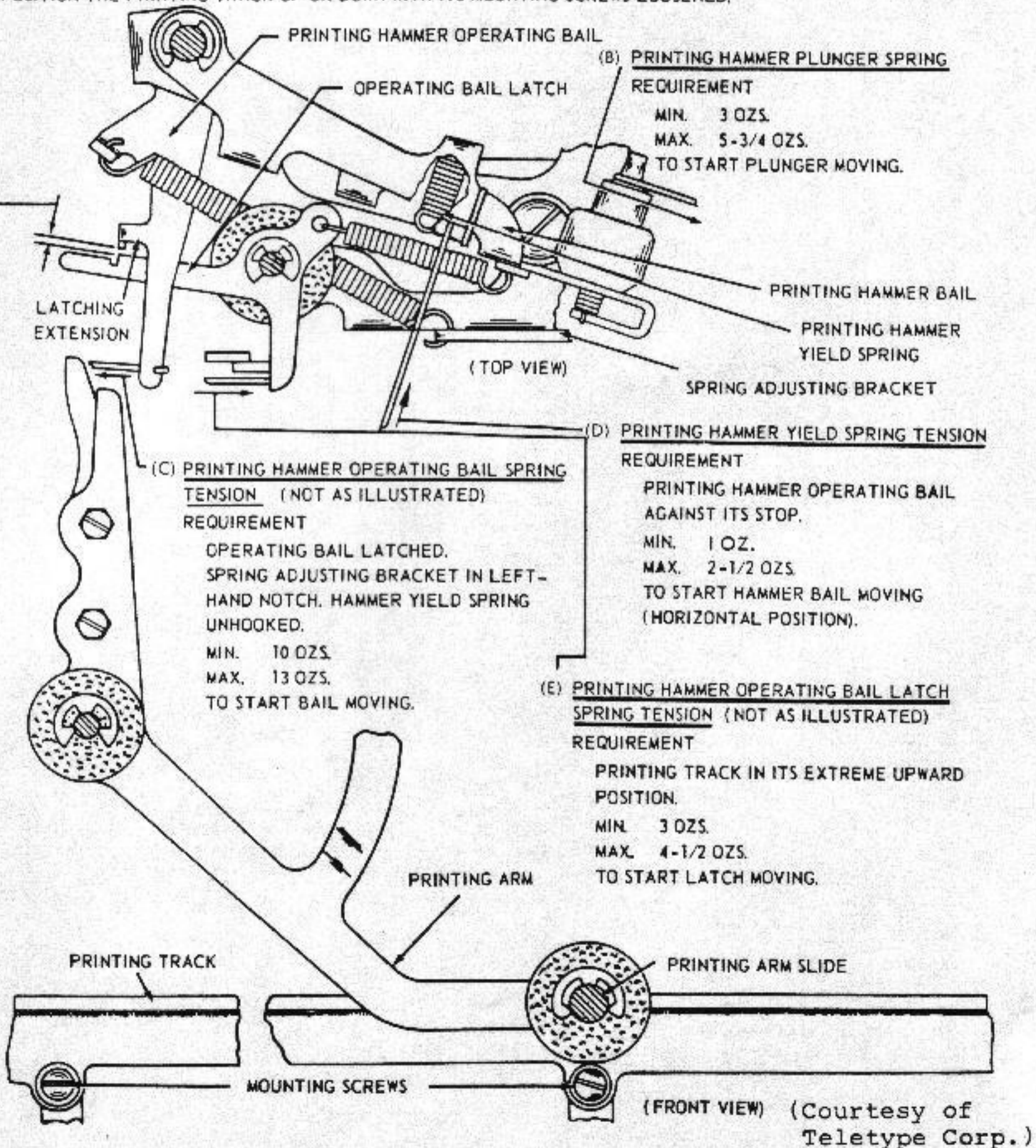

PRINTING HAMMER STOP BRACKET

REQUIREMENT --- WITH TYPE BOX IN POSITION TO PRINT CHARACTER "M", PRINTING TRACK IN ITS MAXIMUM DOWNWARD POSITION, AND PRINTING HAMMER STOP BRACKET HELD TOWARD THE PLATEN WITH PRESSURE OF 8 OZS; CLEARANCE BETWEEN PRINTING HAMMER AND "M" TYPE PALLET. (NOTE 1.) MIN. 0.005 INCH --- MAX. 0.020 INCH AT END OF PLATEN WITH LEAST CLEARANCE TO ADJUST --- POSITION STOP BRACKET BY MEANS OF ITS TWO MOUNTING SCREWS.

NOTE 1. --- CERTAIN MULTIPLE FORM UNITS SHOULD BE REFINED FOR A CLEARANCE OF MIN. 0.005 INCH --- MAX. 0.015 INCH. TO IMPROVE LEGIBILITY OF COPY

TYPE PALLET SPRING TENSION REQUIREMENT

TYPE BOX REMOVED FROM THE UNIT. 8 OZS. SCALE APPLIED VERTICALLY TO THE END OF THE PALLET SHANK. MIN. 1/4 OZS. MAX. 3/4 OZS. TO START PALLET MOVING.

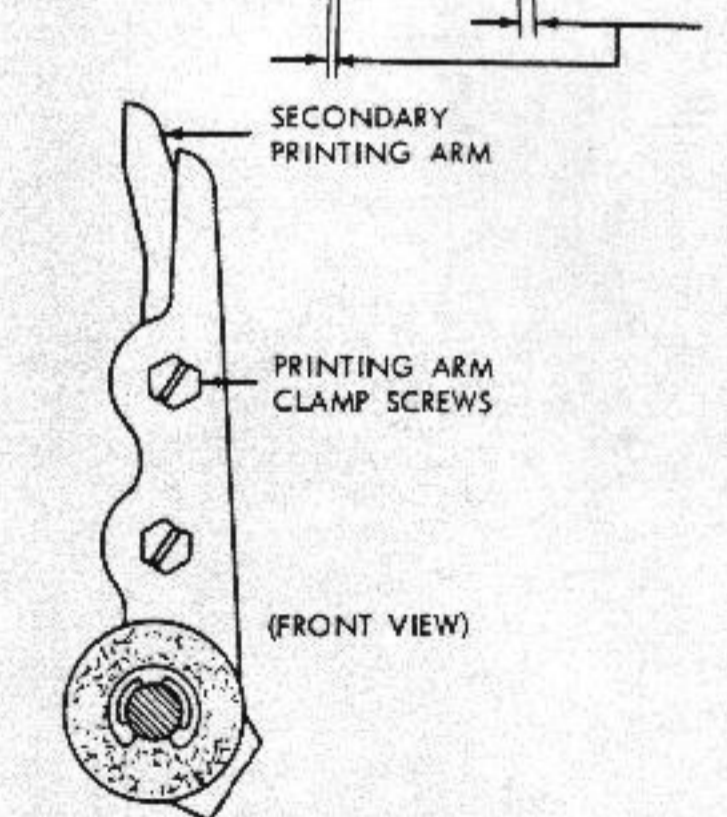
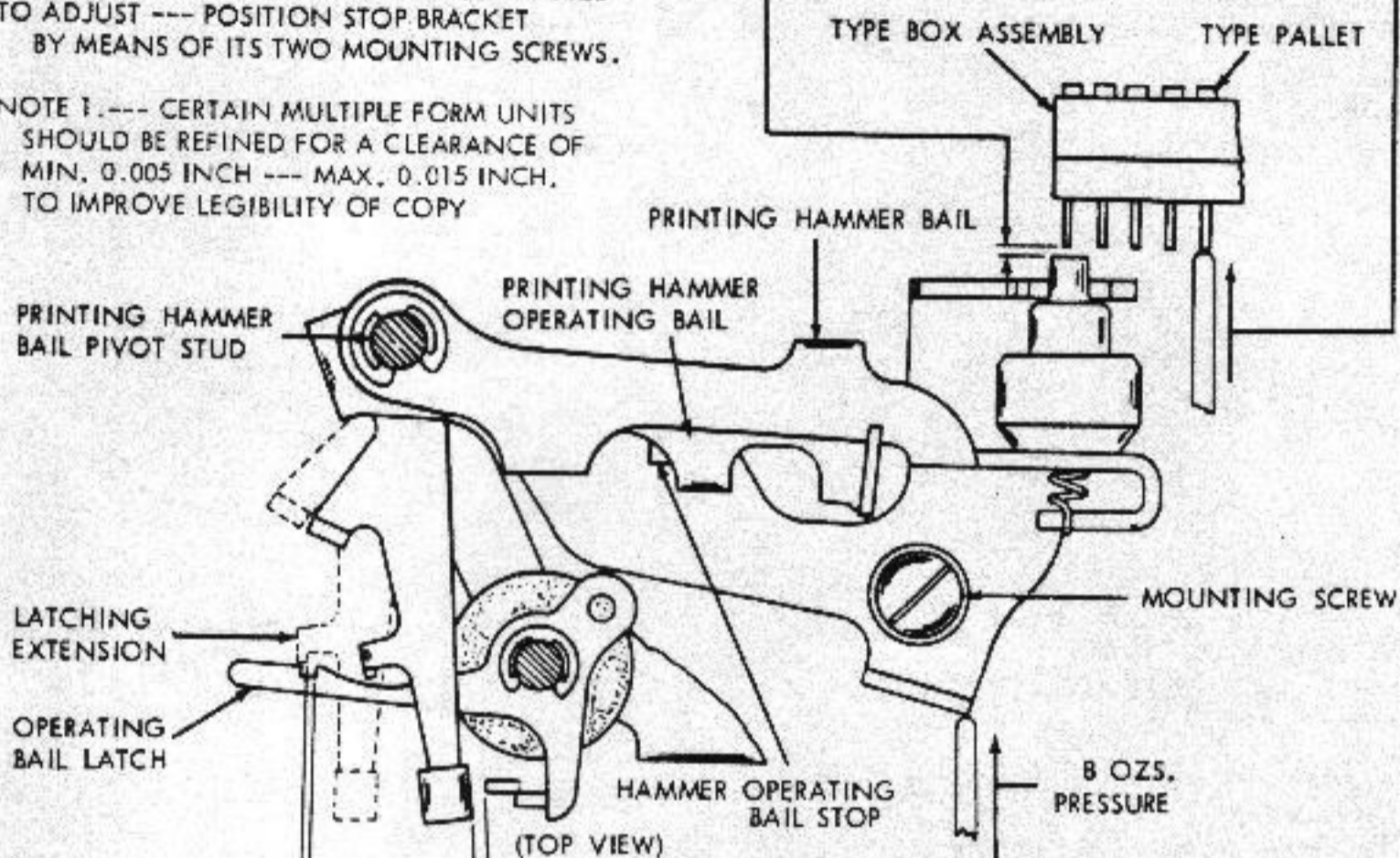

PRINTING ARM

- (1) REQUIREMENT
PRINTING TRACK IN MAXIMUM DOWNWARD POSITION.
PRINTING HAMMER OPERATING BAIL AGAINST ITS STOP.
SOME CLEARANCE BETWEEN SECONDARY PRINTING ARM AND FORWARD EXTENSION OF HAMMER OPERATING BAIL.
MAX. 0.015 INCH
WHEN PRINTING ARM SLIDE IS HELD DOWNWARD OVER EACH PRINTING TRACK MOUNTING SCREW FOR MAXIMUM CLEARANCE.
- (2) REQUIREMENT
PRINTING TRACK IN UPPERMOST POSITION. LATCHING EXTENSION OF PRINTING HAMMER OPERATING BAIL SHOULD OVERTRAVEL LATCHING SURFACE OF OPERATING BAIL LATCH BY MIN. 0.006 INCH
CHECK RIGHT AND LEFT POSITIONS TO ADJUST
POSITION SECONDARY PRINTING ARM WITH CLAMP SCREWS LOOSENED.

NOTE 2

THE PRINTING ARM ADJUSTMENT SHOULD ALWAYS BE MADE WITH THE PRINTING HAMMER OPERATING BAIL SPRING BRACKET IN THE NO. 1 POSITION. POSITIONS NO. 2 AND 3 ARE TO BE USED ONLY FOR MAKING MULTIPLE COPIES.

(Courtesy of Teletype Corp.)

Typing Unit, Printing Mechanism

NOTE: THIS ADJUSTMENT SHOULD BE MADE WITH THE TYPE BOX IN ITS UPPER POSITION.

NOTE: RECHECK PRINT HAMMER STOP BRACKET ADJUSTMENT, FIGURE 5-43 AND READJUST IF NECESSARY

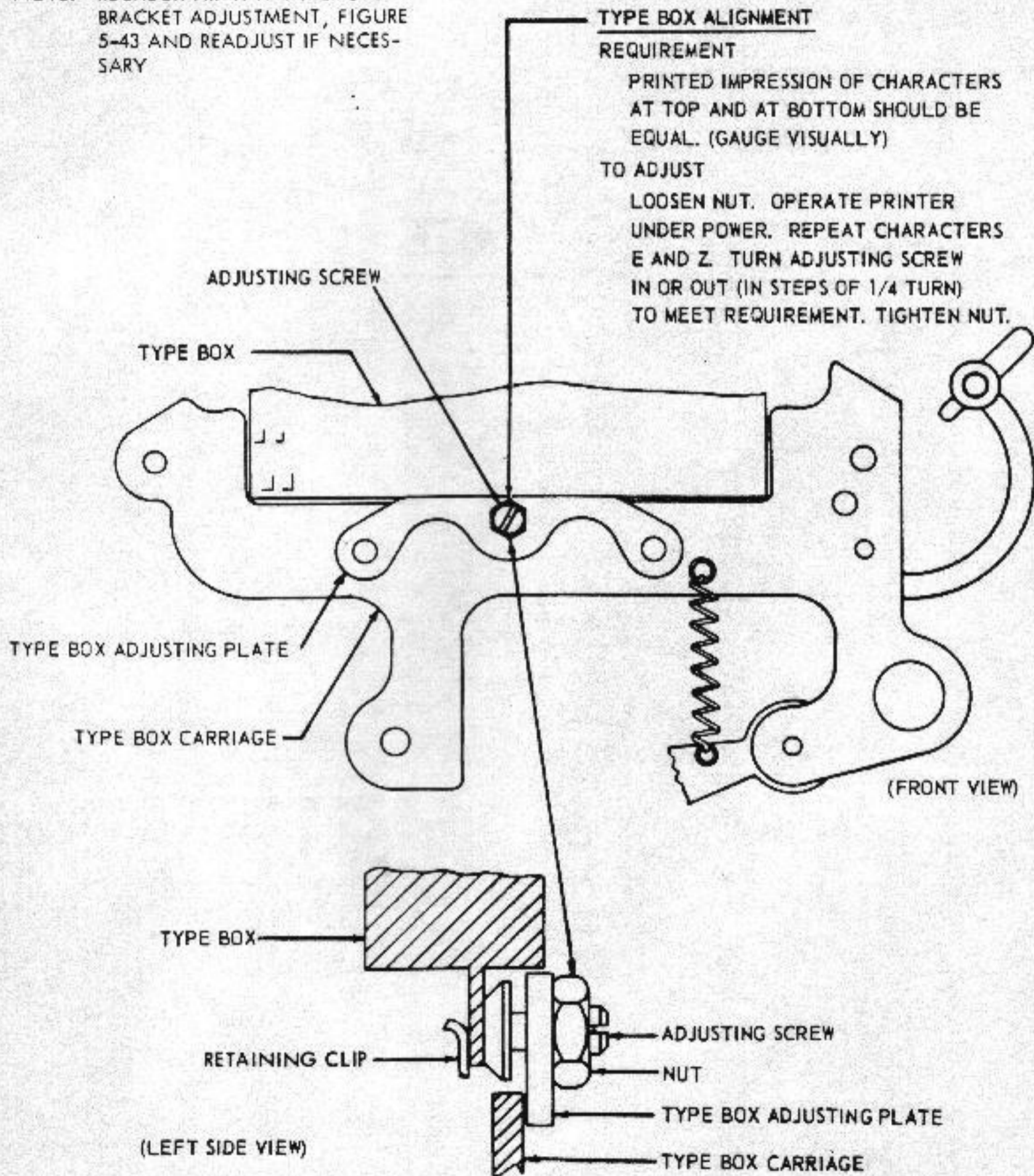

(Courtesy of Teletype Corp.)

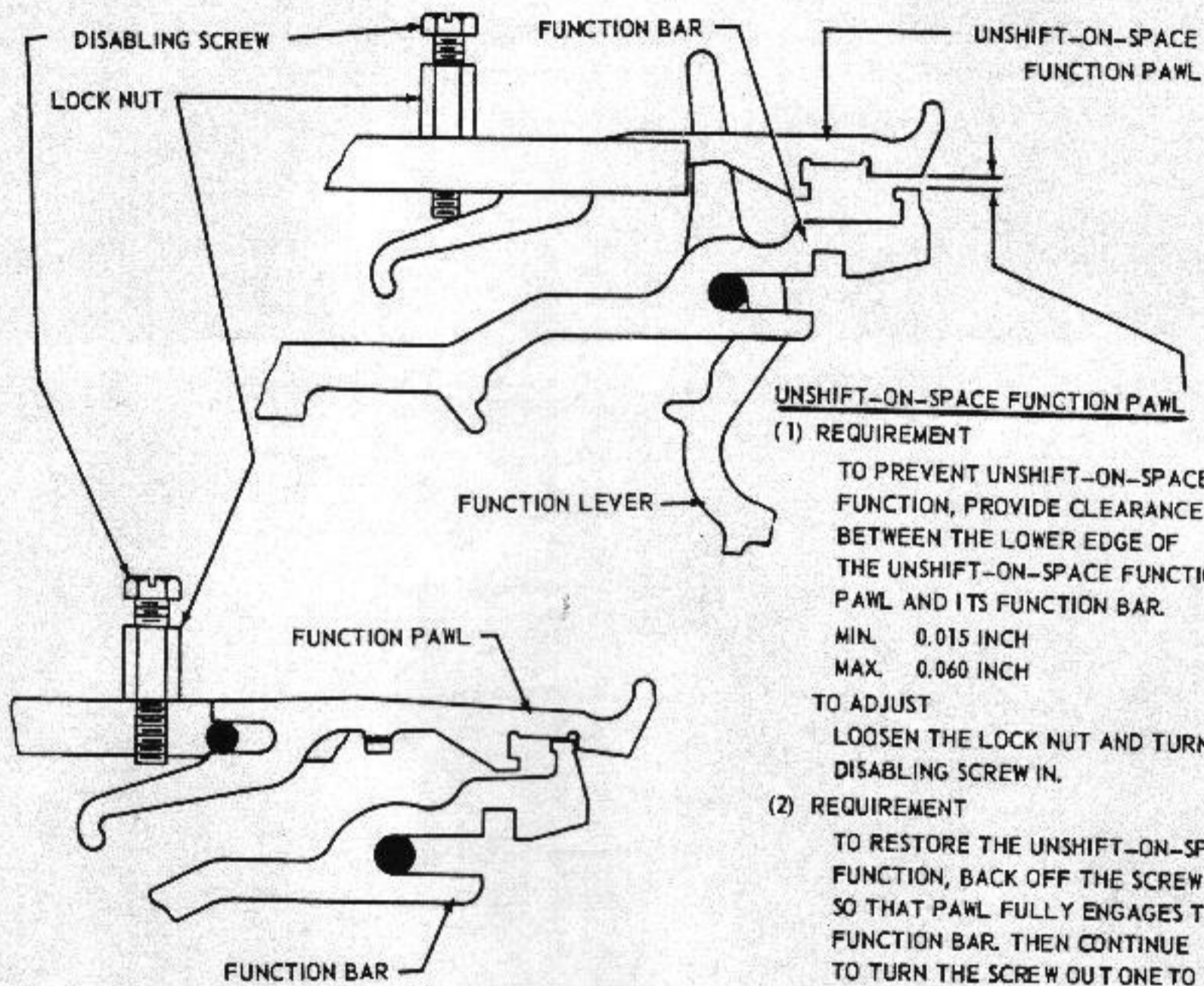

(Courtesy of Teletype Corp.)

THE MODEL 32 TELETYPE ^R

Registered trademark of the Teletype Corporation

CONTENTS

Page

A. Preparation for Connection to an Acoustical Coupler	M32-3
B. Some Common Troubles	M32-9
C. Replacing the Motor Drive Belt	M32-25
D. Removing the Typing Unit	M32-27
E. Removing and Installing the Carriage	M32-29
F. Replacing the Motor Driven Gear and Pinion	M32-33
G. Adjusting Uniformity of Printed Characters	M32-37
H. Removing the Distributor Assembly	M32-41
I. Removing the Mainshaft	M32-45
J. Reinstalling the Mainshaft	M32-55
K. Codebar Adjustments	M32-59
L. Armature Bracket Adjustments	M32-61
M. Blocking Lever Position Adjustment	M32-63
N. Platen Adjustment	M32-65
O. Carriage Rear Rail Alignment	M32-67
P. Carriage Return Adjustment	M32-69
Q. Left and Right Rocker Arm Adjustments	M32-71
R. Miscellaneous Model 32 Information	M32-72

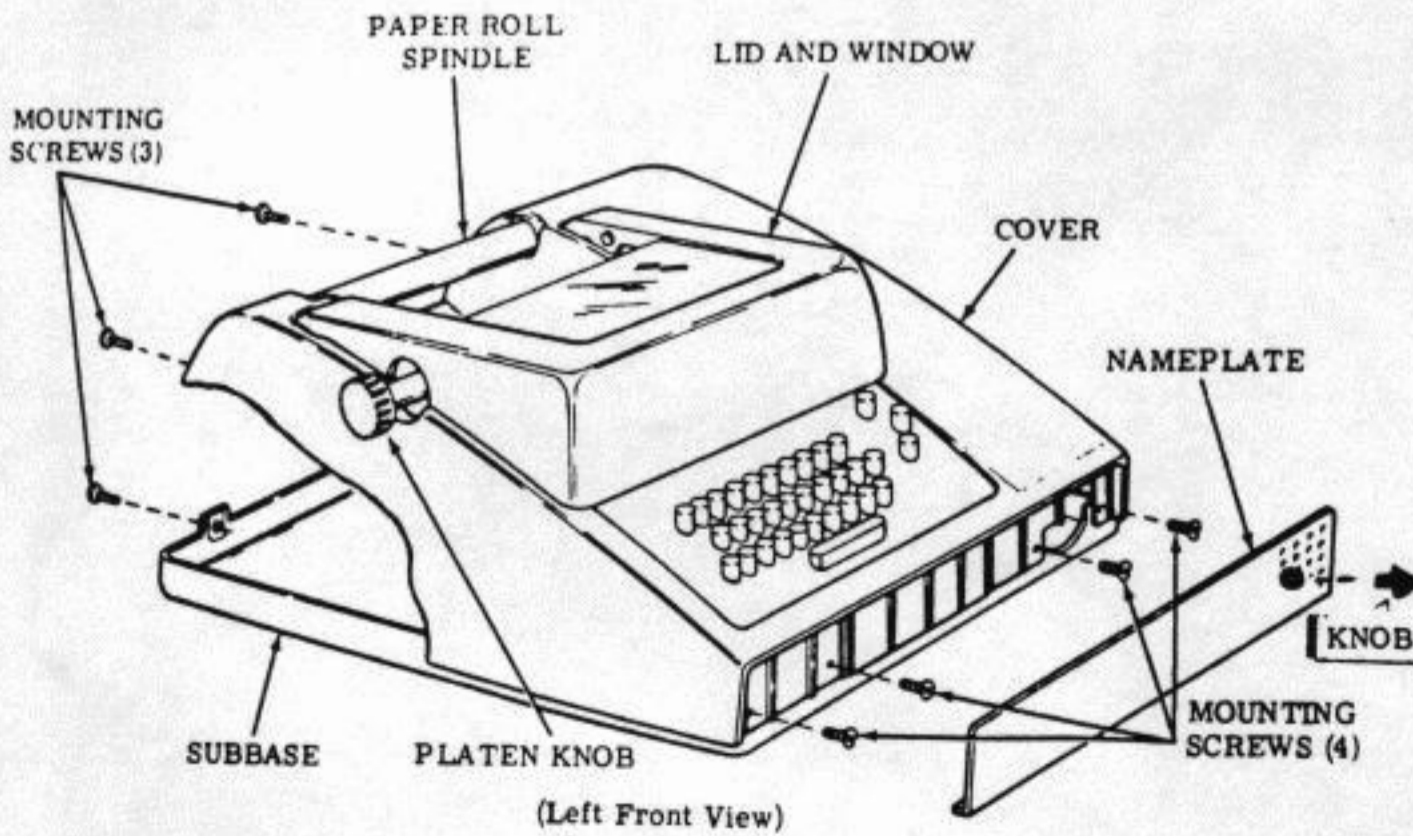
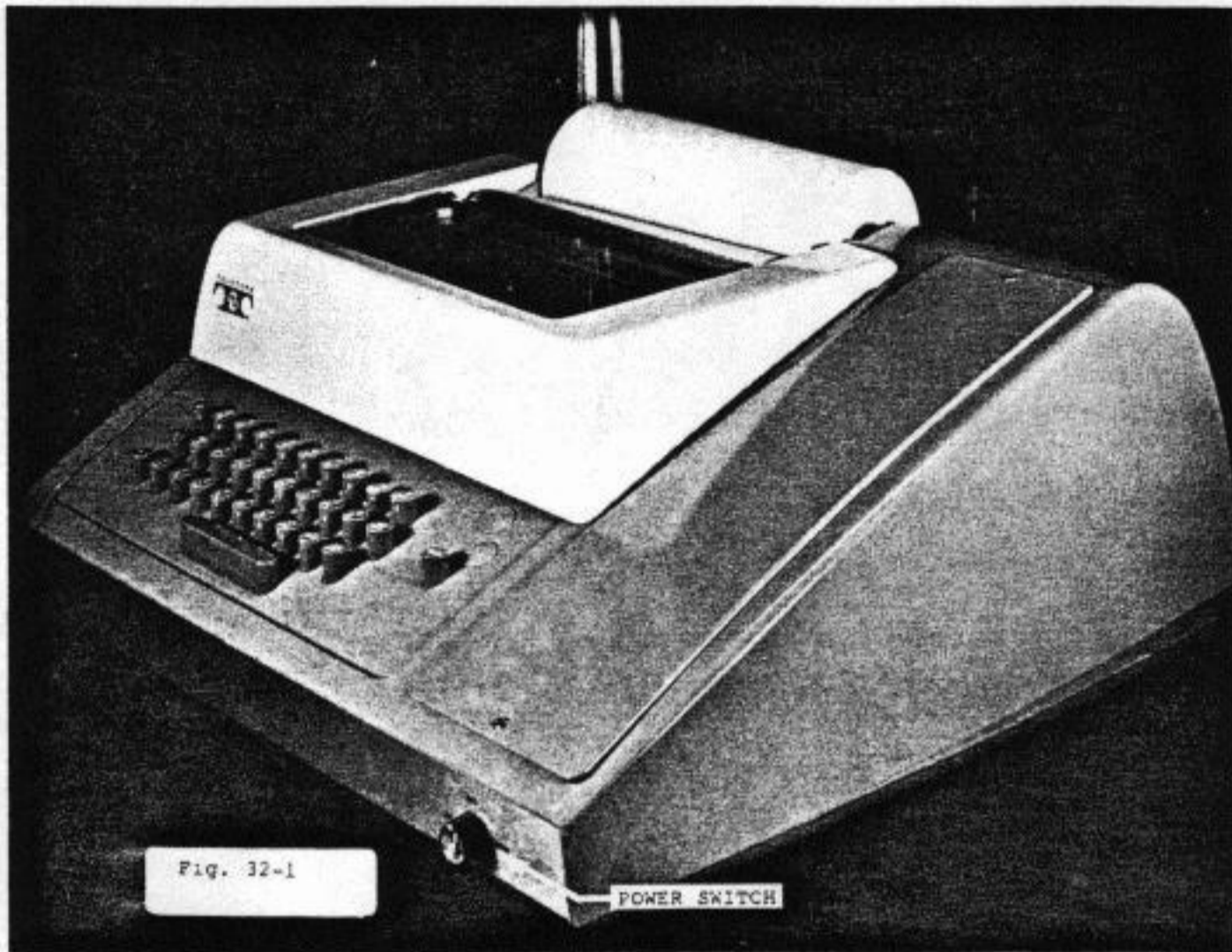

Fig. 32-2

MODEL 32

A. PREPARATION FOR CONNECTION TO AN ACOUSTICAL COUPLER

1. Fig. 32-1 shows the appearance of a Model 32. Be sure it is unplugged.
2. Fig. 32-2 shows the disconnecting procedure for removal of the cover.
 - a) Remove the two knobs.
 - b) Pull down the nameplate.
 - c) Remove the 7 mounting screws (4 in front & 3 in back).
 - d) Remove the paper roll.
 - e) Pull cover upwards.
3. Refer to terminal strip in Fig. 32-3. Remove the terminal strip paper cover.
4. Install 3 wire power cord, magnet, and keyboard wiring according to Fig. 32-4. More details are given in a schematic in Fig. 32-5.
5. Make sure the shipping screw (Fig. 32-6) is removed.

Note: For your information, the Model 32 selector magnet uses 500 mA current. The large current comes from an amplifier located in the Selector Magnet Driver (SMD) circuit card shown in Fig. 32-5. The 60 mA current from the acoustical coupler is amplified to 500 mA by the SMD card. The 500 mA current through terminals 3 and 4 to the selector magnet.

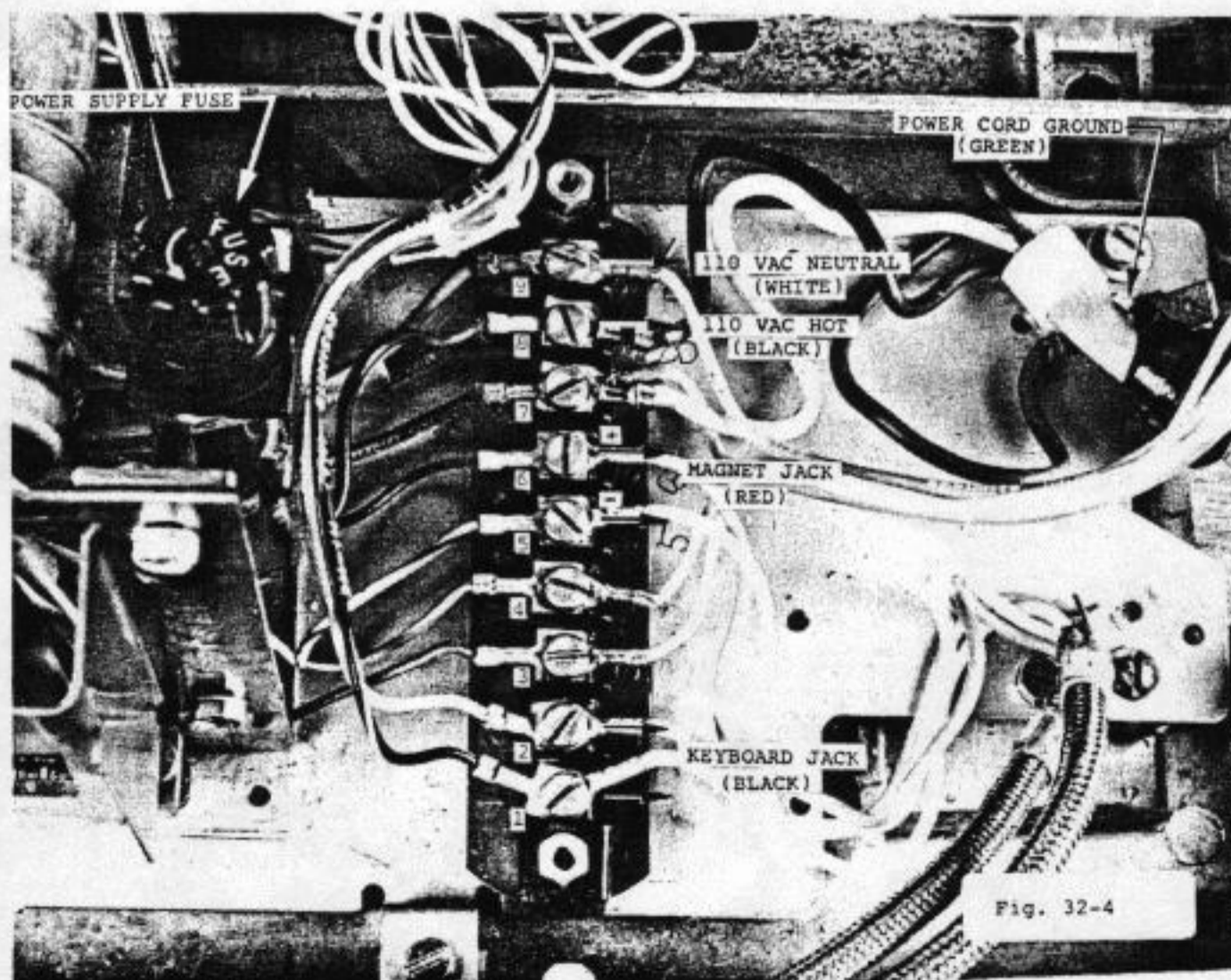
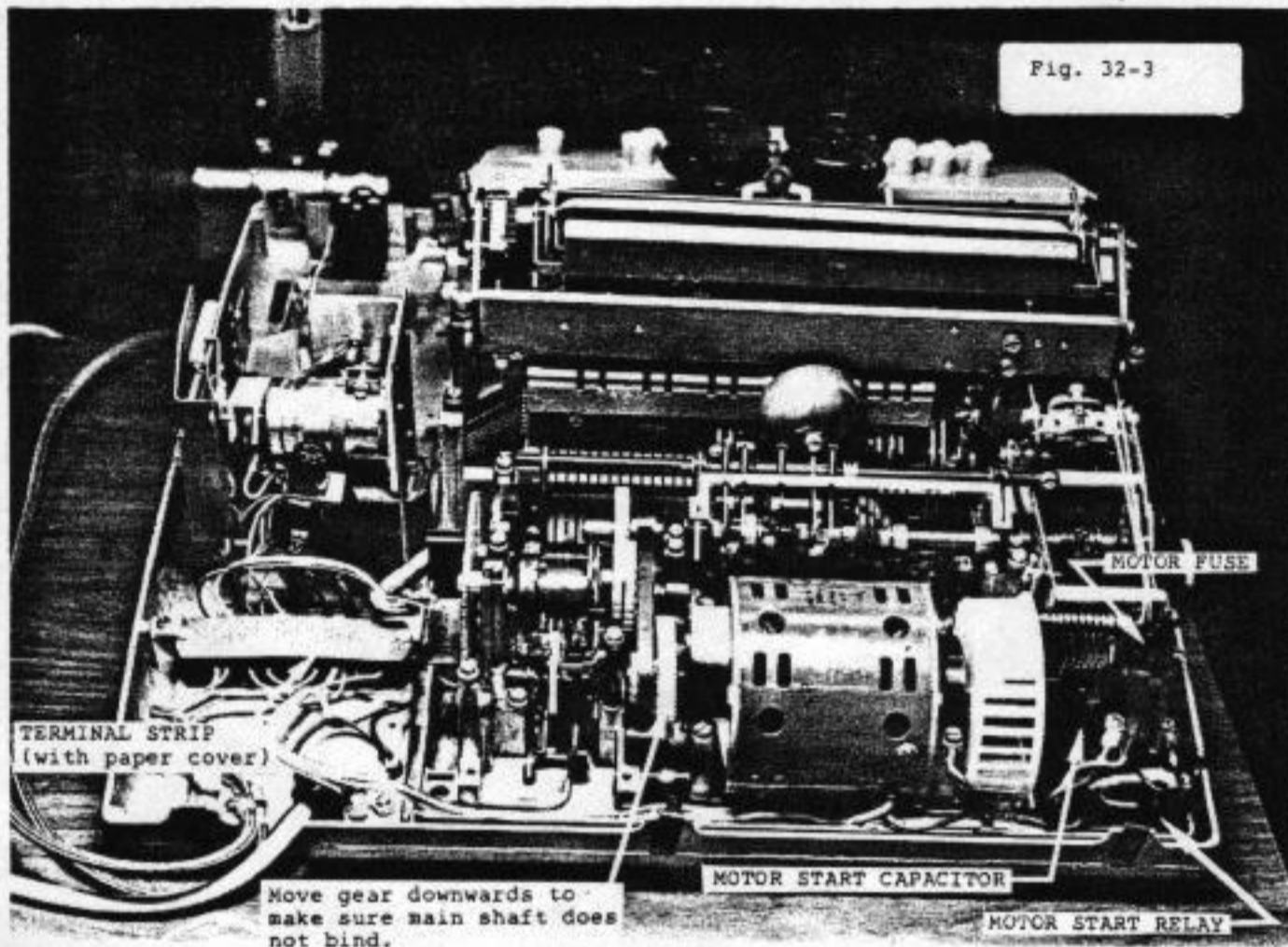

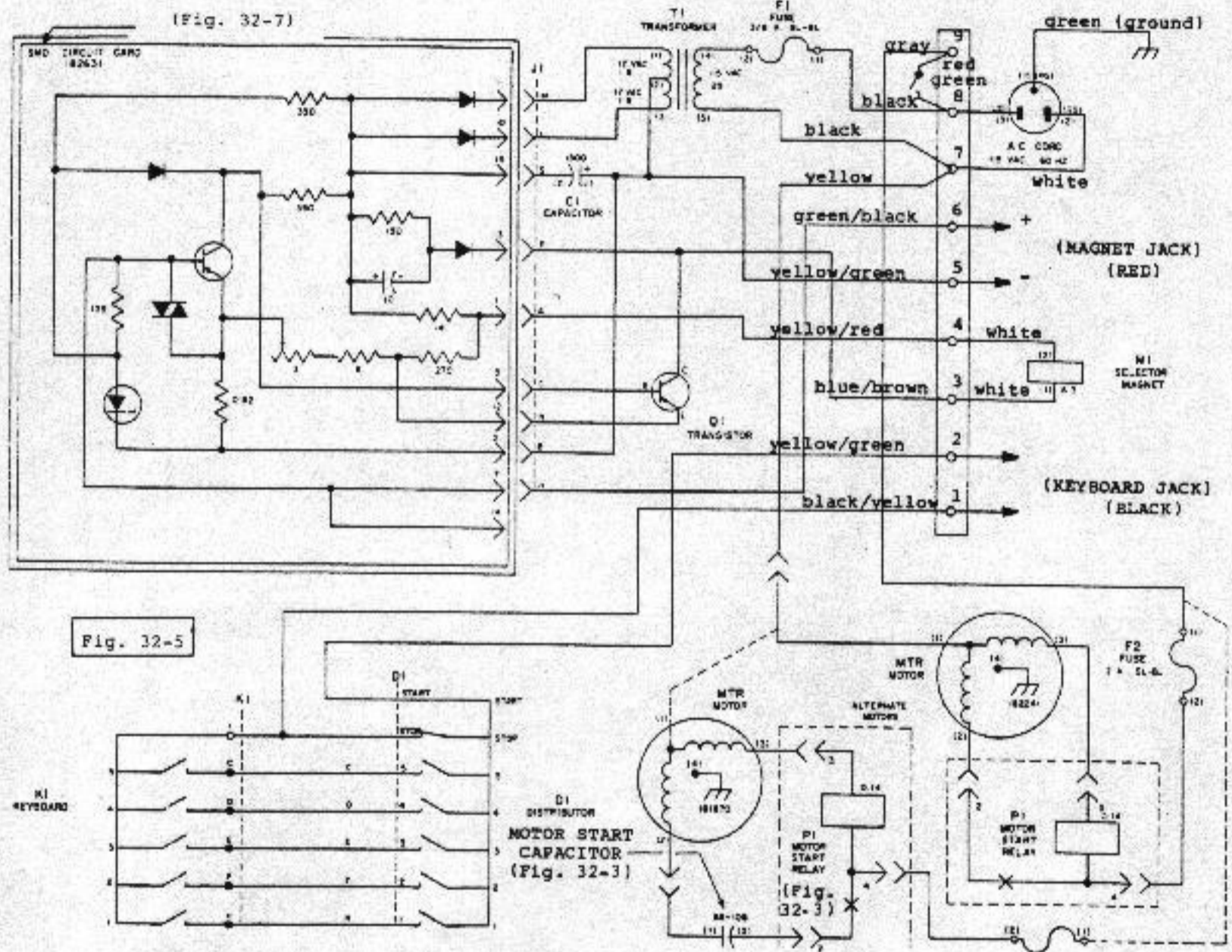

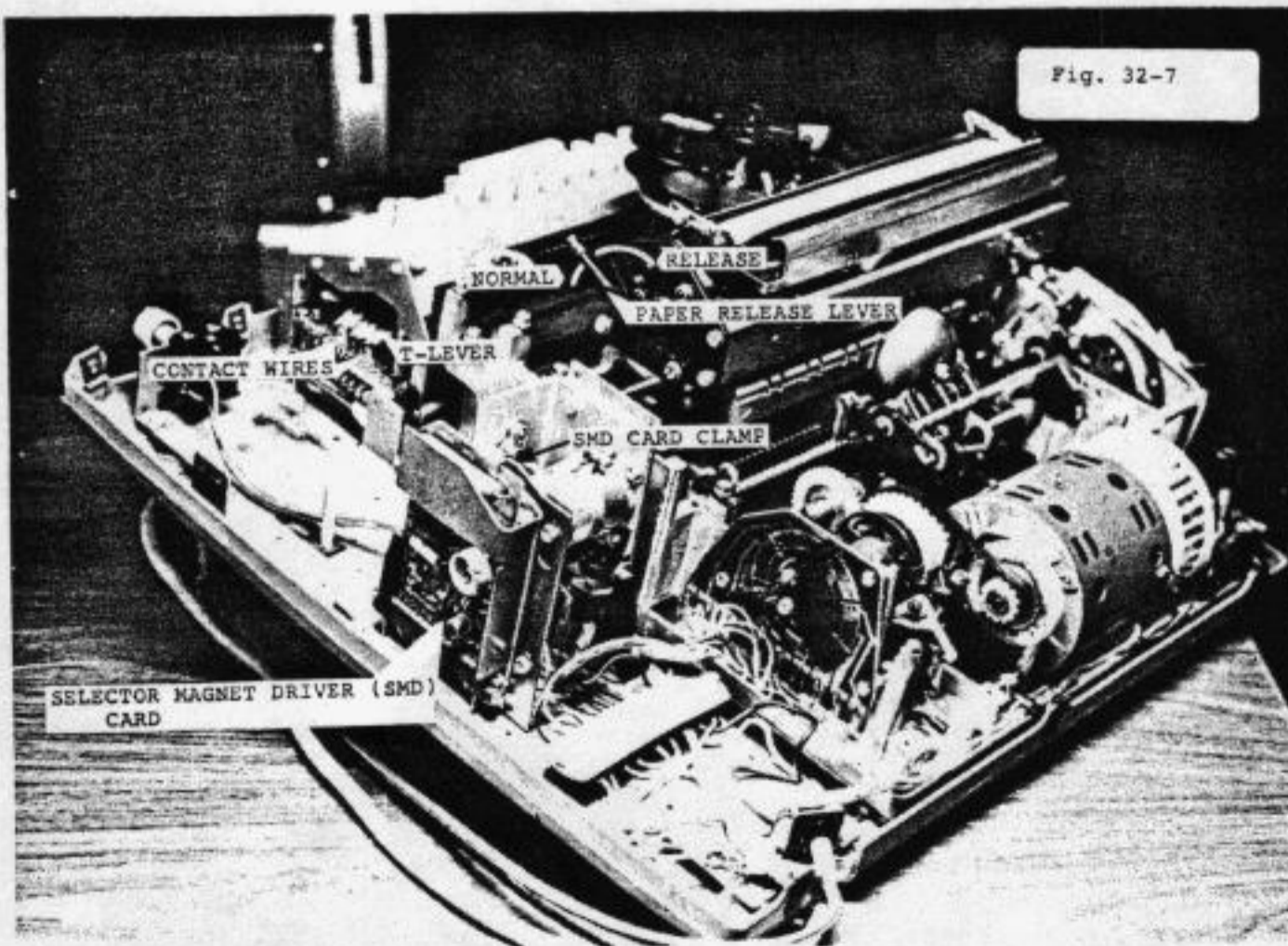
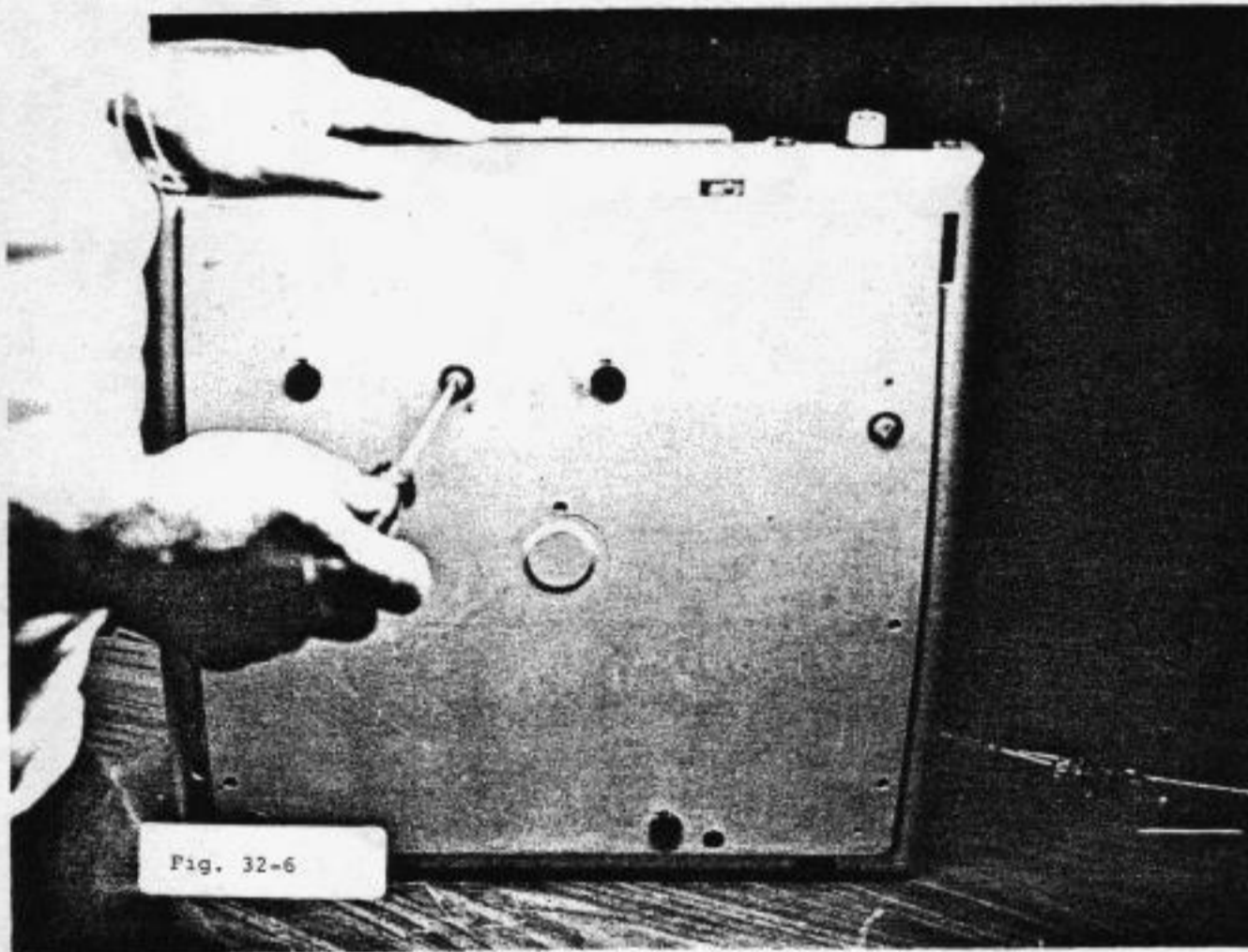

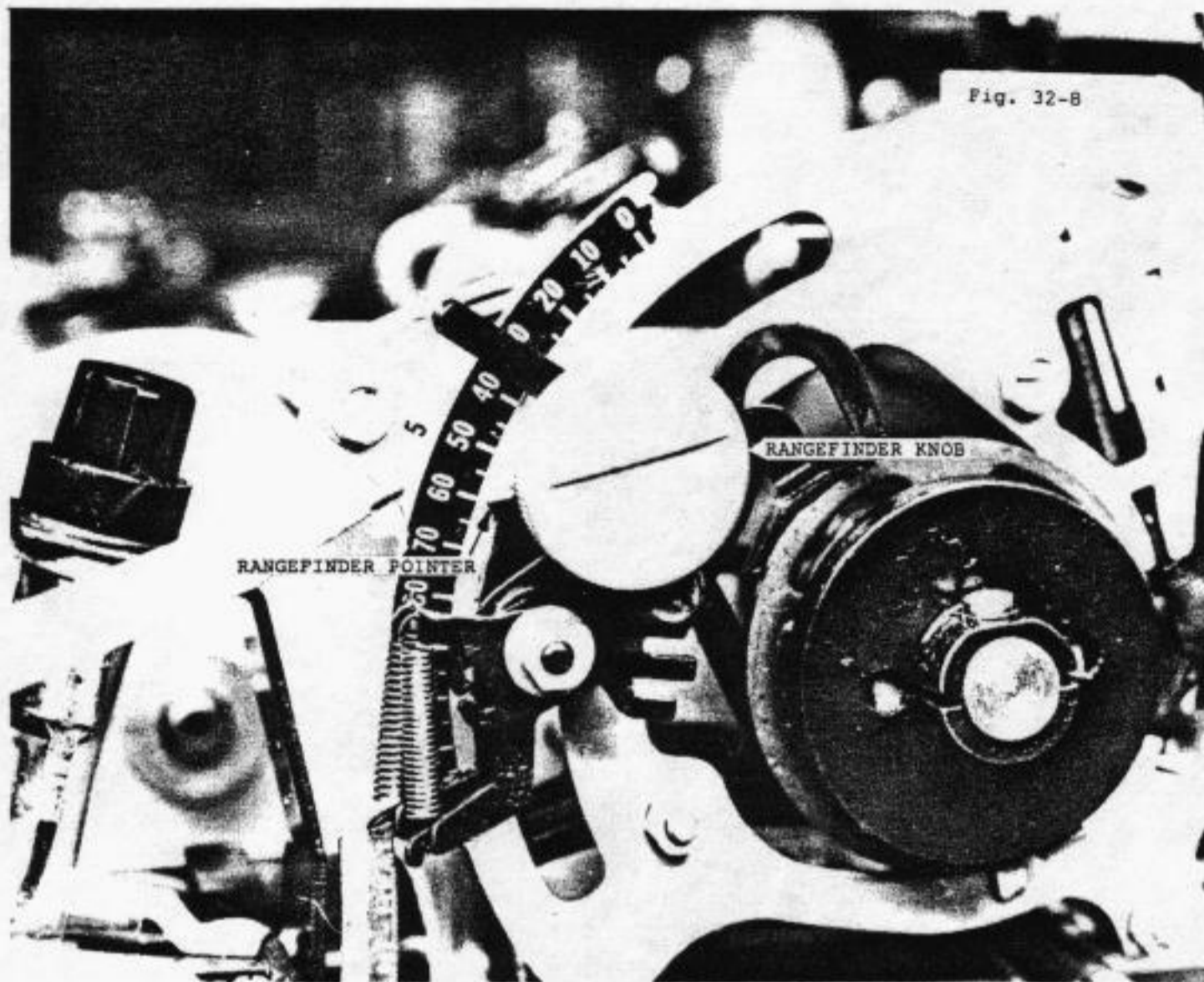
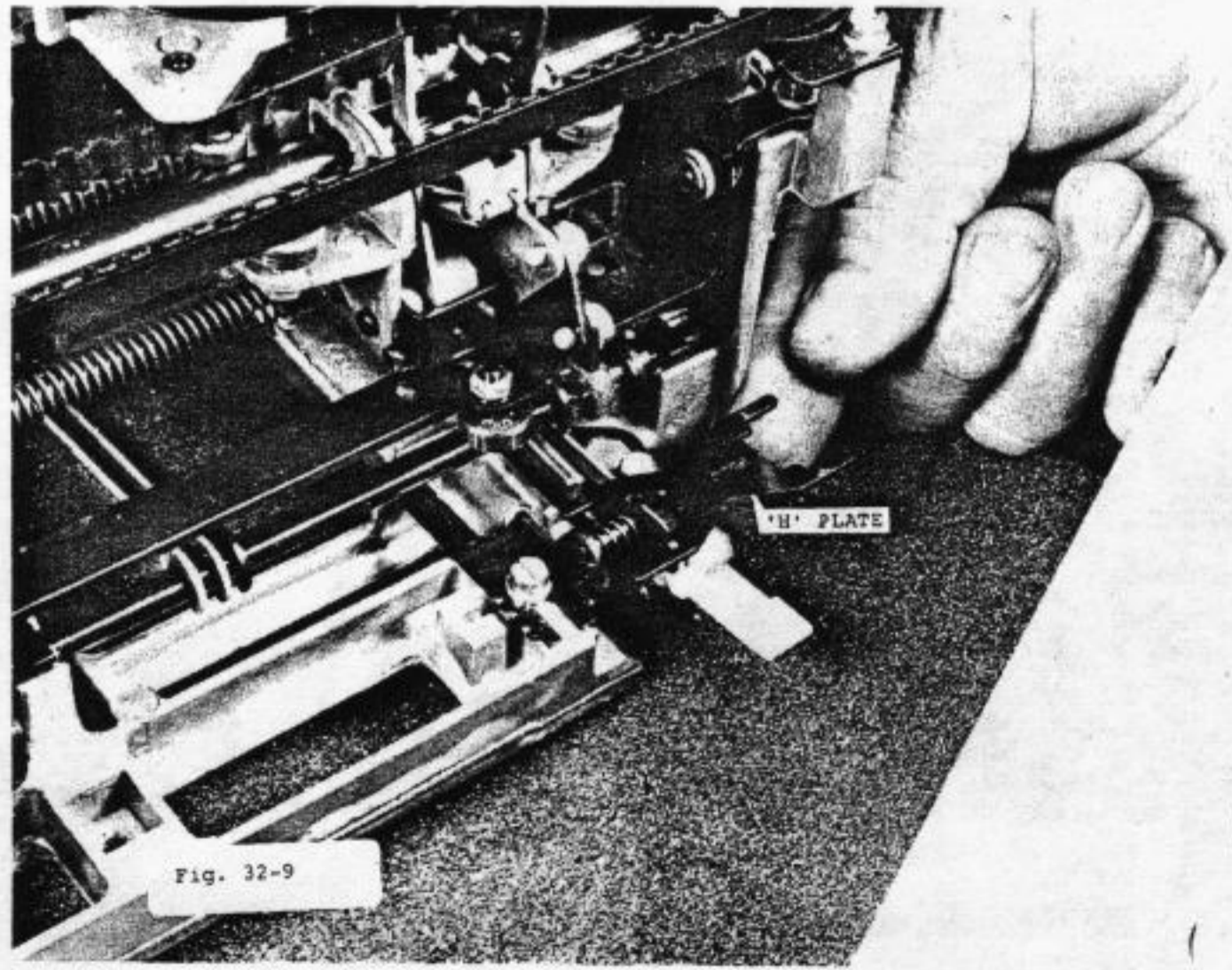

Fig. 32-8

RANGEFINDER POINTER

RANGEFINDER KNOB



'H' PLATE

Fig. 32-9

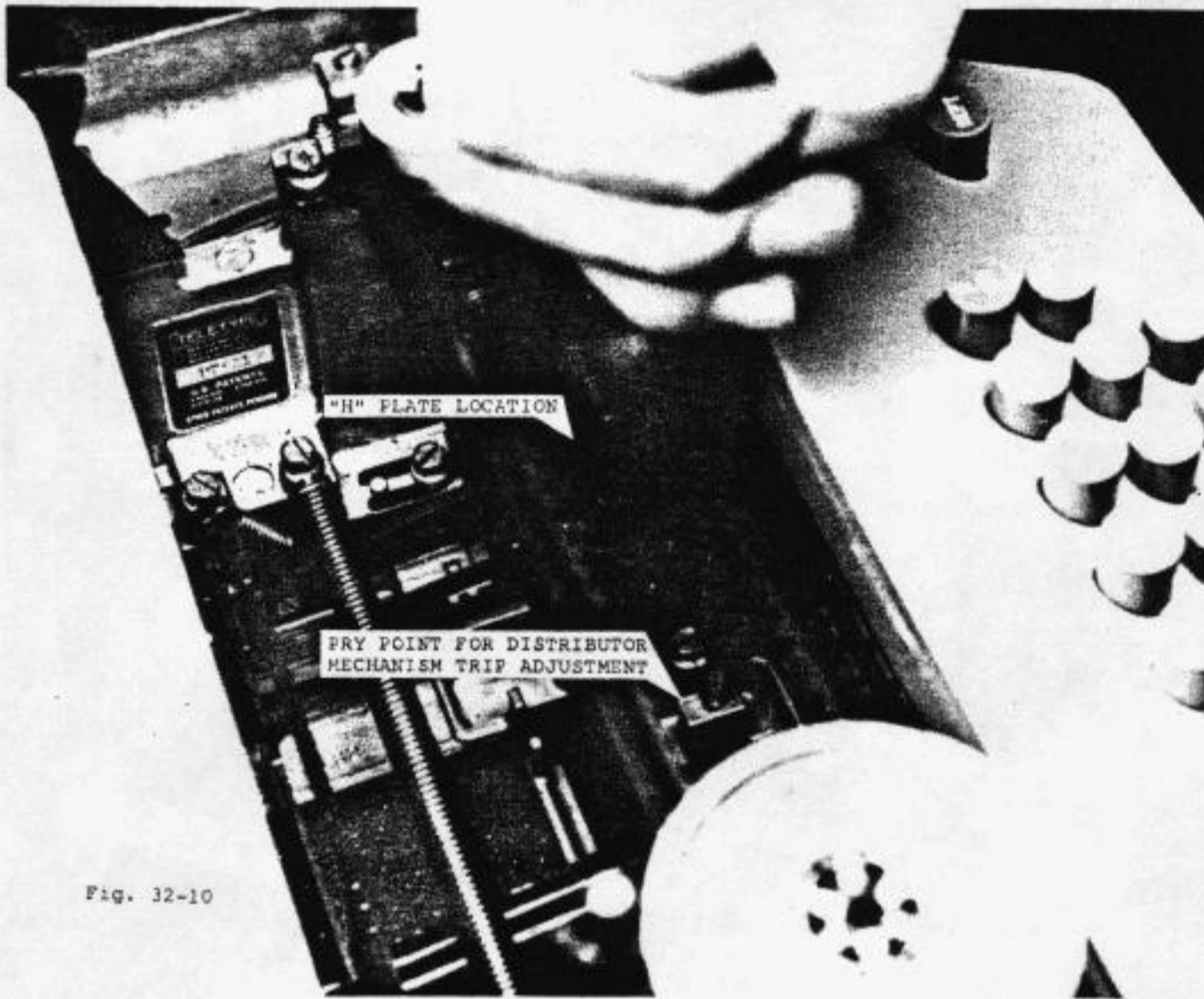

Fig. 32-10

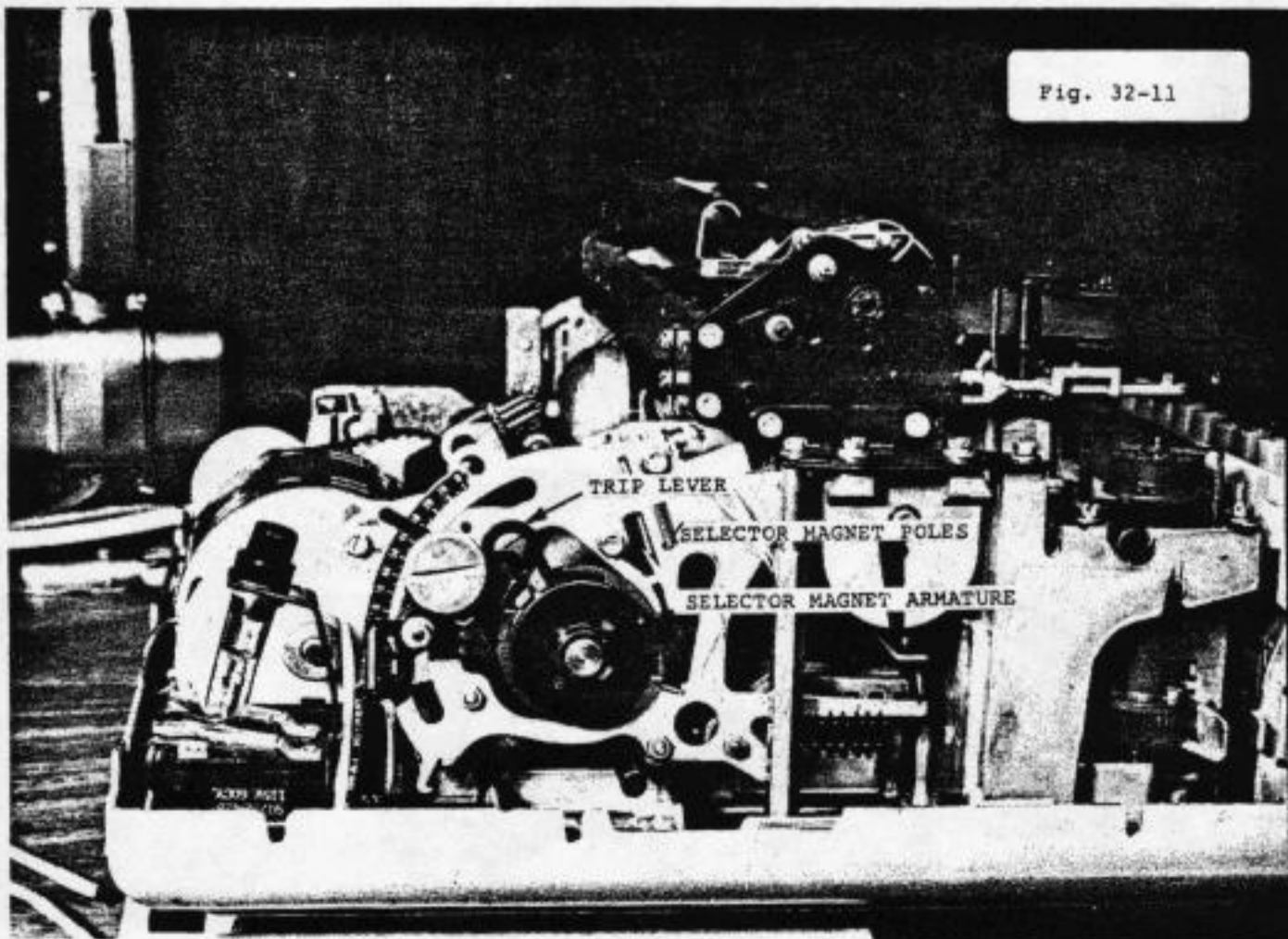
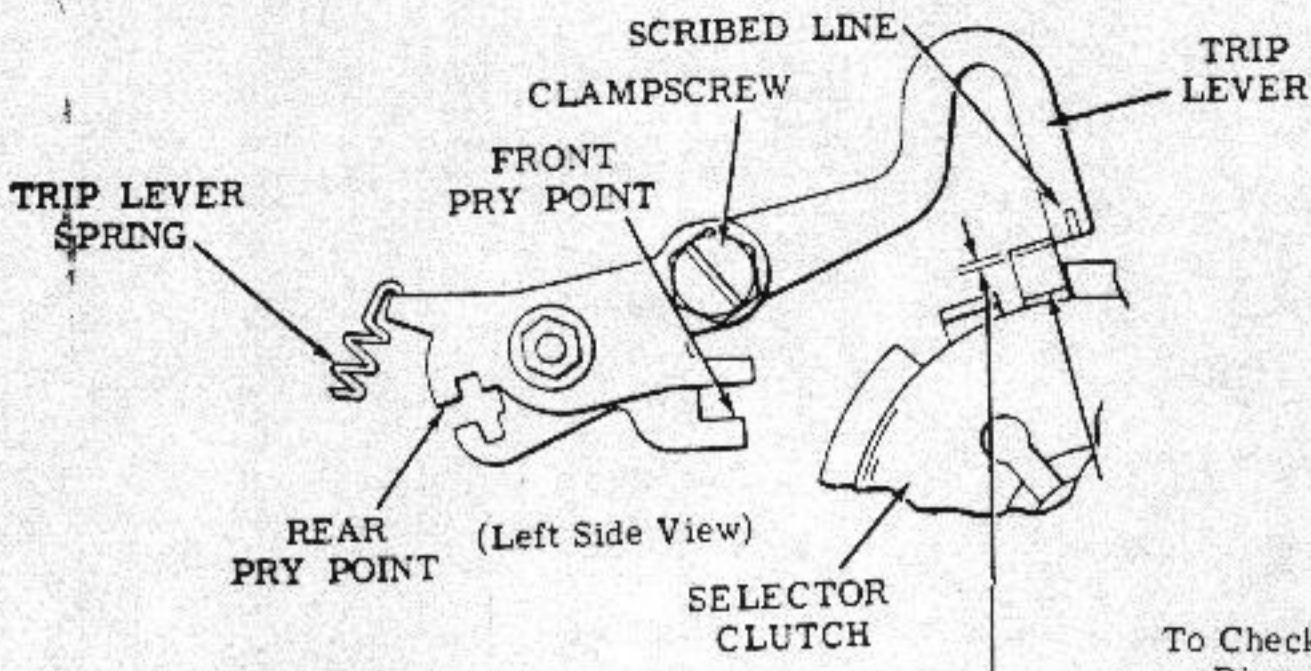

Fig. 32-11

MODEL 32

B. SOME COMMON TROUBLES

1. Motor is not running.
 - a) Check the fuse (Fig. 32-3).
 - b) Check the power switch (Fig. 32-1).
 - c) Motor start capacitor (Fig. 32-3) may be bad.
 - d) If motor hums, motor start relay (Fig. 32-3) may be bad.
 - e) Check for main shaft bind (Fig. 32-3).
2. Printing does not occur.
 - a) Keyboard plug (black) or magnet plug (red) not pushed all the way in the acoustical coupler.
 - b) Check power supply fuse (Fig. 32-4).
 - c) SMD Circuit Card (Fig. 32-7) may have a bad transistor or diode. To remove card, first remove SMD card lamp.
 - d) Rangefinder knob may have vibrated itself loose and fallen down. Refer to Fig. 32-8. Reset setting to 60 or to a determined setpoint (See Basic Troubleshooting chapter.)
 - e) If your teletype will print when the other person types, but will not print when you type; check to see if the typing unit and the keyboard are properly connected by means of the "H" plate. Refer to Figs. 32-9 and 32-10.
 - f) Trip lever not adjusted properly. Refer to Fig. 32-11



(Courtesy of Teletype Corp.)

To Check
Disengage (latch) selector clutch.

Requirement
Trip lever should engage shoe lever
Min 2/3 thickness
of shoe lever.

To Adjust
Loosen clampscrew friction tight and position trip lever using front and/or rear pry points. Tighten clampscrew.

TRIP LEVER PULLED DOWN BY ENERGIZED SELECTOR MAGNET (MARK)

FIG. 32-12

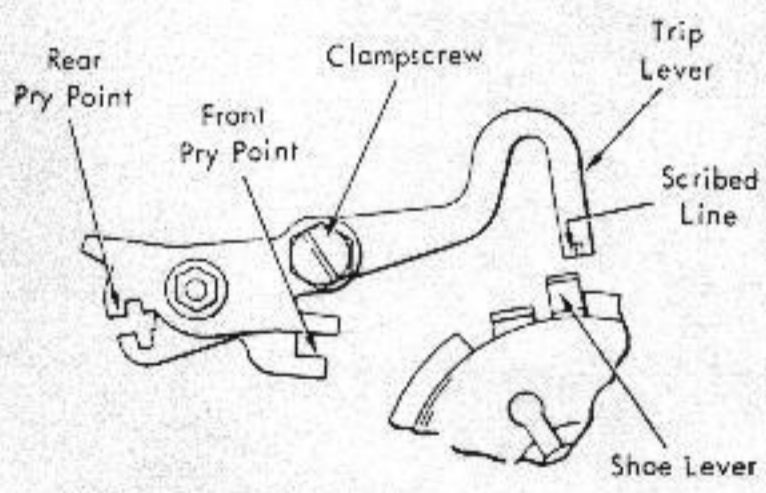

(Right Side View)

NOTE: SCRIBED LINE SHOULD LINE UP WITH EDGE OF SHOE LEVER.

(Courtesy of Teletype Corp.)

To Adjust
Loosen clampscrew. Use front pry point to meet Requirement (1); use rear pry point to meet Requirement (2).

TRIP LEVER RELEASED BY DE-ENERGIZED SELECTOR MAGNET (SPACE)

FIG. 32-13

MODEL 32

for location. Trip lever should engage shoe lever during idle condition while selector magnet is energized. See Fig. 32-12 for adjustment instructions. Adjustment is easier if performed with power turned off. Use thumb to rotate gear and screwdriver to move armature as shown in Fig. 32-14. After adjustment according to Fig. 32-12 is made, go to the second adjustment procedure in Fig. 32-13. Make sure scribed line is in line with edge of shoe lever. You may have to go back and forth between the two adjustments to get a good adjustment.

3. Ribbon does not feed properly.

Carbon ribbon may not have eyelets at ends. Eyelets are needed to trip the ribbon reversing levers, enabling the ribbon to reverse feed itself.

4. Paper does not feed properly.

a) Check with Fig. 32-15 to see if your paper follows the threading procedure.

b) Make sure paper release lever is down in the normal position (Fig. 32-7).

c) Paper roll spindle (Fig. 32-2) helps the paper feed through properly. Make sure you take it out of the empty paper roll before discarding the paper roll. Makeshift spindles sometimes hinder the paper roll from rotating smoothly, preventing the paper from feeding through properly.

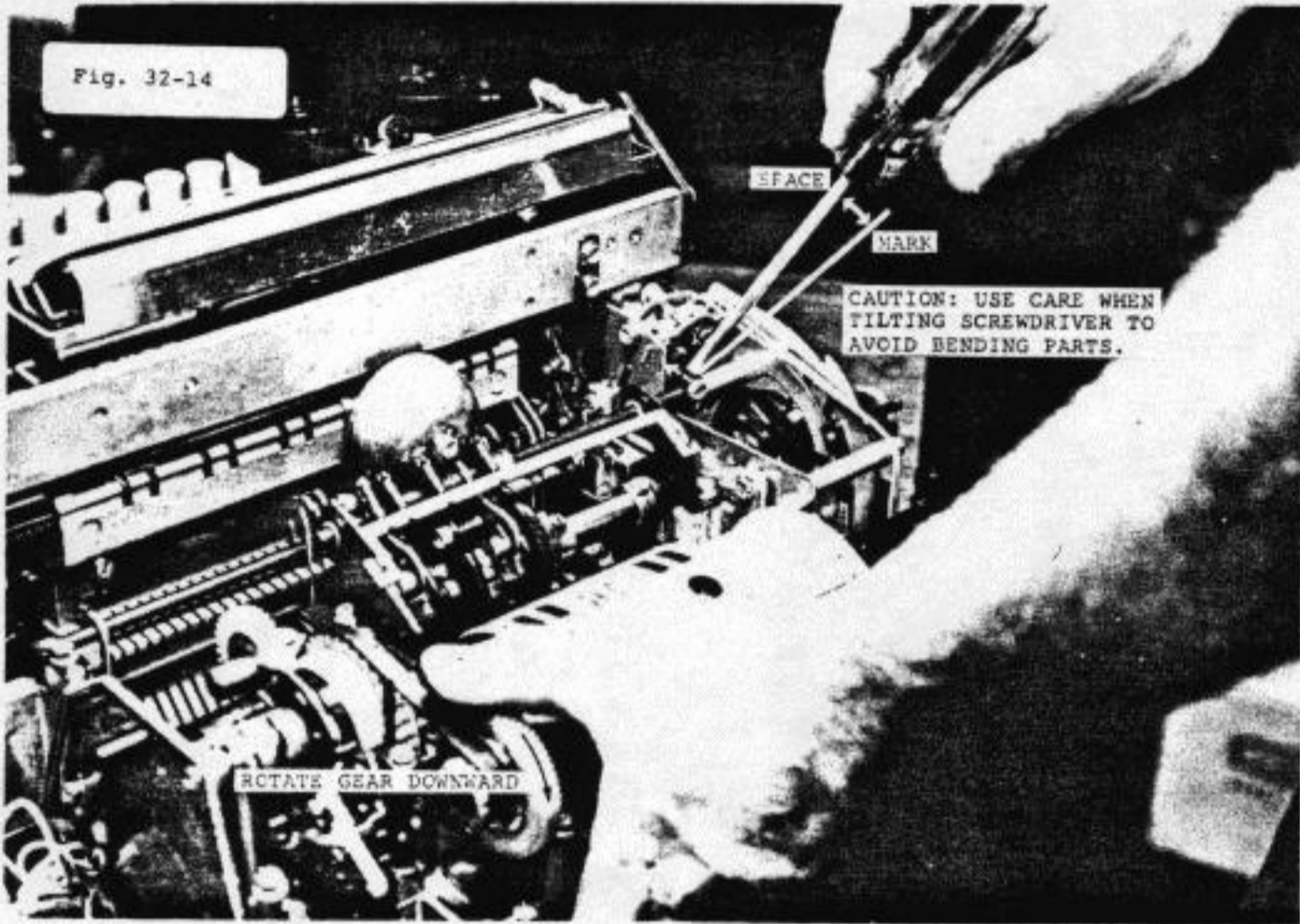
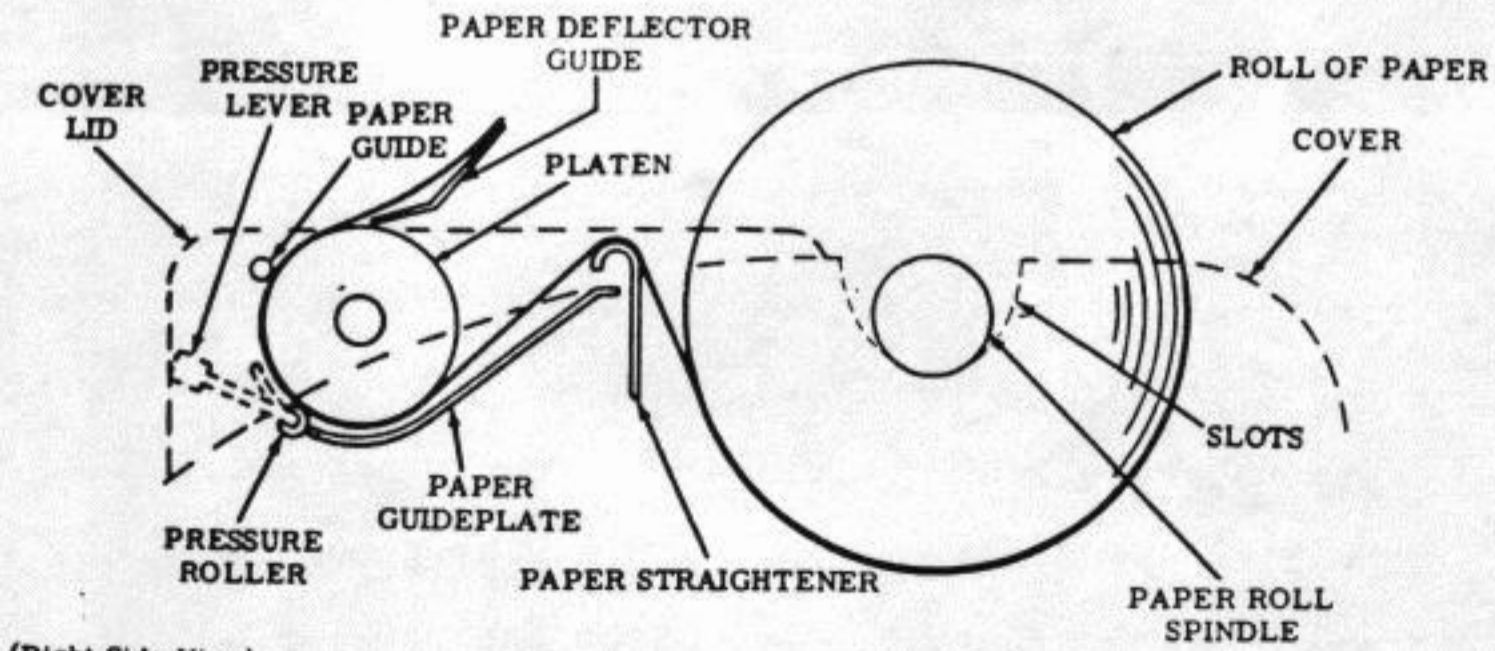

Fig. 32-15

(Courtesy of Teletype Corp.)



(Right Side View)

Paper Threading — Friction Feed

MODEL 32

- d) Line feed may not be working properly. Hit "Repeat" key and line feed key and observe the action of platen teeth and detent in Fig. 32-16. Another figure reference is Fig. 32-17. Detent and platen teeth should fully mesh at an even rhythmical pace. If pace is uneven, adjustment information is provided in Figs. 32-17, 32-18, and 32-19. The order of adjustment cannot be determined; it is up to the best judgement of the repairman. Location reference of line feed parts is given in Fig. 32-20.
5. First few spacings (after carriage return) is unevenly spaced or does not occur at all.
- a) Cylinder and dashpot are dirty and maybe sticky
Fig. 32-21. Clean both with naphtha or a good solvent and apply one drop of oil on dashpot. Do not overoil!
- b) Check for carriage bounce on carriage return. To adjust, loosen clampscrew and position orifice adjusting plate (Fig. 32-22). Note: Do not fully uncover orifice. A fully uncovered orifice may result in breakage of the carriage return lobe plate. (Fig. 32-22)
- c) Check for proper alignment of piston and dashpot cylinder. Piston should move freely back and forth inside cylinder. If alignment is necessary, loosen the screws as shown in Fig. 32-23. Holding carriage in place, push dashpot cylinder to right firmly onto piston. Make sure dashpot cylinder is square to piston. Caution: Do not

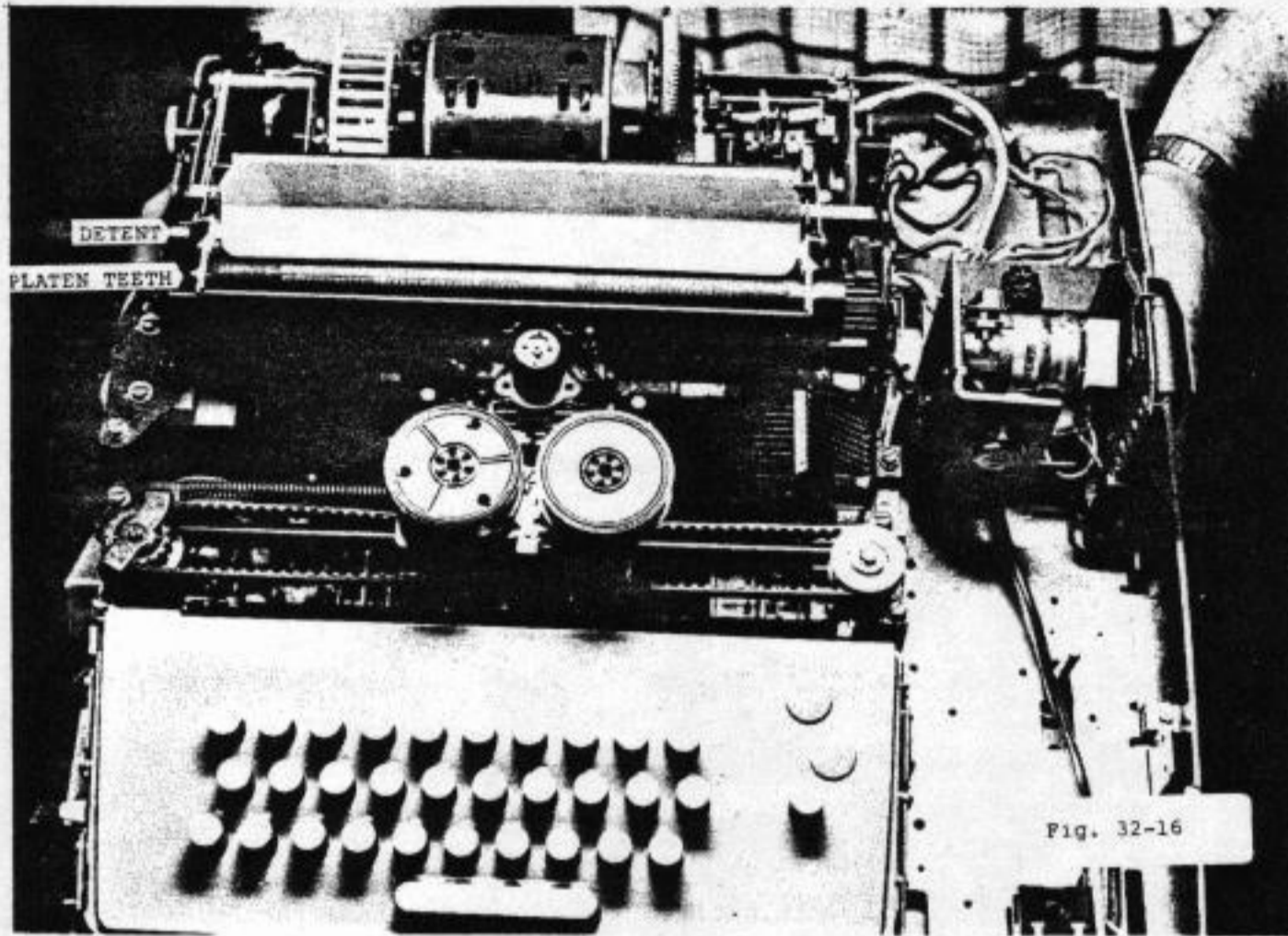

NOTE: If drive link travel is complete, check Requirements (1), (2), and (3). If link travel is incomplete, check Requirement (4).

Requirement

With the line feed pawl placed in its lowest position:

- (1) Pawl held forward should fully mesh with platen teeth.
- (2) Platen should not rotate when detent is held outward then released against platen.

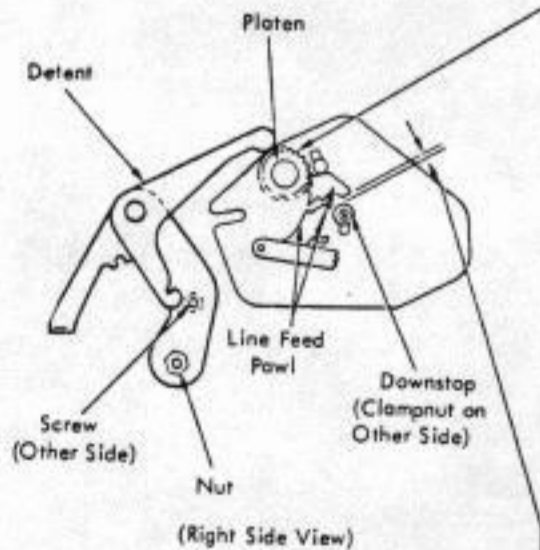

(Courtesy of Teletype Corp.)

- (3) Min some---Max 0.010 inch between pawl and downstop.

Fig. 32-17

With line feed code in selector, rotate main shaft to pivot line feed drive arm to its highest position. There should be a gap between drive arm and blocking lever, and the blocking lever should engage the drive link as illustrated.

To Adjust

- (1) If no gap exists, loosen clampscrew (friction tight) and reposition drive arm. Check 6.14 Requirement (2).
- (2) If gap exists but drive link does not engage blocking lever, loosen mounting screws and lower upstop bracket.

To Check (2)

Cycle unit as in Requirement. Push down lightly, then release blocking lever. Observe 0.010 to 0.050 inch movement of blocking lever. If necessary, refine To Adjust (2)

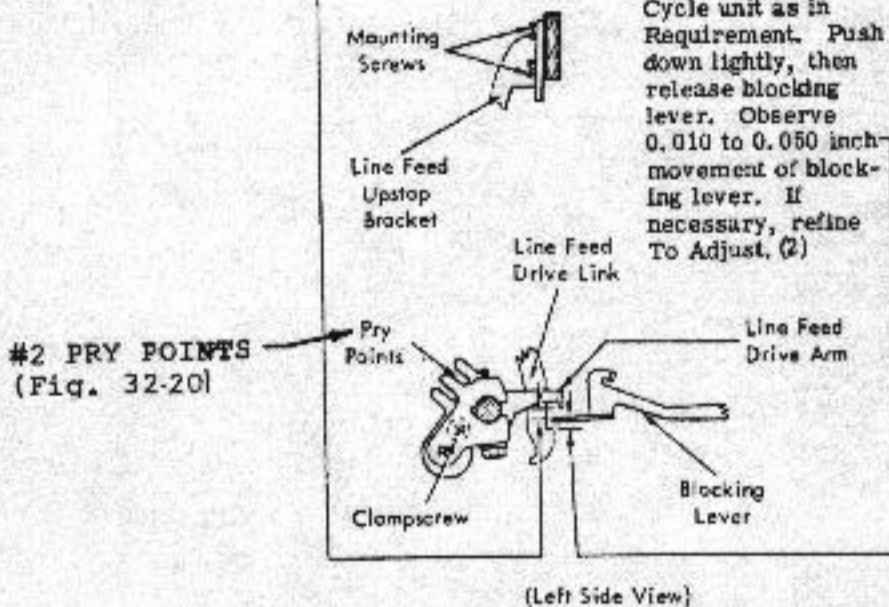

(Courtesy of Teletype Corp.)

Fig. 32-18

- (4) Min some---Max 0.005 inch between stripper ball and plate.

To Adjust

To meet Requirement (1), loosen nut and screw and position detent. For Requirement (2), loosen clampscrews and position drive link — if necessary, decrease gap of 6.13 Requirement (1). For Requirement (3), loosen downstop clamp nut and position downstop. For Requirement (4), loosen stripper plate screw and position plate.

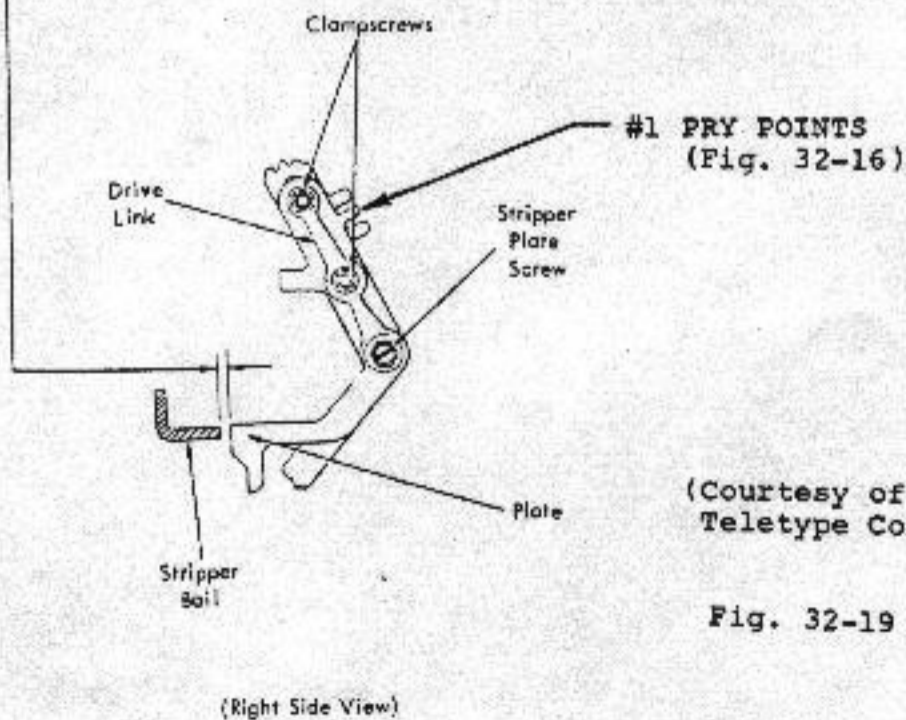

(Courtesy of Teletype Corp.)

Fig. 32-19

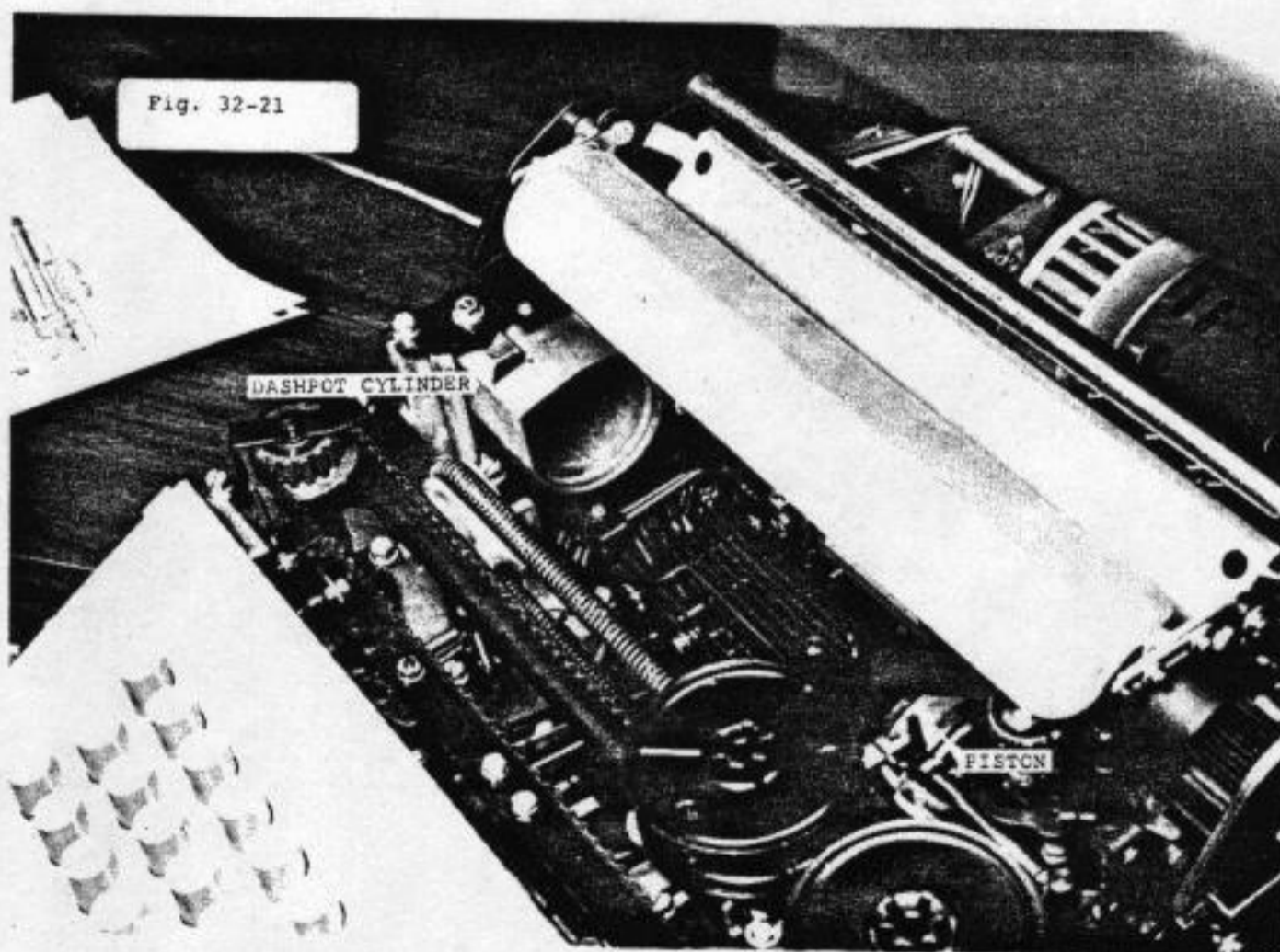
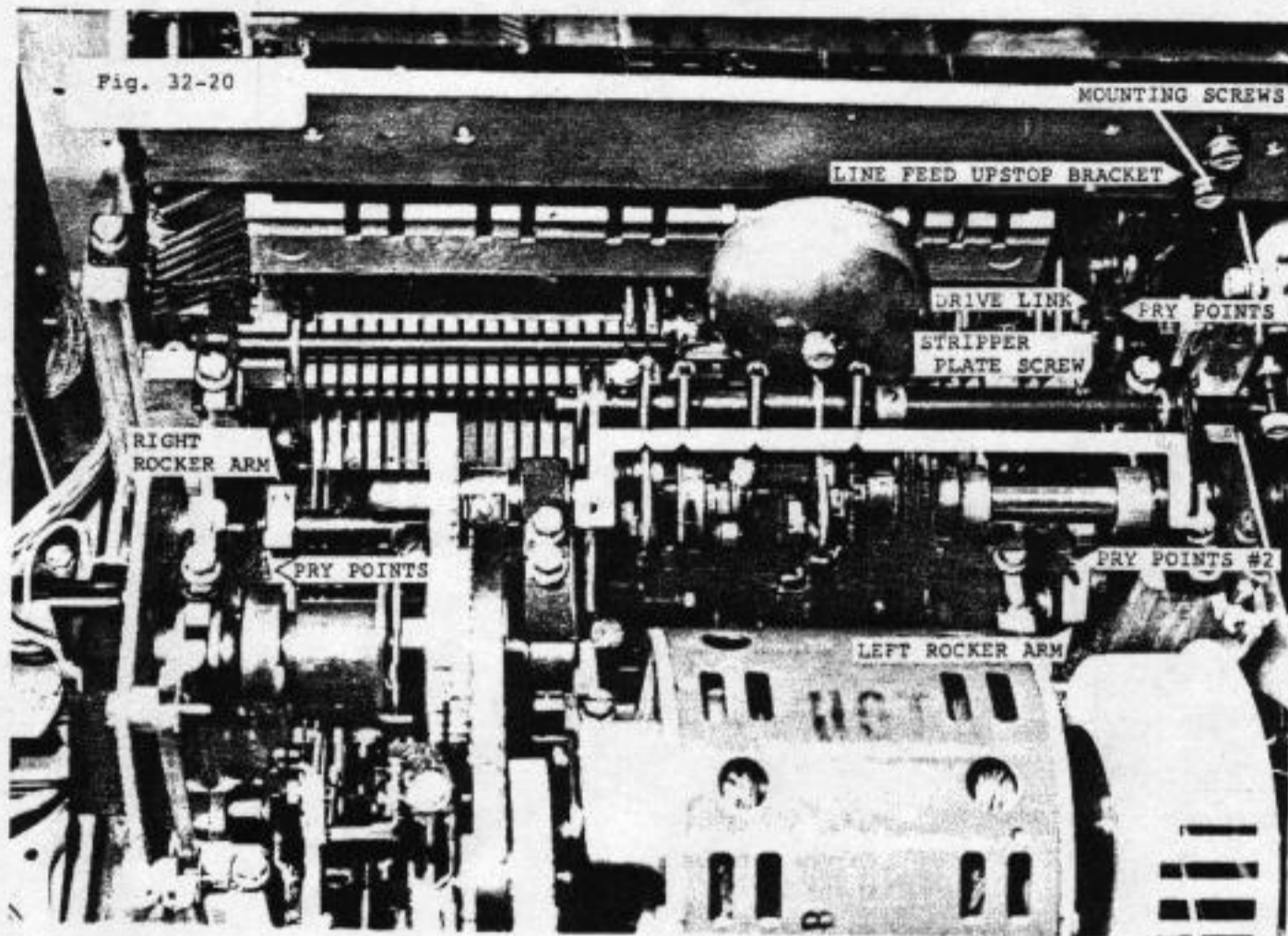

MODEL 32

push cylinder too far to the right since lobe plate will not engage carriage return unlatch lever. (Fig. 32-22).

d) If the first two characters still are uneven (Fig. 32-24), refer to the space ratchet adjustment described in Fig. 32-25. Location of space ratchet is shown in Fig. 32-26.

e) If carriage return spring (Fig. 32-22) is suspected to be weak, replace it. If a replacement is not available, cut about an half inch off one end and reposition spring.

6. Printing occurs but garbles.

a) Check rangefinder setting (Fig. 32-8). Setting should be at 60 or at a predetermined point.--See Basic Troubleshooting chapter.

b) Oil may have gotten between the armature and pole pieces of the selector magnet. Refer to fig. 32-11.

c) Check that the contact wires are properly located in their T-lever. Refer to Fig. 32-7. Also check on contact wire gap away from common terminal. Gap should be 0.01 to 0.04 inches, gauged by eye. Refer to Fig. 32-27.

d) Check the motor drive belt (Fig. 32-28) by observing the rubber teeth with a flashlight. Rotate the nylon gear downward to advance the belt as shown in Fig. 32-14. If the belt is stripped, replace it according to Section C.

e) Distributor face (Fig. 32-29) may be dirty, thus preventing good electrical contacts. Clean with erasure. Rotate brush holder by rotating nylon gear downwards (Fig. 32-14).

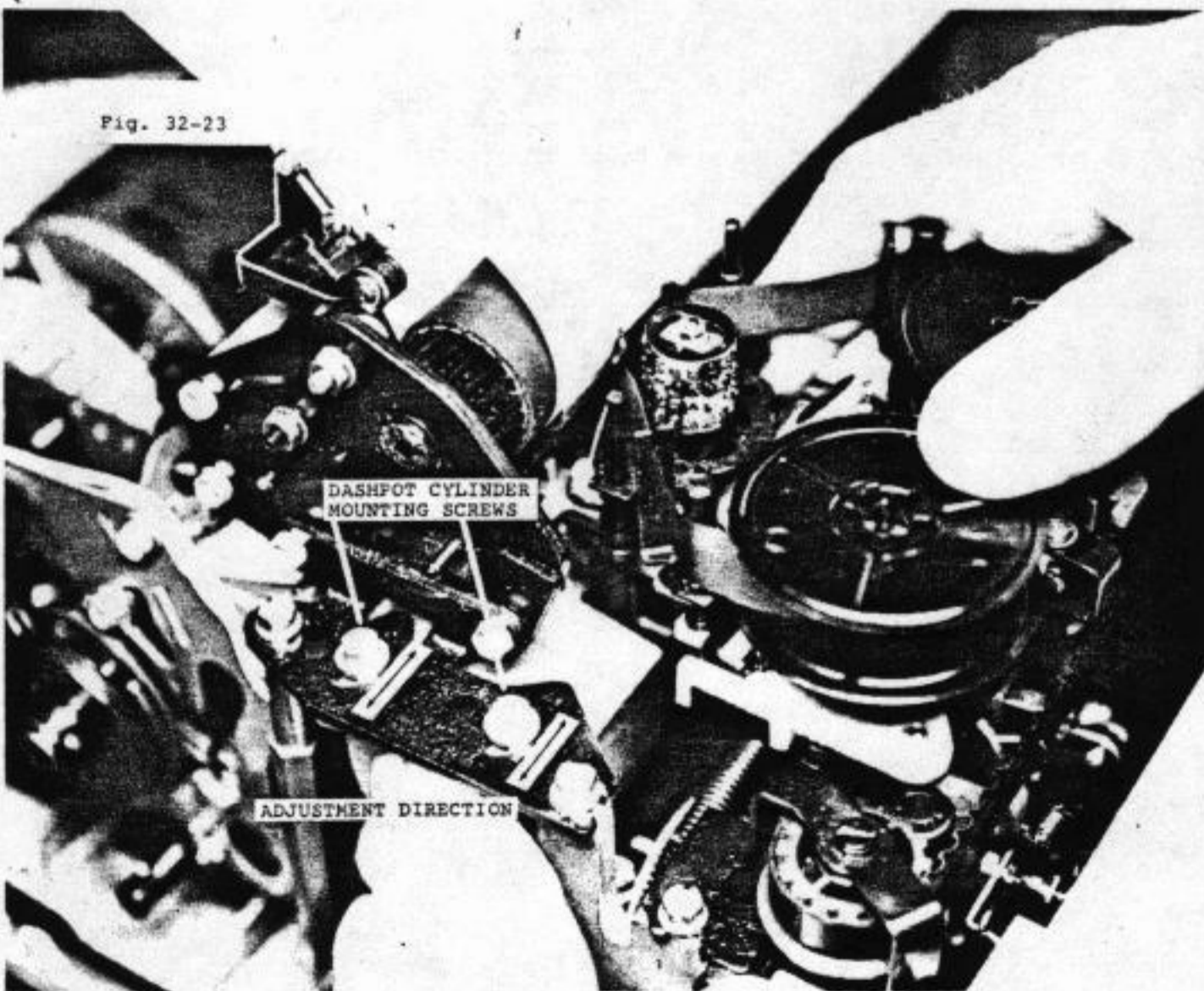
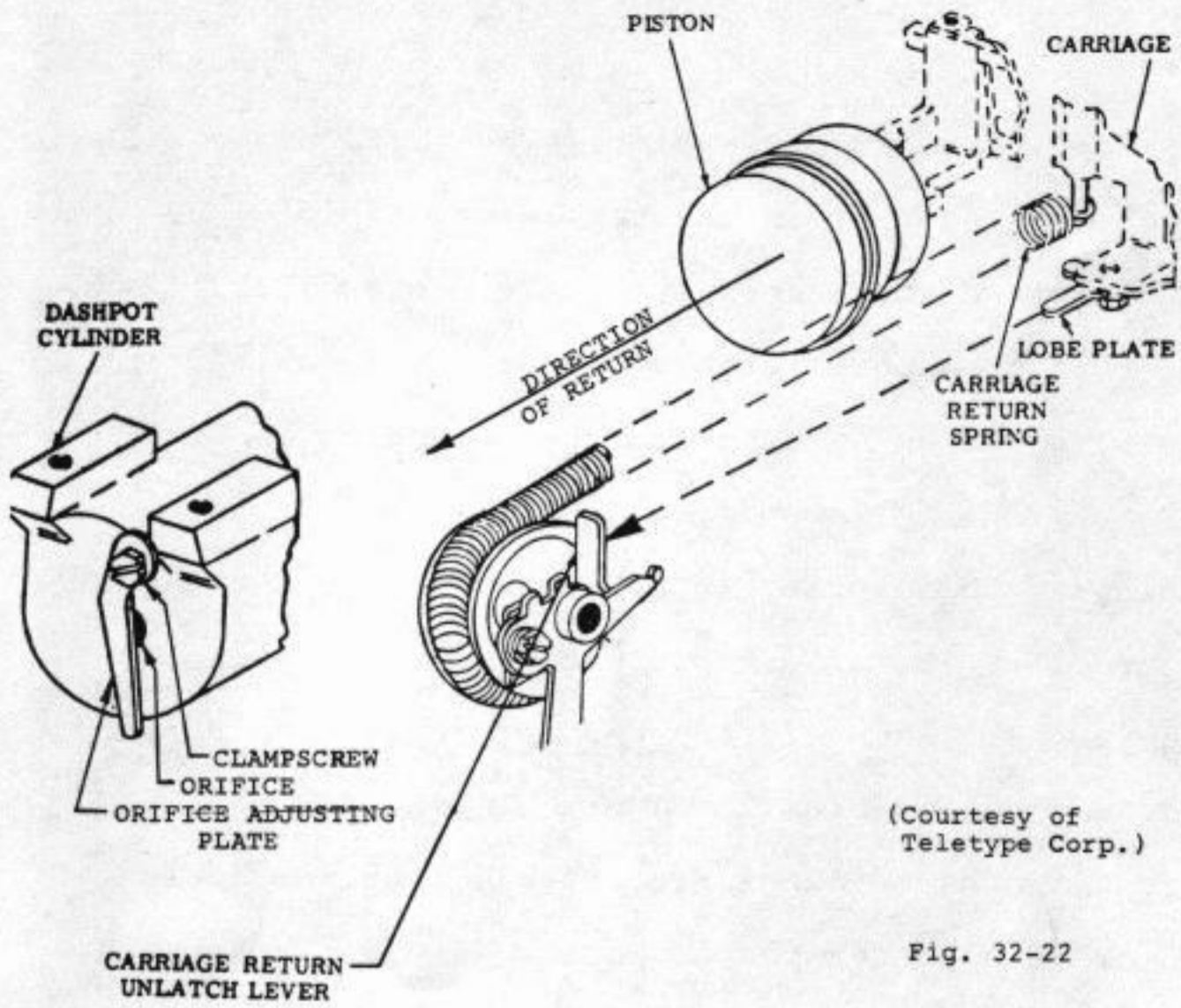

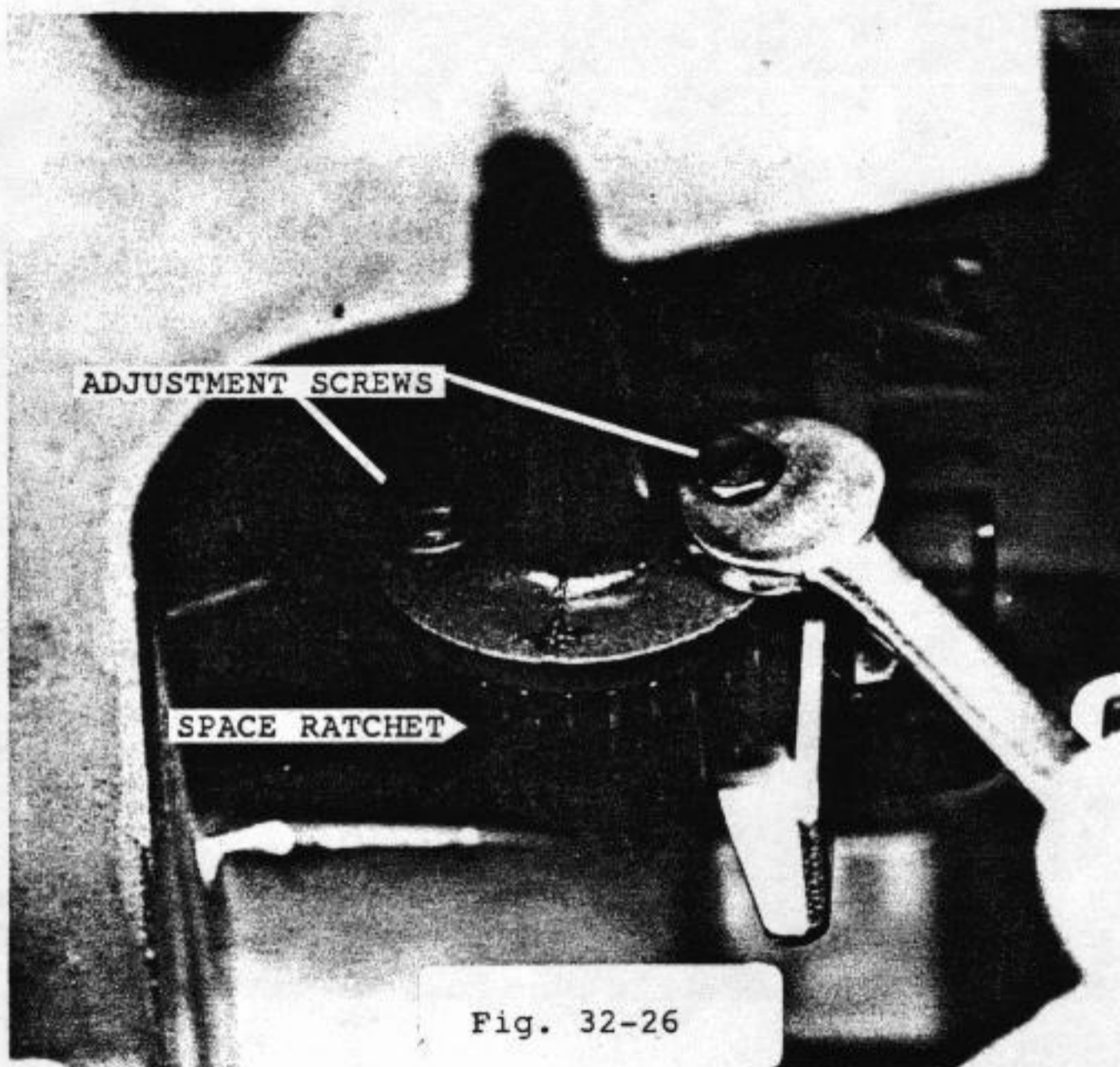
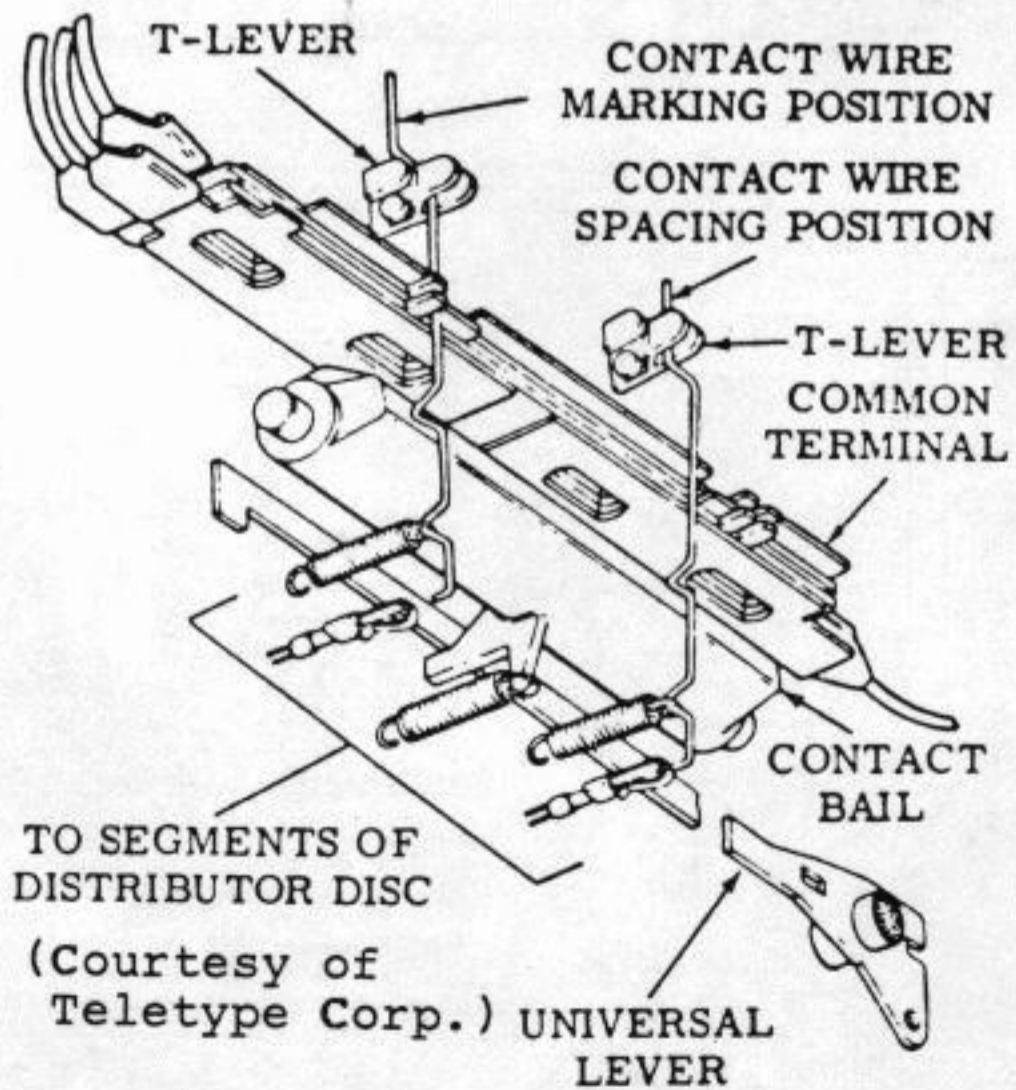
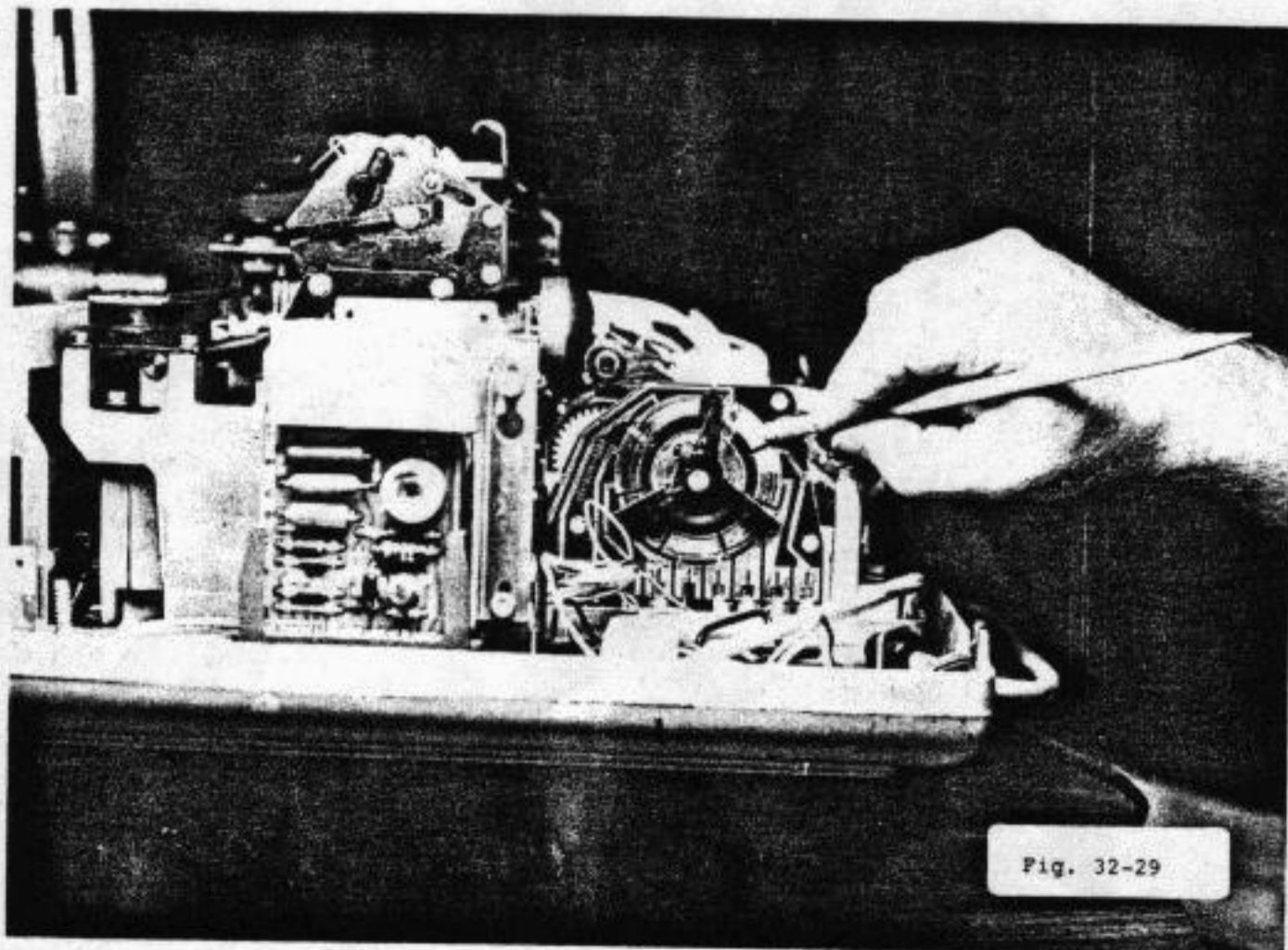
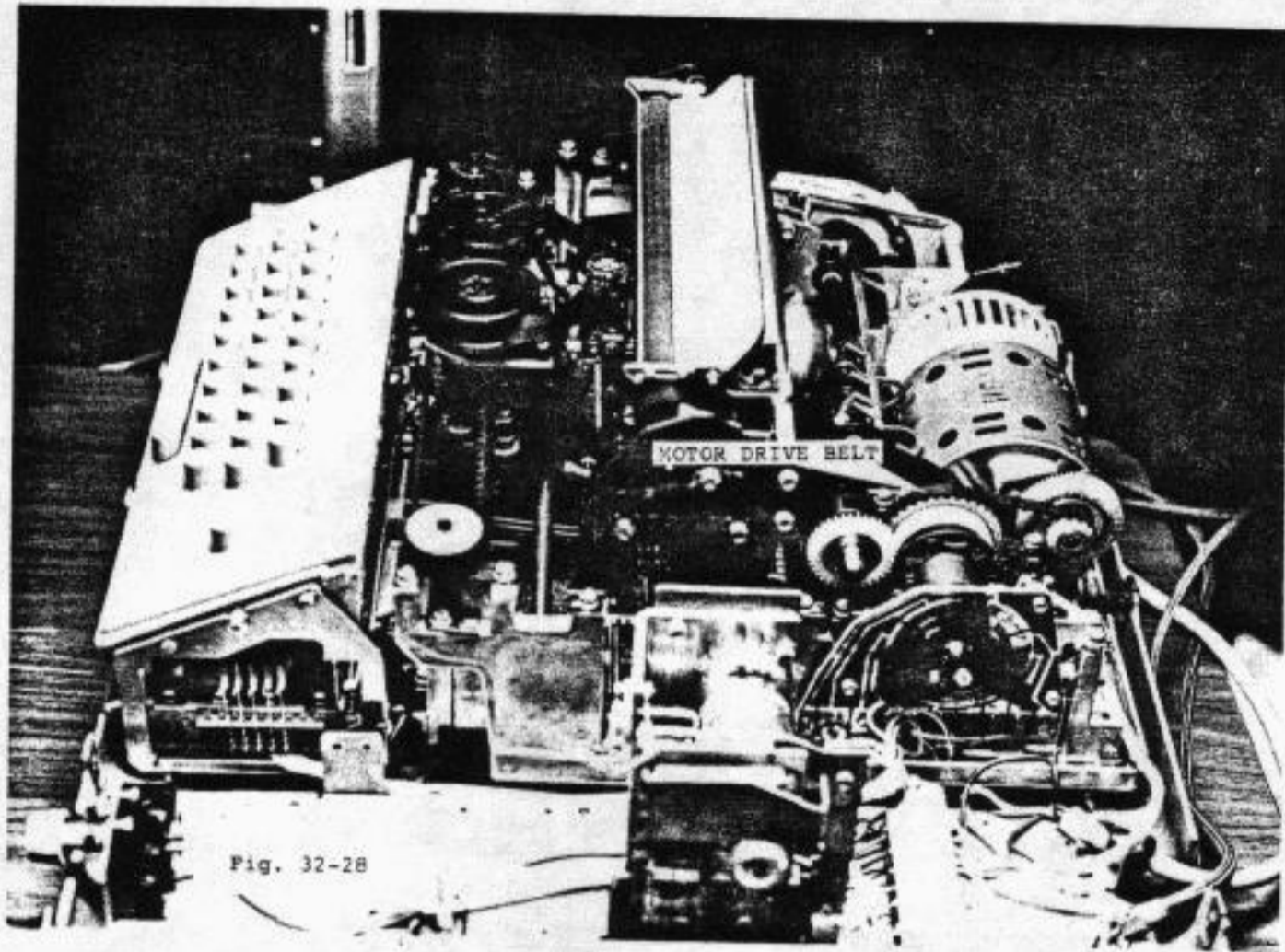

Fig. 32-26



(Courtesy of Teletype Corp.)

Fig. 32-27



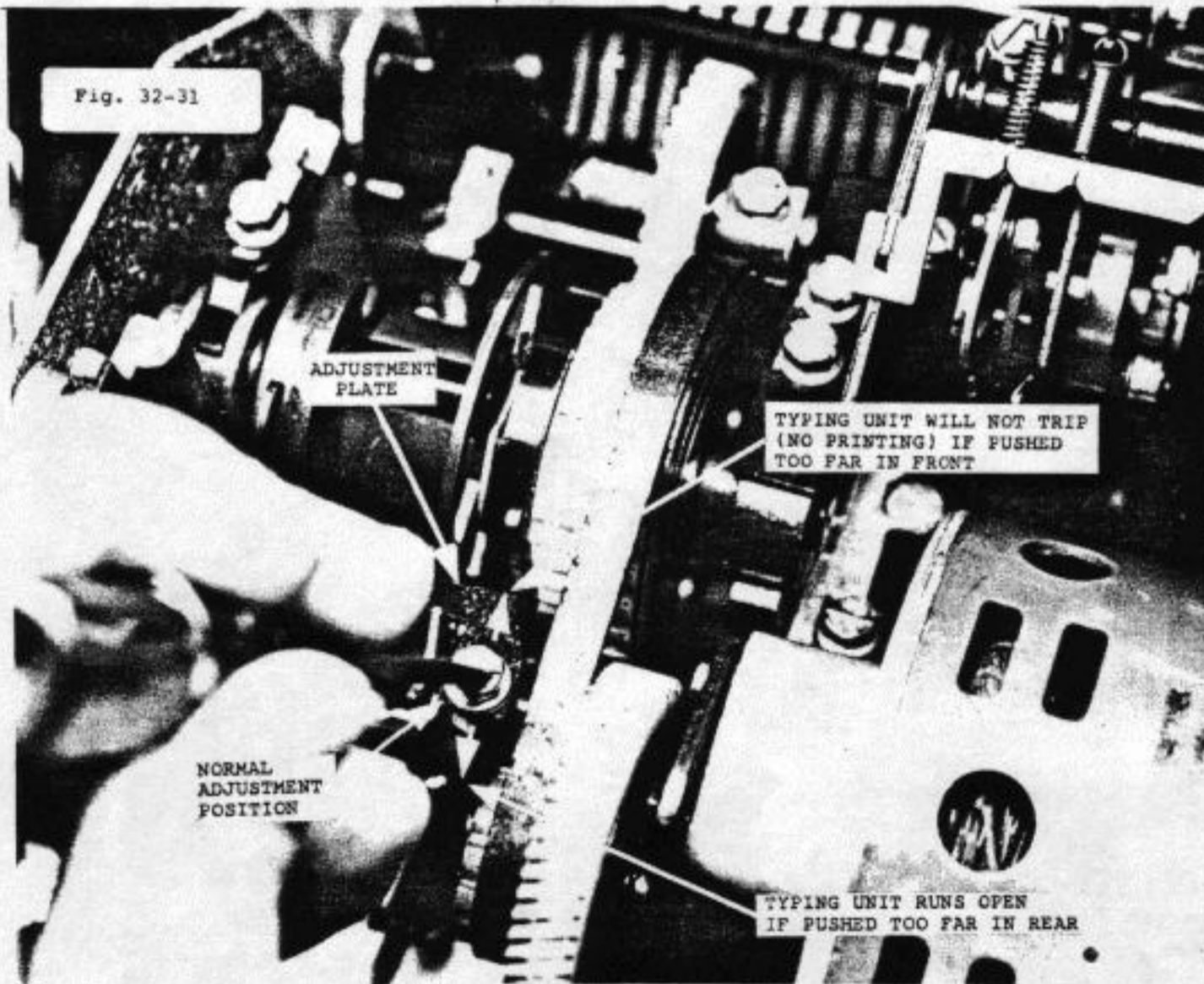
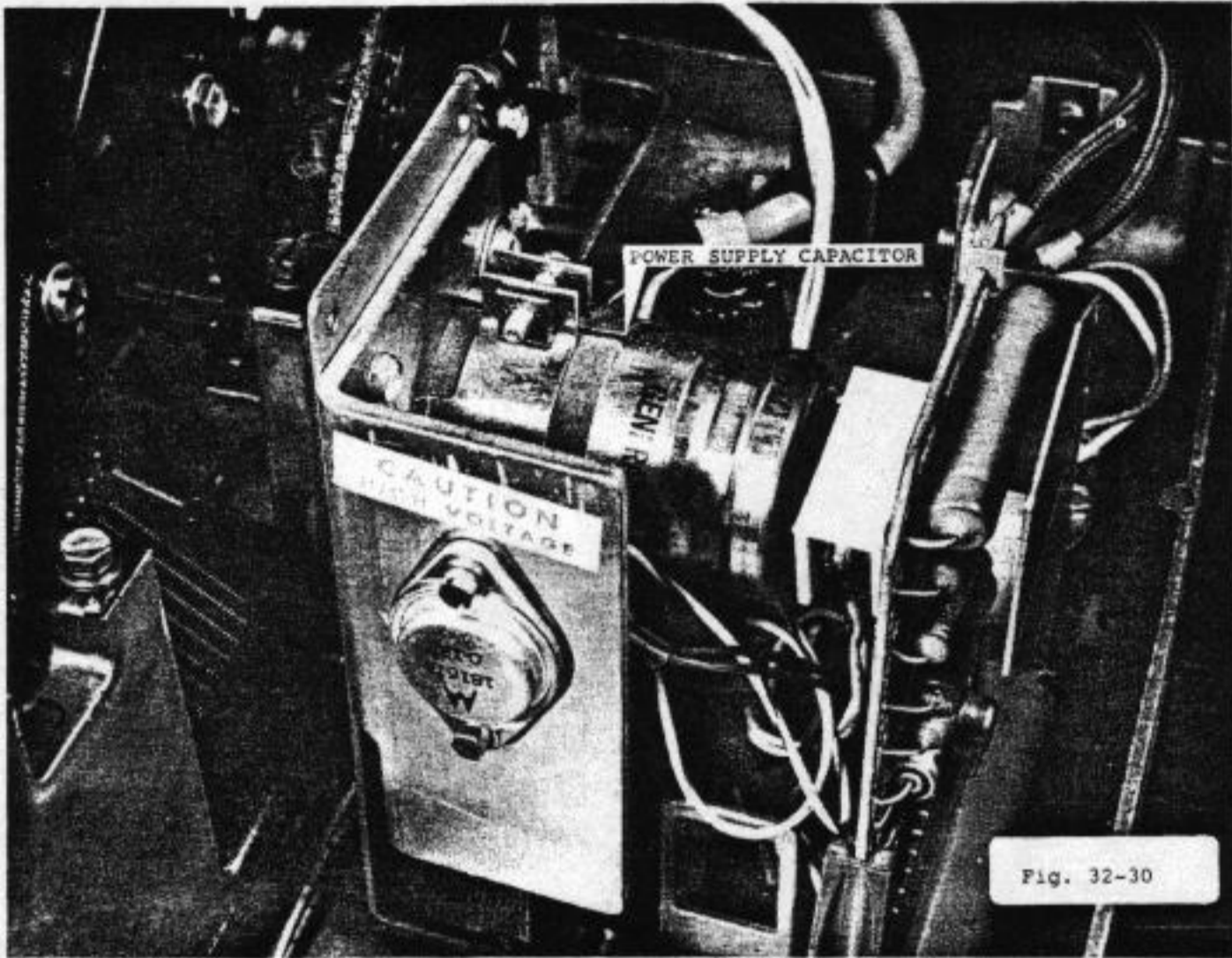

MODEL 32

Or a more thorough cleaning job can be done with a piece of wet cloth dabbed with a little Ajax or some powdered household cleaner. Be sure to remove all traces of powder.

- f) Power Supply Capacitor (Fig. 32-30) may have gone bad. Magnet current will drop from 500 mA to about 300 mA with this bad capacitor.
- g) Adjustment plate (Fig. 32-31) may be too far towards the front. Inspect and determine position of plate. If too far in front, adjust plate a little farther back.

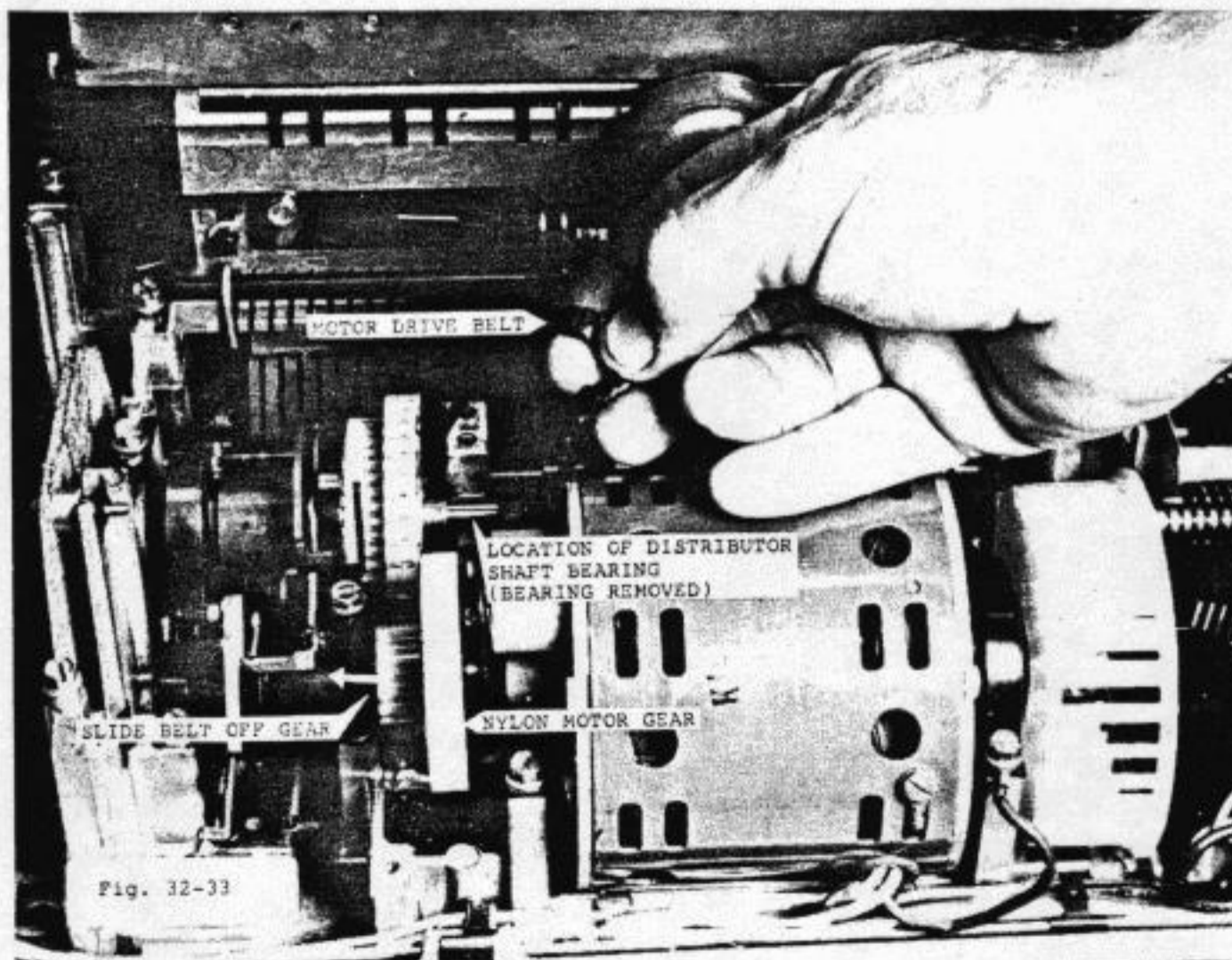
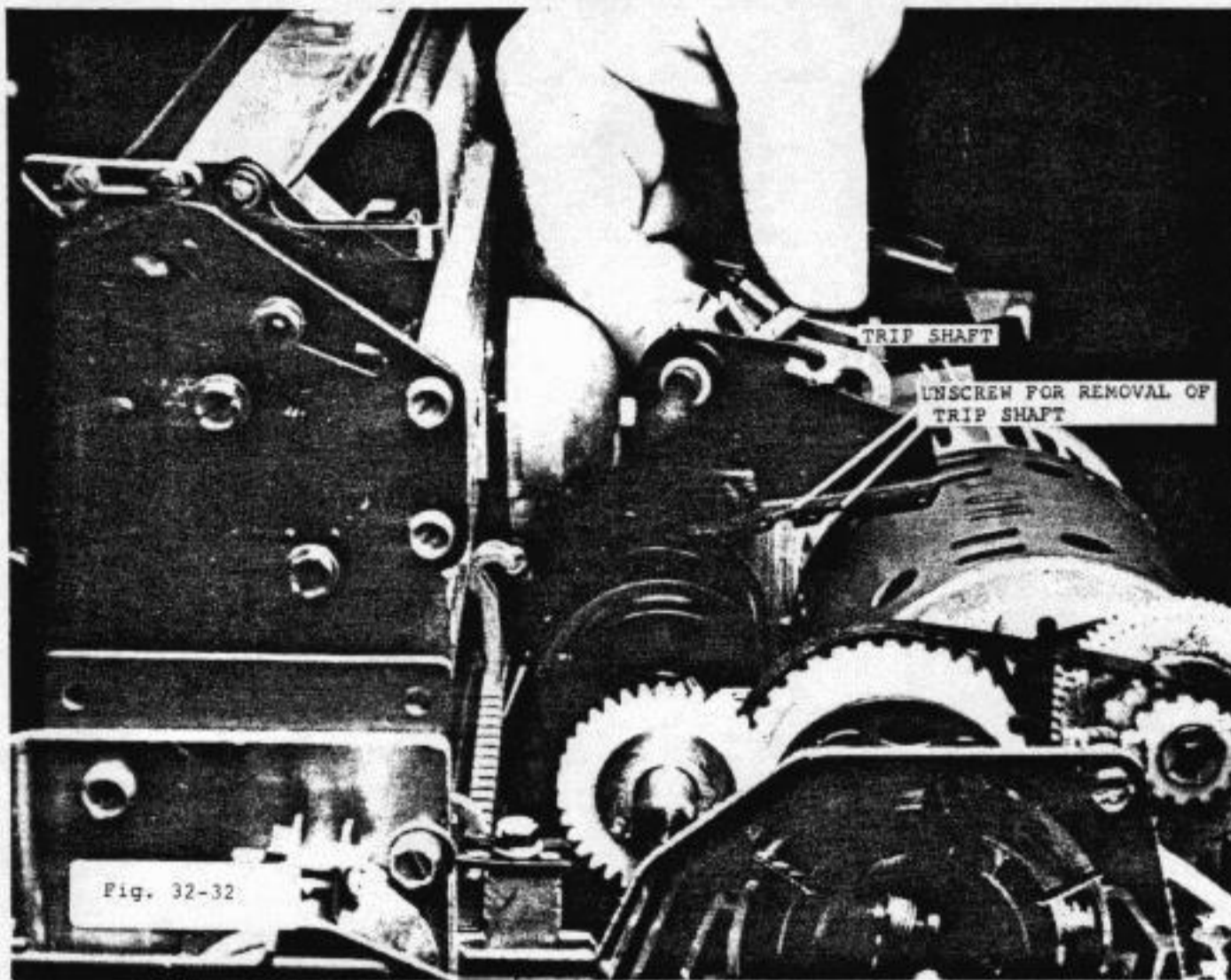

MODEL 32

C. REPLACING THE MOTOR DRIVE BELT

1. Unscrew and remove trip shaft according to Fig. 32-32. Be careful not to lose the 4 springs connected to the shaft since they come out easily.
2. Remove the bearings on the distributor shaft according to Fig. 32-33. Slide the rubber belt off the nylon motor gear (Fig. 32-33). Remove the motor drive belt. It might take some worming to do it.
3. Install new belt and assemble the parts back in place.

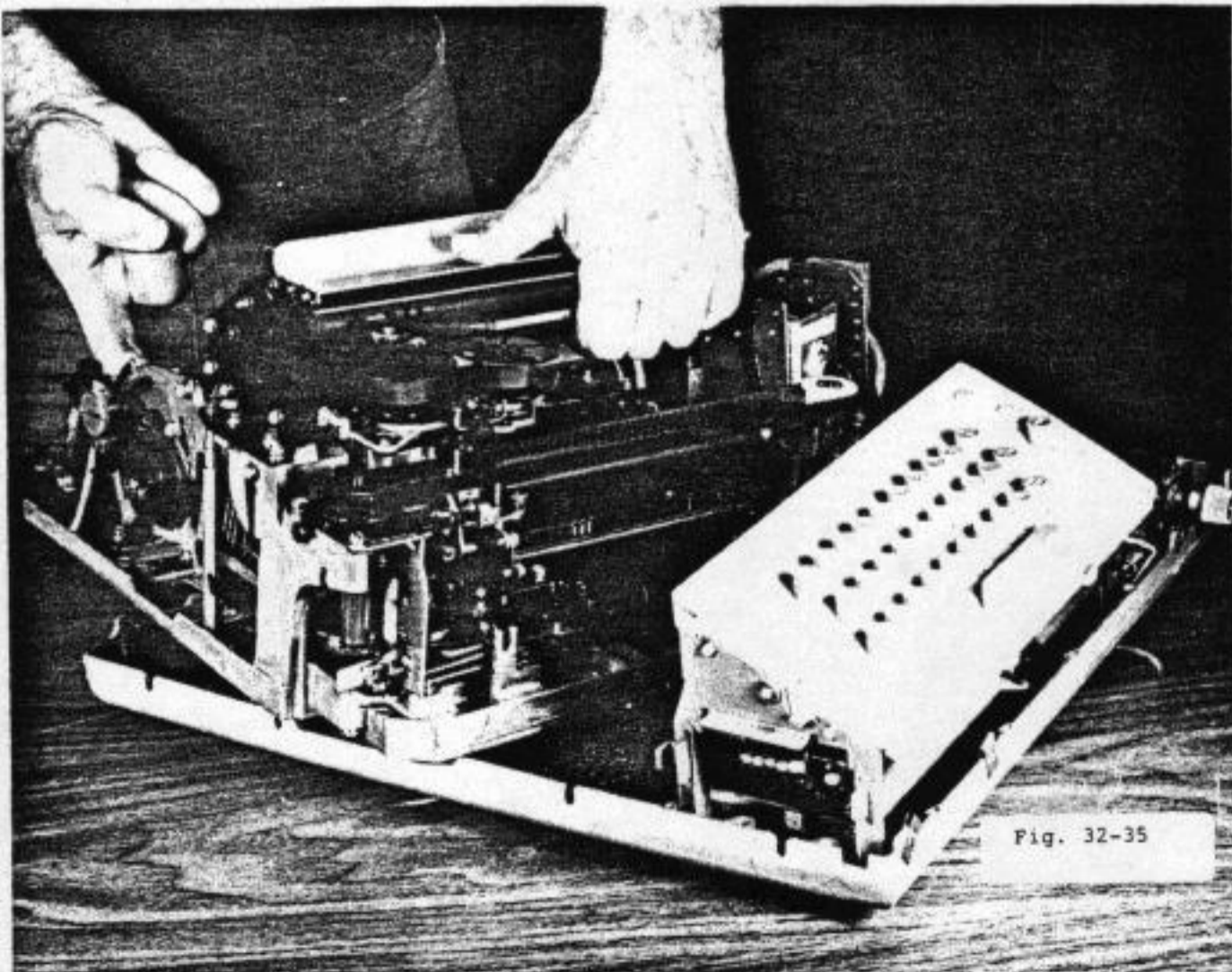
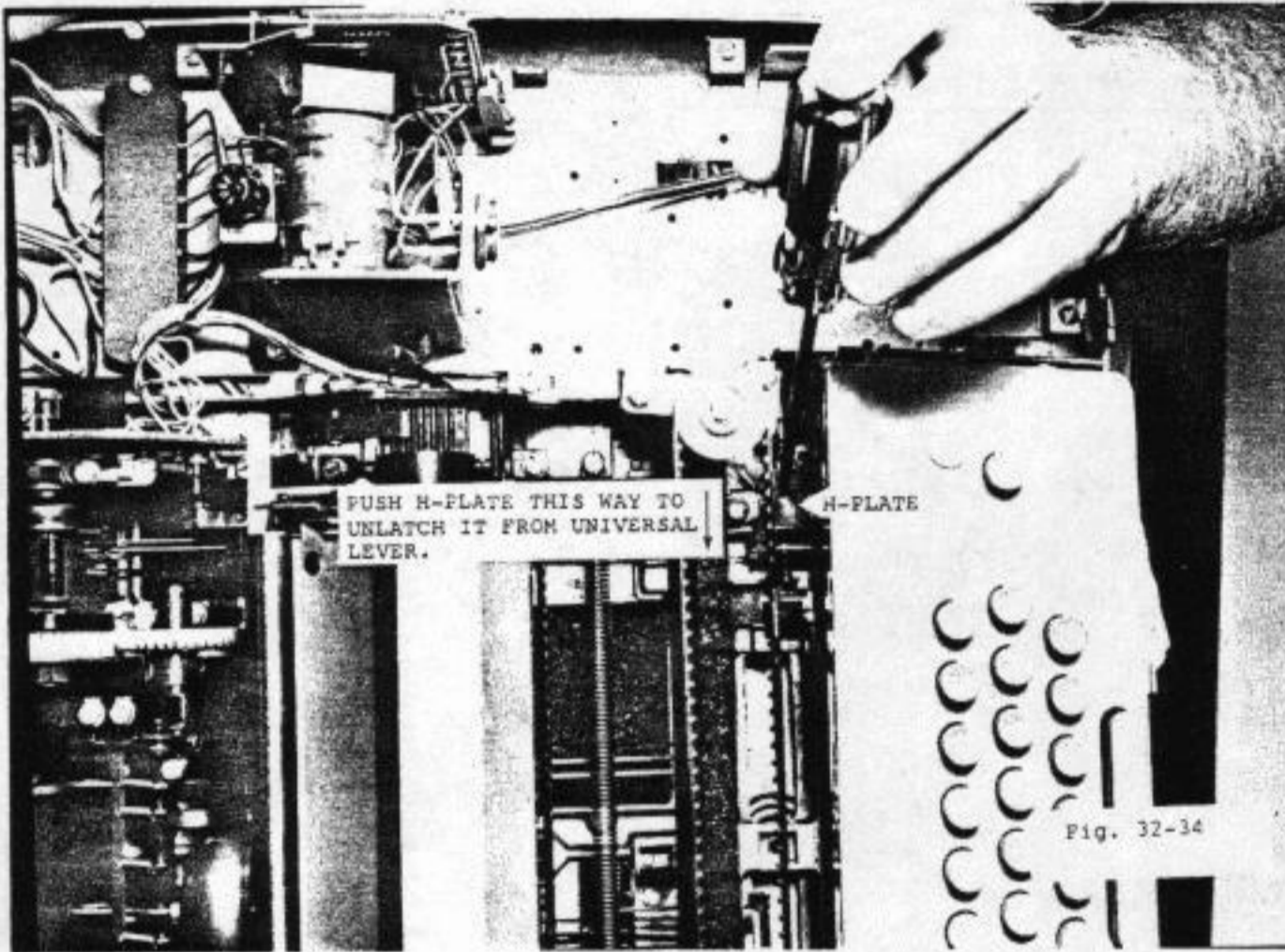

D. REMOVING THE TYPING UNIT

1. Unlatch the H-plate from the universal lever with a screwdriver by pushing it to the left according to Fig. 32-34.
2. Lift typing unit as shown in Fig. 32-35. For most jobs, it is not necessary to remove the wires since the wires are long enough for typing unit to be moved around a bit.

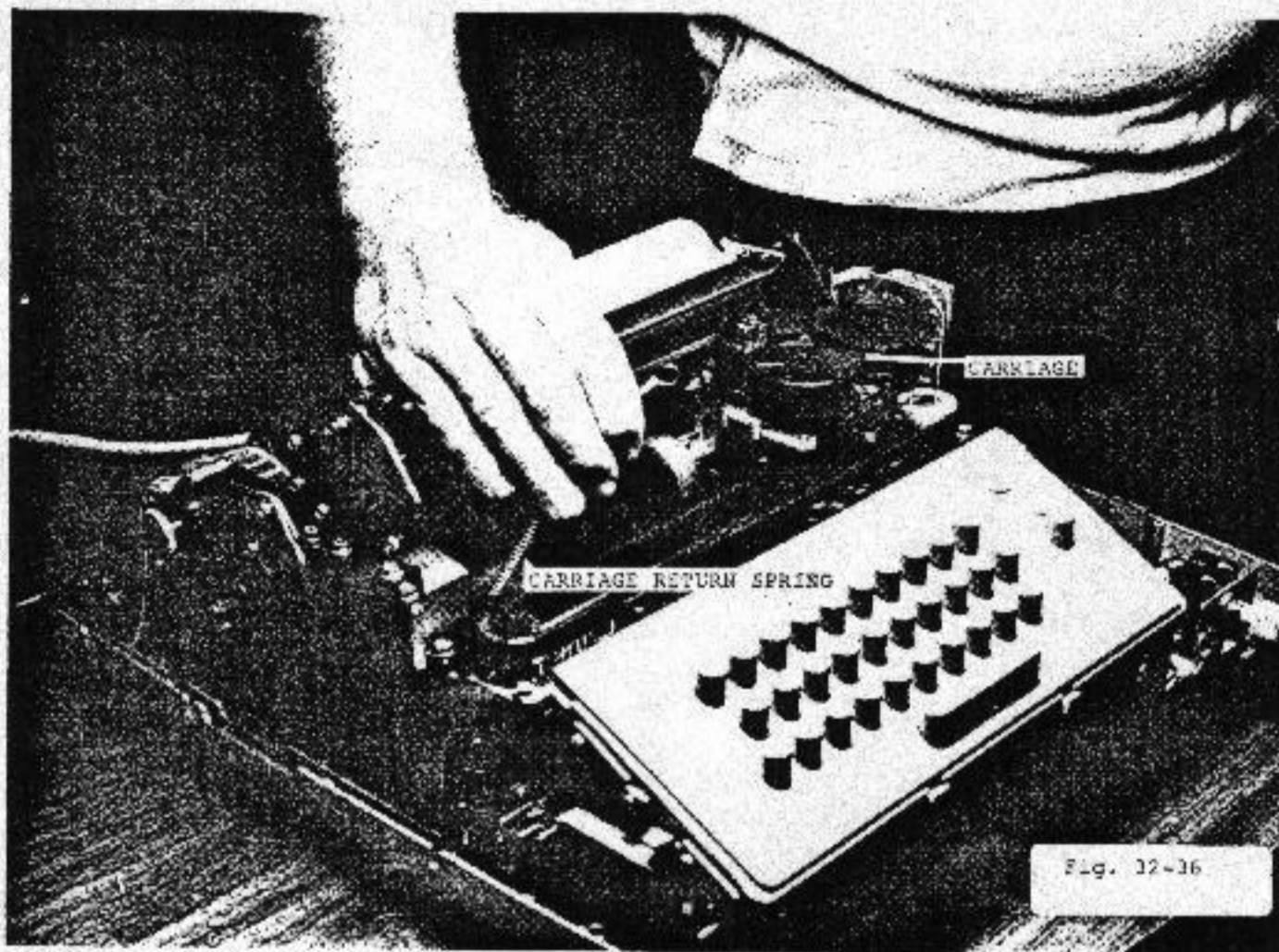

MODEL 32

E. REMOVING AND INSTALLING THE CARRIAGE

1. It is not necessary to remove the typing unit to remove just the carriage.
2. Remove carriage return spring according to Fig. 32-36.
3. Loosen right pulley mounting screws according to Fig. 32-37. Slide out the pulley.
4. Loosen the belt retainer mounting screws according to Fig. 32-38. Slide out the belt retainer.
5. Pull out the carriage front rail according to Fig. 32-39.
6. Carriage is now pulled out. See Fig. 32-40.
7. To install carriage, reposition carriage as shown in Fig. 32-41 and make sure that the rollers engage the carriage rear rail.
8. Using screwdriver as shown in Fig. 32-41, lift slides over code bars. Carriage should be tilted slightly to the left. Slides should ride on the codebars as shown in Fig. 32-42.
9. Reinstall the carriage front rail and make sure the notch on the left side of the rail is aligned with the nip in the belt retainer.

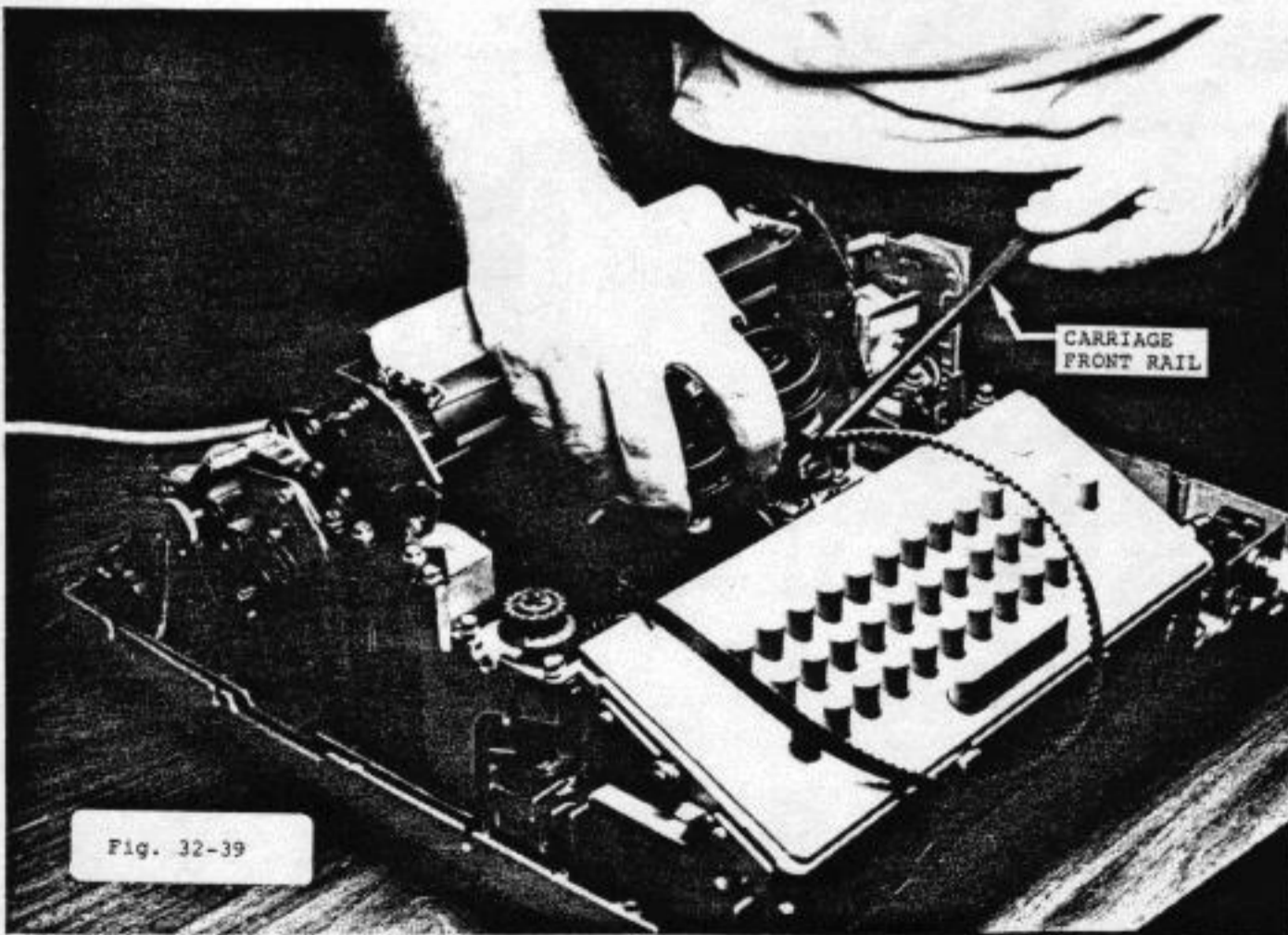

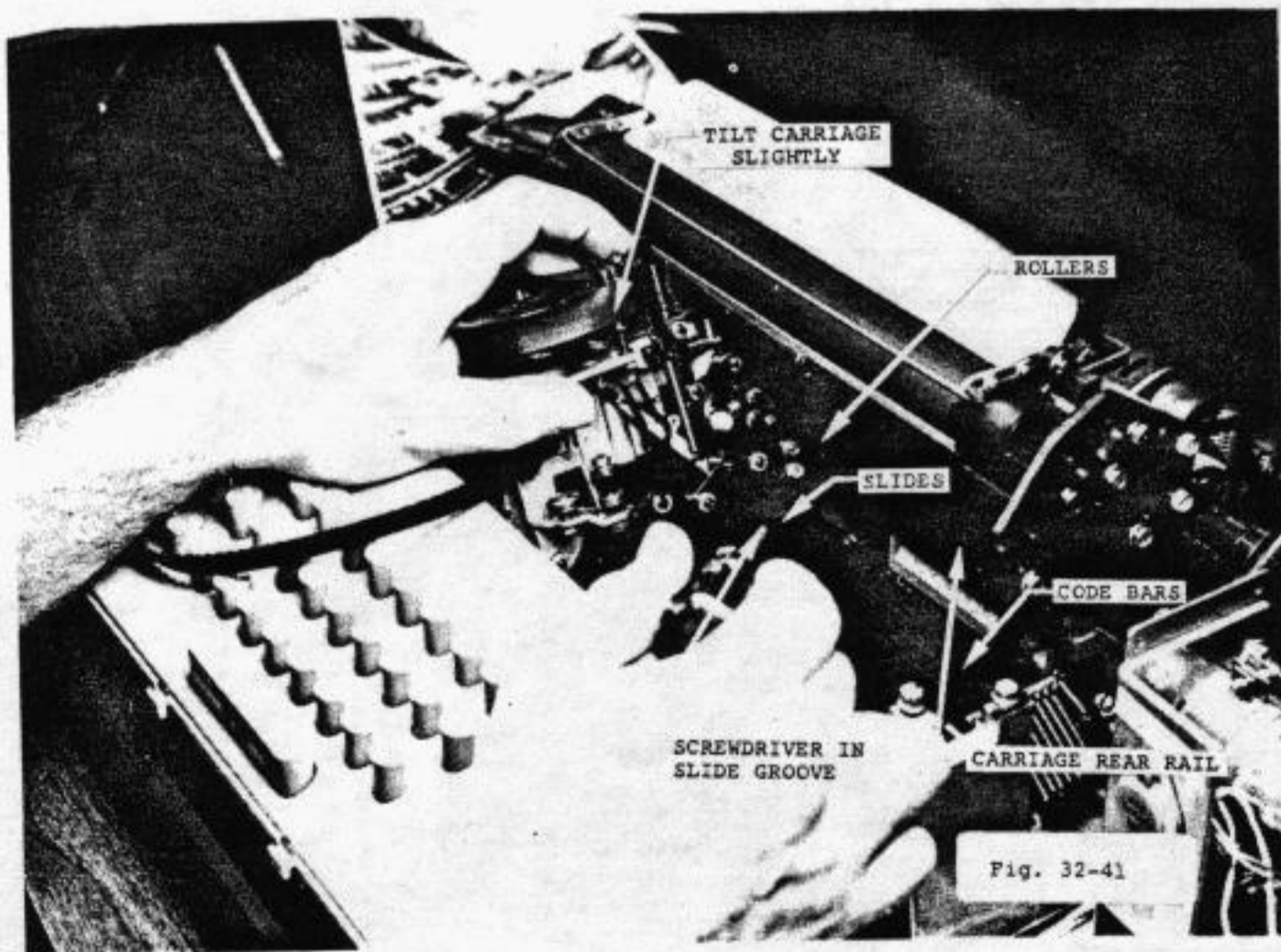
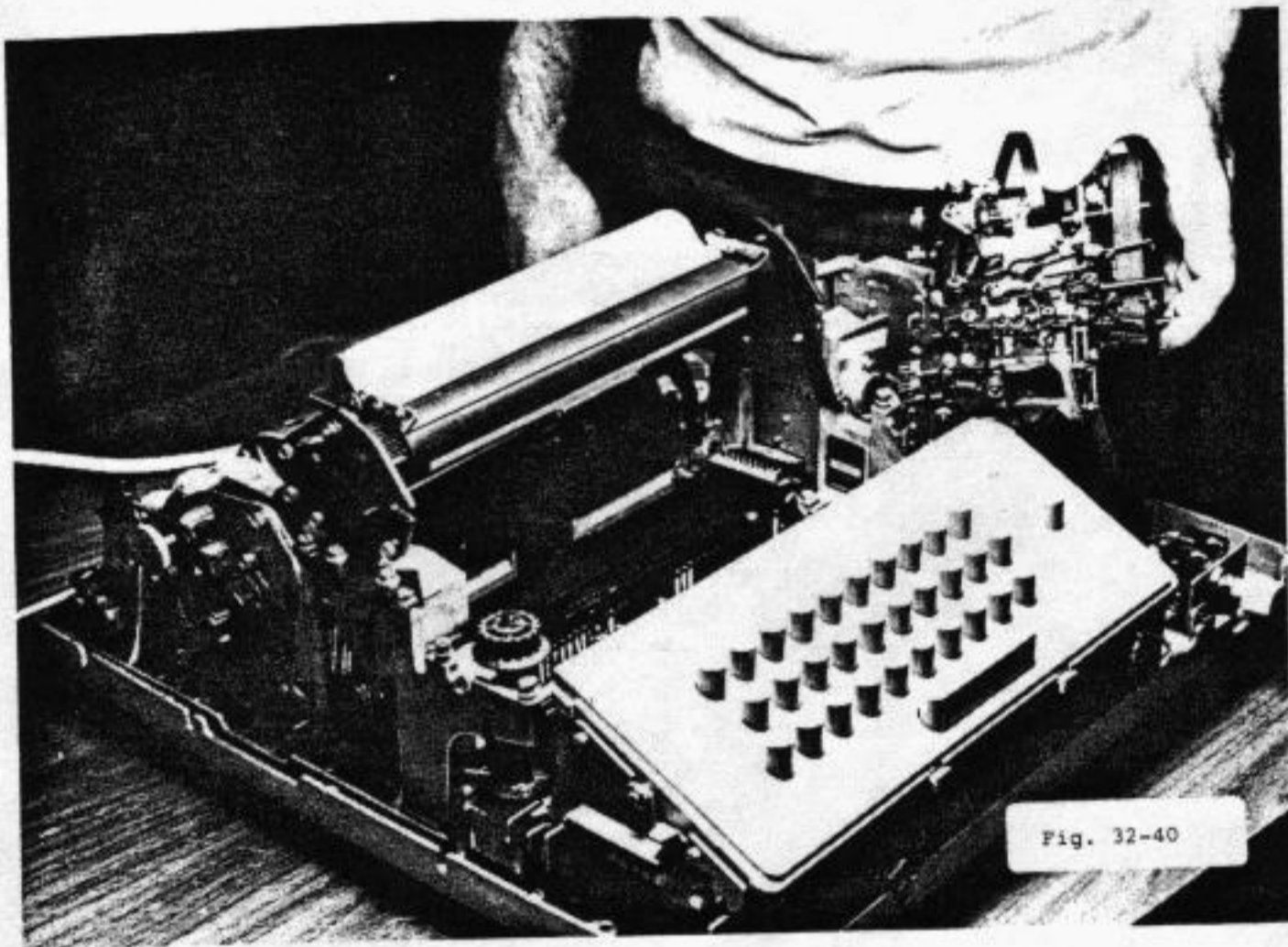

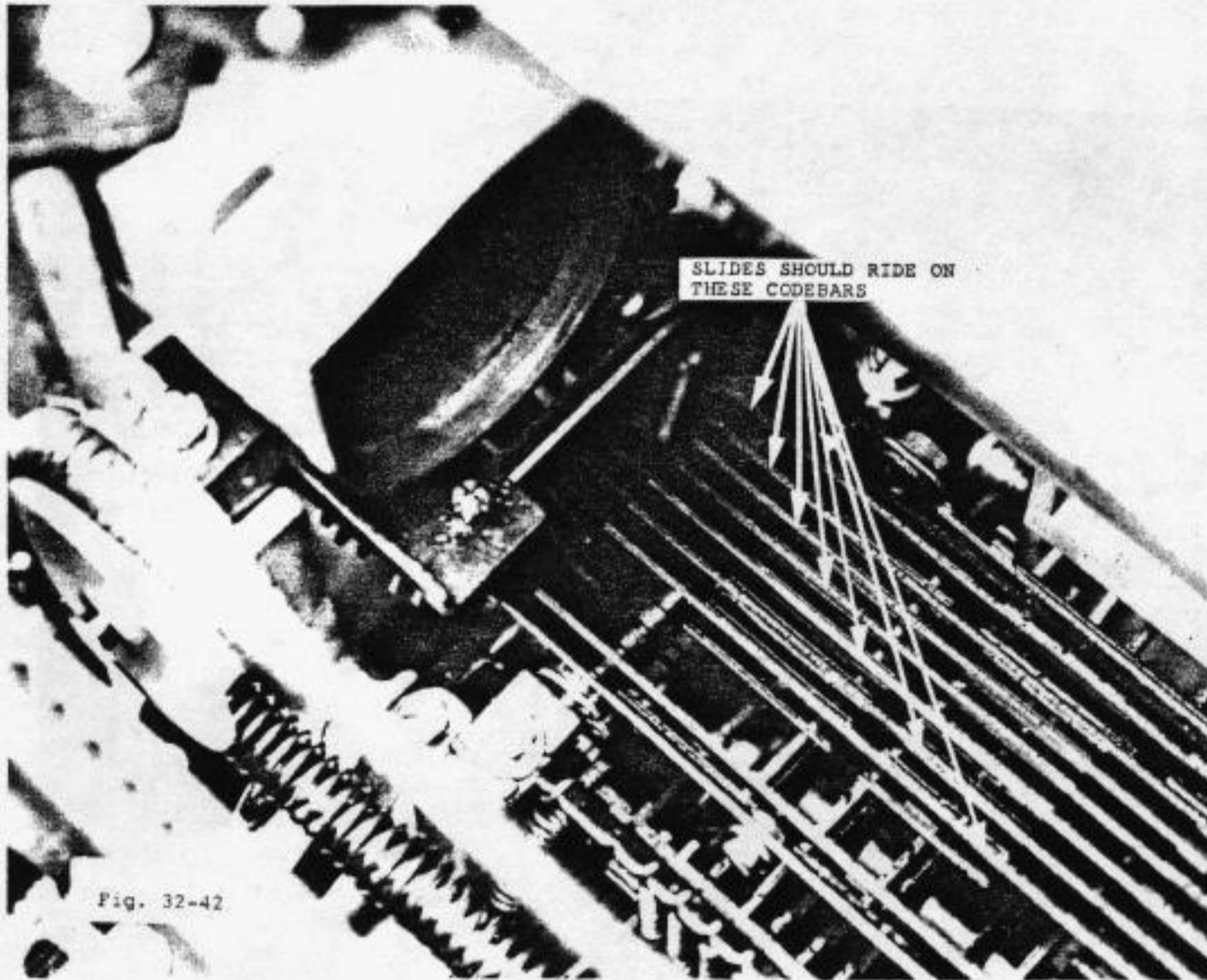

SLIDES SHOULD RIDE ON THESE CODEBARS

Fig. 32-42

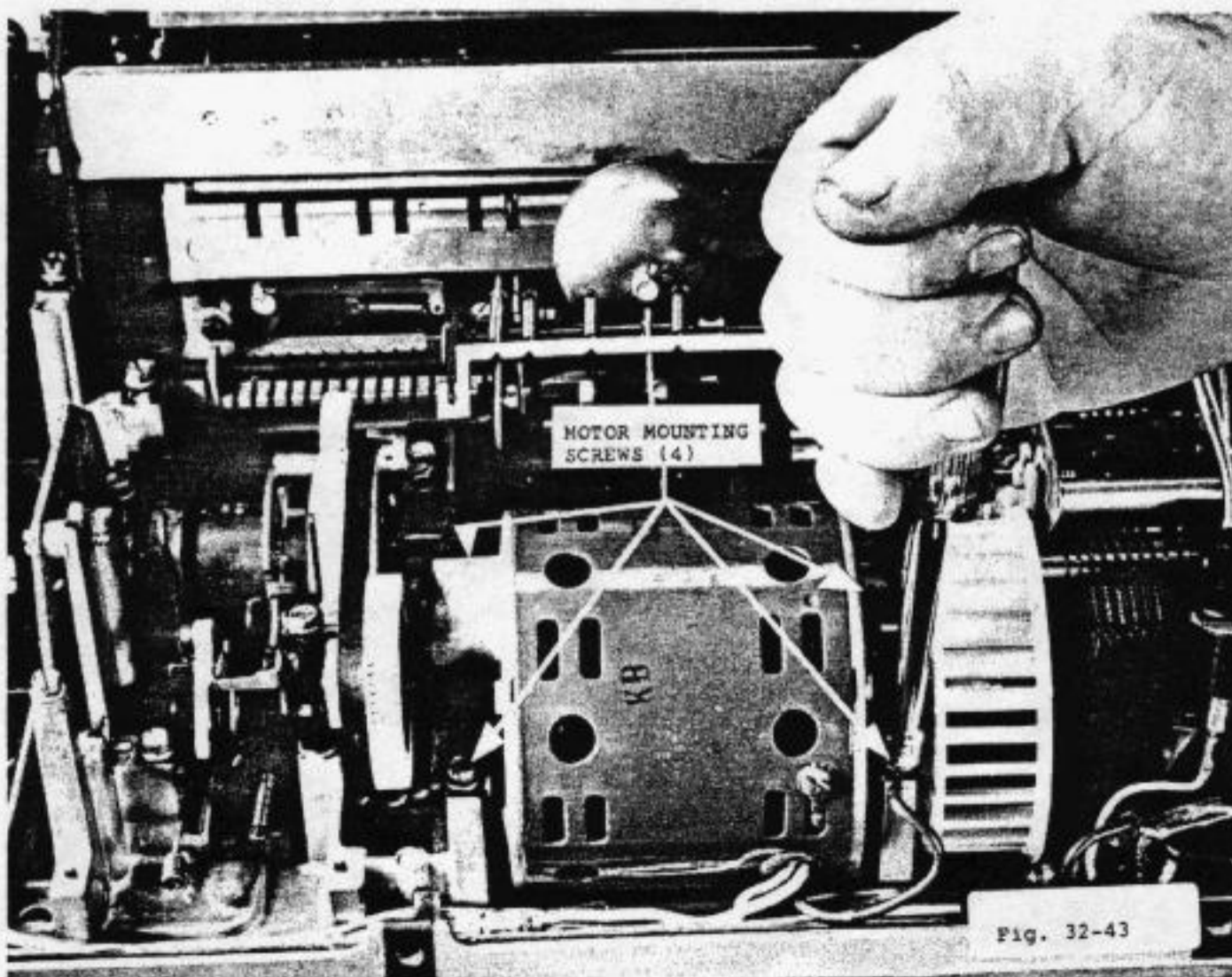

MOTOR MOUNTING
SCREWS (4)

Fig. 32-43

F. REPLACING THE MOTOR DRIVEN GEAR AND PINION

1. Remove the 4 motor mounting screws according to Fig. 32-43.
2. Slide the motor driven belt off and lift motor according to Fig. 32-44.
3. Pull out snap ring according to Fig. 32-45.
4. Remove nylon gear according to Fig. 32-46 and check pinion for extent of wear.
5. When replacing gears, make sure that gear and pinion are meshed NOT TOO LOOSE or TOO TIGHT. Refer to Fig. 32-47. Adjustment can be made by referring to Fig. 32-48.
6. Reinstall motor and replace belt. Adjust tension of belt according to Fig. 32-49.

Note: 60 WPM Gear and Pinion are Teletype Corp. Part Nos. 181417 and 181411.

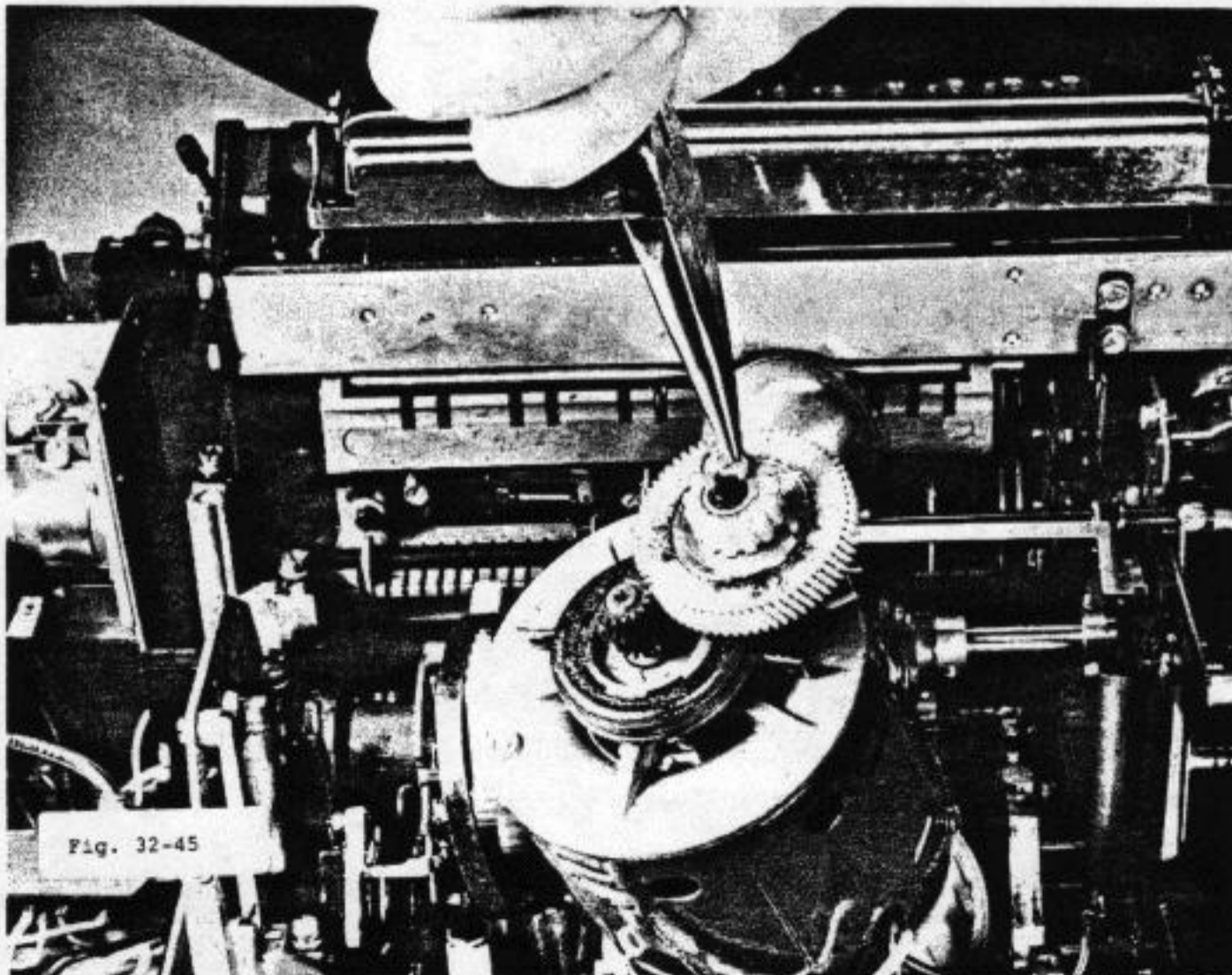
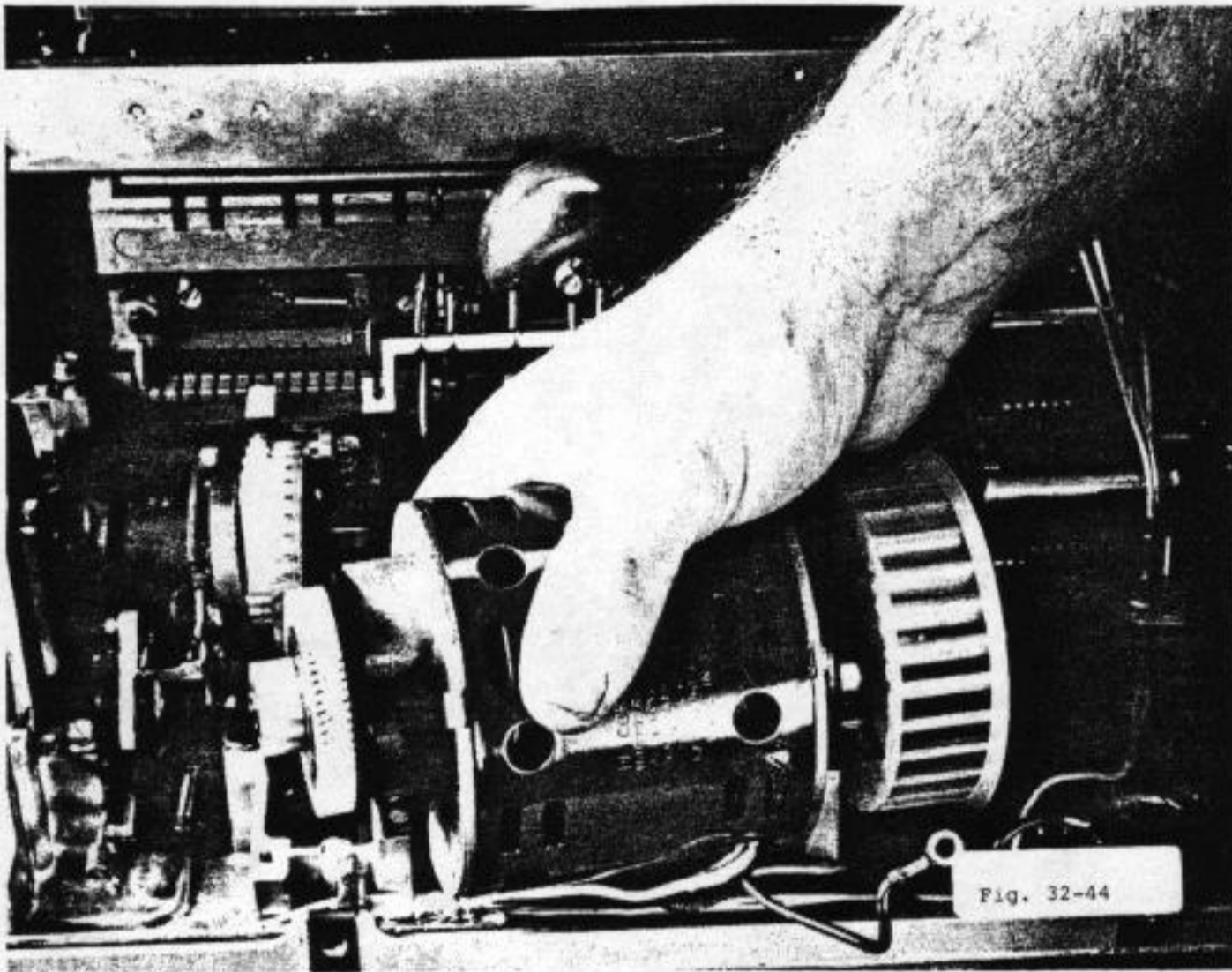

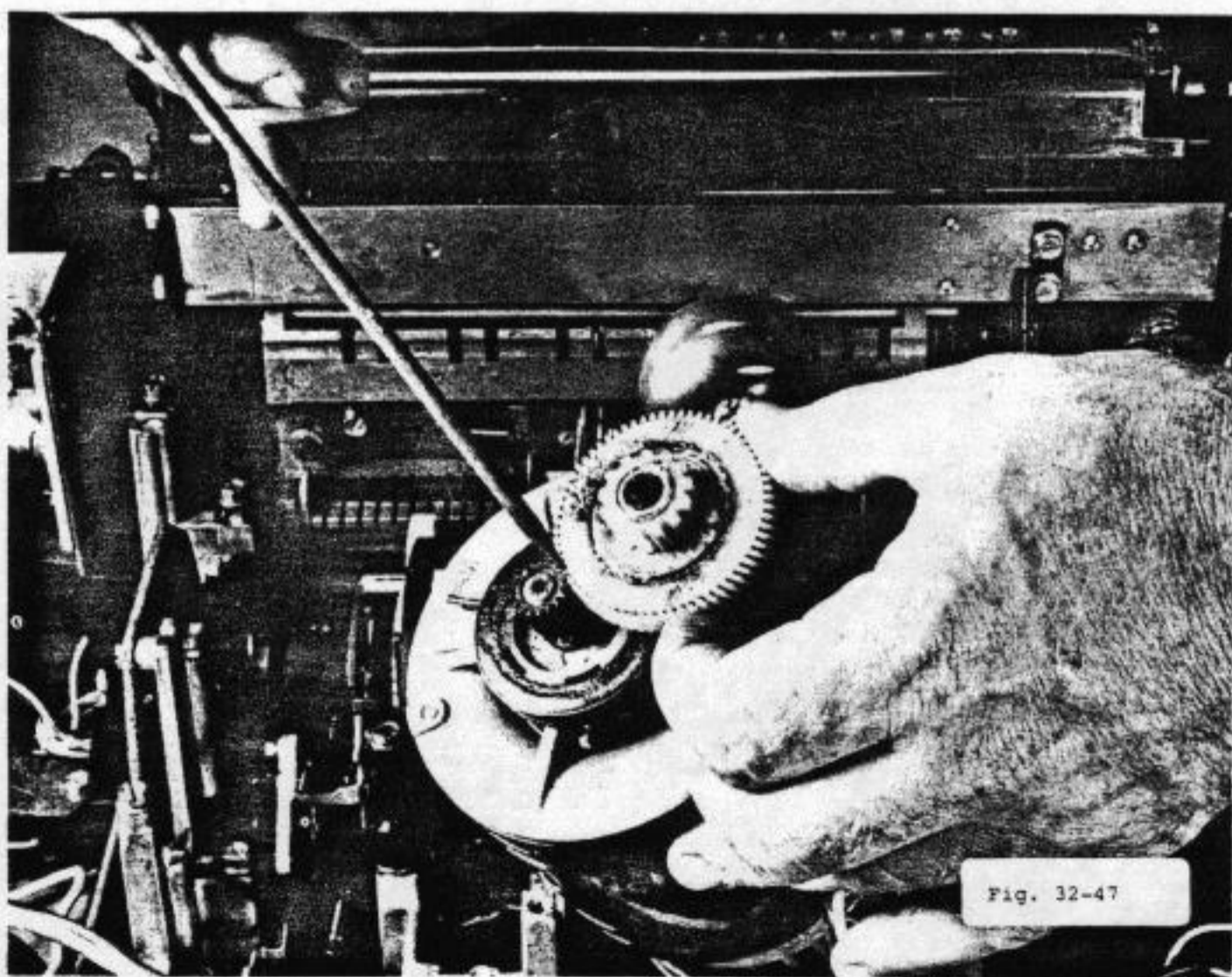
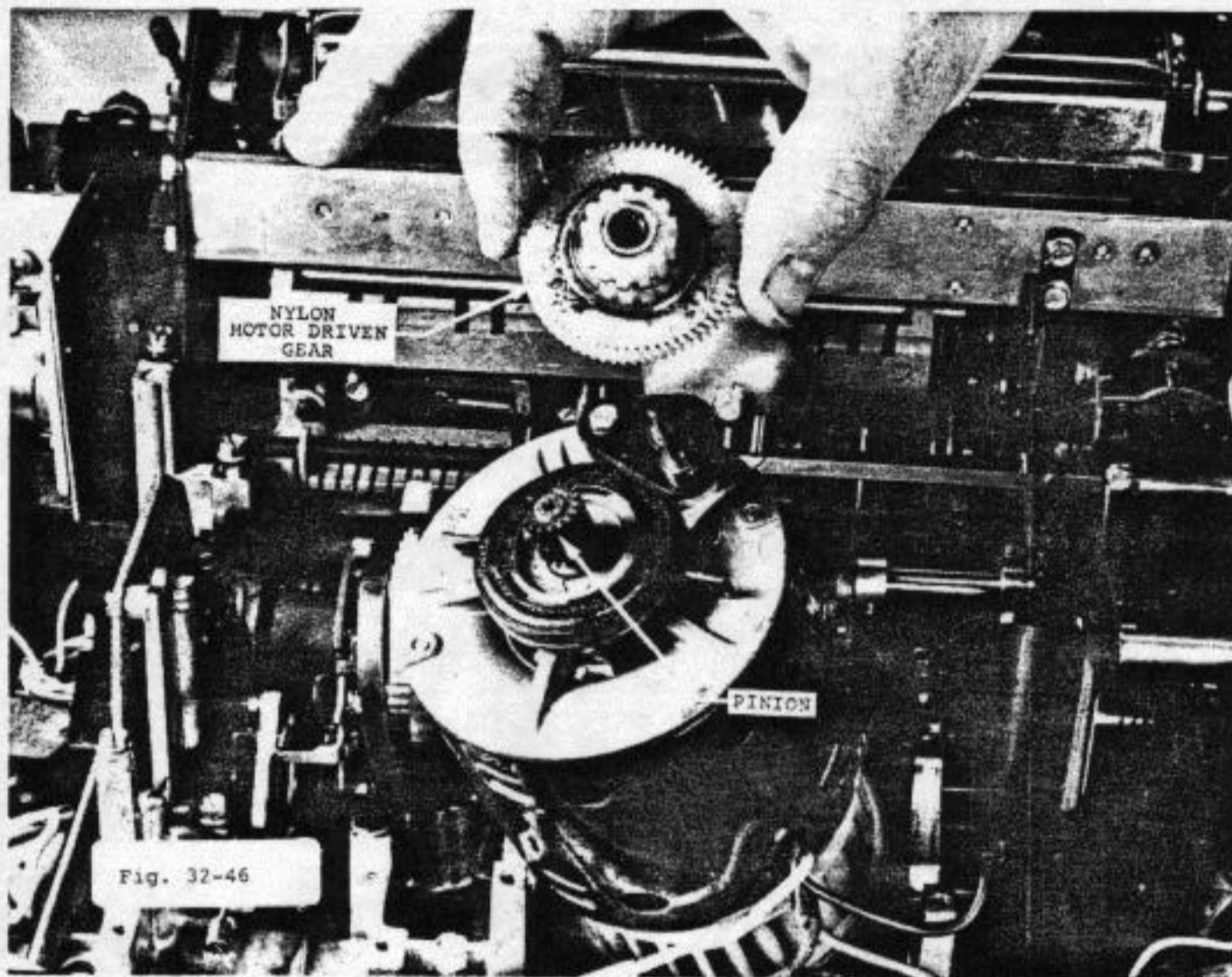

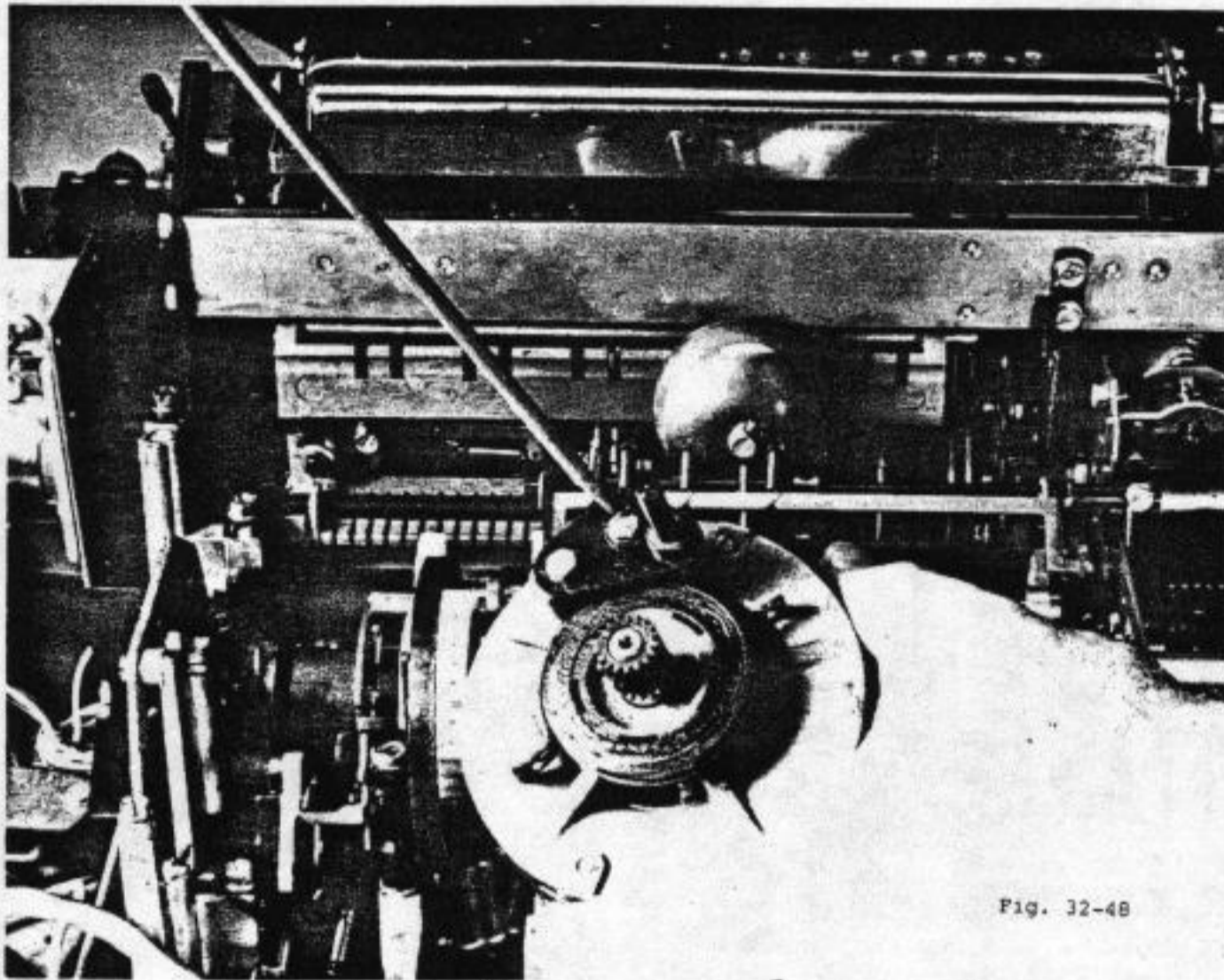
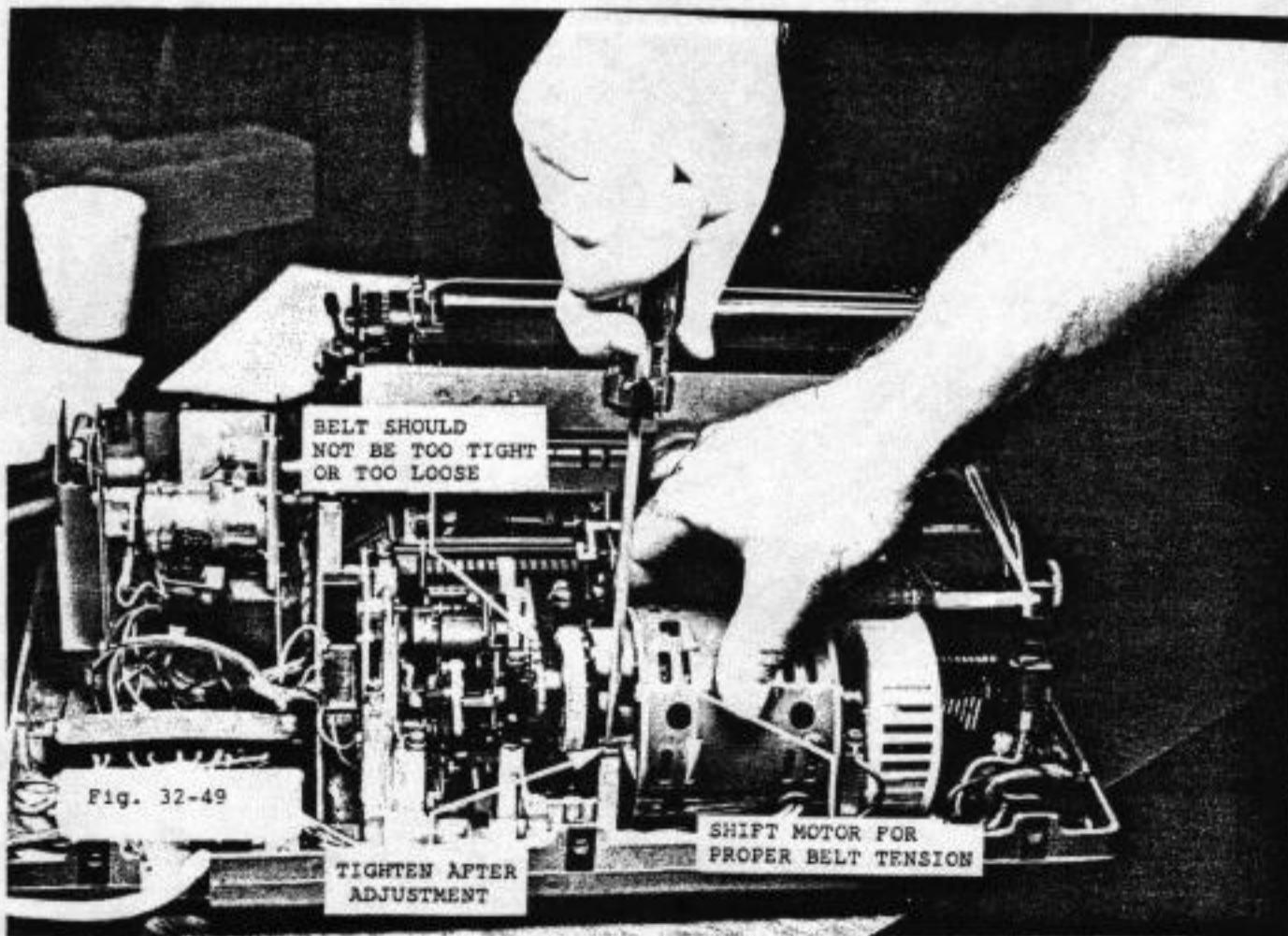
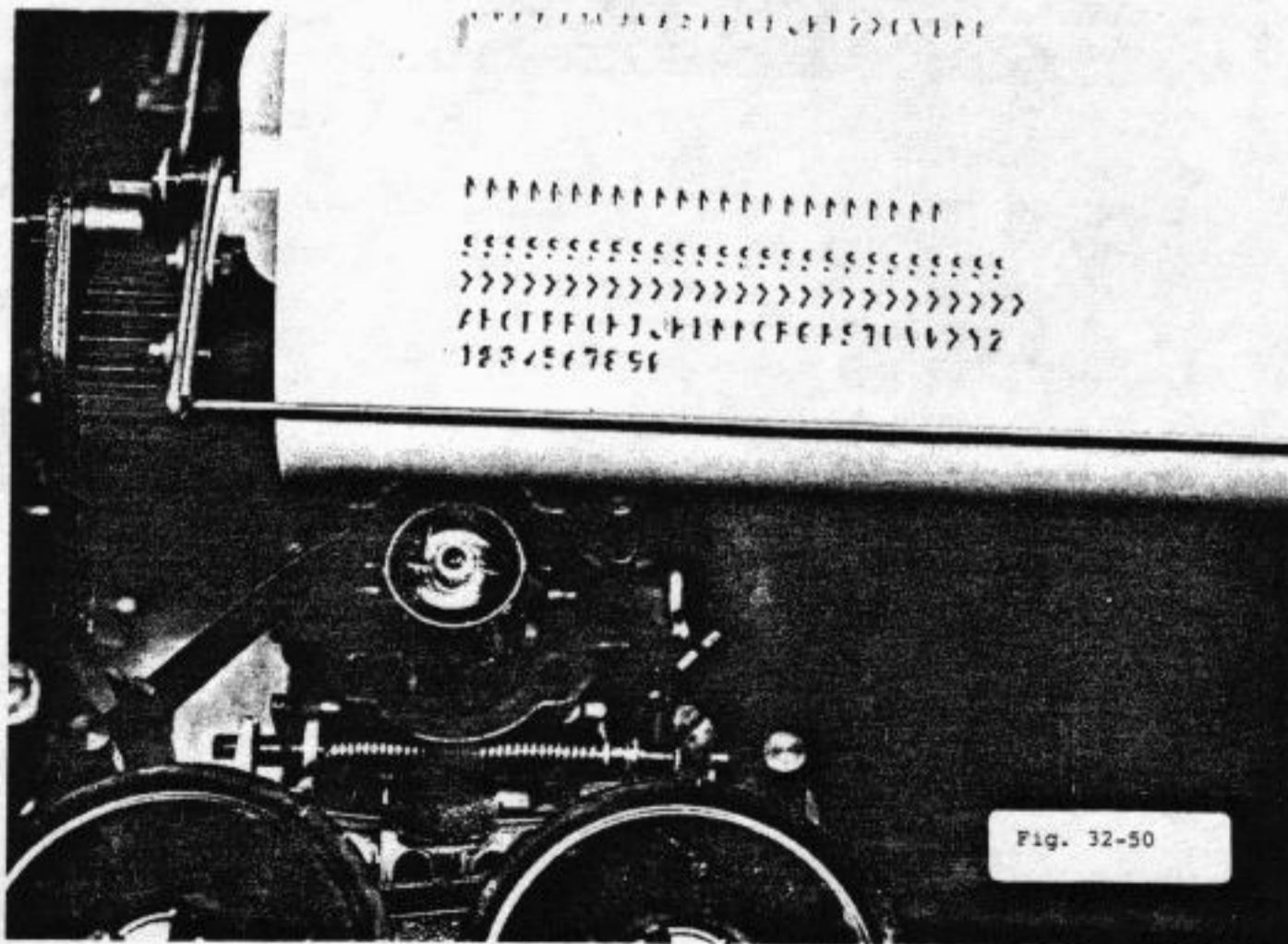

Fig. 32-48



G. ADJUSTING UNIFORMITY OF PRINTED CHARACTERS

1. Fig. 32-50 shows that the printed characters are not uniform.
2. Use tool #180588 to adjust typewheel according to Fig. 32-51. Tighten and try a few printed letters and check. Several attempts may be required to achieve desired results.
3. If steps 1 and 2 above do not achieve desired results, refer to Fig. 32-52 for adjustment instructions and to Fig. 32-53 for location of adjustment points.



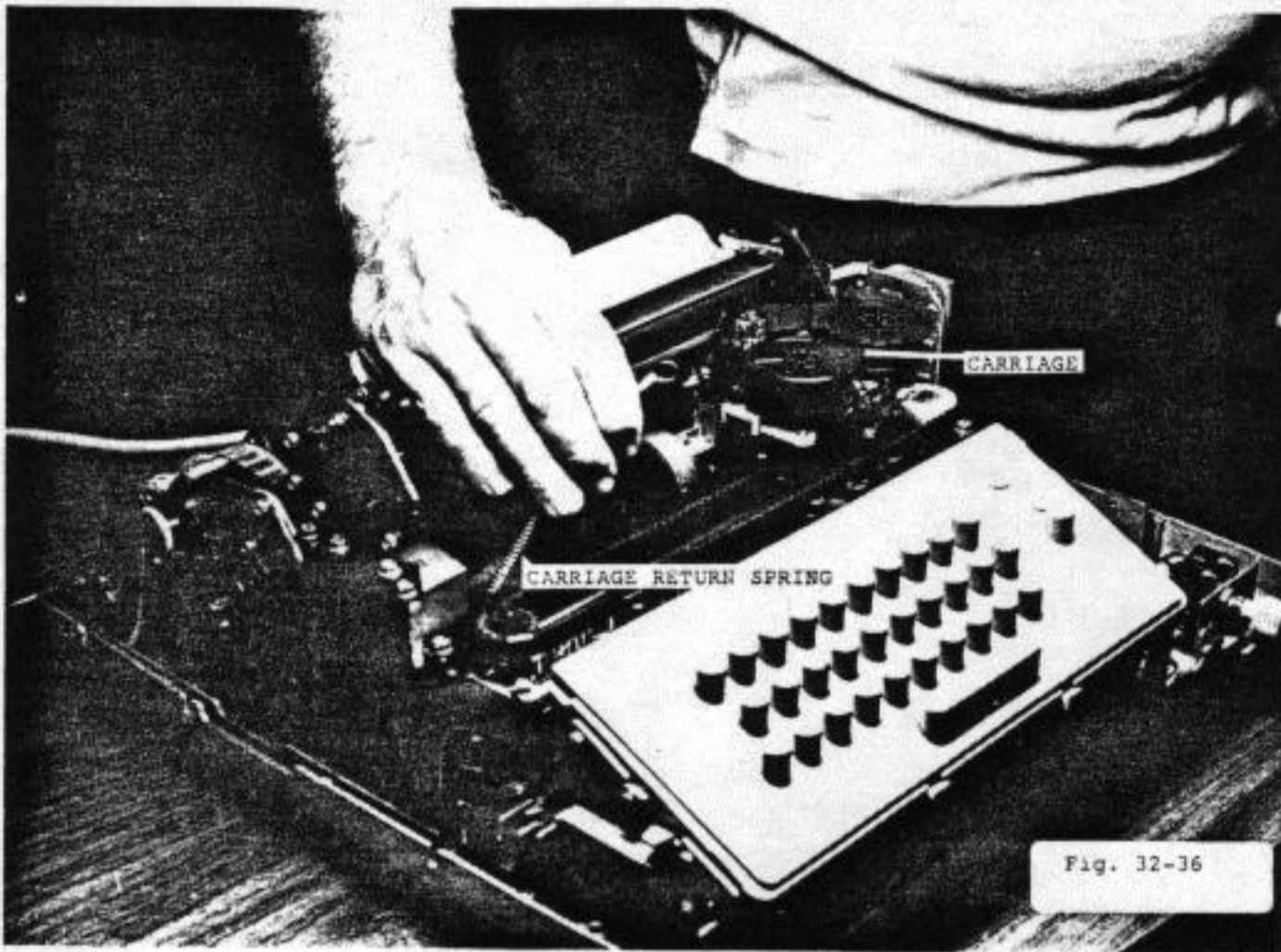

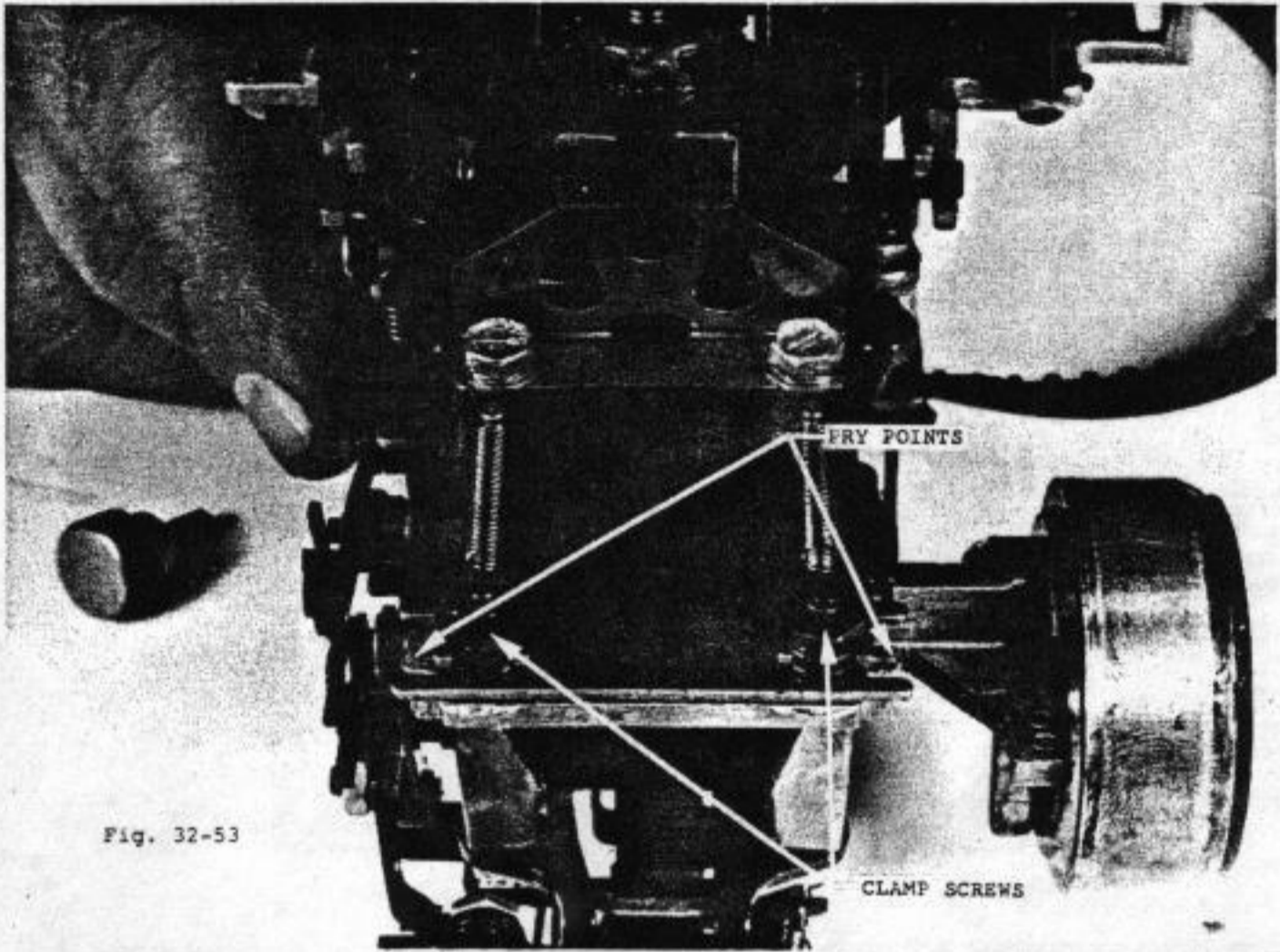
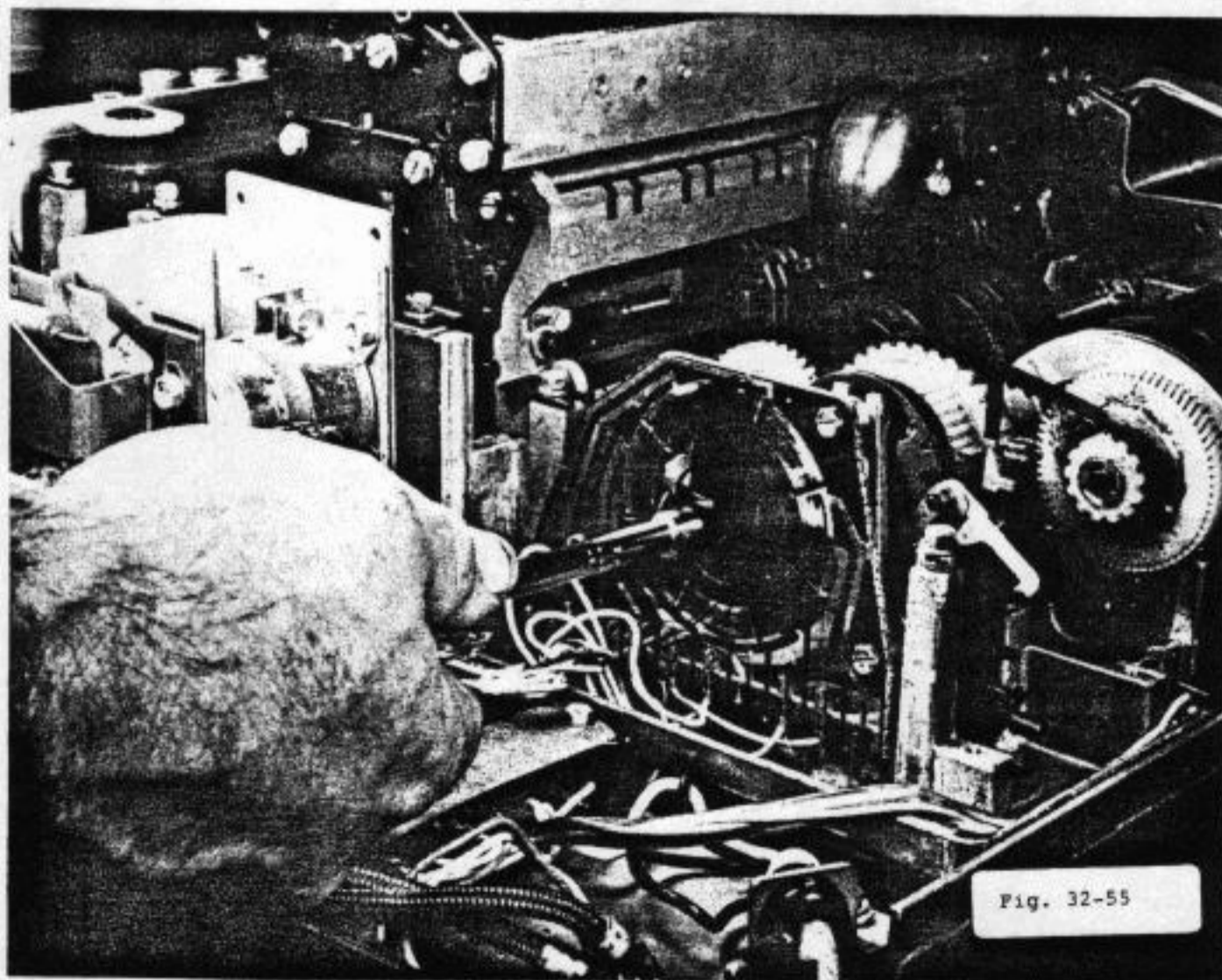
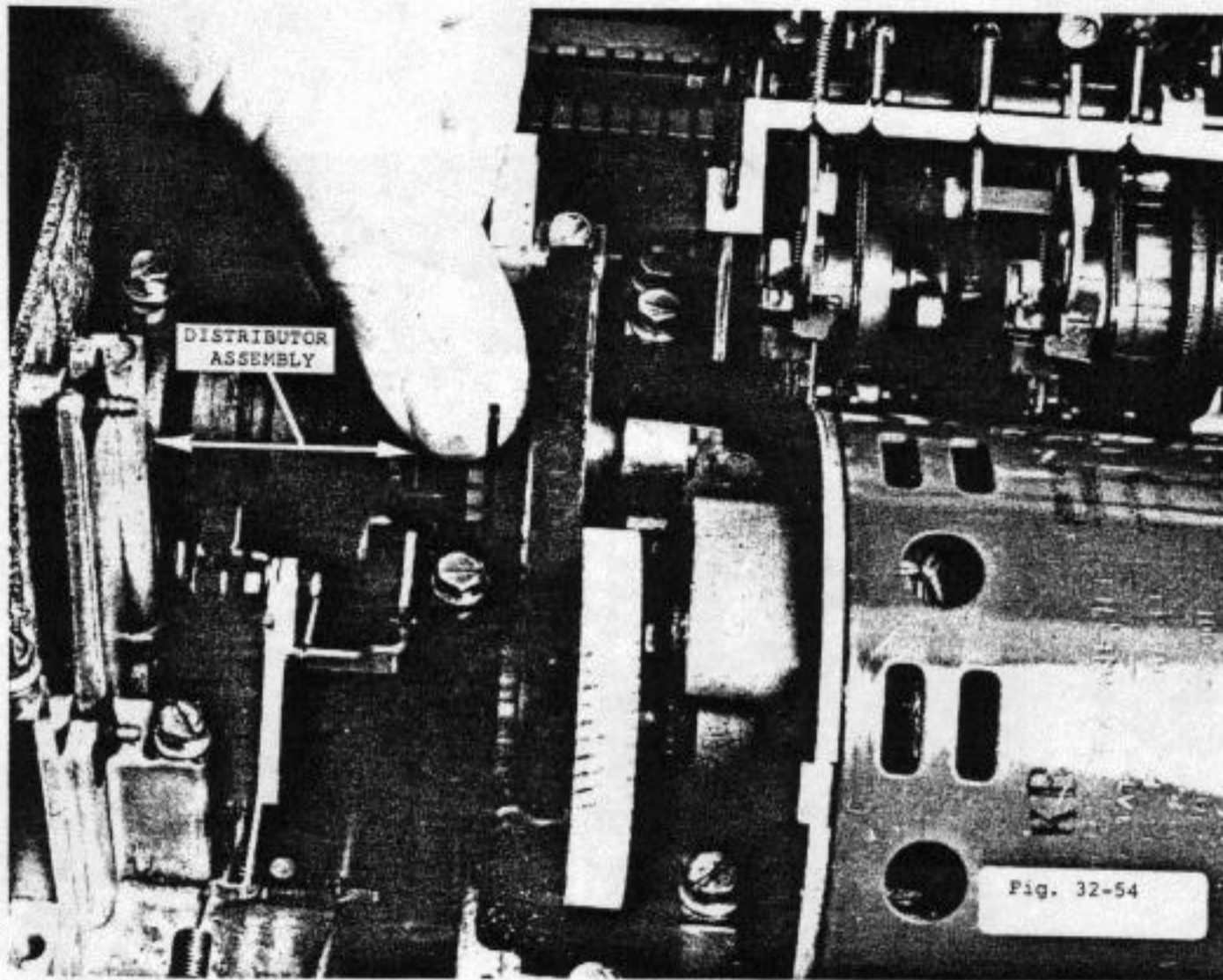
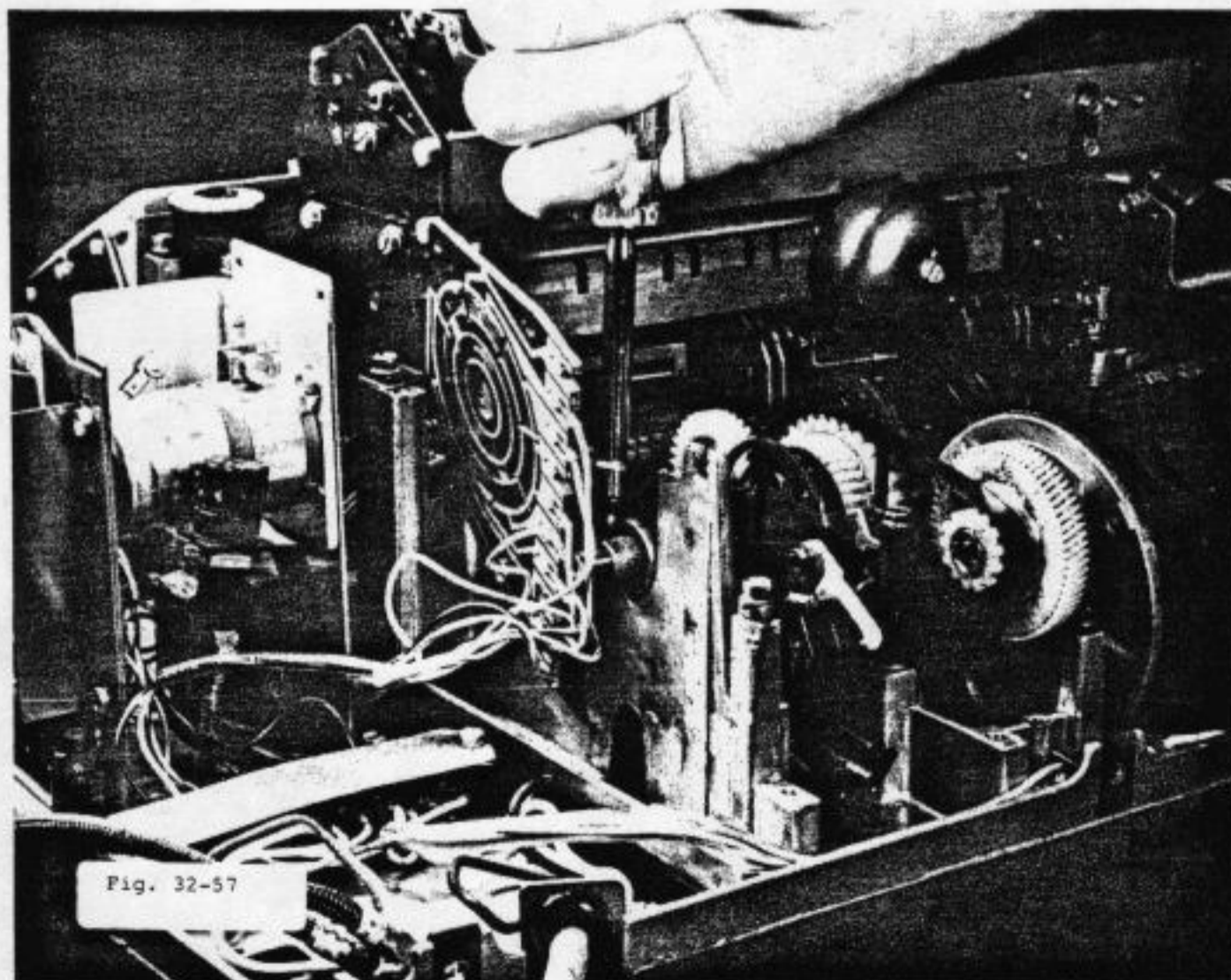
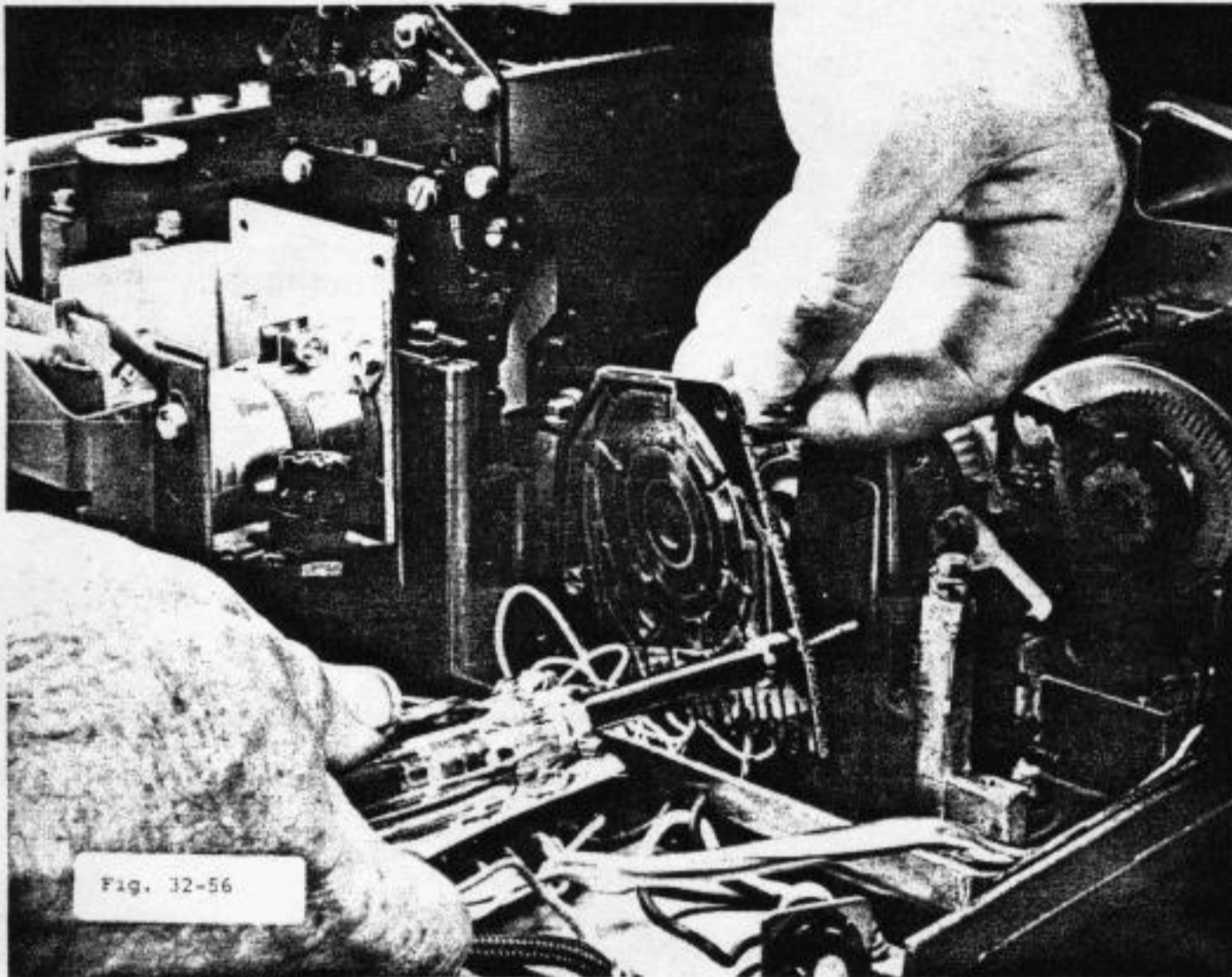

Fig. 32-53



H. REMOVING THE DISTRIBUTOR ASSEMBLY

1. Fig. 32-54 shows the assembly. Shake the assembly for tightness of fit.
2. Looseness of fit indicates worn bearings. They should be replaced.
3. Remove the trip shaft according to Fig. 32-32.
4. Remove the distributor brush holder according to Fig. 32-55.
5. Remove the distributor face from its mount by removing the three mounting screws according to Fig. 32-56.
6. Remove the bearing clamp according to Fig. 32-57.
7. Pull out the distributor shaft assembly according to Fig. 32-58.
8. Disengage the drum from the clutch. First, pinch the latchlever and the stoplug together to make drum come off easily. Refer to Fig. 32-59.
9. Replace bearings, gears, or clutch assembly parts as needed.
10. Replace distributor assembly parts. When remounting the distributor brush holder, make sure that pointer is in line with locating mark. See Fig. 32-60. Note that the distributor clutch must be latched. To latch it, push nylon driven gear down (as in Fig. 32-14) until clutch is latched.
11. More details about the clutch is given in Fig. 32-61.



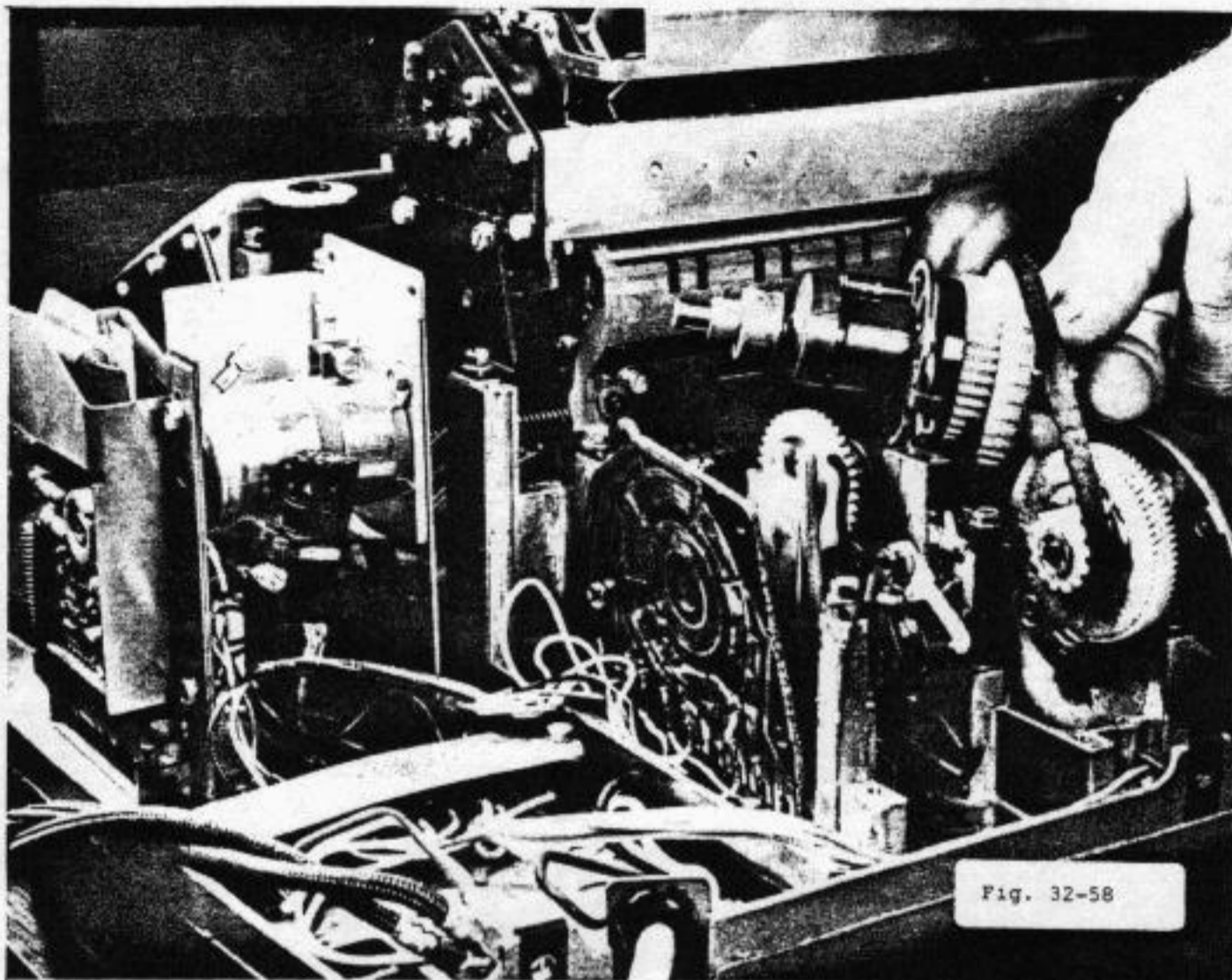

Fig. 32-58

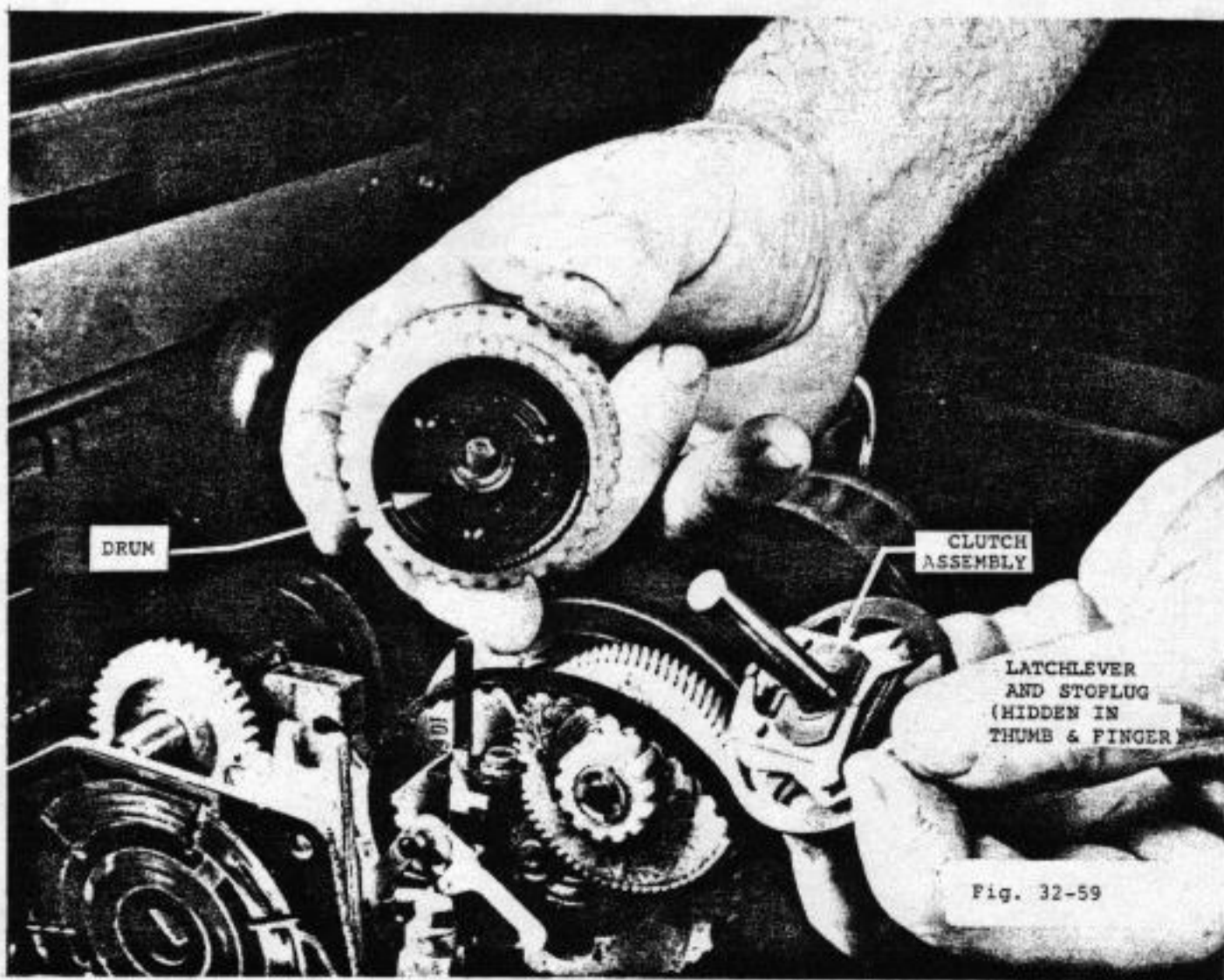
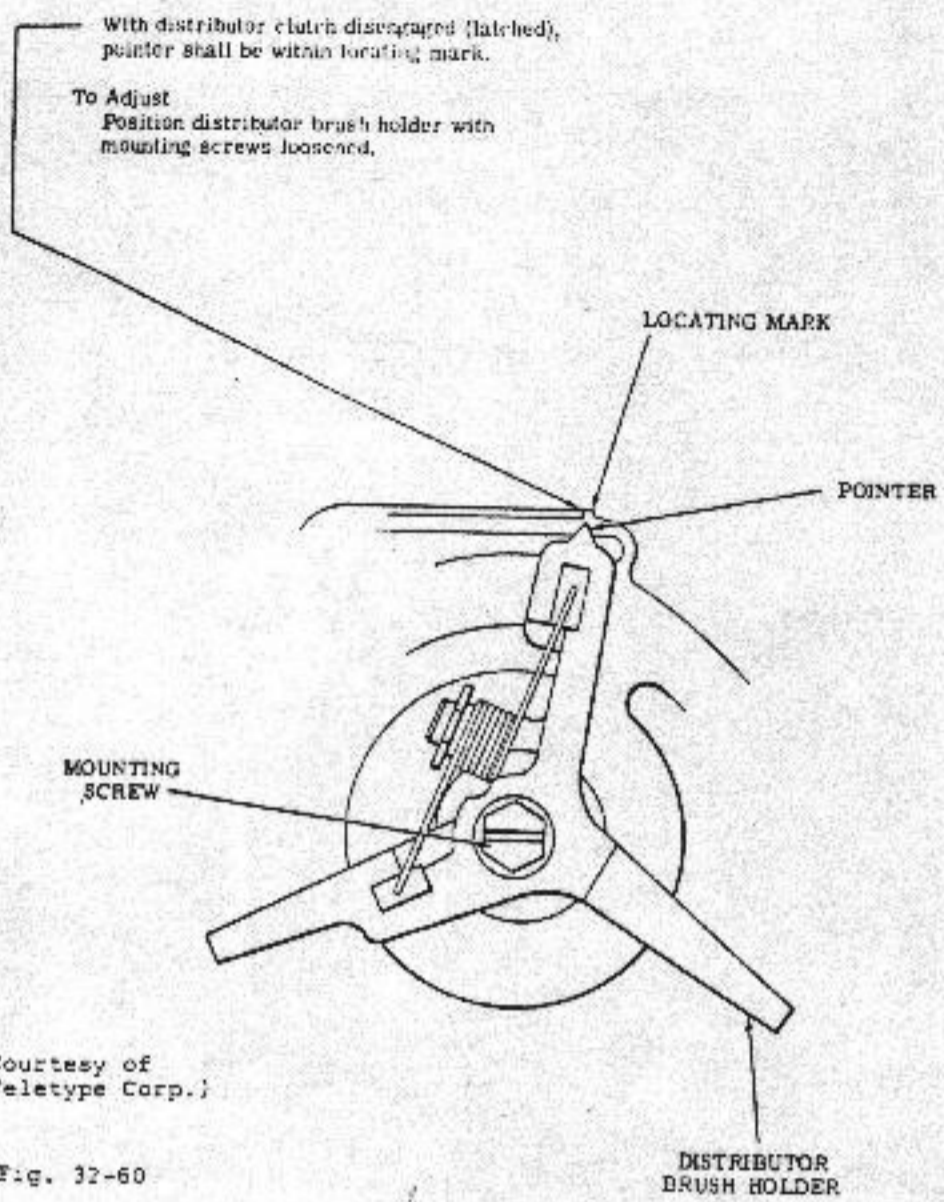
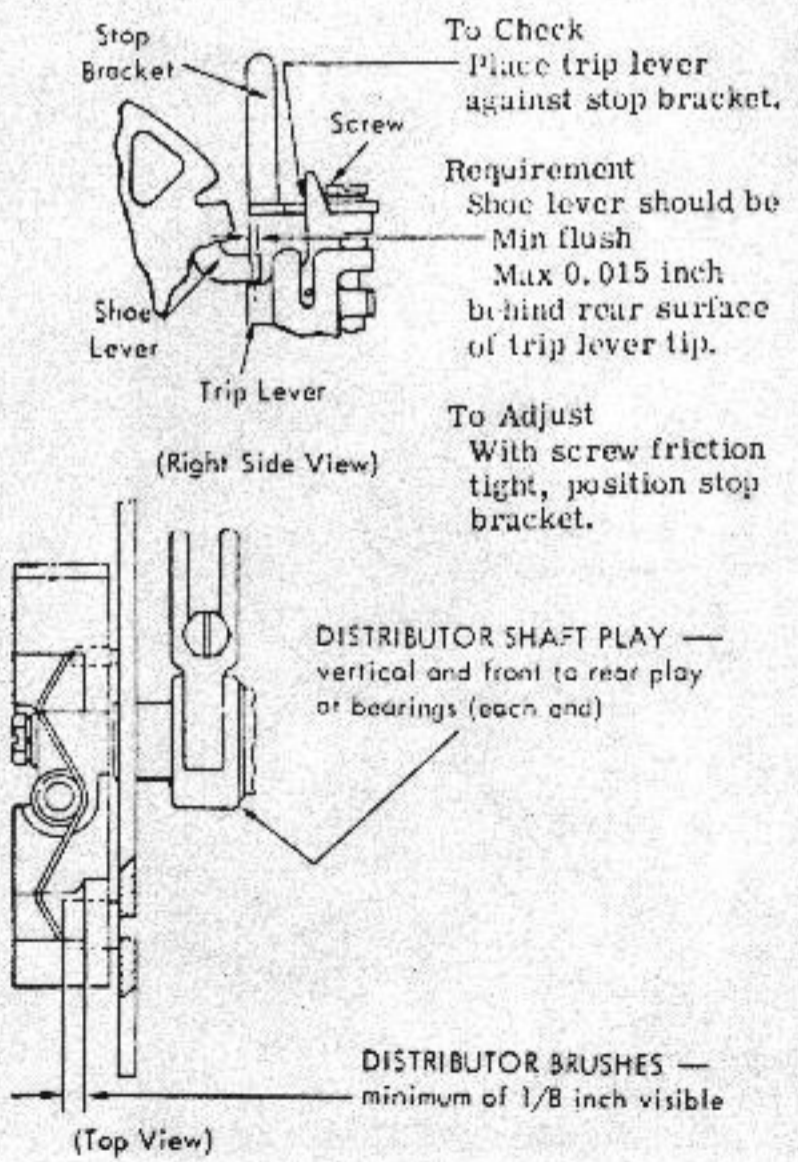

Fig. 32-59



(Courtesy of Teletype Corp.)

Fig. 32-60



To Check
Manually place universal lever in its lower latched position — pencil mark lever position. Rotate distributor clutch until universal lever is fully reset.

Requirement
Min 0.010 inch --- Max 0.035 inch
movement of universal lever from its latched to its reset position, as gauged by eye.

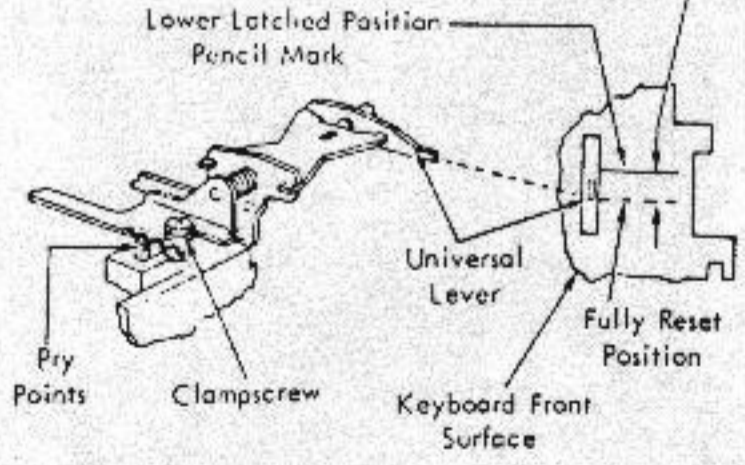

To Adjust
Loosen clampscrew. Using pry points, position linkage.

Affected Adjustment
Trip Lever Engagement

(Courtesy of Teletype Corp.)

MODEL 32

I. REMOVING THE MAINSHAFT

1. A bad mainshaft or its bearings can be responsible for all kinds of problems.
2. Refer to Fig. 32-62. Shake mainshaft at ends to test for tightness of fit.
3. Remove trip shaft according to Fig. 32-32.
4. Remove screws according to the following figures in order:
 - a) Fig. 32-63
 - b) Fig. 32-64
 - c) Fig. 32-65
 - d) Fig. 32-66
 - e) Fig. 32-67
 - f) Fig. 32-68
5. Push mainshaft to the right according to Fig. 32-69. Hold selector clutch drum (Fig. 32-75) while pushing mainshaft. The following figures show the sequences that occur when pulling the mainshaft.
 - a) Fig. 32-69
 - b) Fig. 32-70
 - c) Fig. 32-71
 - d) Fig. 32-72
 - e) Fig. 32-73
 - f) Fig. 32-74
 - g) Fig. 32-75
6. Mainshaft parts are laid out in Fig. 32-76. Most likely replacement parts are the main shaft and the bearings.

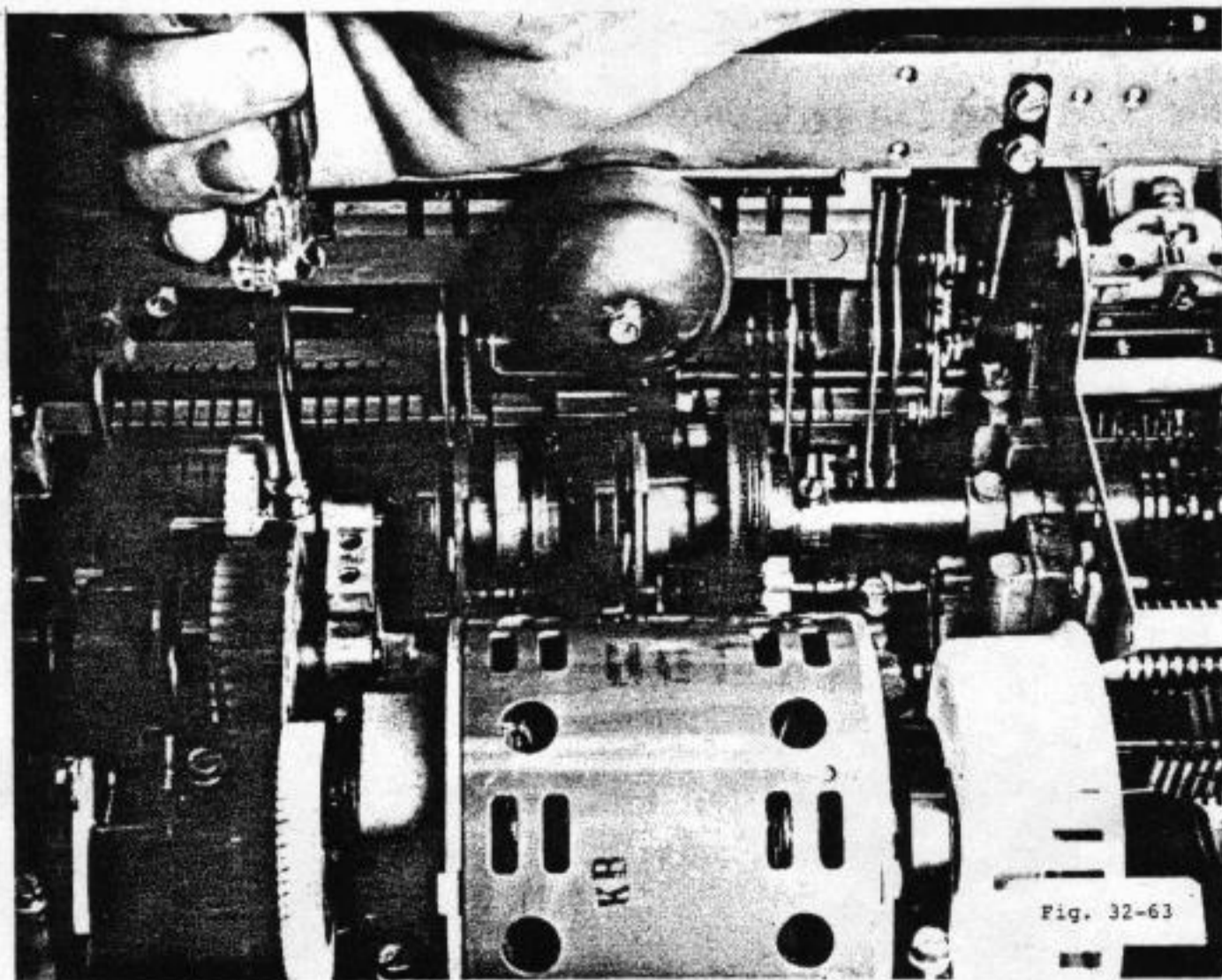
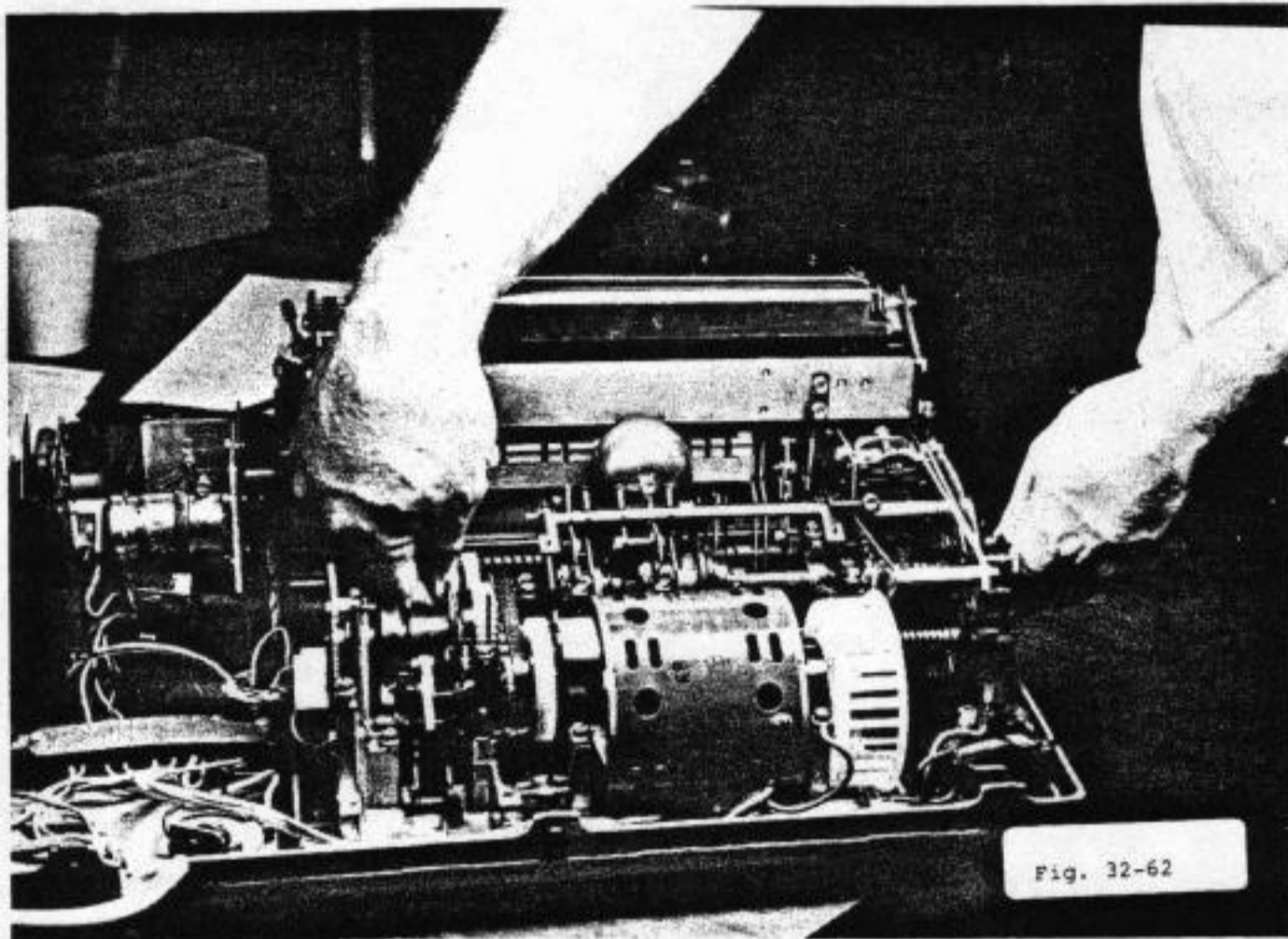

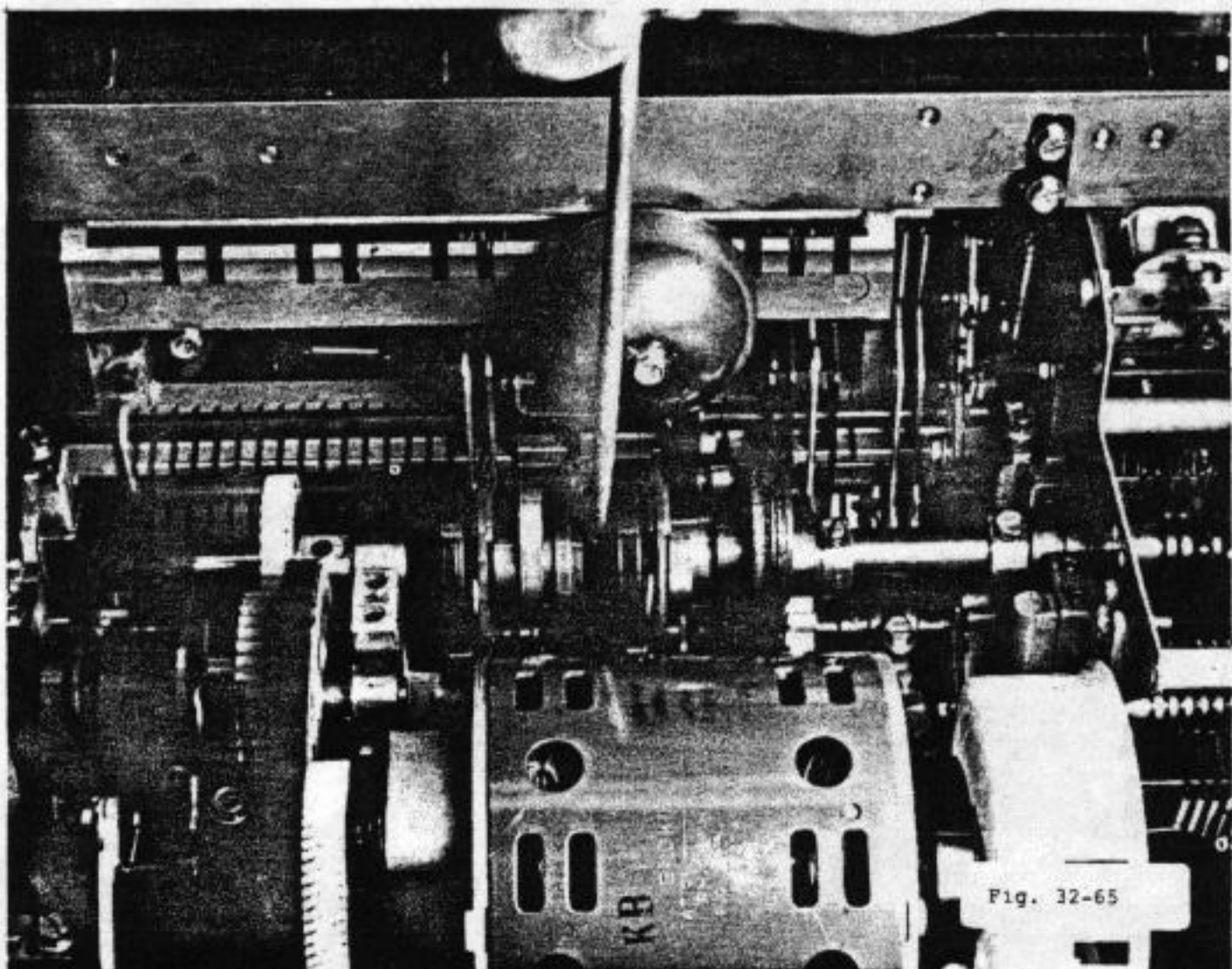
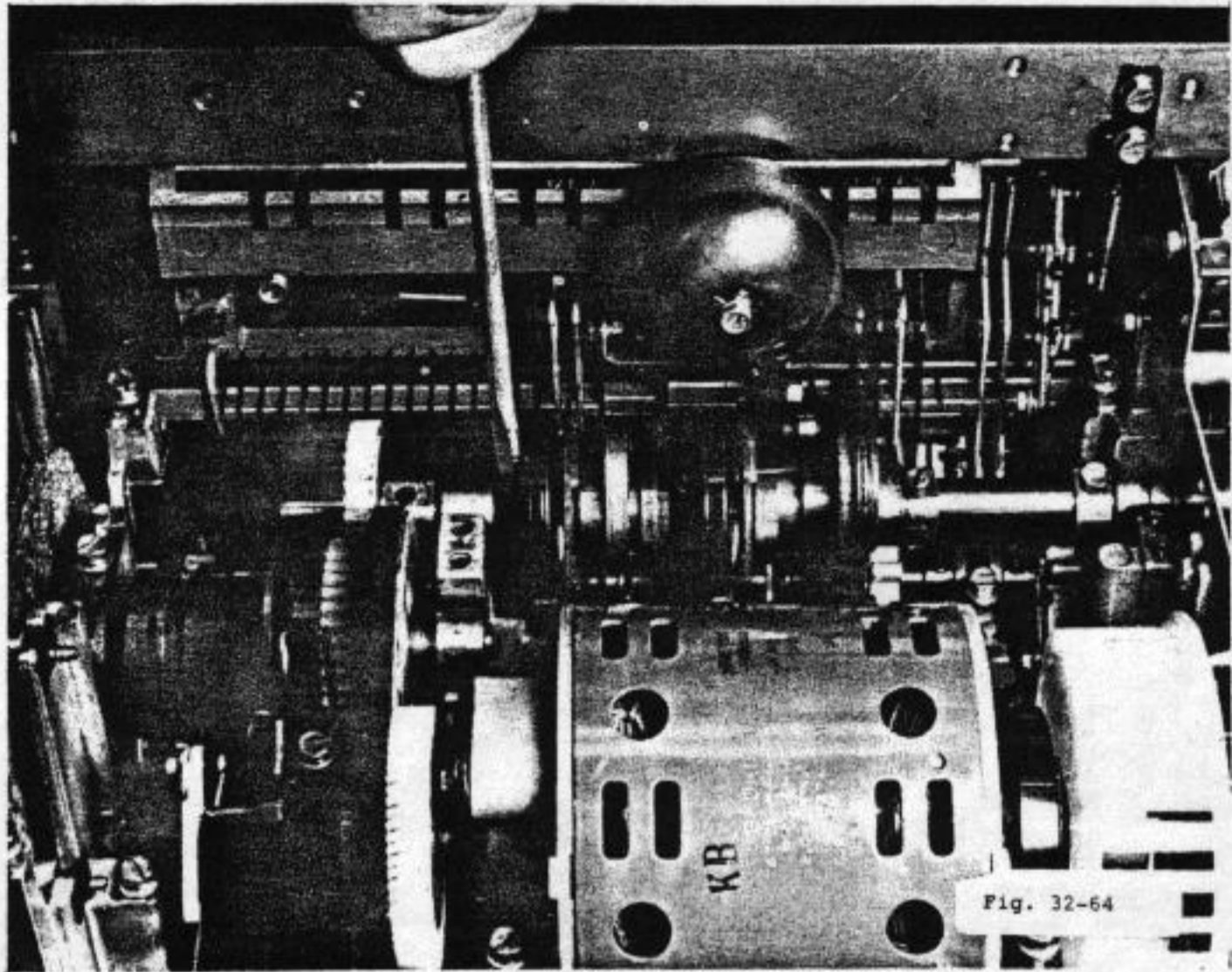

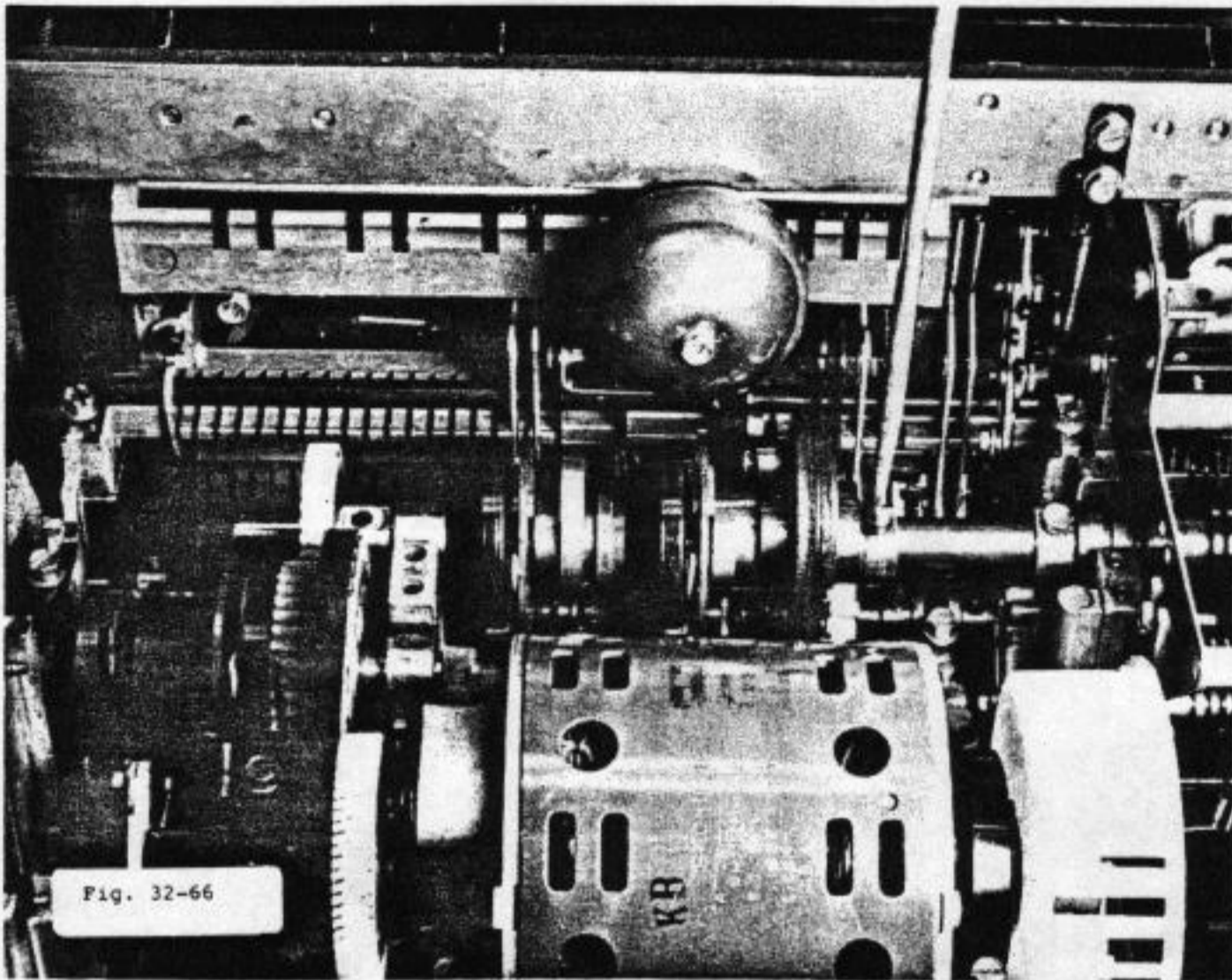

Fig. 32-66

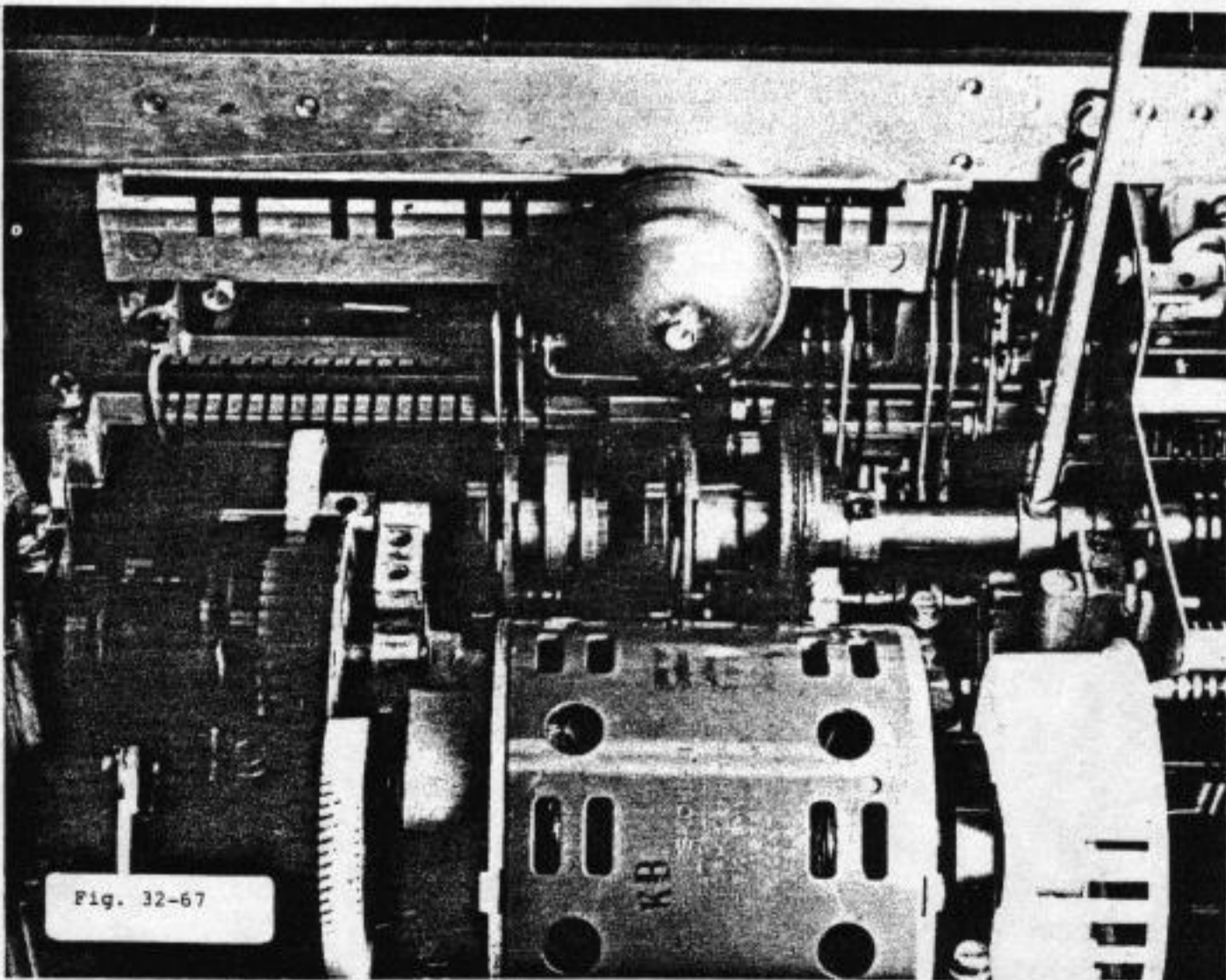
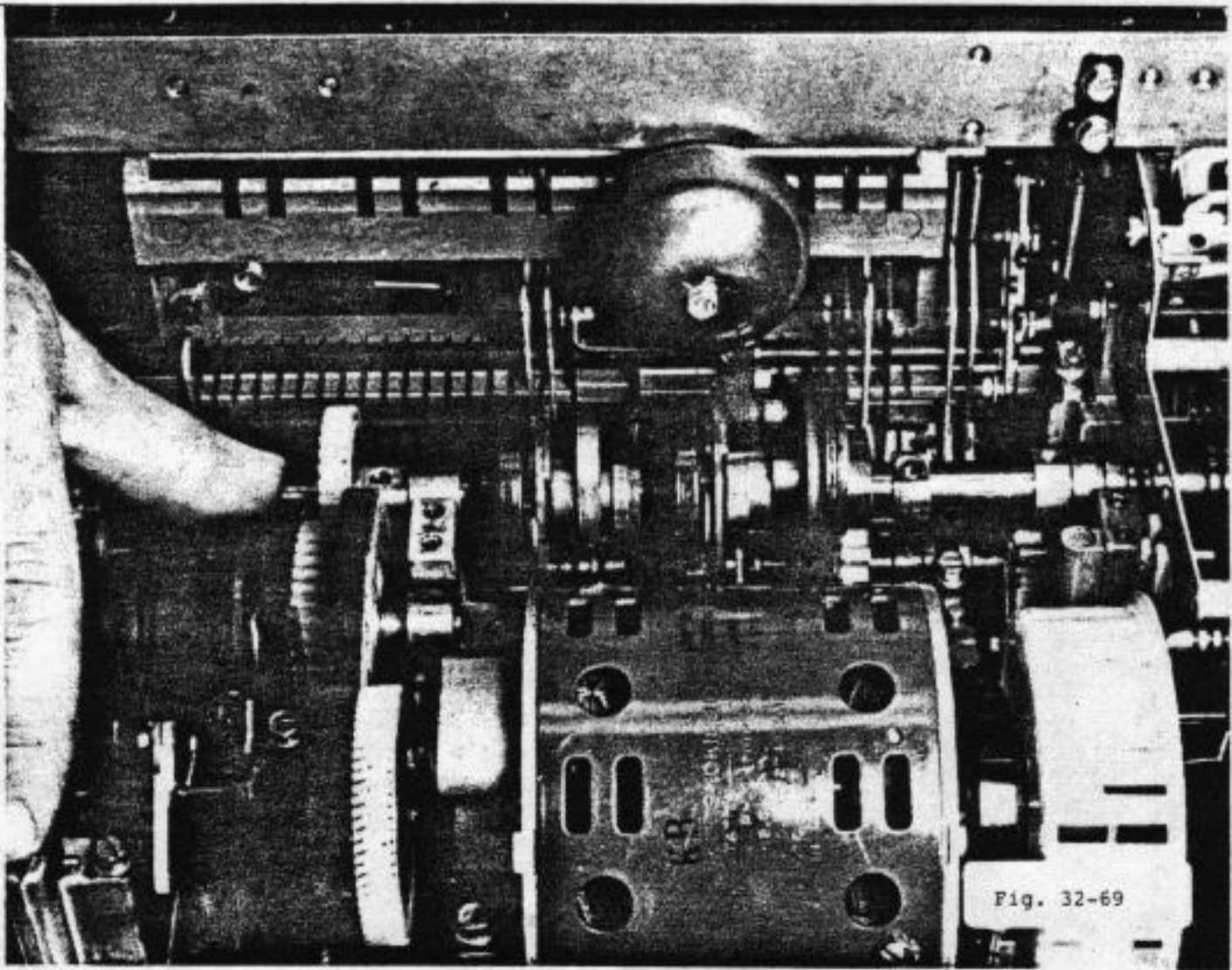
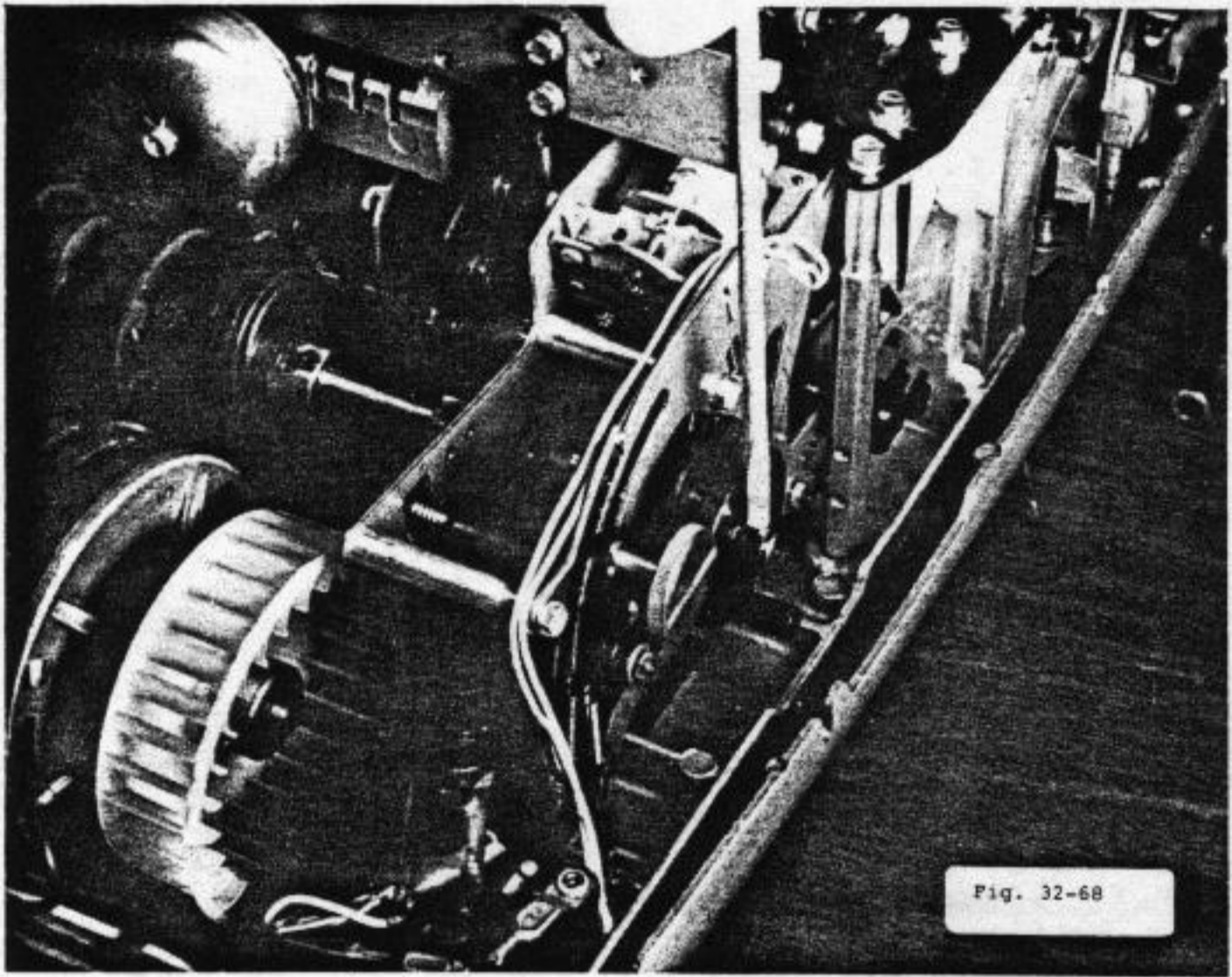
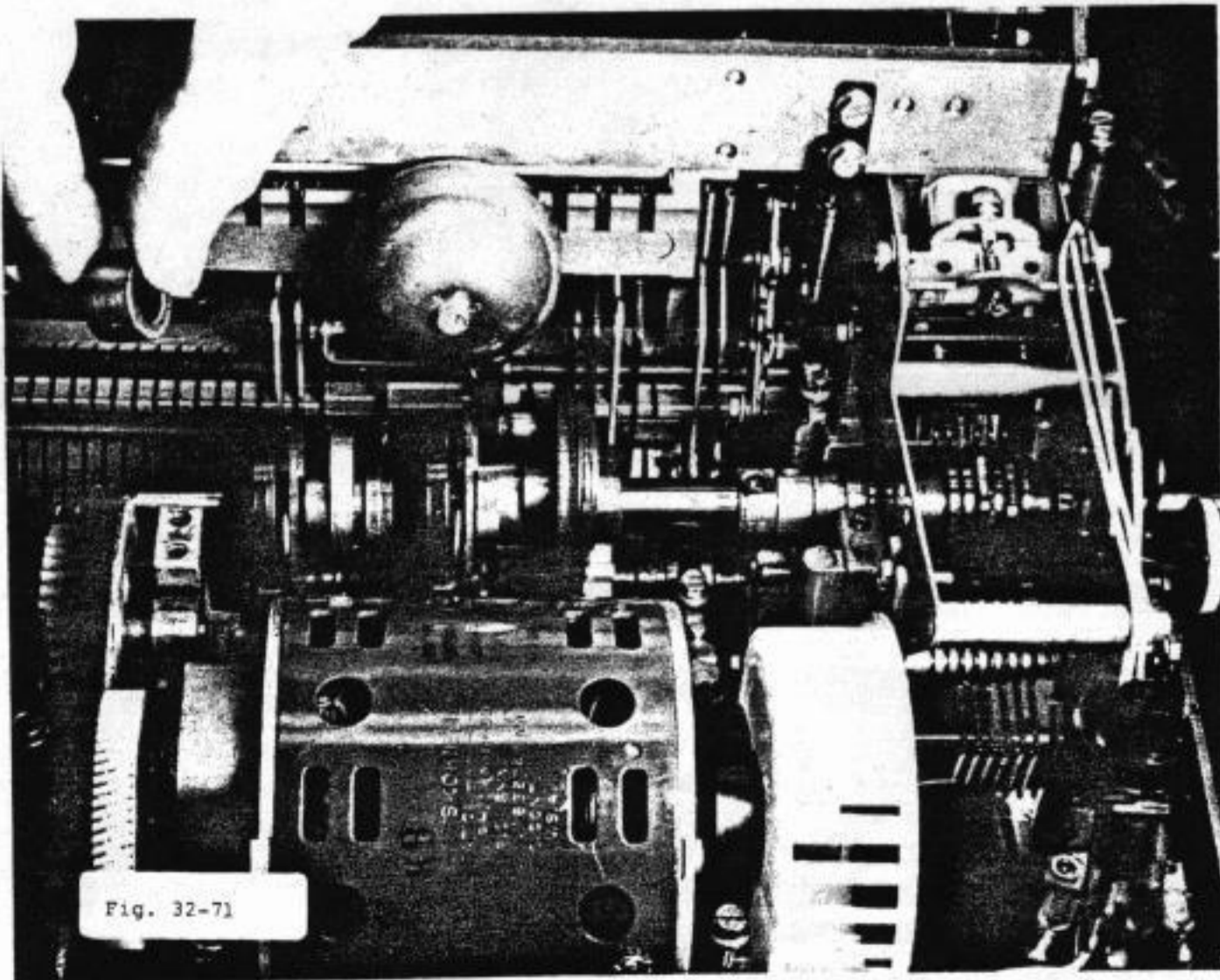
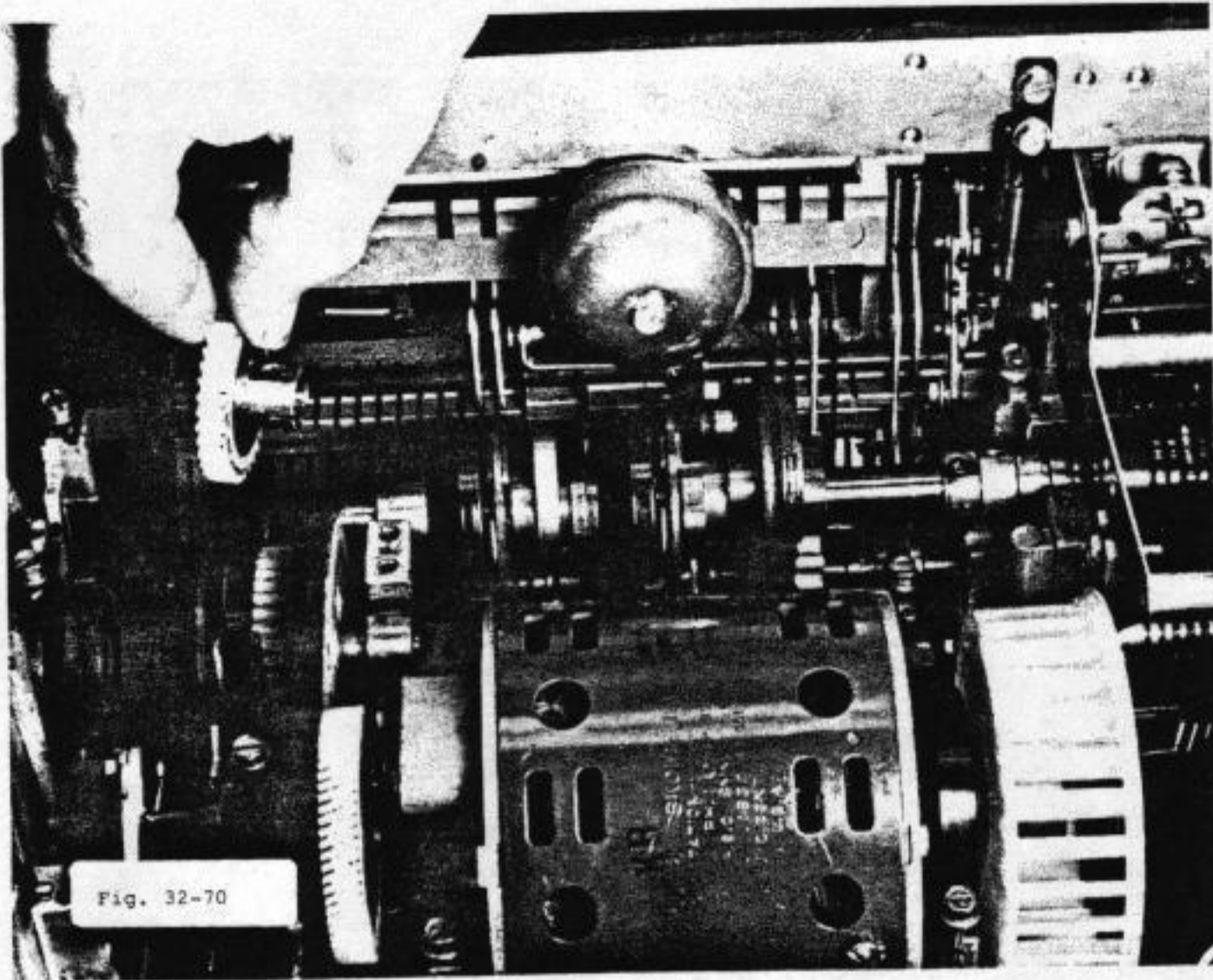
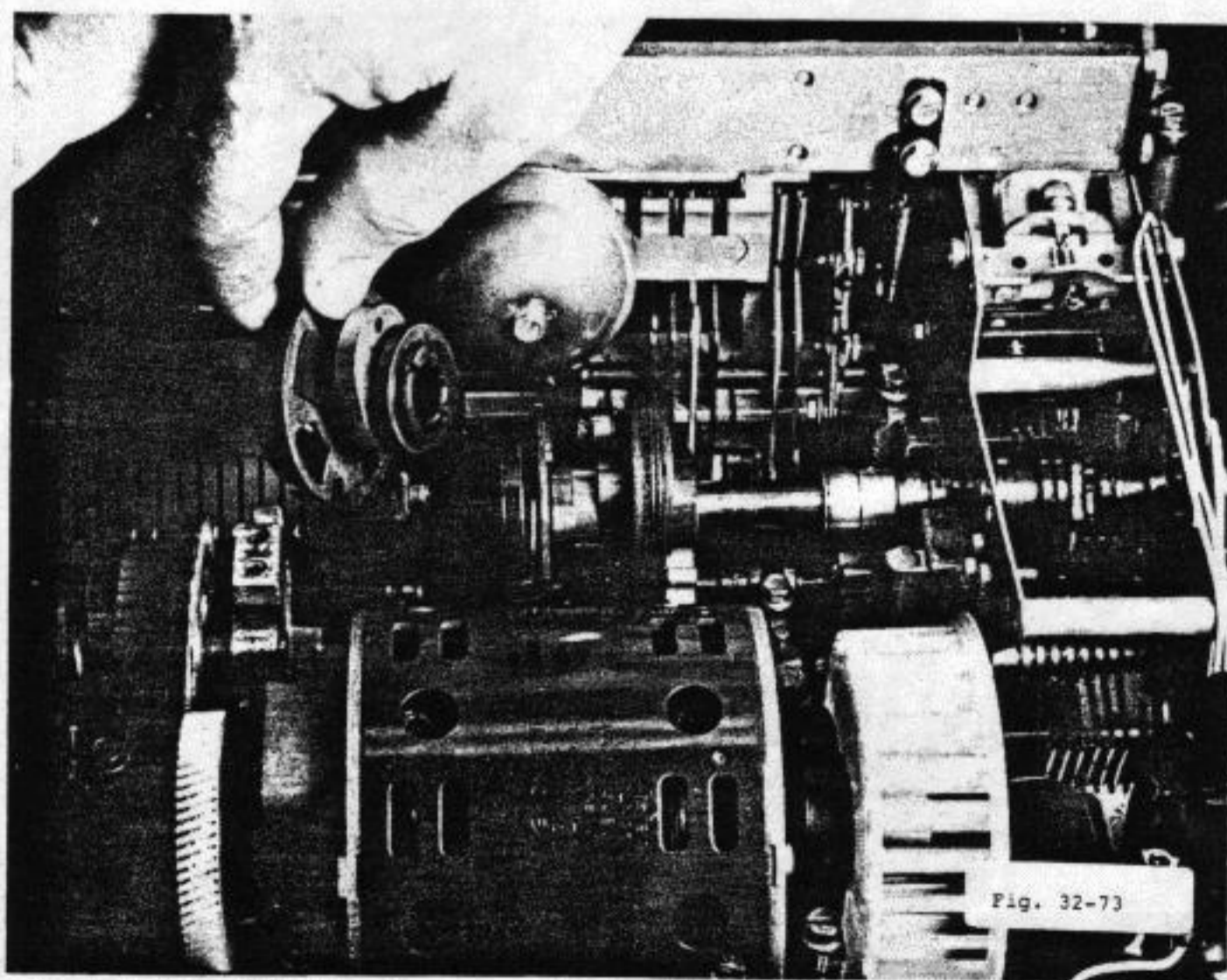
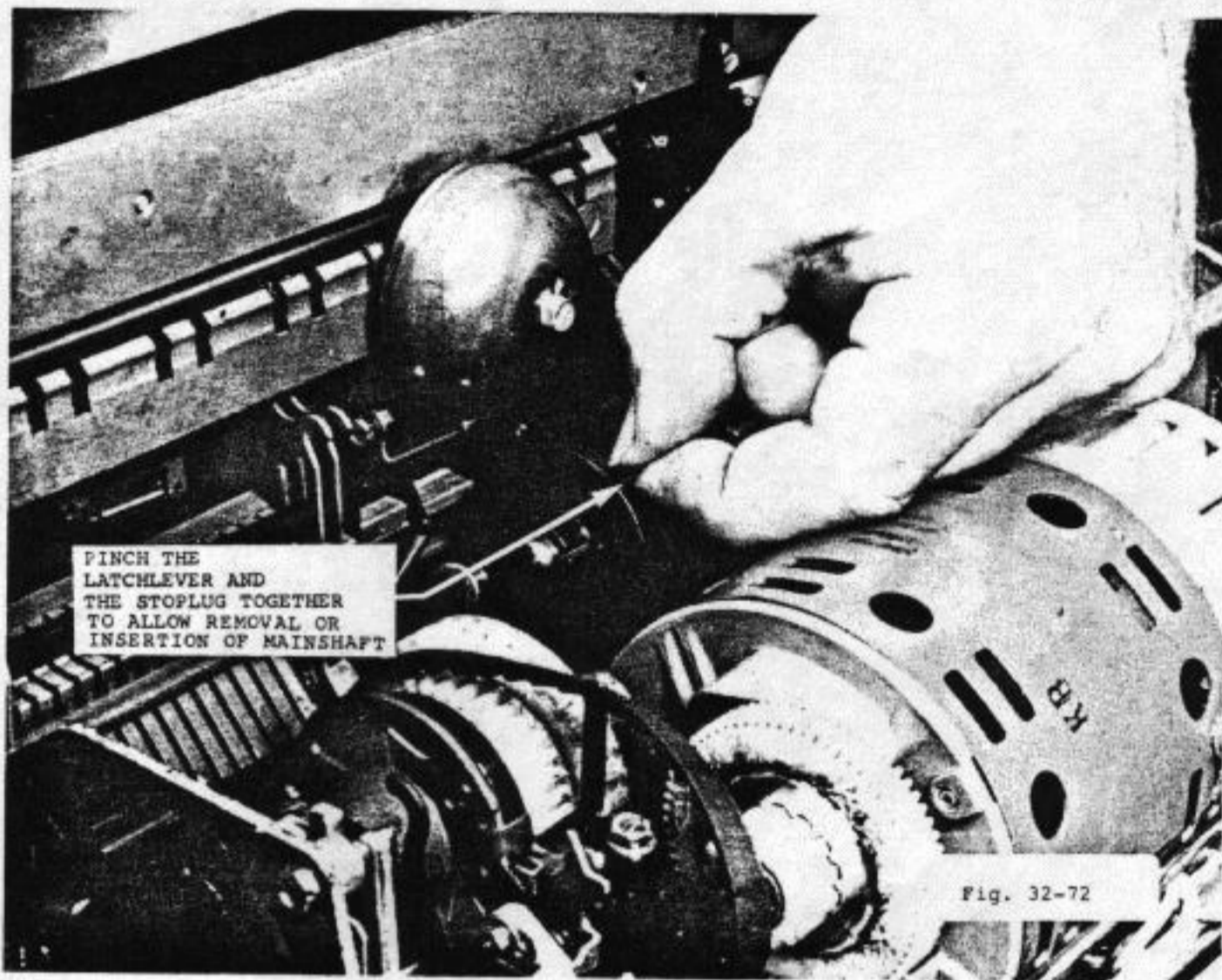
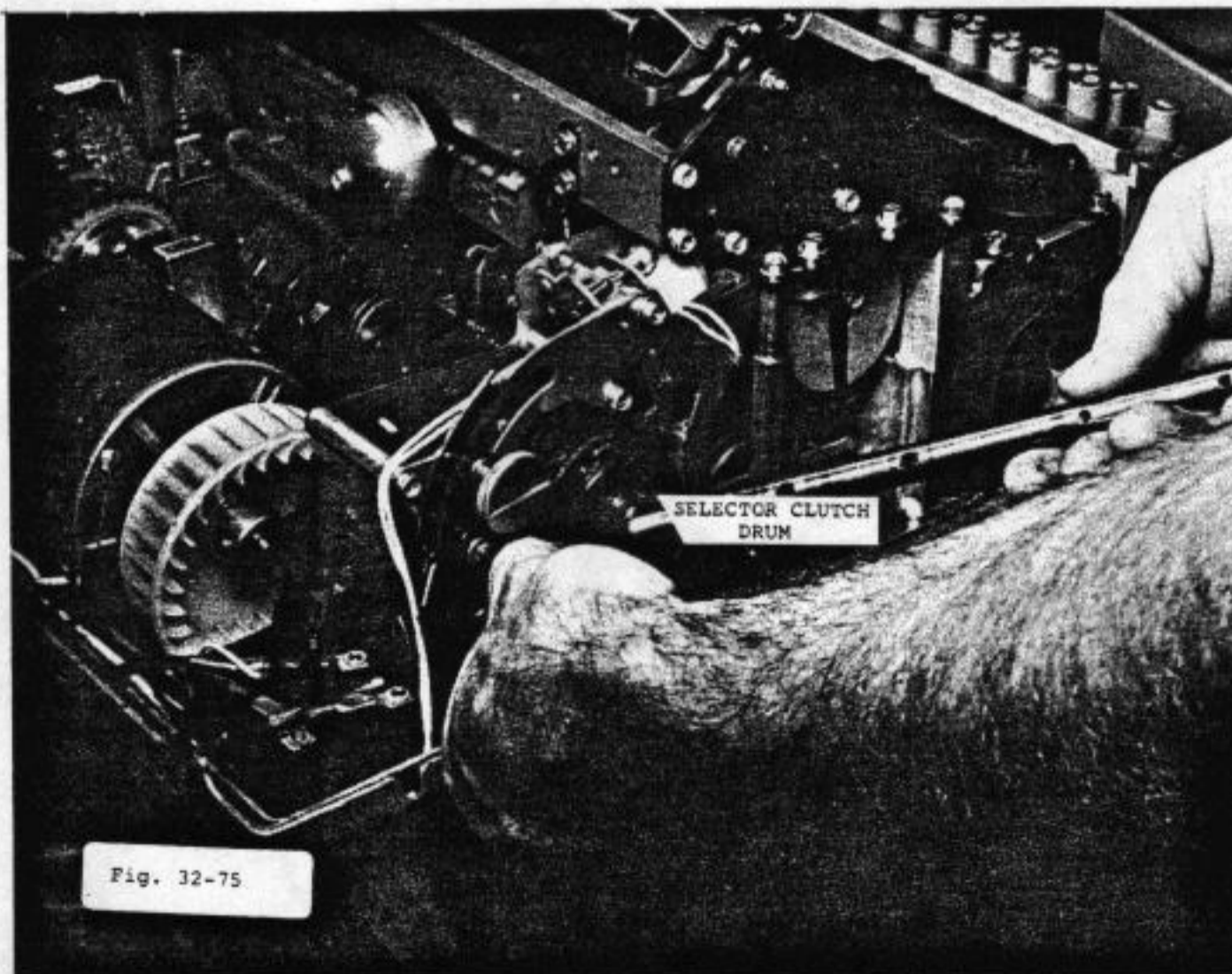
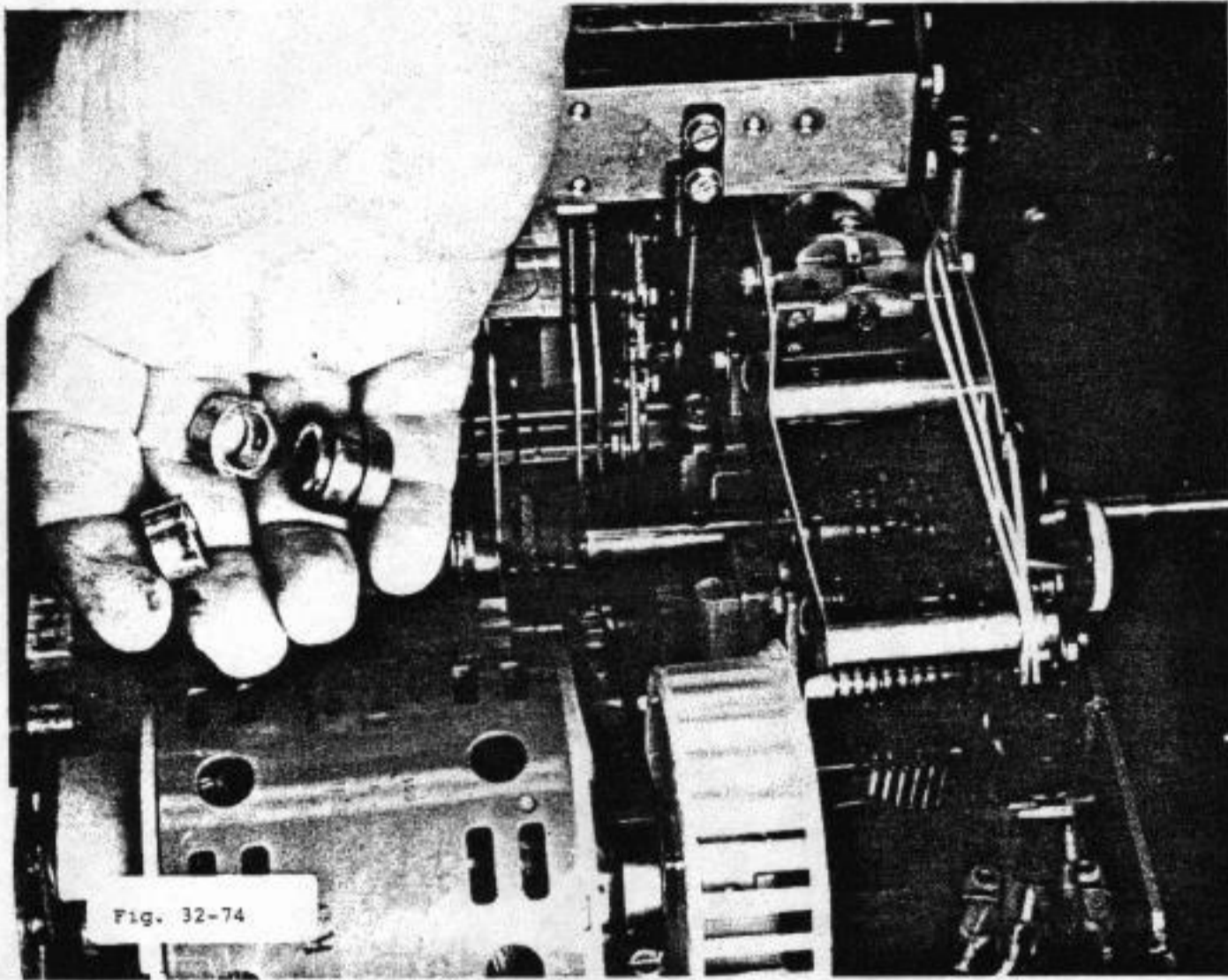

Fig. 32-67









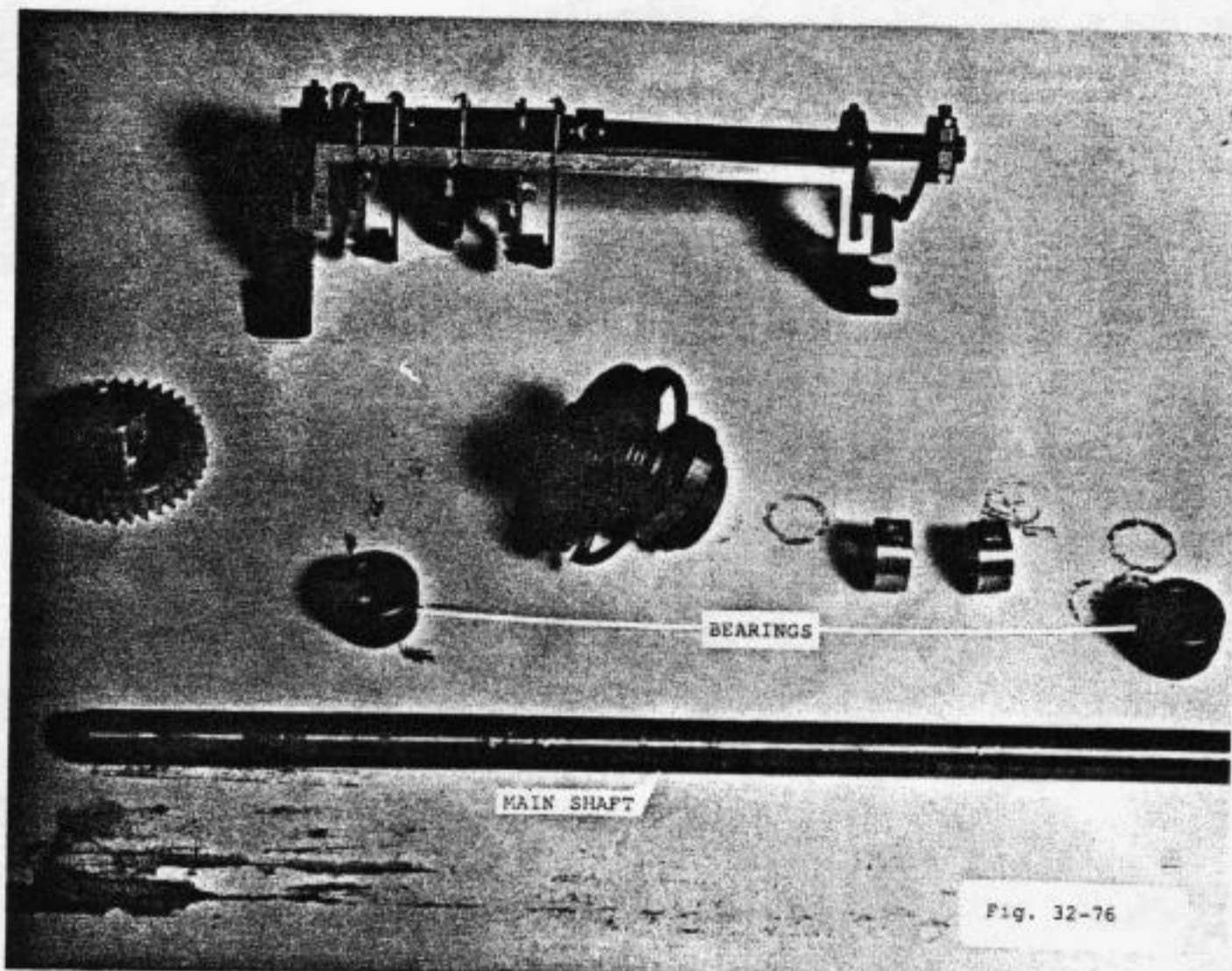

Fig. 32-76

CLUTCH ASSEMBLY
(SHOES POSITIONED
INCORRECTLY)

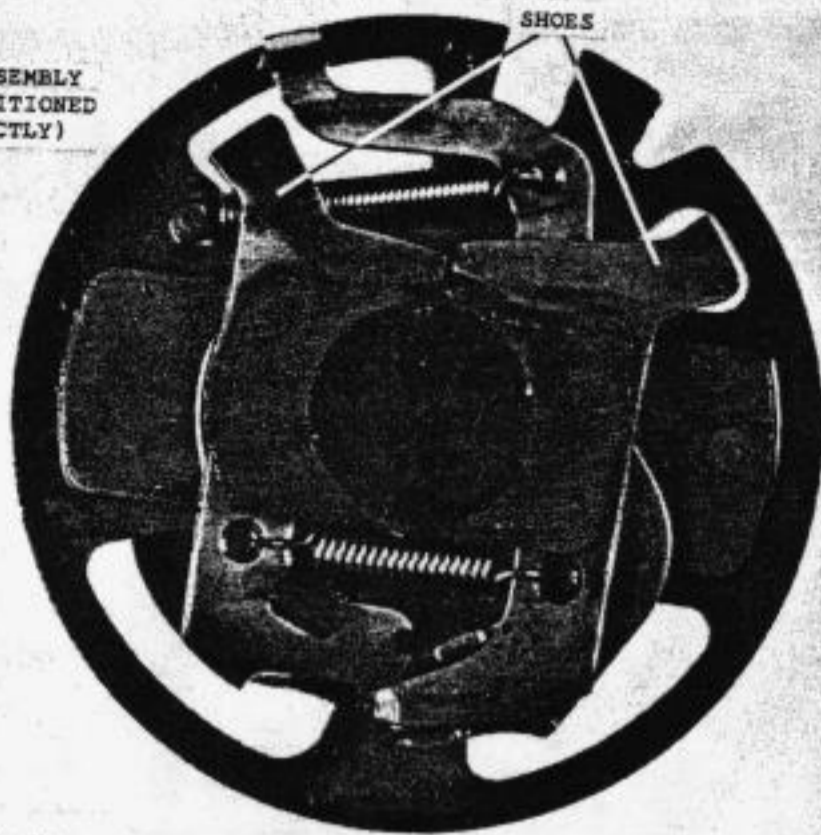

Fig. 32-77

CLUTCH ASSEMBLY
(SHOES POSITIONED CORRECTLY)

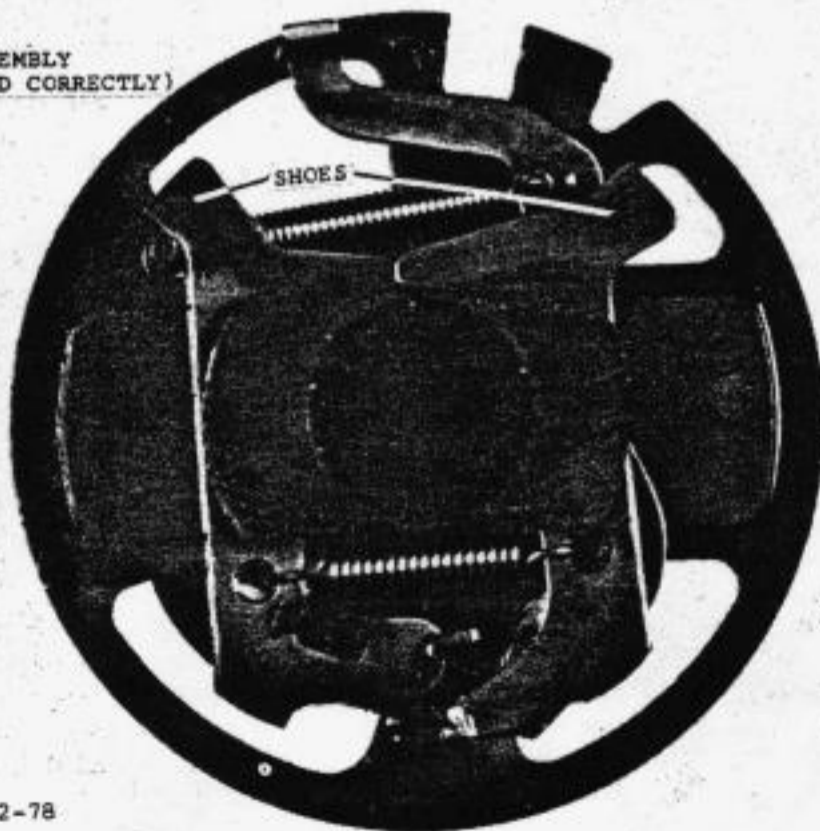
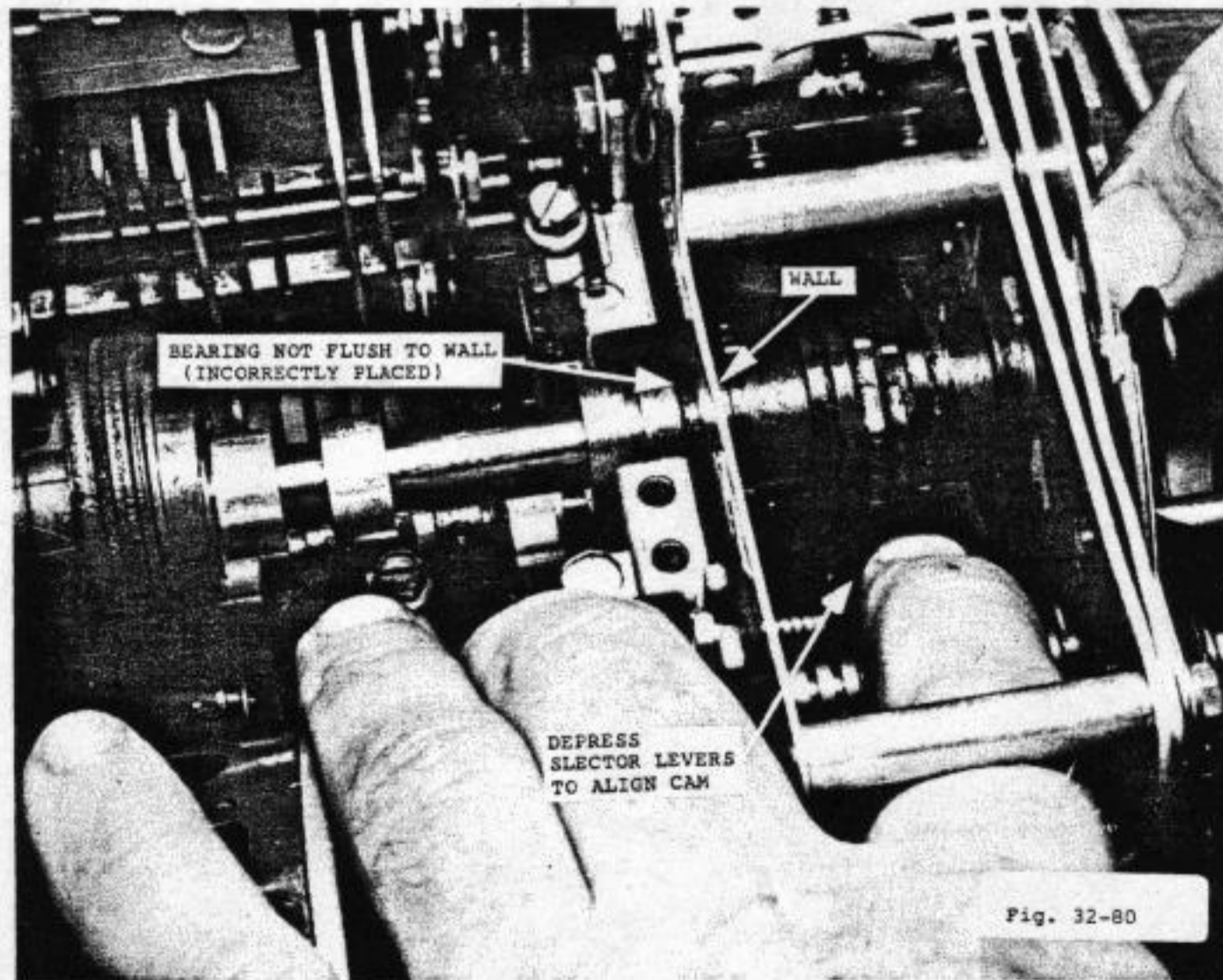
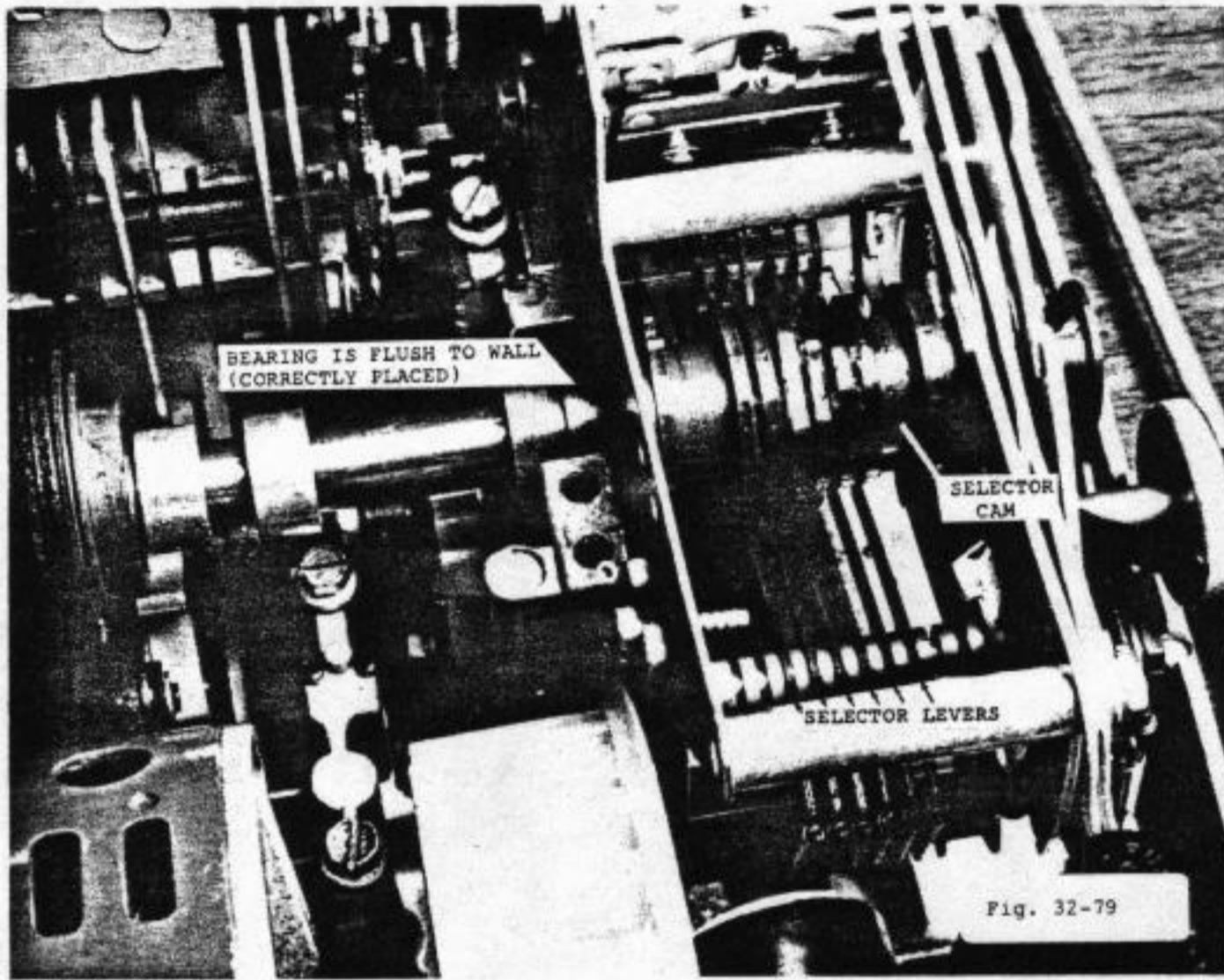

Fig. 32-78

J. REINSTALLING THE MAINSHAFT

1. Be sure to pinch the latchlever and the stoplug together (Fig. 32-72) to let the mainshaft through the clutch assembly. The clutch assembly is a delicate thing and if the drum is separated from the clutch, the shoes may separate and get out of alignment. Refer to Fig. 32-77. Proper shoe positions are found in Fig. 32-78. Incorrectly placed shoes will not allow mainshaft to pass through the clutch assembly.
2. Alignment of mainshaft parts:
 - a) Make sure selector cams are in line with selector levers according to Fig. 32-79. It may be necessary to depress selector levers with your finger in order to align the cam. See Fig. 32-80.
 - b) Make sure bearing is correctly placed and flush to wall according to Fig. 32-79. Example of bearing not flush to wall is in Fig. 32-80.
3. Reinstallation of Trip Lever:

Refer to Fig. 32-81 for trip lever layout and to Fig. 32-82 for line-up instructions.



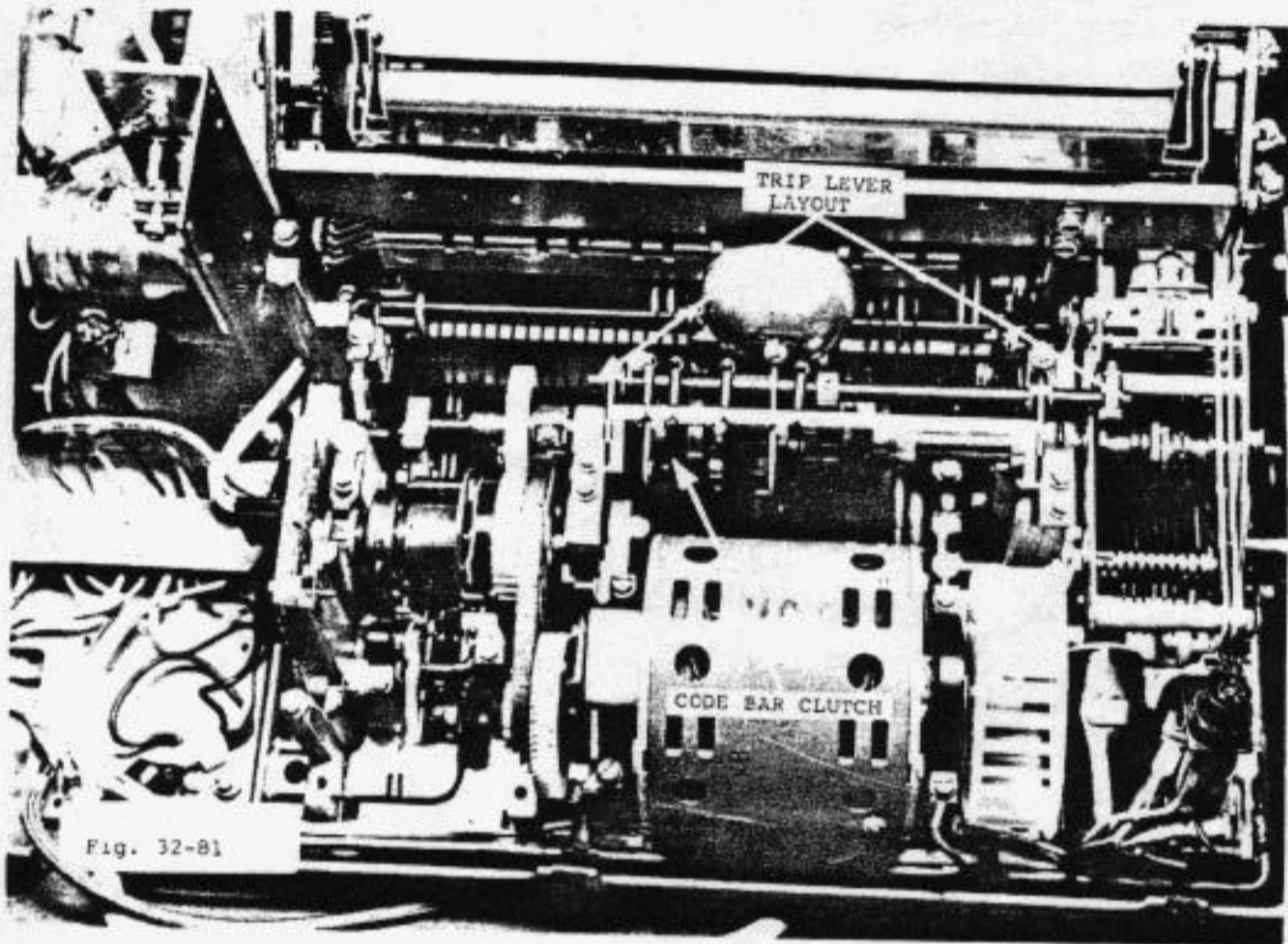

CODEBAR CLUTCH TRIP LEVER LINE-UP

(1) Requirement
 As gauged by eye, codebar clutch trip lever approximately aligned with shoe lever
 within 0.030 inch.

(2) Requirement
 Min 0.005 inch
 between function clutch trip roller's shaft and codebar reset cam when all play is taken up to make clearance minimum.

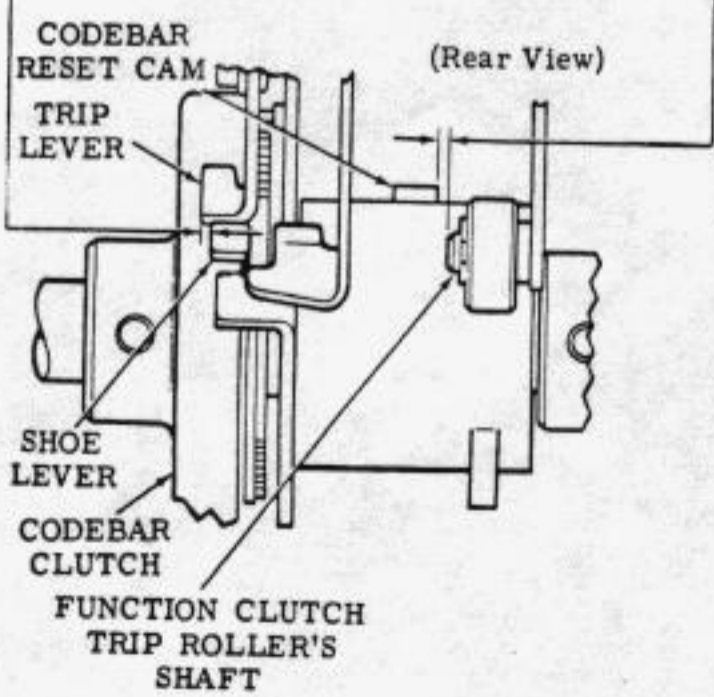

(Courtesy of Teletype Corp.)

Fig. 32-82

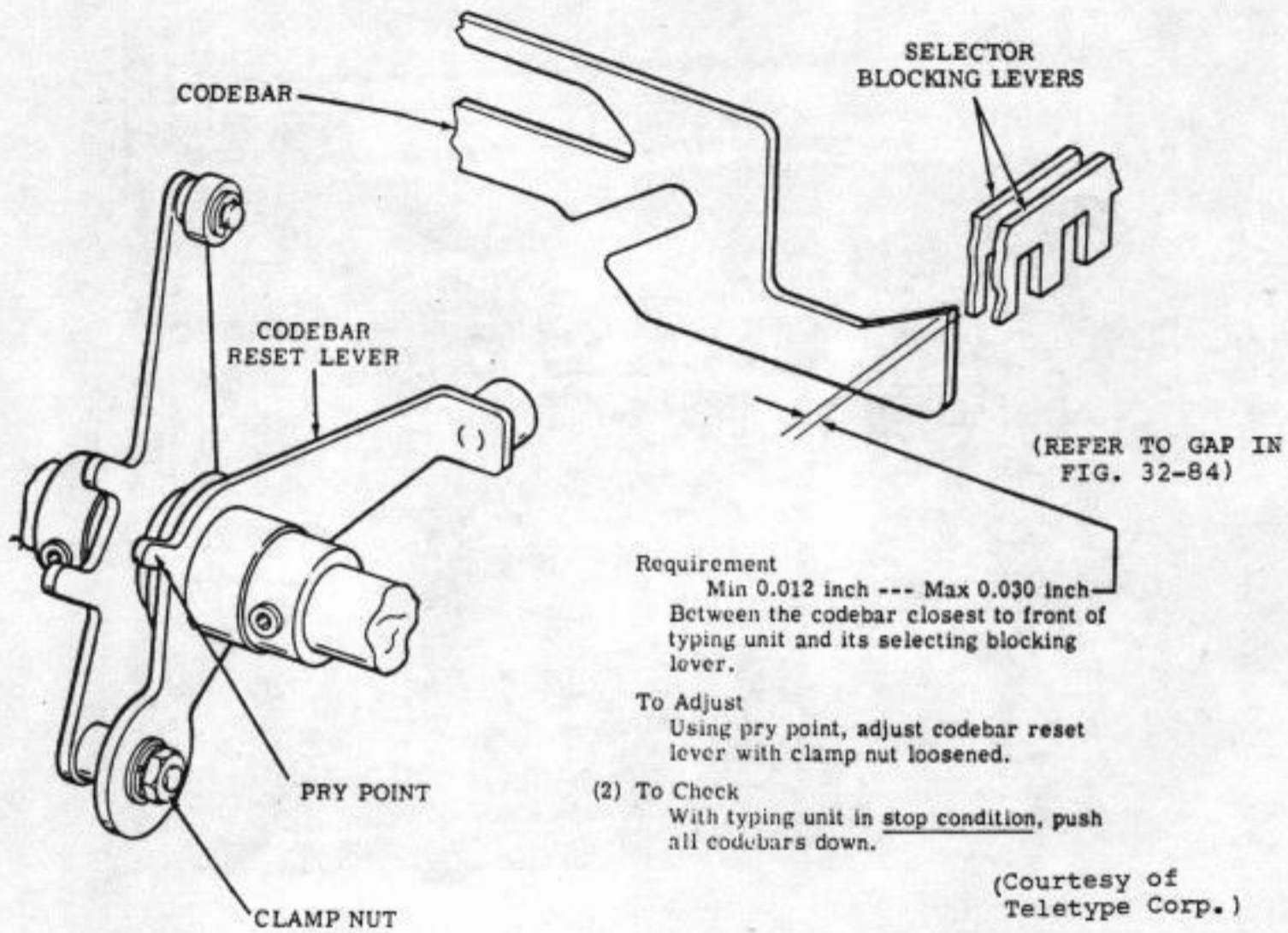

(LEFT REAR VIEW)

(Courtesy of Teletype Corp.)

Fig. 32-83

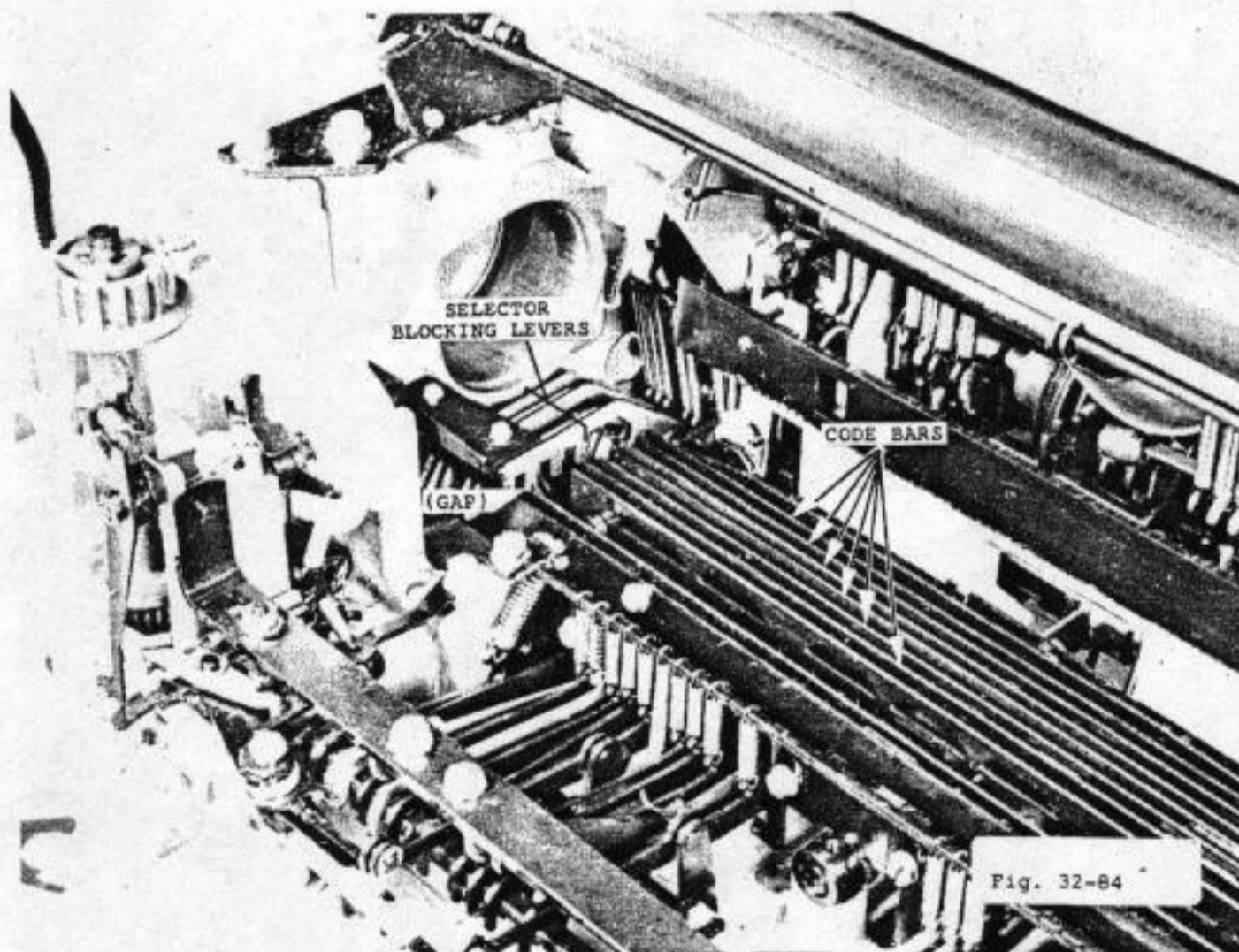

K. CODEBAR ADJUSTMENTS

1. This type of adjustment should be done only when the simple adjustments have not helped solve the problem of misprinted characters. Such misprinting is usually not the continuous type but rather the occasional type.
2. Adjustment instructions are in Fig. 32-83. Location of selector blocking levers and the end of the codebar are in Fig. 32-84. In that figure, note where the gap is. Adjustment actually takes place at the spot indicated by Fig. 32-85. A closer look can be provided in Fig. 32-86.

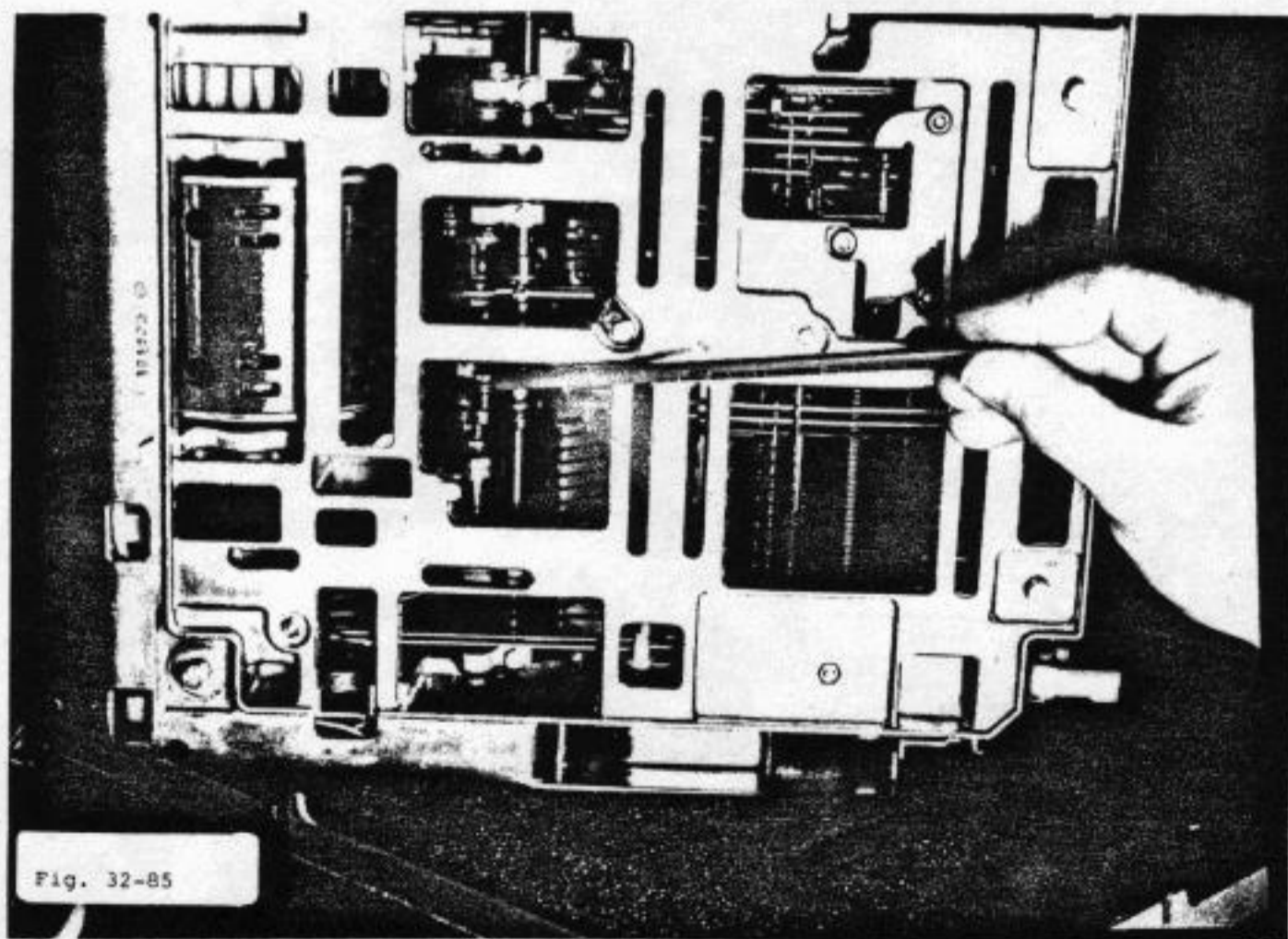

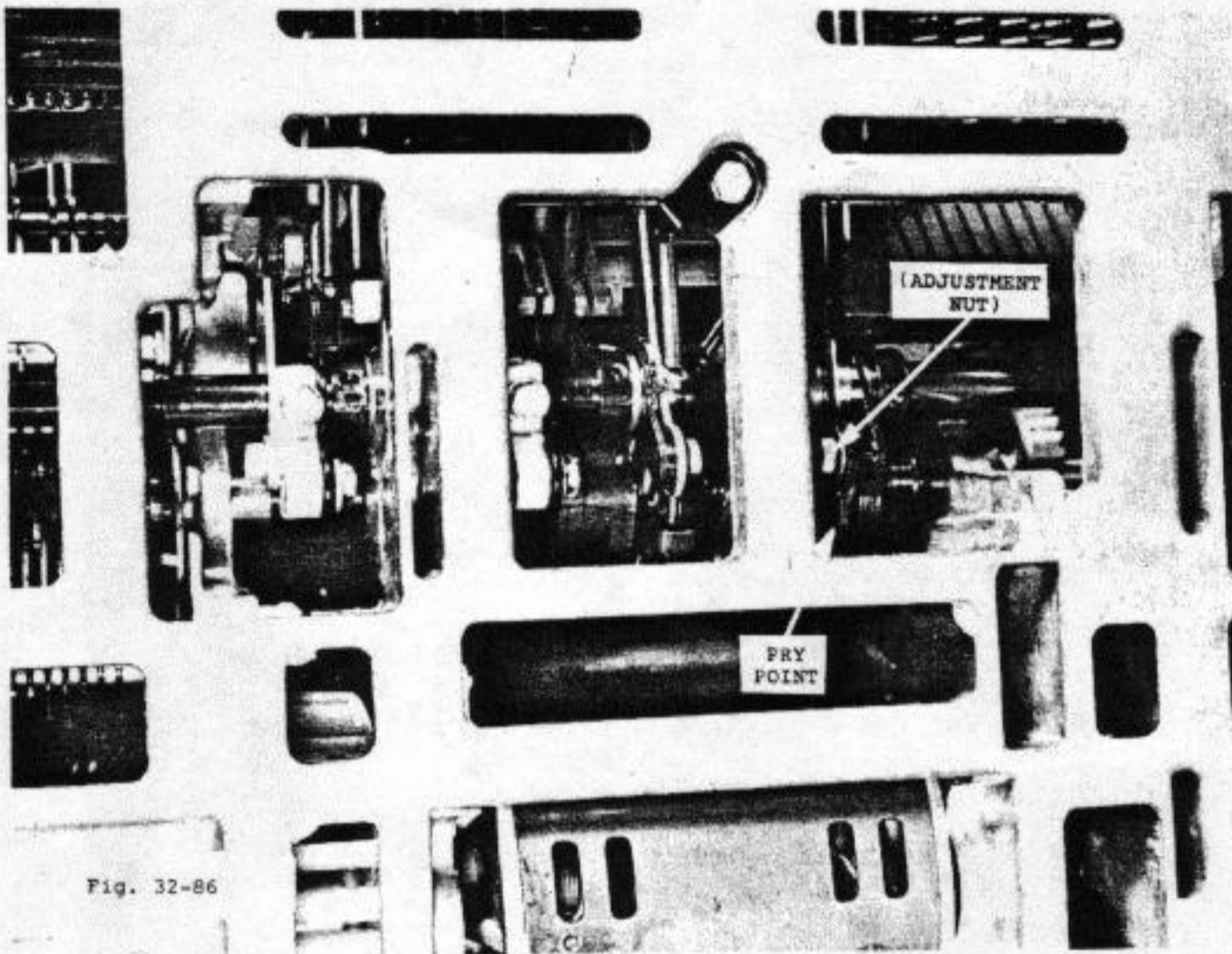

Fig. 32-86

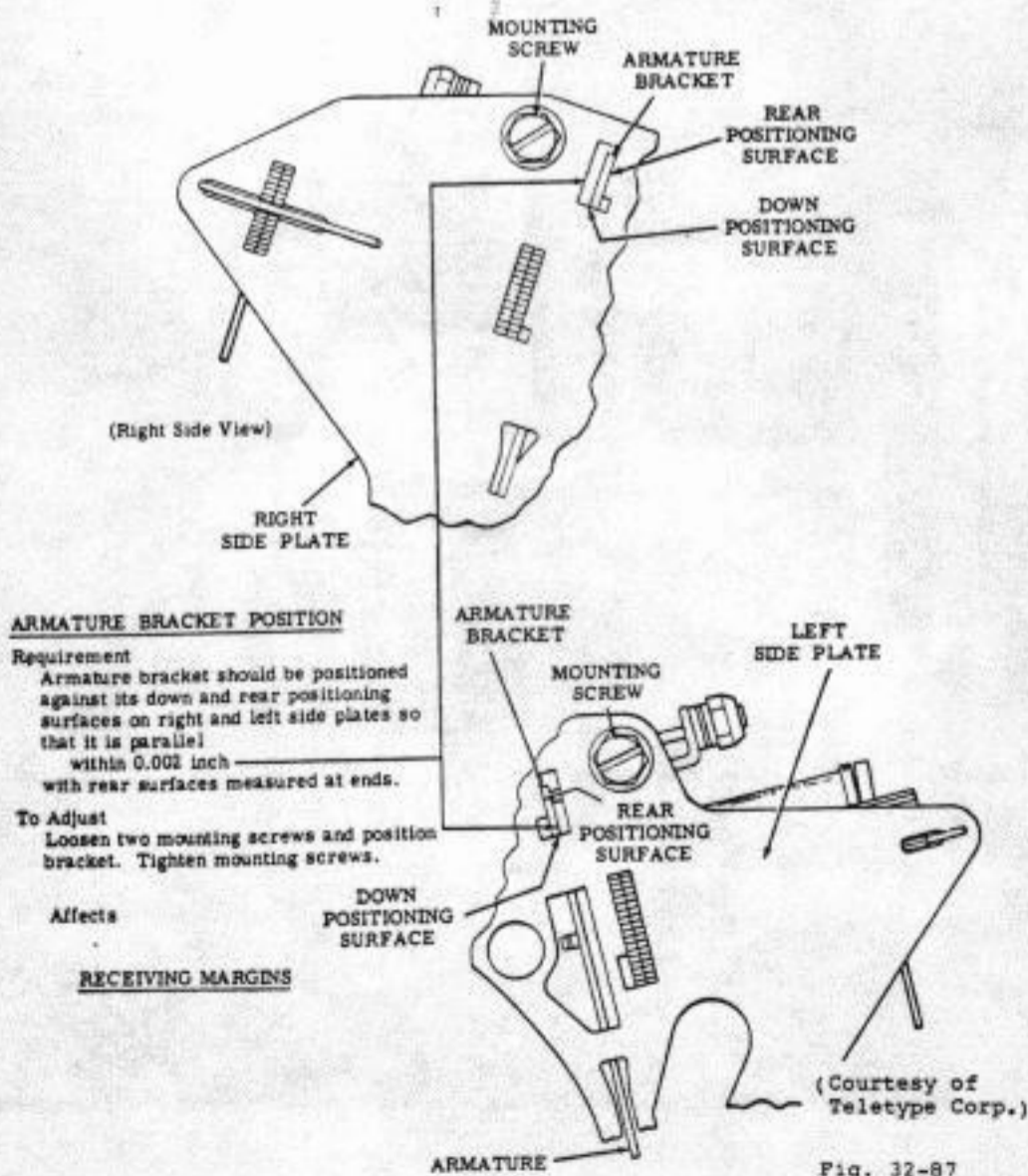
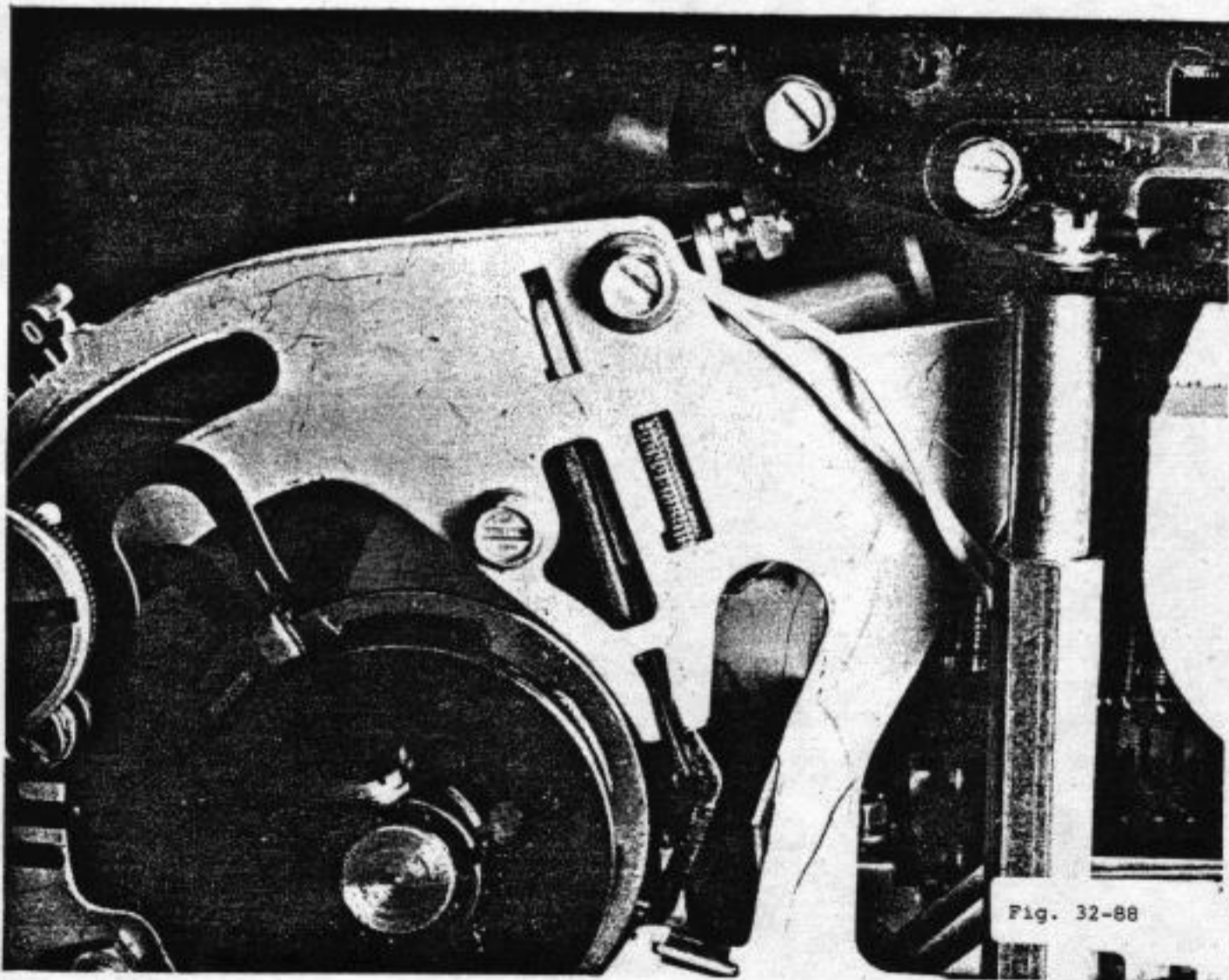

Fig. 32-87

L. ARMATURE BRACKET ADJUSTMENT

1. Occasional misprinting could be caused by armature bracket misalignment but not too likely. This is a very simple adjustment procedure.
2. Refer to Fig. 32-87 for adjustment information and Fig. 32-88 for location.



- (1) With rangefinder set at 80, selector in all marking condition and clutch disengaged, manually trip codebar clutch and rotate main shaft to position codebars flush with left edge of blocking levers.

Min 0.006 inch---Max 0.050 inch
between no. 1 (leftmost) blocking lever
and codebar.

Min 0.003 inch
between remaining blocking levers and
codebars.

- (2) With all clutches latched, trip and rotate selector clutch (selector conditioned all marking). As clutch shoe lever travels between the 12 and 3 o'clock positions, there should be no vertical motion of the no. 1 or no. 2 blocking levers.

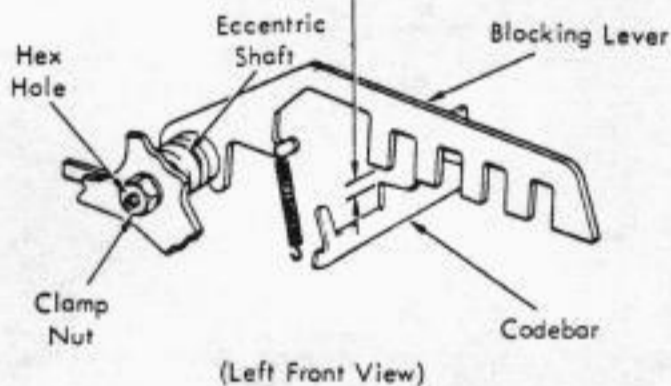

(Courtesy of
Teletype Corp.)

To Adjust

Loosen clamp nut and use hex wrench to position eccentric shaft — keep shafts chamfered right shoulder to the rear.

Fig. 32-89

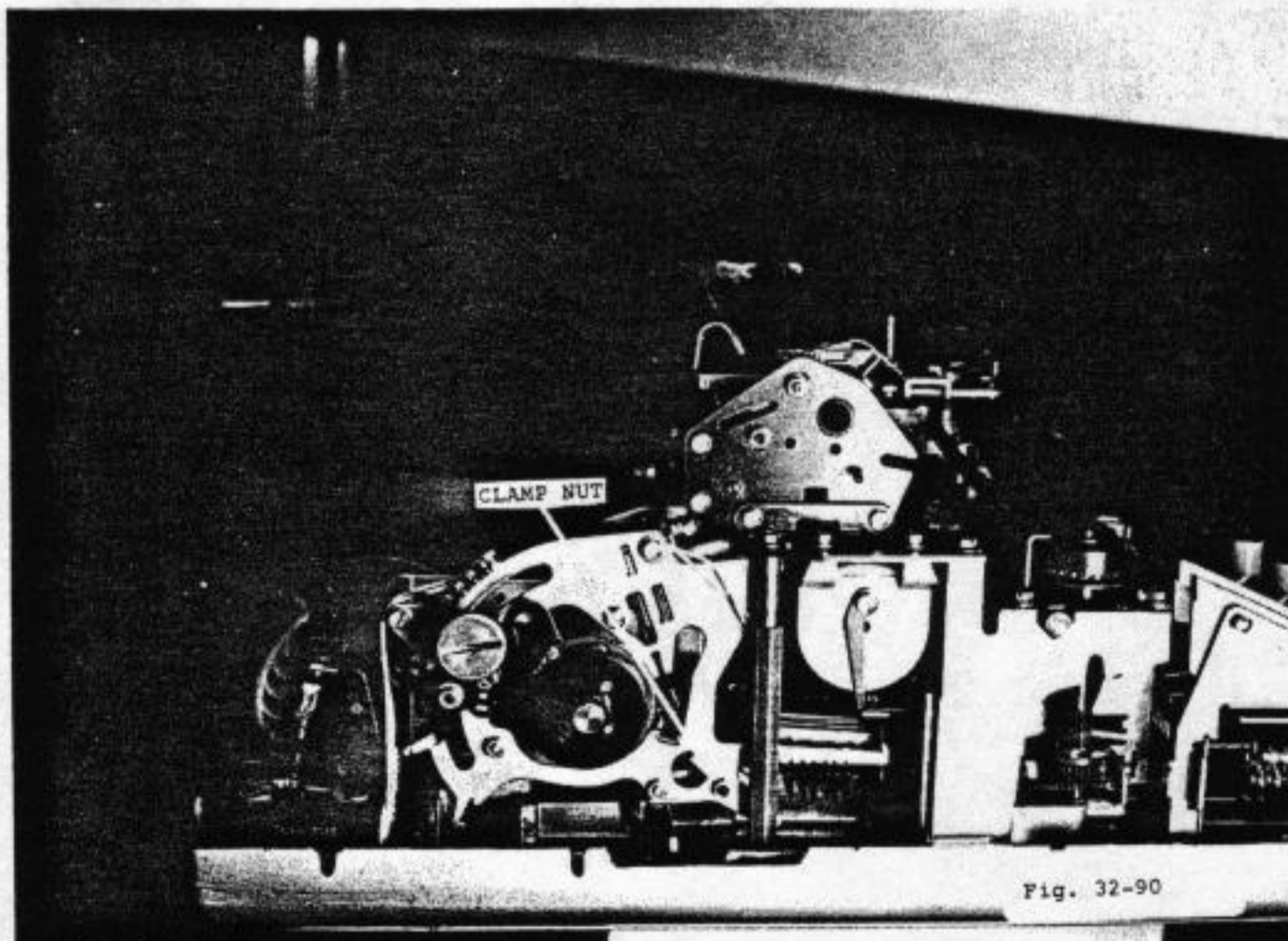

M. BLOCKING LEVER POSITION ADJUSTMENT

1. Occasional misprinting could be caused by the blocking lever slightly out of position.
2. Refer to Fig. 32-89 for adjustment information and Fig. 32-90 for location of adjustment point.

N. PLATEN ADJUSTMENTS

1. Misalignment of platen can result in poorly printed characters such as those in Fig. 32-91.
2. Fig. 32-92 describes alignment instructions and Fig. 32-93 shows location of alignment points.

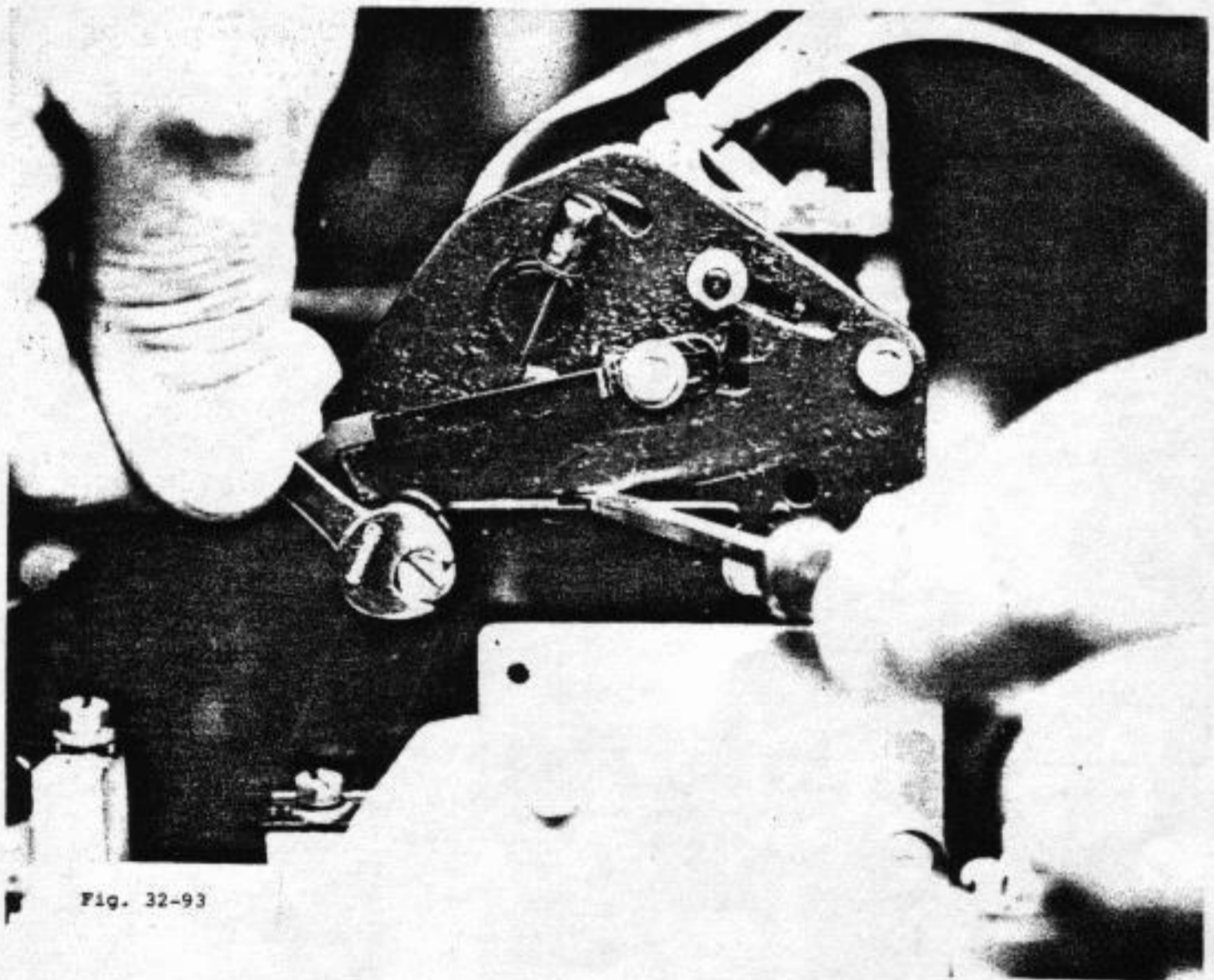

REAR RAIL

(1) To Check
Position the carriage on the left side of the typing unit with the center of the typewheel 2-7/8 inches from the platen left mounting plate. Manually operate the typing unit until the codebars fully rise. Depress the letters blocking lever.

Continue to rotate the main shaft until the shift slide barely comes to rest on the stop plate.

Requirement
With all play in shift slide taken up in the downward direction
Min 0.028 inch --- Max 0.042 inch
between bottom edge of shift slide and top edge of stop plate. Record the measurement.

(2) To Check
Position the carriage to the right side of the typing unit with the center of the typewheel 1/2 inch from the right-hand margin. Manually operate the typing unit until the codebars fully rise. Depress the letters blocking lever (see above note). Continue to rotate the main shaft until the shift slide barely comes to rest on the stop plate.

Requirement
Perform "Requirement" in "(1) To Check" above.

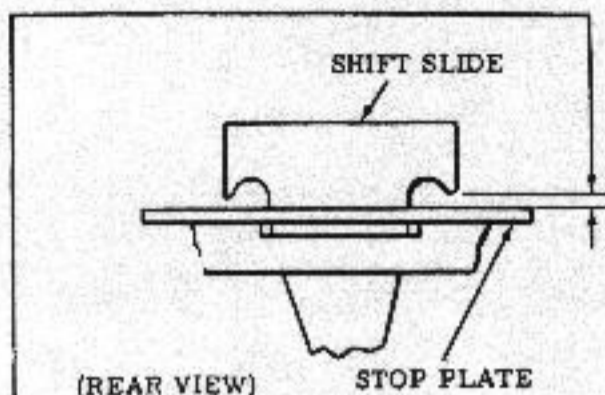

(3) To Check
Calculate the difference between the recorded measurements in "(1) To Check" and "(2) To Check" above.

Requirement
Max 0.010 inch
difference between recorded measurements.

To Adjust
With two carriage rear rail mounting screws friction tight, position carriage rear rail using pry point.

Related Adjustments
Affects
REAR ROLLER
RESET LEVER
PULSE LEVER
DRIVE BAIL
PLATEN-VERTICAL
PRINT RESET ARM
PRINT DRIVE LEVER

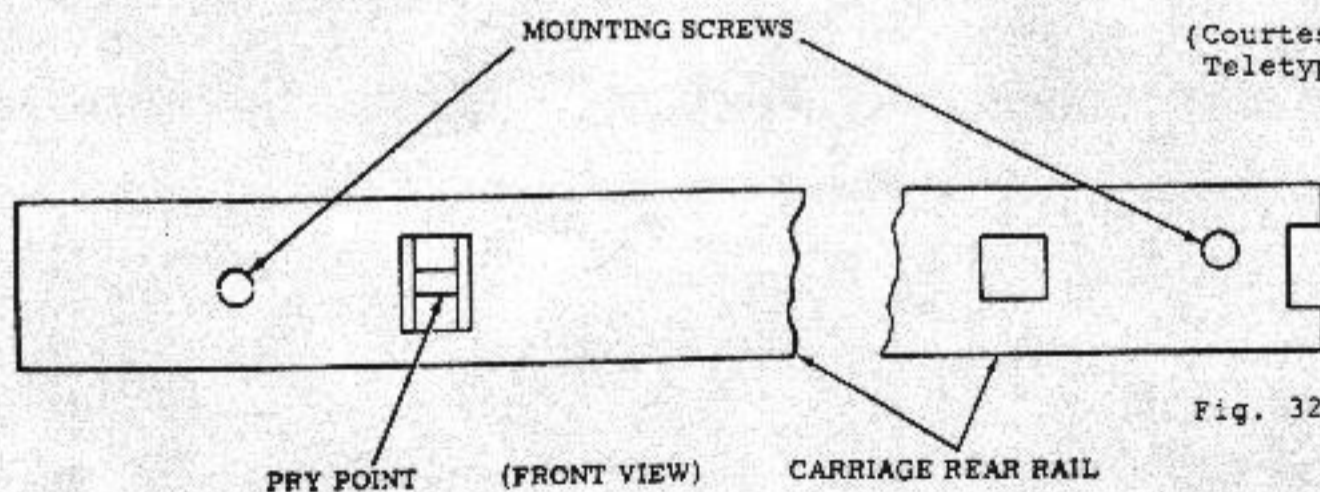

(Courtesy of Teletype Corp.)

O. CARRIAGE REAR RAIL ALIGNMENT

1. Misalignment of the rear rail will result in incorrect printing only on a part of the full 72 character line.
2. Alignment instructions are given in Fig. 32-94. Location of alignment points are shown in Fig. 32-95.

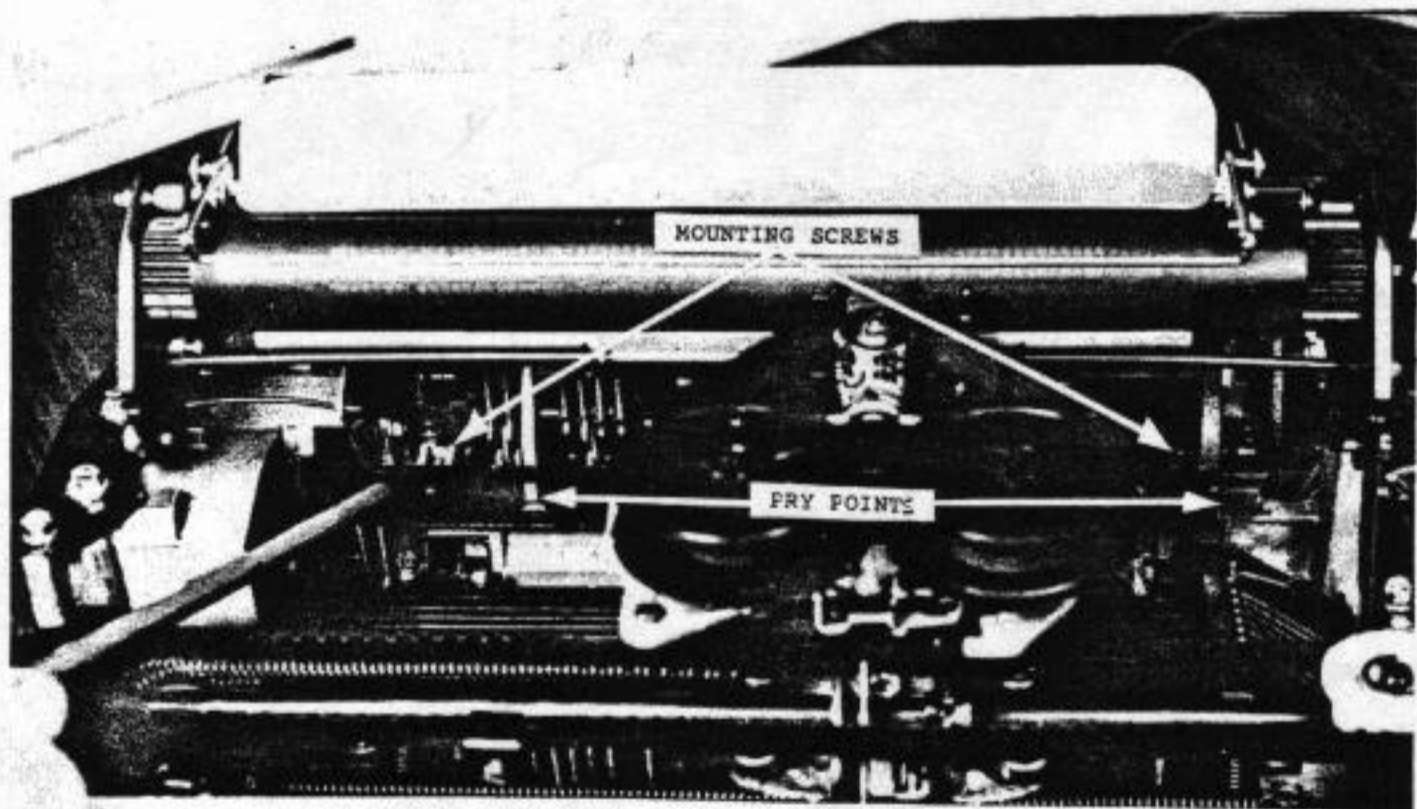

Fig. 32-95

Requirement

With carriage return code in selector, rotate main shaft until function bail reaches lowest point of travel.

(1) **Early Design**
Carriage return lever should be flush with carriage return latch within 0.005 inch.

(2) **Late Design**
Min some---Max 0.030 inch
between carriage return lever and
carriage return latch.

To Adjust

With clampscrew loosened, use pry points to position carriage return lever.

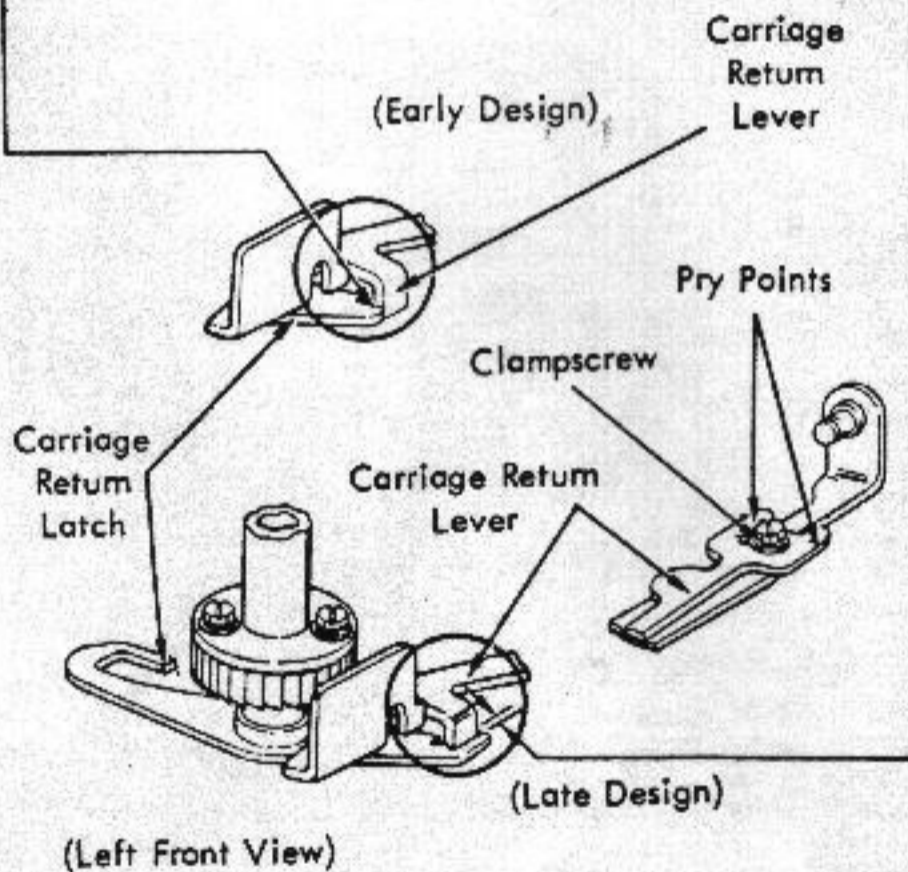

(Courtesy of
Teletype Corp.)

Fig. 32-96

P. CARRIAGE RETURN ADJUSTMENTS

1. This adjustment is needed when carriage return misses occasionally.
2. Adjustment instructions are given in Fig. 32-96. Location of adjustment points are shown in Fig. 32-97.

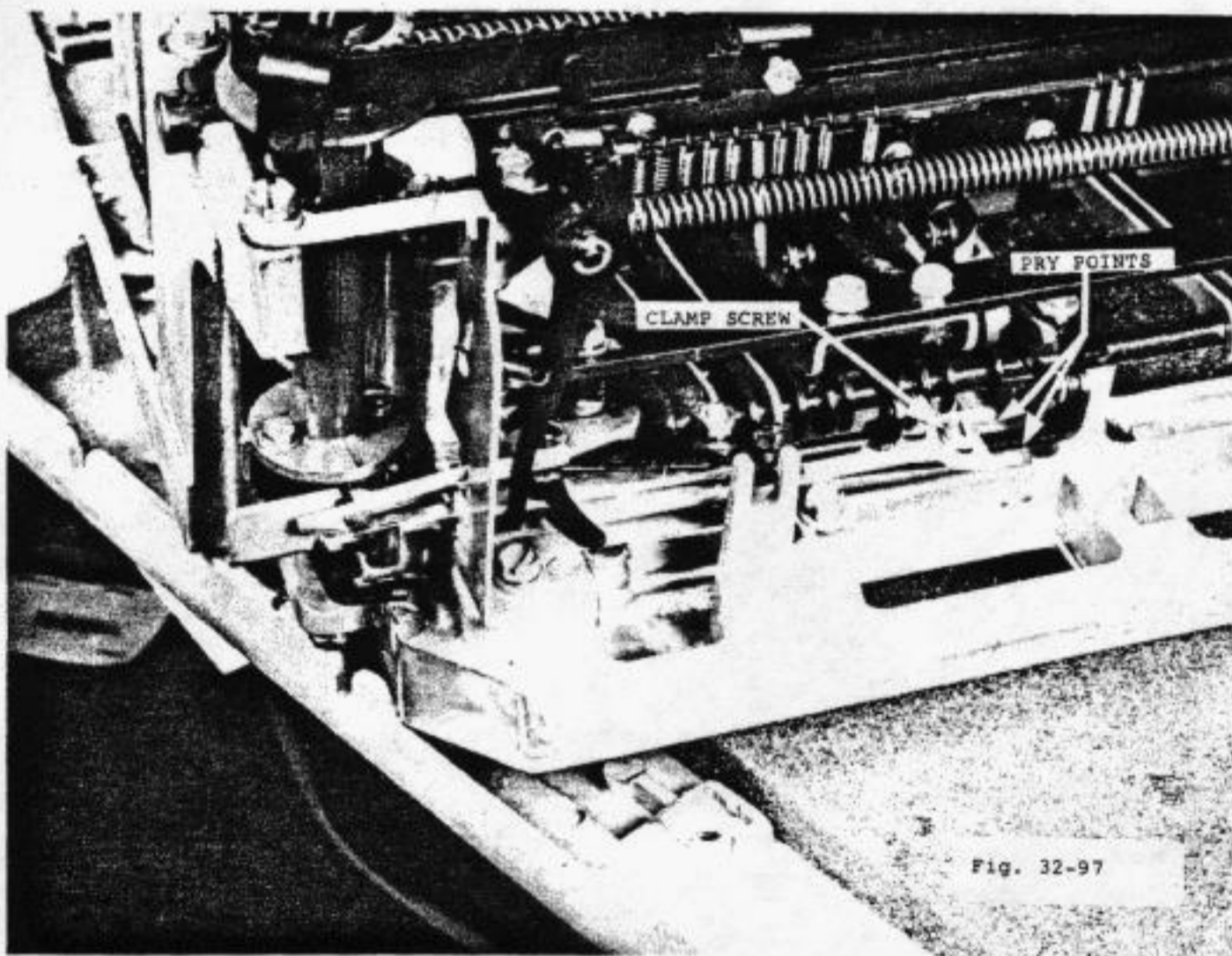

LEFT ROCKER DRIVE ARM

To Check

Set up "carriage return" code combination (---4-) or (1-34---8) in selector. Rotate main shaft until function bail is at highest point of travel.

Requirement

Min 0.020 inch---Max 0.040 inch between carriage return function lever and its function pawl.

To Adjust

Using pry point, adjust left rocker drive arm with clampscrew loosened.

Related Adjustments

Affects

RIGHT ROCKER DRIVE ARM

CARRIAGE RETURN LEVER

SPACE SUPPRESSION TRIP LEVER (Spacing Area)

LINE FEED DRIVE ARM

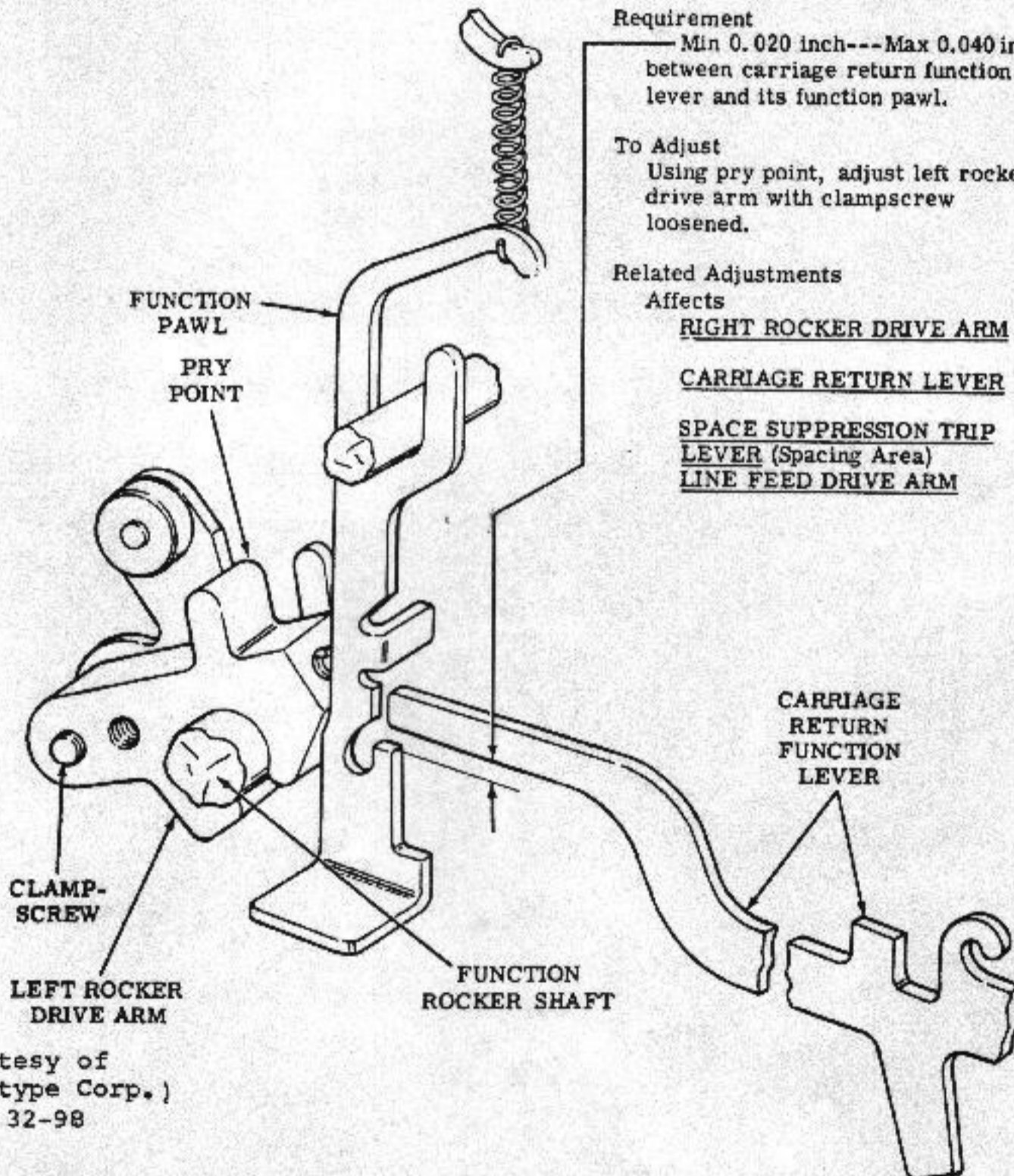

(Courtesy of
Teletype Corp.)
Fig. 32-98

Q. LEFT AND RIGHT ROCKER ARM ALIGNMENTS

1. Misalignment of either rocker arm results in misalignment of function pawls. This mean that carriage return, line feed, and space suppression may not function properly.
2. Figure 32-20 shows location of rocker arms and pry points. Refer to Figs. 32-98 and 32-99 for left and right alignment instructions.

RIGHT ROCKER DRIVE ARM

To Check

Set up answer-back character "WRU" (-234-) or (1-3----8) code combination in selector. Rotate main shaft until function bail is at its highest point. Make sure that distributor clutch has not been tripped.

Min 0.015 inch --- Max 0.050 inch

To Adjust

Using pry point, adjust right rocker drive arm with clampscrew loosened.

Related Adjustments
Affects

CARRIAGE RETURN LEVER

LINE FEED DRIVE ARM

LINE FEED STRIP LEVER

SPACE SUPPRESSION TRIP LEVER

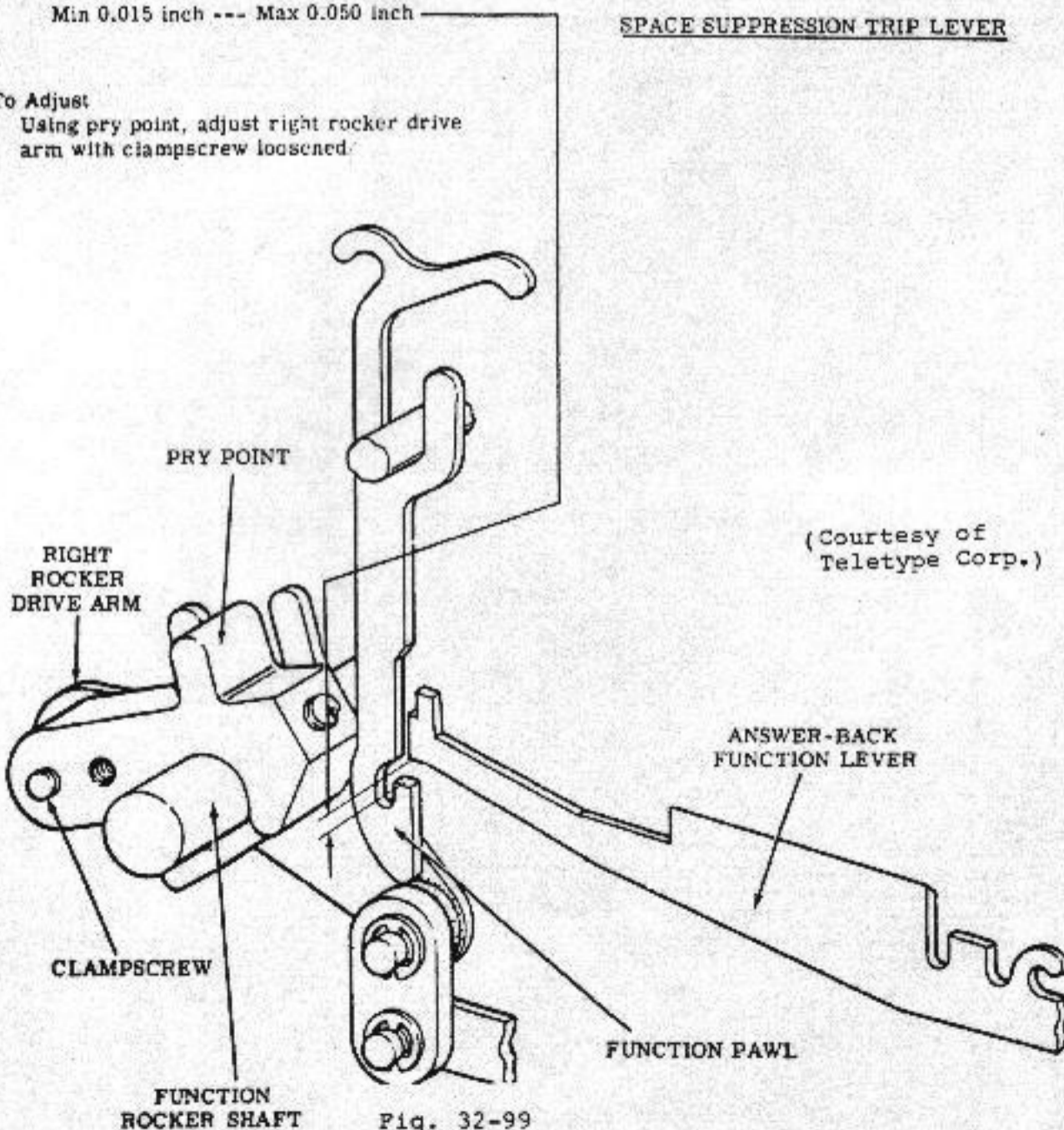
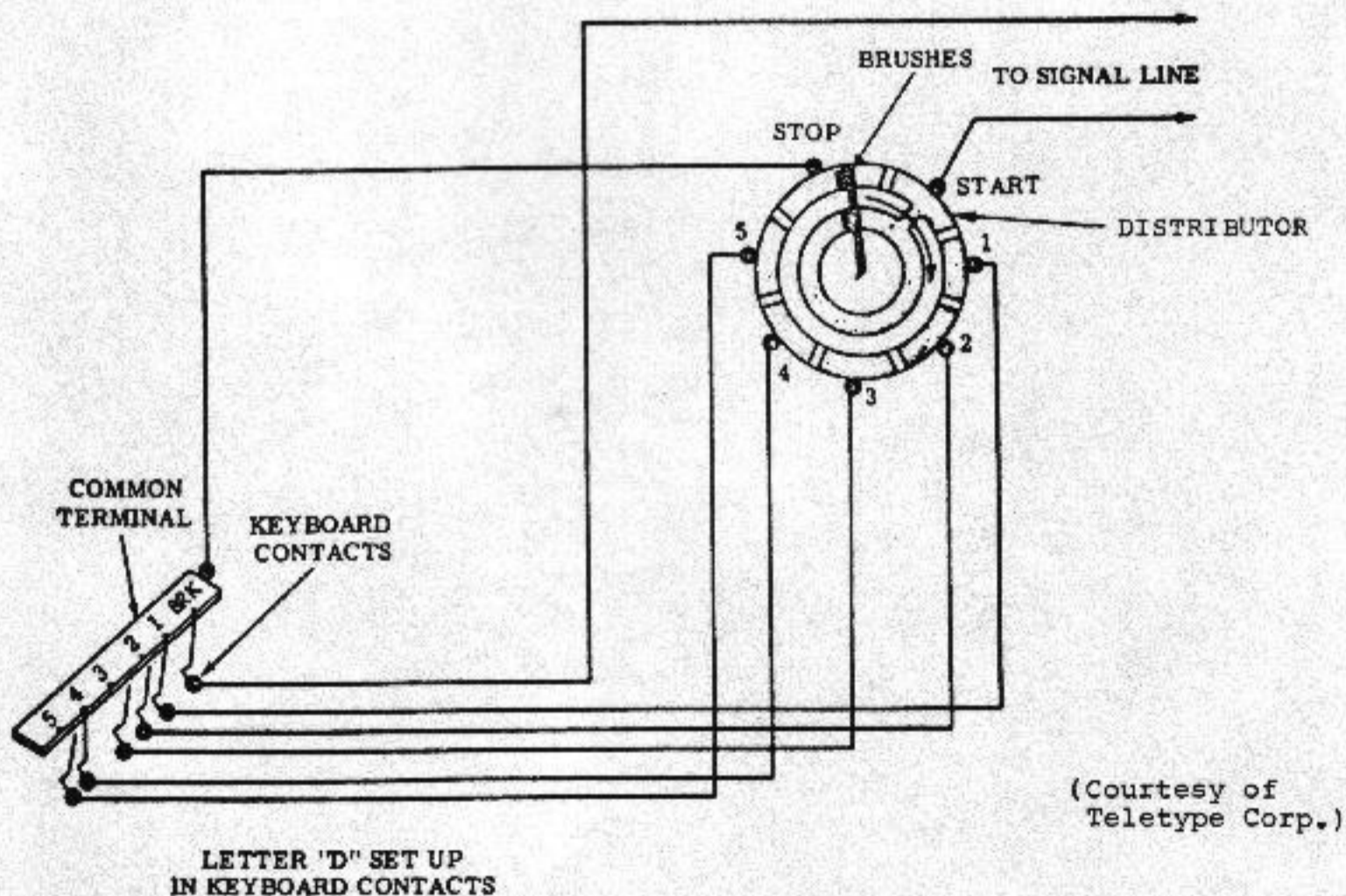
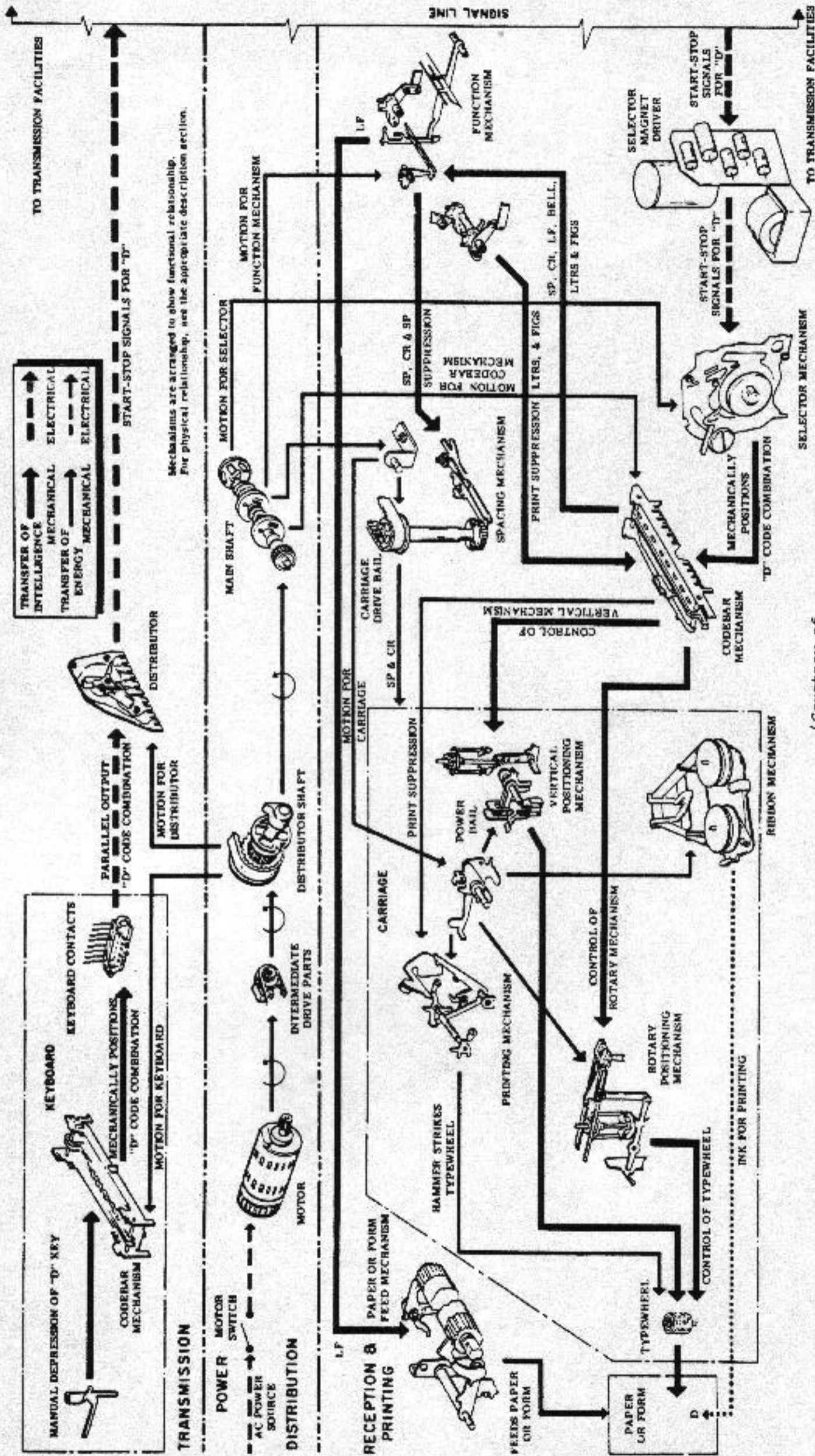

Fig. 32-99

R. MISCELLANEOUS MODEL 32 INFORMATION

1. The keyboard contacts are set up for parallel operation; that is, the individual contacts operate at the same time either in MARK or SPACE position. The timing of the MARK and SPACE pulses are provided by the distributor. It is interesting to note that the configuration of the keyboard contacts of the M15, 28, and 32 teletypewriters are quite different from each other; yet, they generate the same signal pattern. Figure 32-100 shows the configuration of the Model 32 keyboard contacts and how they are connected to the distributor.
2. The major components of the Model 32 teletypewriter and how each component interacts with one another are illustrated in Fig. 32-101.





(Courtesy of Teletype Corp.)

Fig. 37-101

Schematic Diagram -
Typing Unit Operation