

RECEIVED OCT 16 1979

OCTOBER 1979

RTTY *Journal*

VOLUME 27 No. 8

75 CENTS

EXCLUSIVELY AMATEUR RADIOTELETYPE

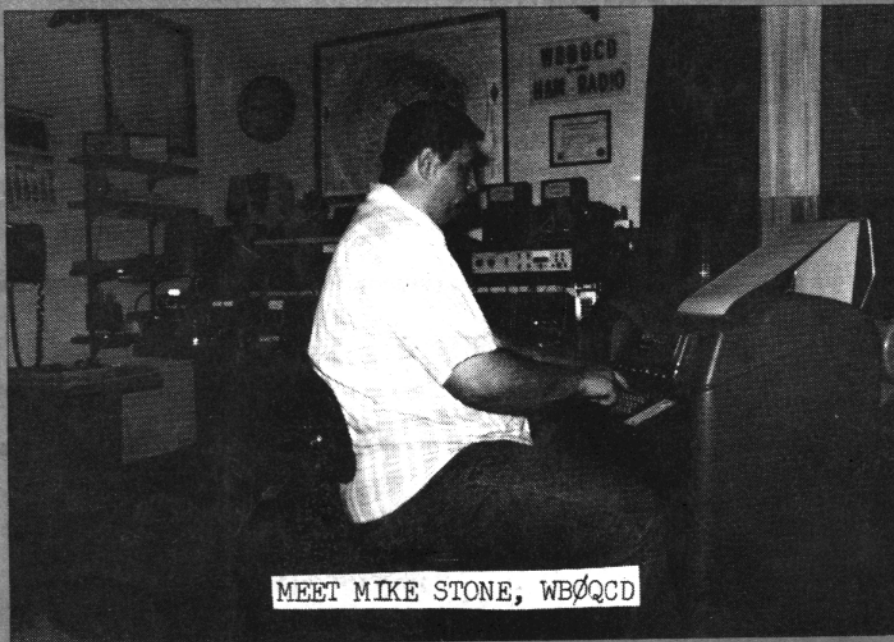

MEET MIKE STONE, WBØQD

CONTENTS

HAL D5 3000 modified
Contest Rules

CRYSTAL CONTROL FOR DRAKE

Subscription Rates

RTTY JOURNAL

Dee Crumpton, Editor & Publisher
P.O. Box RY
Cardiff by the Sea, CA. 92007

The RTTY JOURNAL
SUBSCRIPTION RATES

RATES AS OF OCTOBER 1, 1978 WILL BE
US- \$5.00 per year.

CANADA and MEXICO \$6.50 per year
Air Mail \$7.50 per year.

FOREIGN AIR MAIL \$12.00 per year.

Published 10 times per year, May-June,
July-August are combined issues.

Second Class permit Encinitas
California 92024.

Subscription rates above.

Business Offices
1155 Arden Drive
Encinitas, California 92024

POSTMASTER SEND FORM 3579 to
Post Office Box 179
Cardiff by the Sea, California 92007

New subscriptions and classified ads
are cash in advance as we have no
method for billing. New subscriptions
will be started with the current issue.

Please do not ask us to start any
further back than this. The JOURNAL
is mailed about the 20th of the month
preceding the dated month. May and
June are combined in one issue and
July and August are combined in one
issue.

BACK ISSUES

A duplicate of any back issue may be ob-
tained from R. Wilson, 4011 Clearview Dr.,
Cedar Falls, IA. 50613. \$1.00 pp. Reprints of
all UART articles, \$2.00 pp.

RTTY JOURNAL

PO Box RY

Cardiff by the Sea, CA. 92007

**FOREIGN SUBSCRIPTION
MANAGERS**

EUROPE

Jean F. Hurtaud - F8XT

Chillac

16480 Brossac, FRANCE

AUSTRALIA

Norman Wilson - VK4NP

P.O. Box - 81 a

Albion Brisbane

Queensland 4010-AUSTRALIA

THE RTTY JOURNAL AIR SHIPS TO THE FOLLOWING
FOREIGN SUBSCRIPTION MANAGERS. CONTACT THEM
FOR RATES IN THEIR TERRITORIES.

ENGLAND

Arthur Owen - G2FUD

Gwenarth

184 Hale Road

Hale, Cheshire ENGLAND

Japan

Toshio Hotta - JA2EFV

4-5-11 Tomida

Yokkaichi City

Mie-Pref., JAPAN 512

BUY YOUR RTTY BEGINNERS HANDBOOK \$4.50

TRS-80 OWNERS!

MACROTRONICS PROUDLY INTRODUCES M800 Deluxe RTTY System for the TRS-80

Look at these spectacular features

- Split-screen display. Compose and edit messages while receiving.
- Save received or keyboard entered messages on cassette and play them back at a later time.
- *Instant Replay* -- Repeat entire last transmission or retransmit received messages.
- Instant break operation - respond to a direct question (*Still Copy OK? BK*) without sending the transmit buffer. Then resume typing into the buffer where you left off.
- WRU--receive only messages directed to you, acknowledge *Station ready to receive*, then save message on cassette - all automatically. No operator intervention required. Receive messages while away.

■ Provision to call user programs from the M800 operating system. This feature will allow sending and receiving programs over the air, playing interactive games (chess, anyone?), sending real-time pictures (custom pix), auto contest logging /duping and more.

■ Instant callsign insertion. Enter other fellow's call just once, then press a single key to send entire ID exchange: W9XYZ Herb De Ron N6EE

- Direct output to your line printer or BAUDOT printer.
- Auto line numbering.
- Auto ID-RTTY and CW, CW only, or RTTY only.
- Auto left margin labeling.
- Auto carriage return/line feed-selectable carriage width.
- Auto suppress carriage returns and line feeds on receive to compact display.
- Output speed control-like the UT4-set as slow as you like to ensure uniform output rate and realtime editing.
- Four programmable messages of 255 characters each plus one *big* message limited only by RAM available (around 2.5 K on a 16K TRS-80). Save brag tapes, pix, etc. on cassette.
- Additional built-in RY, FOX, and CQ messages.

RECEIVE MODE. JLF 11294 C-72 S-45 B-60 TRU 00428 00428 30899
 IT'S TOO DAMN BAD THE DEDICATED HARDWARE SYSTEMS ARE SO IMPELDED
 I.E. IT SEEMS I HAVE TO BUY A WHOLE NEW SYSTEM EVERY TWO YEARS A
 S TECHNOLOGY CHANGES. IT'S COSTING ME A FORTUNE! THE WORST PA
 RT IS THAT I HAVE A BUNDLE TIED UP IN THIS TERMINAL SYSTEM AND I
 CAN'T USE IT FOR ANYTHING ELSE. SURE WOULD BE NICE TO BE ABLE
 TO GET THE WHOLE FAMILY IN ON THE FUN. THIS SYSTEM CAN'T
 DO ANYTHING ELSE BUT RTTY AND MORSE CODE. WISH I COULD SAVE
 INCOMING MESSAGES ON CASSETTE AND PLAY THEM BACK LATER. ALSO
 WISH I HAD SOME WAY TO INSERT A CALLSIGN JUST ONCE INSTEAD
 OF HAVING TO INSERT IT AT THE BEGINNING AND END OF EVERY QSO.

YAU RALPH I DONT HAVE THAT PROBLEM IN MY SHACK I HAVE THE
 TRS-80 GENERAL PURPOSE COMPUTER AND THE NEW M800 DELUXE RTTY
 SYSTEM. I DONT HAVE TO WORRY ABOUT MY GEAR BECOMING OBSOLETE !!

- Four Baudot speeds (60, 66, 75, and 100 WPM) plus ASCII at 110 baud.
- Auto transmitter control-keys PTT line. Fail-safe time-out circuitry for WRU.
- Continuous display of mode, options selected, buffer available no. characters typed, no. characters ahead of buffer, and more. (MUCH MORE)

Requires the M80 Ham Interface

Also recommended (not required):

- MLK-1 Loop Keyer Module \$29.
- FSD-1 Demodulator \$99.

M800 Hardware/Software / Manual \$99

Similar RTTY systems available for the PET, APPLE and EXIDY SORCERER. Write for our catalog of Micro computer products, including Baudot and ASCII printer interfaces.

M80 Send-Receive RTTY & CW

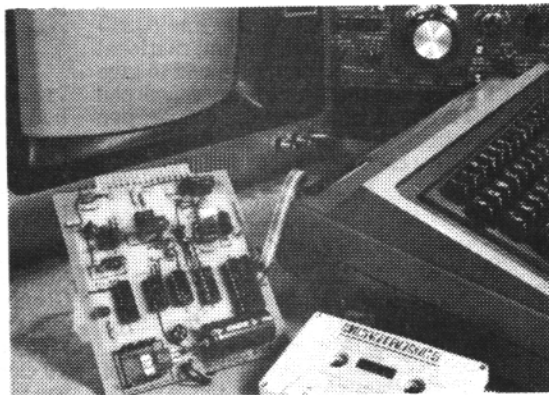

- Auto send. & receive: RTTY & CW
- Complete hardware & software.
- Connects to TRS-80 User Port & Key / headphone jacks.
- 10 message memories - 255 char. ea.
- Keyboard buffer - allows typing ahead.
- Uses built-in PLL or external TU.
- Includes hardware, cassette & manual.
- Morse trainer - random 5 letter words.
- Requires Level II Basic & 16K RAM.

NEW FEATURES

- Auto-number contest keyer.
- Interactive Graphics.
- Auto-Transmitter control.

Assembled & Tested
\$149.

■ PET, APPLE, SORCERER versions available.

Write or Call for Complete Catalog.



MACROTRONICS, inc.®
 P.O. Box 518 (R) Keyes, CA 95328
 (209) 634-8888 / 667-2888

We are experiencing telephone difficulties, please keep trying.



California residents add 6% tax

HITS & MISSES

George Hammon WA6CQW
14215 Pecan Park Lane SP 73
El Cajon, CA 92021

FROM
THE
MAILBAG



STAND UP AND BE COUNTED

I was very pleased to receive so many letters this month. The words of encouragement in your letters was most gratifying. While I was reading your letters it was apparent you were also seeking a fair shake for RTTY from ARRL League officials. The lack of communication between League officials and their members was also apparent in your letters. The image of League officials insulating themselves from their members is a curious matter and leaves one with the feeling they want your money and not your input. I think Vic Clarks Long Range Planning Committee is a start in the right direction for the future. What happens now, while we wait for the results of their labor? I think we should start a write in campaign to each of our Division Directors. Invite them to your RTTY Ham Clubs. When you go to ARRL Conventions have a mini forum with him and talk RTTY with him. Tell him the lack of articles in QST is appalling, stale dated League publications on RTTY should be updated and the lack of recognition of RTTY should be rectified. I think we should take the initiative and make our voices heard. I have composed a letter to my Division Director (Southwestern Division) and hope it may give you some ideas for your letters.

Mr. Jay A. Holladay W6EJJ
5128 Jessen Drive
La Canada, California
91011

Dear Mr. Holladay

I have recently written to Victor Clark (copy of letter enclosed) concerning long range planning for the ARRL. The contents of this letter contained a few of my thoughts concerning the ARRL and RTTY. The limitations imposed by a letter made it necessary to present only a brief overview of my thoughts. In my letter I addressed my remarks only to the future planning of the ARRL and RTTY.

Mr. Holladay, as a concerned league member in your division I wish to avail myself the opportunity to create an avenue of communication between you and RTTY members in your Division. I have never received a single communication from you concerning the league. I realize you cannot personally check to see if members in your Division are getting your information. I am not and I wonder how many other division members are not receiving your input?

RTTY comprises a large segment of the worlds amateur population. The League's attitude to ignore this area of our hobby is indeed perplexing. The marriage of microcomputers and RTTY has created a whole new era in the amateur RTTY field. While '73' and 'Ham Radio' early in the

game recognized the tremendous growth potential in this field, and thus reaped the financial rewards. The league sat back and let the competition run away from them.

I notice each month in QST advertisements concerning RTTY equipment and even lately a few equipment reviews. I cannot imagine any manufacture spending money for advertisements in QST and seeing the very group he is attempting to sell to totally ignored. This enigma would be quickly remedied if I was a QST advertiser. I would switch to '73' and 'Ham Radio' and spend all my advertising dollars with them.

The need for the League to solicit and pay for articles on RTTY and micro-computers is painfully apparent. Amateur RTTY'ERS have earned the right to be recognized in the DXCC Column. League materials including the Handbook must be updated. I realize the material the League has on RTTY is stale dated. I also realize that nine year old material could not be included in the new Handbook. The League's choice was apparently simple, we don't have any new material so delete it from the Handbook.

The Director of any of the ARRL Divisions certainly has a set of complex and varied duties. If I was a Division Director I would create a group of volunteers who act as a liaison between me and my Division members. This group would make appearances at Ham Clubs, show ARRL films and supply me with mandatory information necessary for me as an elected League official to represent my Division members.

I would like to meet with you and other members of the RTTY community at the Southwestern ARRL Convention with the purpose of creating a professional and meaningful dialoge concerning RTTY.

The ARRL to me is not a magazine (QST) nor a qsl Bureau, but the international voice of Amateur Radio. The need to give RTTY a part of that voice is my concerned hope. I know with your sincere cooperation by accepting my offer to meet with RTTY'ERS we can accomplish this.

yours very truly,

George Hammon WA6CQW

READERS COMMENTS

I would like to share with you a few of the comments taken from letters received.

"I talked with Harry Daniels President of the ARRL this spring at the Dayton Hamvention. I asked him (with a copy of the 1979 League Handbook in hand) why RTTY, Slow Scan and Facsimile chapters of the Specialized Communications had been totally ignored and deleted from the handbook? Mr. Daniels informed me that I was not the only one who had mentioned

that to Headquarters and it was simply deleted due to space allocation."

"Let me take this opportunity to tell you how much I enjoy the new format as well as the contents of the Journal. All of your editors are doing a fine job."

"First I will say I got my first ARRL Handbook in 1938, used to buy them every year. When they were only a buck a piece. Even then most of the material was repeated from year to year."

I wish I had the column space to print all your letters but had to just share with you some of the better comments.

Computer TVI

RF interference by computer systems is apparently becoming a problem. The FCC has asked Radio Shack, Heath, Atari, Apple, Technical Products, Commodore to submit their systems for TVI testing. The FCC has decided to develop regulations pertaining to allowable RF radiations levels. The present regulations exempt these companies as their systems are not directly connected to a TV set.

Conventions

The Southwestern Division Convention will be held at the Anaheim Sheraton Hotel, Anaheim, California. The date is October 19, 20 and 21st. The pre-registration prize is your choice of the following: Kenwood TS820S, Yaesu FT901 or a Ten-Tec Omini. The last date for preregistration is September 15, 1979. The price is \$17.00 (complete program) and at the door \$19.00. The banquet is only \$12.00 and Exhibits tech sessions are \$5.00 and \$6.00 at the door.

RTTY Contest

The 9th S.A.R.T.G. World Wide RTTY Contest is over for another year. I sure enjoyed it. Using low power (40 watts), I was able to make 80 contacts. I was pleased to work Al 7P8BC, who had the loudest signal on the band. I was also able to work another new one TF31RA (Iceland).

DELAWARE

I received a letter from AE3H Charles who lives in New Castle Delaware. I am sending him information on the FT101E. I hope to arrange a sked with him and get him to put out Delaware for all you that need it.

NEWSLETTERS

In the mail this month I received two very fine newsletters, Stark County RTTY Group courtesy WB8RVN and the West Island Radio Club courtesy VE2QO. Many thanks to both of you.

To close out my column this month I hope you found it interesting. The Journal would like to hear from you. The need for articles on RTTY, FM, Microcomputers and RTTY ART are still being solicited by the Journal.

So long for now
George

Classified Ads

30 words \$2.00. Additional Words 4 c ea.

Cash with Copy - Deadline 1st of Month.

THE DOVETRON SSD-100 solid state cross display replaces the conventional CRT and associated high voltage power supplies as the tuning indicator in the MPC-Series RTTY terminal units.

In addition to "instant-on" operation and a predicted reliability in excess of 100,000 hours, the solid state display out-performs the original CRT in every instance.

The absence (or deactivation) of the high voltage supplies and the resultant decrease in heat generation increases the MTBF (Mean Time Before Failure) of the terminal unit more than 10 times.

The display itself consists of high intensity (4 millicandelas), red, rectangular LEDs (Light Emitting Diodes) arranged in the traditional cross pattern and operated in a baragraph mode. The two LEDs that form the apex of the cross are tied into the terminal unit's logic in such a way that they extinguish if the TU is improperly tuned to the incoming tones, or if the incoming signal is up-side down in respect to the "sense" of the terminal unit.

A separate LED in the upper left quadrant of the cross display monitors the two input channels and flashes in the presence of time or frequency dispersive multipath distortion, indicating that the MULTIPATH CORRECTOR should be turned on.

Separate LEDs in two other quadrants monitor the status of the internal loop, the Signal Loss circuit and the Send/Receive mode of the terminal unit, making the SSD-100 a convenient display center of the various functions. A light sensitive photocell in the fourth quadrant monitors the ambient light conditions at the operating location and automatically adjusts the display's light output. Under normal conditions, the SSD-100 may be read comfortably from 75 feet.

The new front bezel contains an anti-glare optical filter and provides 30% more viewing area than the original CRT bezel.

A retrofit kit (SSD-100K) is available to update existing CRT-equipped terminal units in the field. Your inquiry will bring complete details by return mail. DOVETRON, 627 Fremont Avenue, (PO Box 267), South Pasadena, California 91030.

TELETYPE 43 KSR RS-232 \$999.95
Factory New. Postpaid USA. Data Mart, 914 Waverly, Arlington Heights, IL 60004, 312-398-8525. 6-11 PM CST.

THE RACK LINE BY DAYTAPRO, for individual or repeater these versatile uniform boards will do the job rite. All boards are 4½" X 6½" (same as the DT-600) G-10 1 oz copper solder plated with a 22 Pin edge connection. All kits have edge connector included.

CW ID SYSTEM, interfaced for digital, FSK or AFSK keying, 10 minute timer, variable speed (5-24 wpm) 12 or 5 volt use. Kit \$27.90, Board alone \$8.95.

MINI VERSION OF above CW ID (CW ID only) Kit \$19.95. (NEW LOW PRICES)

M4D POWER SUPPLY, Plus 5 volts and 1 amp with crow bar protection, Plus 12 volts and 1 amp and minus 12 volts at 1 amp. Each fused and has LED indication. Kit \$32.50 BOARD alone \$8.50.

DUEL XB-6 CRYSTAL CONTROLLED CLOCK for UAR/T control develops 6 baud rates each. Kit \$26.95 board alone \$8.50.

CRYSTAL CONTROLLED AFSK. Now enjoy rock solid frequency with no drift. Kit \$28.49 BOARD ALONE \$8.75.

TU-LOOP POWER SUPPLY. Low voltage supplies (+5, +12 and -12) all rated at 800 mls each with a high voltage loop supply with the keying transistor located on board. Also has a 20 mil loop driver and keying provisions, input keying need be only 5 volts and ground. Kit \$52.49 Board Alone \$8.50.

EXTENSION BOARDS (available in July, 1979.) Two types. Stright for rack testing and 90 degree angle for cabinet testing. With Edge connector Kit \$13.95.

UT2B SPEED CONVERTOR (Available in October 1979) Write for additional information.

UNIVERSAL BOARD (Available in September 1979) Write for additional information. DAYTAPRO ELECTRONICS, INC., 3029 WILSHIRE LN, ARLINGTON HTS, IL 60004. PHONE 312-870-0555 EVENINGS. Add \$1.00 for shipping, Visa accepted.

TELETYPEWRITER parts wanted for all machines manufactured by Kleinschmidt, Mite and Teletype Corp., New only, Also sub-Assembled. I pay shipping. Phil Rickson, W4LNW, Rt. 6, Box 1103G2, Brooksville, FL 33512.

SALE! SALE! SALE! SALE! SALE!
RTTY ID GENERATOR. Accepts 5 or 12 volt supplies, 31 characters available, (please include letters, figures, spaces etc.) Your pre-programmed answer-back must be supplied with order. EXAMPLE: DE K9WRL NEIL ARL HTS ILL. Board is the same size as the ST-6 Boards. WAS \$34.99 SALE PRICE \$24.95. BOARD ALONE WAS \$8.50 SALE PRICE \$6.95. ADD \$1.00 FOR SHIPPING. DAYTAPRO ELECTRONICS, 3029 N. Wilshire Ln. Arlington Hts., IL 60004 VISA AVAILABLE. PHONE ORDERS 312-870-0555 EVENINGS.

UT-4B KITS NOW AVAILABLE, All logic, resistors, capacitors, diodes and transistors to fill board, edge connector included. See November 1978 RTTY Journal for users report. Kit 109.95, UT4B Board alone \$17.95 M4D POWER SUPPLY for UT-4B, Kit \$32.50, Board alone \$8.50 DUEL XB-6 OPTIONAL CRYSTAL CLOCK for UT-4B, Kit \$26.95 Board alone \$8.75. Additional information available with a stamp. DAYTAPRO ELECTRONICS, INC. 3029 N. WILSHIRE LN, ARLINGTON HTS., IL 60004 VISA ACCEPTED, PHONE EVENINGS 312-870-0555.

FOR SALE: RTTY Demodulator, designed especially for the reception of shortwave RTTY signals with various types of speeds and shifts. The PLL circuit is adapted automatically to the shift of the station received! Printing usual stations like press, military, amateur, diplo, weather, etc., is rather easy with this LED-controlled unit. Features: switchable audio filter; autostart relay; power supply 220 V AC 50 Hz; outputs: loop supply for mechanical RTTY machine, and/or TTL-compatible for VDU. Price, including packing and surface mail postage to anywhere in the world, DM 460.00 or \$260.00. Some more information is air mailed to you for DM 10.00 or \$6.00; this amount is credited on the final price of the unit if ordered later on. Joerg Klingenfuss, Goethestrasse 14, D-7400 Tuebingen 1, West Germany.

MODEL 28 ASR with TD and PERF \$350.00 add \$50.00 for reperf instead of perf. Model 28 KSR \$175.00 add \$100.00 for 60-75-100 gearshift add \$50.00 for answerback. Model 28 chadless reperf with 60-75-100 gearshift \$125.00 add \$50.00 for keyboard. All above rewired and ready to plug in. Bill Parker, 984 Amelia Avenue. Akron, Ohio 44302.

SIG. CORPS TEST SETS TS-2/TG (TT) sends fox, SIG (60-100) speed. Quantity available, good condition, rare find. Cheap; (1,000) return address labels heavy stock, striped, \$2.00 PSTPD. QSL's printed, low cost; (SASE) to D. Testa Jr., 390 Lincoln Ave., (R.J), Newark, NJ 07104.

ST-5, DT500, NS-1A OWNERS. Get increased selectivity with our active bandpass filter 2125/2295 HZ. See February Journal. Kit \$11.95, WIRED/TESTED \$16.95 Postpaid. SASE for info. Nat Stinnette Electronics, Tavares, FL 32778.

SOLID STATE TIME Delay relay. 10 MW input signal can control up to 1 kilowatt of load power. Great for teletype users in the Microcomputer and/or Amateur Radio environments. Plans or PC Board \$5.00, information \$.50. Keith Ryan, Dept. RTTY, Box 3103, Ottawa, CANADA KIP 6H7.

FOR SALE: Hal DS-3000 KSR, version 3, with sanyo model 4215 Professional 15 inch monitor \$1125.00, Jim Lee, WB0PMT, 3086 N. Milton St., St. Paul, MN 55113, (612-484-8030).

TELETYPE MACHINES AND ALLIED EQUIPMENT. SASE for list. Model 28 three (3) speed receive only \$250.00. Model 28 ASR. Perforators, TD's, ROTR's. Modems, TWX's, Telex's ETC. Antique Telegraph Instruments. Goodman 5454 South Shore Drive, Chicago, IL 60615 (312-753-8342).

INFO-TECH M 200E (72) KBD M300 TU, 60-66-75-100 WPM CW 4-125 WPM TX and RX ASCII 110/300 BAUD 6 Moths old \$850.00 Bob Smith, WB6DR, (714-443-3400), 9129 Pueblo Road, Lakeside, CA 92040.

SELL: MODEL 28 KSR, three speed floor model \$190.00, 28 TD, stand alone with 60/100 speed gears \$120.00, 28 typing reperator, stand alone three speed \$125.00 Package price available. W3JW Jeff (301-437-0171).

SURPLUS TD PAPER YELLOW AND OILED

11/16 carton of 10	\$ 3.00 Wt 13
carton of 40	\$10.00 Wt 48
7/8 carton of 8	\$ 3.75 Wt 13
carton of 32	\$12.00 Wt 48
7/8 Blk carton of 8	\$ 3.00 Wt 13
carton of 32	\$10.00 Wt 48

Add UPS wt Harmon 5628 10th Ave So. Birmingham Ala. 35222

KITS! ST5X TERMINAL UNIT/POWER SUPPLY/AFSK. WRU. RITTY SCOPE AMPLIFIER. Write for details: Bomark, Inc., Box 7116, Hollywood, Florida 33021, 305-962-7219

Ham Radio Magazine-The no-nonsense state-of-the-art technical magazine. Dozens of exciting projects and an emphasis on quality unmatched by any other radio magazine. Subscribe now and see for yourself. 1 year; \$12.00, 2 years; \$22.00 and three years.. \$30.00 Ham Radio Magazine, Greenville, NH 03048.

FOR SALE: 4TH Edition of the "LIST OF RTTY STATIONS IN FREQUENCY ORDER", now contains more than 2800 frequencies of commercial stations like press, military, diplo, telex, weather, etc. on shortwave. Schedules of around 100 news agency stations are also included.. This offset printed list is air mailed to you for \$15.00 or 39 IRC from Joerg Klingenfuss, Goethestrasse 14, D-7400 Tuebingen 1, West Germany.

Model 28 ASR's, GEARED FOR 100 WPM, rewired for amateur use, \$300.00. Model 35 RO's \$300.00. Model 33 RO \$250.00. Can Ship. M. Gaston, 2117 Westlake Drive, Plano, TX 75075.

TY-300 TELETYPE MODEMS, Pulled from service and sold as is but complete with installation and operation instructions and schematic; \$17.50 postpaid. M. Gaston, 2117 Westlake Drive, Plano, TX 75075.

TELETYPE SUPPLIES, Technical manuals, equipment. 11/16" and 7/8" perforator tape. Page paper. New ribbons. Teletype Corp. maintenance manuals. Let me know what you need. Send 75 cents postage for 3 current catalogs. JIM COOPER, W2JC/W2BVE, Box 73, PARAMUS, NJ 07652.

THOUSANDS OF COMMERCIAL RTTY stations are active between the amateur shortwave bands. Many of them can be printed easily with your existing equipment. (Take care of legislative restrictions if applicable!) If interested, you need "software", compiled from nonstop monitoring the complete shortwave spectrum. I do have up-to-date frequency, callign, schedule, code lists for press, Military, DIPLO, Telex, Aeronautical, Weather, Etc. Stations. Write for details. Joerg Klingenfuss, Goethestrasse 14, D-7400 Tuebingen 1, West Germany.

KLIENSCHMIDT RE-PERF-TT-107 Choice 60 or 100 words. Checked out and working \$39.95 add UPS 40 lbs. Harmon 5628 10th Avenue So Birmingham Ala. 35222.

UT-4B, M4D, XFRMR, all components mounted, you put in box and troubleshoot \$150.00. W.R. Johnston, WA4AOZ, 687 Monticello Way SE, Marietta, GA 30067.

NEWS-NEWS-NEWS-Amateur Radio's Newspaper, "Worldradio". Trial subscription - Two issues for one dollar. "Worldradio", 2509-F Donner Way, Sacramento, California 95818.

UT-4 COMPONENTS. FC33512DC FIFO \$12.00, AY5-1013A UART \$5.00 Others as listed July/August ad except 74221/74LS221 in very short supply. Everything postpaid (Airmail overseas). Peter Bertelli, W6KS, 5262 Yost Place, San Diego, CA 92109. (714-274-7060).

MODEL 14 TYPING REPERFS \$35.00 each. Model 28 TD's \$30.00 each. All work. Add \$5.00 for UPS. Write Illiana Repeater System, P.O. Box G, Catlin, IL 61817, or call (217-267-2734) or (217-446-6985).

HAL D5 3000 K S R MODIFIED

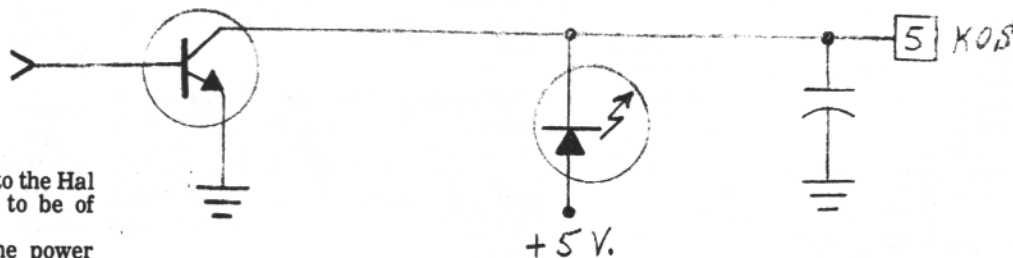

Here is a simple modification to the Hal DS-3000KSR, that I have found to be of some value.

Drill a 1/4 inch hole near the power switch and install a Light Emitting Diode (LED) connect the LED to 5volt and pin 5 of the loop connector.

The LED will light as long as there is data being sent from the buffers.

J. L. Kofron - K7GW
2038 Palm St. 225
Riviera Vegas Park
Las Vegas, Nevada 89104

NOW YOU CAN HAVE BOTH HIGH QUALITY & LOW COST!

The DS2000 KSR FROM HAL

HAL design experience now makes it possible to offer you an efficient, reliable, and cost effective terminal for your RTTY or CW station. Investigate the new DS2000 KSR from the people who KNOW HOW to build RTTY and CW equipment. See how you can get great performance and save money too!



- Integrated keyboard and video generator
- 72 character line
- 24 line display
- 2 programmable "Here Is" messages
- Automatic carriage return and line feed
- QBF and RY test messages
- Word mode operation, full screen buffering
- All 5 standard Baudot speeds
- 110 and 300 baud ASCII
- CW identification at the touch of a key
- Morse code transmit
- Morse code receive (optional)
- self tracking speeds from 1-175 wpm on a separate plug-in circuit board (Available June, 1979)
- All in a convenient, small cabinet (14.1" x 9.25" x 4.35")

Price: \$449.00

Optional Morse Receive Board: \$149.00

Optional 9" monitor: \$150.00

BIG PERFORMANCE SMALL SIZE. . . SMALL PRICE

If you're looking for an RTTY demodulator with great performance on both the HF and VHF bands, take a look at the ST-5000 from HAL. The use of active filters with no phase-lock loop or 'single-tone' short-cuts ensure the kind of performance you expect. Full features in an attractive and conveniently small package make this demodulator a value that's hard to beat!

- Hard limiting front end
- Active discriminator
- Active detector
- Wide and Narrow shift (850hz and 170hz)
- Normal and Reverse sense
- Autostart
- Self-contained high voltage loop supply
- RS-232C voltage output (direct FSK)
- Audio tone keyer (AFSK)
- Provision for external tuning scope
- Attractive, small cabinet (2.75" H x 8" D x 12" W)
- Fully assembled and tested

Price: \$225.00

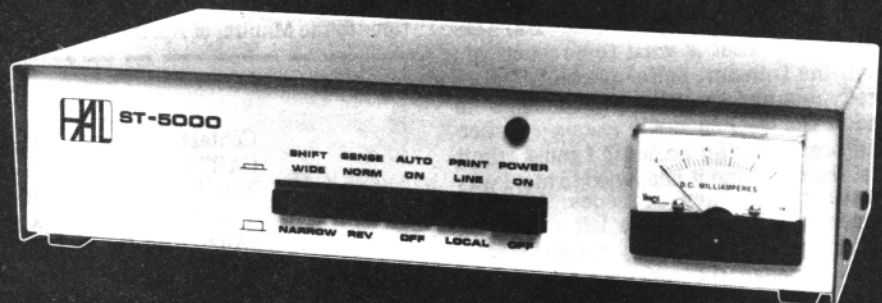

For more information call or write us at:

HAL COMMUNICATIONS CORP.

P.O. Box 365

Urbana, IL 61801

Phone: 217-367-7373

In Europe contact:

Richter & Co.; Hannover

I.E.C. Interelco; Bissone



the exciting new INFO-TECH M-70 CODE/SPEED CONVERTER

The Info-Tech M-70 is a microprocessor based unidirectional simplex converter which will accept as an input: Loop, RS-232 or TTL signals at Baudot speeds of 60, 66, 75 or 100 wpm or ASCII speeds of 110 or 300 baud. The outputs of the M-70 are: Loop, RS 232 and TTL at Baudot speeds of 60, 66, 75 or 100 wpm or ASCII at 110 or 300 baud. With simple external switching, the M-70 can be operated half duplex in any mode/speed conversion combination.

A 1024-character buffer is provided for down-speed conversion, with buffer empty and buffer full status indicator outputs.

OTHER FEATURES:

- Auto-start output with two selectable formats: channel active, or space character detect
- Two programmable sel-cal (selective calling) outputs decode up to 7 characters each. (4 character turn off code)
- WRU output generated after detection of a string up to 7 characters long
- Selectable automatic C/R and L/F
- Selectable unshift on space (Baudot inputs only)
- Selectable bell defeat
- Selectable parity select (ASCII outputs only)
- Buffer Run/Load input

PRICE \$175.00 FCB ST. LOUIS.

The M-70 is a "Semi-Kit", including a completely assembled and tested printed circuit board with 22 pin, double side edge card connector, power transformer, complete schematic and operating information with several application examples. All that need be added are selecting switches, when options may want to be changed, indicating LED's, and a suitable cabinet or card rack position.

User Specified, Factory Programmed Options Include:

Selcal #1 = _____ Off = _____
 Selcal #2 = _____ Off = _____
 WRU = _____

Enter only one character per space, including non-printing characters, shown as follows (all spaces need not be filled in):

Figures = † Line Feed = L/F
 Letters = ‡ Blanks = BLK
 Carriage Rtn = C/R Space = SPC
 eg. Selcal #1 = W † ‡ † K E BLK Off = N N N N

Please use order form supplied.

see above

INFO-TECH INCORPORATED
 Specializing in Digital
 Electronic Systems

2349 Weldon Parkway
 St. Louis, Missouri 63141
 (314) 576-5489

ADDENDA TO "HAL'S DS 3100 ASR" ARTICLE in SEPTEMBER RTTY JOURNAL ISSUE 1979 ED TREGO — W9WKC

There is a point which has since come up in operation practice which I completely missed in my original article on "Hal's DS 3100 ASR." That is what to do when you have the transmit buffer partially full of pre-typing and the fellow on the opposite end of the QSO suddenly asks a question and breaks for an answer? I must admit that the first time it happened to me, I was Place a flag, key sequence, FN-Flag, which will appear on the left side of the sursor and locks up any typing to that point. Change the machine to transmit "enable" status and any further typing goes out on the air as typed, leaving any previous typing in the transmit buffer. When the question is answered or comment made; reposition the cursor back to the flag, return the ASR to transmit "inhibit" status, wipe out the flag with again FN-FLAG. Then, continue the "in buffer" typing. Any new typing will just be typed over the printing made during the break.

My DS 3100 ARS is one of the early models, there has been a subsequent change in both the circuitry and com-

puter programs for Morse Code reception. In the original Morse set-up, there were problems with receiver or transmitter frequency instability. The THRESHOLD CONTROL is now a frequency control instead of acting as a noise squelch. A different tuning technique is required and is fully explained in Addenda and Corrections to the Manual of April 1979.

"Kontest Korner"

Contest	Dates	Rules Printed in
CARTG	20-21 October 1979	Sept. 79
WAEDC	10-11 November 1979	no rules yet
Giant Flash (Australia-Oceania & Asia)	3-4 November 1979	October 79
DAFG	24 November 1979	March 79
Volta	1-2 December 1979	no rules yet
Giant Flash (North & South America)	19-20 January 1980	October 79
Giant Flash (Europe & Africa)	9-10 March 1980	October 79
BARTG	March 1980	October 79
VK/ZL/Oceania	June 1980	
SARTG	August 1980	



VHF RTTY NEWS



Army Gamson, K6PXA, 8034 Gentry

N. Hollywood, CA 91605

Glad to see lots of reports of new exclusive RTTY repeaters on. The 10/70 machine is temporarily down in Lowden, Iowa. Most of the Group is operating simplex on the output. The new president of the BI-State VHF Teleprinter Society is Dave Johansen-WB0FBP. There is another 10/70 repeater in Des Moines, Iowa and Winona, Minnesota. In Illinois (near Peoria) is WA9LRO/RPT in Gridley which is shared voice and RTTY-regenerated. This repeater covers about a 100 mile radius. Also in Chicago, Illinois is the Chicago Area RTTY Repeater System (CARRS) new repeater on 144.71/145.31 NH. Their UT-2 converter and Xtal controlled AFSK generator. The repeater will have a computer performing mail box service AND emergency weather bulletins service. They will be holding an RTTY seminar at the radio expo this year. Contact: PAUL MAYER Jr.-WB9ZHG, PRESIDENT CAARS C/o 1549 N. Cicero, Chicago, Illinois 60651. Still looking for someone to take over this fine column. Hope to see your Clubs Newsletters — keep them coming. Thanks to the Journal Staff for inventing a new disease for me; It's Cushings not Cushman's! Getting better all the (long) time thanks. Follows is a pertinent article on getting into computers (isn't everyone?;

COMPUTER TALK

Over the last couple of years I have tried to convince several people that they should buy a computer. I have heard a variety of reasons why they should not. This month I will try and convince you that the purchase of a computer is not as outrageous as it seems. In almost all cases a person has an excuse for not buying a computer. This month I will try and answer some of the more common ones.

"I don't know anything about computers." — Knowledge of how the inside of you teletype works? Or how about the guts in your TV set? I'm sure that you have at least some knowledge how these things work but could you fix one? Even people who do not have any electronics knowledge

still enjoy a good movie on the "tube". As time goes on you will get curious as to what happens inside the computer and you will certainly learn thru study and hands on tinkering.

"I don't know anything about programming." This is the excuse that people with electronics knowledge used most of the time. Again it is not necessary to know how to program. There is available for each computer a large amount of software (remember last months definition). Most of the micros on the market today have available a BASIC that will make programming very easy.

"How do I justify the expense?" — Well how do you justify the new HF rig; or the color TV set? A computer will not only find its way into the ham shack but when the XYL finds out about it she will have it planning menus and keeping inventory of the groceries. The kids will be playing games on it and the dog may even want to get into the act. What I am trying to say is that a computer can find many uses around the house other than a in the shack. Along these lines some people ask "what good is a computer?" I ask you what good is a beachball? It is nothing but a piece of plastic filled with air! The beachball (and the computer) are only as good as the imagination of the owner allows them to be. The more things that you can think of to do with them the more useful they are.

"I can't afford one." This is the only excuse that can't be refuted. But it must be remembered that you need not get a computer with 48K and line printers to enjoy them. You can start with a basic system and either add to it or move up to a larger one as the pocketbook permits.

Lets assume at this point that I have convinced you that you should join in the fun and you want to get a computer. The burning question that is now in your mind is WHICH ONE? Only you can answer this question! I will try and give you a few things to consider while making this paramount decision. 1) What do I want to do with it (both now and in the future)? 2) Do I want to be able to build circuits for it or just operate it? 3) How much do I want

to spend on it? All three of these questions will determine which one is the best for your needs. If the only thing that you wish to do with the computer is to run RTTY then a system like the HAL, Microlog or Info-tech would be the one for you. If you would like to do other things with it then you still have about 60 different ones to chose from.

If you are not afraid of small solder joints and homebrew add-ons then you might look into the various kits that are on the market (SWTPC, Sphere, Imsai, etc) and you can save some money here and custom build the system to fit your needs. If you want everything is one neat little box then the TRS-80 or Apple 2 would be front runners. \$\$\$\$\$ is the big factor.. Computer systems can be had for \$149.95 but these are bare bones computers and there is a hidden cost of the necessary add-ons needed to really do much with them. Don't get me wrong — these bare bones systems have their place. They are great learning tools. nd can be a dedicated controller, but they do lack versatility. super-duper systems go for about 10 grand and up. Most of these type systems are being bought by small businesses. Quit beating around the bush you say and tell me how much I should spend. Okay I will! Look for an initial outlay of about !600 for a good system. For this amount of money you can get a computer that you can learn on and has enough versatility to be expanded to a larger system as the need arises.

In summary, if you are thinking in the least about getting a home computer I would encourage you to drop by your local computer store (they are listed in the yellow pages) and talk it over with the "experts." 73's DE AH6AC-DALE OTT So. Counties A.T.S. "Scatter"

*C U Enjoy
Army*

A FOND FAREWELL TO ARMY
WE WILL MISS YOU.



Deal yourself in...

Use our classifieds.

• RTTY-DX •

SKIP PRINSEN WB6CYA 714-276-3182

3611 Merrimac, San Diego, Calif. 92117

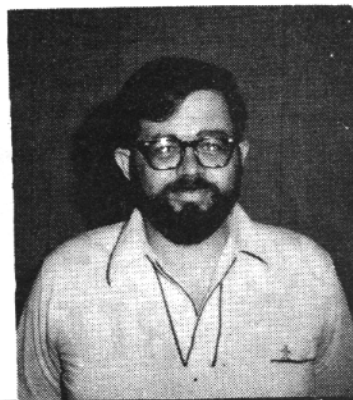

Greetings to all...

With the beginning of a new school year my shack is in a turmoil with missing paper pencils etc.

The DXCC honor roll will run again with the January issue. Please don't wait until the last minute to give me your scores. If you get any last minute changes a phone call or short note to me will update your listing. I must have your inputs by the 1st of Decemeber so please don't wait until its too late. Again please mail your inputs directly to me and not to the Journal Office as that causes in some cases very long delays in getting into print. For the new comers all that I need is your call sign number of countries worked and the number of worked countries that you have confired.

Not much news from the DX stand point due to moving my station to another room in the house.

John W3KV writes that no sign of Bruce at Sri Lanka as of 15th of August. For that matter not many people if any have heard from Bruce in some time.

The boys in Europe have worked Alain 5R8AL on 15 meters. Als M1C has been on with CQ's but doesn't respond to calls.

5B4HF on 15 meters also JA0BxU/SU was worked on the East Coast the first week of August.

TI2CAH is quite active and also have printed TI2AEB.

Also ZLI4VO, HK2YO, LX1HA/M, PS7JA, KG6JJY, KL7JHD, LU2DGO, GM3GGL, YU2OH.

Sid, 5N0SID, is back in England for a short vacation. He will bring TTY gear when he returns to Nigeria. In the meantime 5N0DOG is quite active. QSLrua W4FRU. (thanks John

From the awards sections
JA1EN Earned WAS all on 14MHZ numbered #74 dated 15 September 1979. Yasu. Shimada worked all contacts during 1979 a very commendable task indeed.

DL8KS Earned DXCC #39 dated 29 August 1979.

JA8ADQ Earned DXCC #40 dated 15 September 1979.

That's all for this month.
73 de Skip

CONTESTS

12 EUROPE & AFRICA "GIANT" RTTY FLASH CONTEST Sponsored by IATG

IATE — Radio communications announces its 12th annual "GIANT RTTY FLASH CONTEST" as part of a new promotional program for RTTY.

The basic purpose of this contest is to increase in RTTY, but even more to increase interest in intercontinental contacts rather than just international contacts.

We have tried our best to organize the contest along these lines. We have retained the "FLASH" format of the previous contests, which we developed and had been adopted by many other clubs, since it has proved to be effective.

We are open to and welcome suggestions which might improve future conts.

- 1) CONTEST DATES
1st 14.00-24.00 GMT March 9th 1980
2nd 08.00-1800 GMET March 10th 1980
- 2) BANDS
3,5 - 7 - 14 - 21 - 28 MHz amateur bands.
- 3) COUNTRY STATUS

The DXCC list will be used except that the VE/VO, W/K, VK, PY, LU, JA, UA0/9 call areas will be considered as separate countries.

- 4) MESSAGES
Messages will consist of:

- a) RST
- b) number of QSO
- c) one's continents (Example; I4XXX 599 EUROPE).

- 5) EXCHANGE POINTS
QSO on 3,5 - 7 MHz 1 point
QSO on 14 MHz 2 points
QSO on 21 MHz 8 points
QSO on 28 12 points

No points or multipliers for contact with one's own country. Only 2 x RTTY QSO are valid.

- 6) LOGS AND SCORE SHEETS
Use one Log for each band.

Logs must be contain:
date, time (GMT), call sign, RST-number of the QSO-continents sent and received, country and continent multipliers, points and final score.

Each station may be contacted only once on any band, additional contacts may be made with same station if a different band is used. In order to qualify, all logs must be received not later than: 15 April 1980.
Send them to:

Prof. Franco Fanti
Via A. Dallolio n 19
40139 BOLONA (Italy)

7) MULTIPLIERS

Multipliers are given for countries and continents. A multiplier is given for each country worked on band 14-21-28 MHz. **NO MULTIPLIERS FOR 3,5 - 7 MHz.**

A separate multiplier may be claimed for the same country if a different band is used (max 3 time).

Only countries which appears in an least 5 other logs will be valid as multipliers.

One's own country is not valid as a multiplier.

The continents are valid as multipliers. For contacts with Europe or Africa (domestic or intercontinental) the sender and the receiver will each be assigned 100 points as multiplier. 50 points will be assigned for each of the remaining continents contacted.

An additional 100 points will be given for each contact with Europe & Africa on 21 or 28 MHz.

8) SCORING

TOTAL POINTS x TOTAL NUMBER OF COUNTRIES x TOTAL CONTINENTS POINTS + TOTAL POINTS EUROPE & AFRICA STATION WORKED.

Example: 600 points for total x 10 countries worked x 100 continents points = 600.00 plus 20 station of Europe & Africa worked on 21-28 MHz giving a great total of 602.000 points.

ATTENTION: two promotional periods are included in the contest
Saturday 9 March 17.00-18.00 GMT
Sunday 10 March 10.00-1.00 GMT
OMs operating from North America, South America, Australia, Oceania, or Asia who contact Europe and/or Africa (during these hours) will **DOUBLE** their points for these periods.

BEGINNER PRIZE: RTTYers entering logs in the "GIANT" contest who have not participated in previous contest will receive an additional bonus of 5 percent of their final score.

HANDICAP: — 10 percent of the total final score of the winner of a previous RTTY Championship.

— 8 percent of the total final score for the winner of on or more precedents RTTY contest.

9) SWLs

This contest is open also the RTTY SWLs. The same scoring rules for OMs are valid for SWLs.

A separate result table will be made for these entries.

The logs for SWLs must contain: date, time (GMT), call sign of the station heard, RST — number of the QSO — continent of the station heard, country and continents multipliers, points and final score.

The same station is valid **ONLY ONE TIME ON ALL BANDS.**

10) PRIZES: GRAND PRIZES, AS USUAL, ARE RESERVED FOR THE FOUR FIRST PLACE WINNERS. CONSOLATION PRIZES ALONG WITH MEDALS AND CERTIFICATES WILL ALSO BE AWARDED.

11) RULES OF BEHAVIOUR AND PENALIZATION

Logs must be compiled in accordance with the above mentioned rules. The contacts must be made by means of the RTTY mode **ONLY**. That is other modes of transmission are not permitted before, during or after the exchange of the radio teletype message. During the contest it is expected that amateurs will observe the fundamental rules of courtesy and good operating. The contest disqualification criteria used by the ARRL in its contest apply also to this contest.

Failure to observe any of the above rules will result in the exclusion of the entry from the final results and any such log will be considered as a check-log. Logs with compiling errors which exceed 10 percent of the final score will also be excluded from the final standing and will serve only as check-log. Logs received become the property of the IATG — Radiocommunications and will not be returned.

The decision of the organizing Committee in any dispute will be final and any subsequent controversy may not be referred to the Civil Court.

REMEMBER: this contest is valid towards the final standings of the **CONTINENT WORLD CHAMPIONSHIP.**

**AUSTRALIA - OCEANIA - ASIA
RTTY FLASH CONTEST**

Sponsored by
E.A.T.G.-Radiocommunications

IATG Radiocommunications is pleased to announce the first annual AUSTRALIA-OCEANIA & ASIA RTTY FLASH CONTEST.

IATG, the leading organization for the promotion of radioamateur techniques, is presenting this contest to increase interest in inter-continental communication, interest which has tended up to now more towards international contacts.

Experienced gained from this contest will be incorporated into organization of future contest. All suggestions and constructive criticism are welcome.

1) CONTEST DATES

1st 08.00-18.00 GMT 3 November 1979

2nd 08.00-18.00 GMT 4 November 1979

2) BANDS

3,5 - 7 - 14 - 21 - 28 MHz amateur bands.

3) COUNTRY STATUS

The DXCC list will be used except that the VE/VO, W/K, VK, PY, LU, JA, UA0/9 call areas will be considered as separate countries.

4) CLASSES

a) Single or multioperator, single transmitter.

b) SWL's

5) MESSAGES

Messages will consist of:

a) RST

b) number of the QSO

c) one's continent (Example VK4XX 599 72 Australia)

6) EXCHANGE POINTS

QSO on 3, 5 and 7 MHz 1 point

QSO on 14 MHz 2 points

QSO on 21 MHz 8 points

QSO on 28 MHz 12 points

No points or multipliers for contact with one's own country. Only 2 x RTTY QSOs are valid.

7) LOGS AND SCORE SHEETS

Use one log for each band.

Logs must contain:

date, time (GMT), call sign, RST-number of the QSO-continent sent and received, country and continent multipliers, points and final score.

Each station may be contacted only once on any band, additional contacts may be made with the same station if a different band is used. In order to qualify, all logs must be received not later than: **15 December 1979.**

Send them to:

Prof Franco Fanti
Via A. Dallolio n 19
40139 BOLOGNA (Italy)

8) MULTIPLIERS

Multipliers are given for countries and continents. A multiplier is given for each country worked on band 14-21-28 MHz. **NO**

MULTIPLIERS FOR 3, 5 - 7 MHz.

A separate multiplier may be claimed for the same country if a different band is used (max. 3 times).

Only countries which appear in at least 5 other logs will be valid as multipliers.

One's own country is not valid as a multiplier.

The continents are valid as multipliers. For contacts with Europe or Africa (domestic or intercontinental) the sender and the receiver will each be assigned 100 points as multiplier.

50 points will be assigned for each of the remaining continents contacted.

An additional 100 points will be given for each contact with Australia-Oceania and/or Asia on 21 or 28 MHz.

9) SCORING

TOTAL POINTS x TOTAL NUMBER OF COUNTRIES x TOTAL CONTINENT POINTS + TOTAL AUSTRALIA-OCEANIA & ASIA STATION POINTS

Example: 600 exchange points x 10 countries worked x 100 continent points equals 600.000 plus 20 station of Australia Asia worked on 21-28 MHz giving a great total of 602.000 points.

ATTENTION: two promotional periods are included in the contest

Saturday 3 November 13.00-14.00 GMT

Sunday 4 November 16.00-17.00 GMT

OMs operating from North America, South America, Europe, Africa contact Australia - Oceania and/or Africa (during these hours) will **DOUBLE** their points for these periods.

BEGINNER PRIZE: RTTYers entering logs in the "AUSTRALIA-OCEANIA & ASIA RTTY FLASH CONTEST" who have not participated in previous contest will receive an additional bonus of 5% of their final score.

HANDICAP:

—10% of the total final score of the winner of previous RTTY Championships.

—8% of the total final score for the winner of one, or more, precedent RTTY contest.

10) SWLs

This contest is open also to RTTY SWLs. The same scoring rules for OMs are valid for SWLs.

The logs for SWLs must contain: date, time (GMT), call sign of the station heard, RST-number of QSO-continent of the station heard, country and continent multipliers, points and final score. The same station is valid **ONLY ONE TIME ON ALL BANDS.**

11) PRIZES: GRAND PRIZES, AS USUAL, ARE RESERVED FOR THE FOUR FIRST PLACE WINNERS. CONSOLATION PRIZES ALONG WITH MEDALS AND CERTIFICATES WILL ALSO BE AWARDED.

IMPROVED CRYSTAL CONTROL FOR DRAKE "C" LINE

by Melvin Leibowitz, W3KET
25 Holly Hill Rd
Wilmington, DE 19809

The Drake R4C and T4XC are well suited for RTTY work. The one area that could stand some improvement is the provision for crystal control. The T4XC has provision for one crystal controlled frequency. The receiver may be locked to the transmitter for crystal controlled reception as well as transmission. True transceive operation results.

This system is deficient in a number of ways:

(1) The netting (trimmer) capacitor is inside the transmitter cabinet and has to be set with a screwdriver. This capacitor is an ordinary mica compression trimmer. Adjustment to the precise tolerance required in autostart work is extremely difficult. This adjustment has to be made every time the crystal is changed. Since I monitor 20 meters during the day and 80 meters at night and Navy Mars in-between; this method of adjustment is very inconvenient.

(2) The trimmer capacitor seems to have a temperature coefficient that is worse than either the crystal or the vfo and it takes several hours after turn on before drift stops. One transmission will generate enough heat to start drift all over again.

(3) I do not use the T4XC for autostart work. I use a DX-60 instead. Some means had to be found to control the receiver independently of the transmitter.

Fortunately there are several easy solutions to the above problems and the reader can select those which best meet

his needs. In-as-much as all of the difficulties center around the netting capacitor; we might consider replacing the mica trimmer with a piston capacitor whose adjusting screw would be extended through the front panel and be equipped with a knob for easy adjustment. Unfortunately, the mechanical construction of the transmitter makes this extremely difficult and there is an easier way that does not require major surgery on the transmitter. Thus those owners that wish to use the transmitter and receiver together can make up a small box containing a crystal socket and a piston trimmer capacitor of about 12 pf. max. Connect the capacitor in parallel across the crystal socket and ground one side. Connect this through an inch or two of RG-174U co-ax cable to the crystal socket on the transmitter. Disconnect the hot side of the internal trimmer capacitor. The other side is grounded and need not be disconnected. This simple stratagem accomplishes three things:

(1) The thermal path to the transmitter has been broken with a consequent reduction in drift.

(2) We have made the adjusting capacitor accessible and easy to adjust.

(3) We have improved the electrical qualities of the capacitor.

There is a solution that is almost as simple and easy for those that do not want to use the transmitter at all. A separate, external oscillator will have to be used in this instance. Since the oscillators are cheap and easy to build you can make one for each frequency of interest and either plug in or switch between them. The oscillators are powered from the 12 volt accessory socket on the rear of the receiver. The output of the oscillator is

plugged into the phono jack marked "INJ" (injection) on the rear of the receiver in lieu of the cable from the transmitter that would normally go there.

The crystal frequencies are chosen in accordance with the instructions in the owner's manual. Crystal frequencies may be moved several Khz. by changing the values of C1-C2 & C3 although it is desirable to keep the ratio of C1 & C2 the same as shown in the diagram. The crystal (range) selector switch on the R4C should be turned to an unused position when using the crystal oscillator although you can listen to the crystal controlled frequency plus a VFO selected channel by leaving the range switch in the normal position. The noise level in the receiver drops when using the crystal oscillator indicating incorrect drive level; however, this does not seem to affect receiver performance. Stability on 80 meters is 3 or 4 hz for months on end. There is some quick warm-up drift of as much as 50-60 Hz on 20 meters. This disappears within 10-15 minutes and the oscillator always returns to the same frequency plus or minus 5 Hz.

Construction is via printed circuit card. The PC board may be drawn freehand or can be fabricated by the tape resist method. This board is an excellent beginners project if you have never made a PC board before and would like to try your hand at it. The drawing are not to scale and are approximately twice normal size. They are shown only as a guide for making your board to accommodate the parts that you have.



(NOTE)

From The Publisher Dee Crumpton

Well fellows, the RTTY JOURNAL will have a new editor starting next month. Mike Stone, W8OQCD, will take over the VHF NEWS column currently being managed by ailing Arny Gamson, K6PXA. Arny has done a magnificent job with the column and will be missed by all. Good health to you Arny.

Mike lives in Lowden, Iowa 52255 at 804 Jefferson Avenue. Please send him you info on VHF Clubs, repeaters, short cuts, hatchet jobs etc.

Mike comes to the JOURNAL well qualified: active on both HF and VHF RTTY, CW, ATV and phone. Founder and past president "midwest's" largest teletype club "Bi-State VHF Teleprinter Society." Published in QSL, 7e, A5 and RTTY JOURNAL published since 1953 (that is quite an accomplishment in itself). So fellows lets make Mike feel right at home and swamp him with input, especially all of you Easterners, Mike is right "in your backyard."

Thanks for all of the cards and letters while I was in Europe. I did have a ball there visiting with all of my relatives, my parents were born in Denmark, so there were quite a few to visit with. Met a few Hams and their names and calls are in the possession of someone that stole part of my luggage.

Hope you fellows can come to the aid of a quite exasperated lady (me). A few months back Jean Alliaume, F5JA sent Skip, WB6CYA, our awards editor, over 100 QSL cards to substantiate his ap-

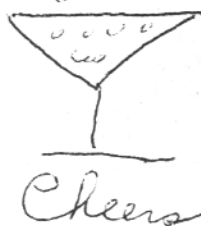

plication for the RTTY JOURNAL DXCC award. This was normal procedure. Skip turned the QSL's over to me to mail back along with his plaque. They were mailed in two separate packages and you guessed it the post office has no trace of F5JA's QSL cards. I neglect to have the packages insured registered. So now F5JA cannot send the QSL cards to ARRL for his award there. I have written to ARRL along with WB6CYA, Skip, and have been told that ARRL could "set no precedence" by accepting the word of two members of the RTTY JOURNAL staff as to the amount and kind of QSL cards sent to us by F5JA. So fellows please help me out by sending QSL cards to F5JA and helping him gain what is rightfully his award. Jean Alliaume, LaMerinerie, Buxeuil, 37160 Descartes, France. Thanks.

Hope to see all of you at the Convention in October at Anaheim.

73's Dee.

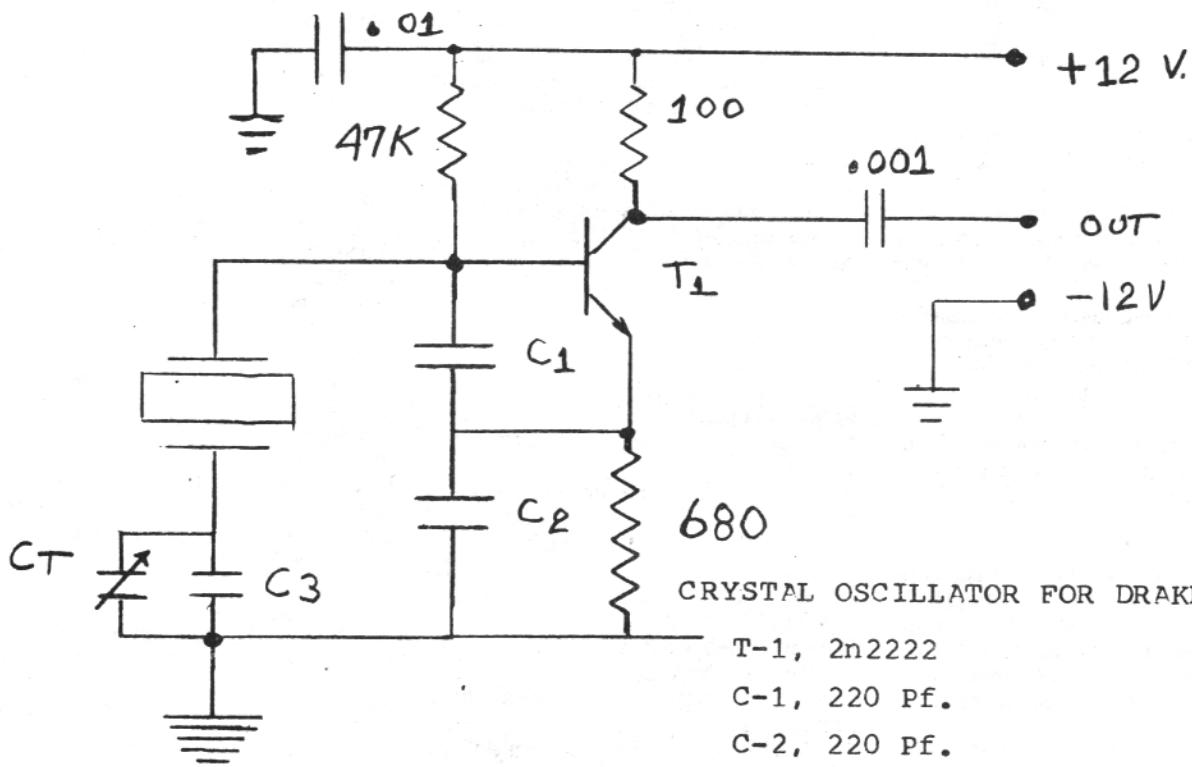

CRYSTAL OSCILLATOR FOR DRAKE R4C

- T-1, 2n2222
- C-1, 220 Pf.
- C-2, 220 Pf.
- c-3, 30 Pf.
- C-t, 3-12 Pf. piston trimmer

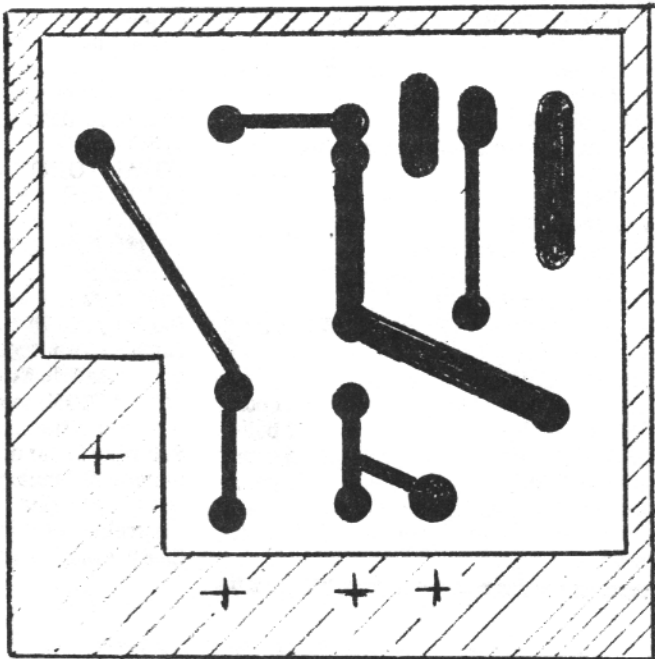
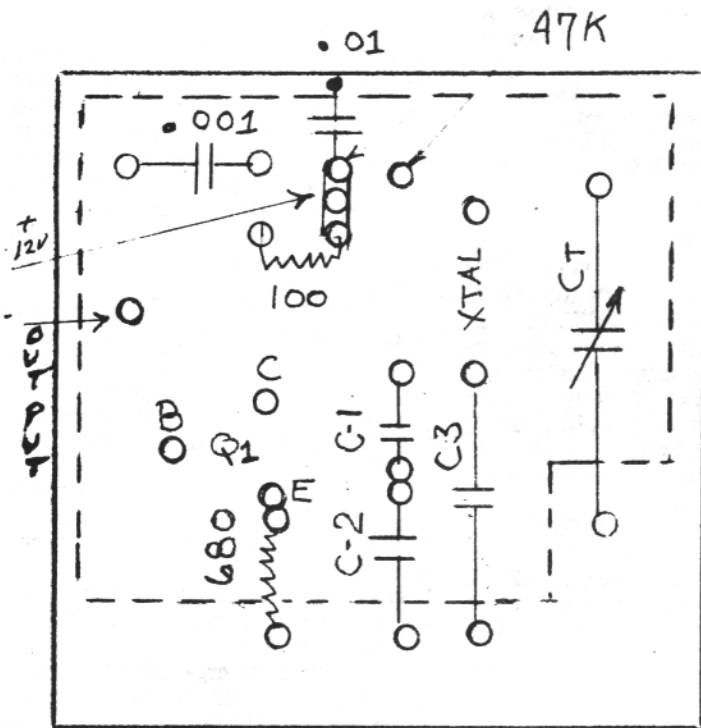

PARTS PLACEMENT GUIDE
 XTAL OSCILLATOR for DRAKE R4C
 NOT TO SCALE- APPROX. 2X
 All resistors mount vertically

FOIL SIDE
 NOT TO SCALE- APPROX 2X

**NORTH & SOUTH AMERICA
RTTY FLASH CONTEST**

Sponsored by I.A.T.G.-

Radiocommunication

IATG - Radiocommunications is announcing its first annual NORTH & SOUTH AMERICA RTTY FLASH CONTEST.

Even though the radioteletype began in the Americas there have been few contests for RTTY operators. We would like to fill this gap.

The points and multipliers will be awarded in a manner to encourage long range contacts, which are an indication of the operators ability and the efficiency of his equipment.

We have to organize the contest in this direction but remain open for suggestions or constructive criticism which will be considered for the rules for future contests.

We are especially interested in suggestion as to what regulation we might incorporate in future contest to encourage the use of home-made microprocessors and/or programming on commercial available equipment in radioteletypes.

1) CONTEST DATES

1st 18.00-02.00 GMT 19 January 1980

2nd 12.00-24.00 GMT 20 January 1980

2) BANDS

3,5 - 7 - 14 - 21 - 28 MHz amateur bands.

3) COUNTRY STATUS

The DXCC list will be used except that the VE/VO, W/K, VK, PY, LU, JA, VA0/9 call areas will be considered as separate countries.

4) CLASSES

1) Single or multioperator, single transmitter.

b) SWL's

5) MESSAGES

Messages will consist of:

a) RST

b) number of the QSO

c) one's continent (Example: W4XXX 599 58 N. America)

6) EXCHANGE POINTS

QSO on 3, 5 and 7 MHz 1 point

QSO on 14 MHz 2 points

QSO on 21 MHz 8 points

QSO on 28 MHz 12 points

No points or multipliers for contact with one's own country. Only 2 x RTTY are valid.

7) LOGS AND SCORE SHEETS

Use one log for each band.

Logs must contain:

date, time (GMT), call sign, RST-number of the QSO-continent sent and received, country and continent multipliers, points and final score.

Each station may be contacted only once on any band, additional contacts may be made with same station if a different band is used. In order to qualify, all logs must be received not later:

20 February 1980.

Send them to:

Prof Franco Fanti

Via A. Dallolio n 19

BOLOGNA 40139 (Italy)

8) MULTIPLIERS

Multipliers are given for countries and continents.

A multiplier is given for each country worked on band 14-21-28 MHz. **NO MULTIPLIERS FOR 3, 5 - 7 MHz.**

A separate multiplier may be claimed for the same country if a different band is used (max. 3 times).

Only countries which appears in at least 5 other logs will be valid as multipliers.

One's own country is not valid as a multiplier.

The continents are valid as multipliers.

For contacts with North & South America (domestic or intercontinental) for sender and receiver will each be assigned 100 points as multiplier.

50 points will be assigned for each of the remaining continents contacted.

An additional 100 points will be given for each contact with North & South America on 21 or 28 MHz.

9) SCORING

TOTAL POINTS x TOTAL NUMBER OF COUNTRIES x TOTAL CONTINENTS POINTS + TOTAL POINTS NORTH & SOUTH AMERICA STATION WORKED.

Example: 600 points for total x 10 countries worked x 100 continents points equals 600.000 plus 20 station of North & South America worked on 21-28 MHz giving a great total of 602000 points.

ATTENTION: two promotional period are included in the contest:

Saturday 19 January 19.00-20.00 GMT

Sunday 20 January 21.00-22.00 GMT

OMs operating from Europe, Africa, Australia-Oceania, Asia contact North & South America (during these hours) will

DOUBLE their points for these period.

BEGINNER PRIZE: RTTYers entering logs in the "NORTH & SOUTH AMERICA RTTY FLASH CONTEST" who have not participated in previous contest will receive an additional of 5% of the final score.

HANDICAP:

—10% of the total final score of the winner of previous RTTY Championship.

—8% of the total final score for the winner of one, or more precedent RTTY contest.

10) SWLS

This contest is open also to RTTY SWLS. The same scoring rules for OMs are valid for SWLS.

A separate results table will be made for these entries.

The logs for SWLS must contain: date, time (GMT), call sign of the station heard, RST-number of QSO-continent of the station heard country and continents multipliers, points and final score.

The same station is valid **ONLY ONE TIME ON ALL BANDS.**

11) PRIZES

GRAND PRIZES, AS USUAL, ARE RESERVED FOR THE FOUR FIRST PLACE WINNERS. CONSOLATION PRIZES ALONG WITH MEDALS AND CERTIFICATES WILL ALSO BE AWARDED.

12) RULES OF BEHAVIOUR AND PENALIZATION

Logs must be compiled in accordance with the above mentioned rules. The contacts must be made by means of RTTY mode **ONLY**. That is other modes of transmission not are permitted before, during or after the exchange of the radio teletype message. During the contest it is expected that amateurs will observe the fundamental rules of courtesy and good operation.

The contest disqualification criteria used by the ARRL in its contest apply also to this contest.

Failure to observe any of the above rules will result in the exclusion of the entry for the final result and any such log will be considered as a check-log.

Logs with compiling errors which exceed 10% of final score will also be excluded from the final standing and will serve only as check-log.

Logs received become the property of the IATG-Radiocommunications and will not returned.

The decision of the organizing Committee in any dispute will be final and any subsequent controversy may not be referred to the Civil Court.

REMEMBER: the contest is valid towards the final standing of the 5 CONTINENT WORLD CHAMPIONSHIP.

Hospitality Room

The RTTY Journal will have a Hospitality Room (1214) at the Southwestern Division Convention. All are welcome, so stop by and share a Kentucky Kool Aid with fellow green keyers.

Ham Helps

Darell Heiselman DO 620 Treiside — #3c Akron, Ohio 4433

Darell writes that he has aquired a new model 28ASR which has auto carriage return and line feed which is set for 72 Characters. Darell likes copying pictures but some are over 72 characters wide and would like someone to assist him in setting his line length.

Paul Jackson, 1013 Lynwood, Rolla Mo 65401

Recently aquired a Honeywell teletype system with a papertape punch, papertape reader, and OCR card reader. He has been unable to locate any technical info on this system. Paul intends to interace this with his TRS80 computer. Any help would be greatly appreciated.

DOVETRON

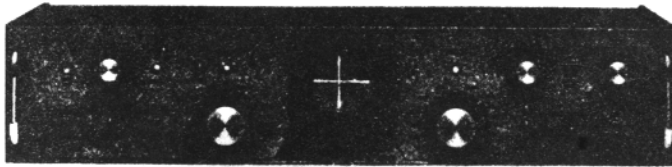

MPC-1000C

Multipath Correction
In-Band Diversity &
AFSK Tone Keyer

Amateur Net: \$545.00

Standard features include CONTINUOUSLY tuneable Mark and Space channels (1000 Hz to 3200 Hz), Dual Mode (MARK or FSK) Autostart and internal high level neutral loop keyer (20 to 60 ml). Both EIA and MIL FSK outputs are provided for direct interface to microprocessor and video terminal peripherals.

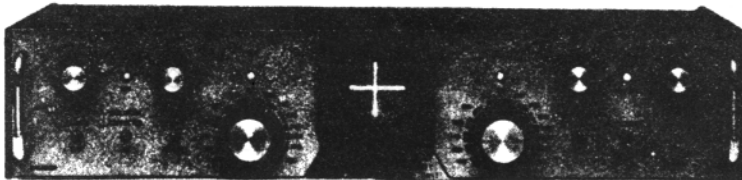

MPC-1000CR

Signal Regeneration &
Speed Conversion

Amateur Net: \$645.00

A front panel switch permits internal TSR-200 Signal Regenerator-Speed converter assembly to electronically "gear-shift" between 60, 67, 75 and 100 WPM. All incoming and outgoing signals are regenerated to less than 0.5% bias distortion. Also available with DIGITAL Autostart (TSR-200D): Amateur Net: \$695.00

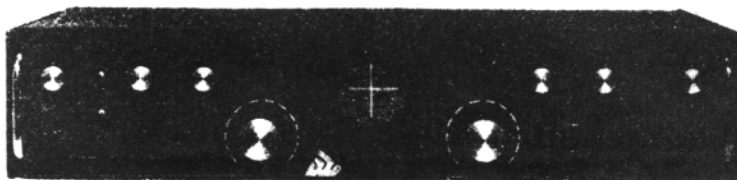

MPC-1000R/- TSR-500

Dual UART Regeneration,
Speed Conversion, 200
Char. Memory, Word Cor-
rection & DIGITAL
Autostart

Amateur Net: \$895.00*

The MPC-1000R/TSR-500 provides Preloading and Recirculation of the 200 character FIFO Memory, a keyboard-controlled Word Correction circuit, Variable Character Rate, Tee Dee Inhibit, Blank/LTRS Diddle, a Triple Tone-Pair AFSK Tone Keyer and a Character Recognition/Speed Determination DIGITAL (DAS-100) Autostart mode.

*The MPC-1000R is also available without a TSR assembly and functions as a MPC-1000C with a Triple Tone-Pair AFSK Tone Keyer. This "Basic-R" permits future expansion with a TSR-100, TSR-200, TSR-200D or TSR-500 by simply lifting the lid and plugging in the appropriate TSR assembly: Amateur Net (Basic-R): \$595.00

Your QSL will bring complete specifications, or call: 213-682-3705.



627 FREMONT AVENUE
(P. O. BOX 267)
SOUTH PASADENA, CA. 91030

MPC-1000R BY DOVETRON

MULTIPATH CORRECTION, IN-BAND DIVERSITY, SIGNAL REGENERATION,
UP-DOWN SPEED CONVERSION, 200 CHARACTER FIFO MEMORY,
KEYBOARD-CONTROLLED WORD CORRECTION & DIGITAL AUTOSTART

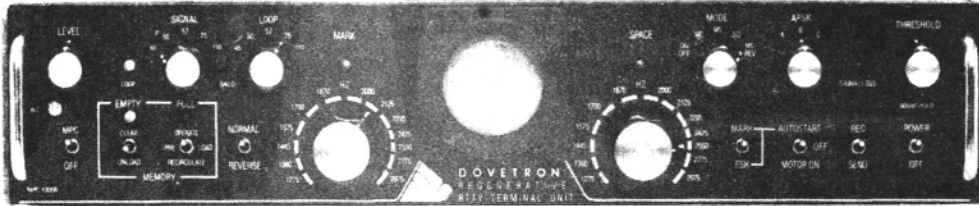

THE MPC-1000R REGENERATIVE RTTY TERMINAL UNIT

The DOVETRON MPC-1000R is a complete Transmit-Receive modem designed for optimum radio teleprinter communications on land, sea and in the air.

Standard features include a high level loop supply and keyer (neutral or polar), EIA and MIL FSK outputs, a phase-continuous AFSK Tone Keyer with three selectable Mark - Space - Shift tone pairs, Mark, FSK & Digital Autostart, Automatic Markhold, an internal RY Generator for terminal unit Self-Test and circuit adjustment, and a Signal Loss Alarm circuit.

The MPC Series is available in six different models to meet your exact requirements.

**Complete specifications are
available on your request,
or call 213-682-3705.**



**627 Fremont Avenue
South Pasadena,
California 91030, U.S.A.**

RTTY Journal

PO BOX RY

Cardiff by the Sea, CA. 92007

SECOND CLASS PERMIT PAID
AT ENCINITAS, CA 92024