





NO.	NOTES
1.	ALL RESISTORS 1/2 WATT. RESISTANCE VALUES IN OHMS. CAPACITANCE VALUES IN MICROFARDS UNLESS OTHERWISE SPECIFIED.
2.	 INDICATES FEMALE TERMINAL  INDICATES MALE TERMINAL
3.	 INDICATES CIRCUIT COMMON
4.	TERMINAL DESIGNATIONS ENCLOSED IN PARENTHESIS ARE FOR REFERENCE AND ARE NOT MARKED ON COMPONENT.
5.	SL-BL INDICATES SLOW-BLOWING.
6.	REFER TO 8316WD FOR ACTUAL WIRING DIAGRAM.
7.	REFERENCE SPEC. FOR TELETYPE CORPORATION EMPLOYEES ONLY: 61.267S
8.	 INDICATES SINGLE SHIELDING  INDICATES DOUBLE SHIELDING
9.	T1 SECONDARY 50V AC TO CENTER TAP WITH 115V AC INPUT. 8 OHMS (MAX.) PRIMARY RESISTANCE 10 OHMS (MAX.) SECONDARY RESISTANCE TO CENTER TAP.
10.	REFER TO RELATED SET DIAGRAMS FOR EXTERNAL CIRCUITS.
11.	ALL VOLTAGES GIVEN WITH RESPECT TO CIRCUIT COMMON.
12.	+6 VOLT INPUT CLUTCH MAGNETS ENERGIZED -6 VOLT INPUT (OR OPEN LINE) CLUTCH MAGNETS DE-ENERGIZED.

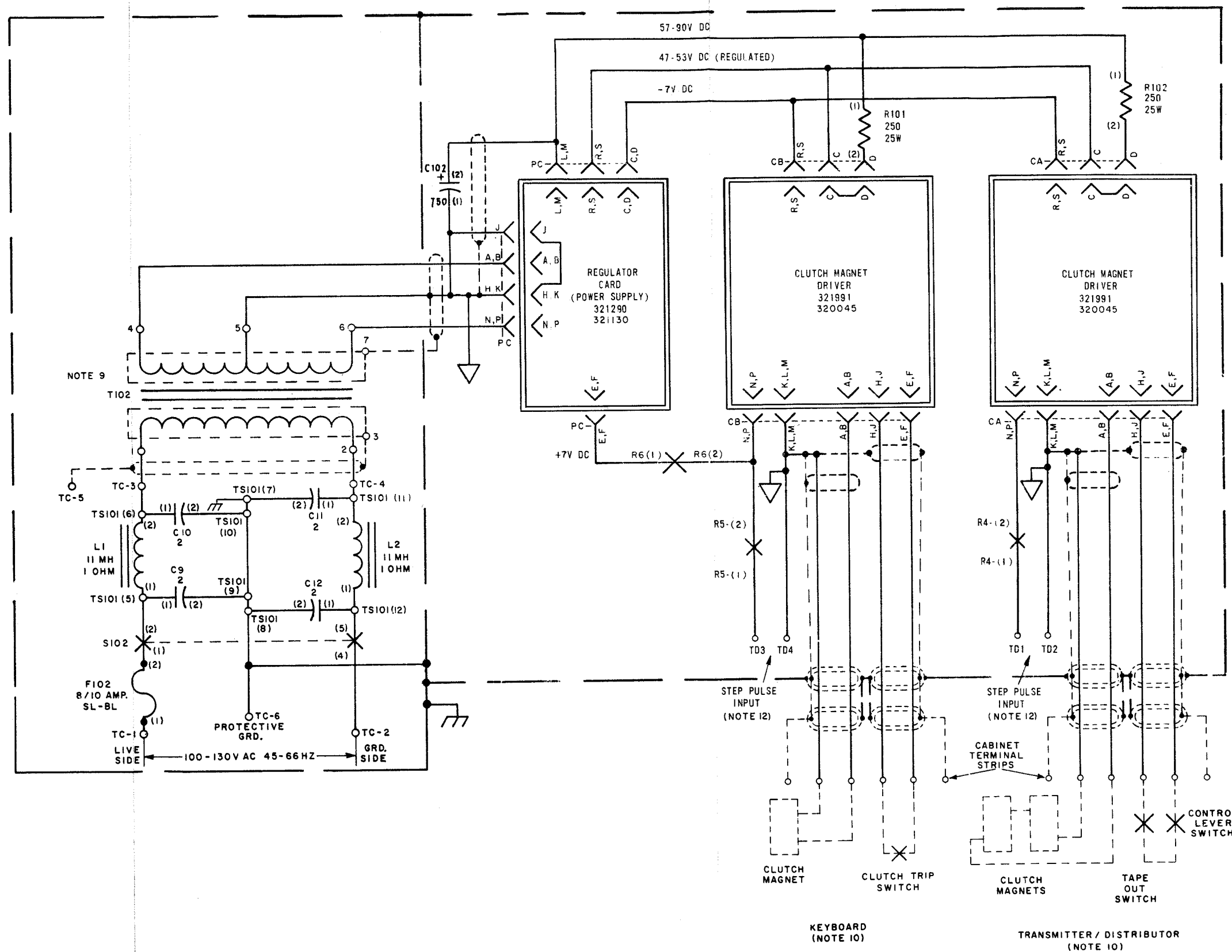
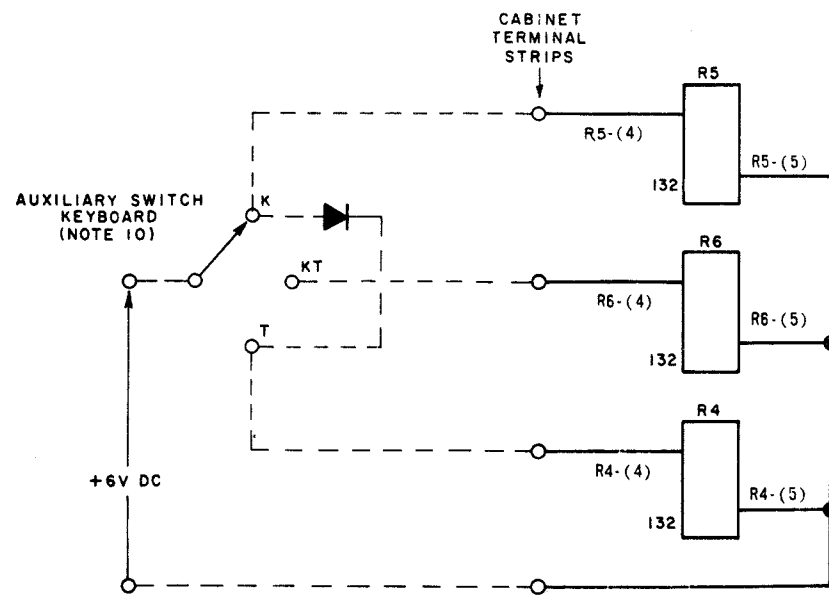

Figure 5-43. 323812 Electrical Service Assembly (Clutch) Schematic Wiring Diagram