

6020WD-AI

SHEET INDEX

CONTENTS	SHEET NO.	ISSUE NO.																																																		SHEET NO.
		1	2	3	4	5	6	7	8	9	10	11	12	13	14	15	16	17	18	19	20	21	22	23	24	25	26	27	28	29	30	31	32	33	34	35	36	37	38	39	40	41	42	43	44	45	46	47	48	49	50	
SHEET INDEX	A1	1	1	3	4																																															A1
FS-1 CALL PROGRESS	B1	1	1	1	/																																													B1		
FS-2 TEST																																																				
FS-3 BREAK RELEASE																																																				
FS-4 RESTRAIN																																																				
FS-5 CLEAR																																																				
FS-6 ANSWER																																																				
FS-7 ORIGINATE																																																				
FS-8 ROTARY DIAL AND PULSING CARD DIALER	B2	1	2	2	2																																												B2			
FS-9 AMPLIFIER																																																				
FS-10 TOUCH TONE DIALER	B3	1	1	1	/																																												B3			
FS-11 SIGNAL GENERATORS AND SELECTOR MAGNET DRIVERS	B4	1	1	3	3																																												B4			
FS-12 ANSWER BACK CONTROL	B5	1	1	1	/																																												B5			
FS-13 FORM OUT MAGNET	B6	1	1	1	/																																												B6			
FS-14 PAPER OUT DISCONNECT																																																				
FS-15 EOT DISCONNECT																																																				
FS-16 LOCAL	B7	1	2	2	2																																												B7			
FS-17 MOTOR CONTROL RELAY																																																				
FS-18 OUT OF SERVICE INDICATOR	B8	1	1	1	/																																												B8			
FS-19 RINGER CIRCUIT AND OFF HOOK CIRCUIT																																																				
FS-20 PAPER ALARMS	B9	1	1	1	/																																												B9			
FS-21 ROTR CONTROL	B10	1	2	2	2																																												B10			
FS-22 POWER AND CABINET	B11	1	2	3	4																																												B11			
APP. FIG. 1 (PART OF)	C1	1	1	1	/																																												C1			
APP. FIG. 1 (PART OF)	C2	1	1	3	3																																												C2			
APP. FIG. 1 (PART OF)	C3	1	1	1	/																																												C3			
APP. FIG. 2	C4	1	1	1	/																																												C4			
APP. FIG. 3	C5	1	1	1	/																																												C5			
APP. FIG. 4	C6	1	1	1	/																																												C6			
APP. FIG. 5	C7	1	1	3	3																																												C7			
APP. FIG. 6																																																				
APP. FIG. 7																																																				
APP. FIG. 8																																																				
APP. FIG. 9																																																				
APP. FIG. 10																																																				
CIRCUIT NOTES 101-104	D1	1	1	1	/																																												D1			

SUPPORTING INFORMATION

CATEGORY		NO.
LESU 300 LK 802 LP 805 LP 806 LCCU 300		5821 WD 5812 WD 4787 WD 4786 WD 5824 WD
	DATA SET	101 C BSP 591-013-100 BSP 591-013-200 BSP 591-013-300
		105A BSP 591-018-100 BSP 591-018-200 BSP 591-018-300
		88 BSP C18.005.00 BSP C18.005.01
	DIALER	25 F1 BSP C18.006
26 C		
41 A BSP C18.009		
DATA SYSTEMS ATTENDANT CIRCUIT	8D-20009-01	

ISSUE	DATE	AUTH. NO.
2	12-13-62	75884
3	3-5-63	75882

SHEET INDEX NOTES

- WHEN CHANGES ARE MADE IN THIS DRAWING, ONLY THOSE SHEETS AFFECTED WILL BE REISSUED.
- THIS SHEET INDEX WILL BE REISSUED AND BROUGHT UP TO DATE EACH TIME ANY SHEET OF THE DRAWING IS REISSUED, OR A NEW SHEET IS ADDED.
- THE ISSUE NUMBER ASSIGNED TO A CHANGED OR NEW SHEET WILL BE THE SAME ISSUE NUMBER AS THAT THE SHEET INDEX.
- SHEETS THAT ARE NOT CHANGED WILL RETAIN THEIR EXISTING ISSUE NUMBER.
- THE LAST ISSUE NUMBER OF THE SHEET INDEX IS RECOGNIZED AS THE LATEST ISSUE NUMBER OF THE DRAWING AS A WHOLE.

SHEET INDEX FOR
35A, 35B, 35C, 35D
TELETYPEWRITER
SET (KSR)

APPROVALS
D AND R E OF M

E-NUMBER
PROD. NO. 6020WD-AI

DATE 10-4-62

P.D. FILE NO. G-A151AA

DRAWN GCK CHKD J. G. H. APPD.

TELETYPE CORPORATION

6020WD-AI

ISSUE	DATE	AUTH. NO.
2	12-13-62	75364

FS
CALL PROGRESS LAMPS

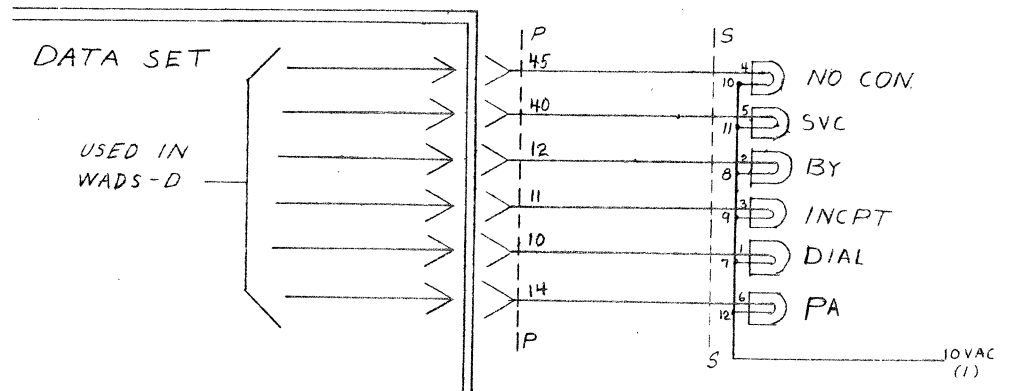

FS-2
TEST

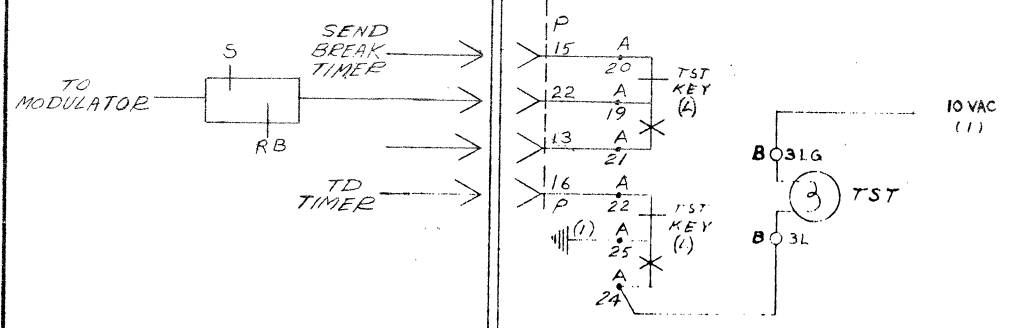

FS-3
BREAK RELEASE

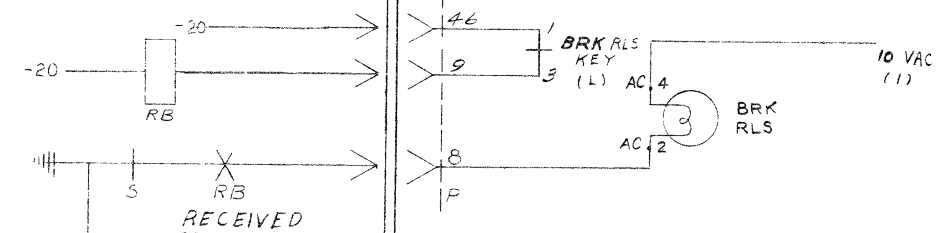

FS-4
RESTRAIN

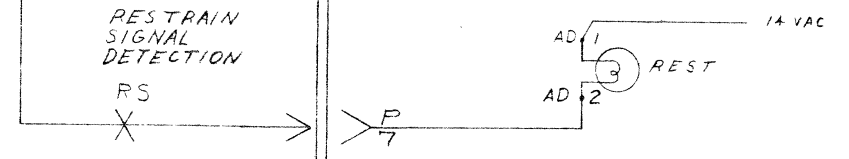

FS-5
CLEAR

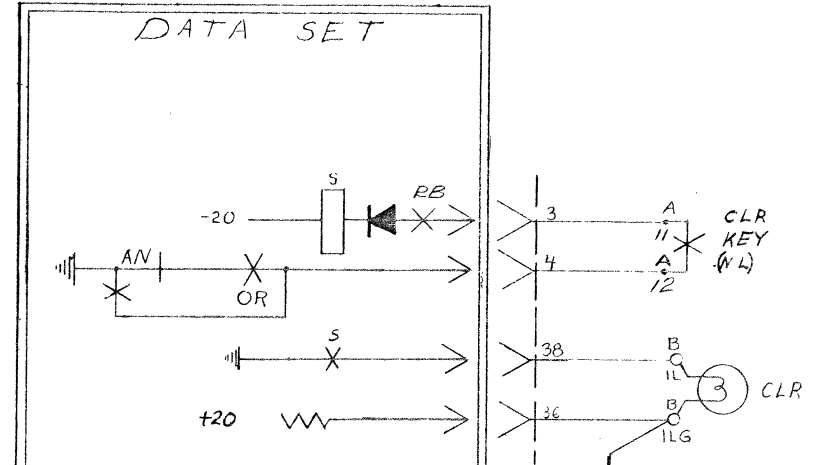

FS-6
ANSWER

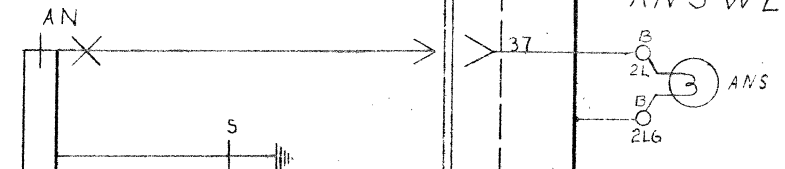

FS-7
ORIGINATE

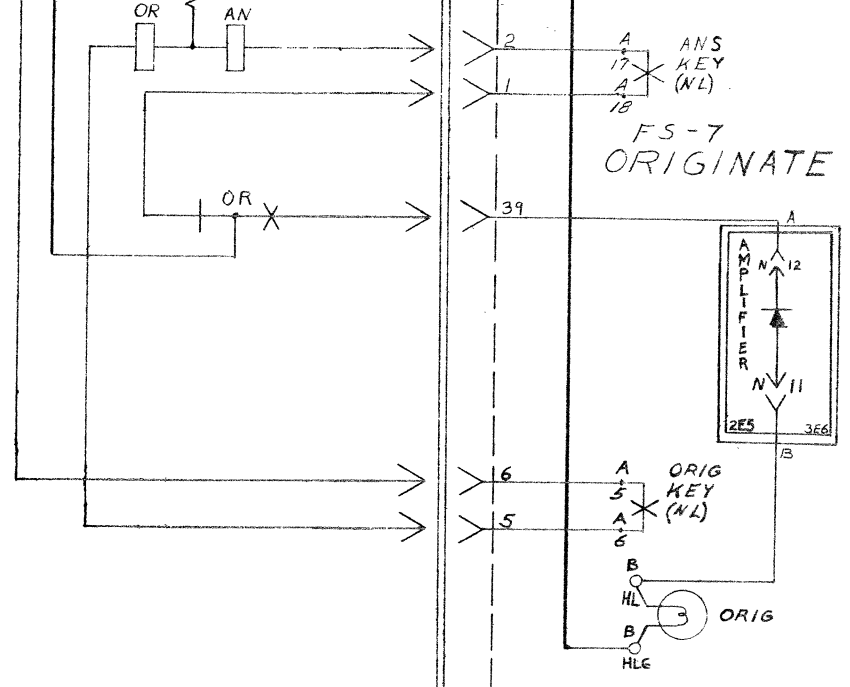

DETACHED SCHEMATIC
WIRING DIAGRAM FOR
35A, 35B, 35C & 35D
TELETYPEWRITER SET
(KSR)
SHEET B1

APPROVALS	
D AND R	E OF M
<i>[Signature]</i>	<i>[Signature]</i>
E-NUMBER	
PROD. NO. WD 6020-B1	
DATE: 8-20-62	
P.D. FILE NO. 5-A151AA	
DRAWN HAK	CHKD. <i>[Signature]</i>
ENGD RDS.	APPD. <i>[Signature]</i>

TELETYPE
CORPORATION

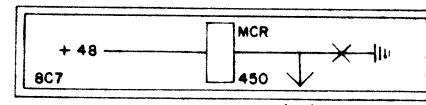

FS-21 ROTR CONTROL CIRCUITS

CORRESPONDING ACTUAL WIRING DIAGRAMS:
 7170WD (LESU306)
 5846WD (LRB300)
 4957WD (LPR801, LPR804)

ROTR SELECTOR MAGNET DRIVER CARD 182630

6020WD-B10

REVISIONS		
ISSUE	DATE	AUTH. NO.
2	4-24-64	7944

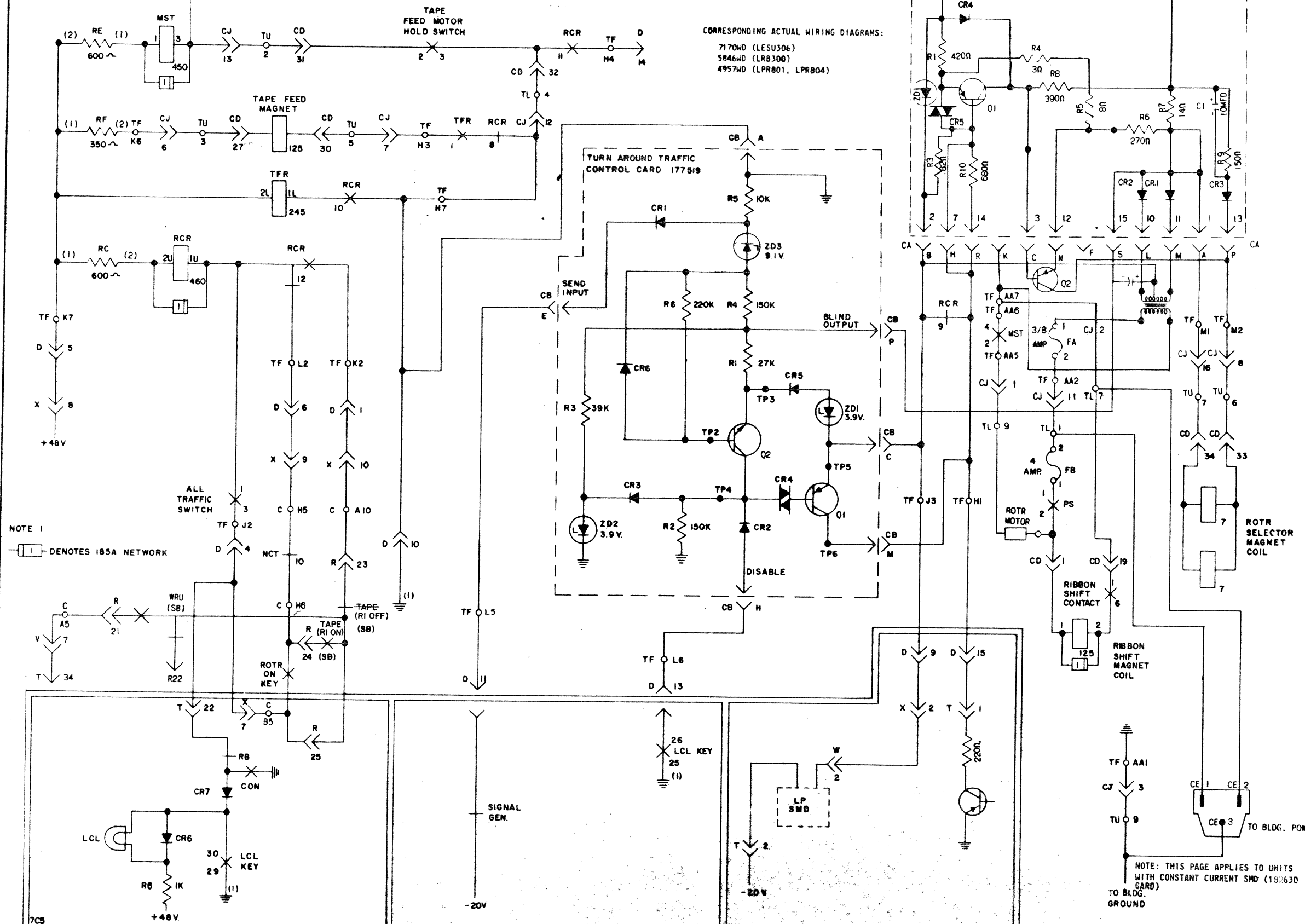

NOTE 1
 DENOTES 185A NETWORK

DETACHED SCHEMATIC WIRING DIAGRAM FOR 35A, 35B, 35C, 35D. TELETYPEWRITER SETS (KSR)

APPROVALS	
D AND R	E OF M
E-NUMBER	
PROD. NO. 6020WD-B10	
DATE 2/14/64	
P.D. FILE NO. G-A151AA	
DRAWN R.E.L.	CHKD. <i>[Signature]</i>
ENGD. G.E.W.	APPD. <i>[Signature]</i>

TELETYPE CORPORATION

6020WD-B10

NOTE: THIS PAGE APPLIES TO UNITS WITH CONSTANT CURRENT SMD (182630 CARD)
 TO BLDG. GROUND

FS-22
POWER AND CABINET CIRCUITS

6020-B11WD

ISSUE	DATE	AUTH. NO.
2	11-12-62	75072
3	12-13-62	75364
4	3-5-63	75882
5	3-10-64	81103
6	4-24-64	81824

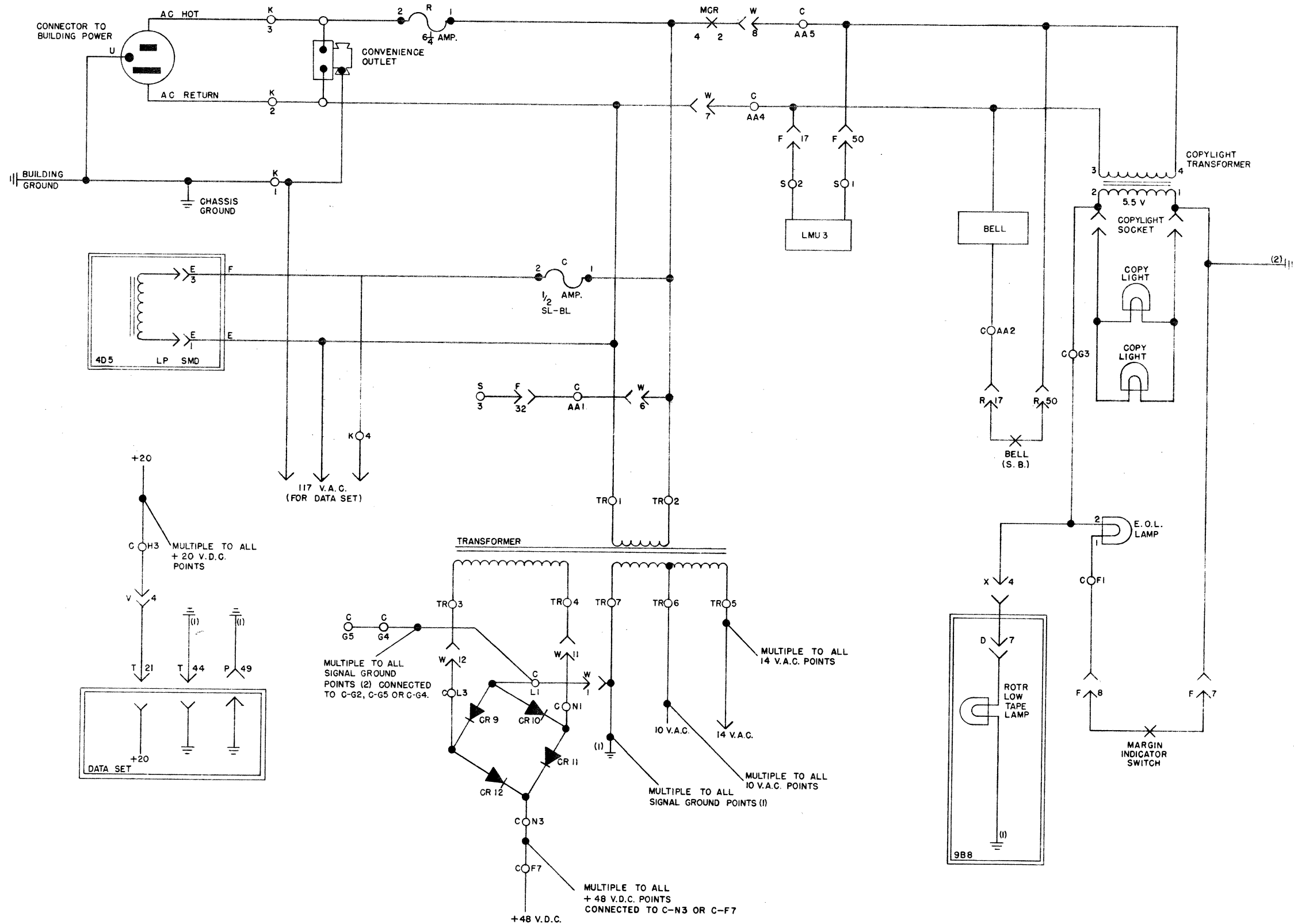

DETACHED SCHEMATIC WIRING DIAGRAM FOR 35A, 35B, 35C & 35D TELETYPEWRITER SET (KSR)

SHEET B11

APPROVALS

D AND R	E OF M
---------	--------

E-NUMBER

PROD. NO. WD 6020-B11

DATE 8-20-62

P.D. FILE NO. G-A151AA

DRAWN A.D. CHKD. J.G.M.

ENGD. R.D.S. APPD. R.F.G.

TELETYPE CORPORATION

6020-B11WD

6020-B2WD

ISSUE	DATE	AUTH. NO.
2	11-12-62	75072
3	12-13-62	75364

(T, 11) FS-8
 ROTARY DIAL & PULSING CARD DIALER

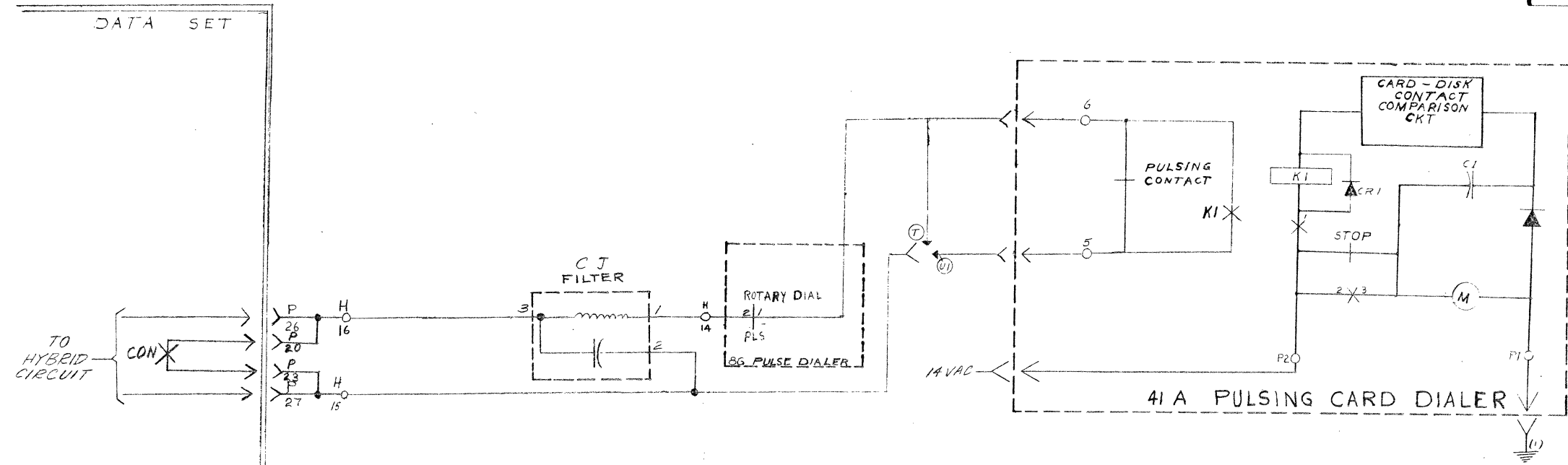

(T, U1) FS-9
 AMPLIFIER

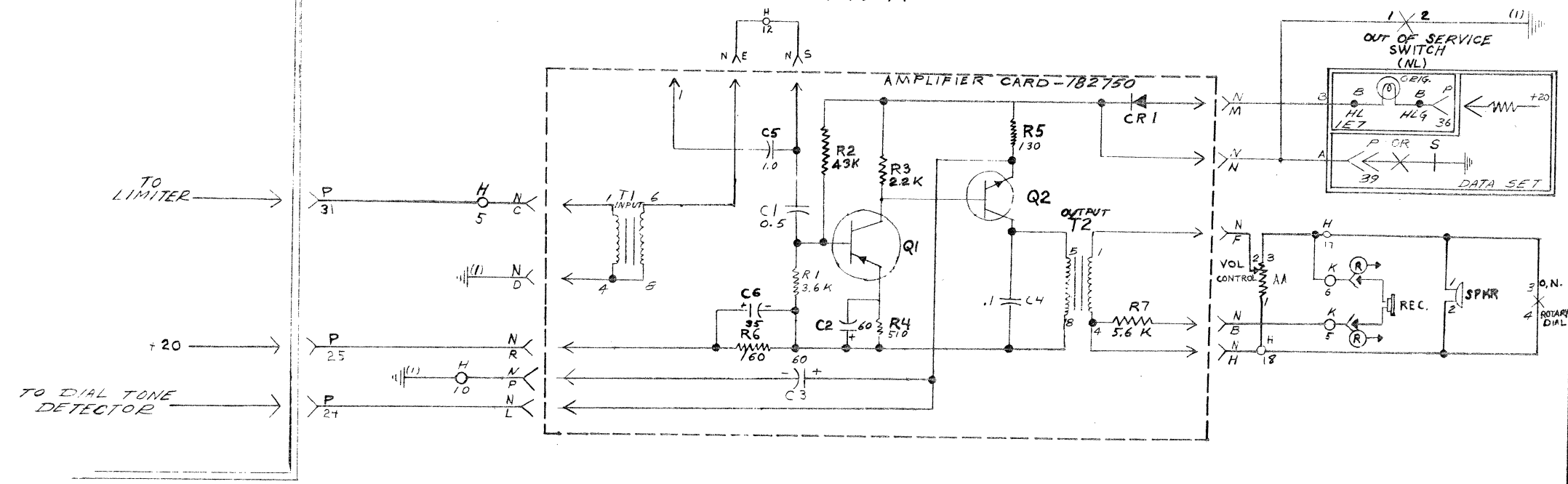

DETACHED SCHEMATIC
 WIRING DIAGRAM FOR
 35A, 35B, 35C & 35D
 TELETYPEWRITER SET
 (KSE)
 SHEET BR.

APPROVALS

DESIGNED BY	REVIEWED BY
DATE: 8-20-62	
P.D. FILE NO. 6-A151A.A	
DRAWN HAK	CHKD. [Signature]
ENGR. R.D.S.	APPD. [Signature]

TELETYPE
 CORPORATION
 6020-B2WD

M,X,Y FS-10
TOUCH TONE DIALER &
AMPLIFIER CIRCUIT

6020-B3 WD

ISSUE	DATE	AUTH. NO.
2	12-13-62	75364
3	12-9-63	79390

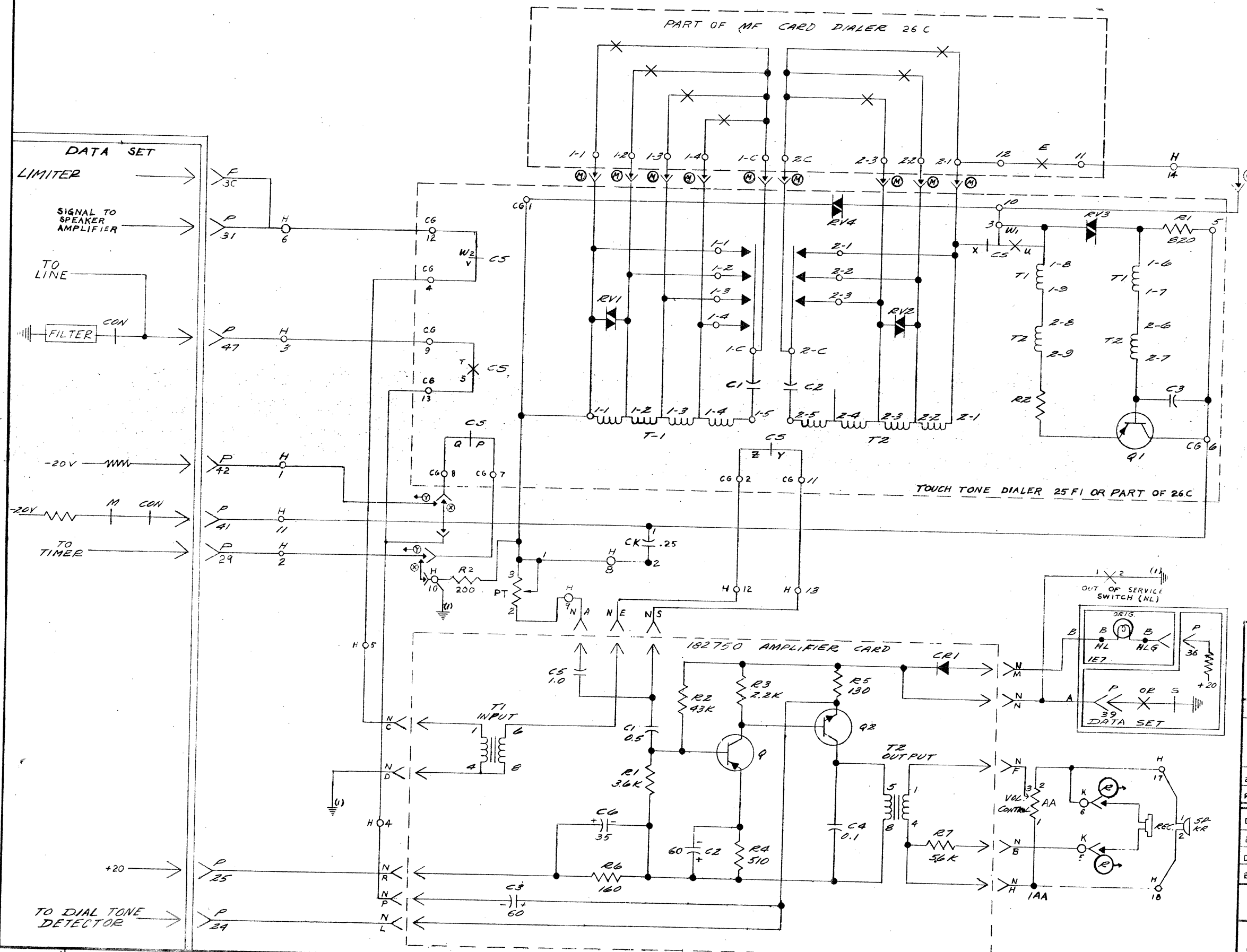

DETACHED SCHEMATIC
WIRING DIAGRAM FOR
35A, 35B, 35C & 35D
TELETYPEWRITER SET
(MSR)

SHEET B3

APPROVALS

D AND R E OF M

E-NUMBER

PROD NO WD6020-B3

DATE: 8-20-62

P.D. FILE NO. G-A151AA

DRAWN L.A. CHKD J.B.

ENGD R.D.S. APPD. J.B.

TELETYPE CORPORATION

6020-B3 WD

FS-11
SIGNAL GENERATORS AND SELECTOR MAGNET DRIVERS

6020-B4 WD

ISSUE	DATE	AUTH NO.
2	12-13-62	75364
3	4-3-64	81121

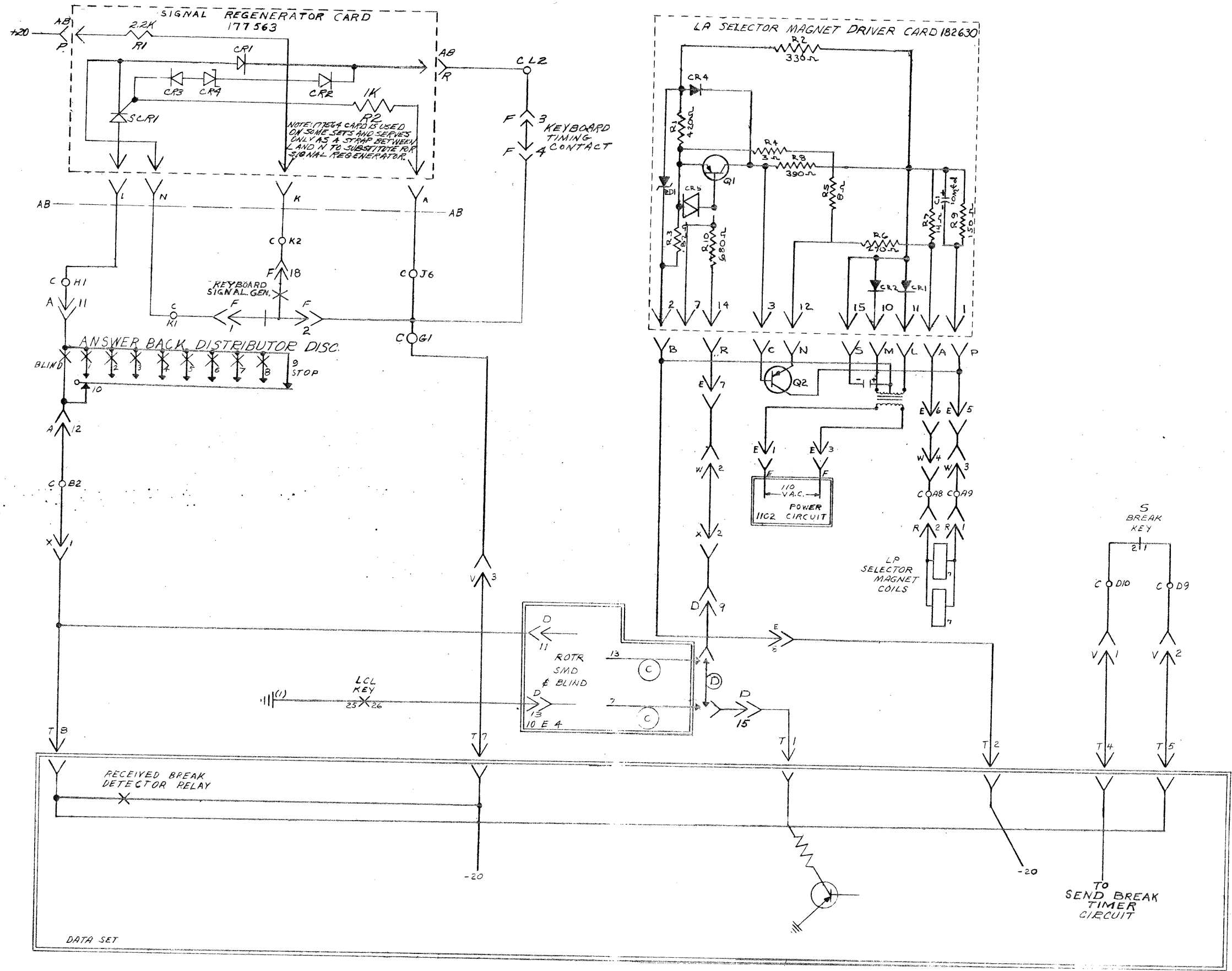

DETACHED SCHEMATIC
WIRING DIAGRAM FOR
35A, 35B, 35C & 35D
TELETYPE WRITER SET
(KSR)
SHEET B4

APPROVALS

C AND R	E OF M
<i>[Signature]</i>	<i>[Signature]</i>

E-NUMBER

PAOD NO WD 6020-B4

DATE: 8-20-62

P.D FILE NO. 6-A151AA

DRAWN H.D. CHKD *[Signature]*

ENGD R.D.S. APPD *[Signature]*

TELETYPE
CORPORATION
6020-B4 WD

FS-12
ANSWER BACK CONTROL CIRCUIT

6020-B5 WD

ISSUE	DATE	AUTH. NO.
2	12-13-62	75364

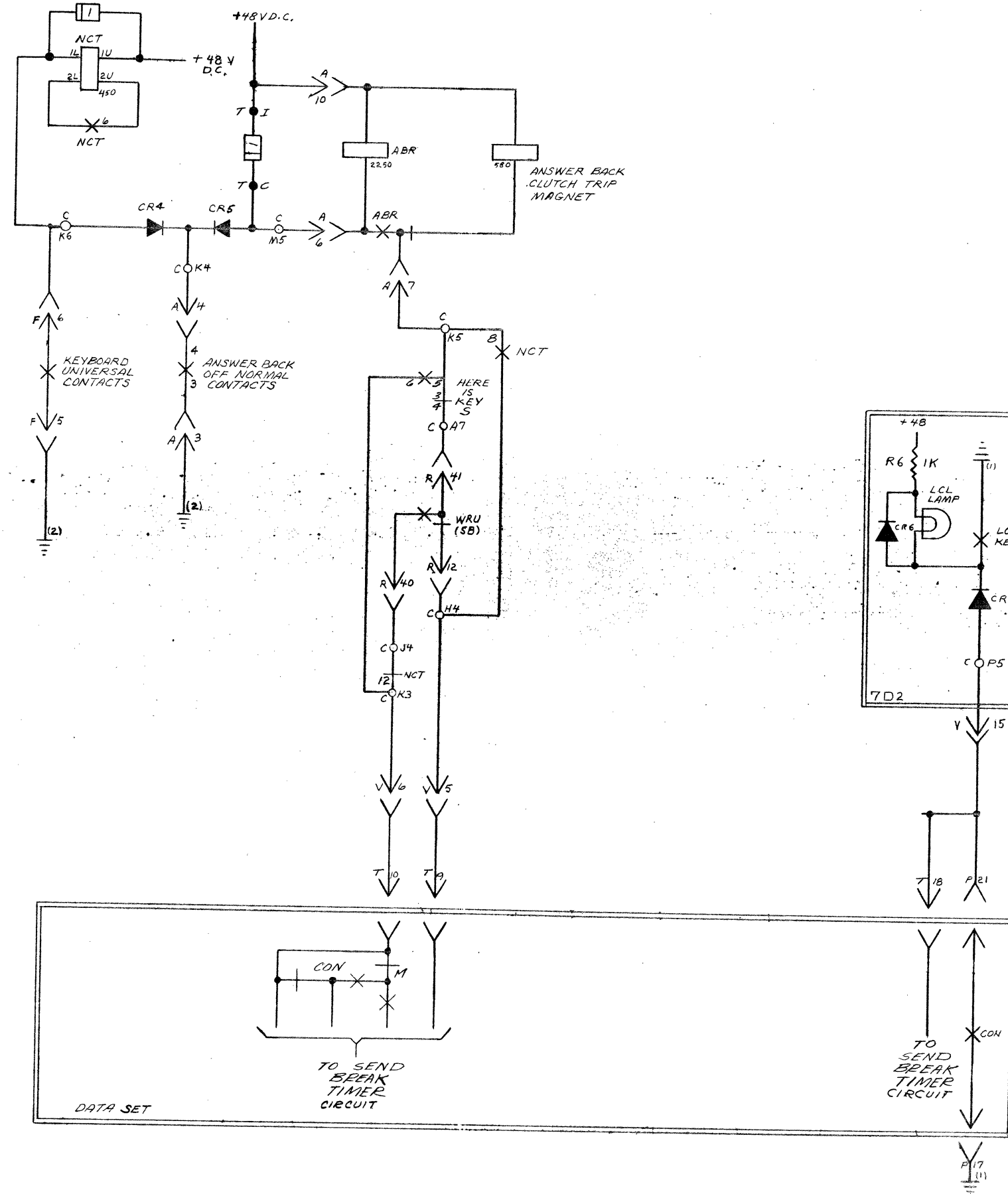

SHEET NOTES:
1. DENOTES 185 NET

DETACHED SCHEMATIC WIRING DIAGRAM FOR 35A, 35B, 35C & 35D TELETYPEWRITER SET (KSR)

SHEET B5

APPROVALS

D AND R	E OF M

E-NUMBER

PROD. NO. WD 6020-B5

DATE: 8-20-62

P.D. FILE NO. G-A151AA

DRAWN A.D. CHKD.

ENGD. R.D.S. APPD.

TELETYPE CORPORATION

6020-B5 WD

FS-13
 (L) FORM OUT MAGNET COIL

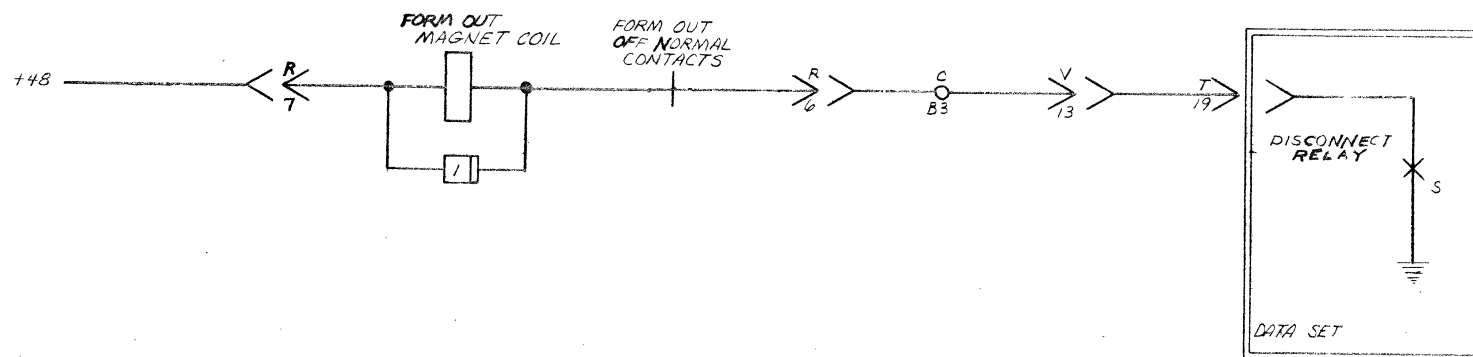

FS-14
 PAPER OUT DISCONNECT

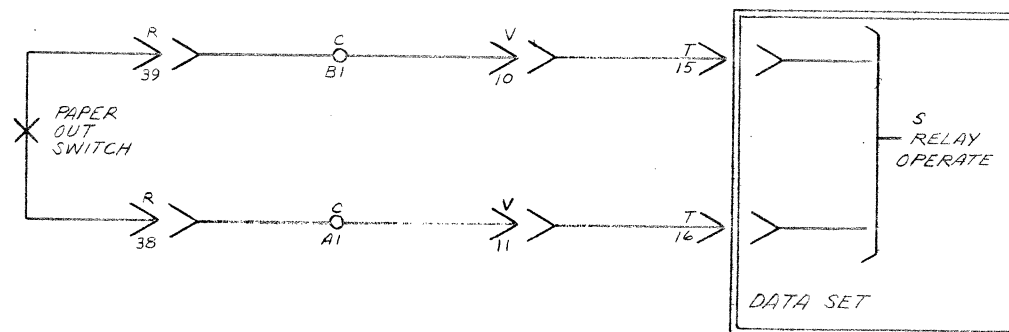

FS-15
 EOT DISCONNECT

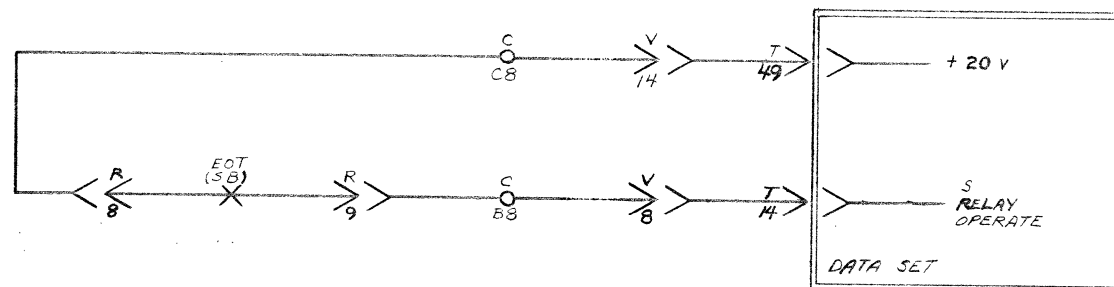

SHEET NOTES:
 1. [] DENOTES 185A NET

6020-B6 WD

ISSUE	DATE	AUTH NO
2	12-13-62	75364

DETACHED SCHEMATIC WIRING DIAGRAM FOR 35A, 35B, 35C & 35D TELETYPEWRITER SET (KSR)

SHEET B6

APPROVALS

D AND R	E OF M
<i>[Signature]</i>	<i>[Signature]</i>

E-NUMBER

PROD NO. WD 6020-B6

DATE: 8-20-62

P.D FILE NO. 5-A151AA

DRAWN A.D. CHKD *[Signature]*

ENGR R.D.S. APPD *[Signature]*

TELETYPE CORPORATION

6020-B6 WD

ISSUE	DATE	AUTH. NO.
2	11-12-62	75072
3	12-13-62	75364

FS-17
MOTOR CONTROL RELAY CIRCUIT

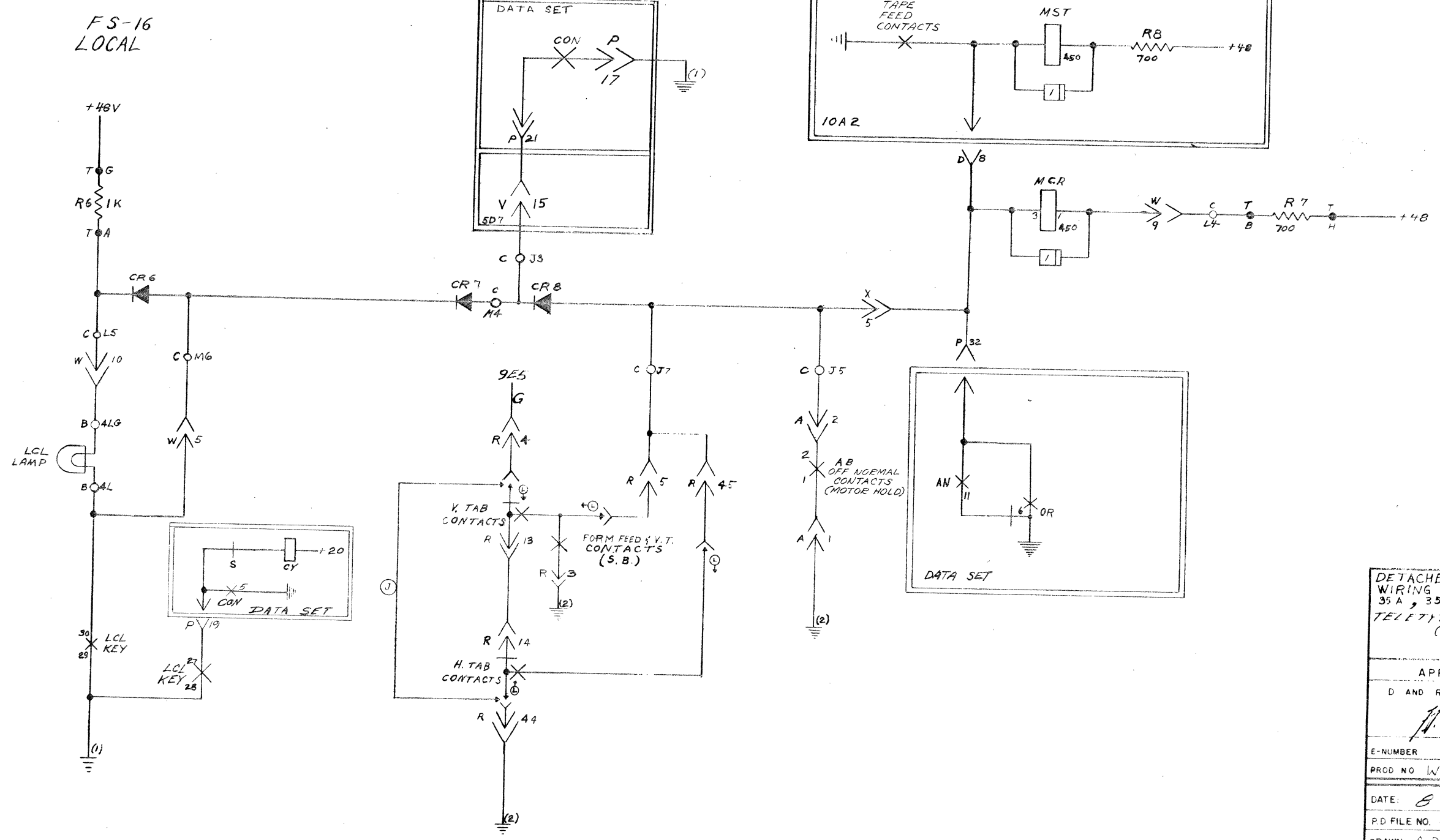

SHEET NOTES:
1. [Symbol] DENOTES 185A NET

DETACHED SCHEMATIC WIRING DIAGRAM FOR 35 A, 35 B, 35 C & 35 D TELETYPEWRITER SET (KSE)

SHEET B7

APPROVALS	
D AND R	E OF M
[Signature]	[Signature]
E-NUMBER	
PROD NO WD 6020-B7	
DATE: 8-20-62	
P.D FILE NO. G-A1514A	
DRAWN A.D.	CHKD. [Signature]
ENG. R.D.S.	APPD. [Signature]

TELETYPE CORPORATION

6020-B8 WD

ISSUE	DATE	AUTH. NO.
2	12-13-62	75364

FS-18
OUT OF SERVICE
INDICATOR

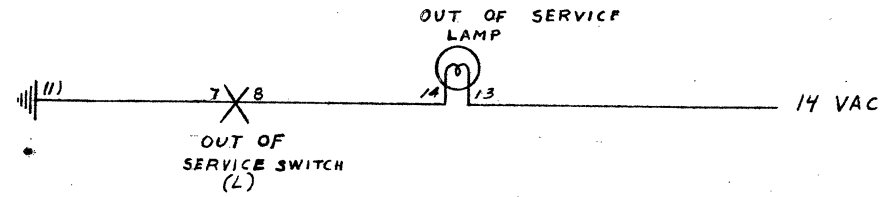

FS-19
RINGER CIRCUIT
& OFF HOOK CIRCUIT

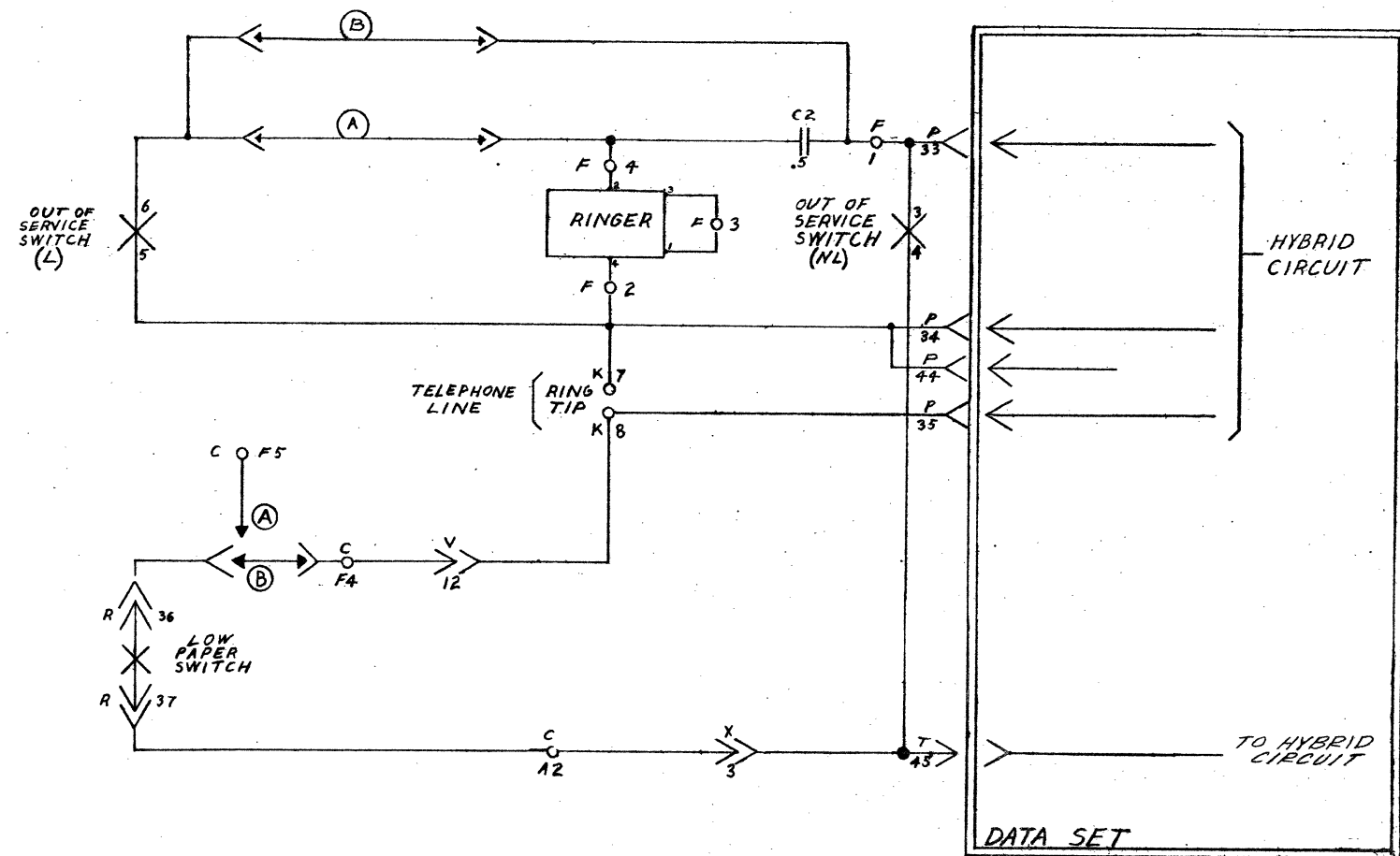

DETACHED SCHEMATIC
WIRING DIAGRAM FOR
35A, 35B, 35C & 35D
TELETYPEWRITER SET
(KSR)

SHEET 88

APPROVALS

D AND R	E OF M
<i>[Signature]</i>	<i>[Signature]</i>

E-NUMBER

PROD. NO. WD 6020-B8

DATE: 8-20-62

P.D. FILE NO. G-A151AA

DRAWN R.E.D. CHKD *[Signature]*

ENGR. R.D.S. APPD. *[Signature]*

TELETYPE
CORPORATION

6020-B8 WD

FS-20
PAPER ALARMS

6020-B9 WD

ISSUE	DATE	AUTH. NO.
2	12-13-62	75364

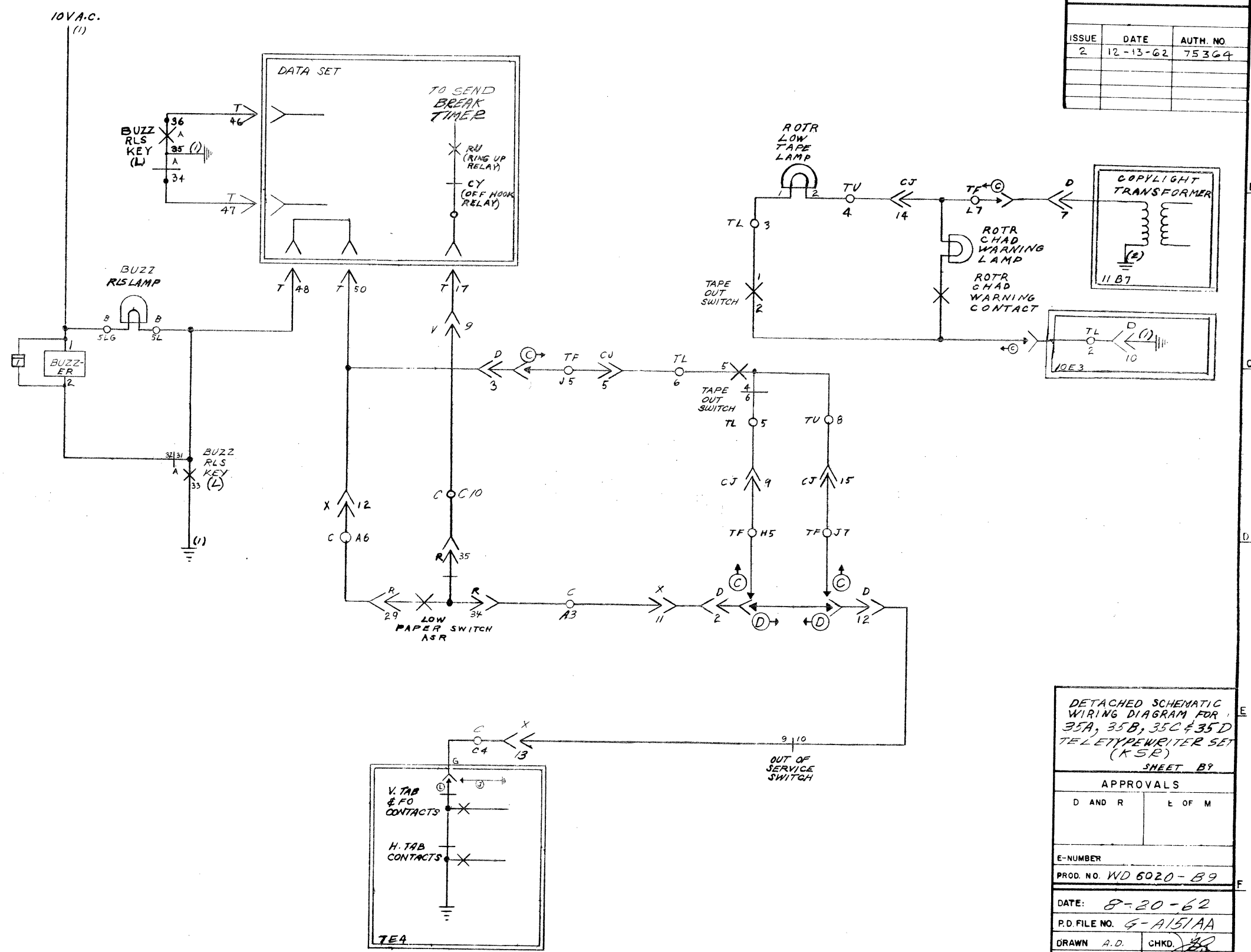

DETACHED SCHEMATIC
WIRING DIAGRAM FOR
35A, 35B, 35C & 35D
TELETYPEWRITER SET
(KSR)
SHEET B9

APPROVALS

D AND R	E OF M

E-NUMBER
PROD. NO. WD 6020-B9

DATE: 8-20-62
P.D. FILE NO. G-A151AA

DRAWN A.D.	CHKD.
ENG. R.D.S.	APPD.

TELETYPE
CORPORATION
6020-B9 WD

(PART OF)
APPARATUS FIGURE 1

6020WD-CI		
ISSUE	DATE	AUTH. NO.

DESIG.	C	TERM.	LOC.
PART NO.	193922	H1	4C1
TERM.	LOC.	H2	11E2
AA1	11D4	H3	5D4
AA2	11C6	H4	10D2
AA3		H5	10E2
AA4	11B5	H6	
AA5	11A5	H7	
A1	6D4	J3	7C4
A2	8F5	J4	5D4
A3	9E6	J5	7D5
A4		J6	4C3
A5	10E1	J7	7D4
A6	9D4	K1	4C2
A7	6C4	K2	4B2
A8	4D4	K3	5D4
A9	4B7	K4	5B3
A10	10D3	K5	5C4
B1	6C4	K6	5B2
B2	4D1	K7	
B3	6B5	L1	11E4
B4		L2	4B3
B5		L3	11E3
B6		L4	7C7
B7		L5	7D1
B8	6F4	L6	
B9		L7	
B10		M1	
C1		M2	
C2		M3	
C3		M4	7C4
C4	9E5	M5	5B4
C5		M6	7D2
C6		M7	
C7		N1	11E4
C8	6E4	N2	
C9		N3	11F4
C10	9D5	N4	
D1		N5	
D2		N6	
D3		N7	
D4		P1	
D5		P2	
D6		P3	
D7		P4	
D8		P5	
D9	4D8	P6	
D10	4D7	P7	
E1		R1	
E2		R2	
E3		R3	
E4		R4	
E5		R5	
E6		R6	
E7		R7	
F1	11E7	S1	
F2		S2	
F3		S3	
F4	8E4	S4	
F5	8E3	S5	
F6		S6	
F7	11F4	S7	
G1	4C3	T1	
G2		T2	
G3	11E7	T3	
G4	11E3	T4	
G5	11E3	T5	
		T6	
		T7	

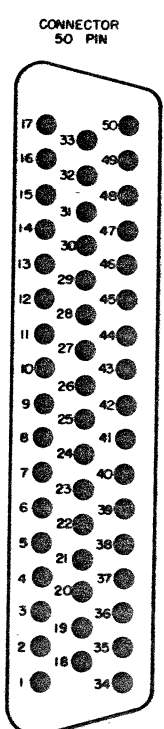

PART NO. 192013

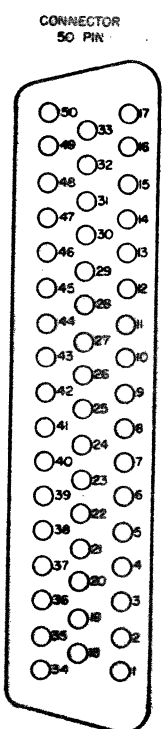

PART NO. 192014

DESIG.	F	R
PART NO.	192013	192014
TERM.	LOC.	LOC.
1	4C2	4D6
2	4C3	4D6
3	4C3	7E4
4	4C3	7D4
5	5C2	7E4
6	5C2	6A3
7	11E3	6A3
8	11E7	6F3
9		6F4
10		
11		
12		
13		
14		
15		
16		
17	11B5	11D6
18	4C2	
19		
20		
21		10E1
22		
23		10E3
24		10E2
25		
26		
27		
28		
29		9E4
30		
31		
32	11D4	
33		
34		9E5
35		9D5
36		8F3
37		8F3
38		6D3
39		6C3
40		5D4
41		5C4
42		
43		
44		7F4
45		7E5
46		
47		
48		
49		
50	11B6	11D7

PRINTED CIRCUIT CARDS

DESIG.	PART NO.	LOC.
L.P. SELECTOR MAGNET DRIVER	103440	4B6
SIGNAL REGENERATOR	111564	9A2

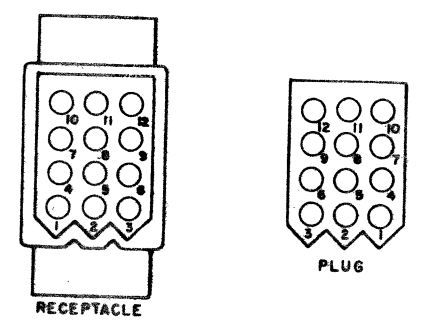

PART NO.	182648	182647
MTG.	CHASSIS	CABLE

TERMINAL NUMBERING AS VIEWED FROM TERMINAL END.
TERMINALS ARE INDIVIDUALLY INSERTED AND MAY BE EITHER MALE OR FEMALE.

INSERT	PART NO.
MALE	182643
FEMALE	182644

CONNECTOR

DESIG.	A
PART NO.	193040
TERM.	LOC.
1	7E5
2	7D5
3	5C3
4	5C3
5	
6	5B4
7	5B4
8	
9	
10	5B4
11	4C1
12	4D1

CONNECTOR

DESIG.	COPYRIGHT
PART NO.	182647
TERM.	LOC.
1	11C7
2	11C7

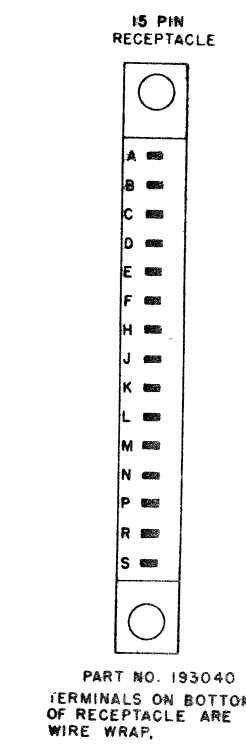

CONNECTOR

DESIG.	AB
PART NO.	193040
TERM.	LOC.
A	4B3
B	
C	
D	
E	
F	
G	
H	
I	
J	
K	4B2
L	4B1
M	
N	4B2
P	4B2
R	4B3
S	

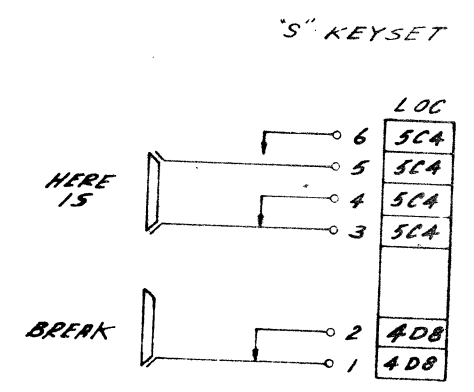
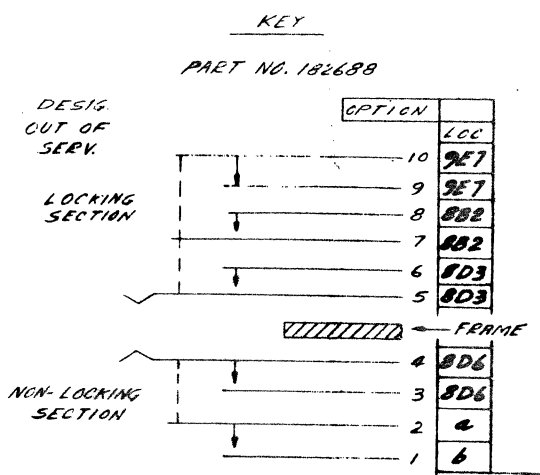

TURRET

DESIG.	T
PART NO.	165008
TERM.	LOC.
A	7C1
B	7C8
C	5B3
D	
E	
F	
G	7C1
H	7C8
I	5B3
J	
K	
L	

RELAY

DESIG.	NCT
PART NO.	145022
TERM.	LOC.
12	B 5D4
11	B 7C8
10	B 10E2
9	
8	M 8C5
7	
6	BM 5B3
5	
4	M
3	
2	B
1	
COIL	5B3

APPARATUS FIGURE FOR
35A, 35B, 35C, 35D
TELETYPEWRITER
SET (KSR)

APPROVALS
D AND B E OF M

E-NUMBER
PROD. NO. 6020WD-CI

DATE: 10-5-62

P.D. FILE NO. G-A151AA

DRAWN GCK CHRD J. Bly

ENG. WEC APPD. J. Bly

TELETYPE CORPORATION

6020WD-CI

(PART OF)
APPARATUS FIGURE 1

2" KEYSSET

6020 WD-C2

182732 CONNECTOR

50	25
49	24
48	23
47	22
46	21
45	20
44	19
43	18
42	17
41	16
40	15
39	14
38	13
37	12
36	11
35	10
34	9
33	8
32	7
31	6
30	5
29	4
28	3
27	2
26	1

DESIG.	P	T
PART NO. 182733	182732	
TERM. LOC. LOC.		
1 1D7	4F6	
2 1D7	4F7	
3 1B7		
4 1B7	4F7	
5 1F7	4FB	
6 1F7		
7 1F2	4F4	
8 1E2	4F1	
9 1E2	5F4	
10 1B2	5F4	
11 1B2		
12 1B2		
13 1D2		
14 1B2	6F5	
15 1C2	6C5	
16 1D2	6D5	
17 5F7	9C5	
18 5F7	9F7	
19 TE2	6B6	
20 2C3		
21 5F7	11E2	
22 1C2	10E2	
23 2C3		
24 a		
25 b		
26 2C3		
27 2C3		
28		
29 3E2		
30 3B2		
31 c		
32 7D6		
33 8D6		
34 8E6	10E1	
35 8E6		
36 1C7		
37 1C7		
38 1C7		
39 1E7		
40 1B2		
41 3D2		
42 3D2		
43		
44 8E6	11E2	
45 1A2	8F6	
46 1E2	9B4	
47 3C2	9B4	
48	9C4	
49 11E2	6F5	
50	9C4	

MALE

182733 CONNECTOR

25	50
24	49
23	48
22	47
21	46
20	45
19	44
18	43
17	42
16	41
15	40
14	39
13	38
12	37
11	36
10	35
9	34
8	33
7	32
6	31
5	30
4	29
3	28
2	27
1	26

FEMALE

a	Ⓣ	2F3
	Ⓧ	3F2
b	Ⓣ	2F3
	Ⓧ	3F2
c	Ⓣ	2E3
	Ⓧ	3B2

15 PIN RECEPTACLE

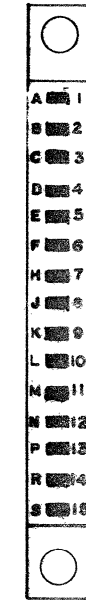

PART NO. 182536

CONNECTOR

DESIG.	SMD
PART NO. 182536	
TERM. LOC.	
1 4C6	
2 4C5	
3 4C5	
4	
5	
6	
7	
8	
9	
10	
11 4C6	
12 4C5	
13 4C6	
14 4C5	
15 4C6	

TERMINAL BOARD

DESIG.	H	H
PART NO. 182717	182717	
OPTION	Ⓣ	Ⓧ
TERM. LOC. LOC.		
1	3D2	
2	3E2	
3	3C2	
4	3F3	
5 2E3	3E3	
6	3B2	
7		
8	3E4	
9	3E4	
10 2F3	3E3	
11	3D2	
12 2E5	3E5	
13	3E6	
14 2C5	3B8	
15 2C3		
16 2C3		
17 2F7	3F8	
18 2F7	3F8	

TERMINAL BLOCK

DESIG.	K
PART NO. 181411	
TERM. LOC.	
1 11B2	
2 11B2	
3 11A2	
4 11D3	
5 a	
6 b	
7 8E5	
8 8E5	
9	
a	Ⓣ 2F7
	Ⓧ 3F7
b	Ⓣ 2F7
	Ⓧ 3F7

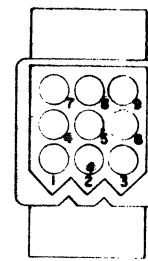

PART NO. 182716	182645
MTG. CHASSIS	CABLE

TERMINAL NUMBERING AS VIEWED FROM TERMINAL END

TERMINALS ARE INDIVIDUALLY INSERTED AND MAY BE EITHER MALE OR FEMALE

INSERT	PART NO.
MALE	182643
FEMALE	182644

BUZZER

DESIG. LOC. PART NO.
BUZZER 9C3 182718

RINGER

DESIG. LOC. PART NO.
RINGER 8D5 182503

CARD

DESIG. LOC. PART NO.
U 11B2 182510

SPEAKER

DESIG. LOC. PART NO.
AB a 183478
a 2FB
b 3FB

CONVENIENCE RECEPTACLE

DESIG. LOC. PART NO.
M 11B3 178831

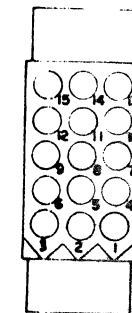

PART NO. 182539	182540
MTG. CHASSIS	CABLE

TERMINAL NUMBERING AS VIEWED FROM TERMINAL END

TERMINALS ARE INDIVIDUALLY INSERTED AND MAY BE EITHER MALE OR FEMALE

INSERT	PART NO.
MALE	182643
FEMALE	182644

DESIG.	E
PART NO. 182645	182716
TERM. LOC.	
1 4D5	
2	
3 4D6	
4	
5 4C6	
6 4C6	
7 4C5	
8 4E6	
9	

ORIG. (NL)

CLR (NL)

ANS. (NL)

TST (L)

LCL (L)

BUZ PLS (L)

CONNECTOR

DESIG.	D	D	V	W	X
PART NO. 182539	182539	182540	182541	182542	182543
OPTION C D					
TERM. LOC. LOC. LOC. LOC. LOC.					
1 10D3		4E7	11E4	4D1	
2 9E6	9E6	4E8	4D5	4D5	
3 9C5		4D4	4D6	8F5	
4 10E2		11E2	4D6	11E7	
5 10C1		5E4	7D2	7D6	
6 10D2		5E4	11D4		
7 9B8		10E1	11B5	10E2	
8 7C6	7C6	6F5	11B5	10D1	
9 4E5	4E5	9C5	7C7	10D2	
10 10E3		6C4	7D1	10D3	
11 10E3		6D4	11E4	9E6	
12 9E7	9E7	8E4	11E3	9D4	
13 10E5		6E5		9E5	
14		6E5			
15 4E5	4E5	5E7			

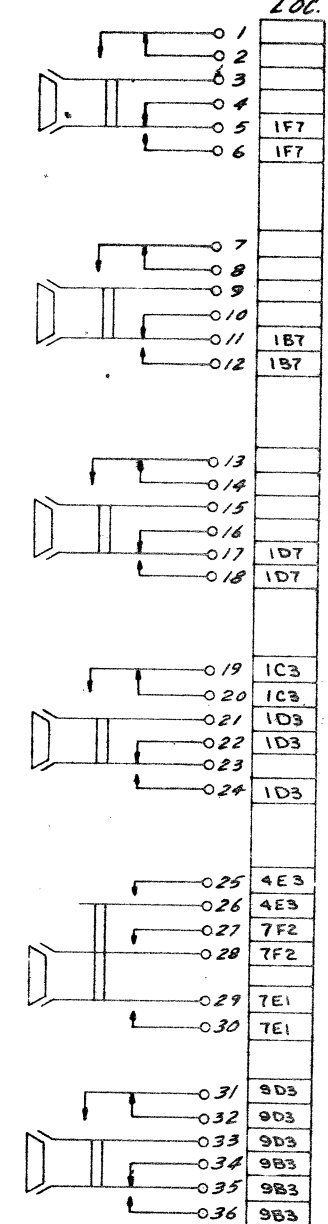

ISSUE	DATE	AUTH. NO.
2	12-13-62	75364

APPARATUS FIGURE FOR 35A, 35B, 35C, 35D TELETYPEWRITER SET (KSR)

APPROVALS	
D AND P	E OF M
E-NUMBER	
PROD. NO. 6020WD-C2	
DATE: 10-5-62	
P.D. FILE NO. G-A151A	
DRAWN GCK	CHKD J. H. [Signature]
ENGD. WEC	APPD. [Signature]

TELETYPE CORPORATION
6020WD-C2

(PART OF)
APPARATUS FIGURE 1

6020 WD-C3

ISSUE	DATE	AUTH. NO.
2	3-5-63	75682
3	3-10-64	81108

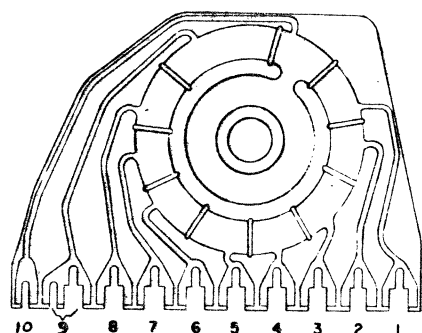

DISTRIBUTOR DISC

DESIG.	PART NO.
1	4C1
2	4C1
3	4C1
4	4C2
5	4C2
6	4C2
7	4C2
8	4C2
9	4C2
10	4C1

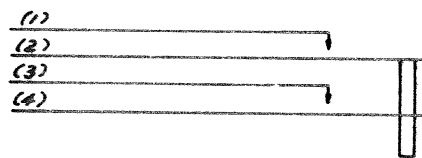

192225

SWITCH

DESIG.	AB. OFF. NO. NORM.	PART NO.
1	7E5	7E5
2	7E5	7E5
3	5C3	5C3
4	5C3	5C3

SIGNAL GENERATOR KBD



DESIG.	B
1	4C2
2	4C2
3	4C2

MAGNET COILS

DESIG.	LOC.	PART NO.
A.B. COIL	5B5	274M

MOTOR

DESIG.	LOC.	PART NO.
LMU 3	11C5	1517B5

TERMINAL STRIP

DESIG.	S	F
1	11B5	8D6
2	11B5	8E5
3	11B4	8D5
4		8D5

SWITCH

DESIG.	LOC.	PART NO.
KBD TIMING CONTACT	4C3	1924B6
KBD UNIVERSAL	5C2	17B144
MARGIN INDICATOR	11F8	15B163

RELAY

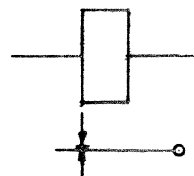

MCR

7C6

11B5

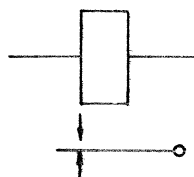

ABR

5B4

5B4

BELL

DESIG.	LOC.	PART NO.
BELL	11C6	193451

DIODES

DESIG.	LOC.	PART NO.
CR4	5B3	171541
CR5	5B3	171541
CR6	7D1	171541
CR7	7D3	171541
CR8	7D4	171541
CR9	11F4	171541
CR10	11F4	171541
CR11	11F4	171541
CR12	11F4	171541

NETWORKS

DESIG.	LOC.	PART NO.
ABR	5B3	153631
MCR	7C6	153631
BUZZER	9C2	153631
NCT	5A3	153631

TRANSFORMER

DESIG.	LOC.	PART NO.
TR1	4D6	182519
TR	11E4	182687
COPYLIGHT	11B7	193412

LAMP

DESIG.	LOC.	PART NO.
NO COIL	1A3	182529
SVC	1B3	182529
BY	1B3	182529
INCPY	1B3	182529
DIAL	1B3	182529
PA	1B3	182529
TST	1D3	182529
BRK RLS	1E3	182659
REST	1F3	182659
CLR	1C7	182529
ANS	1C7	182529
ORIG.	1F7	182529
LCL	7D1	182529
OUT OF SERVICE	5B3	182659
BUZZ RLS	9C3	182529
(2) COPY	11C7	154882
MARGIN INDICATOR	11D7	142159

CAPACITOR

DESIG.	LOC.	PART NO.	VALUE
C3	4C6	182501	1500MFD
C2	8D5	182761	.5MFD

FUSE

DESIG.	LOC.	PART NO.	VALUE
C	11C4	117176	1/2 A
R	11B3	161136	64A.

RESISTOR

DESIG.	LOC.	PART NO.	VALUE
R5	4C6	182517	35Ω
R6	7C1	165330	1KΩ
R7	7C8	171524	700Ω
AA	"	182683	50Ω
⓪	2F7		
ⓧ	3F7		

APPARATUS FIGURE FOR
35A, 35B, 35C, 35D
TELETYPEWRITER
SET (KSR)

APPROVALS

D AND	E OF M
<i>[Signature]</i>	<i>[Signature]</i>

E-NUMBER

PROD. NO. 6020 WD-C3

DATE: 10-5-62

P.D. FILE NO. G-A151AA

DRAWN	CHKD.
WEC	<i>[Signature]</i>

TELETYPE CORPORATION

6020WD-C3

APPARATUS FIGURE 2

6020WD-C4		
ISSUE	DATE	AUTH NO
	1-6-64	79912
	3-5-7-64	79914-2

- 19
- 20
- 21
- 22
- 23
- 24
- 25
- 26
- 27
- 28
- 29
- 30
- 31
- 32
- 33
- 34
- 35
- 36

- 1
- 2
- 3
- 4
- 5
- 6
- 7
- 8
- 9
- 10
- 11
- 12
- 13
- 14
- 15
- 16
- 17
- 18

DESIG.	CD
PART NO.	193040
TERM.	LOC.
1	10E7
2	
3	
4	
5	
6	
7	
8	
9	
10	
11	
12	
13	
14	
15	
16	
17	
18	
19	10E7
20	
21	
22	
23	
24	
25	
26	
27	10B2
28	
29	
30	10B2
31	10A2
32	10B4
33	10D2
34	10D2
35	
36	

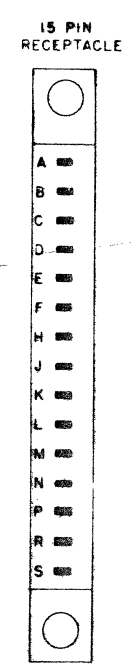

PART NO. 193040
TERMINALS ON BOTTOM OF RECEPTACLE ARE WIRE WRAP.

DESIG.	CA	CB
PART NO.	193040	193040
TERM.	LOC.	LOC.
A		10D3
B	10C7	
C	10C7	10C5
D		
E		10E3
F	10C8	
H	10C6	10E5
J	10C7	
L	10C8	
M	10C8	10D5
N	10C6	
P	10C6	10D5
R	10C7	
S	10C8	

DESIG.	TF
PART NO.	193040
TERM.	LOC.
AA1	10E7
AA2	10C7
AA3	
AA4	
AA5	10C7
AA6	10C7
AA7	
H1	10D6
H2	
H3	10B3
H4	10A4
H5	9B6
H6	
H7	10B3
J1	
J2	10C2
J3	10D6
J4	
J5	9C5
J6	
J7	9D7
K1	
K2	10C2
K3	
K4	
K5	
K6	10B1
K7	10C1
L1	
L2	10C2
L3	
L4	
L5	10E4
L6	10E5
L7	9B8
M1	10C8
M2	10C8
M3	
M4	
M5	
M6	
M7	

DESIG.	TL	TU
PART NO.	193040	193040
TERM.	LOC.	LOC.
1	10D7	
2	10B4	10A2
3	9B6	10B2
4		9B7
5	9C6	10B3
6	9C7	10C8
7	10D7	10C8
8	10D7	9C7
9	10D7	10F7
10		
11		
12		
13		
14		
15		
16		
17		
18		

- 9
- 10
- 11
- 12
- 13
- 14
- 15
- 16

- 1
- 2
- 3
- 4
- 5
- 6
- 7
- 8

DESIG.	CJ
PART NO.	193040
TERM.	LOC.
1	10C7
2	10C7
3	10F7
4	
5	9C6
6	10B2
7	10B2
8	10C8
9	9D6
10	
11	10C7
12	10B4
13	10A2
14	9B7
15	9D7
16	10C8

DESIG.	TFR	RCE
CODE	AK-1	AK-1
PART NO.	193834	193834
CONT ARR	LOC	CONT ARR
12		EBM 10C2
11		EBM 10A4
10		M 10B3
9		10C6
8		EMR 10B4
7		
6		
5		
4		
3		
2		EBM 10B3
1		M 10B3
COIL	10B2	10C2

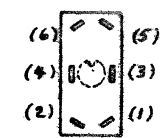

DESIG.	ALL TRAFFIC
PART NO.	193834
TERM.	LOC.
1	10D2
2	
3	10D2
4	
5	
6	

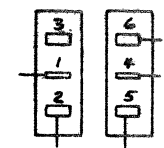

DESIG.	TYPE
PART NO.	194220
TERM.	LOC.
1	9C7
2	9C7
3	
4	9C6
5	
6	9C6

DESIG.	LOC.	PART NO.
ROTR	10D8	271M
RIBBON SHIFT	10E7	224M
TAPE FEED	10B2	224M

DESIG.	LOC.	PART NO.
ROTR	10D7	1707G4

DESIG.	PART NO.	LOCATION
ROTR SELECTOR MAGNET DRIVER	193440	10A7 PAGE 1
ROTR SELECTOR MAGNET DRIVER	182630	10A7 PAGE 2

DESIG.	LOC.	PART NO.	VALUE
RE	10A1	1534E5	600.Ω
RF	10B1	17362	350.Ω
RC	10C1	1534E5	600.Ω
RD	10C8	1934E5	32.Ω

DESIG.	LOC.	PART NO.	VALUE
FA	10C7	1532G9	3/8A.
FE	10D7	129919	4A.

DESIG.	LOC.	PART NO.
TR 3	10C8	182519

DESIG.	LOC.	PART NO.	VALUE
CA	10C8	182501	1500MFD

DESIG.	LOC.	PART NO.
RCR	10C2	153631
MST	10B2	153631

DESIG.	LOC.	PART NO.
CE	10F8	114467

DESIG.	LOC.	PART NO.
ROTR LOW TAP	9B7	151902
ROTR HIGH TAP	9B8	151902

DESIG.	LOC.	PART NO.
ROTR CHRD	9C9	158163
WARMING	10A3	195005
TAPE FEED		
MOTOR HOLD		
PS	10D7	1787M

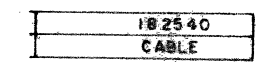
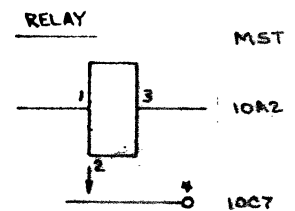

TERMINAL NUMBERING AS VIEWED FROM TERMINAL END
TERMINALS ARE INDIVIDUALLY INSERTED AND MAY BE EITHER MALE OR FEMALE

INSERT	PART NO.
MALE	182643
FEMALE	182644

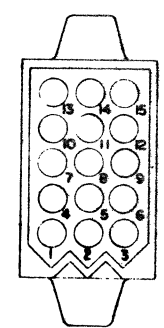

DESIG.	D
PART NO.	182540
TERM.	LOC.
1	10D3
2	9E6
3	9C5
4	10E2
5	10C1
6	10D2
7	9B8
8	7C6
9	4E5
10	10E3
11	10E3
12	9E7
13	10E5
14	10A4
15	4E5

APPARATUS FIGURE FOR 35A, 35B, 35C, 35D TELETYPEWRITER SET (KSR)

APPROVALS

D AND E OF M

E NUMBER

PROJ NO. 6020WD-C4

DATE: 10-5-62

RD FILE NO. G-A151AA

DRAWN GCK

ENG WEC

TELETYPE CORPORATION

6020WD-C4

APPARATUS FIGURE 3

6020WD-C5

ISSUE	DATE	AUTH. NO.
A/2	4-20-64	81579

STUNT BOX
DESIG. "ATG"

CONNECTOR

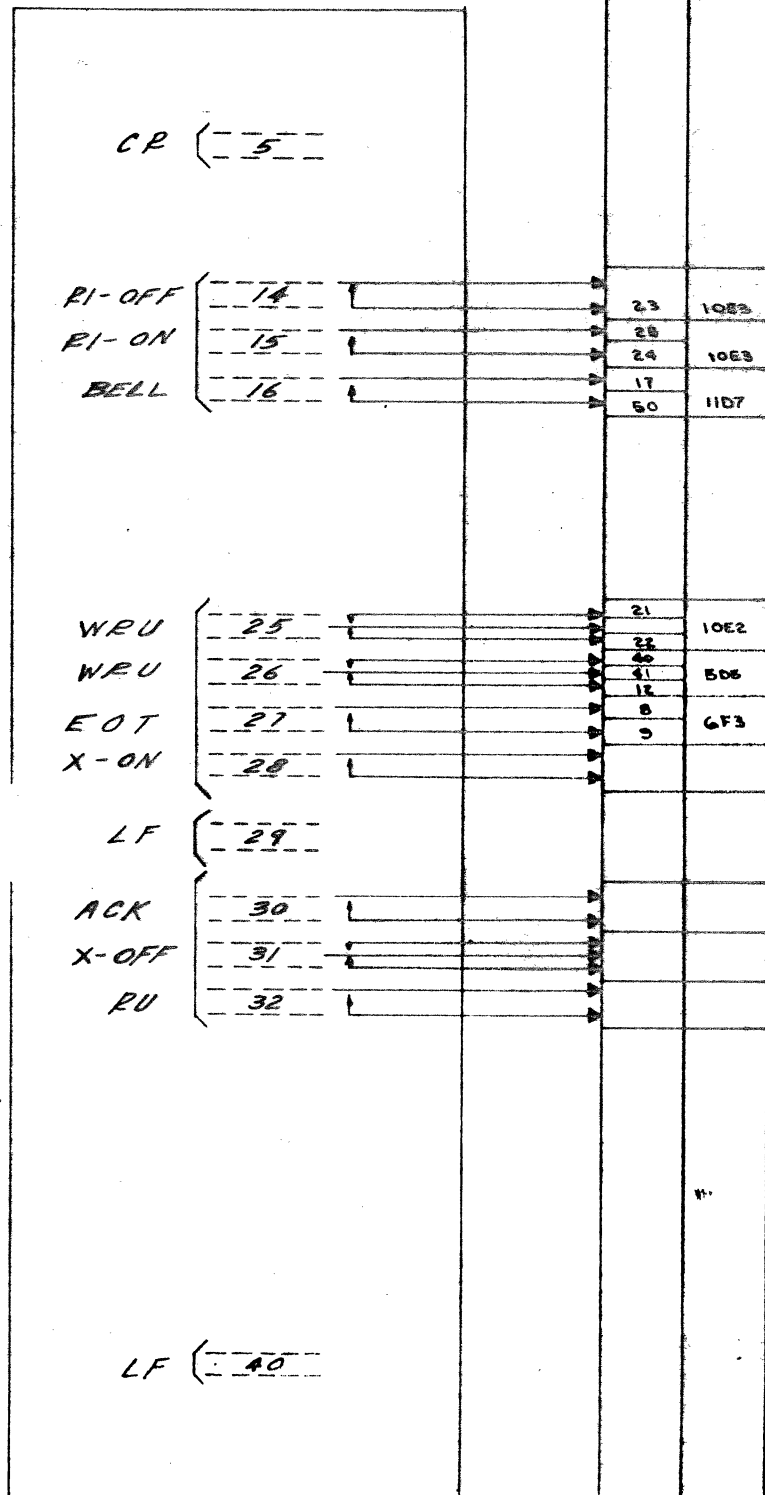

MAGNET COILS
DESIG. LP



CONNECTOR

DESIG.	R
TERM.	LOC.
1	4D6
2	4D6
35	9D5
34	9D5
20	9D5
37	8F3
36	8F3

SWITCH
DESIG. PAPER OUT
ALARM



1	4	35	9D5
2	5	34	9D5
3	6	20	9D5
4		37	8F3
5		36	8F3

APPARATUS FIGURE FOR
35A, 35B, 35C, 35D
TELETYPEWRITER
SET (KSR)

APPROVALS

D AND P	E OF M
<i>[Signature]</i>	<i>[Signature]</i>

E-NUMBER

PROD. NO. 6020WD-C5

DATE: 10-5-62

P.D. FILE NO. G-A151AA

DRAWN GCK	CHKD. <i>[Signature]</i>
ENGD WEC	APPD.

TELETYPE
CORPORATION

6020WD-C5

6020WD-C7		
ISSUE	DATE	AUTH. NO.
2	12-18-62	75364
3	12-9-63	79390

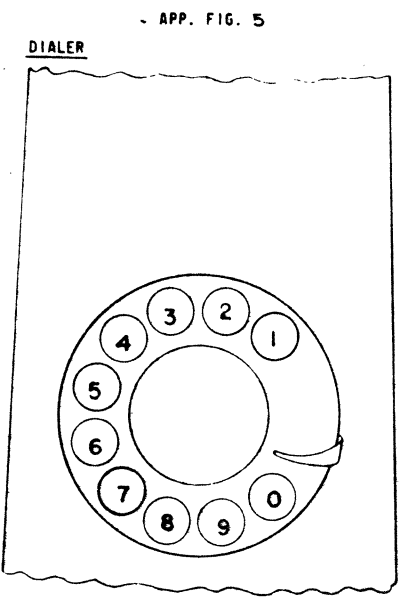

DESIG. 8G PULSE DIALER
 LOC. 2C5, 2FB
 OPTION
 CODE WECO 8G
 WECO A DWG.
 579298
 TELETYPE NO.
 182500

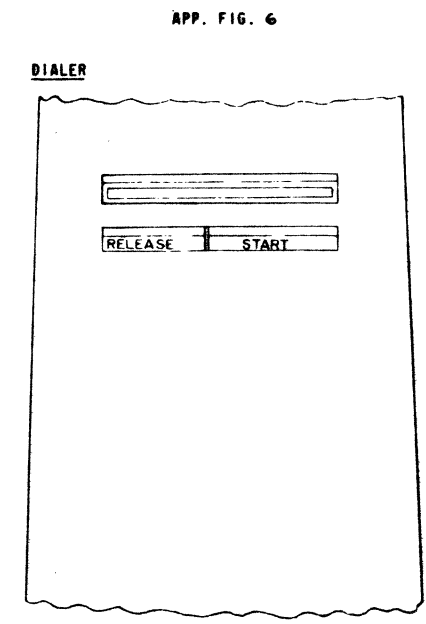

DESIG. 41A PULSE DIALER
 LOC. 2B7
 OPTION
 CODE WECO 41A
 WECO A DWG.
 579298
 TELETYPE NO.
 182622

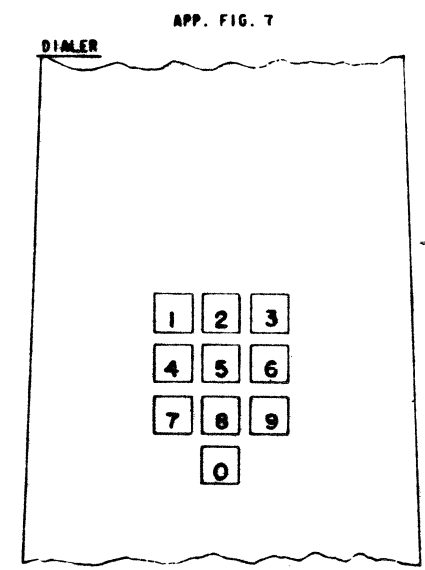

DESIG. TONE DIALER 25F1-49
 LOC. 3C6
 OPTION
 CODE WECO 25F1-49
 WECO A DWG.
 579827
 579892
 TELETYPE PART NO.
 182620

RESISTOR

DESIG.	LOC.	PART NO.	VALUE
R2	3E3	182765	200Ω
PT	3E4	182686	50KΩ

CAPACITOR

DESIG.	LOC.	PART NO.	VALUE
CK	3D5	182795	.25MFD

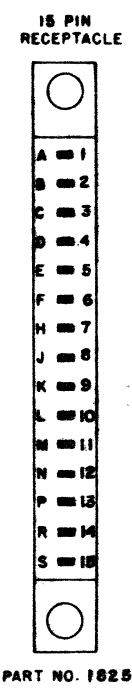

PART NO. 182536

CONNECTOR

DESIG.	M	N
PART NO.	182536	182536
OPTION	T.W.	M.X.Y
TERM.	LOC.	LOC.
A		3E4
B	2F7	3F7
C	2E4	3F3
D	2F4	3F3
E	2E5	3E4
F	2F7	3F7
H	2F7	3F7
J		
K		
L	2F4	3F3
M	2E7	3E7
N	2E7	3E7
P	2F4	3F3
R	2F4	3F3
S	2E5	3E5

FILTER
 DESIG. CJ
 LOC. 2C4
 OPTION
 CODE WECO CJ
 WECO A DWG.
 579881-4
 TELETYPE NO.
 182621

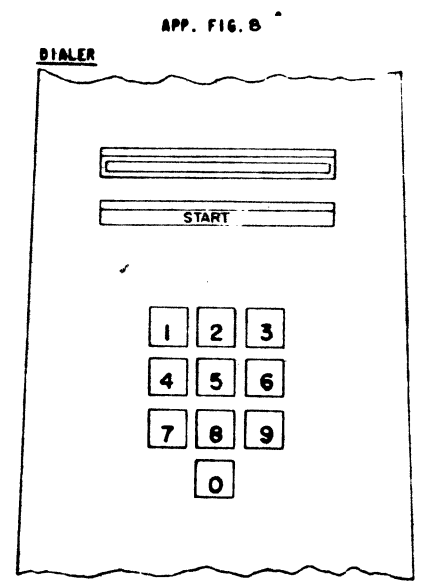

DESIG. TONE DIALER 26C-49
 LOC. 3B5
 OPTION
 CODE WECO 26C-49
 WECO A DWG.
 579881-4
 TELETYPE NO.
 182621

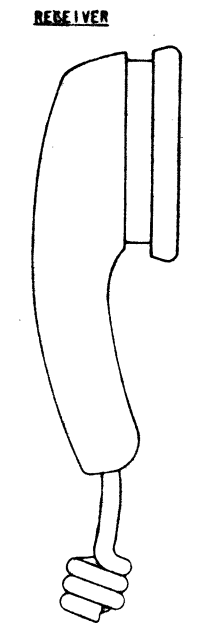

DESIG. REC
 LOC. a
 OPTION
 CODE WECO REC
 WECO A DWG.
 579881-4
 TELETYPE NO.
 182621

APP. FIG. 10

PRINTED CIRCUIT CARDS

DESIG.	PART NO.	LOC.
TURN AROUND TRAFFIC CONTROL	177519	10D4

PRINTED CIRCUIT CARD

DESIG.	PART NO.	LOC.
AMPLIFIER CARD	182743	a
		2F3
		3F3

APPARATUS FIGURES FOR 35A, 35B, 35C, 35D TELETYPEWRITER SET (KSR)

APPROVALS

D AND R E OF M

E-NUMBER

PROD. NO. 6020WD-C7

DATE: 10-5-62

P.D. FILE NO. G-A151AA

DRAWN GCK CHKD. [Signature]

ENGD. WEC APPD. [Signature]

TELETYPE CORPORATION

6020WD-C7

