

**ISSUE CONTROL RECORD**

**6005WD**

**NO. NOTES SUPPORTING INFORMATION CONTENTS**

**SHEET NO. ISSUE**

REVISIONS APPLYING TO THIS CONTROL RECORD

ISSUE	DATE	AUTH. NO.
1	3-27-67	93756-RC
2	5-2-67	93362
3	2-7-68	95266

**CATEGORY NO.**

2	3	4	5	6	7	8	9	10	11	12	13	14	15	16	17	18	19
---	---	---	---	---	---	---	---	----	----	----	----	----	----	----	----	----	----

1	X	X	X	X	X	X	X	X	X								
2	X	X	X	X	X	X	X	X	X								

**RTTY ELECTRONICS**  
 TELETYPE=Sales-Service-Parts  
 PO Box 20101 El Sobrante, Ca.  
 94820. (510)222-3102  
 mr\_rtty@pacbell.net

**ISSUE CONTROL SHEET 1 OF 1**

ACTUAL WIRING DIAGRAM FOR MODEL 35 KEYBOARD BASE LK803 LK815  
  
( WALL MOUNT )

WD NUMBER	6005WD	
DRAWN	REG	CHKD. <i>RHH</i>
ENGD.	WTC	APPD. <i>TIP</i>

**TELETYPE CORPORATION**

**6005WD**

- NO. NOTES
1. WIRING LEGEND:  
 Distant Terminating Area  
 Distant Terminating Designation  
 Wire Color Code  
 A-2-W
  2. COLOR CODE:  
 BK - BLACK      P - PURPLE  
 BR - BROWN     S - SLATE  
 BL - BLUE       W - WHITE  
 O - ORANGE     G - GREEN  
 Y - YELLOW      R - RED
  3. UNIT WIRED FOR 115 VOLTS 60 CYCLE AC POWER INPUT ONLY.
  4. CONNECTOR VIEWED FROM SOLDER TERMINAL END.
  5. COVER LEADS WITH 155753 INSULATING SLEEVE (15 PLS).
  6. TERMINAL DESIGNATIONS ENCLOSED IN PARENTHESES ARE NOT NECESSARILY MARKED ON COMPONENTS.
  7. CONTACTS SHOWN IN UNOPERATED OR DE-ENERGIZED POSITIONS.
  8. ASSOCIATED CABLES:  
 178504 LAMP HOLDERS AND SWITCH  
 199817 SIGNAL GENERATOR  
 195853 LINE BREAK AND RECEIVE BREAK SWITCHES.
  9. THE 154166 ARC SUPPRESSOR MUST BE DISCONNECTED IN SYSTEMS THAT EMPLOY THE 312325 OR 323609 REGENERATOR CARDS.
  10. WIRE TO KEYBOARD GROUND SCREW NOT INCLUDED ON SOME SETS.
  11. MOTOR GROUND LEAD (GREEN) MUST BE ASSEMBLED TO MOUNTING PLATE USING A SEPARATE GROUND SCREW (TO MEET U. L. REQUIREMENTS)
  12. \*DENOTES 18 GA. ALL OTHER WIRE 24 GA. EXCEPT AS NOTED.
  13. NETWORK TELETYPE  
 NO. NO. 470 0.11  
 1 153631

**A**  
158163  
MARGIN INDICATOR SWITCH

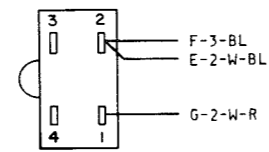

**B**  
197019  
CONTACT BOX ASSEMBLY WITH ARC SUPPRESSION  
NOTE 9

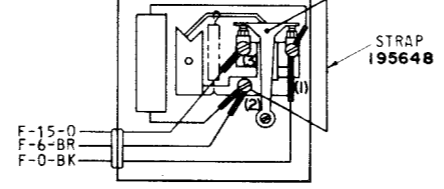

**D**  
SIGNAL BELL

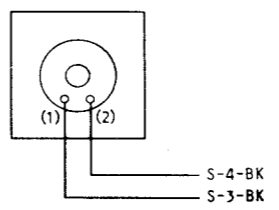

NOTE: REVISION INFORMATION MUST ALSO BE REFLECTED ON THE ISSUE CONTROL RECORD, WHICH IS PART OF THIS W.D.

**E**  
COPY LAMP

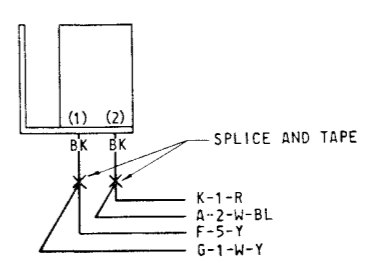

**F**  
152467  
KEYBOARD CONNECTOR PLUG

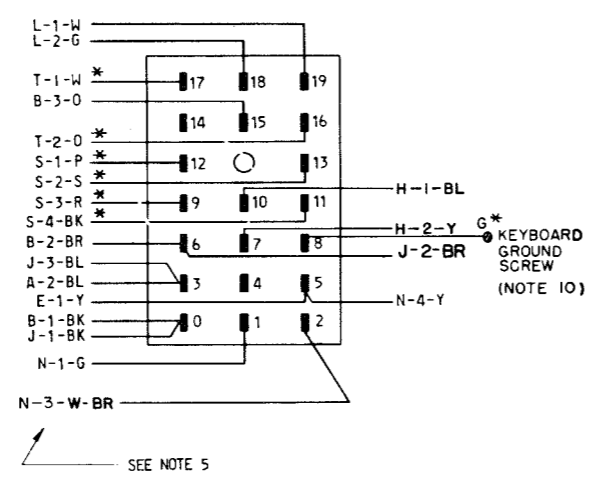

**G**  
MARGIN INDICATOR LAMP

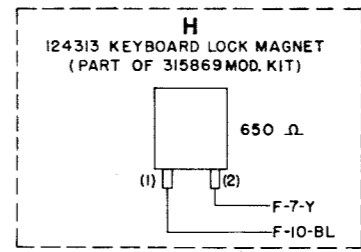
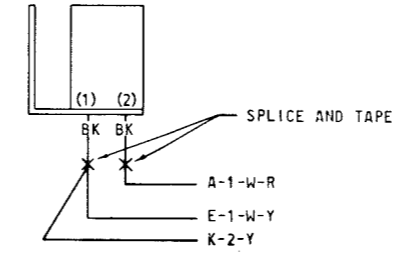

NOT PART OF LK 803

**K**  
COPY LAMP

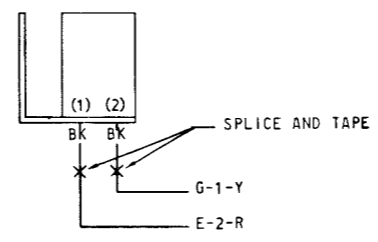

**L** 324010  
192485 OR 319946  
KEYBOARD TIMING CONTACT

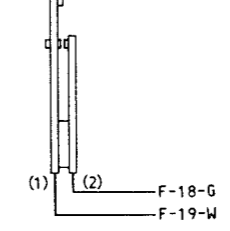

**N** 304376  
SIGNAL LINE BREAK SWITCH

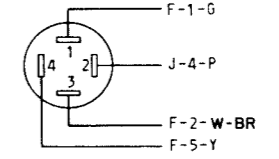

SEE ISSUE CONTROL RECORD FOR COMPLETE LIST OF SHEETS COMPRISING THIS W. D. SHEET 1

**S**  
MOTOR TERMINAL BLOCK

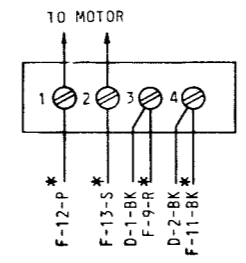

**T** 178714  
POWER SWITCH

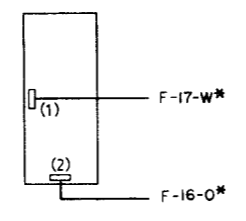

6005 WD		
REVISIONS		
ISSUE	DATE	AUTH. NO.
1	6-19-64	15369-F
2	8-10-64	81919
3	4-19-65	86500
4	6-24-65	87329
5	10-7-65	88785
6	8-24-66	91437
7	11-23-66	91976-1
8	1-25-67	92056
9	3-27-67	93756-RC
10	5-2-67	93362
11	2-7-68	95266

ACTUAL WIRING DIAGRAM FOR MODEL 35 KEYBOARD BASE LK803 LK815 (WALL MOUNT)

APPROVALS

D AND R HJK	E OF M CAJ
----------------	---------------

E-NUMBER  
 PROD. NO. 6005WD  
 DATE 2-5-63  
 P.D. FILE NO. 1-30 151AA  
 DRAWN JJK CHKD. EHH  
 ENGD. WTC APPD. TIP

TELETYPE CORPORATION

11 6005 WD

SEE SHEET 1 FOR NOTES

NOTE: REVISION INFORMATION MUST ALSO BE REFLECTED ON THE ISSUE CONTROL RECORD, WHICH IS PART OF THIS W.D.

# 6005 WD

## REVISIONS

ISSUE	DATE	AUTH. NO.
1	6-19-64	15369-R
2	8-10-64	81919
3	4-19-65	86500
4	6-24-65	87329
5	10-7-65	88785
6	8-24-66	91437
7	11-23-66	91976-1
8	1-25-67	92056
9	<b>3-27-67</b>	<b>93756-RC</b>
10	2-7-68	95266

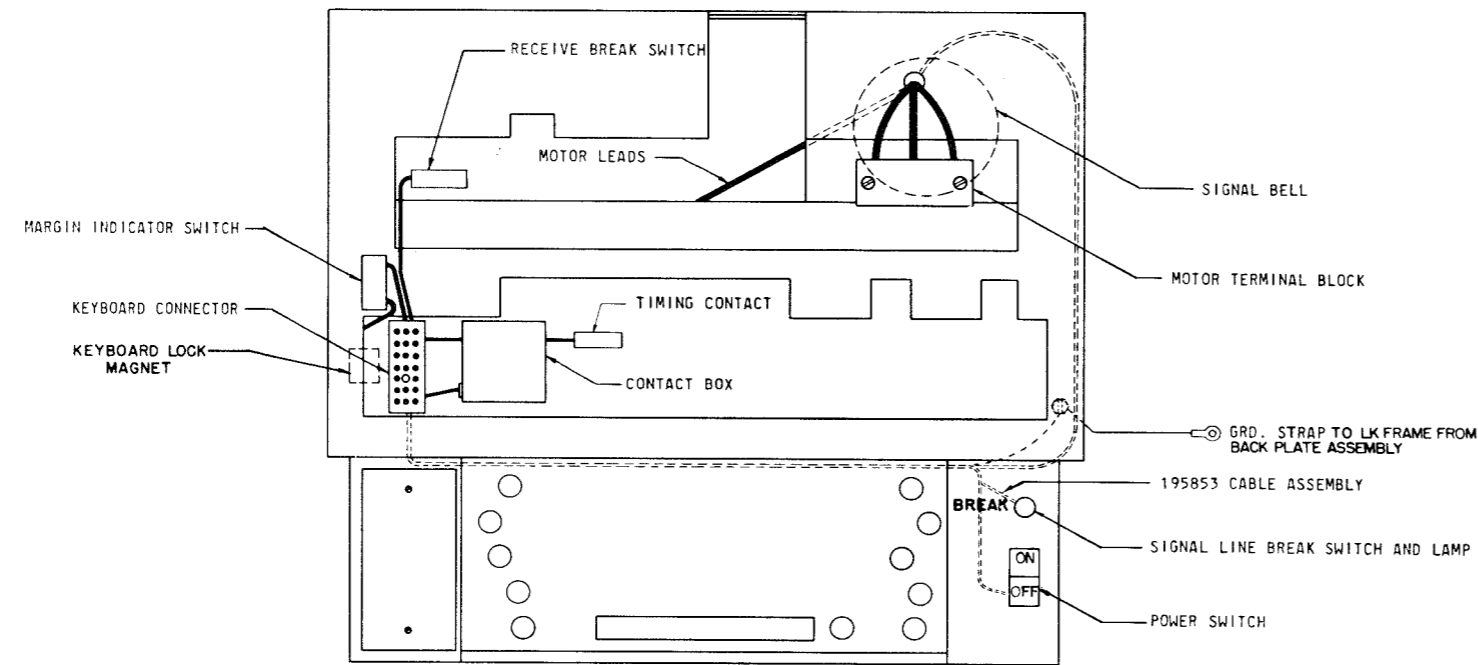

TOP VIEW

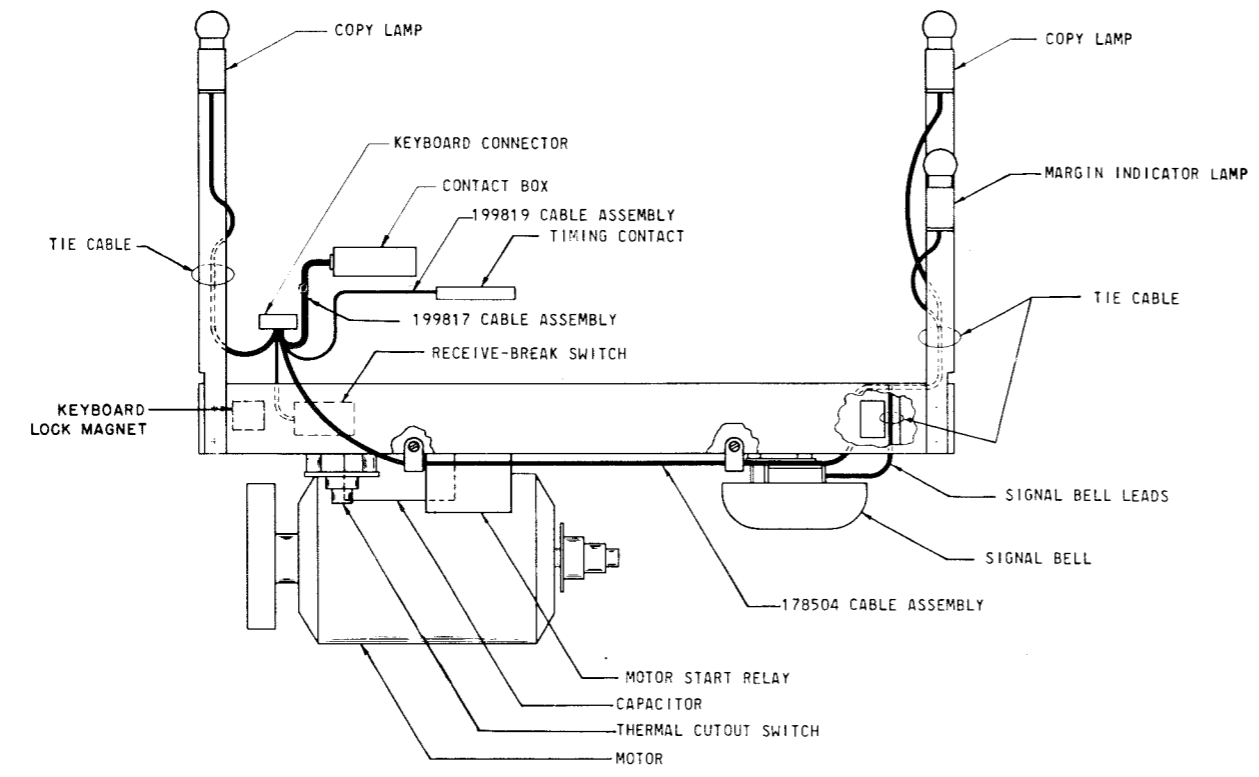

FRONT VIEW

## U MOTOR ASSEMBLY

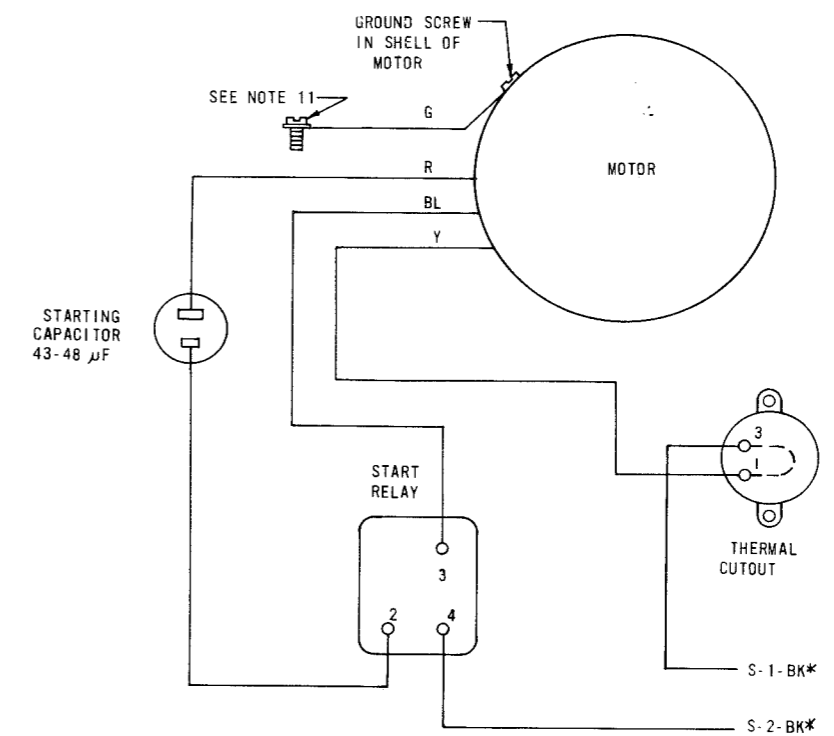

SEE ISSUE CONTROL RECORD FOR COMPLETE LIST OF SHEETS COMPRISING THIS W.D.

SHEET 2

ACTUAL WIRING DIAGRAM FOR MODEL 35 KEYBOARD BASE LK803 L 815 (WALL MOUNT)

### APPROVALS

D AND R <i>HJK</i>	E OF M <i>CH</i>
-----------------------	---------------------

E-NUMBER  
 PROD. NO. 6005WD  
 DATE 2-5-63  
 P.D. FILE NO. 1-30.151AA  
 DRAWN JJK CHKD. RHH  
 ENGD. WTC APPD. TIP

TELETYPE CORPORATION

# 6005 WD