

NAVSHIPS 91146

INSTRUCTION BOOK
for
TEST-TOOL SET
AN/USM-3

RADIO FREQUENCY LABORATORIES, INC.

BOONTON, NEW JERSEY

BUREAU OF SHIPS

NAVY DEPARTMENT

Contract: NObsr-42100

Approved by BuShips: 12 JAN 1949

LIST OF EFFECTIVE PAGES

PAGE NUMBERS	CHANGE IN EFFECT	PAGE NUMBERS	CHANGE IN EFFECT
Title page	Original	4-1 to 4-12	Original
A to C	Original	5-1 to 5-14	Original
i to v	Original	6-1 to 6-28	Original
1-0 to 1-7	Original	i-1 to i-4	Original
2-0 to 2-3	Original		
3-0	Original		

ADDRESS NAVY DEPARTMENT
BUREAU OF SHIPS

REFER TO FILE NO.

NAVY DEPARTMENT
BUREAU OF SHIPS
WASHINGTON 25, D. C.



Code 993-100

12 January 1949

To: All Activities concerned with the
Installation, Operation and Maintenance
of the Subject Equipment.

Subj: Instruction Book for Test-Tool Set
AN/USM-3, NAVSHIPS 91146.

1. NAVSHIPS 91146 is the instruction book for the subject equipments and is in effect upon receipt.
2. When superseded by a later edition, this publication shall be destroyed.
3. Extracts from this publication may be made to facilitate the preparation of other Navy instruction books and handbooks.
4. All requests for NAVSHIPS Electronics publications should be directed to the nearest District Publications and Printing Office. When revised books are distributed, notice will be included in the applicable maintenance bulletin and the ELECTRON Magazine.

E. W. MILLS
Chief of Bureau

FROM BUREAU OF SHIPS

TABLE OF CONTENTS

SECTION 1—GENERAL DESCRIPTION		SECTION 4—OPERATION, CONT'D	
<i>Paragraph</i>	<i>Page</i>	<i>Paragraph</i>	<i>Page</i>
1. Instruction Book Coverage.....	1-1	3. Signal Tracer TS-673/U.....	4-7
2. Purpose and Basic Principles.....	1-1	a. Limitations.....	4-7
3. Description of Units.....	1-1	b. Operation of Signal Tracer TS-673/U.....	4-7
4. Reference Data.....	1-5	c. Typical Applications.....	4-7
SECTION 2—THEORY OF OPERATION		4. Interference Generator SG-23/U.....	4-9
1. General Description of Circuits.....	2-0	a. Limitations.....	4-9
a. Basic Circuits of Tube Tester.....	2-0	b. Operation of Interference Generator SG-23/U.....	4-9
b. Method of Measurement Using Tube Tester TV-4/U.....	2-1	c. Typical Applications.....	4-9
c. Capacity Meter Section of Tube Tester TV-4/U.....	2-2	5. Voltage Indicator-Probe ID-265/U.....	4-9
d. Basic Circuit of Signal Tracer TS-673/U....	2-2	a. Limitations.....	4-9
e. Basic Circuit of Interference Generator SG-23/U.....	2-3	b. Operation of Voltage Indicator-Probe ID- 265/U.....	4-10
f. Basic Circuit of Voltage-Indicator Probe ID-265/U.....	2-3	c. Typical Applications.....	4-10
g. Circuit of RF Indicator-Probe ID-263/U....	2-3	6. RF Indicator-Probe ID-263/U.....	4-10
h. Circuit of Resistance Indicator-Probe ID-264/U.....	2-3	a. Limitations.....	4-10
SECTION 3—INSTALLATION		b. Operation of RF Indicator-Probe ID-263/U.....	4-10
1. Unpacking Instructions.....	3-0	c. Typical Applications.....	4-10
2. Preparation for Use.....	3-0	7. Resistance Indicator-Probe ID-264/U.....	4-11
3. Replacement of Units in Case.....	3-0	a. Limitations.....	4-11
SECTION 4—OPERATION		b. Operation of Resistance Indicator-Probe ID-264/U.....	4-11
1. Introduction.....	4-1	c. Typical Applications.....	4-11
2. Tube Tester TV-4/U.....	4-1	8. Decade Resistor TS-672/U and Decade Cap- acitor TS-671/U.....	4-11
a. Capabilities and Limitations.....	4-1	a. Limitations.....	4-11
b. Preliminary Operation.....	4-2	b. Operation of Decade Resistor and Decade Capacitor.....	4-11
c. Detailed Operating Procedure.....	4-2	c. Typical Applications.....	4-12
(1) Testing Normal Types.....	4-3	SECTION 5—MAINTENANCE	
(2) Testing Battery Types.....	4-3	1. Tube Tester TV-4/U.....	5-2
(3) Testing Diodes.....	4-3	a. Preliminary Tests.....	5-2
(4) Testing Special Types.....	4-3	b. Disassembly.....	5-2
(5) Testing Center Tap Filament Types.....	4-3	c. Detailed checks.....	5-3
(6) Norm. Rev. Toggle Switch.....	4-3	2. Signal Tracer TS-673/U Trouble Shooting.....	5-8
(7) Tube Data Chart Symbols.....	4-3	3. Interference Generator SG-23/U Trouble Shooting.....	5-9
(8) Open Element Test.....	4-3	4. Voltage Indicator-Probe ID-265/U, Dis- assembly.....	5-12
d. Summary of Operation for Tube Tester TV-4/U.....	4-4	5. RF Indicator-Probe ID-263/U, Disassembly....	5-12
e. Method of Establishing Tube Data.....	4-4	6. Resistance Indicator-Probe ID-264/U, Dis- assembly and Repair.....	5-12
f. Operation of Capacity Meter Section of Tube Tester TV-4/U.....	4-5	7. Repair of Decade Resistor TS-672/U and Decade Capacitor TS-671/U.....	5-12
g. Typical Applications.....	4-6	SECTION 6—PARTS LISTS	
		1. General.....	6-1

LIST OF ILLUSTRATIONS

SECTION 1—GENERAL DESCRIPTION

<i>Figure</i>	<i>Title</i>	<i>Page</i>
1-1	Test-Tool Set AN/USM-3, Identification of Units.....	1-0
1-2	Tube Tester TV-4/U, Identification of Controls on Control Panel.....	1-1
1-3	Signal Tracer TS-673/U, Test Prod MX-933/U, Test Prod MX-934/U, RF Cable Assembly CG-570/U (3'0"), Navy Type CTE-491898 Telephone Receiver, Navy Type CAOR-491901 Headband and Navy Type CQG-62472 Power Cable Assembly; Identification of Units.....	1-2
1-4	Interference Generator SG-23/U and Navy Type CAOR-491895 Electrical Lead, Identification.....	1-3
1-5	Voltage Indicator-Probe ID-265/U and Navy Type CAOR-491899-A Electrical Lead, Identification.....	1-3
1-6	RF Indicator-Probe ID-263/U, Identification...	1-3
1-7	Resistance Indicator-Probe ID-264/U, Identification.....	1-4
1-8	Decade Resistor TS-672/U, Identification.....	1-4
1-9	Decade Capacitor TS-671/U, Identification.....	1-4

SECTION 2—THEORY OF OPERATION

2-1	Simplified Schematic, Tube Test Section of Tube Tester.....	2-0
2-2	Simplified Schematic, Capacity Meter Section of Tube Tester.....	2-2
2-3	Simplified Schematic, Signal Tracer.....	2-2
2-4	Simplified Schematic, Interference Generator	2-3

SECTION 3—INSTALLATION

3-1	Resistance Indicator-Probe, Method of Removing Clamping Ring.....	3-0
3-2	Resistance Indicator-Probe, Disassembled....	3-0
3-3	Interference Generator, Disassembled.....	3-0

SECTION 4—OPERATION

4-1	Curves, Capacity Reading Corrections for Various Power Line Frequencies for Capacity Meter Section of Tube Tester.....	4-1
4-2	Tube Tester in Operating Position.....	4-2

SECTION 4—OPERATION, CONT'D

<i>Figure</i>	<i>Title</i>	<i>Page</i>
4-3	Resistance Curve for Capacity Meter Section...	4-6
4-4	Inductance Curve for 60 cycles.....	4-6
4-5	Inductance Curve for 400 cycles.....	4-6
4-6	Detecting Signal in IF Stage of Radio Receiver with Signal Tracer and Test Prod MX-934/U.....	4-8
4-7	Curve Showing Modulated RF, IF Voltage Input to Test Prod MX-934/U vs. AC Output Voltage.....	4-8
4-8	Using the Interference Generator for Testing an RF Tuned Circuit.....	4-9
4-9	Measuring Line Voltage on Transformer with Voltage Indicator-Probe.....	4-10
4-10	Checking RF Output of Radio Transmitter at Antenna with RF Indicator-Probe.....	4-11
4-11	Checking an Electrolytic Capacitor in a Radio Receiver with Resistance Indicator-Probe.....	4-11
4-12	Substituting Decade Resistor and Decade Capacitor in Electronic Circuit.....	4-12

SECTION 5—MAINTENANCE

5-1	Failure Report, Sample Form.....	5-1
5-2	Side View of Tube Tester, Case Removed.....	5-2
5-3	Angle View of Tube Tester, Case Removed....	5-2
5-4	Rear View of Socket Panel of Tube Tester....	5-3
5-5	Front View of Sockets Showing Pin Numbers....	5-3
5-6	Schematic Diagram of Tube Tester.....	5-4
5-7	Wiring Diagram of Tube Tester.....	5-5
5-8	Rear View Front Panel, Signal Tracer.....	5-9
5-9	Top View Signal Tracer Chassis.....	5-9
5-10	Bottom View, Signal Tracer Chassis.....	5-9
5-11	Schematic Diagram, (1) Signal Tracer TS-673/U, (2) Test Prod MX-933/U, (3) RF Cable Assembly CG-570/U (3'0"), and (4) Test Prod MX-934/U.....	5-10
5-12	Wiring Diagram of Signal Tracer.....	5-11
5-13	Schematic Diagram, Interference Generator ...	5-12
5-14	Schematic Diagram, Voltage Indicator-Probe	5-12
5-15	Schematic Diagram, RF Indicator-Probe....	5-12
5-16	Schematic Diagram, Resistance Indicator-Probe.....	5-12
5-17	Schematic Diagram, Decade Resistor.....	5-13
5-18	Schematic Diagram, Decade Capacitor.....	5-13

LIST OF TABLES

SECTION 1—GENERAL DESCRIPTION

1-1	Vacuum Tube Complement.....	1-5
1-2	Battery Complement.....	1-5
1-3	Equipment Supplied.....	1-6
1-4	Technical Summary.....	1-7

SECTION 4—OPERATION

4-1	Toggle Switch & Socket Connections.....	4-5
4-2	Voltage & Current Output from Tube Tester...	4-7

SECTION 5—MAINTENANCE

5-1	Resistance Table for Tube Tester.....	5-6
5-2	Point-to-Point Voltages on Tube Tester for T-101 and Line Short Check Circuits.....	5-7

SECTION 5—MAINTENANCE, CONT'D

5-3	Point-to-Point Voltages on Tube Tester for Filament and Socket Wiring.....	5-8
5-4	Point-to-Point Voltages, Signal Tracer.....	5-9
5-5	Tube Operating Voltages and Currents.....	5-13
5-6	Tube Characteristics.....	5-13
5-7	Winding Data.....	5-14

SECTION 6—PARTS LISTS

6-1	List of Major Units.....	6-1
6-2	Combined Parts and Repair Parts List.....	6-2
6-3	Cross Reference Parts List.....	6-25
6-4	Color Codes and Miscellaneous Data.....	6-27
6-5	List of Manufacturers.....	6-28

GUARANTEE

The equipment, including all parts and spare parts, except vacuum tubes, batteries, rubber and material normally consumed in operation, is guaranteed for a period of one year from the date of delivery of the equipment to and acceptance by the Government with the understanding that all such items found to be defective as to material, workmanship or manufacture will be repaired or replaced, f.o.b. any point within the continental limits of the United States designated by the Government, without delay and at no expense to the Government; provided that such guarantee will not obligate the Contractor to make repair or replacement of any such defective items unless the defect appears within the aforementioned period and the Contractor is notified thereof in writing within a reasonable time and the defect is not the result of normal expected shelf life deterioration.

To the extent the equipment, including all parts and spare parts, as defined above, is of the Contractor's design or is of a design selected by the Contractor, it is also guaranteed, subject to the foregoing conditions, against defects in design with the understanding that if ten percent (10%) or more of any such said item, but not less than two of any such item, of the total quantity comprising such item furnished under the contract, are found to be defective as to design, such item will be conclusively presumed to be of defective design and subject to one hundred percent (100%) correction or replacement by a suitably re-designed item.

All such defective items will be subject to ultimate return to the Contractor. In view of the fact that normal activities of the Naval Service may result in the use of equipment in such remote portions of the world or under such conditions as to preclude the return of the defective items for repair or replacement without jeopardizing the integrity of Naval communications, the exigencies of the Service, therefore, may necessitate expeditious repair of such items in order to prevent extended interruption of communications. In such cases the return of the defective items for examination by the Contractor prior to repair or replacement will not be mandatory. The report of a responsible authority, including details of the conditions surrounding the failure, will be acceptable as a basis for affecting expeditious adjustment under the provisions of this contractual guarantee.

The above one year period will not include any portion of time the equipment fails to perform satisfactorily due to any defects, and any items repaired or replaced by the Contractor will be guaranteed anew under this provision.

INSTALLATION RECORD

Contract Number NObsr-42100	Date of Contract, 17 February 1948
<i>Serial Number of equipment</i>	
<i>Date of acceptance by the Navy</i>	
<i>Date of delivery to contract destination</i>	
<i>Date of completion of installation</i>	
<i>Date placed in service</i>	

Blank spaces on this page shall be filled in at time of installation. Operating personnel shall also mark the "date placed in service" on the date of acceptance place located below the model nameplate on the equipment, using suitable methods and care to avoid damaging the equipment.

REPORT OF FAILURE

Report of failure of any part of this equipment, during its entire service life, shall be made to the Bureau of Ships in accordance with current regulations using form NAVSHIPS NBS 383 (revised). The report shall cover all details of the failure and give the date of installation of the equipment. For procedure in reporting failures see Chapter 67 of the Bureau of Ships Manual or superseding instructions.

ORDERING PARTS

All requests or requisitions for replacement material should include the following data:

1. Federal stock number or, when ordering from a Marine Corps or Signal Corps supply depot, the Signal Corps stock number.
2. Name and short description of part.

If the appropriate stock number is not available the following shall be specified:

1. Equipment model or type designation, circuit symbol, and item number.
2. Name of part and complete description.
3. Manufacturer's designation.
4. Contractor's drawing and part number.
5. JAN or Navy type number.

SAFETY NOTICE

The attention of officers and operating personnel is directed to Chapter 67 of the Bureau of Ships Manual or superseding instructions on the subject of radio-safety precautions to be observed.

This equipment employs voltages which are dangerous and may be fatal if contacted by operating personnel. Extreme caution should be exercised when working with the equipment.

While every practicable safety precaution has been incorporated in this equipment, the following rules must be strictly observed:

KEEP AWAY FROM LIVE CIRCUITS:

Operating personnel must at all times observe all safety regulations. Do not change tubes or make adjustments inside equipment with high voltage supply on. Under certain conditions dangerous potentials may exist in circuits with power controls in the off position due to charges retained by capacitors. To avoid casualties always remove power and discharge and ground circuits prior to touching them.

DON'T SERVICE OR ADJUST ALONE:

Under no circumstances should any person reach within or enter the enclosure for the purpose of servicing or adjusting the equipment without the immediate presence or assistance of another person capable of rendering aid.

DON'T TAMPER WITH INTERLOCKS:

Do not depend upon door switches or interlocks for protection but always shut down motor generators or other power equipment. Under no circumstances should any access gate, door, or safety interlock switch be removed, short-circuited, or tampered with in any way, by other than authorized maintenance personnel, nor should reliance be placed upon the interlock switches for removing voltages from the equipment.

RESUSCITATION

AN APPROVED POSTER ILLUSTRATING THE RULES FOR RESUSCITATION BY THE PRONE PRESSURE METHOD SHALL BE PROMINENTLY DISPLAYED IN EACH RADIO, RADAR, OR SONAR ENCLOSURE. POSTERS MAY BE OBTAINED UPON REQUEST TO THE BUREAU OF MEDICINE AND SURGERY.

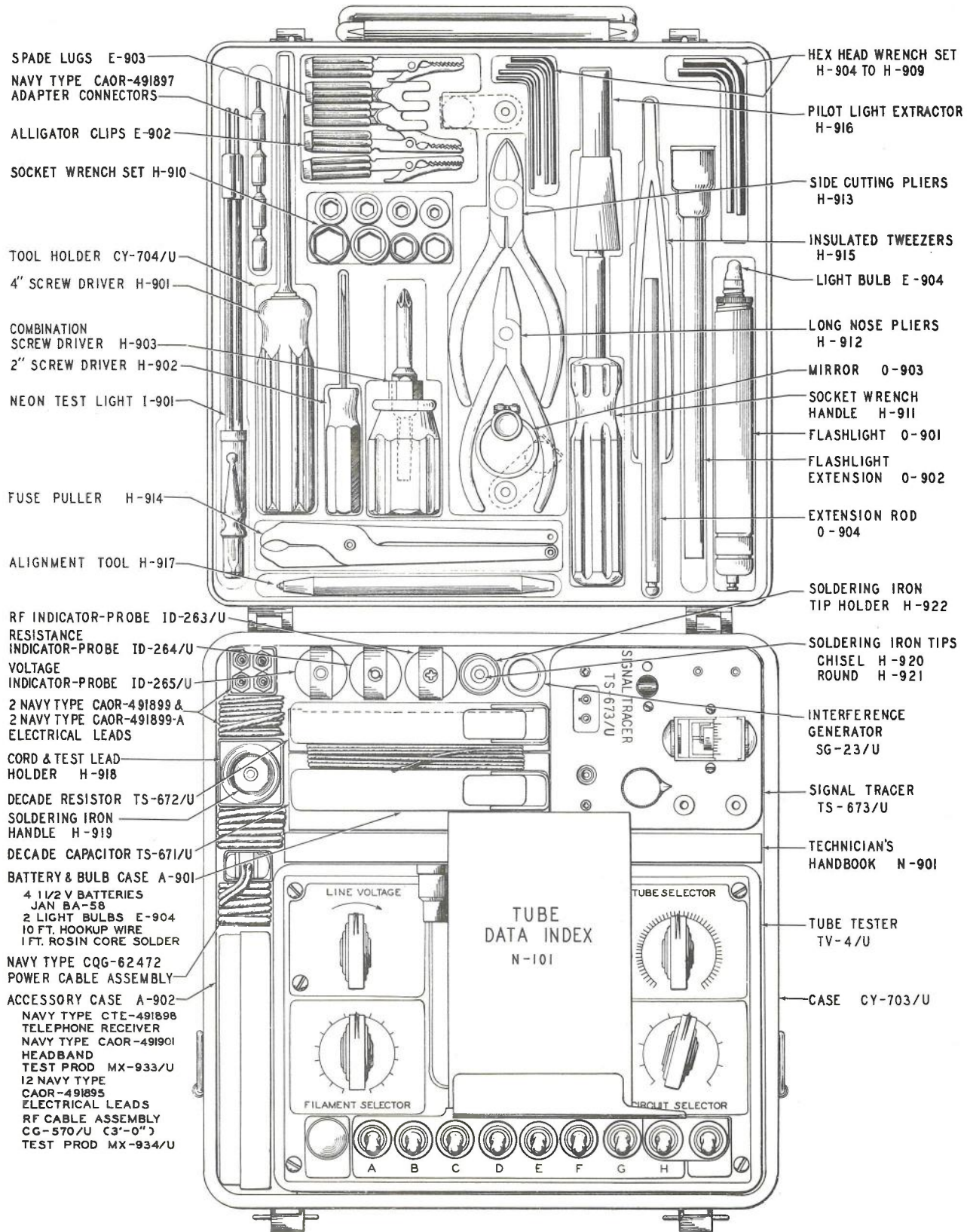

Figure 1-1. Test-Tool Set AN/USM-3, Identification of Units

**SECTION 1
GENERAL DESCRIPTION**

1. INSTRUCTION BOOK COVERAGE.

This instruction book covers Test-Tool Set AN/USM-3 as shown in figure 1-1. The units are shown in place in the carrying case.

2. PURPOSE AND BASIC PRINCIPLES.

The Test-Tool Set AN/USM-3 is designed for use as a test and repair set for general service work and emergency repair on electronic and electrical equipment. To accomplish this end, a compact, lightweight case is supplied with the items as shown in figure 1-1 fitted into it in a manner such that all items are accessible and easily located.

3. DESCRIPTION OF UNITS

a. CASE CY-703/U. (See figure 1-1.) - The Case consists of two drawn aluminum covers 9-1/2 x 9-1/2 x 3-1/2 inches which are hinged together, forming a box 7 inches deep. Latches, fittings and a handle are provided.

b. TUBE TESTER TV-4/U. (See figure 1-2.) - This unit consists of a molded bakelite control panel on which are mounted the meter and all of the controls, a socket panel for all of the tube test sockets and a wrap-around case enclosing the complete unit. Pin jacks are available at the top of the control panel for capacity readings in addition to all of the tube test functions. The complete assembly is mounted in a steel case and is pivoted on a full length hinge so that it can be raised into operating position through an angle of 45 degrees. The hinge is fastened to the front face of the Tube Tester and the front edge of the Case. A supporting arm, hinged at the bottom of the Case, holds the Tube Tester at a 45 degree angle when it is pivoted into position for operation.

Two grid leads are provided and extend from the front panel. One is a captive double-ended connector for contacting the top cap stud on metal and glass vacuum tubes, and the other is an acorn connector lead that terminates in a small, split phosphor bronze connector for attachment to the top pin of acorn tubes.

A 105 to 125 volt, AC only, 50 to 1600 cycles single phase power supply source is required. The power demand at

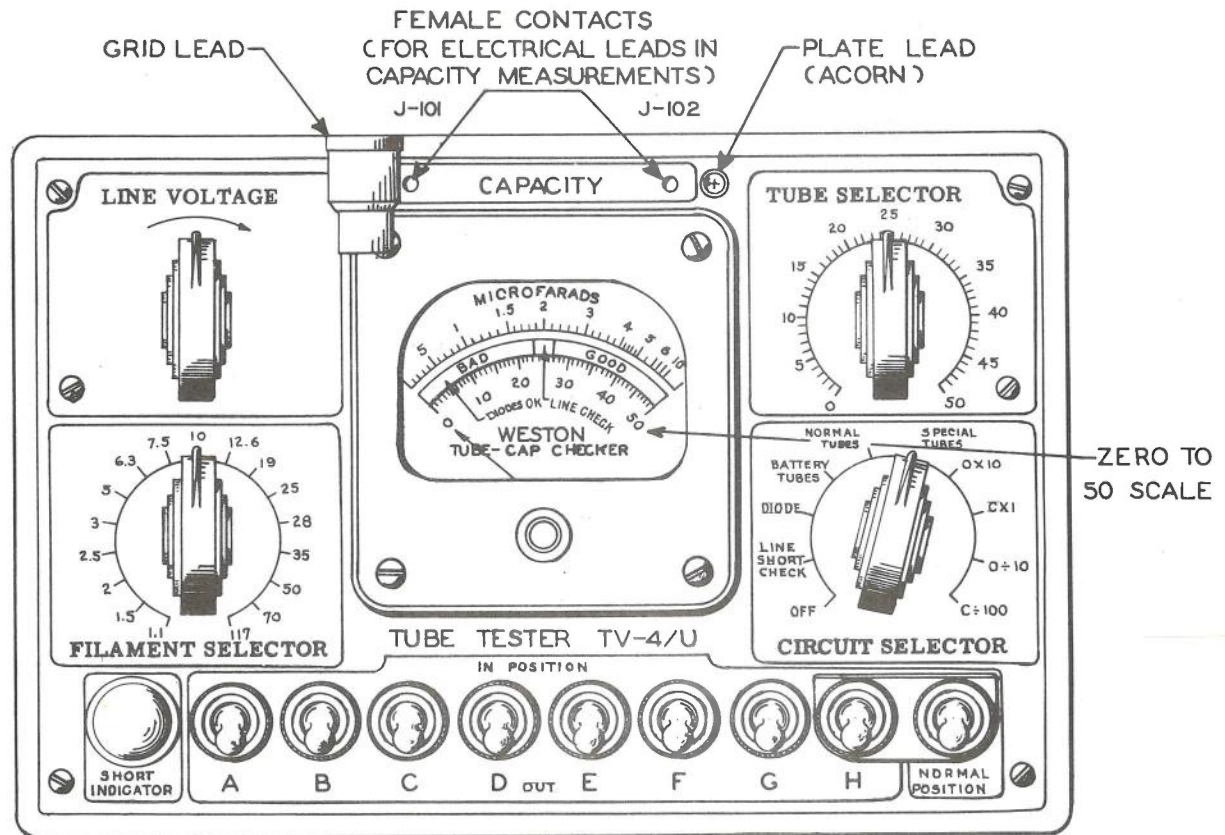

Figure 1-2. Tube Tester TV-4/U, Identification of Controls on Control Panel

115 volts is approximately 25 watts. From such a power source, tube test filament potentials at power line frequency are available in 17 steps: from 1.1 to 117 volts inclusive.

For the tube test function, two electrode potentials and four load impedances are available for diode, battery type, normal and special type tubes. One meter reversing toggle switch and eight electrode toggle switches provide the required flexibility for the total emission and individual electrode emission tests on the various tube types listed in the Tube Data Index.

The indicating meter is calibrated with three scale arcs: the top arc for capacity readings, the middle arc for tube indications in three different colors and the inside, or bottom, arc for comparative readings between different tubes of the same type. This inside arc is linear and is used for several purposes, as outlined in Section 2, paragraph 1 (b).

The Tube Data Index is a small booklet attached to the Tube Tester by a panel bracket and is folded over the front face of the Tester when not in use. When the Tube Tester is raised to the operating position, the Tube Data Index can be rotated to the right and swung forward for ready reference.

c. SIGNAL TRACER TS-673/U. (See figure 1-3.) - This equipment consists of a variable gain amplifier and output meter. A Navy Type CQG-62472 Power Cable Assembly is provided for plugging in a 105 to 125 volt, 50 to 1600 cycle AC power source. Navy Type CAOR-491899-A Electrical Leads are provided for connecting an oscilloscope, an earphone or an electronic voltmeter to the output. The RF Cable Assembly CG-570/U (3' 0") is used with Test Prod MX-934/U (for RF signals) and Test Prod MX-933/U (for audio signals). The Navy Type CAOR-491895 Electrical Lead with Navy Type CAOR-491897 Adapter Connector and Alligator Clip (E-902) are used to ground the prod.

The amplifier is capable of amplifying AC voltages from 47 to 15,000 cycles per second when used with the Test Prod MX-933/U. Audio modulation on voltages having frequencies from 15,000 cycles to 400 megacycles is detected by Test Prod MX-934/U and amplified by the Signal Tracer. The Signal Tracer is located behind the Tube Tester as shown in figure 1-1.

The Telephone Receiver, RF Cable Assembly and Test Prods are in the Accessory Case to the left of the Tube Tester (see figure 1-1) and are listed in TABLE 1-1, under Accessories.

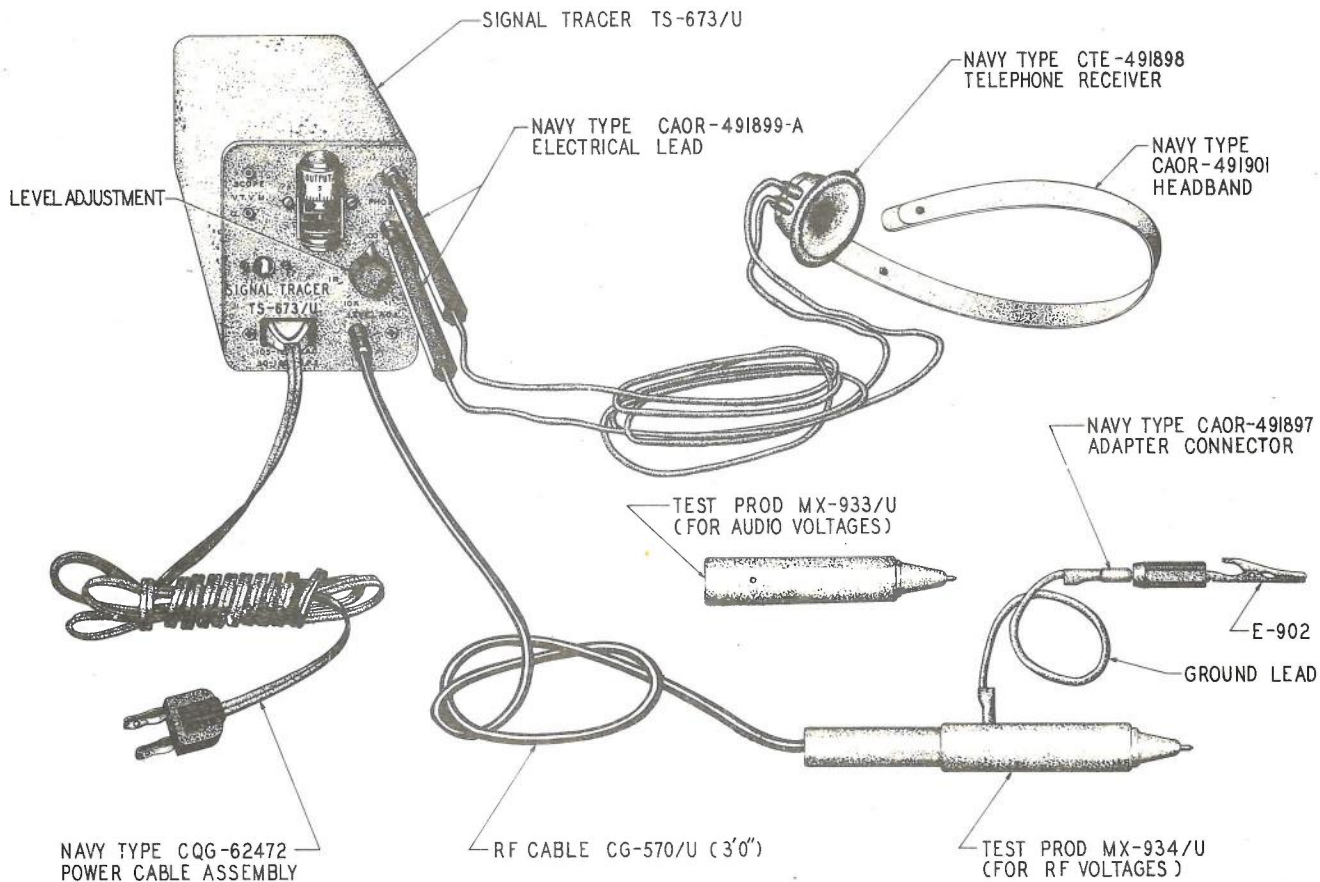

Figure 1-3. Signal Tracer TS-673, Test Prod MX-933/U, RF Cable Assembly CG-570/U (3'0"), Navy Type CTE-491898 Telephone Receiver, Navy Type CAOR-491901 Headband and Navy Type CQG-62472 Power Cable Assembly; Identification of Units

d. INTERFERENCE GENERATOR SG-23/U. (See figure 1-4.) - This unit is an aperiodic impulse buzzer type generator housed in a probe case. Pressing the button at the top connects the battery to the buzzer. The white line on the button indicates the position of the attenuator. The buzzer is connected directly to the probe tip in POSITION 1 and through a variable capacitor in POSITIONS 2 through 10. The buzzer frequency is approximately 2000 cycles per second with harmonics extending up to approximately 400 megacycles. It is used to generate audio and radio frequency voltages for test purposes. It is used with Navy Type CAOR-491895 Electrical Lead, Navy Type CAOR-491897 Adapter Connector, and alligator clip (E-902). These items are located in the Accessory Case and the Tool Holder. (See figure 1-1.)

The Interference Generator is located next to the Signal Tracer in the back of the Case as shown in figure 1-1.

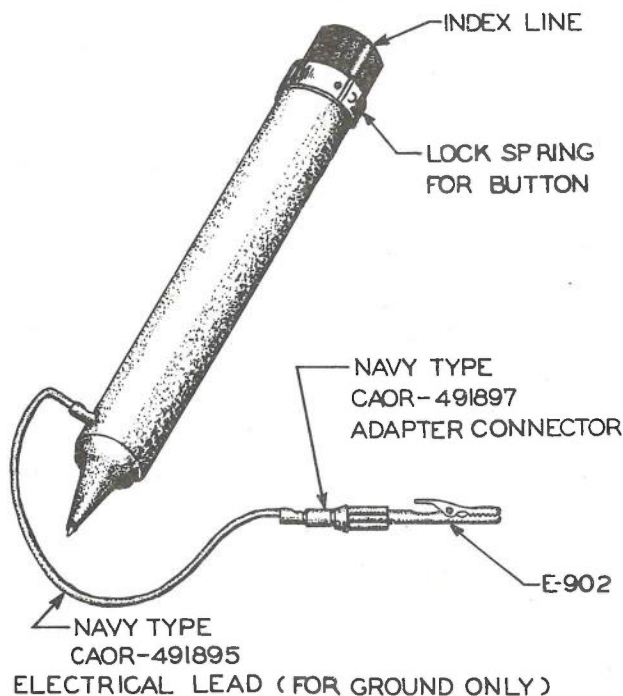

Figure 1-4. Interference Generator SG-23/U and Navy Type CAOR-491895 Electrical Lead, Identification

e. VOLTAGE INDICATOR-PROBE ID-265/U. (See figure 1-5.) - This unit is shown with its lead attached for a complete circuit. It consists of two meter elements so arranged electrically that one (M-401) indicates whether the line is AC or DC. If the line is DC, the polarity of the probe tip is indicated. The second meter movement (M-402) indicates the magnitude of the voltage. The scale is marked 0, 55, 110, 220 and 440 volts. The AC voltage measured can be in the frequency range of 10 to 10,000 cycles. The lead used with this probe is Navy Type CAOR-491899-A, which is located on the Cord and Test Lead Holder (H-918) behind the Accessory Case.

This Probe is located in the Case behind the Tube Tester. (See figure 1-1.)

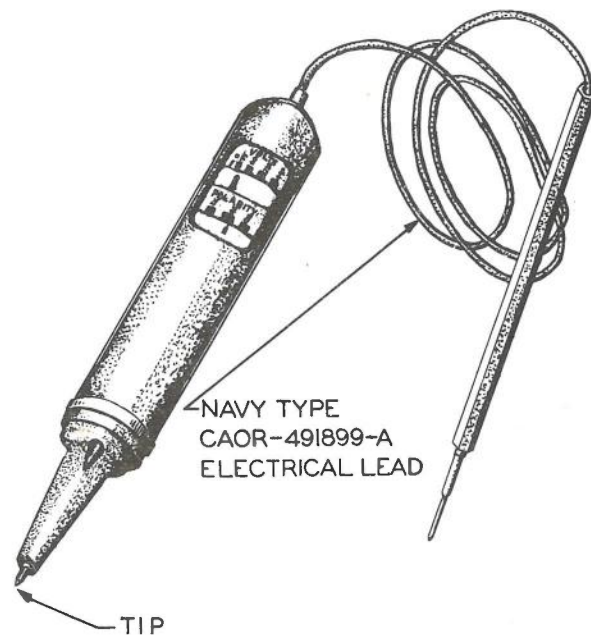

Figure 1-5. Voltage Indicator-Probe ID-265/U and Navy Type CAOR-491899-A Electrical Lead, Identification

f. RF INDICATOR-PROBE ID-263/U. (See figure 1-6.) - This unit contains a meter movement and a crystal rectifier circuit housed in a plastic body. It is used to indicate the presence of electric RF fields of relatively large magnitude. Its sensitivity is of the order of 25% of full scale when one volt of RF voltage is applied to the tip of the Probe. The hand capacitance of the operator supplies the return RF connection.

To reach into a deep chassis or into high voltage areas, the Extension Rod (O-904) is provided. This rod slips onto the tip of the Probe. When used it normally increases the sensitivity of the unit. It is stowed in the Tool Holder, and the Probe is located at the rear of the Case as shown in figure 1-1.

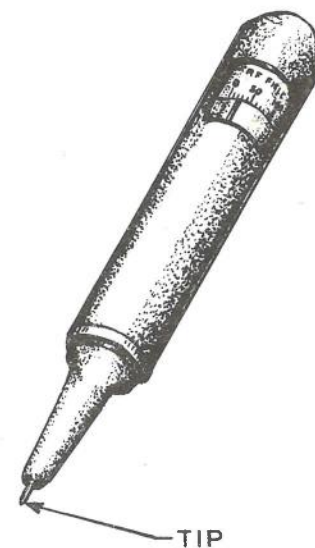

Figure 1-6. RF Indicator-Probe ID-263/U, Identification

g. RESISTANCE INDICATOR-PROBE ID-264/U. (See figure 1-7.) - Also of the probe type, this unit consists of a meter movement, a calibrating resistor and a 1-1/2 volt battery enclosed in a plastic case. The scale is marked from 0 to 10,000 ohms. The electrical connections are at the probe tip and through a test lead plugged into the top of the case. This Probe is used with Electrical Lead CAOR-491899-A, which is located on the Cord and Test Lead Holder. For its location in the Test-ToolSet refer to figure 1-1.

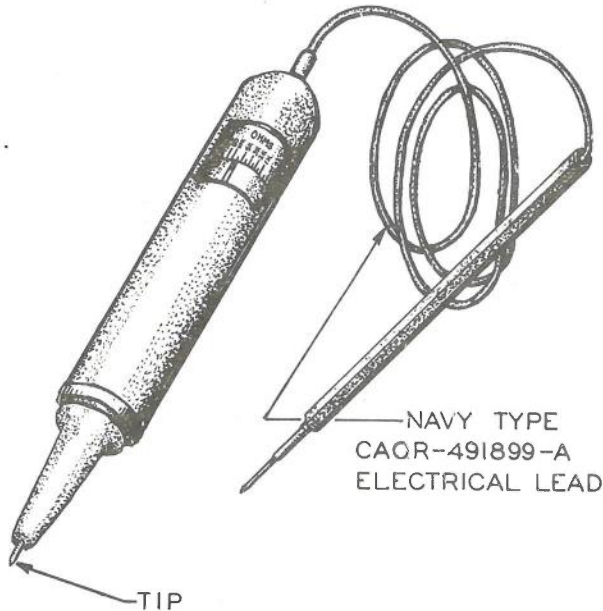

Figure 1-7. Resistance Indicator-Probe ID-264/U, Identification

h. DECADE RESISTOR TS-672/U. (See figure 1-8.) - This unit consists of a molded bakelite case housing 28 watt resistors, each insulated from the other. The values are arranged in a one, two, three, six series, from one ohm to six megohms; thus allowing any value between one ohm and 12 megohms to be obtained in steps of one ohm by connecting the proper resistors in series by means of the Navy Type CAOR-491895 Electrical Leads. Figure 1-1 shows its location in the rear of the Case.

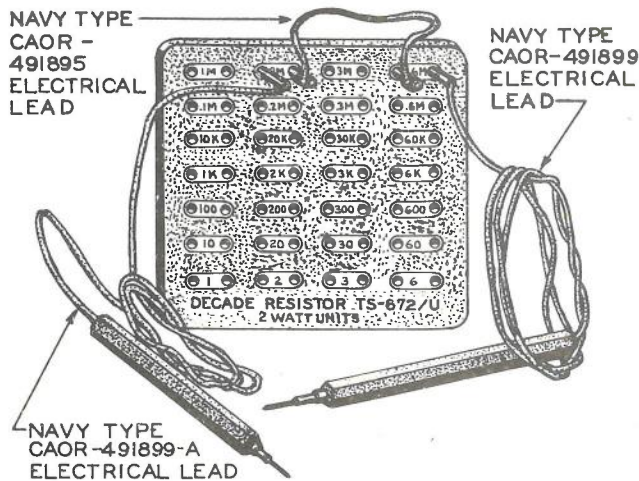

Figure 1-8. Decade Resistor TS-672/U, Identification

i. DECADE CAPACITOR TS-671/U. (See figure 1-9.) - Consisting of a molded case similar to the Decade Resistor, this unit contains a series of capacitors covering a range between 0.0001 microfarads and 48 microfarads. Individual capacitors having values of 0.0001, 0.0003, 0.001, 0.003, 0.01, 0.02, 0.1 and 0.25 microfarads, rated at 600 volts, are placed as indicated by the front panel markings. The two 20/4 microfarad electrolytic capacitors each have a common negative. Other values in the range covered can be obtained by the use of electrical leads. The Decade Capacitor is located in the Case immediately in front of the Probes as shown in figure 1-1.

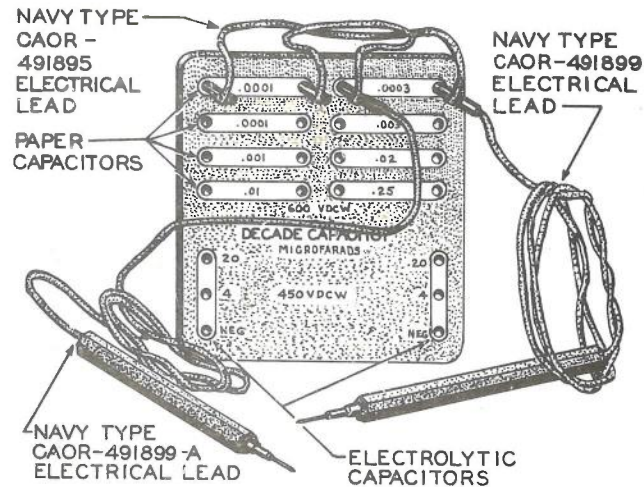

Figure 1-9. Decade Capacitor TS-671/U, Identification

j. NAVY TYPE CQG-62472 POWER CABLE ASSEMBLY. - This cable is used with the Tube Tester as a line cord or with the Signal Tracer as required. The cord is two conductor, #18AWG, 57 inches long with a male plug on one end and a female plug on the other end.

k. NAVY TYPE CAOR-491899 AND CAOR-491899-A ELECTRICAL LEADS. - These consist of two red and two black 30 inch leads with miniature banana plug terminals at one end and phone tip plugs on the other. The Navy Type CAOR-491897 Adapter Connectors fit the capacity pin jacks directly above the meter of the Tube Tester and adapt the banana plugs of these leads to the pin jacks.

l. NAVY TYPE CAOR-491897 ADAPTER CONNECTORS. - Four of these units are provided. Two are used for the capacity meter function of the Tube Tester. They are stowed in the Tool Holder CY-704/U as shown in figure 1-1. The units adapt a banana plug to a phone tip jack.

m. NAVY TYPE CAOR-491895 ELECTRICAL LEADS. - These leads are eight inches long and have a combination banana plug and female connector on each end. They are used as grounding leads for the Test Prods and as patch cords for the Decade Capacitor and Decade Resistor.

n. TOOL HOLDER CY-704/U. (See figure 1-1.) - It consists of two pressed, transparent plastic sheets with recesses provided for stowing each tool. The bottom sheet is fastened to the inside top of Case CY-703/U. The top sheet holds the tools in their respective compartments and is secured by two snap-slides. The name and standard Navy stock number of each tool appears in the bottom of its individual compartment, and all tools are installed in the top of the Case. The top sheet, or tool cover, is held by a wire when open to prevent its loss.

o. TECHNICIAN'S HANDBOOK. (See figure 1-1.) - This book is provided for ready reference on the part of the operator when making emergency repairs and includes sufficient technical data and information necessary to use the Test-Tool Set. It is located in the Case behind the Tube Tester.

p. BATTERY & BULB CASE. (See figure 1-1.) - Molded from sheet plastic, this case provides storage space for four 1-1/2 volt flashlight batteries JAN BA-58, two flashlight bulbs, 10 feet of hook-up wire and one foot of 50/50 rosin core solder.

q. TOOLS AND MINOR ITEMS. (See figure 1-1.) - The tools and items listed below are contained in the Tool Holder in the top of the Case.

- (1) Fuse puller (H-914) - flat dual size.
- (2) Pilot light extractor (H-916) - a rubber cup device to aid in the removal of pilot lamps from inaccessible locations.
- (3) Hex head wrench set (H-904 to H-909) - 0.050, 1/16, 5/64, 3/32, 1/8 and 5/32.
- (4) Insulated dental type mirror (O-903) - can be attached to Flashlight Extension (O-902) to examine areas hidden from direct view.
- (5) Insulated tweezers (H-915) - 6 inches.
- (6) Flashlight (O-901) with lucite extension (O-902).
- (7) Long nose pliers (H-912) - 4 inches.
- (8) Side cutting pliers (H-913) - 4 inches.
- (9) Socket wrench set (H-910) - 3/16, 7/32, 1/4, 9/32, 5/16, 11/32, 3/8 and 7/16 with handle (H-911).
- (10) Neon test light (I-901), 200,000 ohms impedance, 60-500 VAC and 90-500 VDC - tests for presence of voltage.
- (11) Combination screwdriver (H-903) with interchangeable 1/4 inch slot drive bit and #2 Phillips drive - stubby size.
- (12) Screwdriver (H-901) - 4 inches with 3/16 inch blade.
- (13) Screwdriver (H-902) - 2 inches with 3/32 inch blade.

- (14) Pen type soldering iron, 115 volts, 50 to 1600 cycles (with chisel tip and round point tip.)
- (15) Three alligator clips (E-902) for test leads.
- (16) Two spade lugs (E-903) for test leads.
- (17) Alignment tool (H-917) - an insulated low capacitance screwdriver for adjusting variable trimmer capacitors.
- (18) Extension rod (O-904) for use with all Probe units. It has a metal center conductor and plastic exterior. A removable insulating cover is provided for use with the RF Indicator-Probe ID-263/U for Test Prod MX-934/U.

4. REFERENCE DATA.

- a. NOMENCLATURE. - Test-Tool Set AN/USM-3.
- b. CONTRACT. - NObSr-42100, dated 17 February 1948.
- c. CONTRACTOR. - Radio Frequency Laboratories, Inc. Boonton, New Jersey.
- d. COGNIZANT NAVAL INSPECTOR. - Inspector of Navy Material, Newark, New Jersey.
- e. PACKAGES PER COMPLETE SHIPMENT. - One.
- f. CUBICAL CONTENTS. - 5.9 cu. ft. crated; 0.75 cu. ft. uncrated.
- g. TOTAL WEIGHTS. - 53 lbs. crated; 23 lbs. uncrated.
- h. POWER SUPPLY. - Signal Tracer TS-673/U and Tube Tester TV-4/U require 105 to 125 volts at 50 to 1600 cycles. Interference Generator SG-23/U and Resistance Indicator - Probe ID-264/U each require a self-contained 1-1/2 volt battery JAN BA-58.
- i. POWER CONSUMPTION. - Signal Tracer TS-673/U consumes 7 watts. Tube Tester TV-4/U consumes 25 watts at 115 volts, 60 cycles.

TABLE 1-1. VACUUM TUBE COMPLEMENT

UNIT	SYMBOL DESIG.	TUBE TYPE
Tube Tester TV-4/U	V101	3A4
Signal Tracer TS-673/U	V201 V202 V203	12AX7 12AX7 6AL5

TABLE 1-2. BATTERY COMPLEMENT

UNIT	JAN TYPE	STANDARD NAVY STOCK NUMBER	VOLT- AGE	SIZE		NO. REQ.
				DIA.	LENGTH	
Flashlight	BA-58	17-F-13468-850	1-1/2	35/64	1-31/32	2
Interference Generator	BA-58	16-G-59001-1001	1-1/2	35/64	1-31/32	1
Resistance Indicator-Probe	BA-58	17-P-84841-1831	1-1/2	35/64	1-31/32	1

TABLE 1-3. EQUIPMENT SUPPLIED

QUAN- TITY PER EQUIP- MENT	NAME OF UNIT	NAVY TYPE DESIGNA- TION	OVER-ALL DIMENSIONS			VOL- UME	WEIGHT
			HEIGHT	WIDTH	DEPTH		
	MAJOR UNITS:						
1	Case	CY-703/U	7	9-3/4	10-1/2	0.42	5.0
1	Tool Holder	CY-704/U	3/4	9-1/4	9-1/4	0.037	
1	Tube Tester	TV-4/U	5-1/2	8-1/4	5-1/2	0.145	9.0
1	Signal Tracer	TS-673/U	3-1/2	3	5-3/4	0.035	2.0
1	Interference Generator	SG-23/U		3/4 D	5-3/4		
1	Voltage Indicator-Probe	ID-265/U		1 D	6		
1	RF Indicator-Probe	ID-263/U		1 D	6		
1	Resistance Indicator-Probe	ID-264/U		1 D	6		
1	Decade Resistor	TS-672/U	3/4	4-3/4	4-3/8	0.009	
1	Decade Capacitor	TS-671/U	1-1/4	4-3/8	4-3/4	0.015	
	ACCESSORIES:						
1	Test Prod	MX-933/U					
1	Test Prod	MX-934/U					
1	RF Cable Assembly	CG-570/U (3'0")					
1	Telephone Receiver	CTE-491898					
1	Headband	CAOR-491901					
1	Power Cable Assembly	CQG-62472					
2	Electrical Lead (red)	CAOR-491899					
2	Electrical Lead (black)	CAOR-491899-A					
4	Adapter Connector	CAOR-491897					
12	Electrical Lead	CAOR-491895					
1	Extension Rod						
1	Cord & Test Lead Holder						
1	Battery & Bulb Case (w/2 bulbs, 10' of hook-up wire and 1' of solder)						
1	Accessory Case						
1	Technician's Handbook						
1	Tube Data Index						
	TOOLS:						
3	Alligator Clips						
2	Spade Lugs						
1	Screwdriver (4-inch)						
1	Screwdriver (2-inch)						
1	Combination Screwdriver						
1	Hex Head Wrench Set (0.050, 1/16, 5/64, 3/32, 1/8, 5/32)						
1	Socket Wrench Set						
1	Socket Wrench Handle						
1	Long Nose Pliers						
1	Side Cutting Pliers						
1	Fuse Puller						
1	Insulated Tweezers						
1	Pilot Light Extractor						
1	Alignment Tool						
1	Soldering Iron Handle						
1	Soldering Iron Tip (Chisel)						
1	Soldering Iron Tip (Round)						
1	Soldering Iron Tip Holder						
1	Neon Test Light						
1	Flashlight						
1	Flashlight Extension						
1	Mirror						
1	Instruction Book	NAVSHIPS 91146					

Unless otherwise stated, dimensions are inches, volume cubic feet, weight pounds.

TABLE 1-4. TECHNICAL SUMMARY

ORIGINAL

GENERAL DESCRIPTION

NAVSHIPS 91146 AN/USM-3

Section 1

TUBE TESTER TV-4/U	Power supply:	105-125 volts, 50 to 1600 cycles.	RF INDICATOR- PROBE ID/263/U	Useful frequency range:	100 KC to 400 megacycles per second.
	Power consumption:	25 watts at 115 volts and 60 cycles.		Sensitivity:	25% full scale for one volt RF direct connected.
	Measurements:	(1) Tests all tubes listed in Tube Data Index for filament continuity, emission, shorted elements and open elements. (2) Capacities from 0.001 to 100 microfarads when operated from 60 cycle per sec. power supply. See figure 4-1.		Sensitivity, approx., with extension rod in RF field:	5 volts/meter for 25% full scale.
SIGNAL TRACER TS-673/U	Power supply:	105-125 volts, 50 to 1600 cycles.	RESISTANCE INDICATOR- PROBE ID-264/U	Max RF signal:	10 volts across crystal diode.
	Power consumption:	7 watts.		Measurements:	0 to 10,000 ohms.
	AF range:	47 to 15,000 cycles per sec.		Power supply:	1-1/2 volt battery JAN BA-58.
	RF range:	Audio modulated signals 15 KC to 400 megacycles per sec.	DECADE RESISTOR TS-672/U	Power rating:	Two watts per resistor. 10 watts for unit.
	Audio sensitivity:	0.002 volts audible in earphone. 0.004 volts for 1/2 scale M-201.		Tolerance:	± 5%.
	RF sensitivity:	0.005 volts of 50% modulated RF audible in earphone. 0.05 volts of 50% modulated RF for 1/2 scale M-201.		Range:	One ohm to 12 megohms in one ohm steps.
INTERFERENCE GENERATOR SG-23/U	Power supply:	1-1/2 volts battery, JAN BA-58.	DECADE CAPACITOR TS-671/U	Range:	0.0001 to 48 microfarads.
	Current:	0.2 amps.		Tolerance (paper):	± 10%.
	Frequency:	Audio approx. 2000 cycles per sec. Harmonics to approx. 400 megacycles per sec.		Voltage rating (paper):	500 volts DC.
VOLTAGE INDICATOR- PROBE ID-265/U	Measurements:	(1) 0-440 volts AC or DC. (2) DC polarity.	TEST PROD MX-934/U	Tolerance (electrolytic):	-0 +75%.
	Frequency range AC:	10 to 10,000 cycles per second.		Voltage rating (electrolytic):	450 volts DC.
	Impedance:	500,000 ohms.		Maximum RF signal:	20 volts.
				Voltage rating:	300 volts DC.
				Maximum AF signal:	100 volts.
		Voltage rating:	400 volts DC.		
		Input resistance:	One megohm.		
		Input capacitance:	0.0001 microfarads.		

1-7

SECTION 2 THEORY OF OPERATION

1. GENERAL DESCRIPTION OF CIRCUITS.

a. BASIC CIRCUITS OF TUBE TESTER TV-4/U. (See figure 2-1.) - The major circuit sections of the Tube Tester are shown in the Simplified Schematic, Tube Test Section. Energy for all tube elements is supplied by the power transformer through the FILAMENT, CIRCUIT and TUBE selectors to the socket panel. For purposes of explanation, the unit can be subdivided into the following basic circuit sections.

(1) POWER TRANSFORMER. - Supplies all potentials for the tube test functions as well as for the capacity meter ranges. Basically this transformer consists of a primary winding and three secondary sections with a total of 29 terminals. All windings are accurately wound; so that a single line control of the potentiometric type in the primary circuit can be used to adjust all of the secondary voltages.

(2) FILAMENT SELECTOR. - This consists of a 17-position switch with each contact connected to a transformer tap on the filament winding. Filament voltages can thus be individually selected in steps from 1.1 volts to 117 volts by rotating the switch knob. The operator should realize that it is important to index this switch correctly as the first operation in testing a tube.

NOTE

Excessive filament voltage will, in most cases, burn out the filament or ruin the tube.

(3) CIRCUIT SELECTOR. - The circuit selector is a 10-position rotary switch and performs the following functions.

(a) On-off switch for energizing or disconnecting the Tube Tester from the line circuit.

(b) Connects the indicating meter into the line check circuit for line voltage reading.

(c) Applies potential to the short test circuit to energize the neon short indicator lamp.

(d) Selects four different load resistances and voltage combinations for diodes, battery types, normal and special types.

(e) Connects the indicating meter into the capacity meter network, as shown in the simplified schematic (figure 2-2), and is used on four positions to select the required capacity range. The switch is so designed that the Tube Tester transformer will be energized on all switch positions except the first position marked OFF.

(4) TUBE SELECTOR. - This is a wire-wound potentiometer used for controlling the sensitivity of the indica-

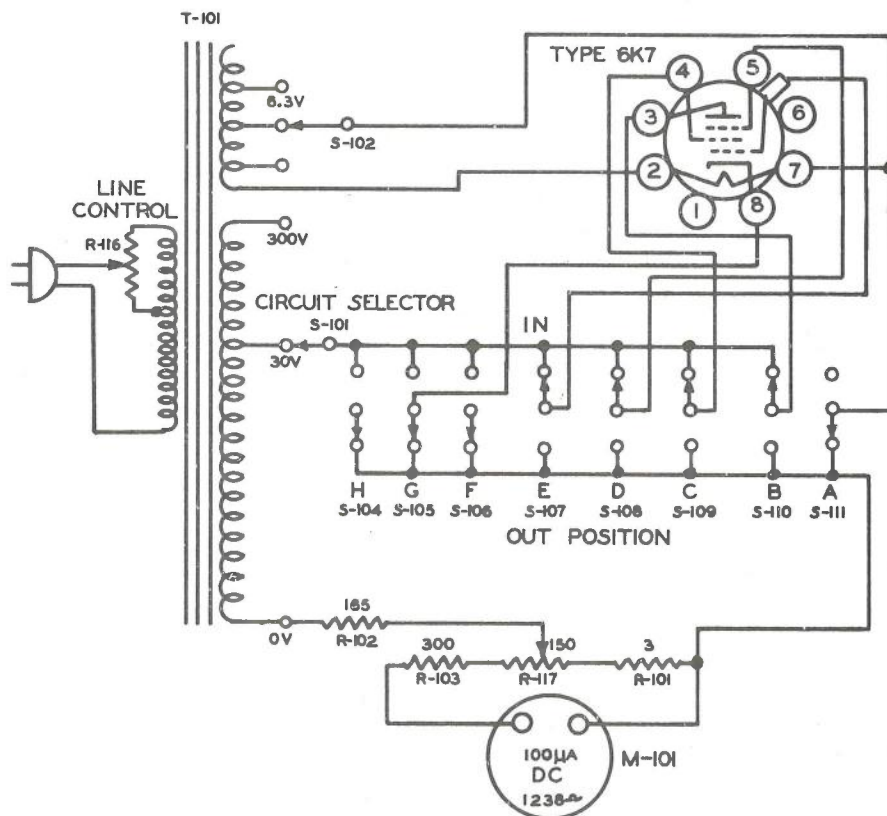

Figure 2-1. Simplified Schematic, Tube Test Section of Tube Tester

ting meter for all tube test emission readings. This control must always be indexed to a definite number on the zero to 50 scale in accordance with the Tube Data Index number in the column marked Tube Selector. A wide range of adjustment is necessary on this sensitivity control due to the large variation in different types of vacuum tubes.

(5) ELECTRODE SWITCHES. - As shown in figure 2-1, these switches connect between the socket panel and the electrode energizing circuits, with the exception of the filament circuit. Filament current is not fed through these switches. The switches are used individually or in groups for both tube tests and short tests. The first electrode switch marked A is used particularly for the cathode leakage test on indirectly heated tubes. The other electrode switches marked B through H are each connected to a socket terminal and control the energization of that terminal. One switch is used for each active tube element. A table showing the socket terminal controlled by each switch is listed in Section 4. The lower right-hand switch marked NORMAL POSITION in figure 1-2 is the meter reversing switch indicated in figure 2-1. It is only used for tests on three or four particular tubes.

(6) SOCKET PANEL. - The socket panel is actually a separate subassembly and is wired and tested as a complete unit before assembly in the Tube Tester. All thirteen socket terminals are wired directly to a single terminal strip which in turn connects to the electrode switches as shown in figure 2-1. The regular sockets are not lettered and are always used where foot-notes are not listed in the Tube Data Index. There is one regular socket available for each mechanical type of tube base including the miniature nine pin and acorn types. Where peculiar or unusual electrical characteristics are encountered, a †† appears after the tube number indicating that the tube should be tested in the A socket, or a ⊕ may be listed to indicate that the B socket should be used. These special sockets are mounted on the test panel in a row near the bottom of the tube tester. A combination socket near the left-hand edge of the socket panel is used for testing all four prong, five prong and six prong tubes. The large seven pin socket, next in line, will accommodate both large and small diameter seven pin bases. The acorn socket is designed to take five and seven radial pin acorn tubes with or without axial contacts. Octal, loctal, miniature seven and nine pin sockets are also available.

(7) SHORT TEST CIRCUIT. - The short test circuit consists of a transformer winding in series with a rectifier which supplies the DC current required for the short indicator and also for the line check reading. Since the indicating meter is a DC milliammeter, a rectifier is required between the transformer and the meter. This rectifier is a type 3A4 miniature tube (V-101) connected as a diode. It is mounted inside the equipment with the other components and, in conjunction with a resistance capacitance filter, supplies DC potential for both short test and line check functions.

(8) LINE VOLTAGE CONTROL. - This is a power type potentiometer for adjusting all test potentials.

(9) INDICATING METER. - This meter is basically a DC milliammeter operating in conjunction with the vacuum tube rectifier for line check reading. It functions with a full-wave copper-oxide rectifier for capacity readings and is used directly as a DC milliammeter for tube test readings.

b. METHODS OF MEASUREMENT USING TUBE TESTER TV-4/U. - Most tube failures are due to one or more of the following defects.

- (1) An inter-electrode short.
- (2) Low cathode to heater resistance, also referred to

as cathode leakage.

- (3) Poor electron emission from heater or cathode.
- (4) Open element connection.
- (5) Instability due to loose parts.

Tests for each one of these defects can be made by the Tube Tester TV-4/U. The neon lamp marked SHORT INDICATOR is used for the determination of the first two. Failure of the type listed under (3), (4), and (5), can be detected by watching the instrument pointer.

For the inter-electrode short test, each element of the tube is individually isolated by one of the electrode switches, and a DC potential is applied in series with the short indicator. The polarity of this potential is opposite to that required for normal emission current and, in this way, the short indicator will only register leakage resistance or actual short circuit between elements. The tube filament is heated to normal temperature for all short testing.

The cathode leakage test applies only to tubes of the indirectly heated type as marked by a small star after the type number in the Tube Data Index. Here the heater is isolated from the cathode by operation of the electrode switch marked A; a potential is applied through the short indicator circuit; and resultant heater-cathode resistance below 1/4 megohm will cause illumination of the neon lamp. The short indicator sensitivity must be limited to this value, since many indirectly heated tubes are manufactured under specifications approaching 1/4 megohm for minimum heater cathode resistance.

The emission characteristic is indicated on the meter in terms of a three-color scale with segments in red, yellow and green. Readings in the red section indicate at once that the tube is defective, except for tests on diodes. Readings in the yellow section indicate a borderline tube very close to the rejection point. Pointer deflections into the green section indicate a good tube or one that has a normal emission characteristic. Where comparative emission readings may be useful, or data are to be recorded, the 50 line scale arc marked 0 to 50 is available. Meter readings as noted on this 50 line arc provide a means for plotting the fall-off in emission on any tube throughout its normal life.

The basic principle of operation can be readily understood by referring to the simplified schematic (figure 2-1) showing a 6K7 tube under emission test.

All potentials applied to the tube are AC and are delivered by transformer (T-101). Resistors (R-101) and (R-103) and the control (R-117) form a network that provides a sensitivity adjustment on the indicating meter. Note that (R-117) is the TUBE SELECTOR control. (R-102) is the load resistor and serves to limit the maximum current drawn from the tube under test.

Indexing toggle switches (S-104) through (S-110) to the IN position selects the tube electrodes to be checked. Note that only those toggles that connect to a tube element are indexed to the IN position, and when in this position all of these elements are tied together. Any toggles corresponding to a heater or cathode connection must be in the OUT position.

The energizing potential is delivered by the 30 volt winding of (T-101) and is connected in series with the load resistor (R-102), the DC meter including its variable sensitivity network (R-103, R-117 and R-101), the cathode of the tube under test and back through the tube elements (socket terminals 3, 4, 5 and cap) to the 30 volt winding by way of those toggle switches in the IN position.

Since the tube under test acts as a half-wave rectifier, and there is a closed circuit, the meter will indicate a current which is a function of the cathode emission.

For checking diode or battery types, the circuit is the same, except that an additional resistance (R-112) or (R-113) respectively is inserted in series with the 30 volt winding of (T-101). For special types the original circuit is used except that the 30 volt potential is changed to 300 volts with

(R-115) inserted in series. (See figure 5-7.)

Open elements can be detected by connecting or disconnecting each electrode from the indicating and energizing circuit. This operation is performed by operating the individual electrode switches as listed in the Tube Data Index. The change in emission reading is noted on the meter.

Intermittent operation due to loose electrodes, their supports, or faulty connections in the tube under test can often be detected by tapping the tube with a pencil during both the short test and emission test. Faulty operation will be apparent by flashing of the short indicator or fluctuation of the instrument.

c. CAPACITY METER SECTION OF TUBE TESTER TV-4/U. (See figure 2-2.) - In this section of the Tube Tester, the circuit on each range consists of an AC potential supplied by one of the transformer windings and applied through a series resistance and an instrument shunt network to the capacity jacks which in turn are connected across the capacitor under test. Effectively, the instrument operates as an AC milliammeter indicating the impedance of the capacitor under fixed applied voltage conditions. A current limiting series resistor (the instrument network resistance on large capacity ranges) is used on each range; so that the capacity meter operates very much like a conventional series ohmmeter. By short circuiting the test leads, the LINE CONTROL (R-116) can be rotated, adjusting the applied potential for a full scale deflection of the milliammeter pointer. This is equivalent to zero external impedance or infinite capacitance. The insertion of a capacity between the test leads will then increase the impedance of the circuit causing the meter to deflect a given amount for each capacitance. This capacitance is calibrated directly on the dial for a 60 cycle power supply.

d. BASIC CIRCUIT OF SIGNAL TRACER TS-673/U. (See figure 2-3.) - This unit comprises a conventional three stage linear amplifier, the output of which is of the cathode follower type, and a power supply capable of operating on 50 to 1600 cycle source. The power supply is of the full wave type with capacitor input and resistor capacitor filter network. The power transformer is of special design to cover the power supply frequency range. The following items are accessories.

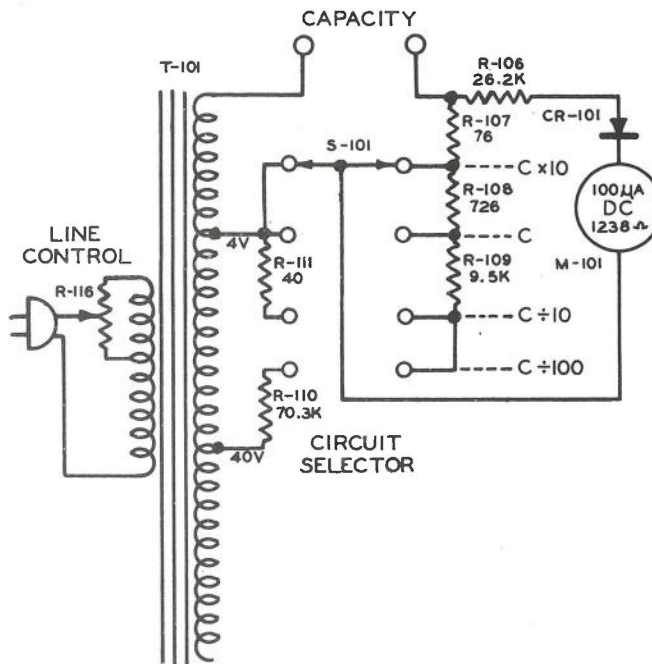

Figure 2-2. Simplified Schematic, Capacity Meter Section of Tube Tester

- (1) Test Prod MX-933/U for audio frequencies from 47 to 15,000 cycles per second.
- (2) Test Prod MX-934/U to detect an audio modulated RF signal within the range from 15,000 cycles to 400 megacycles per second.
- (3) Navy Type CTE-491898 Telephone Receiver, Navy Type CAOR-491901 Headband and connecting cable for the test prods.

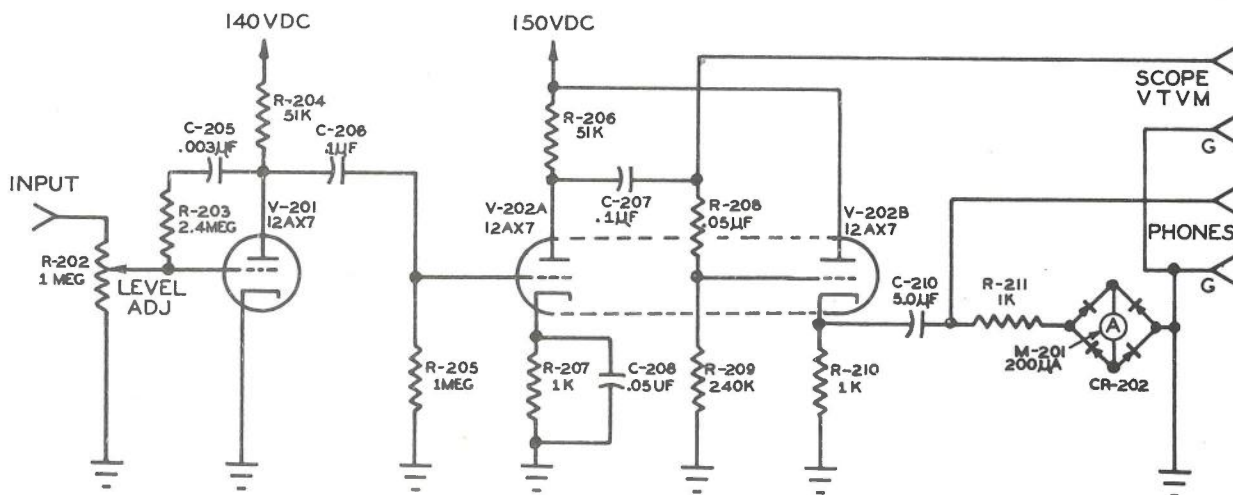

Figure 2-3. Simplified Schematic, Signal Tracer

The over-all sensitivity of the Signal Tracer is controlled by potentiometer (R-202), the moving contact of which is connected to the grid of (V-201). The resistor (R-203) and capacitor (C-205) feed an opposite phase voltage back to the input grid, so lowering the gain of the first stage, and expanding the frequency range of the amplifier. An audio signal that is applied to the input of the Signal Tracer is amplified by tubes (V-201) and (V-202A) and applied to the grid of the cathode follower stage (V-202B) through coupling capacitor (C-207) and voltage divider resistors (R-208) and (R-209). The PHONES plug and the output meter circuit are connected to the cathode follower output by means of coupling capacitor (C-210). The SCOPE VTM plug is connected internally to the plate of tube (V-202A) through capacitor (C-207) and should be connected only to equipment having a high impedance input, such as an oscilloscope or vacuum tube voltmeter. The meter circuit consists of dropping resistor (R-211), full wave copper-oxide bridge rectifier (CR-202), and 200 uA full scale DC meter (M-201). The circuit rectifies and indicates a portion of the audio energy output of the cathode follower tube, so giving a means of determining relative input voltage magnitudes. As shown in figure 5-11, the Test Prod MX-933/U contains only a 0.1 microfarad 400 volt DC coupling capacitor. The Test Prod MX-934/U contains a conventional crystal diode detector circuit.

e. BASIC CIRCUIT OF INTERFERENCE GENERATOR SG-23/U. (See figure 2-4.) - This is an aperiodic, impulse buzzer type generator and is housed in a probe case. The simplified schematic is shown in figure 2-4. When the switch is closed by pressing the button at the top of the probe, a modified square wave appears across the energizing coil. The harmonic content of this wave extends into the megacycle region. Varying the position of the inner tip with respect to the outer tip by means of the index at the end varies the coupling capacitance and allows some attenuation. For audio output the inner and outer probes are placed in contact by setting the attenuator at POSITION 1.

f. BASIC CIRCUIT OF VOLTAGE INDICATOR-PROBE ID-265/U. - A schematic diagram of this device is shown in

figure 5-14, Section 5. This unit indicates voltage by indicating the AC or DC current flowing through a high impedance calibrating resistor (R-401). The sensitivity of meter (M-401) is 250-0-250 milliamperes DC and indicates the polarity of the Probe for DC measurements. The meter (M-402) has a sensitivity of 0.88 milliamperes full scale and, with the aid of the full-wave copper-oxide bridge rectifier (CR-401), will indicate the relative magnitudes of either AC or DC. An AC current of a frequency greater than 10 cycles per sec. will flow through the high resistance calibrating resistor (R-401) and not disturb the moving system of meter (M-401), but this AC current will be rectified by rectifier (CR-401) and the average value of current indicated on DC meter (M-402). For a DC current through (R-401), the pointer of DC meter (M-401) is moved in a direction determined by direction of electron flow in the coil of the moving system, so indicating polarity. A path also exists for DC current flow through the rectifier and meter (M-402), which moves and indicates the average value. As the unit is calibrated by means of an RMS AC voltage, a DC voltage of the same magnitude will read about 10% high.

g. CIRCUIT OF RF INDICATOR-PROBE ID-263/U. - The schematic diagram of this Probe is shown in figure 5-15, Section 5. The circuit is of conventional design with a diode around the instrument network to prevent the coupling capacitors from assuming a DC charge. The sensitivity of the meter (M-501) is 200 microamperes full scale. When the unit is placed in an electric RF field, dielectric or capacity currents flow on to the probe tip and through the coupling capacitor (C-501). On the positive half cycle the capacity current flows through the germanium diode (CR-501) to the instrument frame and then through the operator's hand capacity to the operator and back into the field. On the negative half cycle the current flows through diode (CR-502) and DC meter (M-501) which indicates the magnitude of this current.

h. CIRCUIT OF RESISTANCE INDICATOR-PROBE ID-264/U. - A schematic diagram of this unit is shown in figure 5-16, Section 5. The circuit is the conventional series ohmmeter type and consists of a 1000 ohm dropping resistor (R-601) and a DC milliammeter. The sensitivity of the meter is approximately 1.48 milliamperes full scale.

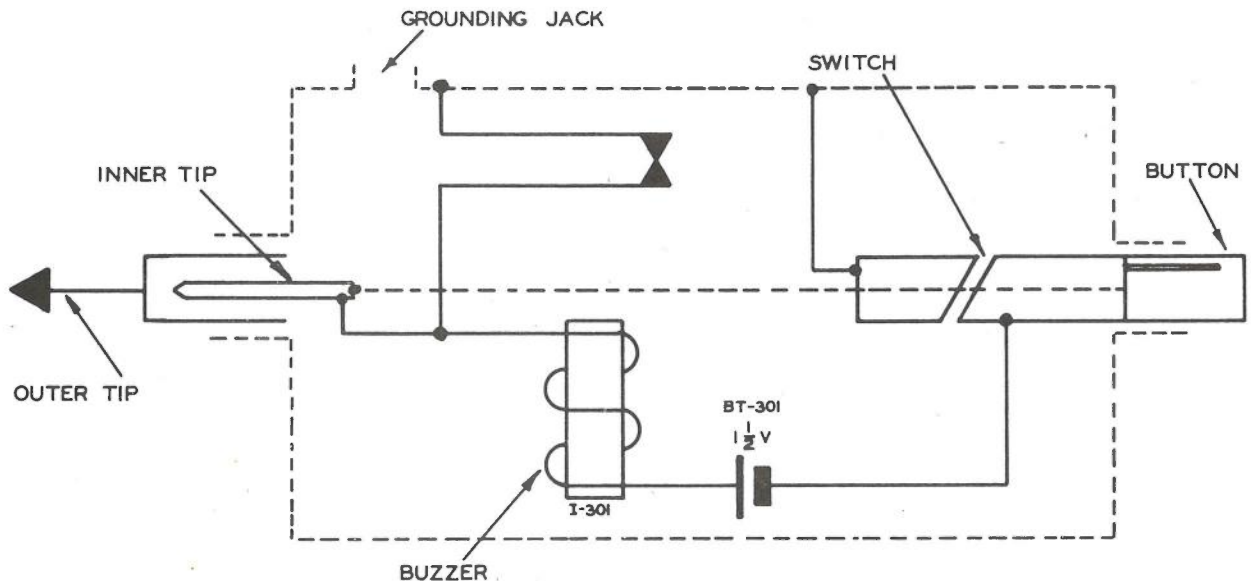

Figure 2-4. Simplified Schematic, Interference Generator

SECTION 3 INSTALLATION

1. UNPACKING INSTRUCTIONS.

Remove the top of the wood packing case and take out the cushioning material above the equipment. Lift out the equipment box. Remove the outer paper wrapping and the inner cushioning wrap from the equipment box. The Repair Parts Box can then be removed from the packing case.

CAUTION

This equipment incorporates fragile instruments. It has been packed with extreme care and should be unpacked and handled in like manner.

2. PREPARATION FOR USE.

To prepare the Test-Tool Set for use in repairing electrical equipment, unsnap the latches and open the Case. The tools are obtained by releasing the snapslides and removing the Tool Holder cover in the top of the Case. The cover is held to the Case by a spring wire to prevent loss of this item. If the Tube Tester is to be used, the Technician's Handbook behind it should be removed from the Case, allowing the Tester to be tilted up and forward into operating position. If leads or other accessories are required, they will be found as indicated in figure 1-1.

NOTE

Batteries must be installed in the Resistance Indicator-Probe ID-264/U, Interference Generator SG-23/U and the Flashlight (0-901) before they are put in operation.

Four flashlight batteries JAN BA-58 are required for these three units. Four spare batteries should be kept with the two flashlight bulbs in the Battery and Bulb Case.

The battery can be installed in the Resistance Indicator-Probe by inserting the tip of the 2" screw driver in the slot of the metal clamping ring and gently prying the ring open. (See figure 3-1.) The Probe end may then be slipped off the body, exposing the battery compartment. Since the resistor (R-601) is held in place by spring pressure only, it may fall out when the Probe is disassembled. (See figure 3-2.) Therefore, when reassembling the Probe make sure that this resistor is in place.

The battery compartment of the Interference Generator is reached by lifting the flared end of the metal index ring and removing the bakelite knob. Figure 3-3 shows the unit disassembled. The battery is inserted with its positive end toward the Probe tip. The half-round screw head in the index button (indicated as BAT. ADJUST SCREW) adjusts for different battery lengths. It may be necessary to turn this screw in or out when a new battery is installed, until the inner tip touches the outer tip only on POSITION 1. Contact between the two tips can be tested by inserting an electrical lead (CAOR-491895) in the ground jack and touching the other end to the Probe tip. The buzzer noise will stop if the tips are in contact. When re-assembling, the white index line on the knob should be set at a numbered position on the index ring before the knob assembly is re-inserted.

The two JAN BA-58 batteries are placed in the Flashlight with their positive ends toward the bulb.

Four spare JAN BA-58 batteries should always be kept in the Battery and Bulb Case.

3. REPLACEMENT OF UNITS IN CASE.

All units must be replaced in their proper location in the Test-Tool Set as shown in figure 1-1. Be sure to engage both snapslides on the Tool Holder before closing the Case.

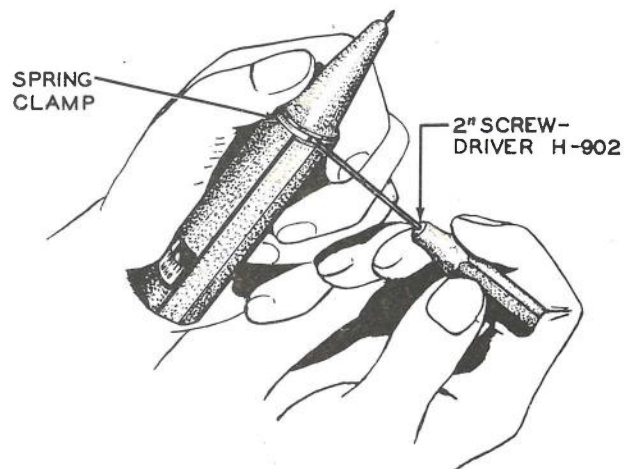

Figure 3-1. Resistance Indicator-Probe, Method of Removing Clamping Ring

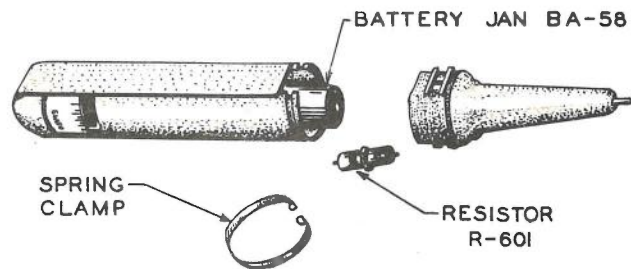

Figure 3-2. Resistance Indicator-Probe, Disassembled

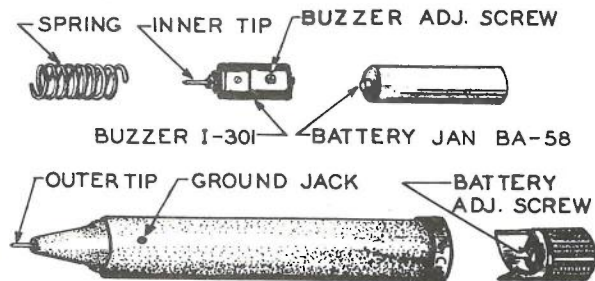

Figure 3-3. Interference Generator, Disassembled

**SECTION 4
OPERATION**

1. INTRODUCTION.

The major parts, tools and accessories contained in this Test-Tool Set are specifically designed for emergency repair of electronic equipment. The units are small in size and incorporate only basic electrical features. An attempt has been made to design each unit to suggest its operation and use. Since the set also includes sensitive meters, it must be handled with reasonable care.

2. TUBE TESTER TV-4/U.

a. CAPABILITIES AND LIMITATIONS. - This is an ultra-compact portable unit for checking the performance of receiving type electron tubes only; it is not designed for tests of transmitting tubes. The device is made as flexible as

possible to handle the large number of receiving tubes used in Navy as well as commercial equipment. A minimum number of controls are used to test any one tube, so that the average operator will find the testing procedure quite simple to understand after study of the operational instructions.

The Tube Tester requires a 105-125 volt, 50-1600 cycle power source for operation. (Operation must not be attempted on frequencies below 50 cycles per second.) It is designed to test all the tubes listed in the Tube Data Index for emission, shorted and open elements.

It can also measure capacities from 0.001 to 100 microfarads. The capacity values for a 60 cycle supply are obtained directly from the meter scale and the multiplier position. For other frequency power sources, the calibration curves shown in figure 4-1 should be used. The unit will not indicate a gassy condition in a tube, except as it may affect the emission.

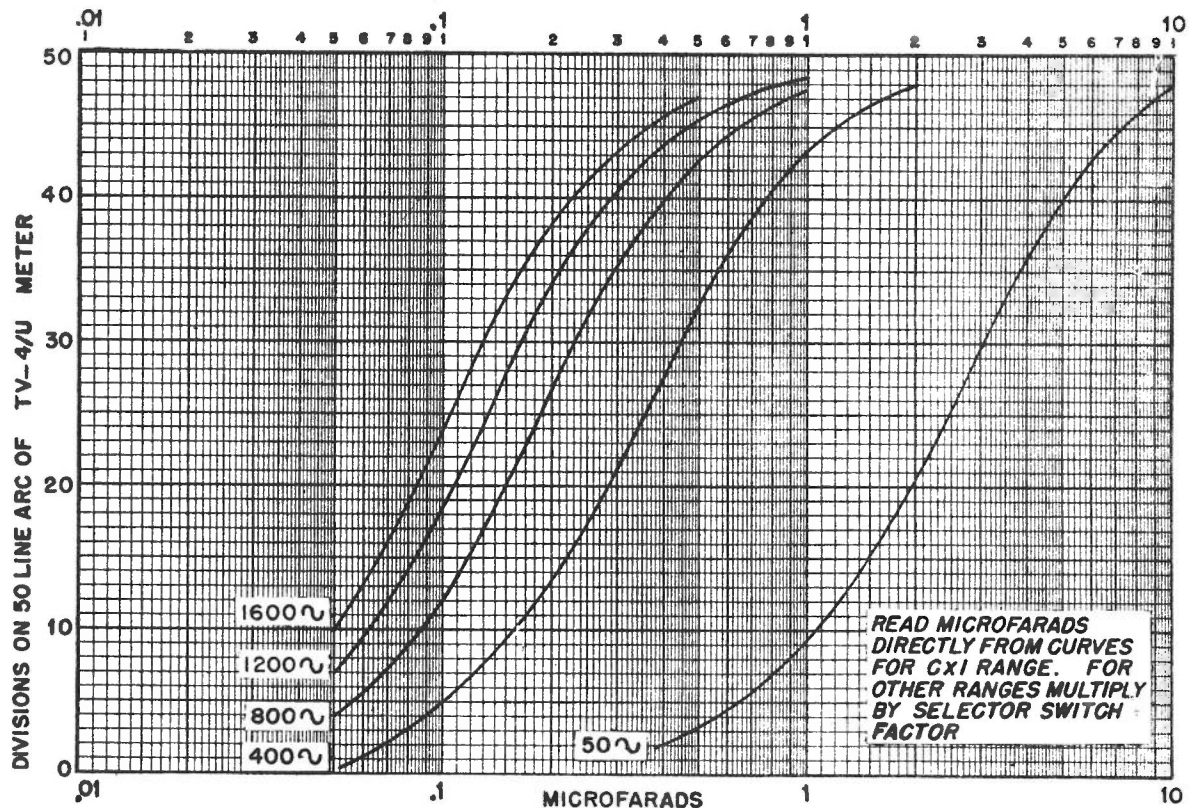

Figure 4-1. Curves, Capacity Reading Corrections for Various Power Line Frequencies for Capacity Meter Section of Tube Tester

b. **PRELIMINARY OPERATION.** - To set up the Tube Tester in operating position, unlatch the Test-Tool Set cover by opening the two snap catches on the front or handle side. Open the cover and remove the Technician's Handbook. Then tilt the Tube Tester forward into position about 45 degrees from the bottom of the case, exposing the socket panel until the locking arm locks into place. (See figure 4-2.)

Unwind the Power Cable Assembly from the Cord and Test Lead Holder (H-918) and plug it into the line receptacle on the left-hand side of the Tube Tester. Connect the other end to a power outlet (105 to 125 volts, 50 to 1600 cycles.)

Swing the Tube Data Index to the right, exposing the indicating meter. This Index contains type numbers of the various tubes to be tested and is mounted on a special bracket for easy reference.

Rotate the **CIRCUIT SELECTOR SWITCH** to the **LINE SHORT CHECK** position. The meter pointer should deflect up-scale near the **LINE CHECK** arrow. Rotate the **LINE VOLTAGE CONTROL** until the meter pointer rests over the line check mark. The Tube Tester is now ready for operation. Thirty seconds is the minimum warm up time. For a description of the front panel controls and sockets refer to Section 2, paragraph 1a.

c. **DETAILED OPERATING PROCEDURE.** - After the Tube Tester is set up in operating position, locate the tube type number to be tested in the Tube Data Index, and turn the **FILAMENT** and **TUBE SELECTOR** knobs to their listed

positions. Re-examine the tube type number to see if an abbreviation **BAT.** (battery), **DI.** (diode) or **SPEC.** (special) is listed after the type number. All tubes that have no reference to any of these types are considered normal tubes and are tested in the **CIRCUIT SELECTOR** position so marked.

Determine whether the tube has a center tap filament as indicated on the tube chart by a dagger (†) immediately following the tube type number. Tubes of this type require that the **A** toggle switch be indexed to the **IN** position before inserting the tube in the socket, and it should be kept in this position during the complete test. If a double dagger (††) occurs after the tube type number in the Tube Data Index, place the tube in the **A** socket of corresponding pin arrangement. If a target ⊕ occurs after the tube type number, use the **B** socket. If neither symbol occurs, use the regular sockets. See figure 4-2. Most tubes use the regular socket, and **NORMAL** position of the **CIRCUIT SELECTOR**. Set the meter pointer to the line check position by adjusting the **LINE VOLTAGE** control. If practicable, let the tube warm up about five minutes in order to detect shorts which occur due to the heating of the elements.

Test the tube for shorts by turning the **CIRCUIT SELECTOR** switch to **SHORT TEST** and placing only one toggle switch in the **IN** position at a time. Index only those toggles called for on the data chart under the **IN** position column to the **IN** position one at a time. If a star (*) follows the tube type number on the data chart, check for cathode leakage by indexing the **A** toggle to the **IN** position, while all the other

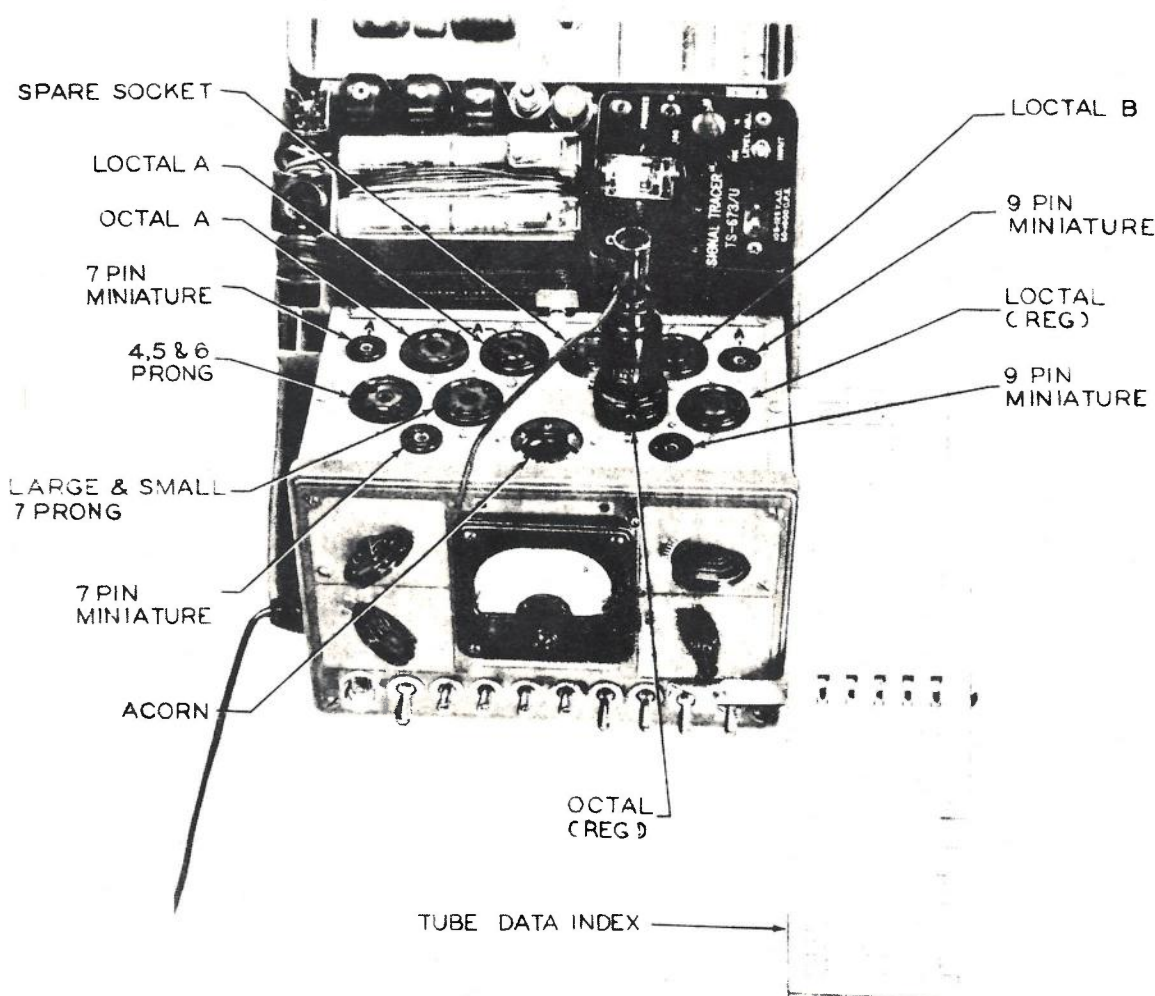

Figure 4-2. Tube Tester in Operating Position

toggles are in the OUT position. Should a short be indicated by a lighted neon lamp, the tube should be rejected. A flickering of the neon lamp at the instant of throwing a toggle switch does not indicate a short. For tapped filament tube types (indicated on tube chart by a dagger †), refer to paragraph 2c (5).

(1) TESTING NORMAL TYPES. - Rotate the CIRCUIT SELECTOR switch to the NORMAL TUBES position. Place each of the switches listed under the IN position correctly and note the test reading. There are two groups of listings for some tubes, such as the 6F8, with an & sign between them. This tube has two sections and should be tested separately. For this particular tube, switches B and E should be thrown to the IN position and the reading noted, the switches returned to the OUT position, then D and F thrown together to the IN position and the reading on the second section taken, the & sign in all cases separates the electrode switches from each section of the tube to be tested. After the total emission test has been made, do not neglect to perform the open element test described in Paragraph 2c (8).

NOTE

Certain types are marked directly after the tube number on the tube data list with symbols (††) or ⊕. These tubes, due to unusual electrode connections, must be tested in the A socket corresponding to the pin arrangements of the tube to be tested. In all other respects, these tubes are tested in the usual way. These tubes, due to unusual electrode connections must be tested in either the A socket or the B socket with the corresponding pin arrangement. Tube types marked in the Tube Data Index with a symbol (††) are tested in the A socket, and types marked with a symbol ⊕ are tested in the B socket.

(2) TESTING BATTERY TYPES. - These are the low current filament type of tube and must be tested as a separate group. These tubes can be damaged if not correctly handled, and all tubes of this type are marked BAT. directly after the tube number. When testing these tubes, the CIRCUIT SELECTOR switch should be indexed to the BATTERY TUBES position but, in all other respects, the procedure is the same as listed under NORMAL TUBES. Note that all of these tubes are of the filament type and, therefore, no cathode leakage test is required.

(3) TESTING DIODES. - Tubes of this type are marked on the tube data card as DI. and, when so designated, the CIRCUIT SELECTOR switch should be placed in the DIODE position. When testing diode plates, it should be noted that the TUBE SELECTOR control should always be placed in the 0 position. A black line and arrow on the meter scale is used as the passing line for emission of diode plates. If the meter indication is above this line the tube should be passed as having sufficient emission in accordance with R.M.A. limits.

Certain tubes, such as the 957 and 958, require that the CIRCUIT SELECTOR be set to the DIODE position to prevent damage to the emitting surface of the filaments. These tubes have a double (**) followed by the abbreviation DI. immediately following the tube type number on the tube chart. These tubes are not actually diodes, but are checked in the diode position, and the reject point for such types is 16 on the zero to 50 scale.

(4) TESTING SPECIAL TYPES. - Tubes listed with the marking SPEC. after the tube number should be checked with the CIRCUIT SELECTOR switch indexed to the SPECIAL TUBES position. This is used principally for rectifier types. With the exception of the setting of the CIRCUIT SELECTOR, the procedure for test is the same as specified for normal tubes.

(5) TESTING CENTER TAP FILAMENT TYPES. - Center tap filament types may fall under any of the classifications, such as diode, battery, or normal types. Tubes in this category have a single dagger (†) immediately following the tube type number on the tube data chart. It is important to index the A toggle switch to the IN position before inserting the tube in the socket and keep in this position during the complete test. A lighted neon lamp will indicate continuity of the filament connections, when CIRCUIT SELECTOR is in the SHORT TEST position. Short tests can be made on tubes of this type by reducing the filament voltage to 1.5 volts and then indexing the A toggle switch to the OUT position. The short tests can then be performed in the normal manner.

(6) NORM. REV. TOGGLE SWITCH. - In the lower right-hand portion of the panel is a toggle switch that performs the function of reversing the meter connections. Ordinarily this switch should be indexed to the NORMAL position. If the tube has a † symbol following the tube type number, this toggle switch should be indexed to the reverse position to make the tube test. To short check tubes of this type, index the A toggle to the IN position, leaving G toggle in the IN position.

(7) TUBE DATA CHART SYMBOLS. - The procedure for checking the various tubes having certain symbols following the tube type numbers has been given in the preceding paragraphs; however, it should be kept in mind that any one tube may have several symbols indicating that the procedure outlined for each one of the symbols should be followed. For instance, a tube type having a star and a double dagger (* ††) should be checked in an A socket corresponding to the pin arrangement of the base and should also be checked for cathode leakage. The symbols used on the tube chart are listed below, and it must be kept in mind that any combination of these symbols might possibly be used following the tube type number.

- § When testing for open elements or short checking, F & G toggles should be thrown to the IN and OUT positions together.
- * Same holds for toggles B & D. See first note.
- §§ The same holds for toggles D & G. See first note.
- ▽ The same holds for toggles B, D & F. See first note.
- △ The same holds for toggles B & C. See first note.
- ** Reject Point is 16 on 50 Line Arc.
- † Index switch A to IN position before inserting tube; keep in this position during complete test. A lighted neon lamp will indicate continuity of third filament connection. For short test, refer to instruction in Paragraph 2c (5).
- * Test for cathode leakage by throwing A switch to IN position when the tube is hot; all other switches should be in the OUT position.
- †† Test in A socket.
- † Place NORM. REV. toggle in REV. position; to short check, index A toggle to IN position, leaving G in the IN position.
- Place NORM. REV. toggle in REV. position.
- & Move grid lead to the cap that gives the higher reading.
- or Tie both grid caps together.
- When testing for open elements or short testing, B & H toggles should be thrown to the IN and OUT positions together. The same holds for C & G toggles. Check for cathode leakage.
- ⊕ Test in B socket.

(8) OPEN ELEMENT TEST. - In checking for emission on any tube, some of the electrodes handle most of the emission current because of their proximity to the cathode, resulting occasionally in a tube checking good when one of the elements carrying only a very small current is open. Such a tube will not operate in a receiver. With the system of independent electrode switching used in this Tube Tester.

this type of fault can be located readily. First, set the tube up for the regular total emission check as outlined in the previous paragraphs. Using one of the toggles already in the IN position, index it to the OUT position and note whether there is a drop in the meter deflection. If there is no change in meter indication, the tube should be rejected as bad due to an open element.

To double check when an open element is suspected, move all toggles to the OUT position. The meter pointer will drop to zero. Move the toggle for which there was no change in indication under the test in paragraph (k) above to the IN position. The meter pointer should move up scale at least one-quarter of a division. The TUBE SELECTOR, which controls the meter sensitivity, may be temporarily advanced (counter-clockwise) to increase this deflection. No deflection indicates an open element and a defective tube. Be sure to return the TUBE SELECTOR control to its proper position specified in the tube data chart before testing another tube.

d. SUMMARY OF OPERATION. - The step-by-step procedure listed in paragraphs (1) through (7) below must be followed as a set-up preliminary to making any of the three tests which follow. The three tests should also be followed in consecutive order, i.e., first make the short test, then the emission test, followed by the open test.

(1) Plug the device into a 105 to 125 volt, 50 to 1600 cycle supply.

(2) Rotate the CIRCUIT SELECTOR to the LINE SHORT CHECK position.

(3) Set the FILAMENT SELECTOR in accordance with the tube data.

(4) If a single dagger (†) appears following the tube type number, index the A toggle to the IN position before inserting any tubes.

(5) Insert the tube in the socket corresponding to the proper pin arrangement. (See figure 4-2) If a double dagger (††) appears after the tube type number on the tube data chart, the A socket should be used. If a symbol (⊕) appears after the tube type number, use the B socket. Neither symbol indicates the regular sockets.

(6) Rotate the LINE VOLTAGE control until the pointer indicates at the LINE CHECK mark.

(7) Rotate the TUBE SELECTOR to the figure indicated on the tube data chart. The Tube Tester is now ready to perform the following tests:

Short Test

(a) Place all toggle switches in OUT position, with the exception of the A toggle switch when a single dagger (†) follows a tube type number.

(b) Index one of the toggle switches called for on the data chart under the IN position column to the IN position.

(c) Tap the tube and see if the neon lamp lights. If it lights the tube is shorted and should be rejected.

(d) Return the toggle to the OUT position.

(e) Repeat the above procedure for each of the other toggle switches called for on the data card. The position of the TUBE SELECTOR has no effect when short checking a tube. Index only those toggle switches called for on the data card under the IN position column.

(f) If a star (*) follows the tube number on the data chart, check for cathode leakage by indexing the A toggle to the IN position with the other toggles in the OUT position.

Emission Test

(g) Rotate the CIRCUIT SELECTOR to either the DIODE, BAT. or SPEC. tube position in accordance with the abbreviations Di., Bat. or Spec., respectively, following the tube type number on the data chart.

(h) Use the NORMAL TUBES position when no abbreviation follows the tube type number on the chart.

(i) Index the toggle switches at the bottom of the panel to the IN position as called for on the tube data chart under the IN position column for a total emission test.

(j) Note meter indication. If pointer is in the red or yellow section, reject the tube. If the pointer indicates in the green section, proceed with the open element test.

Open Element Test

(k) With the same toggle switches in the IN position as required for the emission test, paragraph (i) above, throw one of these switches to the OUT position and see if the meter drops. DO NOT, however, index an A toggle switch to the OUT position when a single dagger (†) follows the tube type number. A drop of only one-quarter of a division on the meter scale indicates that the element is making contact. No movement of the meter indicates an open element.

(l) Return the toggle to the IN position.

(m) Repeat the same procedure for each of the other toggles that are in the IN position, except for the A toggle switch where a single dagger (†) follows the tube type number.

(n) To double check when an open element is suspected move all toggles to the OUT position. The meter pointer will drop to zero. Move the toggle for which there was no change in indication under the test in paragraph (k) above to the IN position. The meter pointer should move up scale at least one-quarter of a division. The TUBE SELECTOR, which controls the meter sensitivity, may be temporarily advanced (counter-clockwise) to increase this deflection. No deflection indicates an open element and a defective tube. Be sure to return the TUBE SELECTOR control to its proper position specified in the tube data chart before testing another tube.

NOTE

Do not index the A toggle switch to the OUT position when a single dagger (†) follows the tube type number. Failure to observe this caution on tubes will result in a burned out filament section.

e. METHOD OF ESTABLISHING TUBE DATA. - Sometimes it is necessary to set up tube data for tubes not listed on the data chart. By using Table 4-1 below, it is possible to pick the active toggle switches.

First from the tube base diagram obtain the element pin numbers, noting particularly the two filament pin numbers. With these pin numbers, enter Table 4-1 and note which socket has the same filament numbers as the tube to be tested. Use this socket for testing the tube in the Tester. In the column under this socket choose the numbers which correspond to the pin numbers on the diagram, omitting the cathode, and note the letters of the corresponding toggle switches to be used for the test procedure.

For example on a 6K7 tube: From a diagram of this type tube it is noted that the tube has an octal base with filaments on pins 2 and 7 and other elements on pins 3, 4, 5 and cap. (Disregard cathode on pin 8.) Table 4-1 lists three octal sockets. A comparison of the 6K7 filament pin numbers with those listed under the three octal sockets shows that the regular octal socket should be used. The column of figures under the regular octal socket indicates that toggle B is connected to pin 3, C to pin 4, D to pin 5 and E to the grid cap.

NOTE

The A toggle switch is used primarily for heater to cathode leakage tests but serves a useful purpose when testing tubes having tapped filaments.

TABLE 4-1. TOGGLE SWITCH AND SOCKET CONNECTIONS

TOGGLE SWITCH	ACORN	4 PRONG	5 PRONG	6 PRONG	7 PIN MINIATURE	7 PIN MINIATURE A	7 PRONG LARGE & SMALL	LOCTAL (REG.)	LOCTAL A	LOCTAL B	OCTAL (REG.)	OCTAL A	OCTAL B	9 PIN MINIATURE	9 PIN MINIATURE A
1st Fil.	A	4	1	1	1	3	1	8	8	7	7	8		5	9
	B	2	2	2	2	3	2	2	1	3	3	3		1	3
	C	3	3	3	3	4	3	3	3	4	4	4		2	4
	D	5	4	4	4	5	5	5	(Spare Socket)	3	5
	E	Cap	Cap	Cap	Cap	Cap	Cap	5	Cap	Cap	Cap	Cap		9	7
	F	6	4	6	5	6	6	6	6	6		6	6
	G	5	..	4	5	2	6	7	7	8	8	1		7	8
	H	5	1	1	2		8	2
2nd Fil.	1	4	5	6	7	4	7	1	2	2	2	7		4	1

CAUTION

Any tube having a center tap filament should have the A toggle switch indexed to the IN position before inserting a tube in the socket. Use the FILAMENT SELECTOR position corresponding to the rated filament voltages. i.e., both sections of the filament, listed in the tube manufacturer's specifications or the nearest value available.

Take into account the type of tube that is to be tested. The diode position is used for RF diode types and for those battery types on which the load on the tube is too great. Whether the load is too great or not can be determined by placing the tube in its proper socket and indexing the CIRCUIT SELECTOR to the BAT. position. If the meter pointer deflects up scale to a reasonable deflection, and then tends to deflect slowly down scale toward the zero mark, the load placed upon the tube is too great and the diode position should be used instead.

The battery type position (BAT.) will be used for those tubes having more than two elements and having filament voltages corresponding to the 1.4 or 2.0 volt types. Center tapped filament tubes with ratings of 2.8 and 4 volts fall under this same classification. The SPECIAL position should be used only on tubes of the rectifier type, such as the 0Z4, 5U4-G, etc. All other types should have the CIRCUIT SELECTOR indexed to the NORMAL type position during test.

After determining the SELECTOR SWITCH and FILAMENT SELECTOR positions, and the toggle switches to be used, it is then necessary to rotate the TUBE SELECTOR control until the meter indicates approximately 36 on the 50 line DC scale for tubes known to be good. Several good tubes should be used for determining this TUBE SELECTOR position. All diode types should have the TUBE SELECTOR set at zero. Although this procedure will not give accurate tube test data, it will suffice for a large number of tubes.

When determining the data for a new tube, if it is noted that the base connections are the same as a tube listed in the TUBE DATA INDEX then set the CIRCUIT SELECTOR, FILAMENT SELECTOR and TUBE SELECTOR controls.

The toggle switches to be used and the symbol following the tube type number would then be the same as for the tube already listed on the data chart.

f. OPERATION OF CAPACITY METER SECTION OF TUBE TESTER TV-4/U. - Aside from the tube test functions, a four range capacity meter is available in the Tube Tester. The CIRCUIT SELECTOR switch is used on the last four positions for capacity meter range selection. These four switch positions are marked C x 10, C x 1, C + 10 and C + 100. The meter scale reads directly in microfarads from 0.1 to 10 on the C x 1 range. Other ranges are: C x 10 from one to 100 microfarads, C + 10 from 0.01 to one microfarad, C + 100 from 0.001 to 0.1 microfarad.

The Tube Tester transformer supplies all potentials for the capacity ranges at power line frequency. The meter scale is calibrated for a frequency of 60 cycles. If capacity readings are taken when the Tube Tester is energized from 50, 400, 800, 1200 or 1600 cycle power sources, a correction factor must be applied. Refer to figure 4-1 for capacity readings on any of these power line frequencies. These corrections are necessary, since the meter actually measures impedance and, therefore, the pointer deflection is a function of both capacitance and frequency.

To determine the value of a capacitor, connect the Tube Tester to a 105-125 volt AC power line of known frequency. Rotate the CIRCUIT SELECTOR switch to one of the C positions. Insert two test leads CAOR-491895 with the pin jack adapters in the two pin jacks directly above the meter marked CAPACITY. Short the test leads and rotate the LINE VOLTAGE control until the meter pointer shows full scale deflection at the infinity mark. Select the capacity range that gives a reading nearest to the center of the scale for best accuracy, and read the capacity in microfarads on the top arc. Multiply or divide by the switch position marking as required. Correct for line frequencies different from 60 cycles.

If power line frequencies other than 60 cycles are used the initial reading is taken on the 0 to 50 scale. Figure 4-1 is then entered and the corrected capacity obtained.

NOTE

Be sure the capacitor under test is not energized by potentials in the circuit where it is connected. No shunt impedances, such as coils, chokes or resistors should be in parallel with the capacitor. To obtain a true reading, disconnect one terminal of the capacitor from the circuit before testing.

g. **TYPICAL APPLICATIONS.** - Beyond the normal function of measuring capacity, the Capacity Meter Section can be used to indicate the AC value of resistance, inductance and impedance. The tube tester can also be used as an AC voltage source.

(1) **RESISTANCE.** - When measuring resistance connect the unknown resistor to the jacks of the Capacity Meter Section of the Tube Tester and set the **CIRCUIT SELECTOR** control at C x 10, C x 1, C ÷ 10, or C ÷ 100, whichever position gives a reading on the scale. Read the zero to 50 scale and refer to figure 4-3 to determine the resistance value.

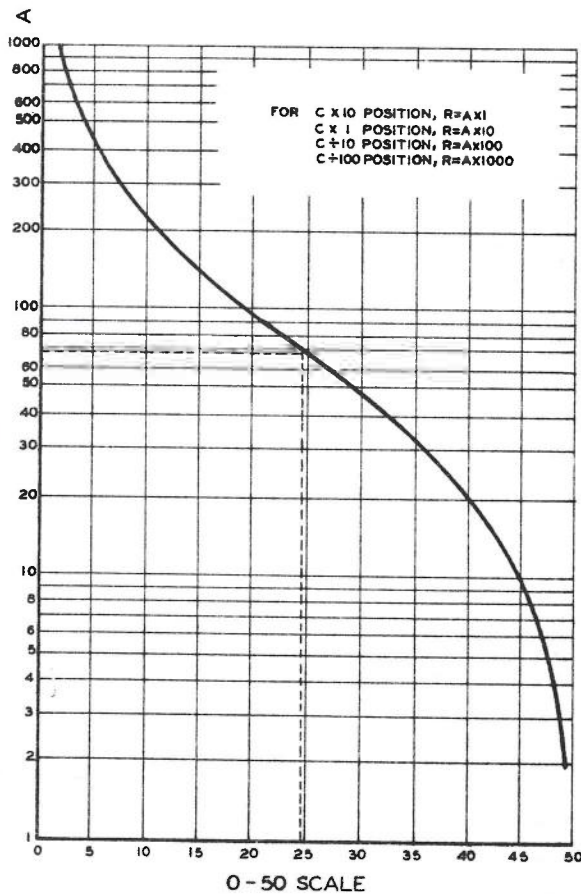

Figure 4-3. Resistance Curve for Capacity Meter Section

To find the value of resistance R locate the reading on the zero to 50 scale on the horizontal axis and read up to a point on the curve. From point on curve read left to determine value for A which when multiplied by switch position factor gives resistance in ohms. Example: For a reading of 24.5 on the zero to 50 scale of the meter with the **CIRCUIT SELECTOR** set to the C ÷ 10 position; the value A is 68. The resistance R = A x 100 or 6800 ohms. The meter may be used for values of resistances from approximately 2 ohms to 1 megohm.

(2) **PURE INDUCTANCE.** - The value of pure inductances can be measured on the Capacity Meter Section of the Tube Tester. The inductance L is measured in the same manner as a capacitor, and the value is calculated from the meter reading using the following formula:

$$L = \frac{10^6}{(2\pi f)^2 C} \text{ henrys}$$

where f is the power source frequency, and C is the value in microfarads as read on the meter scale multiplied or divided by the **CIRCUIT SELECTOR** position. (The value of C must be corrected for any line frequency other than 60 cycles. See figure 4-1.

The curves of figure 4-4 and figure 4-5 show the relation between L and C for 60 and 400 cycles.

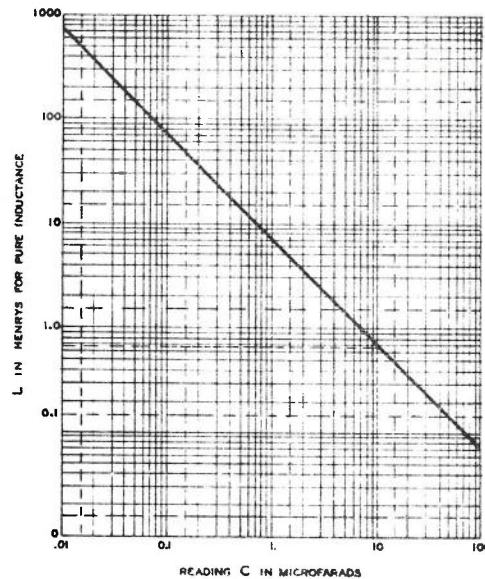

Figure 4-4. Inductance Curve for 60 Cycles

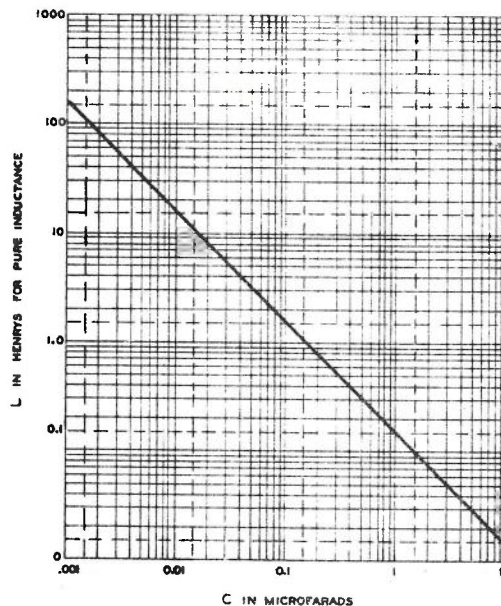

Figure 4-5. Inductance Curve for 400 Cycles

After a value of C is obtained for an unknown inductance, refer to figure 4-4 for the value of L. For example if C were 10 microfarads, the inductance L would be 0.7 henrys as shown by the dotted lines.

(3) **IMPEDANCE.** - True impedance cannot be measured by means of the Capacity Meter Section of the Tube Tester. However, impedances can be approximately determined by considering the unknown impedance to be a pure capacitive or inductive reactance. The value of capacitance in microfarads or the inductance in henrys is found as explained in the preceding paragraphs. This value is then converted to reactance in ohms at the circuit frequency. This reactance is the approximate value of the impedance at the circuit frequency.

The above applies to inductances with a Q between 1 and 10 at the power source frequency and to capacitors with a power factor from 0.1 to 1. Inductances with a Q greater than 10 at power source frequency can be termed pure inductances, and the values obtained will be correct to + 20%.

Most power transformers and inter-stage audio coupling transformers have Q's on the order of 1 to 3 at audio frequencies. For a Q less than 1 measure the component as a resistor, using the resistance curves of figure 4-3.

Capacitors with a power factor less than 0.1 are measured directly on the meter. Those having power factors greater than 1 should be measured as resistors.

(4) **VOLTAGE SOURCE.** - The Tube Tester can be used as a source of variable AC voltage. This is done by plugging Electrical Leads 491899 into pins 2 and 7 of the regular octal socket and turning on the power. The position of the FILAMENT SELECTOR then determines the magnitude of voltage between the Electrical Leads. To check a pilot lamp with this voltage, place the FILAMENT SELECTOR at the lamp's rated voltage, or nearest value, before touching the lamp contacts with the Leads. The voltage and current outputs available for each position of the FILAMENT SELECTOR SWITCH are given in Table 4-2.

TABLE 4-2. VOLTAGE AND CURRENT OUTPUT FROM TUBE TESTER

FILAMENT SELECTOR POSITION	VOLTAGE OUTPUT (V)	MAX. LOAD CURRENT (A)
1.1	1.1	3
1.5	1.5	3
2	2.0	3
2.5	2.5	3
3	3.0	3
5	5.0	3
6.3	6.3	2
7.5	7.5	2
10	10.0	.6
12.6	12.6	.6
19	19.0	.3
25	25.0	.3
28	28.0	.3
35	35.0	.3
50	50.0	.150
70	70.0	.150
117	117.0	.150

3. SIGNAL TRACER TS-673/U.

a. **LIMITATIONS.** - This unit requires a 105-125 volt, 50-1600 cycle power source. In conjunction with the Test Prod MX-933/U and RF Cable Assembly, it can be used as an amplifier for AF voltages from 47 to 15,000 cycles, with its output fed to an oscilloscope, an electronic voltmeter, or a telephone receiver, as indicated by the markings on its front panel (see figure 1-3.) The meter (M-201) indicates the magnitude of the output voltage. A typical application is the

tracing, stage by stage, of an audio signal through an audio amplifier.

This unit, in combination with Test Prod MX-934/U, can also be used as a detector and amplifier for modulated RF voltages. Its over-all sensitivity when used as a detector-amplifier is such that a 0.005 volt RF signal modulated 50% will give an audible output in the telephone receiver. Refer to Section 1, Technical Summary for additional data on the meter sensitivity.

CAUTION

Do not apply more than 20 RF volts to the Test Prod MX-934/U.

b. **OPERATION OF SIGNAL TRACER TS-673/U.** - The Power Cable Assembly, stowed in the Cord and Test Lead Holder, is connected to the Signal Tracer as shown in figure 1-3 and plugged into a 105-125 volt, 50-1600 cycle power source. Accessory parts, which include the RF Cable Assembly CG-570/U (3' 0"), Navy Type CTE-491898 Telephone Receiver, Navy Type CAOR-491901 Headband, Test Prod MX-934/U and Test Prod MX-933/U are contained in the Accessory Case and are shown assembled in figure 1-3.

The Test Prods are assembled to the RF Cable Assembly by turning the prods into the bakelite covered connector on the cable. The other end of the cable is attached to the input contact of the Signal Tracer. Provision is made for directly plugging a grounding lead into both Prods and also in the front panel of the Signal Tracer. When working with RF signals, the ground is made at the Prod. The equipment being tested should also be grounded. The output of the Signal Tracer is indicated by the arbitrary scale meter (M-201) on the front panel of the Signal Tracer. The output of the Signal Tracer can also be applied to an oscilloscope or electronic tube voltmeter by connecting electrical leads to the jacks marked VTVM, SCOPE. The lower terminals marked G on the front panel are chassis ground. If an audible indication of AC voltage is desired, the Telephone Receiver can be connected with two electrical leads to the jacks marked PHONES. The magnitude of the output is adjusted by the control marked LEVEL ADJ. Turning this control clockwise increases the over-all gain of the amplifying circuit.

To trace a signal through an audio amplifier that does not operate, Test Prod MX-933/U is connected to the RF Cable Assembly and Signal Tracer. The faulty amplifier is plugged into its proper power source and its chassis grounded to earth. The Signal Tracer is grounded to the amplifier chassis and plugged into its power source. Both units are allowed to warm up. The test signal can be obtained by using the Interference Generator or any audio oscillator. If the Interference Generator is used, its tip is applied directly to the probe tip of the Signal Tracer and the LEVEL ADJ. turned so that the output indicates on the meter (M-201) scale. The Interference Generator is excited and its tip applied to the input of the amplifier; at the same time, the probe tip of the Signal Tracer is touched to the plate of the first tube. A greater indication on meter (M-201) shows that the tube is operating. The LEVEL ADJ. is then turned counter-clockwise, until the meter is back on scale. The next stage is tested by placing the Signal Tracer probe tip on the plate of the second tube and again exciting the input. An increase in output indicates operation of the circuits between the input and the plate of the second stage. This procedure is continued until a stage is found not operating, and the same step-by-step method is applied to determine the faulty component of that stage, whether it is a tube, capacitor, resistor, etc.

c. **TYPICAL APPLICATIONS.** - A few applications of the Signal Tracer and accessories are listed below.

(1) With Test Prod MX-933/U the Signal Tracer can be used as an audio amplifier to increase the sensitivity of oscilloscopes and electronic voltmeters.

(2) With Test Prod MX-933/U and the Telephone Re-

ceiver the Signal Tracer can be used to trace audio or pulse signals, stage by stage, through an amplifier. The Interference Generator can be used to excite the input of an amplifier. A rough gain check can be obtained during the signal tracing process. This is accomplished (signal source on) by setting the LEVEL ADJ. control of the Signal Tracer (Prod at input of the amplifying stage) for a meter reading of 1/2 scale of M-201. Take LEVEL ADJ. control reading. Move Prod to output of stage. Take LEVEL ADJ. control reading again for 1/2 scale on M-201. To determine voltage gain of stage divide the second reading by the first.

(3) With the Test Prod MX-934/U and Telephone Receiver the Signal Tracer can be used to detect audio modulated RF fields and to trace audio modulated IF and RF signals in IF and RF amplifiers. When the Test Prod MX-934/U tip is extended with the Extension Rod, the equipment can be used as a radio receiver near transmitter antennas. The Prod tip is placed about five feet from (or closer but never touching) the antenna. Audio modulated signals will be heard in the earphone. Only the key clicks will be received on CW operation.

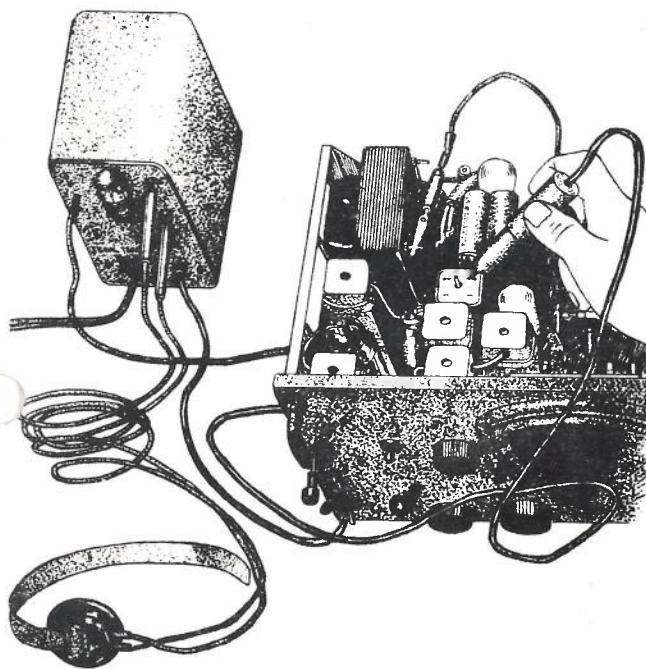

Figure 4-6. Detecting Signal in IF Stage of Radio Receiver with Signal Tracer and Test Prod MX-934/U

(4) When used with Test Prod MX-934/U, Interference Generator SG-23/U and the Telephone Receiver, the Signal Tracer can test RF amplifiers. A signal is generated with the Interference Generator and traced with the Signal Tracer from stage to stage. Normally an increase in gain is expected from the input of a stage to the output. This may not be true in the following cases:

(a) A decrease in output may occur due to the step-down ratio of the output transformer.

(b) When using the Interference Generator, a gain may not be realized in tuned stages, due to reduced band width.

(c) A mixing or converter stage may not give an increase in gain, depending on design.

(5) When connected to the Test Prod MX-933/U, the Signal Tracer can be used as a null voltage indicator. The sensitivity of AC impedance bridges can be increased by connecting the bridge output into the input of the Signal Tracer. Care should be taken that both the Signal Tracer and the ground side of the bridge are externally grounded at the same point.

(6) When used with Test Prod MX-934/U and Extension Rod the Signal Tracer is a radio interference locator. A common source of radio interference is the arcing at the brushes of electric motors. With the aid of the Telephone Receiver as a detector, the Prod is moved into the vicinity of the suspected motors. Once the interference can be heard in the earphone, the Prod is moved in the direction of loudest signal to the arcing brushes.

(7) The Test Prod MX-934/U and Signal Tracer can be used to check the approximate gain of RF and IF amplifier stages. (See paragraph 4c.) (A sine wave generator must be used for these gain tests, as the generated signals from the Interference Generator are attenuated rapidly by tuned circuits, and this unit can only be used for audio gain checks.)

(8) With Test Prod MX-934/U the Signal Tracer can be used for servicing low level RF lines. To check a line for center conductor continuity, open the line at a jack and place the Prod near the center conductor. Audio modulation of the RF voltage is detected through the earphone. An RF line carrying its maximum power should not be opened. A mismatch may occur with arcing of the line.

(9) The RF Test Prod MX-934/U can be used as a demodulator for an oscilloscope or an electronic voltmeter. Figure 4-7 shows the relation between 50% modulated IF or RF voltage input and modulation voltage output of the Prod.

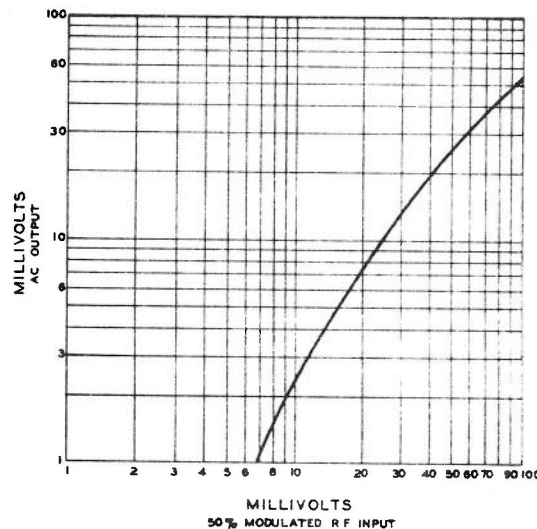

Figure 4-7. Curve Showing Modulated RF, IF Voltage Input to Test Prod MX-934/U vs. AC Output Voltage

(10) For connecting an electronic voltmeter, telephone receiver or oscilloscope to the Test Prod MX-934/U, a simple adapter for the RF Cable Assembly can be constructed. An input jack assembly (J-203) from the spare parts of the Test-Tool Set can be obtained and short lengths of wire soldered to its output terminals. The wires can then be stripped and attached to any electronic voltmeter or oscilloscope.

(11) The Telephone Receiver can be used with the 0.25 mfd. capacitor of the Decade Capacitor TS-671/U to trace audio signals when amplification is not required.

(12) Open circuits in wires can be detected by tracing a signal along the path of the wire. This signal can be generated by the Interference Generator and detected with Test Prod MX-934/U connected to the Signal Tracer.

(13) The Test Prod MX-934/U with adapter mentioned in paragraph (10) above can be connected to an AC electronic voltmeter to indicate modulated RF voltages of weak oscillators.

(14) In applications on radar sets, the Telephone Receiver can be used to check the existence of trigger pulses from the modulator unit to the indicator unit of less than 600

volts peak. This is done by disconnecting the cable at the indicator unit panel and connecting the earphone in series with a 0.25 mfd. capacitor of the Decade Capacitor across the cable terminals. A loud tone will indicate that the pulses from the modulator unit are reaching the indicator unit panel.

(15) Pulses at IF frequencies in radar sets can be detected by use of the Test Prod MX-934/U and amplified by the Signal Tracer. Pulses can be detected on the output of the Signal Tracer by means of the Telephone Receiver or an oscilloscope. Pulse shapes observed on the oscilloscope will generally be distorted due to the limited band width of the Signal Tracer.

(16) Video pulses can be traced with the audio Test Prod MX-933/U and the Signal Tracer with Telephone Receiver. In cases where the signal is of a high level and some distortion is allowable, the Telephone Receiver in series with a 0.25 mfd. capacitor can sometimes be used directly.

CAUTION

Many video signals exceed the voltage rating of Test Prod MX-934/U, since the germanium diode will only withstand 50 volts maximum peak inverse. Random probing must not be done due to the high voltages likely to be encountered.

In signal tracing, a loss of gain is usually experienced in stages containing output or matching transformers. The voltage ratio of a transformer is related to the matching impedances by the following formula:

$$\text{Voltage Ratio} \left(\frac{E_{\text{in}}}{E_{\text{out}}} \right) = \sqrt{\frac{\text{Impedance in } (Z_{\text{pri}})}{\text{Impedance out } (Z_{\text{sec}})}}$$

For example: Some typical output tubes, impedances of transformers usually used with these tubes, and the voltage ratios of these transformers are tabulated below:

Single Tube	Pri Impedance (ohms)	Output Impedance (ohms)	Voltage Ratio
6L6, 25L6, 35L6 and 50L6	2500	4 500	25:1 2.2:1
Push-Pull Tubes			
Two 6V6's or two 45's	7000 (plate to plate)	4 500	42:1 3.8:1

4. INTERFERENCE GENERATOR SG-23/U.

a. LIMITATIONS. - This device has a fundamental audio output of about 2000 cycles. The harmonics generated by the buzzer contacts and the sharp wave fronts extend into the radio frequency range.

In general, this unit is used to supply an input signal to electronic amplifying circuits, while observing the effect on the output voltage.

b. OPERATION OF INTERFERENCE GENERATOR SG-23/U. - Pressing the button at the top of the unit places the buzzer in operation. Touching the probe tip to the grid or plate terminal will excite the circuit. If audio output is desired, place index at POSITION 1. For higher frequencies, place index between 2 and 10. Greatest attenuation of output occurs at POSITION 10. The unit can be grounded by plugging a Navy Type CAOR-491895 lead into the small hole back of the tip as shown in figure 1-4. Usually, this ground is not required.

This device may be used with Test Prod MX-933/U and the Signal Tracer, its index set to POSITION 1 to feed audio circuits, as described in Paragraph 3b, Section 4. It may also be used with Test Prod MX-934/U and Signal Tracer combination, with its index set on POSITION 2 through 10, to excite RF circuits. The Extension Rod (C-904) can be attached to the tip of the Interference Generator to provide a means for reaching into a deep chassis, especially if high voltage exists on exposed contacts which the technician might accidentally touch while using this unit.

c. TYPICAL APPLICATIONS. - The following list indicates some of the uses of the Interference Generator.

(1) It can be used to energize audio circuits for signal tracing purposes.

(2) It can also be used to generate a signal in RF and AF tuned circuits for signal tracing purposes.

(3) The Interference Generator can be used with the Telephone Receiver to "ring" out cables and check continuity of wiring. Care must be taken that an operation of this type does not interfere with needed services. The Resistance Indicator-Probe is probably more desirable to use in these cases.

(4) With the Signal Tracer, the Interference Generator can be used to measure audio amplifier gain. Refer to paragraph 4 c (2) to see how this is done.

(5) The Interference Generator can be used as a triggering device for multi-vibrator circuits.

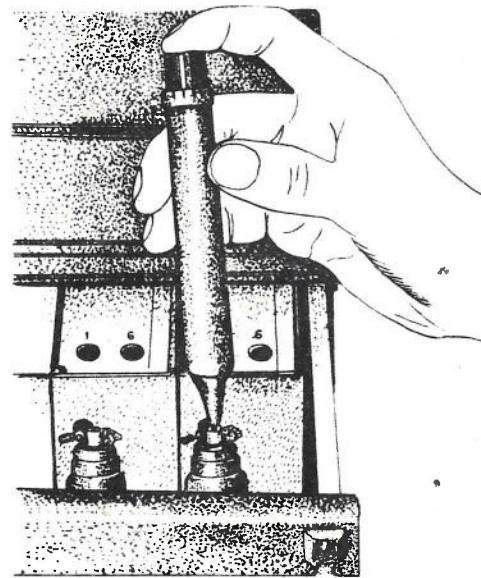

Figure 4-8. Using the Interference Generator for Testing an RF Tuned Circuit

5. VOLTAGE INDICATOR-PROBE ID-265/U.

a. LIMITATIONS. - While measuring voltage magnitudes from zero to 440 volts AC or DC, this instrument also indicates whether the source is AC or DC and the polarity of the source if DC; the tip is positive (+) when the Polarity Indicator (M-401) moves toward the + side. The AC voltage frequency range is 10 to 10,000 cycles. The total internal resistance of the circuit is 500,000 ohms. A typical use of this unit is to determine the presence of line voltage. It is not a precision instrument, and no attempt should be made to read exact voltages.

b. **OPERATION OF VOLTAGE INDICATOR-PROBE ID-265/U.** - An electrical lead with banana plug end is plugged into the top of the Probe to complete the circuit. The meter indicates the approximate voltage magnitude across these terminals. (See figure 1-5.)

If a DC supply voltage is being measured, the return lead is usually clipped to the chassis of the equipment under test and the probe tip touched to the voltage point of interest. The polarity of the tip is indicated by the instrument marked **POLARITY**. A deflection toward (+) means the probe tip is positive. The instrument marked **VOLTS** moves up-scale for either polarity of applied voltage. The Extension Rod (0-904) without its plastic tip can be attached to the end of the unit to increase the prod length when used near high voltages.

c. **TYPICAL APPLICATIONS.** - The paragraphs below show some of the uses for this unit.

(1) The presence and magnitude of line voltage at junction boxes and power transformers can be indicated. Figure 4-9 shows the Probe in use indicating the presence of AC voltage at a power supply transformer.

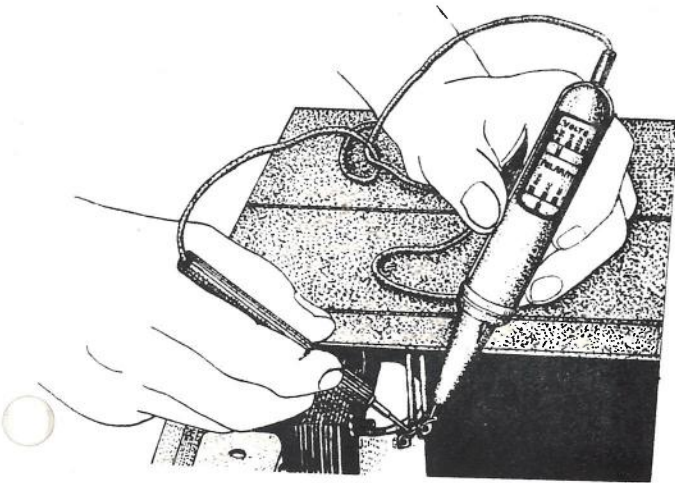

Figure 4-9. Measuring Line Voltage on Transformer with Voltage Indicator-Probe

(2) The magnitude of DC plate voltages in amplifiers and other electronic equipment can also be indicated up to 400 volts.

(3) The Voltage Indicator-Probe can indicate audio signal on transformer secondaries.

(4) Audio voltage in the presence of DC can be indicated by connecting the 0.1 mfd. capacitor of the Decade Capacitor in series with the Probe.

(5) The Voltage Indicator-Probe can be used on audio tuned circuits as a peaking meter. Also the IF circuits of a radio receiver can be aligned approximately by using this Probe as a peaking meter to indicate audio output while adjusting the trimmer capacitors of IF coils with Alignment Tool (H-917).

(6) The Alignment Tool consists of a bakelite rod with a brass slug in one end and a steel slug in the other. The steel slug is also shaped like a screwdriver bit for adjusting trimmer capacitors. Placing the brass slug into a coil lowers its inductance; placing the steel slug in the coil raises its inductance. This effect is used in the tuning of IF and RF tuned circuits. If the output of a tuned amplifier is decreased by inserting either end of the tool into a tuned coil, that coil is aligned with the other tuned circuits. If inserting the brass slug increases the output, reduce the tuning capacity by means of the screwdriver bit. If inserting the steel slug increases the output, increase the tuning capacity. A wave signal generator, audio, IF or RF, should be used

as a voltage source for aligning and tuning such circuits instead of the Interference Generator SG-23/U.

(7) The Voltage Indicator-Probe can be used to indicate high resistance by placing the unknown resistance in series with the Probe and an approximate 300 volt DC source E. The resistance R in kilohms is then calculated by the formula:

$$R = 500 \left(\frac{E}{\text{Reading in Volts}} - 1 \right), \text{ Kilohms}$$

(8) It can also be used to measure, for test purposes, the voltages available at the pins of tube sockets with the tube removed. Adapters in the Navy Type-49992 Adapter Kit will make these measurements possible from the top of the socket with the tube in the circuit.

6. RF INDICATOR-PROBE ID-263/U.

a. **LIMITATIONS.** - This Probe will indicate the presence of electric RF fields near oscillators and power amplifiers. The sensitivity is approximately 25% of full scale for 1 volt of RF energy applied to the tip at 3.5 megacycles, and is used to determine the presence of intense electric radio frequency fields such as exist around transmitters and other RF oscillators. The direct connected sensitivity of the unit as given in the Technical Summary of Section 1 was obtained by actually connecting a 1 volt source of 3.5 megacycles to the tip, the return path being provided by a metal shield over the top of the probe. The sensitivity with Extension rod (0-904) is a calculated value at a high frequency and at the best is only approximate.

b. **OPERATION OF RF INDICATOR-PROBE.** - The probe is held in the operator's hand with the tip pointing in the direction of greatest RF electric field. The manner in which the Probe is held may change the sensitivity slightly. The smaller the capacitive impedance between the operator's hand and the meter frame (inside and at the top); the greater will be the sensitivity. If the Probe is not held in hand but is isolated, the sensitivity is lower. If the field is strong, no contact with the probe tip is required. For smaller fields the point is touched to the source. For hard-to-reach places or near high voltage terminals, plug the Extension Rod (0-904) onto the tip of the Probe.

CAUTION

Approach the source slowly, watching the instrument. Do not let the pointer go off-scale, especially when making a direct connection to the tip. Near high voltage, use the Extension Rod to remove the hand as far as possible from the danger area.

When the Extension Rod is used without the plastic cover, a direct connection exists between the tip of the Extension Rod and the probe tip. This is used for small fields to touch the actual source of radiation.

c. **TYPICAL APPLICATIONS.** - Some of the uses to which this Probe can be put are listed below.

(1) The RF Indicator-Probe will indicate the presence of intense radiation from antennas or RF transmitters. Figure 4-10 shows the method of use of this Probe near an antenna. This is a direct test for radiation, and will show if the overall transmitter and antenna are operating. The Probe indicates the electric field and will give maximum indication near the ends of the dipole antenna. A test of operation for a transmitter would be to move the Probe into the vicinity of the output tubes and coils. An intense source of radiation, such as in this example, should be approached cautiously with the Probe, so as not to overload the internal germanium

diodes and meter.

(2) This Probe will indicate the presence of electric RF fields near local oscillator coils in radio receivers.

(3) It can be used to detect nulls and maximums along whip and dipole antennas and open transmission lines.

(4) Transmitter antennas can be adjusted as to length and tuned to a particular frequency by placing the RF Indicator-Probe near the energized antenna and observing the meter deflection. The antenna is adjusted for maximum meter deflection.

(5) RF bypass capacitors in circuits in which the RF can be indicated directly by the probe, can be checked by touching the tip of the Probe to the RF side of the capacitor. No, or a very small, meter deflection should be observed on a good capacitor.

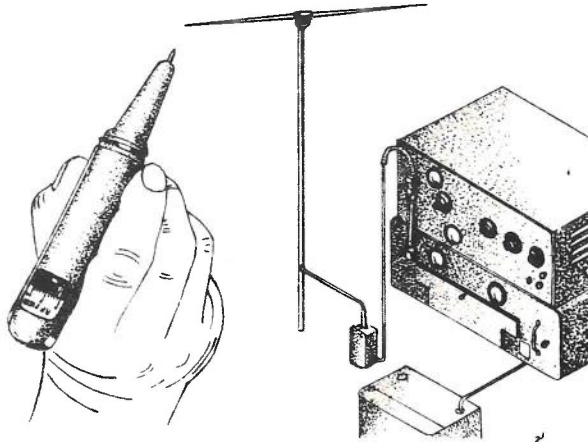

Figure 4-10. Checking RF Output of Radio Transmitter at Antenna with RF Indicator-Probe

7. RESISTANCE INDICATOR-PROBE ID-264/U.

a. LIMITATIONS. - This Probe can indicate circuit continuity and resistance values between zero and 10,000 ohms. The instrument should be shorted and zero checked before using. This is not a precision instrument and cannot be used to measure critical values of resistance.

b. OPERATION OF RESISTANCE INDICATOR-PROBE ID-264/U. - This unit is first checked for zero resistance by shorting the test lead to the metal probe tip. The meter pointer should move up scale and on past the 500 ohm mark when terminals are shorted. If the pointer does not reach the 500 ohm mark, the battery should be replaced (see figure 3-1.) Approximate values of resistance in ohms are indicated directly on the scale. The accuracy can be increased by proportionally correcting for the amount off on the zero test.

c. TYPICAL APPLICATIONS. - A few of the uses for the Resistance Indicator-Probe are listed in the following paragraphs.

(1) This unit will measure approximate resistance values in the range from 0 to 10,000 ohms.

(2) It will indicate continuity of wiring.

(3) The forward and reverse resistances of crystal rectifiers and small copper-oxide rectifiers can be indicated. The tip of the Probe is positive.

(4) Electrolytic capacitors can be tested for short by placing the tip of the Probe to the positive side of the capacitor and return lead to the negative side with one end of the capacitor disconnected. Figure 4-11 shows the Probe being used to test an electrolytic capacitor.

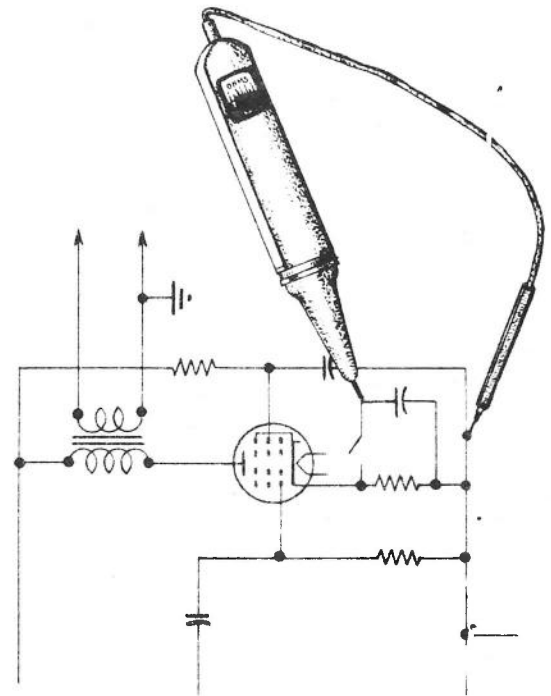

Figure 4-11. Checking an Electrolytic Capacitor in a Radio Receiver with Resistance Indicator-Probe

8. DECADE RESISTOR TS-672/U AND DECADE CAPACITOR TS-671/U.

These units are designed for use as substitution and test resistors and capacitors, having the full range of values required for test, temporary repair or trouble-shooting of electronic equipment.

a. LIMITATIONS AND TYPICAL APPLICATIONS. - The Decade Resistor unit can be used to obtain values of resistance from one ohm to 12 megohms. Each resistor in the case is rated at two watts dissipation and care should be taken when using this decade to make sure that the energy dissipation per resistor does not exceed this value. The accuracy is $\pm 5\%$. The total dissipation inside the decade case should not be permitted to exceed 10 watts.

The Decade Capacitor can be used to obtain values of capacitance between 0.0001 and 48 microfarads. The capacitors in the range of 0.0001 microfarads to 0.25 microfarads have a DC working voltage rating of 600 volts. The electrolytic 20/4 mfd. capacitors are rated at 450 VDC. Polarity of electrolytic condensers must be observed. The accuracy is $\pm 10\%$ for the paper capacitors and $-0 + 75\%$ for the electrolytic capacitors.

b. OPERATION OF DECADE RESISTOR AND DECADE CAPACITOR. - The resistors in this unit can be placed in series by means of Navy Type CAOR-491895 Electrical Leads as shown in figure 1-8 in which the decade resistor is connected so that 8 megohms is between the probe tips.

The capacitors in Decade Capacitor may be hooked up in parallel by electrical leads as shown in figure 1-9. These capacitors have values normally required for test and substitution in electronic equipment. Their DC voltage ratings should not be exceeded. If large AC currents and voltages are involved in the use of paper capacitors, care must be exercised that the peak AC voltage does not exceed the DC working voltage rating. A safe value of AC current through the mica and paper capacitors for frequencies up to 30 megacycles is 0.1 ampere.

CAUTION

Polarity of electrolytic capacitors must be observed. Never allow the positive terminal to become negative with respect to the common (NEG) terminal.

When using the electrolytic capacitors in alternating current circuits (where no DC voltages or currents are involved) the two NEG terminals are connected together and the substitution capacity taken as that between the positive terminals of equal value. This is the only way that the electrolytic capacitors can be used on straight AC; in all other cases the electrolytic capacitors must be biased positively with a DC voltage that is 20% greater than the peak AC voltage, but less than 450 volts DC.

c. **TYPICAL APPLICATIONS.** - Both units may be used independently or in combination as shown below.

(1) The Decade Resistor and Decade Capacitor can be used individually for substitution tests in any electrical circuit, provided the ratings as given in Table 1-4, Technical Summary are not exceeded. To check a capacitor by the substitution method, one lead or connection of the suspected component must be unsoldered and the proper value from the Decade Capacitor connected into the same position in the circuit by means of electrical leads. If one side of a component is at ground voltage level, only the high side should be unsoldered. This will lower stray capacitances. The stray capacities created by the addition of leads and Decade boxes may interfere with the operation of critical circuits. To check a resistor by the substitution method, the value of resistance from the box should be selected and inserted across the resistor. Figure 4-12 shows the method of substituting both units.

(2) Both units can be connected in series and used as an RC time constant or phase shift network.

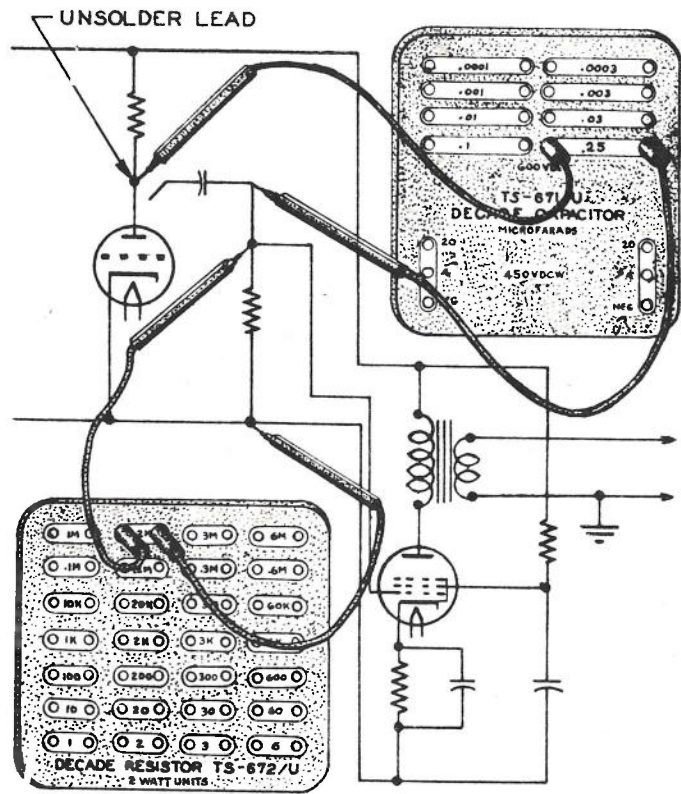

Figure 4-12. Substituting Decade Resistor and Decade Capacitor in an Electronic Circuit

WARNING

ELECTRONIC EQUIPMENT OPERATES AT DANGEROUS VOLTAGES

STOP ! LOOK ! THINK !

Men have been killed by very low voltage circuits. As little as 30 volts may be fatal under the proper combination of circumstances.

Haste, heedlessness, attempts to work where there are distracting noises, and attempts to carry on a conversation while servicing lead to material and personnel casualties.

FAILURE REPORTS

A FAILURE REPORT must be filled out for the failure of any part of the equipment whether caused by defective or worn parts, improper operation, or external influences. It should be made on Failure Report, form NBS-383, which has been designed to simplify this requirement. The card must be filled out and forwarded to BUSHIPS in the franked envelope which is provided. Full instructions are to be found on each card.

Use great care in filling the card out to make certain it carries adequate information. For example, under "Circuit Symbol" use the proper circuit identification taken from the schematic drawings, such as T-803, in the case of a transformer, or R-207, for a resistor. Do not substitute brevity for clarity. Use the back of the card to completely describe the cause

of failure and attach an extra piece of paper if necessary.

The purpose of this report is to inform BUSHIPS of the cause and rate of failures. The information is used by the Bureau in the design of future equipment and in the maintenance of adequate supplies to keep the present equipment going. The cards you send in, together with those from hundreds of other ships, furnish a store of information permitting the Bureau to keep in touch with the performance of the equipment of your ship and all other ships of the Navy.

This report is not a requisition. You must request the replacement of parts through your Officer-in-Charge in the usual manner.

Make certain you have a supply of Failure Report cards and envelopes on board. They may be obtained from any Electronics Officer.

ELECTRONIC EQUIPMENT FAILURE REPORT (SIG)			NAVSHIPS (NBS) 383 (REV. 11-45)		NOTICE—Read notes on cover prior to preparing this form.	* REPORT No. _____
ORGANIZATION PERFORMING MAINTENANCE			NAME AND RANK OF OFFICER ACCOUNTABLE FOR MAINTENANCE			
EQUIPMENT INVOLVED						
<input type="checkbox"/> Navy	<input type="checkbox"/> Army	<input type="checkbox"/> USMC	<input type="checkbox"/> JAH	<input type="checkbox"/> Commercial	<input type="checkbox"/> Other _____ (Specify)	
<input type="checkbox"/> Radio	<input type="checkbox"/> Radar	<input type="checkbox"/> Sonar	<input type="checkbox"/> Wire	<input type="checkbox"/> Tool	<input type="checkbox"/> Test	<input type="checkbox"/> Power <input type="checkbox"/> Sound <input type="checkbox"/> Other _____ (Specify)
EQUIPMENT MODEL DESIGNATION		SERIAL NUMBER OF EQUIPMENT		NAME OF CONTRACTOR		CONTRACT NO.
TYPE NUMBER AND NAME OF MAJOR UNIT INVOLVED		SERIAL NUMBER OF UNIT		CONTRACT OR PO DATA OF UNIT		DATE EQUIPMENT RECEIVED
ITEM WHICH FAILED						
THIS SIDE FOR TUBES			THIS SIDE FOR PARTS (NOTE 9)			
TUBE TYPE, INCLUDING PREFIX LETTERS		SERIAL NO. (NOTE 4)		NAME OF PART		CIRCUIT SYMBOL (eg R-134)
TUBE MANUFACTURER		CONTRACT NO. (NOTE 4)		SERIAL NO.	*CONTRACT DATA	*DATE RECD.
FAILURE OCCURRED IN		GUARANTEED HOURS (NOTE 5)	DATE OF ACCEPTANCE (NOTE 6)	*CHECK-OFF OR TAG DATA (NOTE 9)		*MANUFACTURER'S DATA (NOTE 9)
<input type="checkbox"/> Storage	<input type="checkbox"/> Operation	ACTUAL HOURS	DATE OF FAILURE	BRIEF DESCRIPTION AND CAUSE OF FAILURE, INCLUDING APPROXIMATE LIFE (CONTINUE ON BACK)		
<input type="checkbox"/> Handling	<input type="checkbox"/> Other (Specify in remarks)	TYPE OF FAILURE (NOTE 7)	TUBE CIRCUIT SYMBOL (NOTE 8)			
<input type="checkbox"/> Installation	NATURE OF FAILURE AND REMARKS (NOTE 4) (CONTINUE ON BACK)					
CONCLUSION:						
<input type="checkbox"/> Normal replacement	<input type="checkbox"/> Shortage	<input type="checkbox"/> Misdiagnosis	<input type="checkbox"/> Failure	<input type="checkbox"/> Transportation breakage	<input type="checkbox"/> Other _____ (Specify)	
*NOT REQUIRED FOR REPORTS SUBMITTED BY NAVAL ACTIVITIES.						16-46651-1 U. S. GOVERNMENT PRINTING OFFICE

Figure 5-1. Failure Report, Sample Form

SECTION 5 MAINTENANCE

1. TUBE TESTER TV-4/U.

In case of trouble with the Tube Tester, the following procedure should be followed before attempting to repair the unit.

Connect the Tube Tester with the line cord to a 115 volt AC power line. Index the CIRCUIT SELECTOR switch to the LINE SHORT CHECK position. The Tube Tester meter should show a reading near the center of the scale. Rotate the LINE CONTROL knob to set the meter pointer to the LINE CHECK mark. Obtain a directly heated or filament type tube for test purposes. Locate the tube type number in the Tube Data Index; set the FILAMENT SELECTOR to the required voltage and insert the tube in the correct socket. With the CIRCUIT SELECTOR in the LINE SHORT CHECK position, and all the electrode switches in the OUT position, move the A switch to the IN position. The SHORT INDICATOR lamp should glow, indicating that the neon lamp is functioning correctly. Complete the tests on the tube to be sure that the device is operating normally.

Remove the tube, and index the CIRCUIT SELECTOR to one of the capacity ranges. Plug in a pair of test leads in the capacity jacks, and short circuit the test prods. Rotate the LINE CONTROL for full scale pointer deflection on each capacity range. In general the capacity ranges will function normally if this full scale setting can be made on each range assuming that the power line potential is within ± 10 volts of the nominal 115 volt amplitude.

CAUTION

Do not attempt to open case before reading instructions under paragraph 1b.

a. PRELIMINARY TESTS. - If the Tube Test section or Capacity Meter Section are not operating properly, the following performance checks should be carried out.

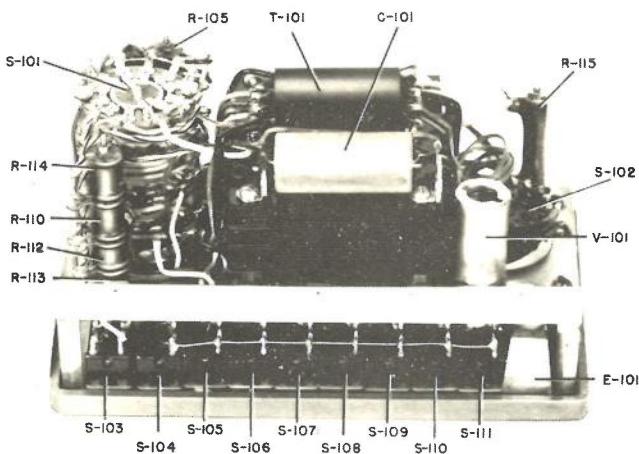

Figure 5-2. Side View of Tube Tester TV-4/U, Case Removed

In servicing the Tube Tester TV-4/U perform only those repairs necessary to make the device function properly. Remember that most of the resistors are precision adjusted. Unless the component indicates a direct short or open circuit, the method of test must involve the standardization of the equipment being used to make these tests. Since most faults will be opens, shorts or a mechanical failure, ordinary test equipment can be used to repair most of the difficulties. Therefore, before attempting to check the individual components check the fuse and line cord and then try to localize the failure into one or more of the first 6 categories listed below:

- (1) Completely dead unit.
- (2) Neon lamp lights all the time or when one of toggle switches is indexed to the IN position. No tube should be placed in a test socket while making this check.
- (3) Low or no line check indication.
- (4) Indication too high on total emission checks.
- (5) Inability to make top mark on capacity meter ranges.
- (6) Capacity meter in error.
- (7) Defective components.
- (8) After classifying the fault as above, disassemble the unit and proceed as outlined under paragraph 1 c, Section 5, where detail checks are given for each fault above. The line cord and fuse are checked immediately if the unit is apparently dead.

b. DISASSEMBLY PROCEDURE. - The Tube Tester in addition to its outer case has three main assemblies: the socket panel, chassis and bakelite panel. These three sections should never be separated at one time, unless the repair personnel is absolutely certain that such procedure is the only course, or that the ensuing instrument readings indicate that it is necessary.

(1) TUBE TESTER CASE REMOVAL. - The case is removed from the instrument as follows:

- (a) Remove the three screws that fasten the top side

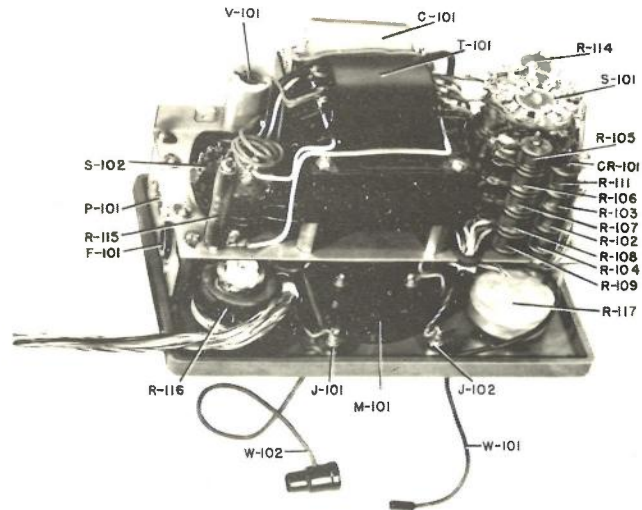

Figure 5-3. Angle View of Tube Tester, Case Removed

- of the hinge to the Tube Tester TV-4/U.
- (b) Lift the Tube Tester out of the test kit.
- (c) Place the Tube Tester on the bench with the socket panel face up.
- (d) Remove the line cord.
- (e) Remove the five button head screws around the three edges of the socket panel.

CAUTION

DO NOT REMOVE ANY OF THE FRONT PANEL SCREWS

(f) Pull the bottom of the case away from the bakelite panel. The socket panel will stay affixed to the bakelite panel, but the case which forms the bottom, ends and opposite side of the device will come off.

(2) SOCKET PANEL REMOVAL.

- (a) Remove outer case as per previous paragraph.
- (b) Remove the two corner screws at the top of the bakelite panel nearest the socket panel.
- (c) Carefully lift socket panel away from the bakelite panel and then pull away from the chassis.
- (d) Unsolder only those leads from the terminal board that go either to the chassis or bakelite panel. Many repairs can be made by just pulling the socket panel away from the Tube Tester without unsoldering any wires to the terminal plate, since the cable is quite long.

(3) CHASSIS REMOVAL FROM BAKELITE PANEL.

- (a) Remove outer case as per previous paragraphs.
- (b) Remove socket panel as per previous paragraph.
- (c) Remove the knobs and nuts from the FILAMENT SELECTOR and the CIRCUIT SELECTOR controls.
- (d) Remove the four panel screws fastening the four chassis posts to the panel.
- (e) Lift the chassis away from the panel and lay it to one side. The leads in the cable are sufficiently long so that connections need not be unsoldered.

c. DETAILED CHECKS. - The following checks are given for each of the faults listed in paragraph 1 a above.

- (1) A completely dead unit can be caused by open primary in T-101, burnt out line control R-116, bad fuse or line cord, or an open meter.
- (a) The line control is a 350 ohm 25 watt unit and can

be readily checked by the Resistance Indicator-Probe. Unsolder the leads to the outside terminals before testing. If the component is defective, remove the chassis assembly from the bakelite panel. See paragraph 1 b (3).

(b) See point to point resistance measurements for determining defective transformer or meter.

(2) A lighted neon lamp with no tube in the test sockets indicates a short in the socket panel wiring, at the terminal strip mounted on the socket panel, in the wiring to S-101 or a short at the terminals on the transformer T-101. Check for the shorts as follows:

(a) Start with all toggle switches in the OUT position and index the CIRCUIT SELECTOR through all positions including the capacity meter ranges. A lighted neon lamp indicates a short in the wiring to the CIRCUIT SELECTOR switch, incorrect wiring on those units where a replacement of the CIRCUIT SELECTOR switch has been made, or a short at the transformer terminals.

1. Mechanically inspect lead dress at S-101 and T-101.

2. Repeat above checks.

(b) With CIRCUIT SELECTOR in LINE SHORT CHECK position index each of the toggles separately to the IN and then return to the OUT position. A lighted neon lamp indicates a short in the socket panel or at the terminal strip on the socket panel.

1. Unsolder the wires that come from the chassis to the terminal strip.

2. Fan out these unsoldered leads and repeat the check. If no short is indicated, the socket panel is faulty.

3. Using an ohmmeter that gives a good indication on two megohms, check between each connection on the terminal strip to locate the shorted leads. An indication of two megohms, or lower, will cause trouble.

NOTE

Do not use solder paste or acid core solder, as it will cause such high leakage currents that the short check will become completely inoperative, requiring that all components on the socket panel be discarded. Use only rosin mixed in alcohol as a flux or a good grade of rosin core solder.

(3) Low or no line check involves only three compon-

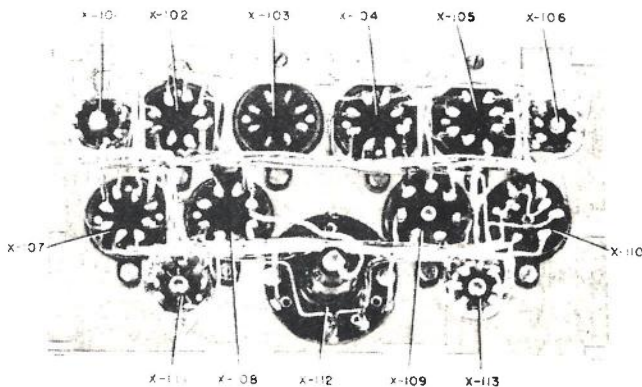

Figure 5-4. Rear View of Socket Panel of Tube Tester TV-4/U

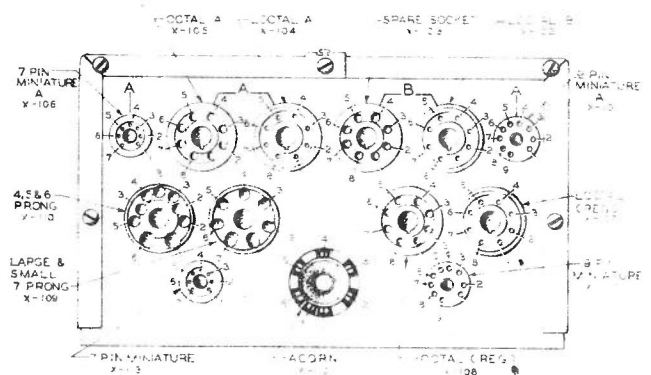
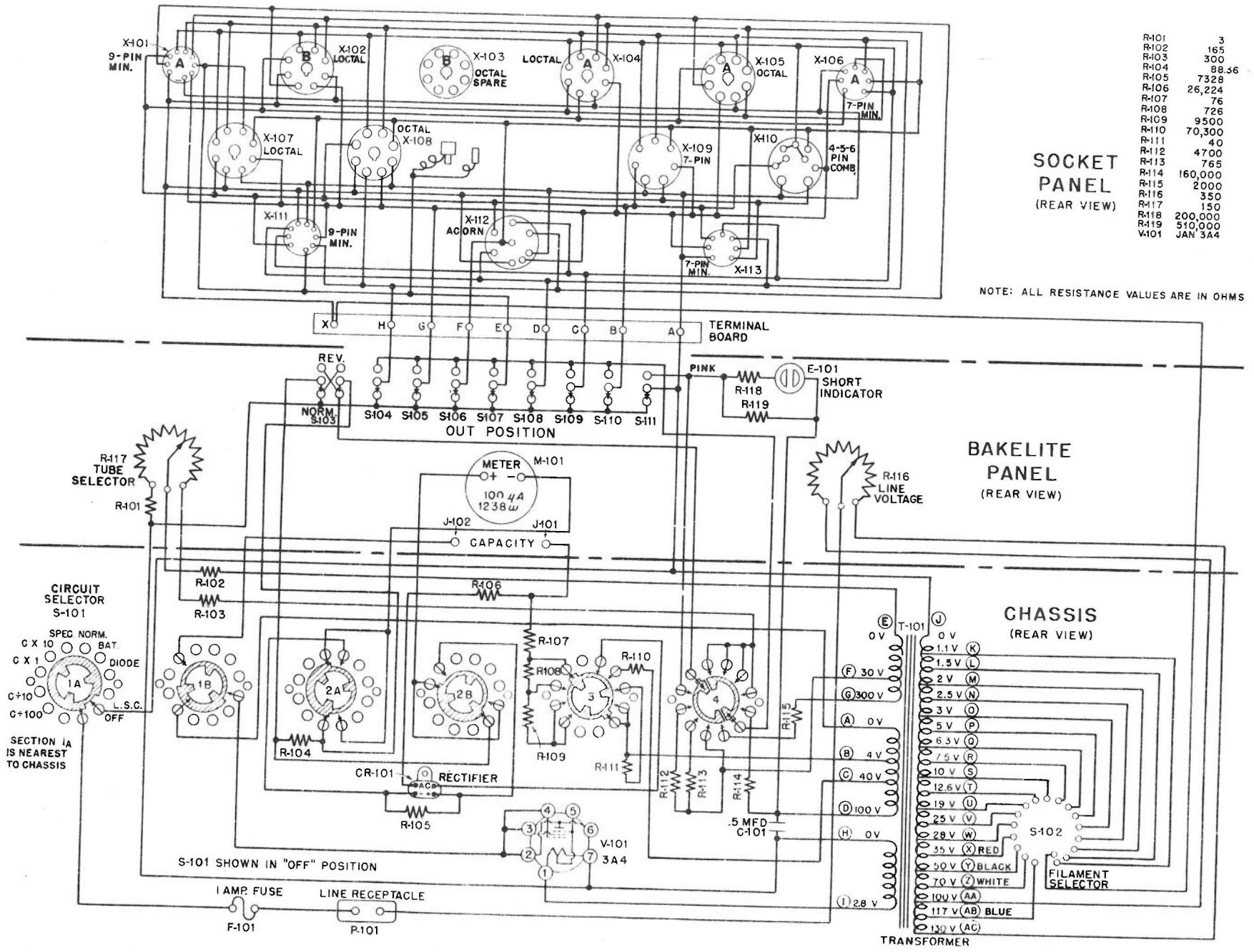

Figure 5-5. Front View of Sockets Showing Pin Numbers



R-101	3
R-102	165
R-103	300
R-104	88.56
R-105	7328
R-106	26,224
R-107	76
R-108	726
R-109	9500
R-110	70,300
R-111	40
R-112	4700
R-113	765
R-114	160,000
R-115	2000
R-116	350
R-117	150
R-118	200,000
R-119	510,000
V-101	JAN 3A4

SOCKET PANEL
(REAR VIEW)

NOTE: ALL RESISTANCE VALUES ARE IN OHMS

BAKELITE PANEL
(REAR VIEW)

CHASSIS
(REAR VIEW)

Figure 5-6. Schematic Diagram of Tube Tester TV-4/U

ORIGINAL

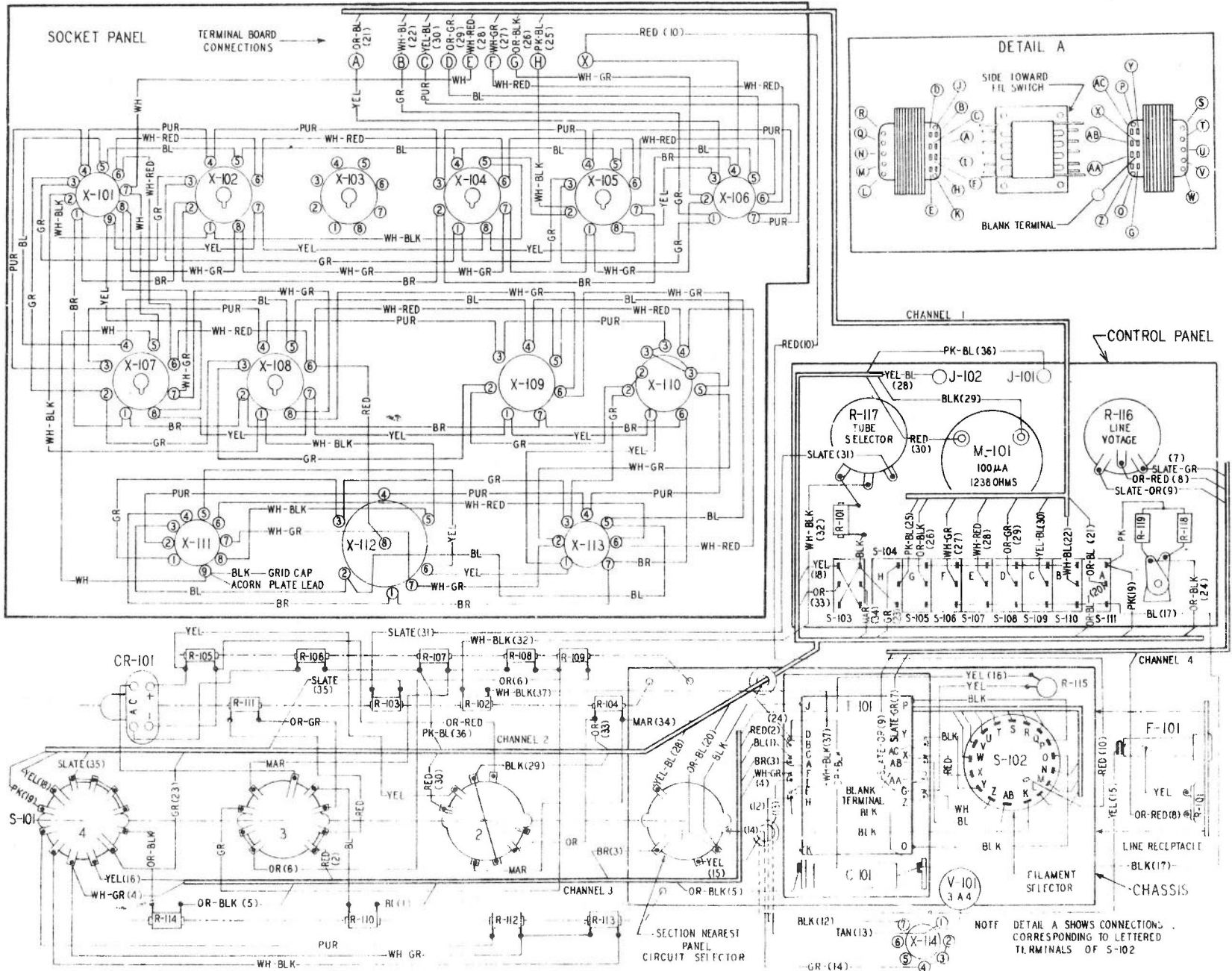

Figure 5-7. Wiring Diagram of Tube Tester TV-4/U

ORIGINAL

5-5

NOTE: DETAIL A SHOWS CONNECTIONS CORRESPONDING TO LETTERED TERMINALS OF S-102

TABLE 5-1. RESISTANCE TABLE FOR TUBE TESTER

COMPONENT TO BE CHECKED	TEST LEADS ACROSS	RESISTANCE VALUE (OHMS)	TUBE SELECTOR POSITION	CIRCUIT SELECTOR SWITCH POSITION	REMARKS (Take apart only those sections noted and unsolder only those connections noted.)
R-101	R-101	$3 \pm 1/2\%$	-	CX10	Unsolder leads from one side of spool.
R-102	R-102	$165 \pm 1/2\%$	-	OFF	
R-103	R-103	$300 \pm 1/2\%$	-	CX10	
R-104	R-104	$88.36 \pm 1/2\%$	-	CX10	
R-105	R-105	$7328 \pm 1/2\%$	-	-	
R-106	R-106	$26,224 \pm 1/2\%$	-	NORMAL	
R-107	R-107	$76 \pm 1/2\%$	-	NORMAL	
R-108	R-108	$726 \pm 1/2\%$	-	NORMAL	
R-109	R-109	$9500 \pm 1/2\%$	-	NORMAL	
R-110	R-110	$70,300 \pm 1/2\%$	-	NORMAL	
R-111	R-111	$40 \pm 1/2\%$	-	NORMAL	
R-112	R-112	$4700 \pm 1/2\%$	-	OFF	
R-113	R-113	$765 \pm 1/2\%$	-	OFF	
R-114	R-114	$160,000 \pm 1/2\%$	-	OFF	
R-115	R-115	$2,000 \pm 10\%$	-	OFF	
R-116	R-116	$350 \pm 10\%$	-	-	
R-117	R-117	$150 \pm 10\%$	-	CX10	
Adjustment of R-117	Junction of R-117-R-101 and the center terminal R-118	$27 \pm 1/2\%$	40	CX10	
R-118	R-118	$200,000 \pm 10\%$	-	OFF	
R-119	R-119	$510,000 \pm 10\%$	-	OFF	
Primary of T-101 and S-102	Pins 1&7 on large 7 prong socket	See Remarks	-	-	
M-101	Meter Studs	$1238 \pm 1\%$	-	-	
S-101	Pin 1 of 4-5-6 prong socket and pin 3 of Reg. octal socket Same as above	Infinity	-	OFF	
	Same as above	$650,000 \pm 10\%$	48	LINE SHORT CHECK DIODE	
	Same as above	$4870 \pm 10\%$	48		
	Same as above	$930 \pm 10\%$	48	Bat. Tubes	
	Same as above	$175 \pm 10\%$	48	NORMAL TUBES	
	Same as above	$2300 \pm 10\%$	48	SPECIAL	
	Capacity Jacks	$75 \pm 10\%$	-	CX10	
	Capacity Jacks	$785 \pm 10\%$	-	CX1	
	Capacity Jacks	$7,850 \pm 10\%$	-	C + 10	
	Capacity Jacks	$79,000 \pm 10\%$	-	C + 100	

TABLE 5-2. POINT-TO-POINT VOLTAGES ON TUBE TESTER FOR T-101 AND LINE SHORT CHECK CIRCUITS

COMPONENT OR CIRCUIT TO BE CHECKED	TEST LEADS ACROSS	VOLTAGE A-C	CIRCUIT SELECTOR SWITCH POSITION	TOGGLE SWITCH TO IN POSITION (ALL OTHERS TO OUT POSITION)	FILAMENT SELECTOR SWITCH POSITION	REMARKS
T-101	Filament Pins (#1&4) on 4-5-6 prong Socket	115	LINE SHORT CHECK	-	117	All voltage checks on T-101 are made with LINE VOLTAGE control rotated so that potential on 117 volt position of FILAMENT SELECTOR is 115 volts. (Test leads across filament pins of 4-5-6 prong socket). Voltages shown are exact and correction for any error in the test meter should be made. Use a 1,000 ohm/volt ac instrument.
	Same as above	69.1	Same as above	-	70	
	Same as above	47.8	Same as above	-	50	
	Same as above	33.8	Same as above	-	35	
	Same as above	27.75	Same as above	-	28	
	Same as above	25.1	Same as above	-	25	
	Same as above	18.9	Same as above	-	19	
	Same as above	12.72	Same as above	-	12.6	
	Same as above	10.3	Same as above	-	10	
	Same as above	7.53	Same as above	-	7.5	
	Same as above	6.32	Same as above	-	6.3	
	Same as above	5.0	Same as above	-	5	
	Same as above	3.1	Same as above	-	3	
	Same as above	2.5	Same as above	-	2.5	
	Same as above	2.01	Same as above	-	2	
	Same as above	1.54	Same as above	-	1.5	
	Same as above	1.19	Same as above	-	1.1	
	Terminals A&B on T-101	4.05	NORMAL	-	-	
	Terminals A&C on T-101	40.7	NORMAL	-	-	
	Terminals A&D on T-101	96.7	NORMAL	-	-	
	Terminals E&F on T-101	29.5	NORMAL	-	-	
	Terminals E&G on T-101	303	NORMAL	-	-	
	Terminals H&I on T-101	2.86	NORMAL	-	-	
Line Short Check Circuit	A&B on socket panel terminal strip	-	LINE SHORT CHECK	B	1.1	Set to LINE CHECK mark by rotating LINE VOLTAGE control. Use 20,000 ohm/volt dc instrument, 250 volt range. Positive of meter to A terminal reads 115 V DC.

ents, V-101, C-101 and R-114, the line check resistor.

(a) A burnt out V-101 or an open R-114 will cause the line check indication to be zero.

(b) An open C-101 will cause the line check indication to be about 5 or 6 on the 50 division arc.

NOTE

Low line check will cause short check sensitivity to be low or zero.

(4) Tubes reading too high as indicated by a number of tubes giving off scale readings is caused by incorrect adjustment of the line check resistor R-114, TUBE SELECTOR control or both.

(a) To adjust line check resistor R-114 proceed as follows:

1. Connect by means of Electrical Leads an 8 or 10 volt a-c meter of known accuracy to the filament leads.

2. Index FILAMENT SELECTOR to 7.5 volts, rotate CIRCUIT SELECTOR to LINE SHORT CHECK position.

3. If there is a small carbon resistor in series with R-114 solder a shorting lead across it.

4. Rotate LINE VOLTAGE control until the meter of known accuracy indicates 7.3 volts.

5. The indication on the Tube Tester meter should be at the LINE CHECK line or higher. If not replace V-101 with a new type 3A4 tube.

6. Insert sufficient resistance in series with R-114 to bring the line check indication to the LINE CHECK division on the Tube Tester meter scale. The resistance to be inserted may run between 1,000 and 20,000 ohms. Any 1/4 or 1/2 watt resistor will be satisfactory.

(b) To adjust TUBE SELECTOR control R-117 proceed as follows:

1. Index CIRCUIT SELECTOR to any one of the capacitor ranges.

2. Set the TUBE SELECTOR control to 40 and measure the resistance between the center terminal and the outside terminal to which the resistance spool R-101 is soldered. The reading should be 27 ohms $\pm 1/2\%$. (This measurement should be made on a bridge or on a series ohmmeter that has been standardized against an accurate 27 ohm resistor.)

3. The position of the TUBE SELECTOR control has

TABLE 5-3. POINT-TO-POINT VOLTAGES ON TUBE TESTER FOR FILAMENT AND SOCKET WIRING

CIRCUIT TO BE CHECKED	VOLTAGE A-C	TOGGLE SWITCH TO IN POSITION (ALL OTHERS TO OUT POSITION)	TEST LEADS ACROSS PIN NUMBER												REMARKS	
			7 PIN MINIATURE A	OCTAL A	LOCTAL A	OCTAL B	LOCTAL B	9 PIN MINIATURE A	4-5-6 COMB.	7 PRONG LARGE & SMALL	OCTAL (REG.)	LOCTAL (REG.)	7 PIN MINIATURE	ACORN		9 PIN MINIATURE
Fil. Socket Wiring	5	-	3-4	8-7	8-2	-	7-2	9-1	1-6	1-7	7-2	8-1	1-7	6-1	5-4	FILAMENT SELECTOR at 5. Use 1,000 ohm/volt a-c instrument. FILAMENT SELECTOR 5. TUBE SELECTOR at 49. CIRCUIT SELECTOR at NORMAL. If voltage is 24, the filament leads to the socket are reversed. If voltage is 0 the socket wiring or wiring from toggle switches to the socket terminal board is incorrect.
	29	B	3-1	8-3	8-1	-	7-3	9-3	1-2	1-2	7-3	8-2	1-3	6-3	5-1	
	29	C	3-7	8-4	8-3	-	7-4	9-4	1-3	1-3	7-4	8-3	1-4	6-4	5-2	
	29	D	3-5	8-5	8-4	-	7-5	9-5	-	1-4	7-5	8-4	1-5	6-2	5-3	
	29	E	-	-	-	-	-	9-7	1 & Grid Caps	-	-	8-5	-	-	5-9	
	29	F	3-6	8-6	8-6	-	7-6	9-6	1-4	1-5	7-6	8-6	1-6	6-8	5-6	
	29	G	3-2	8-1	8-7	-	7-8	9-8	1-5	1-6	7-8	8-7	1-2	6-7	5-7	
	29	H	-	8-2	8-5	-	7-1	9-2	-	-	7-1	-	-	6-5	5-8	

been carefully adjusted at the factory for correct tracking in resistance with the 0 to 50 panel marking. Before tampering with the location of this potentiometer, the operator should be certain that it requires re-positioning on the panel by following the procedure outlined in the preceding paragraph using an accurate resistance measuring device.

(5) Inability to make a top mark adjustment on all of the capacity meter ranges and yet be able to obtain a correct line check indication when using the Tube Tester, indicates that the small instrument rectifier mounted on top of one of the spool pins is damaged, that the 26,224 ohm resistor (R-106) or the 7328 ohm resistor (R-105) are either opened or partially shorted.

(a) Index CIRCUIT SELECTOR to NORMAL TUBES position and check R-106 and R-105. In checking R-105, unsolder the leads from one side of the spool.

(b) If R-105 and R-106 are satisfactory the instrument rectifier is defective.

(6) Error in the capacity meter indication can be caused by defective resistors R-106, R-107, R-108, R-109, R-110 or R-111 or rectifier CR-101. If the resistors mentioned are satisfactory replace the instrument rectifier.

(7) To locate defective components proceed through the tables that follow. The checks listed in the previous paragraphs should be made first, any necessary repairs made and rechecked to determine if satisfactory operation can be obtained. Note that all resistors except R-115, R-118 and R-119 must be measured to within 1/2 of 1%. Controls R-116 and R-117 have a tolerance of ± 10%. Failure to heed the accuracy limits may result in unsatisfactory performance of the Tube Tester or capacity meter.

(a) In the Table 5-1 and Table 5-2 a dash (-) in a given column indicates that the position of the control or switch is of no consequence.

(b) In Table 5-3 a dash (-) with no other figures under the column head indicates that a voltage measurement is not

to be made on that particular socket or that the toggle switch position is of no consequence. Pin numbers in the columns refer to standard R.M.A. notation except for the 4-5-6 combination and acorn sockets. All pin numbers as viewed from the top of panel are given in figure 5-5.

(c) If when making the resistance and voltage measurements shown in Tables 5-1, 5-2, and 5-3, a discrepancy is noted from the given value, refer to the Schematic Diagram of the Tube Tester TV-4/U, figure 5-6, and note the components involved. These components should be individually checked for a defect. Figure 5-7, Wiring Diagram of Tube Tester TV-4/U, will aid in the location of components and connecting wires.

2. SIGNAL TRACER TS-673/U TROUBLE SHOOTING.

Test the fuse (F-201) and line cord for continuity with the Resistance Indicator-Probe before attempting to locate trouble in the chassis. To remove the case from the Signal Tracer, unscrew the two screws at the rear of the unit (these are the bottom screws which hold the legs in place.) DO NOT REMOVE THE SCREWS ON THE FRONT PANEL.

All replaceable components are easily reached and can be located as shown in figures 5-8, 5-9, and 5-10. The pilot light (E-203) on the front panel (shown in figure 5-8) can be replaced by unsoldering its leads. The fuse (F-201) is mounted in a clip on top of the chassis as shown in figure 5-9. The point-to-point voltages listed in Table 5-4 are helpful in trouble shooting on the Signal Tracer and are used in conjunction with the Schematic Diagram (figure 5-11) and figures 5-8, 5-9 and 5-10. These voltages were measured with an electronic voltmeter such as the Navy Model OBQ Series or equivalent. For an indication of the presence and approximate magnitude of AC or DC voltage greater than 55 volts, the Voltage Indicator-Probe may be used. GND is the chassis. The Wiring Diagram of Signal Tracer TS-673/U, fig-

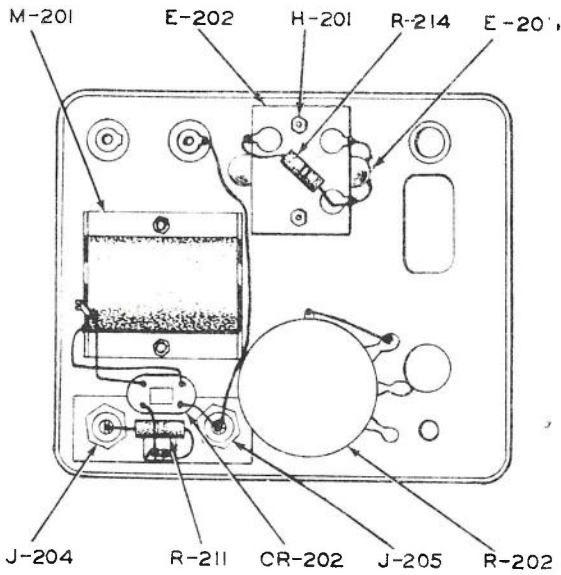

Figure 5-8. Rear View Front Panel, Signal Tracer TS-673/U

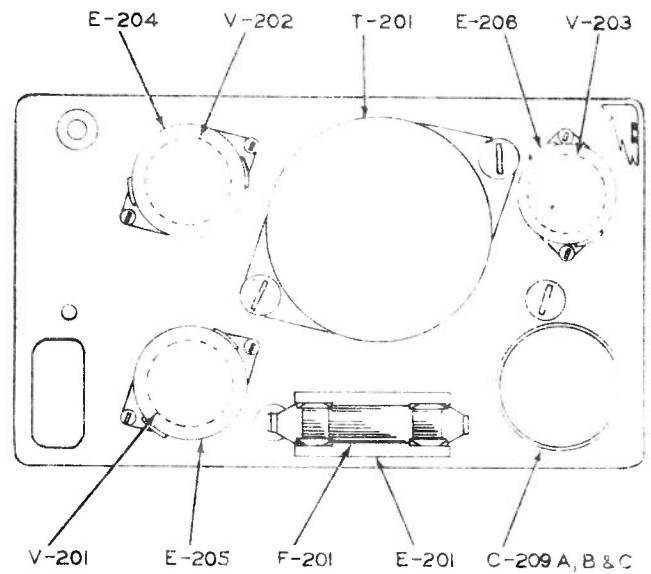

Figure 5-9. Top View, Signal Tracer Chassis

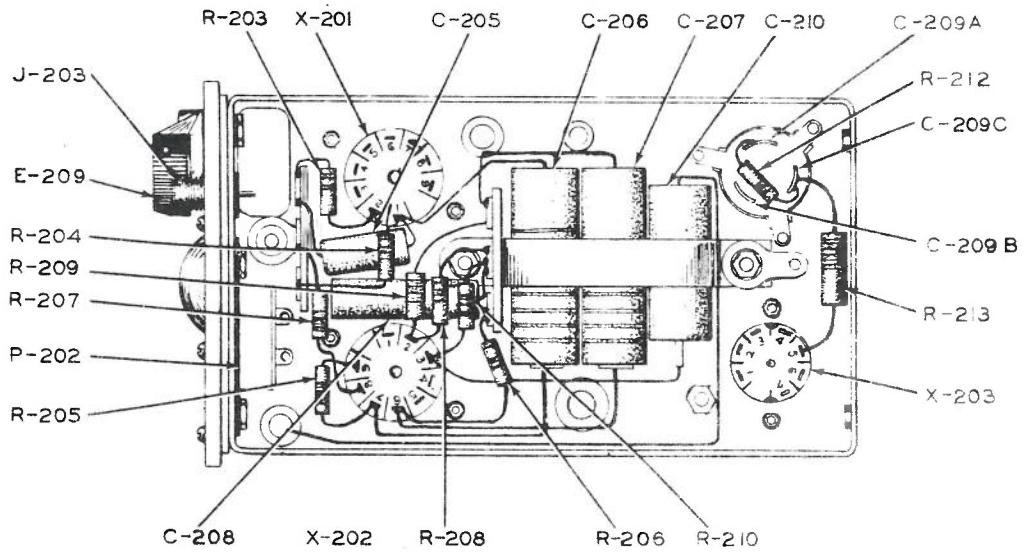

Figure 5-10. Bottom View, Signal Tracer Chassis

ure 5-12 is used to locate the test points.

The indicating meter (M-201) can be replaced by (1) removing the two flathead screws at the rear of the Signal Tracer case and slipping off the cover, (2) unsoldering one wire and removing the screw and wire lug of the other wire at the top of the instrument, (3) removing the round-head shields (X-201) and (X-202), (4) removing the instrument from the rear, (5) removing the two round-head screws that hold the metal frame to the new instrument and replacing with the fillister-head screws, and (7) reversing the procedure outlined above by replacing the instrument and screws in the front panel and connecting the two wires to the instrument.

**3. INTERFERENCE GENERATOR SG-23/U
TROUBLE SHOOTING.**

The 1-1/2V battery in this unit should be changed at regular intervals or as indicated by erratic behavior of buzzer.

TABLE 5-4. POINT-TO-POINT VOLTAGES, SIGNAL TRACER TS-673/U

COMPONENT	TERMINALS	OPERATING NORMAL VOLTAGE TO GROUND	
V-201	1-GND	80	VDC
V-201	4 or 5-GND	6.3	VAC
V-202	1-GND	150	VDC
V-202	3-GND	0.5	VDC
V-202	4 or 5-GND	6.3	VAC
V-202	6-GND	110	VDC
V-202	8-GND	0.5	VDC
V-203	1 or 5-GND	180	VDC
V-203	3-GND	6.3	VAC
V-203	7-GND	150	VAC
V-203	2-GND	150	VAC

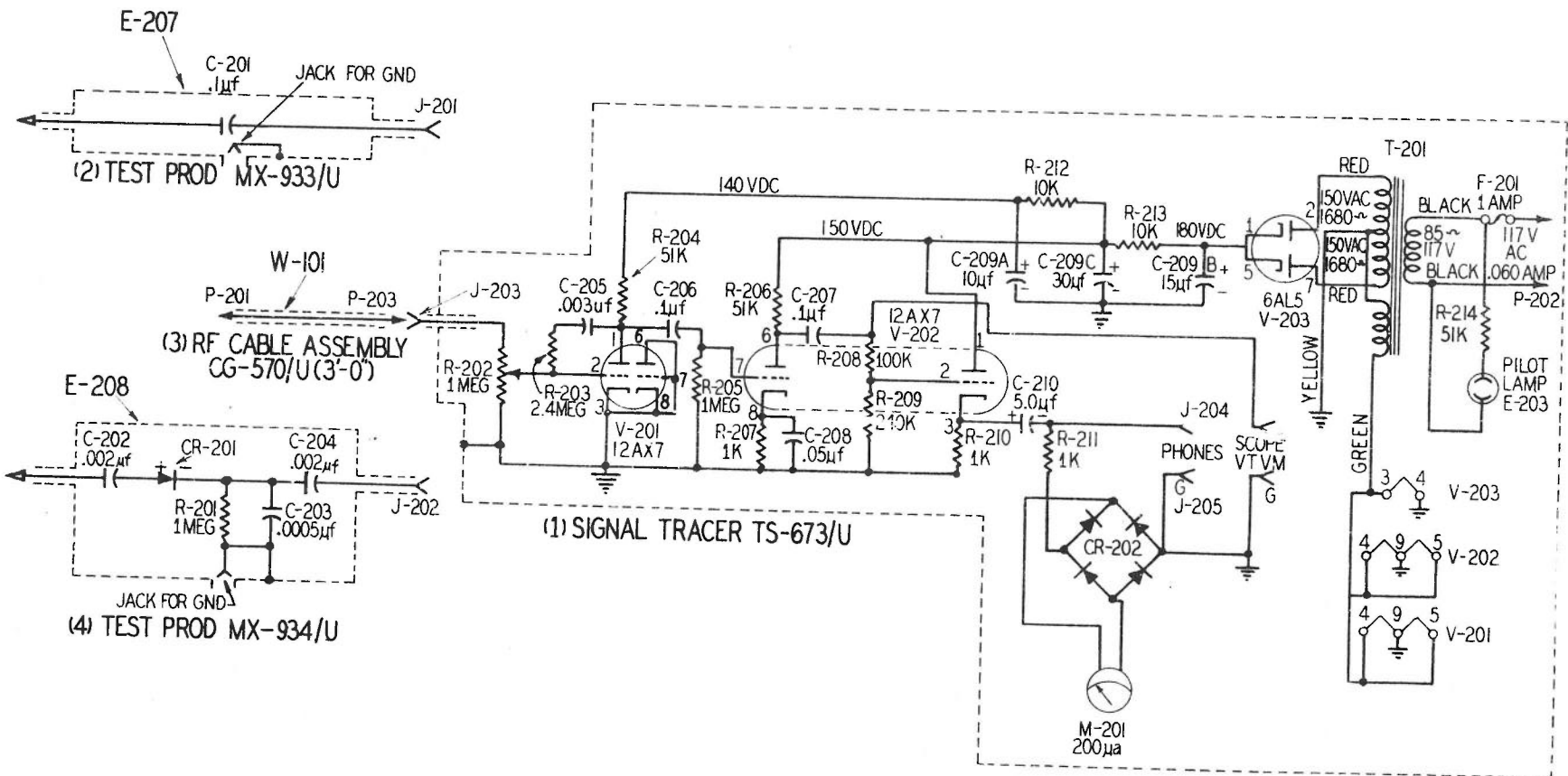

Figure 5-11. Schematic Diagram, (1) Signal Tracer TS-673/U, (2) Test Prod MX-933/U, (3) RF Cable Assembly CG-570/U (3'0") and (4) Test Prod MX-934/U

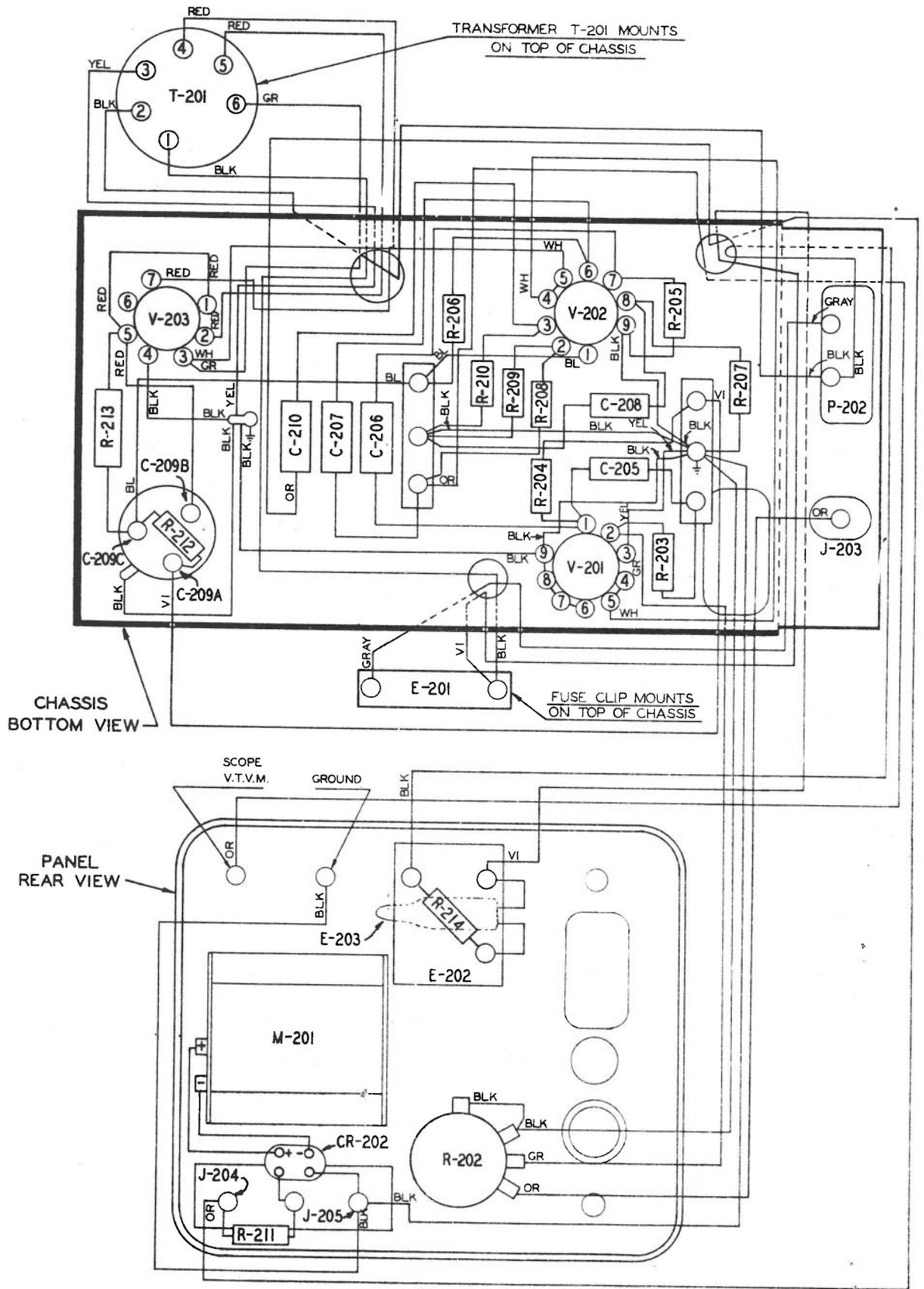

Figure 5-12. Wiring Diagram of Signal Tracer TS-673/U

The unit can be taken apart by loosening the clamp ring (See figure 3-2) and dropping out the components. The half-round screw head in the index button, BATTERY ADJUST SCREW in figure 3-3, adjusts for a change in battery length. When a new battery is installed, it may be necessary to turn this screw in or out until the INNER TIP touches the OUTER TIP only on POSITION 1 of the Index (see figure 2-4). Contact between the two tips can be tested by making a connection with an electrical lead between the shield of the unit and the OUTER TIP. Making this connection will stop the buzzer if the tips are in contact. The sound generated by the buzzer is audible. If the buzzer fails to operate, change the position of the buzzer ADJUSTMENT SCREW shown in figure 3-3. The adjustment of this screw is quite critical, as it controls the mechanical force between the vibrating element contact and the stationary contact. The screw is turned by means of a small screwdriver and the vibrating contacts adjusted to just touch and make electrical connection without appreciable spring force. This is best done by connecting the Resistance Indicator-Probe across the contact members and observing the indication while turning the screw. The buzzer mechanism itself can not be dismantled.

5. RF INDICATOR-PROBE ID-263/U, DISASSEMBLY.

This unit is disassembled by removing the spring clamp with a small screwdriver gently, as indicated in figure 3-1. Care should be taken that the condenser (C-501) and the spring contact in the probe tip are not lost in this operation. The instrument (M-501) and crystal rectifiers (CR-501) and (CR-502) can be taken from the cover after removing the plastic screw at the top of the probe.

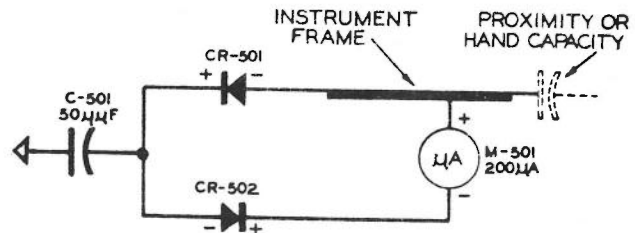

Figure 5-15. Schematic Diagram, RF Indicator-Probe ID-263/U

6. RESISTANCE INDICATOR-PROBE ID-264/U, DISASSEMBLY AND REPAIR.

This probe is checked before use for short or zero position by touching the tip with the electrical lead plugged in the top as shown in figure 1-7. If the pointer does not fall below 500 ohms on the scale, the battery should be changed. The probe is taken apart by removing the spring clamp as shown in figure 3-1. Care should be taken that resistor (R-601) is not dislodged in this operation. The battery is placed in the probe with the positive end toward the tip. The meter (M-601) can be taken from the case after removing the threaded ring nut at the top. A schematic diagram is illustrated in figure 5-16. The return lead of the Resistance Indicator-Probe should not touch the tip while the probe is not in use. Keeping the instrument on short for long periods of time will dissipate the battery.

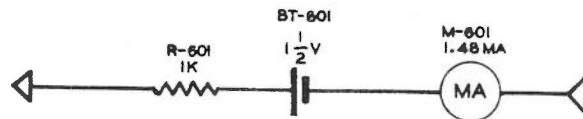

Figure 5-16. Schematic Diagram, Resistance Indicator-Probe ID-264/U

4. VOLTAGE INDICATOR-PROBE ID-265/U, DISASSEMBLY.

To disassemble the probe remove the spring clamp by means of the small screwdriver. Figure 3-1 illustrates the operation. Insert screwdriver as shown and lift end of spring clamps gently. The cover can then be slipped off. The resistor (R-401) can be reached by removing the two screws which hold the probe tip to the brass studs. The resistor can then be dropped out of the probe tip. A schematic diagram of this unit is shown in figure 5-14.

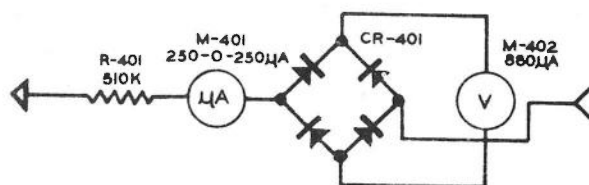

Figure 5-14. Schematic Diagram, Voltage Indicator-Probe ID-265/U

7. REPAIR OF DECADE RESISTOR TS-672/U AND DECADE CAPACITOR TS-671/U.

These units can be repaired after removing the rear cover of each case. Care should be taken that the terminal leads of components being replaced in these cases are not overheated in the soldering process. Schematic diagrams of both units are shown in figures 5-17 and 5-18.

NOTE

The Indicator-Probes, the Interference Generator, the Test Prods and the RF Cable Assembly are not to be disassembled for repair except as covered above. These items will be in stock as complete assemblies for spares.

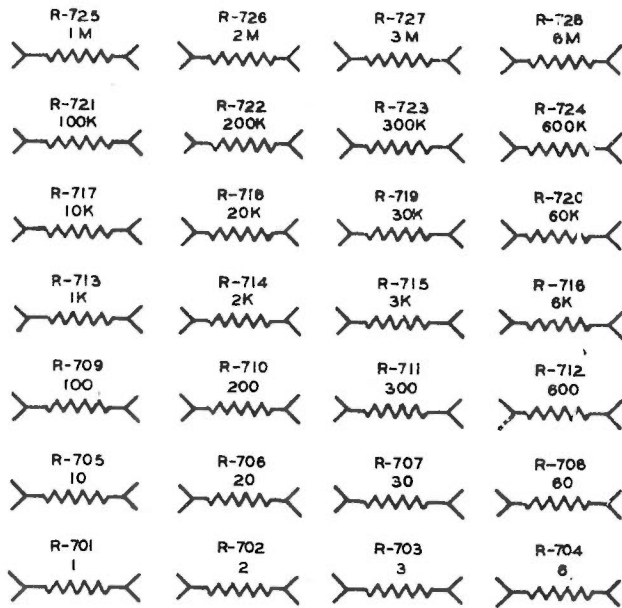

Figure 5-17. Schematic Diagram, Decade Resistor TS-672/U

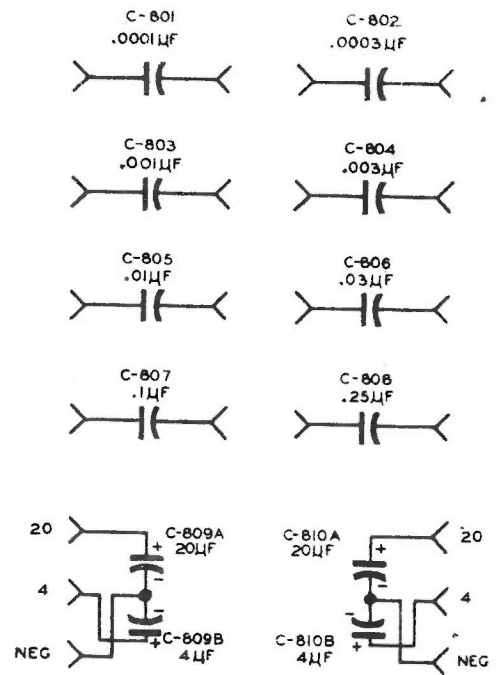

Figure 5-18. Schematic Diagram, Decade Capacitor TS-671/U

CAUTION

This equipment contains sensitive instruments. Precautions must be taken in handling, transportation, and use to prevent damage.

TABLE 5-5. TUBE OPERATING VOLTAGES AND CURRENTS

TUBE TYPE	FUNCTION	SECTION	PLATE (E)	PLATE (MA)	CAT.-I. (E)	GRID (E)	HEATER (E) A-C
3A4	Rectifier						
12AX7	Amplifier	(1)	80	1.0	0	0	6.3
12AX7	Cathode Follower Amplifier	(1) (2)	150 110	0.8 0.55	0.8 0.55	0 0	6.3
6AL5	Rectifier			3.2			

TABLE 5-6. TUBE CHARACTERISTICS

TUBE TYPE	FILA-MENT VOLT-AGE (V)	FILA-MENT CUR-RENT (A)	PLATE VOLT-AGE (V)	GRID BIAS (V)	SCREEN VOLT-AGE (V)	PLATE CUR-RENT (MA)	SCREEN CUR-RENT (MA)	A-C PLATE RESIST-ANCE (OHMS)	VOLT-AGE AMPLI-FICATION FAC-TOR (MU)	TRANSCON-DUCTANCE (MICROMHOS)		EMISSION	
										NOR-MAL	MINI-MUM	IS (MA)	TEST VOLT
3A4	2.8	0.1	135	-7.5	90	14.8	2.6	90,000		1900	1400		
12AX7	6.3	0.3	100	-1.0		0.5		80,000	100	1250	900		
6AL5	6.3	0.3	150 VAC			9.0						500	2

TABLE 5-7. WINDING DATA

DESIGNATION SYMBOL	R. F. L. PART NO.	DIAGRAM	WINDING	WIRE SIZE	TURNS	D. C. RESISTANCE IN OHMS	REMARKS
T-101	H-2463		1 B-C 1 B-D 2 E-F 2 E-G 3 X-Y 3 X-Z 3 X-AA 3 X-AB 3 X-AC 4 A-B 5 H-I 6 J-K 6 J-L 6 J-M 6 J-N 6 J-O 6 J-P 6 J-Q 6 J-R 7 R-S 7 R-T 7 R-U 7 R-V 7 R-W 7 R-X	No. 30 No. 30 No. 30 No. 30 No. 28 No. 28 No. 28 No. 28 No. 22 No. 26 No. 20 No. 20 No. 20 No. 20 No. 20 No. 20 No. 20 No. 20 No. 24 No. 24 No. 24 No. 24 No. 24 No. 24	154 386 124 1286 63 147 253 342 373 17 12 5 6.5 8.5 10.5 13 21 26.5 31.5 12 22 48 74 86 109.5	13.5 34.0 10.9 113.0 3.47 8.1 13.9 18.6 20.5 1.0 1.6 1.8 2.4	1000 VAC Hipot Test
I-301	H-2516			No. 30	100	.77	
T-231	H-2199		Pri. Sec. C.T. Fil.	No. 32 No. 44 No. 25	1364 3770 86	85 2370 1	Core Material - Allegheny Audio Grade Silicon Steel. 750 VAC Hipot Test

**SECTION 6
PARTS LISTS****1. GENERAL**

The Stock Repair Parts furnished for this equipment are supplied in bulk and, therefore, the quantities are not listed. Items in Table 6-2 marked with an asterisk (*) are included in the Stock Repair Parts complement.

TABLE 6-1. LIST OF MAJOR UNITS

SYMBOL GROUP	QUANTITY	NAME OF MAJOR UNIT	NAVY TYPE DESIGNATION
	1	Case	CY-703/U
	1	Tool Holder	CY-704/U
100-199	1	Tube Tester	TV-4/U
200-299	1	Signal Tracer	TS-673/U
300-399	1	Interference Generator	SG-23/U
400-499	1	Voltage Indicator-Probe	ID-265/U
500-599	1	RF Indicator-Probe	ID-263/U
600-699	1	Resistance Indicator-Probe	ID-264/U
700-799	1	Decade Resistor	TS-672/U
800-899	1	Decade Capacitor	TS-671/U

TABLE 6-2. COMBINED PARTS AND REPAIR PARTS LIST

SYMBOL DESIG.	NAME OF PART AND DESCRIPTION	FUNCTION	JAN AND (NAVY TYPE) NO.	STANDARD NAVY AND (SIGNAL CORPS) STOCK NO.	MFGR. AND MFGR'S DESIG- NATION	CON- TRACTOR DRAW- ING & PART NO.	ALL SYMBOL DESIG. INVOLVED	QUAN. EQUIP.	QUAN. EQUIP. REPAIR PARTS
100 to 199	TESTER, TUBE: emission type; 105-125 v 50-1600 cycles; 8-1/4" wd x 5-1/2" d x 5-13/16" h o/a; fil v range 1.1 to 117 v; mts on hinge in case CY-703/U; steel case.	Tube tester	TV-4/U	F16-T-21380-2429 (3F3930-4)	CV Model 685 Type 5	H-2304		1	
C-101	CAPACITOR, FIXED: paper; single section; 500,000 mmf -10+20%; 200 vdcw; HS metal case, w/ins sleeve; 13/16" diam x 2" lg; mineral oil impr and filled; 2 axial wire lead, 2-1/2" lg; no int gnd connections; mtd by term leads.	Line and short check charging	(-484943)	N16-C-47321-9190 (3DA500-146)	CSL #XTM2-5	H-1080-10	C-101	1	
CR-101	RECTIFIER, METALLIC: copper oxide type; input 20 v AC single ph, output 1.6 v, 5 ma max; oval shape, 0.47" lg x 0.52" wd x 0.375" h o/a; one mtg hole 0.128" diam; full bridge instrument type, four 0.130" diam discs, brown dot.	Instrument Rectifier	(-20661)	N17-R-50807-1624 (3F3778-1)	CV D-89368	H-2462	CR-101	1	
E-101	LAMP, GLOW: 105-125 v 1/25 W; starting voltages 65v AC and 90v DC; bulb T-3-1/4 clear; 1-3/16" lg max o/a; miniature bayonet base; GE type W-11 electrodes; any position; requires external resistance 200,000 ohms at 105-125 v; neon gas filled.	Short check indicator		N17-L-6806-130 (2Z5889-17)	GE NE-51	H-2468	E-101	1	
E-102	SHIELD, TUBE: steel; round, open top; bayonet action friction mtg; 13/16" diam x 1-3/4" h, with 15/32" diam top hole; spring in top of can holds tube in socket.	Shield for V-101		N16-S-34557-8367 (2ZK11102.4)	CMG #8661	H-2355	E-102	1	
E-103	FUSEHOLDER: extractor post type; one 8AG cartridge fuse 1/4" OD x 1" lg; phenolic; 250 v 5 amp max; 23/32" diam x 2-1/2" lg o/a; 1/2" x 24 thd for panel hole mtg; 2 solder term.	Line fuse holder		N17-F-74264-9001 (3Z2876-8)	CLF #371001	H-2470	E-103	1	
E-104	*KNOB: bar; black bakelite grade XM-1957; for 1/4" diam shaft; one 0.10" diam x 50 thd dowel type set screw; 1.32" lg x 1/2" wd x 17/32" h o/a.	Control knob		N16-K-700026-101 (2Z5822-250)	CV D-128537	H-2469	E-104	4	
F-101	FUSE, CARTRIDGE: 1 amp; 250 v AC or DC; one time; glass body; ferrule term; 1/4" diam x 1" lg o/a.	Line fuse	(-28041-1)	N17-F-17373-70 (3Z2601.49)	CLF #361001	H-2292	F-101 F-201	2	

ORIGINAL

I-101	LIGHT INDICATOR: clear plastic cap 9/16" x 9/16" less thd; without lens; for miniature bayonet base bulb; 110 v, 1/2w; open frame; nickel plated steel; 15/16" h x 7/8" wd x 1-3/4" lg o/a; 11/16" diam mtg hole; 1/4" max panel thk; lamp replaceable from front; thd type cap; 2 solder term located on base of socket.	Short check lamp holder		N17-L-76742-8038 (2Z5991-108)	CAYZ #810B-937	H-2467	I-101	1
J-101	CONNECTOR, RECEPTACLE: 1 round female contact; straight type; 1/4" diam x 32 thd x 1/2" lg o/a less contact; round nickel plated brass body with hex at term end; silver plated phosphor-bronze contact; mts in 1/4" diam x 32 thd hole.	Capacity test jack		N17-C-73107-7647 (2Z3062-177)	CV D-72923	H-2464	J-101 J-102	2
J-102	CONNECTOR, RECEPTACLE: same as J-101	Capacity test jack						
M-101	*METER, MULTI-SCALE: DC; 0-10 mfd and 0-50 arbitrary scale; rectangular flush mtg bakelite case; 2-3/4" diam barrel; 1-1/16" d behind flange excluding term; 3" x 3-1/8" rectangular flange; 2% accuracy full scale (tube tester) and 5% accuracy full scale (capacity ranges); 100 microamps, 1238 ohms; calibrated for non-magnetic panel; 41 scale divisions on capacity arc, red, yellow and green sectors and 50 division arbitrary scale for tube tester section; requires ext multiplier and rectifier; four 0.12" diam holes on 2.40" x 2.52" mtg/c; 2 solder studs 5/32" diam x 1/4" lg.	Tube tester and capacity measurement	(-22741)	N17-M-21871-2261 (3F871-16)	CV Model 301 (special) D-128580	H-2461	M-101	1
N-101	*BOOK, REFERENCE: Tube Data Index for Army-Navy Tube Tester TV-4/U; 3" x 5". 22 pages; loose leaf; special binder and bracket.	Tube data index		N16-B-670001-101 (6D6998-28)	CAOR H-2309	H-2309	N-101	1
P-101	CONNECTOR, RECEPTACLE: 2 round male contacts; straight type; 1-5/8" lg x 5/8" wd x 5/16" h o/a excluding term; 124 v, 7 amp; rectangular steel shell; 2 mtg holes 0.156" diam on 1-1/4" mtg/c.	Power input	(-491960)	N17-C-73439-4929 (2Z3022-120)	CQG PA-43	H-2283	P-101 P-202	2
R-101	*RESISTOR, FIXED: WW; 3 ohms \pm 1/2%; 1/4 watt at 55 deg C max oper temp; 0.55" diam x 1/2" lg; wax dipped, humidity resistant; 2 solder term; single screw mtg by 0.109" diam center hole; for instrument multiplier use only.	Meter mult.	(-637281-1/2)	N16-R-78617-4224 (3Z5993-60)	CV #139 spool D-128547	H-2440	R-101	1
R-102	*RESISTOR, FIXED: WW; 165 ohms \pm 1/2%; otherwise same as R-101.	Meter mult.	(-637283-1/2)	N16-R-78954-5499 (3Z6016E5-4)	D-128551	H-2444	R-102	1
R-103	*RESISTOR, FIXED: WW; 300 ohms \pm 1/2%; otherwise same as R-101.	Meter mult.	(-637284-1/2)	N16-R-78989-2424 (3Z6030-127)	D-128552	H-2445	R-103	1
R-104	*RESISTOR, FIXED: WW; 88.36 ohms \pm 1/2%; otherwise same as R-101.	Meter shunt	(-637282-1/2)	N16-R-78897-5499 (3Z6008H8-5)	D-128550	H-2443	R-104	1

TABLE 6-2, CONT'D

SYMBOL DESIG.	NAME OF PART AND DESCRIPTION	FUNCTION	JAN AND (NAVY TYPE) NO.	STANDARD NAVY AND (SIGNAL CORPS) STOCK NO.	MFGR. AND MFGR'S DESIGNATION	CONTRACTOR DRAWING & PART NO.	ALL SYMBOL DESIG. INVOLVED	QUAN. EQUIP.	QUAN. EQUIP. REPAIR PARTS
R-105	*RESISTOR, FIXED: non-inductive WW; 7328 ohms \pm 1/2%; otherwise same as R-101.	Meter shunt	(-637291-1/2)	N16-R-79229-7659 (3Z6573B2)	D-128556	H-2449	R-105	1	
R-106	*RESISTOR, FIXED: non inductive WW; 26,224 ohms \pm 1/2%; 1/2 watt at 55 deg C max oper temp; 0.55" diam x 0.70" lg; wax dipped, humidity resistant; 2 solder term; single screw mtg by 0.109" diam center hole; for instrument multiplier use only.	Meter mult.	(-637293-1/2)	N16-R-79302-6615 (3Z6626B21)	CV #109 spool D-128558	H-2451	R-106	1	
R-107	*RESISTOR, FIXED: non-inductive WW; 76 ohms \pm 1/2%; otherwise same as R-101.	Meter shunt	(-637289-1/2)	N16-R-78886-8885 (3Z6007F6-1)	D-128549	H-2442	R-107	1	
R-108	*RESISTOR, FIXED: non-inductive WW; 726 ohms \pm 1/2%; otherwise same as R-101.	Meter shunt	(-637290-1/2)	N16-R-79066-3999 (3Z6072F6)	D-128553	H-2446	R-108	1	
R-109	*RESISTOR, FIXED: non-inductive WW; 9500 ohms \pm 1/2; otherwise same as R-101.	Meter shunt	(-637292-1/2)	N16-R-79251-7824 (3Z6595-1)	D-128557	H-2450	R-109	1	
R-110	*RESISTOR, FIXED: non-inductive WW; 70,300 ohms \pm 1/2%; otherwise same as R-106.	Meter mult	(-637294-1/2)	N16-R-79385-6939 (3Z6007-19)	D-128559	H-2452	R-110	1	
R-111	*RESISTOR, FIXED: non-inductive WW; 40 ohms \pm 1/2 %; otherwise same as R-101.	Meter mult	(-637288-1/2)	N16-R-78817-6024 (3Z6004-52)	D-128548	H-2441	R-111	1	
R-112	*RESISTOR, FIXED: WW; 4700 ohms \pm 1/2%; otherwise same as R-101.	Diode load	(-637286-1/2)	N16-R-79191-9624 (3Z6470-36)	D-128555	H-2448	R-112	1	
R-113	*RESISTOR, FIXED: WW; 765 ohms \pm 1/2%; otherwise same as R-101.	Bat. type load	(-637285-1/2)	N16-R-79071-3699 (3Z6076E5-1)	D-128554	H-2447	R-113	1	
R-114	*RESISTOR, FIXED: WW; 160,000 ohms \pm 1/2%; otherwise same as R-106.	Line check adj.	(-637287-1/2)	N16-R-79426-1144 (3Z6716-7)	D-128560	H-2453	R-114	1	
R-115	*RESISTOR, FIXED: WW; 2000 ohms \pm 10%; 10 watts at 205 deg C max oper temp; 5/16" diam x 1-3/4" lg; vitreous enamel coating; 2 wire leads; mts by removable brackets or screw through core hole.	Rect.type load	(-634262-10)	N16-R-70644-5441 (3Z6200-194)	COM Brown Devil	H-1100-15	R-115	1	

ORIGINAL

R-116	*RESISTOR, VARIABLE: WW; 350 ohms + 10%; 25 watts at 400 deg F max oper temp; 3 solder lug term; ceramic case 1-9/16" diam x 1-3/8" d; open case; round metal shaft 1/4" diam x 9/16" lg; 0.052" diam cross hole 1/8" from end of bushing and in line with contact arm; taper A; contact arm insulated from case; without off position; no shaft locking device; 1/4" lg x 3/8" diam x 32 thd bushing, non-turn lug at 6 o'clock.	Line control	(-637279-10)	N16-R-90398-7670 (3Z7235-11)	COM Model H (modified)	H-2454	R-116	1
R-117	*RESISTOR, VARIABLE: WW; 150 ohms + 5%; 4 watts at 55 deg C max oper temp; 3 solder lug term; enclosed metal case 1-5/8" diam x 9/16" d; round metal shaft 1/4" diam x 11/16" lg. 0.052" diam cross hole 1/8" from end of bushing and in line with contact arm; taper A; contact arm insulated from case; without off position; normal torque; no shaft locking device; 3/8" lg x 3/8" diam x 32 thd bushing, non-turn device.	Sensitivity control	(-637280-5)	N16-R-90262-9996 (3Z7150-8)	CMA Type M (modified)	H-2455	R-117	1
R-118	RESISTOR, FIXED: comp; 200,000 ohms + 5%; 1/2 watt; F characteristics; 0.625 lg x 0.186 diam; insulated, salt water immersion resistant; two axial wire leads; Spec JAN-R-11.	Glow lamp load	RC20BF204J	N16-R-49327-431 (3RC20BF204J)	CIR Type BTS	H-1009-135	R-118	1
R-119	RESISTOR, FIXED: comp; 510,000 ohms + 5%; 1/2 watt; otherwise the same as R-118.	Short check shunt	RC20BF514J	N16-R-50839-431 (3RC20BF514J)	CIR Type BTS	H-1009-38	R-119	1
S-101	*SWITCH, ROTARY: 4 section 10 position; metal parts of brass, silver plated; stator and rotor of laminated phenolic; 2-7/16" lg x 1-7/8" h x 1-5/8" wd, excluding bushing and shaft; section 1 and 2 special, section 3 shorting type, section 4 non shorting type; solder lug term; single hole mtg, bushing 3/8" lg x 3/8" diam x 32 thds, shaft 1/4" diam x 2-3/32" lg from mtg surface, 0.05" diam cross hole 1-15/16" from mtg surface and in line with contact arms of sections 3 and 4; fungus proofed Mallory type B construction.	Circuit selector switch		N17-S-66211-8283 (3Z9825-33.26)	CMA Type RM (modified)	H-2456	S-101	1
S-102	*SWITCH, ROTARY: 1 section 17 positions; metal case and parts of brass, silver plated; laminated phenolic section 1-11/16" diam x 13/16" lg o/a, excluding bushing and shaft, non shorting type; solder lug term; single hole mtg, bushing 3/8" lg x 3/8" diam x 32 thds, shaft 1/4" diam x 2-3/32" lg from mtg surface, 0.052 diam cross hole 1-17/32 from mtg surface and in line with contact arm; fungus proofed Mallory type B construction.	Filament switch	(-241416)	N17-J-60634-6805 (3Z9825-33.25)	CMA Series 3200 (modified)	H-2457	S-102	1

TABLE 6-2, CONT'D

SYMBOL DESIG.	NAME OF PART AND DESCRIPTION	FUNCTION	JAN AND (NAVY TYPE) NO.	STANDARD NAVY AND (SIGNAL CORPS) STOCK NO.	MFGR. AND MFGR'S DESIG- NATION	CON- TRACTOR DRAW- ING & PART NO.	ALL SYMBOL DESIG. INVOLVED	QUAN. EQUIP.	QUAN. EQUIP. REPAIR PARTS
S-103	SWITCH, TOGGLE: DPDT: 3 amp 250 v, 6 amp 125 v; phenolic case; 11/16" wd x 21/32" d x 1-5/32" lg; non shorting contacts; bat handle 0.25" diam x 3/4" lg to fulcrum; locking action; solder lug term; single hole mtg, bushing 15/32" lg x 15/32" diam x 32 thds.	Meter rev. switch	(-241347)	N17-S-74213-8160 (3Z9858-8.203)	CHH #81027-WLF	H-2465	S-103	1	
S-104	SWITCH, TOGGLE; SPDT: 3 amp 250 v, 6 amp 125 v; phenolic case; 11/16" wd x 21/32" d x 1-5/32" lg; non shorting contacts, bat handle 0.25" diam x 3/4" lg to fulcrum; locking action; solder lug term; single hole mtg, bushing 15/32" lg x 15/32" diam x 32 thds.	Tube element switch H	(-241413)	N17-S-72069-5575 (3Z9858-8.202)	CHH #81021-WLF	H-2466	S-104 to S-111	8	
S-105	SWITCH, TOGGLE: same as S-104.	Tube element switch G							
S-106	SWITCH, TOGGLE: same as S-104.	Tube element switch F							
S-107	SWITCH, TOGGLE: same as S-104.	Tube element switch E							
S-108	SWITCH, TOGGLE: same as S-104.	Tube element switch D							
S-109	SWITCH, TOGGLE: same as S-104.	Tube element switch C							
S-110	SWITCH, TOGGLE: same as S-104.	Tube element switch B							
S-111	SWITCH, TOGGLE: same as S-104.	Tube element switch A							
T-101	*TRANSFORMER, POWER: filament and plate type; 105 - 125 v, 50 - 1600 cycle, single phase; 7 windings with electrical rating and electrical connection as shown in Table 5 - 7: uncased and impr with 3 dips of varnish and 2 dips of asphaltum; 3-1/8" wd x 3-3/4" lg x 2-1/2" h o/a; 16 solder lug term and 14 wire leads, 8 term and 7 leads on opposite sides of transformer; four 7/32" diam holes on 3-1/8" x 2-1/2" mtg/c.	Power trans- former	(-304851)	N17-T-73646-6833 (2Z9619-211)	CV D-128544	H-2463	T-101	1	
V-101	TUBE, ELECTRON: RMA #3A4; power amplifier pentode.	Rectifier		N16-T-53140 (2J3A4)		H-2460	V-101	1	

ORIGINAL

ORIGINAL

W-101	*LEAD, ELECTRICAL: #20 AWG strand- ed tinned copper cond; 40 #36 AWG strands; black rubber over single cotton wrap; 1000 v AC, 1500 v DC; 12" lg excluding termin- ations; 1 pin clip Weston Part/Dwg D-91291 and sleeve Weston Part/Dwg D-79552 on one end, other end plain.	Plate lead		N17-L-62701-2801 (3E7998-12.3)	CV D-91290	H-2459	W-101	1
W-102	*LEAD, ELECTRICAL: #20 AWG stranded tinned copper cond; 40 #36 AWG strands; black rubber over single cotton wrap; 1000 v AC, 1500 v DC; 14" lg excluding terminations; Alden grid cap Part 9091 on one end, other end plain.	Grid lead		N17-C-62718-6701 (3E7998-14.3)	CV D-76888	H-2458	W-102	1
X-101	SOCKET, TUBE: 9 contact miniature, one piece saddle mtg; two 0.095" diam holes on 1-1/8" mtg/c, 3/4" diam chassis cut- out; round black bakelite body, oval saddle, 7/16" wd x 1-3/8" lg x 7/16" d o/a exclud- ing term; phospher-bronze silver plated contacts; without shock and center shield; unmarked.	Test socket 9 pin miniature A	(-491961)	N16-S-64063-6710 (2Z8679.17)	CPH Type 59-409	H-2489	X-101 X-111	2
X-102	SOCKET, TUBE: 8 contact loctal, one piece saddle mtg; two 0.144" diam holes on 1.59" mtg/c, 1.22" diam chassis cutout; round black bakelite body, mtg ears in line with key slot, 1-9/32" wd x 1-15/16" lg x 5/8" d o/a excluding term; phospher-bronze silver plated contacts; unmarked.	Test socket loctal B	(-491576)	N16-S-63584-9641 (2Z8678.309)	CYA #438TFL	H-2476	X-102 X-104 X-107	3
X-103	SOCKET, TUBE: 8 contact octal; one piece saddle mtg; two 0.144" diam holes on 1.59" mtg/c, 1.22" diam chassis cut- out; round black bakelite body, mtg ears in line with key slot, 1-5/16" wd x 2" lg x 5/8" d o/a excluding term; phospher- bronze silver plated contact; unmarked.	Spare socket octal B	(-491577)	N16-S-63520-6441 (2Z8678.308)	CYA #438TF	H-2473	X-103 X-105 X-108	3
X-104	SOCKET, TUBE: same as X-102	Test socket loctal A						
X-105	SOCKET, TUBE: same as X-103	Test socket octal A						
X-106	SOCKET, TUBE: 7 contact miniature; retainer ring mtg; mtg in D shaped hole 5/8" diam; round black bakelite body 23/32" diam x 3/8" d o/a excluding term; phospher-bronze silver plated contacts; without shock shield, with center shield; retainer ring included; unmarked.	Test socket 7 pin miniature A	(-491959)	N16-S-62601-5687 (2Z8677.127)	CPH 78-7P	H-2479	X-106 X-113	2
X-107	SOCKET, TUBE: same as X-102	Test socket loctal (reg.)						
X-108	SOCKET, TUBE: Same as X-103	Test socket octal(reg.)						

PARTS LISTS

NAVSHIPS 91146
AN/USM-3Section 6
W-101-X-108

6-7

TABLE 6-2, CONT'D

SYMBOL DESIG.	NAME OF PART AND DESCRIPTION	FUNCTION	JAN AND (NAVY TYPE) NO.	STANDARD NAVY AND (SIGNAL CORPS) STOCK NO.	MFGR. AND MFGR'S DESIG- NATION	CON- TRACTOR DRAW- ING & PART NO.	ALL SYMBOL DESIG. INVOLVED	QUAN. EQUIP.	QUAN. EQUIP. REPAIR PARTS
X-109	SOCKET, TUBE: 7 contact for large and small 7 prong tubes; one piece saddle mtg; two 0.140" diam hole on 1.59" mtg/c, 1.22" diam chassis cutout; round black bakelite body, mtg ears on line at right angle to line through contacts 1 and 7, 1-7/16" wd x 2" lg x 3/4" d o/a excluding term; phospher-bronze silver plated contacts; unmarked.	Test socket large and small 7 prong	(-491962)	N16-S-62768-1091 (2Z8677.126)	CYA 437TF	H-2472	X-109	1	
X-110	*SOCKET, TUBE; combination 4, 5 and 6 contact socket; one piece saddle mtg; two 0.144" diam holes on 1.59" mtg/c, 1.22" diam chassis cutout; round black bakelite body, mtg ears at right angle to line through filament contacts, 1-5/16" wd x 1-15/16" lg x 5/8" d o/a excluding term; phospher-bronze silver plated contacts; unmarked.	Test socket 4,5,6 prong	(-491963)	N16-S-62157-9641 (2Z8676.93)	CYA 456TF	H-2471	X-110	1	
X-111	SOCKET, TUBE: same as X-101	Test socket 9 pin miniature							
X-112	SOCKET, TUBE: 7 contact acorn; one piece saddle mtg; two 0.144" diam holes on 1.59" mtg/c, 1.22" diam chassis cutout; round black bakelite body, mtg holes between contacts 2 and 3 and contacts 5 and 6, 1-7/8" diam x 1-5/8" d o/a excluding term; phospher-bronze silver plated contacts; unmarked.	Test socket acorn	(-491958)	N16-S-60646-8291 (2Z8677.128)	CYA 457V-1	H-2546	X-112	1	
X-113	SOCKET, TUBE: same as X-106	Test socket 7 pin miniature							
X-114	SOCKET, TUBE: 7 contact miniature; one piece saddle mtg; two 1/8" diam holes on 7/8" mtg/c, 5/8" diam chassis cutout; round bakelite body, oval shaped saddle, with shield base, 0.805" diam x 1-9/32" lg o/a excluding term; beryllium-copper silver plated; unmarked; to be used with shock shield (not supplied) and with center shield 0.156" diam.	Socket for V-101	S010M	N16-S-62603-6679 (2Z8677.108)		H-2299	X-114 X-203	2	

ORIGINAL

200	AMPLIFIER, AF-RF: Army-Navy Signal Tracer; used for detection and indication of signals in electronic circuits; p/o Test-Tool Set AN/USM-3, u/w	Signal tracer	TS-673/U	F16-A-27109-5501 (3F4325-873)	CAOR H-2190	H-2190		1
299	Test Prods MX-933/U and MX-934/U and RF Cable assembly CG-570/U (3'0"); consists of detector and amplifier stages with output connection for scope, phones for VTVM, has self-contained indicating mechanism for arbitrary scale indication, output level adjustable; 105-125 VAC 50-1600 cycles, 7 watts, 3" wd x 3-1/2" lg x 5-11/16" h o/a.							
C-201	CAPACITOR, FIXED: paper; 100,000 mmf. \pm 20%; 400 vdcw; molded phenolic case; 17/32" diam x 1-5/8" lg; wax impr; 2 axial wire leads; no internal ground connection; mts by wire leads; p/o E-207 (Test Prod MX-933/U); replace E-207 in case of failure.	Coupling capacitor			CAW P488	H-1007-11	C-201	1
C-202	CAPACITOR, FIXED: paper 2,000 mmf. \pm 20%; 600 vdcw; cardboard case; 1/2" lg x 11/32" wd x 3/16" h; wax impr; 2 axial wire leads; no internal ground connection; mts by wire leads; p/o E-208 (Test Prod MX-934/U); replace E-208 in case of failure.	Charging capacitor			CAPY #1577	H-1007-8	C-202 C-204	2
C-203	CAPACITOR, FIXED: ceramic; 500 mmf \pm 10%; - 20% to \pm 10% for - 40 ^o C to + 85 ^o C; 500 vdcw; 0.562" lg x 0.250" diam; 2 axial wire leads; insulated; p/o E-208 (Test Prod MX-934/U); replace E-208 in case of failure.	RF By-pass capacitor			CER Hi-K Ceramicon	H-1007-20	C-203	1
C-204	CAPACITOR, FIXED: same as C-202	Coupling capacitor						
C-205	CAPACITOR, FIXED: paper dielectric; 3000 mmf \pm 20%, 600vdcw; cardboard tube; 9/32" diam x 11/16" lg; wax impr; 2 axial wire leads 2-1/2" lg, no internal ground connection; mts by wire leads.	Frequency compensating capacitor	(-484940-20)	N16-C-40495-3688 (3DA3-120)	CSF #68P28	H-1007-22	C-205	1
C-206	CAPACITOR, FIXED: paper dielectric; 100,000 mmf. \pm 20%; 400 vdcw; molded phenolic case; 17/32" diam x 1-5/8" lg; wax impr; 2 axial wire leads, 2-1/2" lg; no internal ground connection; mts by wire leads.	Coupling capacitor	(-492829-20)	N16-C-45805-6630 (3DA100-829)	CAW P488	H-1007-11	C-206 C-207	2
C-207	CAPACITOR, FIXED: same as C-206	Coupling capacitor						
C-208	CAPACITOR, FIXED: paper dielectric, 50,000 mmf \pm 20%; 200 vdcw; cardboard tube; 5/16" diam x 1" lg; wax impr; 2 axial wire leads, 2-1/2" lg; no internal ground connections; mts by wire lead term.	Bias capacitor	(-484936-20)	N16-C-44283-3187 (3DA50-339)	CSF #68P16	H-1007-21	C-208	1

TABLE 6-2, CONT'D

SYMBOL DESIG.	NAME OF PART AND DESCRIPTION	FUNCTION	JAN AND (NAVY TYPE) NO.	STANDARD NAVY AND (SIGNAL CORPS) STOCK NO.	MFGR. AND MFGR'S DESIG- NATION	CON- TRACTOR DRAW- ING & PART NO.	ALL SYMBOL DESIG. INVOLVED	QUAN. EQUIP.	QUAN. EQUIP. REPAIR PARTS
C-209	*CAPACITOR, FIXED: electrolytic; 3 section; 30/15/10 mf -10 + 75%; 250 vdcw; -20 deg C to + 85 deg C; 1" diam x 2" lg; HS metal case; 3 solder lug term on mtg end; negative term grounded internally; mts by 3 twist-prong mtg tabs 120 deg apart on 0.368 rad, 0.718 diam chassis hole.	Filter capacitor	(-484941)	N16-C-22484-1271 (3DB30-54)	CSF EL-315	H-2198	C-209	1	
C-209A	CAPACITOR, FIXED: 10 mf; p/o C-209.								
C-209B	CAPACITOR, FIXED: 15 mf; p/o C-209.								
C-209C	CAPACITOR, FIXED: 30 mf; p/o C-209.								
C-210	CAPACITOR, FIXED: electrolytic, 5 mf -0 + 75%; 25 vdcw; -20 deg C to + 85 deg C; 1/2" diam x 1-3/8" lg o/a; HS metal case with vinyl sleeve; 2 axial wire leads, 2-1/2" lg; neg term grounded; mts by wire leads.	Coupling capacitor	(-484942)	N16-C-19456-4654 (3DB5-104)	CD #BER-10017	H-1007-13	C-210	1	
CR-201	CRYSTAL UNITS, RECTIFYING: germanium; ceramic case, metal end bells; 50 volt peak inverse 0 - 22.5 ma; 3/4" lg x 7/32" diam excluding terms; 2 axial wire leads; marked IN34; p/o of E-208 (Test Prod MX-934/U); replace E-208 in case of failure.	Non-linear detector			CHS IN34	H-1761	CR-201 CR-501 CR-502	3	
CR-202	RECTIFIER, METALLIC: copper oxide type; input 2.0 v AC single ph, output 1.6v, 5 ma max; oval shape, 0.47" lg x 0.52" wd x 0.375" h o/a; one mtg hole, 0.128 diam; full bridge instrument type, four 0.20" diam discs.	Rectifier	(-20639)	N17-R-50807-1634 (3F33680-2)	CV D-89367	H-2329	CR-202	1	
E-201	FUSEHOLDER: block type; for 1 type 8AG cartridge fuse; 1/4" OD x 1" lg; 1/8" thk bakelite with nickel plated steel clips; 250 v, 5 amp; 1/8" thk x 1/2" wd x 1-3/16" lg; flush mtg, 0.140" diam in ctr of block; 2 solder lug term.	Fuse holder		N17-F-73767-5001 (3Z3282-34.1)	CAXD #7202	H-2284	E-201	1	
E-202	BOARD, TERMINAL: mtg strip for neon lamp and resistor; 3 rivet type solder term; laminated phenolic board; 1/16" thk x 3/4" wd x 1" lg o/a; two 5/32" diam holes on 11/16" mtg/c.	Support for E-203 and E-214		N17-B-77583-5765 (3Z770-3.7)	CAOR H-2210	H-2210	E-202	1	

E-203	LAMP, GLOW: 105-125 v with 200,000 external series resistor, 1/25 watt, starting 65 v AC; Bulb T-2 clear; 1-1/16" lg max o/a; unbased, 2 wire term 13/16" lg; parallel post filament, type W-11 electrodes, 3000 hrs rated life; burn any position; neon gas filled.	Pilot lamp	(VG-11)	N17-L-6806-120 (2Z5954)	CG Type NE-2	H-2285	E-203	1
E-204	SHIELD, TUBE: steel, cadmium plated; round, open top; bayonet action friction mtg; 0.950" diam x 1-15/16" h, with 19/32" diam top hole; spring in can holds tube in socket.	Tube shield		N16-S-34576-6515 (2Z8304.137)	CMG #16G12627	H-2297	E-204 E-205	2
E-205	SHIELD, TUBE: same as E-204	Tube shield						
E-206	SHIELD, TUBE: steel, cadmium plated; round, open top; bayonet action friction mtg; 13/16" diam x 1-3/8" h, with 15/32" diam top hole; spring in can holds tube in socket.	Tube shield	SOS3	N16-S-34520-3849 (2Z8304.146)	CMG #16G11752	H-2298	E-206	1
E-207	PROD, TEST: used as probe for AF signal tracing; electrical, non-rectifying; consists of phenolic probe type housing with prod tip on one end and female connector on other end, contains 1 fixed capacitor; 400 v DC max oper; 3/4" diam x 4" lg o/a; marked to indicate max oper voltage.	Test prod	MX-933/U	N17-P-84825-7076 (3F3711-267)	CAOR H-2580	H-2580	E-207	1
E-208	PROD, TEST: used as probe for RF signal tracing; electrical, rectifying; consists of phenolic probe type housing with prod tip on one end and female connector on other end, contains 3 fixed capacitors, 1 crystal rectifier and 1 fixed resistor; 300 vDC max oper; 3/4" diam x 4" lg o/a; marked to indicate max oper voltage.	Test prod	MX-934/U	N17-P-84877-4451 (3F3711-266)	CAOR H-2560	H-2560	E-208	1
E-209	KNOB: round; black bakelite; for 1/4" diam shaft; with single 6-32 set screw; 3/8" h x 7/8" wd o/a including pointer; straight knurl.	Control knob		N16-K-700226-101 (2Z5822-249)	Harry Davies Mold #1400	H-2294	E-209	1
F-201	FUSE, CARTRIDGE: 1 amp; same as F-101	Fuse						
H-201	NUT, HEXAGON: brass, nickel plated; 45 deg chamfered corner on bearing surface; 2-56 NC-2 thd; 1/4" h o/a; 3/16" across flats, 0.140" diam x 0.187" lg body.	Nut		N43-N-4743-520 (6L3102-56-3.1)	CAOR H-2214	H-2214	H-201	2
J-201	CONNECTOR, RECEPTACLE; 1 round female contact; straight type; 1/4" diam x 32 thd x 3/4" l o/a excluding term; brass, silver plated; special collar mtg; polystyrene insert; RG-58/U cable size; p/o E-207 (Test Prod MX-933/U); replace E-207 in case of failure.	Probe contact			CAOR H-2566	H-2566	J-201	1

TABLE 6-2, CONT'D

SYMBOL DESIG.	NAME OF PART AND DESCRIPTION	FUNCTION	JAN AND (NAVY TYPE) NO.	STANDARD NAVY AND (SIGNAL CORPS) STOCK NO.	MFGR. AND MFGR'S DESIGNATION	CONTRACTOR DRAWING & PART NO.	ALL SYMBOL DESIG. INVOLVED	QUAN. EQUIP.	QUAN. EQUIP. REPAIR PARTS
J-202	CONNECTOR, RECEPTACLE: 1 round female contact; straight type; 1/4" diam x 32 thd x 3/4 l o/a excluding term; brass silver plated; special collar mtg; polystyrene insert; RG-58/U cable size; p/o E-208 (Test Prod MX-934/U); replace E-208 in case of failure.	Probe contact			CAOR H-2562	H-2562	J-202	1	
J-203	CONNECTOR, RECEPTACLE: 1 round female contact; straight type; 1/4" diam x 32 thd x 1/2" lg o/a excluding term; brass, silver plated, has flange on end and locknut for panel mtg; polystyrene insert; cable opening 0.195" OD	Input contact		N17-C-73107-7652 (2Z3062-176)	CARO MC-20	H-2200	J-203	1	
J-204	CONNECTOR, RECEPTACLE: 1 round female contact, phone tip type; straight type; 1/4" diam x 32 thd body x 3/8" diam x 3/16" h head x 3/4" lg o/a excluding term; brass body, plastic head; panel mtg with nut and ins washer, 1/4" max panel thk; phospher-bronze contact;	Phones contact		N17-C-73108-1959 (2Z5531.4)	CMH #1866	H-2286	J-204 J-205	2	
J-205	CONNECTOR, RECEPTACLE: same as J-204	Phones contact							
M-201	*METER, ARBITRARY SCALE: dc type, arbitrary scale; oval shape, phenolic case and clear plastic window; 0.748" wd x 0.866" d x 1.187" lg o/a; 200 microamp sensitivity full scale; 10 scale divisions; special assembly for replacement use only	Output indicator	(-22742)	N17-M-21873-2251 (3F872-28)	CAOR H-2220	H-2220	M-201	1	
P-201	CONNECTOR, PLUG: 1 round male contact; straight type; 5/16" diam, 7/8" l o/a; brass; silver polystyrene insert; for RG-58/U cable; 1/4" diam x 32 thd x 5/16" diam coupling nut; p/o W-201 (RF Cable Assembly CG-570/U (3'0")) replace W-201 in case of failure.	Cable contact			IPC MC-120	H-2436	P-201 P-203	2	
P-202	CONNECTOR, RECEPTACLE: same as P-101.	Power input							
P-203	CONNECTOR, PLUG; same as P-201.	Cable contact							

ORIGINAL

ORIGINAL

R-201	RESISTOR, FIXED: comp; 1 meg \pm 10%; 1/2 watt; F characteristic; 1/2" lg x 0.150 diam; insulated, salt water immersion resistant; two axial wire lead term; p/o E-208 (Test Prod MX-934/U) replace E-208 in case of failure.	Detector resistor			CBZ Type EB	H-1009-55	R-201	1
R-202	RESISTOR, VARIABLE: comp; 1 meg \pm 20%; 2 watts at 70 deg C, max oper temp 120 deg C; 3 solder lug; metal case 1-1/16" diam x 9/16" d; enclosed case; round shaft; metal; 1/4" diam x 1/2" lg from mtg sur face; A taper; ins contact arm; without off position; normal torque; without shaft locking device; bushing 1/4" lg x 3/8" diam x 32 thd, non-turn device at 9 o'clock on 17/32" radius.	Level adj.	(-637296-K20)	N16-R-88342-5230 (3Z7499-1.78)	CBZ JA 1052	H-2229	R-202	1
R-203	RESISTOR, FIXED: comp; 2.4 meg \pm 5%; 1/2 watt; F characteristic; 1/2" lg x 0.150 diam; insulated, salt water immersion resistant; two axial wire lead term.	Feedback resistor	RC20BF245J	N16-R-51073-431 (3RC20BF245J)	CBZ Type EB	H-1009-136	R-203	1
R-204	RESISTOR, FIXED: comp; 51,000 ohms \pm 5%; 1/2 watt; F characteristic; 1/2" lg x 0.150 diam; insulated, salt water immersion resistant; two axial wire lead term.	Plate resistor	RC20BF513J	N16-R-50497-431 (3RC20BF513J)	CBZ Type EB	H-1009-102	R-204 R-206 R-214	3
R-205	RESISTOR, FIXED: comp; 1 meg \pm 10%; otherwise same as R-204.	Grid resistor	RC20BF105K	N16-R-50975-811 (3RC20BF105K)	CBZ Type EB	H-1009-55	R-205	1
R-206	RESISTOR, FIXED: same as R-204	Plate resistor						
R-207	RESISTOR, FIXED: comp; 1,000 ohm \pm 10%; 1/2 watt; F characteristic; 1/2" lg x 0.150 diam; insulated, salt water immersion resistant; two axial wire lead term.	Cathode bias resistor	RC20BF102K	N16-R-49922-811 (3RC20BF102K)	CBZ Type EB	H-1009-80	R-207 R-210 R-211	3
R-208	RESISTOR, FIXED: comp; 100,000 ohms \pm 10%; otherwise the same as R-207.	Voltage divider resistor	RC20BF104K	N16-R-50633-811 (3RC20BF104K)	CBZ Type EB	H-1009-82	R-208	1
R-209	RESISTOR, FIXED: comp; 240,000 ohms \pm 5%; otherwise the same as R-207.	Grid resistor	RC20BF244J	N16-R-50722-431 (3RC20BF244J)	CBZ Type EB	H-1009-134	R-209	1
R-210	RESISTOR, FIXED: same as R-207.	Cathode resistor						
R-211	RESISTOR, FIXED: same as R-207.	Instrument resistor						
R-212	RESISTOR, FIXED: comp; 10,000 ohms \pm 10%; otherwise the same as R-207.	Filter resistor	RC20BF103K	N16-R-50282-811 (3RC20BF103K)	CBZ Type EB	H-1009-48	R-212	1

PARTS LISTS

NAVSHIPS 91146
AN/USM-3Section 6
R-201—R-212

6-13

TABLE 6-2, CONT'D

SYMBOL DESIG.	NAME OF PART AND DESCRIPTION	FUNCTION	JAN AND (NAVY TYPE) NO.	STANDARD NAVY AND (SIGNAL CORPS) STOCK NO.	MFGR. AND MFGR'S DESIG- NATION	CON- TRACTOR DRAW- ING & PART NO.	ALL SYMBOL DESIG. INVOLVED	QUAN. EQUIP.	QUAN. EQUIP. REPAIR PARTS
R-213	RESISTOR, FIXED: comp; 10,000 ohms ± 10%; 1 watt; otherwise the same as R-207	Filter resistor	RC30BF103K	N16-R-50283-231 (3RC30BF103K)	CBZ Type GB	H-1009-81	R-213	1	
R-214	RESISTOR, FIXED: same as R-204.	Pilot light resistor							
T-201	*TRANSFORMER, POWER: filament and plate type; 105-125 v, 50-1600 cycles; 2 output windings; sec'd #1, 300 v at 3 ma CT; sec'd #2, 6.3 v at 0.9 amp; 750 v insulation; HS metal case; 2-1/2" h x 1-13/16" diam o/a excluding mtg ears; 6 wire lead term on bottom; two 1/8" diam holes on 2-1/8" mtg/c.	Power transformer	(-304850)	N17-T-73621-3701 (2Z9619-210)	CUT D-6687	H-2199	T-201	1	
V-201	TUBE, ELECTRON: RMA #12AX7; twin triode.	Amplifier	12AX7	N16-T-58241-60 (2J12AX7)		H-2287	V-201 V-202	2	
V-202	TUBE, ELECTRON: RMA #12AX7; twin triode, same as V-201.	Amplifier							
V-203	TUBE, ELECTRON: RMA #6AL5; twin diode.	Rectifier	6AL5	N16-T-56195 (2J6AL5)		H-2288	V-203	1	
W-201	CABLE ASSEMBLY, RF: RG-58/U cable; 34" lg excluding terminations; 36" lg o/a; modified IPC MC-10 connector used as terminations each end; has phenolic sleeve held in place by set screw on one end.	Signal tracer input cable	CG-570/U (3'0")	N16-C-11943-8231 (1F430-570.36)	CAOR H-2583	H-2583	W-201	1	
X-201	SOCKET, TUBE: 9 contact miniature oval; one piece saddle mtg; two 1/8" diam holes on 1-1/8" mtg/c; round mica body with shield base shell, oval saddle mtg. 0.940" diam x 25/32" h o/a excluding term; beryllium copper silver plated; unmarked without shock shield, with 0.160" diam center shield.	Socket for V-201	(-491894)	N16-S-64063-6706 (2Z8679.18)	CMG 53F12875	H-2296	X-201 X-202	2	
X-202	SOCKET, TUBE: same as X-201.	Socket for V-202							
X-203	SOCKET, TUBE: 7 contact miniature; same as X-114	Socket for V-203							

300 to 399	GENERATOR, NOISE: Army-Navy Interference Generator; provides random noise for checking circuits for vibration for shocking tubes into oscillation; consists of vibrating buzzer, battery, attenuator, probe tip and housing; phenolic probe type housing; Sig C battery BA-58, self-contained; .878" diam 6.109" lg o/a; fits in case CY-703/U when not in use; mechanical attenuator for output adj ratio approx 1 to 10.	Signal Source	SG-23/U	F16-G-59001-1001 (3F3835-23)	CAOR H-2500	H-2500		1
I-301	BUZZER, SIGNAL: vibrating type; non-adjustable tone; 0.575 diam x 1-1/8" lg -excluding tip; 1-1/2 v DC; non-polarized; 0.77 ohm; fits ID of Interference Generator SG-23/U; bakelite frame-screw contact adj; replace Interference Generator SG-23/U in case of failure.	Signal source			CAOR H-2516	H-2516	I-301	1
BT-301	BATTERY, DRY: Sig C battery BA-58; 1-1/2 v; cylindrical; 1-31/32" lg x 35/64" diam max; non-metallic case; 2 flat surface term; Sig C-BA-58; 4 required per equipment (not supplied by contractor).	Electrical energy source					BT-301 BT-601 BT-901	
400 to 499	PROD, TEST: Army-Navy Voltage Indicator Probe; indicates AC and DC voltage, indicates polarity of probe tip when indicating DC; consists of 2 electrical indicating meters, 1 crystal rectifier and 1 fixed resistor assembled in probe type housing; phenolic housing; meter reads 55-110-220-440 v AC and DC; 1" diam x 6" lg o/a; fits in case CY-703/U when not in use; has probe tip on one end, test lead plugs into other end.	Indicates AC or DC voltage	ID-265/U	F17-P-84881-7666 (3F3711-265)	CAOR H-2310	H-2310		1
CR-401	RECTIFIER, METALLIC: copper oxide type; input 2.0 v AC, output 1.6 v, 5 ma max; oval shape, 0.47" lg x 0.52" wd x 0.375" h o/a; one mtg hole, 0.128" diam; full bridge instrument type, four 0.20" diam discs; replace Voltage Indicator-Probe ID-265/U in case of failure.	Meter rectifier			CV D-89367	H-2329	CR-401	1
M-401	METER, ARBITRARY SCALE: DC type; assembled in phenolic case with M-402; plastic window; occupies lower half of case 2-1/8" lg x 3/4" wd x 0.866" diam; 250-0-250 uA sensitivity; scale marked POLARITY, -, +; replace Voltage Indicator-Probe ID-265/U in case of failure.	Indicate polarity			CAOR H-2341	H-2344	M-401	1
M-402	METER, AMMETER: DC type; assembled in phenolic case with M-401; plastic window; occupies upper half of case 2-1/8" lg x 3/4" wd x 0.866" diam; 0.88 ma full scale sensitivity; scale marked VOLTS, 0, 55, 110, 220, 440; replace Voltage Indicator-Probe ID-265/U in case of failure.	Indicate voltage			CAOR H-2345	H-2345	M-402	1

TABLE 6-2, CONT'D

SYMBOL DESIG.	NAME OF PART AND DESCRIPTION	FUNCTION	JAN AND (NAVY TYPE) NO.	STANDARD NAVY AND (SIGNAL CORPS) STOCK NO.	MFGR. AND MFGR'S DESIGNATION	CONTRACTOR DRAWING & PART NO.	ALL SYMBOL DESIG. INVOLVED	QUAN. EQUIP.	QUAN. EQUIP. REPAIR PARTS
R-401	RESISTOR, FIXED: comp; 510,000 ohm \pm 5%; 1/2 watt; F characteristic; 1/2" lg x 0.150 diam; insulated salt water immersion resistant; two axial wire term; replace Voltage Indicator-Probe ID-265/U in case of failure.	Calibrating resistor	RC30BF514J		CBZ type EB	H-1009-31	R-401	1	
500 to 599	PROD, TEST: Army-Navy RF Indicator-Probe; indicates presence of RF field; consists of 1 electrical indicating meter, 2 crystal rectifiers, and 1 fixed capacitor assembled in probe type housing; phenolic housing; meter range 0-100 (arbitrary scale); 1" diam x 6" lg o/a; fits in case CY-703/U when not in use; probe tip on one end.	RF field indicator	ID-263/U	F17-P-84881-7676 (3F3711-263)	CAOR H-2360	H-2360		1	
C-501	CAPACITOR, FIXED: ceramic; 51 mmf \pm 10%; temp coef \pm 500 parts/million/ $^{\circ}$ C; 500 vdcw; 0.562" lg x 0.250 diam; axial wire leads, ceramic insulation; replace RF Indicator-Probe ID-263/U in case of failure.	Coupling capacitor	CC21SL510J		CER Style K	H-1007-12	C-501	1	
CR-501	CRYSTAL UNIT, RECTIFYING: same as CR-201; replace RF Indicator-Probe ID-263/U in case of failure.	RF rectifier							
CR-502	CRYSTAL UNIT, RECTIFYING: same as CR-201; replace RF Indicator-Probe ID-263/U in case of failure.	RF rectifier							
M-501	METER, ARBITRARY SCALE: DC type, arbitrary scale; assembled in oval shape phenolic case with clear plastic window; 0.748" wd x 0.866" d x 1.187" lg o/a; 200 microamp sensitivity full scale; 10 scale divisions; replace RF Indicator-Probe ID-263/U in case of failure.	Meter			CAOR H-2383	H-2383		1	
600 to 699	PROD, TEST: Army-Navy Resistance Indicator-Probe; consists of 1 electrical indicating meter, 1 Sig C battery BA-58 and 1 fixed resistor assembled in a probe type housing; phenolic housing; meter range 0-10K ohms; 1" diam x 6 lg o/a; fits in case CY-703/U when not in use; probe tip on one end, test lead plugs into other.	Continuity tester	ID-264/U	F17-P-84841-1831 (3F3711-264)	CAOR H-2400	H-2400		1	

ORIGINAL

BT-601	BATTERY, DRY: same as BT-301	Electrical energy source			CAOR H-2421	H-2421	M-601	1
M-601	METER, AMMETER: DC type; assembled in oval shaped phenolic case with plastic window, 0.748" wd x 0.866" d x 1.156" lg o/a; 1.48 ma sensitivity full scale; scale marked OHMS, 10,000 to 0; replace Resistance Indicator-Probe ID-264/U in case of failure.	Indicate resistance						
R-601	RESISTOR, FIXED: comp; 1000 ohm \pm 5%; 1/2 watt; F characteristic; 1/2" lg x 0.150 diam; insulated, salt-water-immersion resistant; two axial wire term; replace Resistance Indicator-Probe ID-264/U in case of failure.	Calibrating resistor			CBZ Type EB	H-1009-31	R-601	1
700 to 799	RESISTOR, DECADE: 10 meg in steps of 1.0 ohms; accuracy + 5%; phenolic case, 4-3/4" lg x 4-3/8" wd x 23/32" h o/a; plug in adj; jack terminals.	Decade resistor	TS-672/U	F16-R-44647-9999 (3F4325-672)	CAOR H-2491	H-2491		1
R-701	*RESISTOR, FIXED: WW; 1 ohm \pm 5%; 2 watts at 82 deg C max oper temp; 13/32" diam x 3/4" lg o/a; paper tube anti-fungus lacquer coating, resistant to humidity; 2 axial wire leads; mts by wire leads.	Resistor	(-637275-5)	N16-R-68273-3591 (3Z5991-102)	CATE type ALA-5/8	H-1220-3	R-701	1
R-702	*RESISTOR, FIXED: 2 ohms \pm 5%; 2 watts; same as R-701 except for value.	Resistor	(-637276-5)	N16-R-68282-2431 (3Z5992-73)	CATE type ALA-5/8	H-1220-4	R-702	1
R-703	*RESISTOR, FIXED: 3 ohms \pm 5%; 2 watts; same as R-701 except for value.	Resistor	(-637277-5)	N16-R-68287-7331 (3Z5993-59)	CATE type ALA-5/8	H-1220-5	R-703	1
R-704	*RESISTOR, FIXED: 6 ohms \pm 5%; 2 watts; same as R-701 except for value.	Resistor	(-637278-5)	N16-R-68302-2071 (3Z5996-39)	CATE type ALA-5/8	H-1220-6	R-704	1
R-705	RESISTOR, FIXED: comp; 10 ohms \pm 5%; 2 watts; temp characteristic F; 0.320 diam x 0.719" lg, max; insulated, humidity and salt-water-immersion resistant; 2 axial wire leads; use only A-B type HB due to equip design.	Resistor	RC40BF100J	N16-R-49238-121 (3Z6001-125)	CBZ type HB 1005	H-1009-110	R-705	1
R-706	RESISTOR, FIXED: 20 ohms \pm 5%; 2 watts; same as R-705 except for value.	Resistor	RC40BF200J	N16-R-49310-121 (3Z6002-74)	CBZ type HB 2005	H-1009-111	R-706	1
R-707	RESISTOR, FIXED: 30 ohms \pm 5%; 2 watts; same as R-705 except for value.	Resistor	RC40BF300J	N16-R-49355-121 (3Z6003-64)	CBZ type HB 3005	H-1009-112	R-707	1
R-708	RESISTOR, FIXED: comp; 60 ohms \pm 5%; 2 watts; temp characteristic F; 0.320" diam x 0.719" lg, max; insulated, humidity and salt-water-immersion resistant; 2 axial wire leads; non RMA value; use only A-B type HB due to equip design.	Resistor	RC40BF600J	N16-R-49472-121 (3Z6006-39)	CBZ type HB 6005	H-1009-113	R-708	1
R-709	RESISTOR, FIXED: 100 ohms \pm 5%; 2 watts; same as R-705 except for value.	Resistor	RC40BF101J	N16-R-49580-121 (3Z6010-217)	CBZ type HB-1015	H-1009-114	R-709	1
R-710	RESISTOR, FIXED: 200 ohms \pm 5%; 2 watts; same as R-705 except for value.	Resistor	RC40BF201J	N16-R-49652-121 (3Z6020-257)	CBZ type HB-2015	H-1009-115	R-710	1

ORIGINAL

Note: All 700 series resistors must be ordered with maximum size indicated.

6-17

TABLE 6-2, CONT'D

SYMBOL DESIG.	NAME OF PART AND DESCRIPTION	FUNCTION	JAN AND (NAVY TYPE) NO.	STANDARD NAVY AND (SIGNAL CORPS) STOCK NO.	MFRG. AND MFRG'S DESIG- NATION	CON- TRACTOR DRAW- ING & PART NO.	ALL SYMBOL DESIG. INVOLVED	QUAN. EQUIP.	QUAN. EQUIP. REPAIR PARTS
R-711	RESISTOR, FIXED: 300 ohms \pm 5%; 2 watts; same as R-705 except for value.	Resistor	RC40BF301J	N16-R-49697-121 (3Z6030-128)	CBZ type HB 3015	H-1009-116	R-711	1	
R-712	RESISTOR, FIXED: 600 ohms \pm 5%; 2 watts; same as R-708 except for value.	Resistor	RC40BF601J	N16-R-49814-121 (3Z6060-93)	CBZ type HB 6015	H-1009-117	R-712	1	
R-713	RESISTOR, FIXED: 1000 ohms \pm 5%; 2 watts; same as R-705 except for value.	Resistor	RC40BF102J	N16-R-49922-121 (3Z6100-252)	CBZ type HB 1025	H-1009-118	R-713	1	
R-714	RESISTOR, FIXED: 2000 ohms \pm 5%; 2 watts; same as R-705 except for value.	Resistor	RC40BF202J	N16-R-49994-126 (3Z6200-193)	CBZ type HB 2025	H-1009-119	R-714	1	
R-715	RESISTOR, FIXED: 3000 ohms \pm 5%; 2 watts; same as R-705 except for value.	Resistor	RC40BF302J	N16-R-50048-126 (3Z6300-204)	CBZ type HB 3025	H-1009-120	R-715	1	
R-716	RESISTOR, FIXED: 6000 ohms \pm 5%; 2 watts; same as R-708 except for value.	Resistor	RC40BF602J	N16-R-50174-121 (3Z6560-79)	CBZ type HB 6025	H-1009-121	R-716	1	
R-717	RESISTOR, FIXED: 10,000 ohms \pm 5%; 2 watts; same as R-705 except for value.	Resistor	RC40BF103J	N16-R-50282-121 (3Z6610-302)	CBZ type HB 1035	H-1009-122	R-717	1	
R-718	RESISTOR, FIXED: 20,000 ohms \pm 5%; 2 watts; same as R-705 except for value.	Resistor	RC40BF203J	N16-R-50363-121 (3Z6620-178)	CBZ type HB 2035	H-1009-123	R-718	1	
R-719	RESISTOR, FIXED: 30,000 ohms \pm 5%; 2 watts; same as R-705 except for value.	Resistor	RC40BF303J	N16-R-50408-121 (3Z6630-104)	CBZ type HB 3035	H-1009-124	R-719	1	
R-720	RESISTOR, FIXED: 60,000 ohms \pm 5%; 2 watts; same as R-708 except for value.	Resistor	RC40BF603J	N16-R-50525-121 (3Z6660-46)	CBZ type HB 6035	H-1009-125	R-720	1	
R-721	RESISTOR, FIXED: 100,000 ohms \pm 5%; 2 watts; same as R-705 except for value.	Resistor	RC40BF104J	N16-R-50633-121 (3Z6700-180)	CBZ type HB 1045	H-1009-126	R-721	1	
R-722	RESISTOR, FIXED: 200,000 ohms \pm 5%; 2 watts; same as R-705 except for value.	Resistor	RC40BF204J	N16-R-50705-121 (3Z6720-64)	CBZ type HB 2045	H-1009-127	R-722	1	
R-723	RESISTOR, FIXED: 300,000 ohms \pm 5%; 2 watts; same as R-705 except for value.	Resistor	RC40BF304J	N16-R-50750-121 (3Z6730-46)	CBZ type HB 3045	H-1009-128	R-723	1	
R-724	RESISTOR, FIXED: 600,000 ohms \pm 5%; 2 watts; same as R-708 except for value.	Resistor	RC40BF604J	N16-R-50867-121 (3Z6760-14)	CBZ type HB 6045	H-1009-129	R-724	1	
R-725	RESISTOR, FIXED: 1 meg \pm 5%; 2 watts; same as R-705 except for value.	Resistor	RC40BF105J	N16-R-50975-131 (3Z6801-107)	CBZ type HB 1055	H-1009-130	R-725	1	
R-726	RESISTOR, FIXED: 2 meg \pm 5%; 2 watts; same as R-705 except for value.	Resistor	RC40BF205J	N16-R-51047-121 (3Z6802-57)	CBZ type HB 2055	H-1009-131	R-726	1	
R-727	RESISTOR, FIXED: 3 meg \pm 5%; 2 watts; same as R-705 except for value.	Resistor	RC40BF305J	N16-R-51101-126 (3Z6803-27)	CBZ type HB 3055	H-1009-132	R-727	1	
R-728	RESISTOR, FIXED: 6 meg \pm 5%; 2 watts; same as R-708 except for value.	Resistor	RC40BF605J	N16-R-51218-126 (3Z6806-11)	CBZ type HB 6055	H-1009-133	R-728	1	

ORIGINAL

800	CAPACITOR, DECADE: consists of one 100 mmf mica capacitor JAN type CM20A101K, one 300 mmf mica capacitor JAN type CM20A301K, one each of following Dubilier type TMC 600 vdcw capacitors, 1000 mmf $\pm 10\%$, 3000 mmf $\pm 10\%$, .01 mf $\pm 10\%$, .02 mf $\pm 10\%$, .1 mf $\pm 10\%$, .25 mf $\pm 10\%$, and two 20/4 mf - 0 + 75% 450 vdcw electrolytic capacitor Dubilier part BRD-3616, all items mounted in common phenolic housing, mica and paper capacitors individually terminated in jacks, electrolytic capacitors terminated in jacks with common negative; 4-3/8" wd x 4-3/4" lg x 1-9/32" h o/a; fits in case CY-703/U when not in use.	Decade test capacitor	TS-671/U	F16-C-55176-1417 (3F4325-671)	CAOR H-2490	H-2490		1
899								
C-801	CAPACITOR, FIXED: mica; 100 mmf $\pm 10\%$; 500 vdcw; 51/64 lg x 15/32" wd x 7/32" h; molded bakelite case; 2 axial wire leads, 1-1/8" lg, #20 AWG.	Capacitor	CM20A101K	N16-C-28558-1671 (3K2010111)	CAW type 1469	H-1080-9	C-801	1
C-802	CAPACITOR, FIXED: mica; 300 mmf $\pm 5\%$; 500 vdcw; 51/64 lg x 15/32" wd x 7/32" h; molded bakelite case; 2 axial wire leads, 1-1/8" lg, #20 AWG.	Capacitor	CM20A301J	N16-C-29660-8991 (3K2030112)	CAW type 1469	H-1080-8	C-802	1
C-803	CAPACITOR, FIXED: paper; single section; 1000 mmf $\pm 10\%$; 600 vdcw; HS metal case w/ vinyl sleeve; 1-3/16" lg x 1/2" diam; mineral oil impr and filled; 2 axial wire leads, 2-1/2" lg; no internal ground connection.	Capacitor	(-484935-10)	N16-C-39696-9549 (3DA1-219)	CD TMC- 6D1-4P	H-1007-19	C-803	1
C-804	CAPACITOR, FIXED: paper; 1 section; 3000 mmf $\pm 10\%$; 600 vdcw; HS metal case w/ vinyl sleeve; 1-3/16" lg x 1/2" diam; mineral oil impregnated and filled; 2 axial wire leads, 2-1/2" lg; no internal ground connection.	Capacitor	CP26A1-F302K	N16-C-40456-9539 (3DA3-119)	CD TMC- 6D3-4P	H-1007-18	C-804	1
C-805	CAPACITOR, FIXED: paper; 1 section; 10,000 mmf $\pm 10\%$; 600 vdcw; HS metal case w/ vinyl sleeve; 1-3/16" lg x 1/2" diam; mineral oil impregnated and filled; 2 axial wire leads, 2-1/2" lg; no internal ground connection.	Capacitor	CP26A1-F103K	16-C-42736-9559 (3DA10-425)	CD TMC- 6S1-4P	H-1007-17	C-805	1
C-806	CAPACITOR, FIXED: paper; 1 section; 20,000 mmf $\pm 10\%$; 600 vdcw; HS metal case w/ vinyl sleeve; 1-3/16" lg x 1/2" diam; mineral oil impregnated and filled; 2 axial wire leads, 2-1/8" lg; no internal ground connection.	Capacitor	(-482727-10)	N16-C-43116-9529 (3DA20-205)	CD TMC- 6S2-4P	H-1007-16	C-806	1
C-807	CAPACITOR, FIXED: paper; 1 section; 100,000 mmf $\pm 10\%$; 600 vdcw; HS metal case w/ vinyl sleeve; 1-7/8" lg x 13/16" diam; mineral oil impregnated and filled; 2 axial wire leads, 2-1/4" lg; no internal ground connection.	Capacitor	(-484937-10)	N16-C-45777-3381 (3DA100-830)	CD TMC- 6P1-4P	H-1007-15	C-807	1

TABLE 6-2, CONT'D

SYMBOL DESIG.	NAME OF PART AND DESCRIPTION	FUNCTION	JAN AND (NAVY TYPE) NO.	STANDARD NAVY AND (SIGNAL CORPS) STOCK NO.	MFGR. AND MFGR'S DESIG- NATION	CON- TRACTOR DRAW- ING & PART NO.	ALL SYMBOL DESIG. INVOLVED	QUAN. EQUIP.	QUAN. EQUIP. REPAIR PARTS
C-808	CAPACITOR, FIXED: paper; 1 section; 250,000 mmf \pm 10%; 600 vdcw; HS metal case w/ vinyl sleeve; 1-7/8" lg x 15/16" diam; mineral oil impregnated and filled; 2 axial wire leads, 2-1/4" lg; no internal ground connection.	Capacitor	(-484938-10)	N16-C-40357-3366 (3DA250-437)	CD TMC- 6P25-4P	H-1007-14	C-808	1	
C-809	CAPACITOR, FIXED: electrolytic; 2 section; 20/4 mf - 0 \pm 75%; 450 vdcw; - 40 deg C to 65 deg C; 2-9/16" lg x 15/16" diam o/a; HS metal case w/ vinyl sleeve; 2 axial wire leads on one end, 1 axial wire lead on other end; 3" lg; negative terminal grounded internally.	Capacitor	(-484939)	N16-C-21439-5350 (3DB20-116)	CD BRD- 10030	H-2484	C-809 C-810	2	
C-809A	CAPACITOR, FIXED: electrolytic; 20 mf; p/o C-809.	Capacitor							
C-809B	CAPACITOR, FIXED: electrolytic; 4 mf; p/o C-809.	Capacitor							
C-810	CAPACITOR, FIXED: electrolytic; 20/4 mf; same as C-809.	Capacitor							
C-810A	CAPACITOR, FIXED: electrolytic; 20 mf; p/o C-810.	Capacitor							
C-810B	CAPACITOR, FIXED: electrolytic; 4 mf; p/o C-810.	Capacitor							
A-901	CASE: holds spare batteries and bulbs, wire and solder; molded vinylite; holds 4 JAN type BA-58 batteries (not supplied), 2 flashlight bulbs (E-904), 10' hook up wire and 12" solder; 1-13/16" wd x 4-1/4" lg x 1-1/16" h o/a; has compartments for batteries and bulbs and winding space for wire and solder; retainer wires hold batteries and bulbs in place.	Case		N16-C-170001-103 (2Z1800.98)	CAOR H-2352	H-2352		1	
A-902	CASE: accessory storage; aluminum, anodized finish; less contents; 31/32" d x 4-1/4" wd x 5-23/32" lg o/a; no compartments or partitions; separable cover.	Case		N16-C-170001-102 (2Z1800.100)	CAOR H-2136	H-2136		1	
E-901	*CONNECTOR, ADAPTER: male one end, female other end; 1 male pin, 1 female socket; straight type; adapts banana plug to phone tip jack; midget banana plug size; 1/4" diam x 1" lg o/a; phenolic body, black.	Adapts banana plug to phone tip jack.	(-491897)	N17-C-67988-1282 (2Z307-75)	CAOR H-2434	H-2434	E-901	4	

E-902	CLIP: alligator one end, insulated phone tip jack other end; alligator clip steel, cadmium finish; 13/32" wd clip end x 7/16" diam jack end x 2-3/4" lg o/a; phenolic insulation; 3/8" max jaw opening.	Clip	N17-C-802609-101 (2Z2708.28)	CXAD #525B	H-2289	E-902	3
E-903	TERMINAL, LUG: spade type on one end, phenolic insulated phone tip, jack other end; spade end, steel cadmium finish; 1/2" wd x 1/32" thk spade end, 7/16" diam jack end, x 2-1/16" lg o/a.	Lug	N17-C-67992-4685 (3Z12073-18.1)	CXAD #525B-879	H-2265	E-903	2
E-904	LAMP, INCANDESCENT: 2.2 V, 0.25 amp; bulb TL-3 clear; 15/16" lg o/a max; min screw base; C-6 fil, white bead; burn any position; lens type bulb.	Bulb for O-901	17-L-6301 (6Z6802.2)	CG #222	H-2225	E-904	1
H-901	SCREWDRIVER: straight; for slotted drive; 4" lg blade; 7-11/16" lg o/a; 3/16" diam round shank; 3/16" wd x 1/32" thk bit; amberyl handle.	Screwdriver	N41-S-1101-1050 (6R15626)	Park Metal- ware R-3164	H-2230	H-901	1
H-902	SCREWDRIVER: straight; for slotted drive; 1-7/8" lg blade; 4" lg o/a; 3/32" diam round shank; 3/32" wd x 0.020" thk bit; amberyl handle.	Screwdriver	N41-S-1099-20 (6R15194)	Park Metal- ware R-3322	H-2231	H-902	1
H-903	SCREWDRIVER: straight; combination slotted drive blade 1-9/16" lg and Phillips drive blade 1-7/8" lg; 3-7/8" lg o/a; 1/4" diam round shank, each blade; 1/4" wd x 3/64" thk bit slot drive, #2 Phillips drive; amberyl handle; blades reversible in handle.	Screwdriver	N41-S-1064-5000 (6R15195)	Park Metal- ware CS-2	H-2232	H-903	1
H-904	WRENCH: Allen Key, 0.050" across flats; 9/16" x 1-7/8" o/a; alloy steel, blued; right angle; for #4 Allen set screw.	Wrench	N41-W-2444-25 (6R55499.2)	CAYT .050 Allen Key, Short Arm	H-2233	H-904	1
H-905	WRENCH: Allen key; 1/16" across flats; 13/16" x 1-7/8" o/a; alloy steel, blued; right angle; for #5 or #6 Allen set screw.	Wrench	N41-W-2445-25 (6R57400-6)	CAYT 1/16 Allen Key, Short Arm	H-2234	H-905	1
H-906	WRENCH: Allen key; 5/64" across flats; 7/8" x 2-1/8" o/a; alloy steel, blued; right angle; for #8 Allen set screw.	Wrench	N41-W-2446-25 (6R57400)	CAYT 5/64 Allen Key, Short Arm	H-2235	H-906	1
H-907	WRENCH: Allen key; 3/32" across flats; 3/4" x 2-1/16" o/a; alloy steel, blued, right angle; for #10 Allen set screw.	Wrench	N41-W-2449-25 (6R55496.1)	CAYT 3/32 Allen Key Short Arm	H-2236	H-907	1
H-908	WRENCH: Allen key; 1/8" across flats; 1" x 2-3/4" o/a; alloy steel, blued; right angle; for 1/4" Allen set screw.	Wrench	N41-W-2450-25 (6R55075-3)	CAYT 1/8 Allen Key, Short Arm	H-2237	H-908	1
H-909	WRENCH: Allen key; 5/32" across flats; 1-1/4" x 3-1/8" o/a; alloy steel, blued; right angle; for 5/16" Allen set screw.	Wrench	N41-W-2451-25 (6R57400-10.3)	CAYT 5/32 Allen Key, Short Arm	H-2238	H-909	1
H-910	SOCKET SET, WRENCH: socket; 8 items all sockets 1/4" sq. drive, hex opening 3/16", 7/32", 1/4", 9/32", 5/16", 11/32", 3/8" and 7/16"; tool steel, nickel plated.	Wrench	N41-W-2965-500 (6R24330-1)	Snap-On TM-6 to TM-14	H-2246	H-910	1

TABLE 6-2, CONT'D

SYMBOL DESIG.	NAME OF PART AND DESCRIPTION	FUNCTION	JAN AND (NAVY TYPE) NO.	STANDARD NAVY AND (SIGNAL CORPS) STOCK NO.	MFGR. AND MFGR'S DESIG- NATION	CON- TRACTOR DRAW- ING & PART NO.	ALL SYMBOL DESIG. INVOLVED	QUAN. EQUIP.	QUAN. EQUIP. REPAIR PARTS
H-911	HANDLE: socket wrench; steel shank, amberyl grip; 7/8" diam x 5-3/4" lg o/a; 1/4" sq drive on 2" lg shank set in 7/8" diam grip; fluted grip; push-on installation.	Handle for socket set		N16-H-150001-101 (6Q51205-5)	Snap-on TM-4X	H-2247	H-911	1	
H-912	PLIERS: chain nose; without cutters; 4-1/4" lg o/a; alloy steel, polished head, blued handles.	Pliers		N41-P-1909-82 (6R4710-4.4)	Uticatools #22-4	H-2248	H-912	1	
H-913	PLIERS: diagonal cutting; with cutters; 4-17/32" lg o/a; alloy steel, polished head.	Cutting pliers		N41-P-1711-1040 (6R4730-4.5)	Uticatools #41-4	H-2249	H-913	1	
H-914	PULLER, FUSE: fibre; 3/4" wd x 1/2" thk x 4-31/32" lg o/a; for fuses 1/4" diam to 5/8" diam.	Fuse pulling		N17-P-91801-1001 (6R7382-4)	Trico Fuse "Midget Size"	H-2254	H-914	1	
H-915	TWEEZERS: steel, nickel plated; 1/2" wd x 6-1/8" lg o/a; blunt point; insulated with vinyl plastic, except tips.	Tweezers		N41-T-4229-500 (6R46206.2)	CZY A-1120	H-2255	H-915	1	
H-916	EXTRACTOR, LAMP: rubber, black, 1/2" diam small end x 7/8" diam large end x 3" lg o/a.	Remove lamps from sockets		N17-E-850271-101 (6Q36920-5)	CAYZ L-73	H-2256	H-916	1	
H-917	TOOL: bakelite; 5/16" diam x 4-3/4" o/a; 1/8" wd x 3/64" thk steel screw-driver bit on one end, 1/8" diam x 3/4" lg brass plug in other end; incorporates both magnetic and non-magnetic metal ends for alignment and general tuning purposes.	Align circuits		N16-T-751655-847 (6R38476-2)	CAOR H-2257	H-2257	H-917	1	
H-918	HOLDER, TEST LEAD: used as holder and winding rack for cords and test leads contained in Test-Tool Set AN/USM-3; aluminum; anodized finish; 1-1/8" wd x 4-23/32" lg x 5-1/2" h o/a.	Holder		N17-R-150048-571 (6Z5250)	CAOR H-2306	H-2306	H-918	1	
H-919	HANDLE: soldering iron: phenolic; 1" diam x 5" lg o/a, 60" lg o/a including power cord; attached POSJ power cord terminated with Belden H-1250 plug; used with soldering iron tips, H-920 and H-921.	Soldering iron		N17-H-150001-102 (6Q51185-5.2)	Ungar #776X Handlecord Set	H-2251	H-919	1	
H-920	TIP, SOLDERING IRON: electric, 20 watts; 5/8" diam x 2-15/16" lg o/a; 117 V; 1/8" diam chisel tip; less handle; used with handle H-919.	Soldering iron tip		N41-T-2325-40 (6R36764-2)	Ungar #538X	H-2252	H-920	1	
H-921	TIP, SOLDERING IRON: electric, 20 watts; 5/8" diam x 2-15/16" lg o/a; 117 V; 1/8" diam round tip; less handle; used with handle H-919.	Soldering iron tip.		N41-T-2325-175 (6R36764-3)	Ungar #537X	H-2253	H-921	1	
H-922	HOLDER, TOOL: steel, nickel plated; tube with slotted ends to hold soldering iron tips; 11/16" diam x 4-5/8" lg o/a.	Holder		N17-H-78201-1001 (6Q52188-1)	CAOR H-2137	H-2137	H-922	1	

HT-901	RECEIVER, TELEPHONE: phenolic; 5000 ohms impedance; 2-1/32" diam x 7/8" h o/a; incorporates special headband fastening feature.	Telephone receiver	(-491898)	N17-R-43438-8601 (2B2125-4)	CTE TH 37A1	H-2269			1
I-901	LIGHT, TEST: prod type with flexible leads; plastic case; 60-500 v AC and 90-500 v DC, 200 K built-in resistor; 5" lg leads terminated in insulated test prods 1/4" diam x 1-1/8" lg, 7/16" diam x 7-3/4" lg o/a.	Test light		N17-L-78719-7305 (2Z5991-109)	CLF #201008 "Tattlelite"	H-2263	I-901		1
N-901	BOOK, REFERENCE: Technician's Handbook for Test-Tool Set AN/USM-3; 5-1/4" x 8".	Reference data		N16-B-670001-102 (6D6998-27)	CAOR H-2597	H-2597	N-901		1
O-901	FLASHLIGHT: tubular brass case, nickel plated; push-button switch, locking; 5/8" diam 5-9/16" lg o/a; requires 2 Sig C batteries BA-58 (same as BT-301); bulb (E-904), 2.2 v, 0.25 amp; less batteries; prefocused; bulb end incorporates threads for attachment of extension O-902.	Flashlight		N17-F-13468-850 (6Z3996.19)	CZY p/o A-1119	H-2261	O-901		1
O-902	ROD, EXTENSION: u/w flashlight O-901; lucite rod with nickel plated brass ferrule and threaded aluminum insert; 21/32" diam ferrule, 3/8" diam rod x 6-7/8" lg o/a.	Extension of flashlight		N17-R-680001-102 (6Z6924-10)	CZY p/o A-1119	H-2262	O-902		1
O-903	MIRROR: glass in phenolic frame 1-1/32" diam incl frame non-magnifying, with hinged split collar to fit flashlight extension O-902; 1-1/32" wd x 5/8" h x 1-13/16" lg o/a.	Mirror		N17-M-250354-941 (6Z7085)	CZY p/o A-1119	H-2264	O-903		1
O-904	ROD, EXTENSION: used to extend prod tips of various items of Test-Tool Set AN/USM-3; consists of phenolic tube with stainless steel core, prod tip one end, female connector other end, plastic cap provided for prod tip when required in use; 1/4" diam x 5-5/16" lg o/a.	Extend prod tips		N17-R-680001-101 (3F3798-10)	CAOR H-2239	H-2239	O-904		1
O-905	HEADBAND: u/w Navy Type CTE-491898 Telephone Receiver; beryllium copper, black nickel finish; consists of 2 metal strips fastened together and formed to fit head when opened; 2-5/16" diam x 11/16" h o/a when coiled for storage.	Headband for telephone receiver	(-491901)	N17-H-46173-4801 (2B742)	CAOR H-2271	H-2271	O-905		1
W-901	*CABLE ASSEMBLY, POWER: type POSJ cable; 2 conductors, #18 AWG, stranded 41 x 34; 300 v working; 57" lg approx excluding terminations, Belden male plug H-1250 one end, Belden female plug H-1166 other end.	Power cable for Tube Tester TV-4/U and Signal Tracer TS-673/U	(-62472)	N17-C-48219-3251 (3E7350.1-57)	CQG CS- 6034	H-2290	W-901		1
W-902	LEAD, ELECTRICAL: #20 AWG stranded tinned copper; 10 #30 AWG strands; red vinylite ins; 600 v working; 30" lg, excluding terminations; ICA part 387R one end, Radio Freq Labs insulated banana plug assm H-2593 other end.	Electrical lead	(-491899)	N17-L-62826-2101 (3E7998.30.1)	CAOR H-2430	H-2430	W-902		2

TABLE 6-2, CONT'D

SYMBOL DESIG.	NAME OF PART AND DESCRIPTION	FUNCTION	JAN AND (NAVY TYPE) NO.	STANDARD NAVY AND (SIGNAL CORPS) STOCK NO.	MFGR. AND MFGR'S DESIG- NATION	CON- TRACTOR DRAW- ING & PART NO.	ALL SYMBOL DESIG. INVOLVED	QUAN. EQUIP.	QUAN. EQUIP. REPAIR PARTS
W-903	LEAD, ELECTRICAL: #20 AWG stranded tinned copper; 10 #30 AWG strands; black vinylite ins; 600 v working; 30" lg, excluding terminations; ICA part 387B one end, Radio Frequency Labs insulated banana plug, assm H-2593 other end.	Electrical lead	(-491899-A)	17-L-62826-2201 (3E7998-30)	CAOR H-2432	H-2432	W-903	2	
W-904	LEAD, ELECTRICAL: #20 AWG stranded tinned copper; 10 # 30 AWG strands; black vinylite ins; 600 v working; 8" lg excluding termination; Radio Freq Labs male and female contact connector assem H-2593 on each end.	Patch cord	(-491895)	N17-L-62668-6801 (3E7998-8.1)	CAOR H-2594	H-2594	W-904	12	
A-1001	CASE: aluminum, grey finish; empty; 10-1/2" lg x 9-7/8" wd x 7" h o/a; 1 hinged handle on front; 2 D rings on sides.	Carrying case for Test-Tool Set AN/USM-3	CY-703/U	N16-C-170001-104 (2Z1800.99)	CAOR H-2149	H-2149	A-1001	1	
0-1001	FASTNER, LATCH: steel, cadmium plated; 7/8" wd x 2-3/8" lg x 1/2" h o/a; two 9/64" diam mtg holes on 7/16" ctrs (latch), two 1/8" diam holes on 17/32" ctrs (catch).	Case fasteners		N17-L-150001-104 (6Z3810-90)	Corbin Cabinet #15797C	H-2171	O-1001	2	
0-1002	*GASKET: neoprene, grey; one piece molded circle approx 11-3/4" diam oval cross-section 1/4" wd x 7/16" h; has slot to fit case edge.	Case seal		N17-G-151779-551 (2Z4867.570)	CAOR H-2179	H-2179	O-1002	1	
0-1003	*HOLDER, TOOL: vinylite; bottom tray and cover with cavities to hold tools; 9-1/4" lg x 9-1/4" wd x 1-1/32" h o/a; cover fastens in place by snap-slides.	Tool holder	CY-704/U	N17-H-78201-1002 (6Q52184)	CAOR H-2307	H-2307	O-1003	1	

ORIGINAL

TABLE 6-3. CROSS REFERENCE PARTS LIST

JAN (OR AWS) DESIGNATION	KEY SYMBOL	NAVY TYPE	KEY SYMBOL	NAVY TYPE	KEY SYMBOL	STANDARD NAVY STOCK NO.	KEY SYMBOL	STANDARD NAVY STOCK NO.	KEY SYMBOL	STANDARD NAVY STOCK NO.	KEY SYMBOL
RC20BF204J	R-118	-484943	C-101	-484941	C-209	F16-T-21380-2429	100	N17-C-62718-6701	W-102	N16-R-49922-811	R-211
RC20BF514J	R-119	-20661	CR-101	-484942	C-210		to	N16-S-64063-6710	X-101	N16-R-50282-811	R-212
SO10M	X-114	-28041-1	F-101	-20636	CR-202		199	N16-S-63584-9641	X-102	N16-R-50283-231	R-213
VG-11	E-203	-22741	M-101	-22742	M-201	N16-C-47321-9190	C-101	N16-S-63520-6441	X-103	N16-R-50497-431	R-214
SOS3	E-206	-491960	P-101	-491960	P-202	N17-R-50807-1624	CR-101	N16-S-63584-9641	X-104	N17-T-73621-3701	T-201
RC20BF245J	R-203	-637281-1/2	R-101	-637296-K20	R-202	N17-L-6806-130	E-101	N16-S-63520-6441	X-105	N16-T-58241-60	V-201
RC20BF513J	R-204	-637283-1/2	R-102	-304850	T-201	N16-S-34557-8367	E-102	N16-S-62601-5687	X-106	N16-T-58241-60	V-202
RC20BF105K	R-205	-637284-1/2	R-103	-491894	X-201	N17-F-74264-9001	E-103	N16-S-63584-9641	X-107	N16-T-56195	V-203
RC20BF102K	R-207	-637282-1/2	R-104	-491894	X-202	N16-K-700026-101	E-104	N16-S-63520-6441	X-108	N16-C-11943-8231	W-201
RC20BF104K	R-208	-637291-1/2	R-105	-637275-5	R-701	N17-F-17373-70	F-101	N16-S-62768-1091	X-109	N16-S-64063-6706	X-201
RC20BF244J	R-209	-637293-1/2	R-106	-637276-5	R-702	N17-L-76742-8038	I-101	N16-S-62157-9641	X-110	N16-S-64063-6706	X-202
RC20BF103K	R-212	-637289-1/2	R-107	-637277-5	R-703	N17-C-73107-7647	J-101	N16-S-64063-6710	X-111	N16-S-62603-6679	X-203
RC30BF103K	R-213	-637290-1/2	R-108	-637278-5	R-704	N17-C-73107-7647	J-102	N16-S-60646-8291	X-112	F16-G-59001-1001	300 to
12AX7	V-201	-637292-1/2	R-109	-484935-10	C-803	N17-M-21871-2261	M-101	N16-S-62601-5687	X-113		399
6AL5	V-202	-637294-1/2	R-110	-482727-10	C-806	N16-B-670001-101	N-101	N16-S-62603-6679	X-114	F17-P-84881-7666	400 to
RC30BF514J	R-401	-637288-1/2	R-111	-484937-10	C-807	N17-C-73439-4929	P-101	F16-A-27109-5501	200 to		499
CC21SL510J	C-501	-637286-1/2	R-112	-484938-10	C-808	N16-R-78617-4224	R-101		299	F17-P-84881-7676	500 to
RC40BF100J	R-705	-637285-1/2	R-113	-484939	C-809	N16-R-78954-5499	R-102	N16-C-40495-3688	C-205		599
RC40BF200J	R-706	-637287-1/2	R-114	-484939	C-810	N16-R-78989-2424	R-103	N16-C-45805-6630	C-206	F17-P-84841-1831	600
RC40BF300J	R-707	-634262-10	R-115	-491897	E-901	N16-R-78897-5499	R-104	N16-C-45805-6630	C-207		699
RC40BF600J	R-708	-637279-10	R-116	-491898	HT-901	N16-R-79229-7659	R-105	N16-C-44283-3187	C-208	F16-R-44647-9999	700
RC40BF101J	R-709	-637280-5	R-117	-491901	O-905	N16-R-79302-6615	R-106	N16-C-22484-1271	C-209		799
RC40BF201J	R-710	-241416	S-102	-62472	W-901	N16-R-78886-8885	R-107	N16-C-19456-4654	C-210	N16-R-68273-3591	R-701
RC40BF301J	R-711	-241347	S-103	-491899	W-902	N16-R-79066-3999	R-108	N17-R-50807-1634	CR-202	N16-R-68282-2431	R-702
RC40BF601J	R-712	-241413	S-104	-491899-A	W-903	N16-R-79251-7824	R-109	N17-F-73767-5001	E-201	N16-R-68287-7331	R-703
RC40BF102J	R-713	-241413	S-105	-491895	W-904	N16-R-79385-6939	R-110	N17-B-77583-5765	E-202	N16-R-68302-2071	R-704
RC40BF202J	R-714	-241413	S-106			N16-R-78817-6024	R-111	N17-L-6806-120	E-203	N16-R-49238-121	R-705
RC40BF302J	R-715	-241413	S-107			N16-R-79191-9624	R-112	N16-S-34576-6515	E-204	N16-R-49310-121	R-706
RC40BF602J	R-716	-241413	S-108			N16-R-79071-3699	R-113	N16-S-34576-6515	E-205	N16-R-49355-121	R-707
RC40BF103J	R-717	-241413	S-109			N16-R-79426-1144	R-114	N16-S-34520-3849	E-206	N16-R-49472-121	R-708
RC40BF203J	R-718	-241413	S-110	TV-4/U	100-199	N16-R-70644-5441	R-115	N17-P-84825-7076	E-207	N16-R-49580-121	R-709
RC40BF303J	R-719	-241413	S-111	TS-673/U	200-299	N16-R-90398-7670	R-116	N17-P-84877-4451	E-208	N16-R-49652-121	R-710
RC40BF603J	R-720	-304851	T-101	MX-933/U	E-207	N16-R-90262-9996	R-117	N16-K-700226-101	E-209	N16-R-49697-121	R-711
RC40BF104J	R-721	-491961	X-101	MX-934/U	E-208	N16-R-49327-431	R-118	N17-F-17373-70	F-201	N16-R-49814-121	R-712
RC40BF204J	R-722	-491576	X-102	CG-570/U (3'0")	W-201	N16-R-50839-431	R-119	N43-N-4743-520	H-201	N16-R-49922-121	R-713
RC40BF304J	R-723	-491577	X-103	SG-23/U	300-399	N17-S-66211-8283	S-101	N17-C-73107-7652	J-203	N16-R-49994-126	R-714
RC40BF604J	R-724	-491577	X-104	ID-265/U	400-499	N17-S-60634-6805	S-102	N17-C-73108-1959	J-204	N16-R-50048-126	R-715
RC40BF105J	R-725	-491577	X-105	ID-263/U	500-599	N17-S-74213-8160	S-103	N17-C-73108-1959	J-205	N16-R-50174-121	R-716
RC40BF205J	R-726	-491959	X-106	ID-264/U	600-699	N17-S-72069-5575	S-104	N17-M-21873-2251	M-201	N16-R-50282-121	R-717
RC40BF305J	R-727	-491576	X-107	TS-672/U	700-799	N17-S-72069-5575	S-105	N17-C-73439-4929	P-202	N16-R-50363-121	R-718
RC40BF605J	R-728	-491577	X-108	TS-671/U	800-899	N17-S-72069-5575	S-106	N16-R-88342-5230	R-202	N16-R-50408-121	R-719
CM20A101K	C-801	-491962	X-109	CY-703/U	A-1001	N17-S-72069-5575	S-107	N16-R-51073-431	R-203	N16-R-50525-121	R-720
CM20A301J	C-802	-491963	X-110	CY-704/U	O-1003	N17-S-72069-5575	S-108	N16-R-50497-431	R-204	N16-R-50633-121	R-721
CP26A1-F302K	C-804	-491961	X-111			N17-S-72069-5575	S-109	N16-R-50975-811	R-205	N16-R-50705-121	R-722
CP26A1-F103K	C-805	-491958	X-112			N17-S-72069-5575	S-110	N16-R-50497-431	R-206	N16-R-50750-121	R-723
		-491959	X-113			N17-S-72069-5575	S-111	N16-R-49922-811	R-207	N16-R-50867-121	R-724
		-484940-20	C-205			N17-T-73646-6833	T-101	N16-R-50633-811	R-208	N16-R-50975-131	R-725
		-482829-20	C-206			N16-T-53140	V-101	N16-R-50722-431	R-209	N16-R-51047-131	R-726
		-482829-20	C-207			N17-L-62701-2801	W-101	N16-R-49922-811	R-210	N16-R-51101-126	R-727
		-484936-20	C-208								

TABLE 6-3. CROSS REFERENCE PARTS LIST

STANDARD NAVY STOCK NO.	KEY SYMBOL	STANDARD NAVY STOCK NO.	KEY SYMBOL	SIGNAL CORPS STOCK NO.	KEY SYMBOL	SIGNAL CORPS STOCK NO.	KEY SYMBOL	SIGNAL CORPS STOCK NO.	KEY SYMBOL	SIGNAL CORPS STOCK NO.	KEY SYMBOL
N16-R-51218-126	R-728	N17-C-48219-3251	W-901	3Z9858-8.202	S-105	2Z3022-120	P-202	3Z6620-178	R-718	6Q52188-1	H-922
F16-C-55176-1417	800 to 899	N17-L-62826-2101	W-902	3Z9858-8.202	S-106	3Z7499-1.78	R-202	3Z6630-104	R-719	2B2125-4	HT-901
		N17-L-62826-2201	W-903	3Z9858-8.202	S-107	3RC20BF245J	R-203	3Z6660-46	R-720	2Z5991-109	I-901
N16-C-28558-1671	C-801	N17-L-62668-6801	W-904	3Z9858-8.202	S-108	3RC20BF513J	R-204	3Z6700-180	R-721	6D6998-27	N-901
N16-C-29660-8991	C-802	N16-C-170001-104	A-1001	3Z9858-8.202	S-109	3RC20BF105K	R-205	3Z6720-64	R-722	6Z3996-19	O-901
N16-C-39696-9549	C-803	N17-L-150001-104	O-1001	3Z9858-8.202	S-110	3RC20BF513J	R-206	3Z6730-46	R-723	6Z6924-10	O-902
N16-C-40456-9539	C-804	N17-G-151779-551	O-1002	3Z9858-8.202	S-111	3RC20BF102K	R-207	3Z6760-14	R-724	6Z7085	O-903
N16-C-42736-9559	C-805	N17-H-78201-1002	O-1003	2Z9619-211	T-101	3RC20BF104K	R-208	3Z6801-107	R-725	3F3798-10	O-904
N16-C-43116-9529	C-806			2J3A4	V-101	3RC20BF244J	R-209	3Z6802-57	R-726	2B742	O-905
N16-C-45777-3381	C-807	SIGNAL CORPS STOCK NO.	KEY SYMBOL	3E7998-12.3	W-101	3RC20BF102K	R-210	3Z6803-27	R-727	3E7350.1-57	W-901
N16-C-40357-3366	C-808	3F3930-4	100 to 199	3E7998-14.3	W-102	3RC20BF102K	R-211	3Z6806-11	R-728	3E7998-30.1	W-902
N16-C-21439-5350	C-809			2Z8679.17	X-101	3RC20BF103K	R-212	3F4325-671	800 to 899	3E7998-30	W-903
N16-C-21439-5350	C-810	3DA500-146	C-101	2Z8678.309	X-102	3RC30BF103K	R-213		899	3E7998-8.1	W-904
N16-C-170001-103	A-901	3F3778-1	CR-101	2Z8678.308	X-103	3RC20BF513J	R-214	3K2010111	C-801	2Z1800.99	A-1001
N16-C-170001-102	A-902	2Z5889-17	E-101	2Z8678.308	X-104	2Z9619-210	T-201	3K2030112	C-802	6Z3810-90	O-1001
N17-C-67988-1282	E-901	2ZK11102.4	E-102	2Z8677.127	X-105	2J12AX7	V-201	3DA1-219	C-803	2Z4867.570	O-1002
N17-C-802609-101	E-902	3Z2876-8	E-103	2Z8678.309	X-106	2J12AX7	V-202	3DA3-119	C-804	6Q52184	O-1003
N17-C-67992-4685	E-903	2Z5822-250	E-104	2Z8678.308	X-107	2J6AL5	V-203	3DA10-425	C-805		
N17-L-6301	E-904	2Z5261-49	F-101	2Z8677.126	X-108	1F430-570.36	W-201	3DA20-205	C-806		
N41-S-1101-1050	H-901	2Z5991-108	I-101	2Z8676.93	X-109	2Z8679.18	X-201	3DA100-830	C-807		
N41-S-1099-20	H-902	2Z3062-177	J-101	2Z8679.17	X-110	2Z8679.18	X-202	3DA250-437	C-808		
N41-S-1064-5000	H-903	2Z3062-177	J-102	2Z8677.128	X-111	2Z8677.108	X-203	3DB20-116	C-809		
N41-W-2444-25	H-904	3F871-16	M-101	2Z8677.127	X-112	3F3835-23	300 to 399	3DB20-116	C-810		
N41-W-2445-25	H-905	6D6998-28	N-101	2Z8677.108	X-113		400 to 499	2Z1800.98	A-901		
N41-W-2446-25	H-906	2Z3022-120	P-101	3F4325-673	X-114	3F3711-265	400 to 499	2Z1800.100	A-902		
N41-W-2449-25	H-907	3Z5993-60	R-101		299	3F3711-263	500 to 599	2Z2708.28	E-901		
N41-W-2450-25	H-908	3Z6016E5-4	R-102	3DA3-120	C-205		599	3Z12073-18.1	E-902		
N41-W-2451-25	H-909	3Z6030-127	R-103	3DA100-829	C-206	3F3711-264	600 to 699	6Z6802.2	E-903		
N41-W-2965-500	H-910	3Z6008H8-5	R-104	3DA100-829	C-207		700 to 799	6R15626	H-904		
N16-H-150001-101	H-911	3Z6573B2	R-105	3DA50-339	C-208	3F4325-672	700 to 799	6R15194	H-902		
N41-P-1909-82	H-912	3Z6626B21	R-106	3DB30-54	C-209			6R15195	H-903		
N41-P-1711-1040	H-913	3Z6007F6-1	R-107	3DB5-104	C-210	3Z5991-102	R-701	6R55499.2	H-904		
N17-P-91801-1001	H-914	3Z6072F6	R-108	3F33680-2	CR-202	3Z5992-73	R-702	6R57400-6	H-905		
N41-T-4229-500	H-915	3Z6595-1	R-109	3Z3282-34.1	E-201	3Z5993-59	R-703	6R57400	H-906		
N17-E-850271-101	H-916	3Z6007-19	R-110	3Z770-3.7	E-202	3Z5996-39	R-704	6R55496.1	H-907		
N16-T-751655-847	H-917	3Z6004-52	R-111	2Z5954	E-203	3Z6001-125	R-705	6R55075-3	H-908		
N17-R-150048-571	H-918	3Z6470-36	R-112	2Z8304.137	E-204	3Z6002-74	R-706	6R57400-10.3	H-909		
N17-H-150001-102	H-919	3Z6076E5-1	R-113	2Z8304.137	E-205	3Z6003-64	R-707	6R24330-1	H-910		
W41-T-2325-40	H-920	3Z6716-7	R-114	2Z8304.146	E-206	3Z6006-39	R-708	6Q51205-5	H-911		
N41-T-2325-175	H-921	3Z6200-194	R-115	3F3711-267	E-207	3Z6010-217	R-709	6R4710-4.4	H-912		
N17-H-78201-1001	H-922	3Z7235-11	R-116	3F3711-266	E-208	3Z6020-257	R-710	6R4730-4.5	H-913		
N17-R-43438-8601	HT-901	3Z7150-8	R-117	2Z5822-249	E-209	3Z6030-128	R-711	6R7382-4	H-914		
N17-L-78719-7305	I-901	3RC20BF204J	R-118	3Z2601.49	F-201	3Z6060-93	R-712	6R46206.2	H-915		
N16-B-670001-102	N-901	3RC20BF514J	R-119	6L3102-56-3.1	H-201	3Z6100-252	R-713	6Q36920-5	H-916		
N17-F-13468-850	O-901	3Z9825-33.26	S-101	2Z3062-176	J-203	3Z6200-193	R-714	6R38476-2	H-917		
N17-R-680001-102	O-902	3Z9825-33.25	S-102	2Z5531.4	J-204	3Z6300-204	R-715	6Z5250	H-918		
N17-M-250354-941	O-903	3Z9858-8.203	S-103	2Z5531.4	J-205	3Z6560-79	R-716	6Q51185-5.2	H-919		
N17-R-680001-101	O-904	3Z9858-8.202	S-104	3F872-28	M-201	3Z6610-302	R-717	6R36764-2	H-920		
N17-H-46173-4801	O-905							6R36764-3	H-921		

TABLE 6-4. COLOR CODES AND MISCELLANEOUS DATA

CAPACITOR COLOR CODES

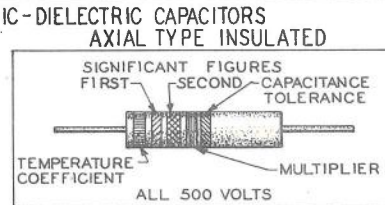
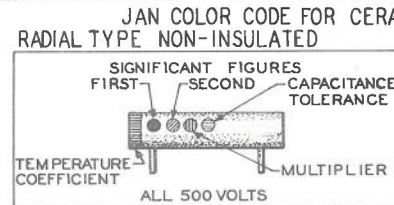
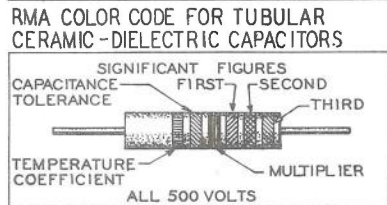
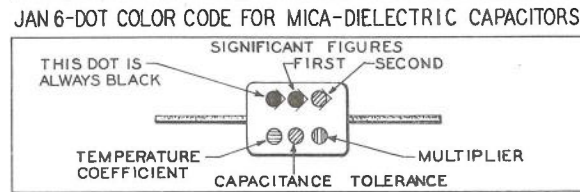
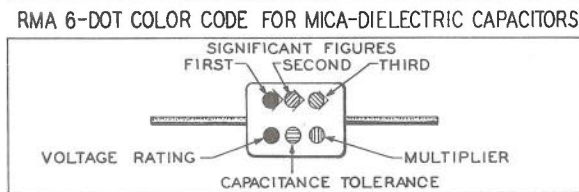
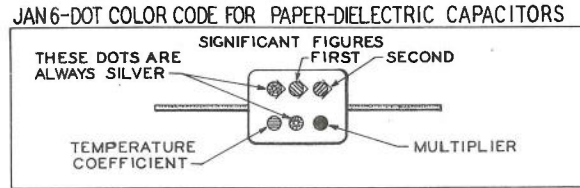
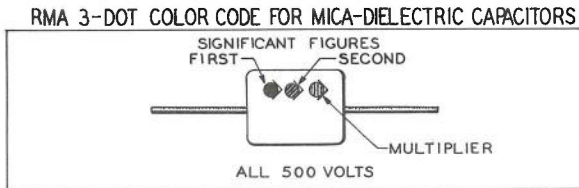

RMA: RADIO MANUFACTURERS ASSOCIATION

JAN: JOINT ARMY-NAVY

RESISTORS		CAPACITORS					VOLTAGE RATING	TEMPERATURE COEFFICIENT
TOLERANCE	MULTIPLIER	SIGNIFICANT FIGURE	COLOR	MULTIPLIER				
				RMA MICA AND CERAMIC-DIELECTRIC	JAN MICA AND PAPER-DIELECTRIC	JAN CERAMIC DIELECTRIC		
	1	0	BLACK	1	1	1	A	
	10	1	BROWN	10	10	10	B	
	100	2	RED	100	100	100	C	
	1,000	3	ORANGE	1,000	1000	1000	D	
	10,000	4	YELLOW	10,000			E	
	100,000	5	GREEN	100,000			F	
	1,000,000	6	BLUE	1,000,000			G	
	10,000,000	7	VIOLET	10,000,000			700	
	100,000,000	8	GRAY	100,000,000		0.01	800	
	1,000,000,000	9	WHITE	1,000,000,000		0.1	900	
5	0.1		GOLD	0.1	0.1		1000	
10	0.01		SILVER	0.01	0.01		2000	
20			NO COLOR				500	

RESISTOR COLOR CODES

RMA COLOR CODE FOR FIXED COMPOSITION RESISTORS

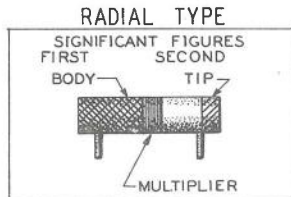
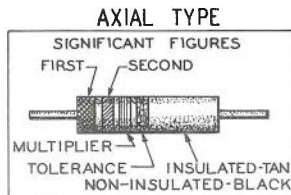

JAN COLOR CODE FOR FIXED COMPOSITION RESISTORS

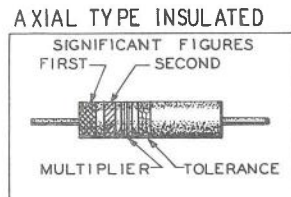

RADIAL TYPE NON-INSULATED

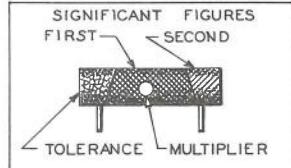

TABLE 6-5. LIST OF MANUFACTURERS

PREFIX	NAME	ADDRESS	PREFIX	NAME	ADDRESS
CD	Cornell-Dubilier Corp.	1000 Hamilton Blvd. South Plainfield, N. J.	CTE	Telephonics Corp.	350 West 31st St., New York, N.Y.
CG	General Electric Company	Schenectady, N. Y.	CUT	United Transformer Corp.	148 Varick St., New York, N.Y.
CV	Weston Electrical Instrument Corp.	619 Frelinghuysen Avenue, Newark, N. J.	CYA	Alden Products Co.	Brockton, Mass.
CAW	Aerovox Corp.	742 Belleville Avenue New Bedford, Mass.	CZY	Allied Radio Corp.	833 Jackson Blvd., Chicago, Ill.
CBZ	Allen-Bradley Company	118 W. Greenfield Avenue Milwaukee, Wis.	CAOR	Radio Frequency Laboratories, Inc.	Boonton, N. J.
CER	Erie Resistor Corp.	644 W. 12th Street Erie, Pennsylvania	CAPY	Dumont Electric Corp.	34 Hubert Street, New York, N.Y.
CHH	Arrow-Hart and Hegeman Electric Co.	102 Hawthorne Street Hartford, Conn.	CARO	Industrial Products Co.	Danbury, Conn.
CHS	Sylvania Electric Products	Emporium, Pennsylvania	CATE	Instrument Resistance Co.	Little Falls, N. J.
CIR	International Resistance Corp.	401 N. Broad Street Philadelphia, Pennsylvania	CAYT	Allen Mfg. Co.	Hartford, Connecticut
CLF	Littlefuse, Inc.	4765 Ravenswood Avenue Chicago 40, Ill.	CAYZ	Dial Light Corp.	900 Broadway, New York, N.Y.
CMA	P. R. Mallory Co.	1941 Thomas Street Indianapolis, Inc.		Corbin Cabinet Lock Co.	New Britain, Connecticut
CMG	Cinch Mfg. Co.	2339 W. Van Buren Street Chicago, Ill.		Harry Davies Molding Co.	1428 North Wells Street, Chicago, Illinois
CMH	American Radio and Hardware Co., Inc.	476 Broadway, New York, N.Y.		Park Metalware Co.	Orchard Park, N. Y.
COM	Ohmite Manufacturing Co.	4835 W. Flourney St., Chicago, Ill.		Snap-on-Tool Corp.	Kenosha, Wisconsin
CPH	American Phenolic Corp.	1630 S. Fifty-fourth Ave. Chicago, Ill.		Trico Fuse Mfg. Co.	Milwaukee, Wisconsin
CQG	Belden Mfg. Co.	P.O. Box 507 OA, Chicago, Ill.		Ungar, Harry A., Inc.	Los Angeles 54, California
CSF	Sprague Specialties Co.	N. Adams, Mass.		Utica Drop Forge and Tool Corp.	Utica, New York
CSL	Solar Mfg. Co.	588 Ave. A., Bayonne, N.Y.			

INDEX

SUBJECT	TABLE	FIGURE	PAGE
A			
Accessories—list of.....	1-3	1-6
Adapter connectors—use of.....	1-4
Adjustments—			
interference generator buzzer contact.....	5-12
screws.....	5-12
signal tracer level adjust.....	4-7
tube tester line adjust.....	4-2
Amplifier—signal tracer.....	1-2
Application, typical—			
decade capacitor.....	4-12
decade resistor.....	4-12
interference generator.....	4-9
resistance indicator-probe.....	4-11
rf indicator-probe.....	4-10
signal tracer.....	4-7
tube tester.....	4-6
voltage indicator-probe.....	4-10
B			
Batteries—			
table of, complement.....	1-2	1-5
installation of.....	3-1, 3-2, 3-3	3-0
Buzzer—winding data.....	5-4	5-14
C			
Capabilities and limitations of—			
decade capacitor.....	4-4
decade resistor.....	4-4
interference generator.....	4-9
resistance indicator-probe.....	4-11
RF indicator-probe.....	4-10
signal tracer.....	4-7
tube tester.....	4-1
voltage indicator-probe.....	4-9
Capacity meter section of tube tester.....	2-2
Circuit description of—			
interference generator.....	2-3
resistance indicator-probe.....	2-3
RF indicator-probe.....	2-3
signal tracer.....	2-2
tube tester—			
basic circuit.....	2-0
capacity meter section.....	2-2
short test circuit.....	2-1
voltage indicator-probe.....	2-3
Cognizant naval inspector.....	1-5
Color codes.....	6-4	6-27
Controls, tube tester.....	2-0
Correction page.....	C
Cubical contents.....	1-6
Curves—capacity vs. power frequencies.....	4-1	4-1
D			
Data, reference.....	1-5
Description of—			
adapter connectors.....	1-4

SUBJECT	TABLE	FIGURE	PAGE
battery and bulb case.....	
case.....	1-1
decade capacitor.....	1-4
decade resistor.....	1-4
electrical leads.....	1-4
interference generator.....	1-3
power cable assembly.....	1-4
RF indicator-probe.....	1-3
resistance indicator-probe.....	1-4
signal tracer.....	1-2
technician's handbook.....	1-5
tool holder.....	1-4
tools and minor items.....	1-3	1-6
tube data index.....	
tube tester.....	1-1
voltage indicator-probe.....	1-3
Diagrams—			
simplified of—			
capacity meter section of tube tester.....	2-2	2-2
interference generator.....	2-4	2-3
signal tracer.....	2-3	2-2
tube test section of tube tester.....	2-1	2-0
schematic of—			
decade capacitor.....	5-18	5-13
decade resistor.....	5-17	5-13
interference generator.....	5-13	5-12
resistance indicator-probe.....	5-16	5-12
RF cable assembly.....	5-11	5-10
RF indicator-probe.....	5-15	5-12
signal tracer.....	5-11	5-10
test prod MX-933/U.....	5-11	5-10
test prod MX-934/U.....	5-11	5-10
tube tester.....	5-6	5-4
voltage indicator-probe.....	5-14	5-12
Dimensions of units.....	1-3	1-6
E			
Effective pages—list of.....	A
Electrical leads.....	1-4
Electrode switches—description of.....	2-0
Equipment—			
location of.....	1-1	1-0
purpose and basic principles.....	1-1
supplied, table of.....	1-3	1-6
Expendable units.....	5-12
Extension rod—use of.....	1-3
F			
Failure report.....	iv
Frequencies—			
interference generator.....	1-3
signal tracer.....	1-2
G			
Guarantee.....	v
General description—see Description			
I			
Identification of—			
decade capacitor.....	1-9	1-4
decade resistor.....	1-8	1-4

SUBJECT	TABLE	FIGURE	PAGE
headband.....	1-3	1-2
interference generator.....	1-4	1-3
power cable assembly.....	1-3	1-2
resistance indicator-probe.....	1-7	1-4
RF cable assembly.....	1-3	1-2
RF indicator-probe.....	1-6	1-3
signal tracer.....	1-3	1-2
telephone receiver.....	1-3	1-2
test prod MX-933/U.....	1-3	1-2
test prod MX-934/U.....	1-3	1-2
tube tester controls.....	1-2	1-1
tube tester sockets.....	5-3
units in case.....	1-1	1-0
voltage indicator-probe.....	1-5	1-3
Impedance—telephone receiver.....	6-2	6-23
Indicating instrument—tube tester.....	2-2
Installation record.....	iii

M

Maintenance—			
decade capacitor.....	5-12
decade resistor.....	5-12
interference generator.....	5-12
resistance indicator-probe.....	5-12
RF indicator-probe.....	5-12
signal tracer.....	5-8
tube tester—			
detailed checks.....	5-3
disassembly and inspection.....	5-2
line check.....	5-7
line short check rectifier.....	5-7
preliminary tests.....	5-2
short indicator.....	5-3
voltage indicator-probe.....	5-12
Major units—list of.....	1-3,1-3	1-6,6-1
Manufacturers—list of.....	6-28

O

Operation of—			
decade capacitor.....	4-11
decade resistor.....	4-11
interference generator.....	4-9
resistance indicator-probe.....	4-11
RF indicator-probe.....	4-10
signal tracer.....	4-7
tube tester—			
capacity meter section.....	4-5
controls.....	2-0
detailed procedure.....	4-2
summary of.....	4-4
voltage indicator-probe.....	4-9
Ordering parts—instructions for.....	iv

P

Parts—			
cross reference list.....	6-25
list.....	6-2	6-1
method of shipment.....	6-1
ordering instructions.....	iv
Power cable assembly—use of.....	1-4
Power consumption.....	1-4	1-5
Power supplies required.....	1-5

SUBJECT	TABLE	FIGURE	PAGE
Power transformer of tube tester—			
description of.....	2-1
position of terminals.....	5-7	5-5
winding data.....	5-7	5-14
Preparation for use.....	3-0
Promulgating letter.....	B
R			
Reference data.....	1-5
Repair of units-see maintenance.....	
Replacement of units in case.....	3-0
Resistance table, tube tester.....	5-1	5-6
Resuscitation notice.....	V
S			
Safety notice.....	V
Socket panel, description of.....	5-3
Socket panel, removal of.....	5-3
Sockets—tube, relative location—			
signal tracer.....	5-9	5-9
tube tester.....	5-5	5-3
Symbols, tube data chart.....	4-3
T			
Technical summary.....	1-4	1-6
Tools—list of.....	1-1	1-6
U			
Unpacking—instructions for.....	3-1
V			
Vacuum tubes—			
cause of failure.....	2-1
characteristics.....	5-6	5-13
data, method of establishing.....	4-4
operating voltages and currents.....	5-5	5-13
symbols, data chart.....	4-3
table of, complement.....	1-1	1-5
testing—			
battery types.....	4-3
center top filament types.....	4-3
diodes.....	4-3
for cathode leakage.....	4-4
for emission.....	4-4
for inter-electrode short.....	4-2
for intermittent operation.....	2-2
for open element.....	4-3
normal types.....	4-3
special types.....	4-3
Voltages—signal tracer.....	5-4	5-9
W			
Weights of—			
individual units.....	1-3	1-6
total equipment.....	1-5