

TM 11-2545

WAR DEPARTMENT TECHNICAL MANUAL

Automatic Transmitter for Perforated Tape (Wheatstone) McElroy Type XTR-442-C

WARNING: This manual is the property of the United States Government, and is printed and distributed solely for the use of the military, naval, and civilian personnel of the War and Navy Departments, and may not be published or reproduced in whole or in part, or in any manner or form (except by lawful copyright holders who may reproduce their copyrighted material in its original form) unless specifically approved by authorized military public relations agencies.

Automatic Transmitter for Perforated Tape (Wheatstone) McElroy Type XTR-442-C



WAR DEPARTMENT

22 JANUARY 1945

WARNING: This manual is the property of the United States Government, and is printed and distributed solely for the use of the military, naval, and civilian personnel of the War and Navy Departments, and may not be published or reproduced in whole or in part, or in any manner or form (except by lawful copyright holders who may reproduce their copyrighted material in its original form) unless specifically approved by authorized military public relations agencies.

WAR DEPARTMENT,
WASHINGTON 25, D. C., 22 JANUARY 1945.

TM 11-2545, Automatic Transmitter for Perforated Tape (Wheatstone) McElroy Type XTR-442-C, is published for the information and guidance of all concerned.

[A. G. 300.7 (31 July 44).]

BY ORDER OF THE SECRETARY OF WAR:

G. C. MARSHALL,
Chief of Staff.

OFFICIAL:

J. A. ULIO,
Major General,
The Adjutant General.

DISTRIBUTION:

IC 11(5).

AAF (5); AGF (5); ASF (2); T of Opn (5); Dept (5); Def Comd (2); Base Comd (5); AAF Comd (2); Arm & Sv Bd (2); S Div ASF (1); Tech Sv (2); SvC (5); Area ASvC (2); WDGS Lib (5); PC&S (2); PE (2); Dep 11 (2); Gen Overseas SOS Dep (Sig Sec) (2); GH (2); M Conc C (2); Air Base Hosp (2); Gen Sv Sch (5); Sp Sv Sch (10); USMA (2); ROTC (5); Lab 11 (2); Sig AS (2); Rep Shop 11 (2); A (5); D (2); AF (2); T/O & E:

11-107 (5); 11-127 (5); 11-237 (5); 11-500, Sig Sv Orgn-Radio Telegraph Fixed Sta 1 Position (EH) (2), Radio Telegraph Fixed Sta 2 Position (EI) (2), Radio Telegraph Fixed Sta 3 Position (EJ) (2), Multi-channel Single Side Band Radio Sta (EL) (2); 11-587 (5); 11-592 (5); 11-597 (5).

(For explanation of symbols see FM 21-6.)

TABLE OF CONTENTS

SECTION	I. Description.	Paragraph	Page
	General	1	1
	Types of operation	2	1
	Components	3	1
	Tape required for operation	4	4
	Power required for operation	5	6
	Dimensions	6	6
	Weight	7	6
	 II. Installation and operation.		
	Unpacking	8	7
	Preparation for use	9	7
	Operation	10	9
	 III. Functioning of parts.		
	Introduction	11	11
	Auto head	12	13
	Speed mechanism	13	14
	Control tube	14	15
	Tone generator	15	16
	Power supply	16	17
	 IV. Maintenance.		
	Inspection	17	18
	Lubrication	18	18
	Adjusting keying relay	19	21
	Synchronizing selector pins	20	21
	Adjusting auto head contacts	21	22
	Replacing selector pin spring	22	22
	Replacing selector pins	23	23
	Replacing contact springs	24	23
	Adjusting slip plate	25	23
	Adjusting tape feed roller	26	24
	Replacing insulating sleeves	27	24
	Replacing rocker	28	24
	Replacing shoulder washers	29	25

TABLE OF CONTENTS

	<i>Paragraph</i>	<i>Page</i>
SECTION IV. Maintenance (contd).		
Mechanical trouble location	30	25
Electrical trouble location	31	27
Voltage readings	32	30
Moistureproofing and fungi- proofing	33	31
V. Supplementary data.		
Maintenance parts list for auto- matic transmitter XTR-442-C	34	37

LIST OF ILLUSTRATIONS

<i>Fig. No.</i>	<i>Title</i>	<i>Page</i>
1	Automatic transmitter for perforated tape, McElroy type XTR-442-C	VIII 2
2	Automatic transmitter for perforated tape, block diagram	2
3	Auto head and drive unit, auto head plate removed	3
4	Electronic unit	3
5	Keyboard perforator	5
6	Hand perforator	5
7	Relay terminals on electronic unit	8
8	Monitoring jack and tone terminals	8
9	Auto head, showing tape insertion	9
10	Wheatstone code perforated tape	11
11	Auto head, front view	12
12	Auto head, rear view	15
13	Auto head and drive unit, cover removed	16
14	Oiling points within the auto head	19
15	Keying relay	21
16	Removing flat from friction-drive disk	27
17	Auto head and drive unit, showing first step in disassembly	32
18	Auto head and drive unit prepared for moistureproofing and fungiproofing, rear view	33
19	Auto head and drive unit prepared for moistureproofing and fungiproofing, top view	34
20	Resistor color code	43
21	Capacitor color code	44
22	Underchassis view of electronic unit	46
23	Automatic transmitter for perforated tape, schematic diagram	47

DESTRUCTION NOTICE

WHY — To prevent the enemy from using or salvaging this equipment for his benefit.

WHEN — When ordered by your commander.

HOW — 1. Smash — Use sledges, axes, handaxes, pickaxes, hammers, crowbars, heavy tools.
2. Cut — Use axes, handaxes, machetes.
3. Burn — Use gasoline, kerosene, oil, flame throwers, incendiary grenades.
4. Explosives — Use firearms, grenades, TNT.
5. Disposal — Bury in slit trenches, fox holes, other holes. Throw in streams. Scatter.

USE ANYTHING IMMEDIATELY AVAILABLE FOR DESTRUCTION OF THIS EQUIPMENT.

WHAT — 1. Smash — All controls, tubes, and castings (especially the keying head casting), the motor, and gears.
2. Cut — All cables, wires, and belts.
3. Burn — Technical manuals; tear out circuit diagrams and burn; then the pictures; and last the text.
4. Bend — All cabinets and chassis.
5. Bury or scatter — Any or all of the above after breaking.

DESTROY EVERYTHING

WARNING

HIGH VOLTAGE

**is used in the operation
of this equipment.**

DEATH OR INJURY ON CONTACT

**may result if operating personnel
fail to observe safety precautions.**

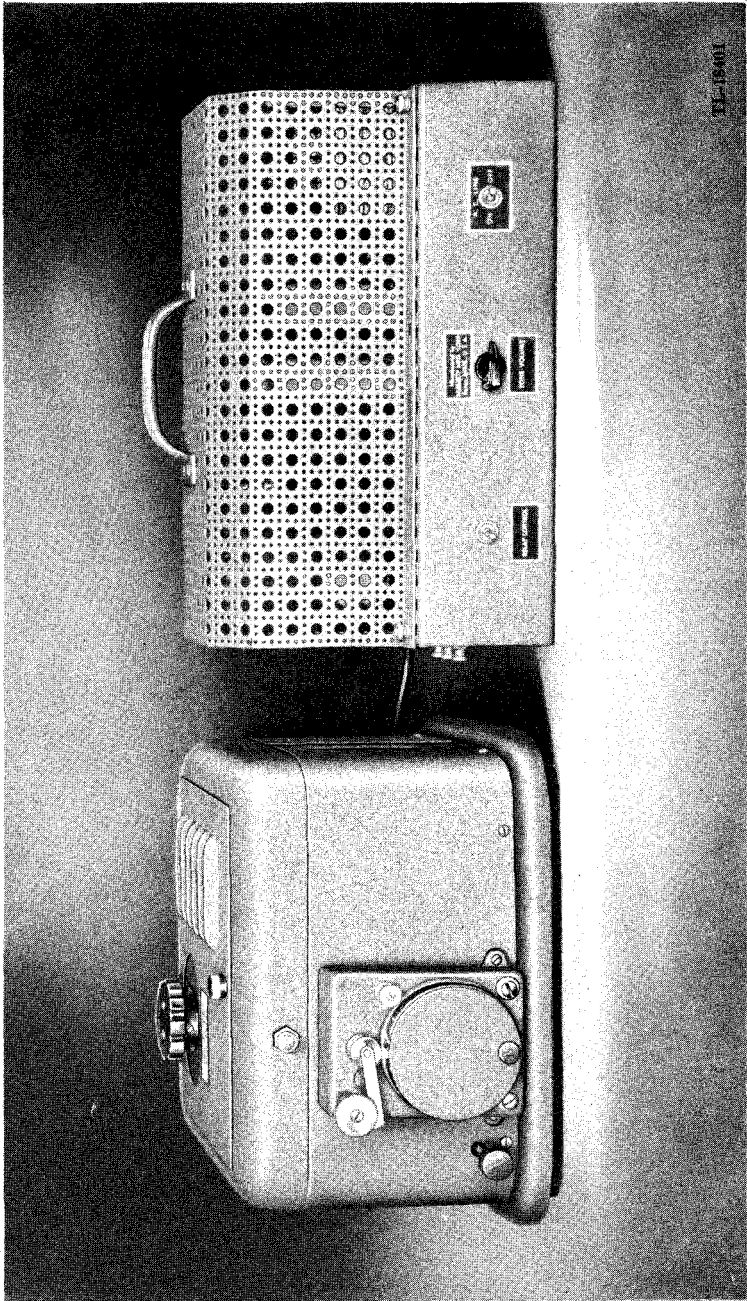

Figure 1. Automatic transmitter for perforated tape, McElroy type XTR-442-C.

SECTION I

DESCRIPTION

1. GENERAL.

The automatic transmitter for perforated tape (Wheatstone), McElroy type XTR-442-C (fig. 1) is an electro-mechanical device using Wheatstone perforated tape to produce International Morse characters at continuously variable speeds from 10 to 100 words per minute. Two types of output are available: terminal output of an electronically operated relay; a keyed a-f (audio-frequency) tone. A block diagram of the equipment is shown in figure 2.

2. TYPES OF OPERATION.

a. Operation of a Radiotelegraph Station by Use of Relay Contained in Automatic Transmitter XTR-442-C. This equipment is terminated in a relay whose contacts pass keying bias voltage or similar voltage for control of a radiotelegraph transmitter.

b. Operation of Remote Radiotelegraph Stations by Carrier Telegraphy. Several automatic transmitters can be used with appropriate carrier equipment for the control of radiotelegraph transmitters at a remote location.

c. Operation of a Polarized Relay. The auto head, through which the perforated tape passes, operates any standard polarized relay without the use of the electronic unit.

3. COMPONENTS.

The automatic transmitter for perforated tape, McElroy type XTR-442-C, consists of the following major units: the auto head and drive unit (fig. 3), the electronic unit (fig. 4), and spare parts.

a. Auto Head and Drive Unit. The auto head and drive unit is a mechanical device which keys electrical impulses in response to the perforations in a Wheatstone tape. An electric motor, coupled through a friction drive variable speed mechanism, furnishes power for operation of the auto head. The unit is housed in a metal case.

b. Electronic Unit. The electronic unit operates with the auto head and drive unit to produce tone modulated signals or to operate a

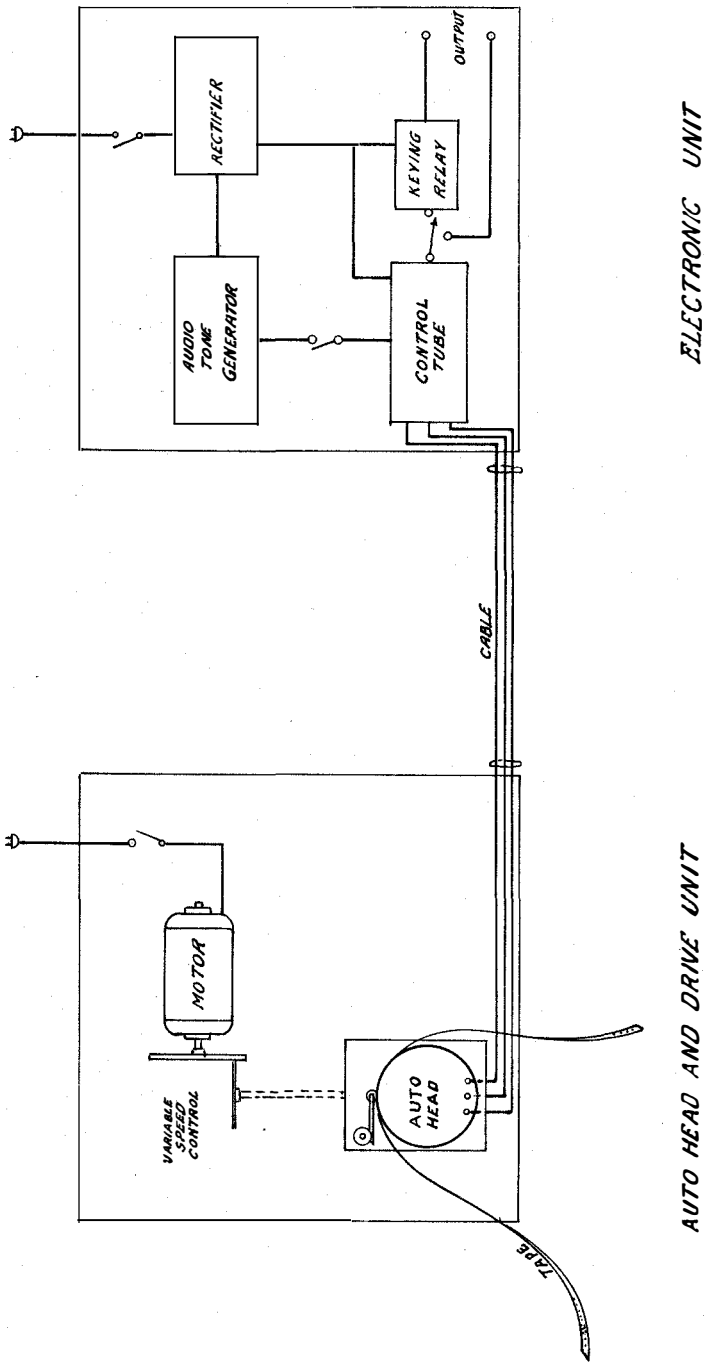

ELECTRONIC UNIT

AUTO HEAD AND DRIVE UNIT

Figure 2. Automatic transmitter for perforated tape, block diagram.

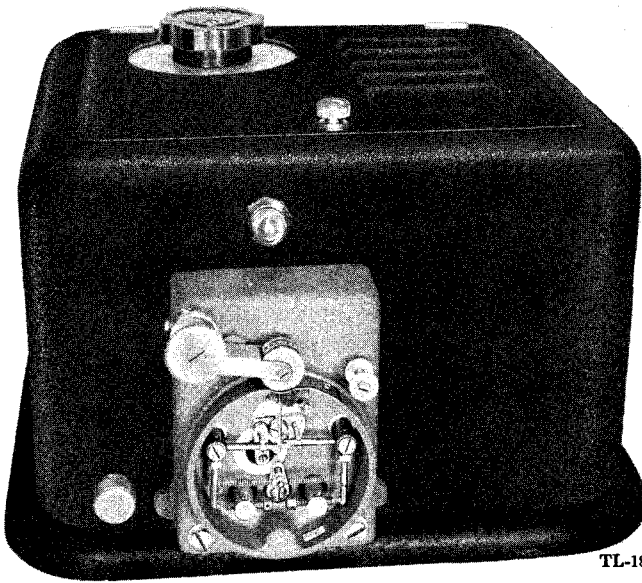

TL-18402

Figure 3. Auto head and drive unit, auto head plate removed.

keying relay; either of which may be used to key a radiotelegraph transmitter. Three tubes are used. One keys the signals in response to the action of the auto head, the second modulates the first at an audio rate to produce a tone source for keying a transmitter or monitoring transmissions, and the third is a rectifier which furnishes d-c voltage for the unit. The unit is mounted on a chassis and shielded by a perforated metal cover.



TL-18403

Figure 4. Electronic unit.

c. Spare Parts.

Name of part and description	Spares
Spring, sledge	1
Spring, selector pin	1
Selector pin	2
Rocker	1
Link, rocker, eccentric	1
Sleeve, insulating, Irvolute	2
Spring, contact	2
Screw, contact	2
Tool, contact adjusting	1
Relay, 2,000-ohm, SPST	1
Woven belt	2
Capacitor, electrolytic, 20-mf, 200-v. (working)	1
Resistor, 2,000-ohm, 1/2-watt	1
Resistor, 250-ohm, 10-watt	1
Resistor, 10,000-ohm, 1-watt	1
Resistor, 20,000-ohm, 1-watt	1
Resistor, 100,000-ohm, 1-watt	1
Resistor, 40-megohm, 1-watt	1
Resistor, 2,000-ohm, 10-watt	1
Resistor, 10,000-ohm, 10-watt	1
Potentiometer, 50,000-ohm, wire-wound	1
Toggle switch, SPST	2
Microswitch	1

4. TAPE REQUIRED FOR OPERATION.

The signal elements (dots and dashes) appear in the tape (fig. 10) as double perforations. A center line of small perforations runs through the tape. Each signal element will have one signal perforation above the center line and one below. Two types of perforators are in use for preparing tape for the automatic transmitter.

a. Keyboard Perforator. Figure 5 shows a typical keyboard perforator. This type is used in much the same way as a typewriter or teletype machine. When a key is depressed, the tape is perforated with the International Morse combination for that letter. A knowledge of the code is, therefore, unnecessary. A keyboard perforator is normally set up for use with the English language and alphabet, but may be used to perforate tapes with combinations assigned to the characters or letters found in other languages.

b. Hand Perforator. The hand perforator (fig. 6) can be used by anyone who knows the International Morse code. Since it has only three

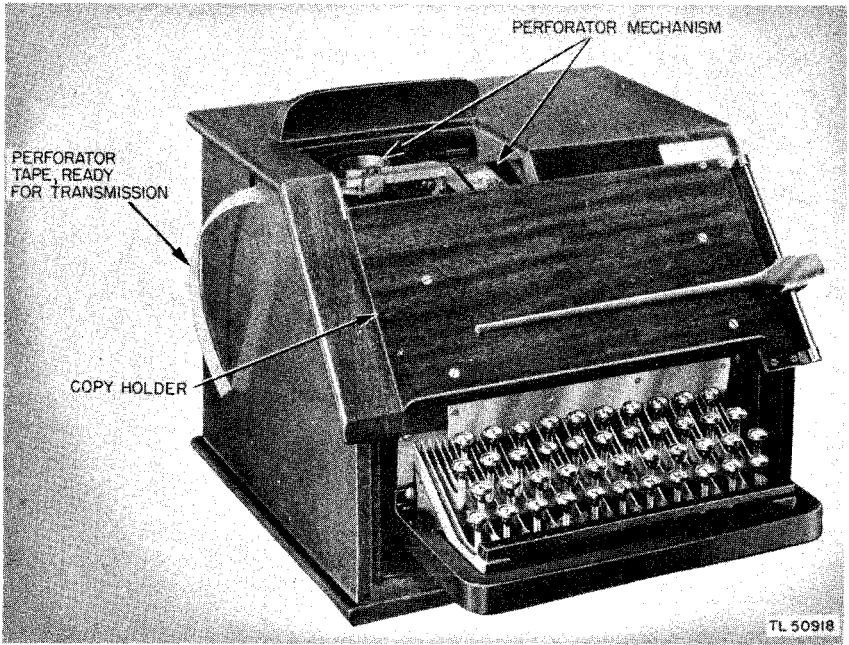

Figure 5. Keyboard perforator.

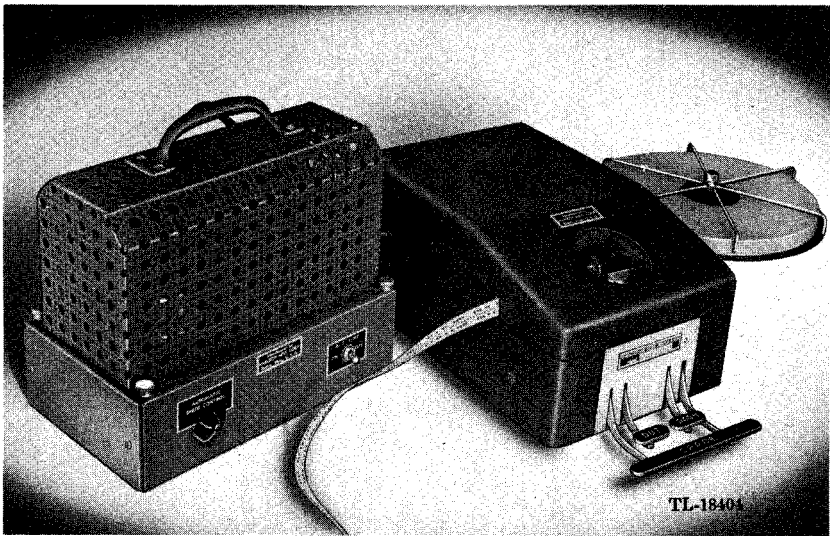

Figure 6. Hand perforator.

keys (labelled DOT, DASH, and SPACE), it is readily adapted to special coding. This device is not in general use.

5. POWER REQUIRED FOR OPERATION.

The automatic transmitter XTR-442-C operates on 115 volts, 50 or 60 cycle alternating current.

6. DIMENSIONS.

The over-all dimensions of the auto head and drive unit are as follows: height, $8\frac{1}{2}$ inches; width, 12 inches; length, $13\frac{3}{4}$ inches. The over-all dimensions of the electronic unit are as follows: height, 10 inches; width, $9\frac{1}{4}$ inches; length, 15 inches. These units are individually packed in boxes whose dimensions are: auto head and drive unit, $11\frac{3}{4}'' \times 12\frac{3}{4}'' \times 18\frac{3}{4}''$; electronic unit, $12\frac{3}{4}'' \times 15'' \times 18\frac{3}{4}''$. Packed for export or domestic shipping, the equipment is contained in a crate whose dimensions are: $20\frac{3}{4}'' \times 15'' \times 31\frac{1}{2}''$.

7. WEIGHT.

The auto head and drive unit weighs 30 pounds. The electronic unit weighs 14 pounds. When packed for shipment the gross weight is 141 pounds.

SECTION II

INSTALLATION AND OPERATION

8. UNPACKING.

Carefully unpack and inspect the automatic transmitter for evidence of possible damage during shipment. Check the various controls and switches for normal operation and make sure that all vacuum tubes are firmly seated in their sockets. If any control or switch binds, or if there is any apparent mechanical defect, the equipment should be thoroughly checked by maintenance personnel.

9. PREPARATION FOR USE.

a. General. The auto head and drive unit and the electronic unit should be installed in such a manner as to prevent interference to the operation of the equipment by vibration. The auto head should be rigidly mounted. Specific installation instructions will vary with the installation.

b. Connections and Interconnections. A heavy rubber-insulated two-wire cable, terminated at each end by shielded plugs, connects the auto head *on*, *center*, and *off* contacts to the electronic unit. The ground connection between the auto head and drive unit and the electronic unit is completed through the cable shielding. Each of the units is provided with a 6-foot line cord which must be plugged into a standard 115-volt outlet. A power switch is mounted on the front of each unit, so that the unit may be turned on and off as desired. Output connections are made to the following: Relay terminals Y and C (fig. 7), which are rated at 3 amperes, and may be used either in a control circuit directly, or connected to the keying relay of a transmitter (terminal X is a "back-contact" sometimes used in control circuits of bias keyed transmitters); tone terminals, (fig. 8), which match a 50-ohm line. Normal connections are made to the two binding posts. When a plug is inserted in the jack, the tone is disconnected from the binding posts. The control marked TONE CONTROL on the front of the electronic unit is actually a volume control which controls the level of tone to the output transformer. A switch marked RELAY CONTROL may be used to short out the relay winding when the tone output is used alone.

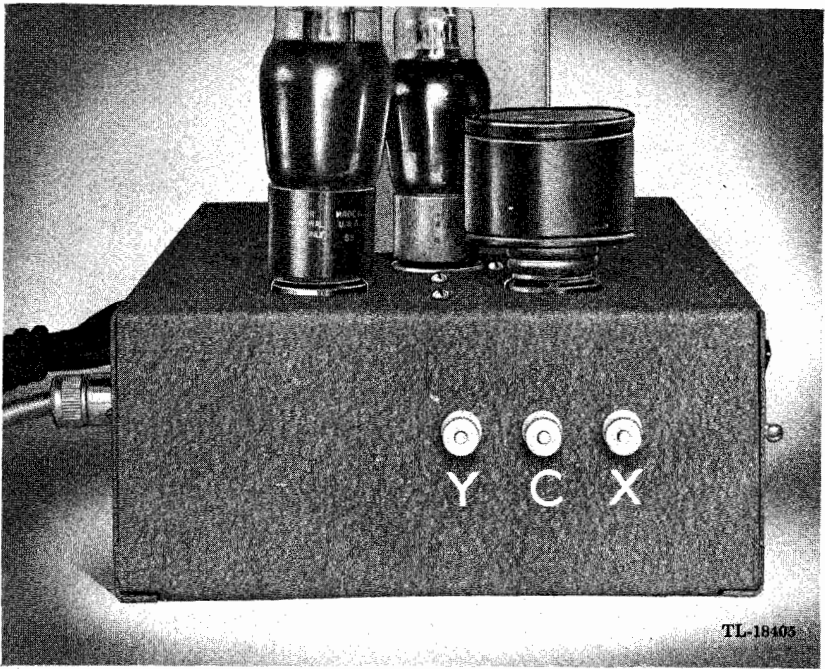

Figure 7. Relay terminals on electronic unit.

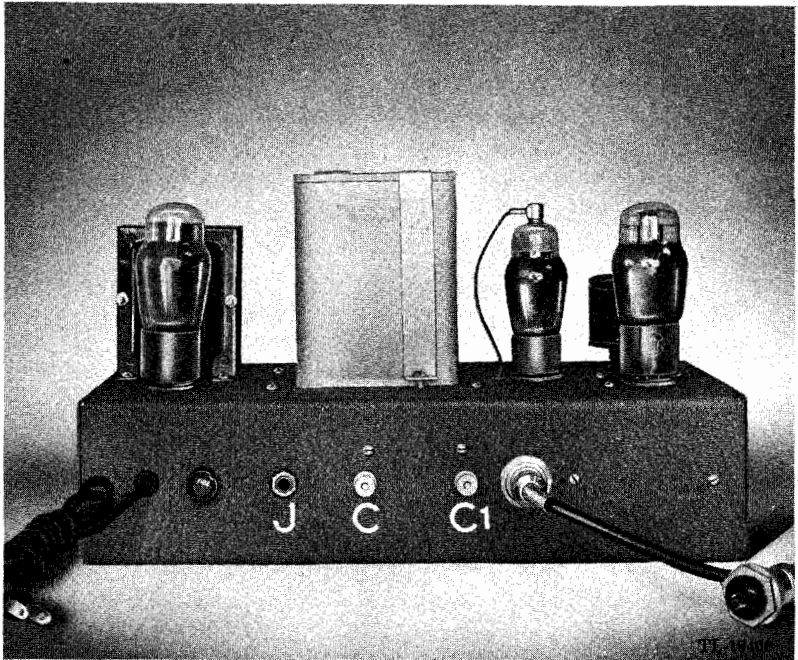
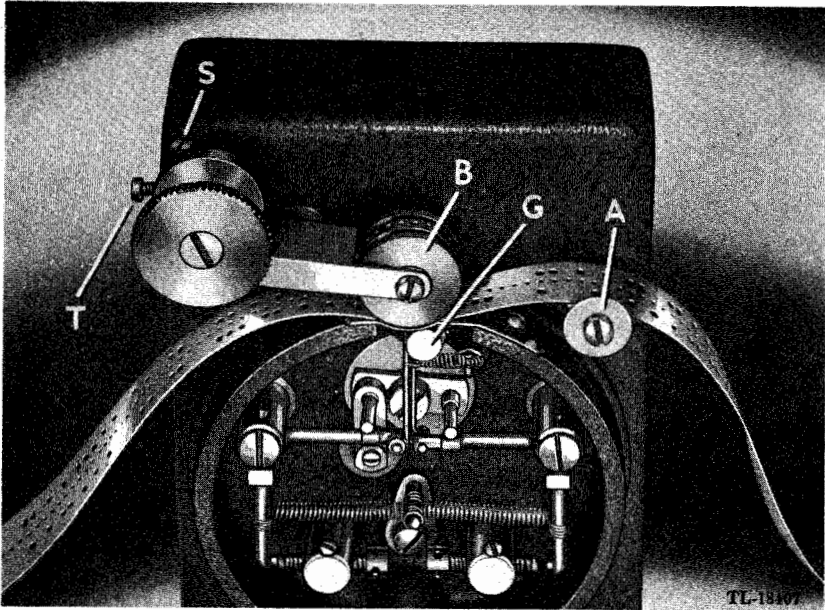

Figure 8. Monitoring jack and tone terminals.

c. Carrier Equipment Keying. Carrier equipment permits the use of a single pair of wires to carry a number of circuits. If a number of automatic transmitters are connected so that the keying relay of each keys a separate carrier circuit, an equal number of remote radiotelegraph transmitters can be keyed simultaneously over a single two-wire line. Care must be taken that the keying speed does not exceed the speed handling capability of the carrier circuits. For further information on carrier circuits and equipment refer to TM 11-486 Electrical Communication Systems Engineering, General Information; and TM 11-487 Electrical Communication Systems, Equipment.



A Tape guide
 B Tape feed roller
 G Tape feed spindle
 S Roller level adjustment
 T Level adjustment lock

Figure 9. Auto head, showing tape insertion.

10. OPERATION.

a. Placing Tape in Auto Head. The tape is placed in the auto head to feed from right to left (fig. 9). It must pass across tape guide A which keeps it in alignment with tape-feed roller B and tape-feed spindle G. The tape passes through the auto head face up, in the position in which it is read (fig. 10). The *start* perforations are in, with respect to the auto head. The *stop* perforations are out, with respect to the auto-head.

b. Lowering Tape-feed Roller. A knurled thumbscrew permits the tape-feed roller to be raised and lowered. The tape-feed roller must

be lowered on a blank area of the tape in advance of the section in which the signal combinations are punched. If the tape is lying within the tape guide, the points of the tape-feed spindle, which coincide with the index holes in the tape-feed roller, will quickly be aligned with the centerline holes in the tape.

c. Changing Speed. Transmission speed can be changed quickly by means of the speed control dial on the top of the unit. The motor turns at a constant speed; the transmission speed is dependent upon the ratio between the 6-inch drive pulley and the friction-drive disk.

d. Keying at Moderate and High Speeds. (1) When the unit is keying at moderate speeds, the tone and the relay may be used at the same time. Thus, a transmitter keyed at moderate speeds by the keying relay may be monitored simultaneously, if a loudspeaker is connected to the tone supply.

(2) When the relay in the electronic unit is used at high speeds, the tone must be shut off by turning the TONE CONTROL knob on the electronic unit (fig. 4) as far to the left as it will go. Disconnecting the loudspeaker from the tone terminals or withdrawing the plug from the jack is not enough, the TONE CONTROL knob must be set to pass the maximum power to the coil of the keying relay, completely bypassing the tone output transformer.

(3) When keying at high speeds with the tone developed in the electronic unit, the RELAY CONTROL switch can be thrown to OFF. This will stop the action of the relay and avoid unnecessary wear.

SECTION III

FUNCTIONING OF PARTS

11. INTRODUCTION (fig. 10).

a. The large holes in the Wheatstone perforated tape permit selector pins in the auto head to rise to the limit of their travel, which allows contacts mechanically coupled to these pins to close. The closing of these contacts controls the action of an electronic circuit which both operates a relay used to key a transmitter, and provides a keyed tone. The center line of smaller holes in the tape is engaged by teeth in a rotating shaft, which moves the tape through the auto head. The two selector pins are arranged to rise and fall alternately (180° apart). The perforations above the center line of small holes control the *start* of a signal element; the perforations below the center line of holes control the *stop* or end of a signal element.

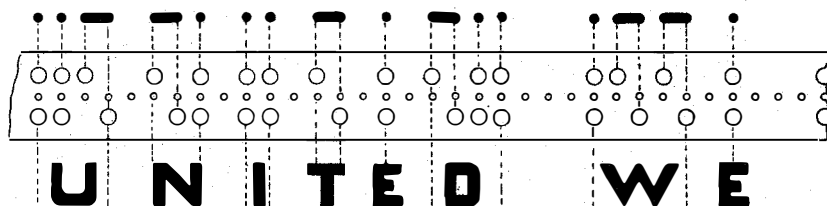

Figure 10. *Wheatstone code perforated tape.*

TL-18408

b. Transmission of signal elements (dot, dash, and space) is as follows:

(1) **DOT.** The *start* pin, at the peak of its upstroke, passes through a tape perforation, and the signal begins. As the tape continues on and the *stop* pin rises, a perforation has moved into position for it to pass through, and the signal is stopped.

(2) **DASH.** The *start* pin rises and passes through a perforation beginning a signal element. The *stop* pin rises, but there is no perforation for it to rise through and complete its stroke. The signal remains on. The *start* pin rises, but there is no perforation for it to pass through. The signal is still on. The *stop* pin rises again, this time passing through a perforation, completing its stroke, and the signal is stopped. A dash is three times as long as a dot.

(3) **SPACE BETWEEN LETTERS.** After the *stop* pin has risen

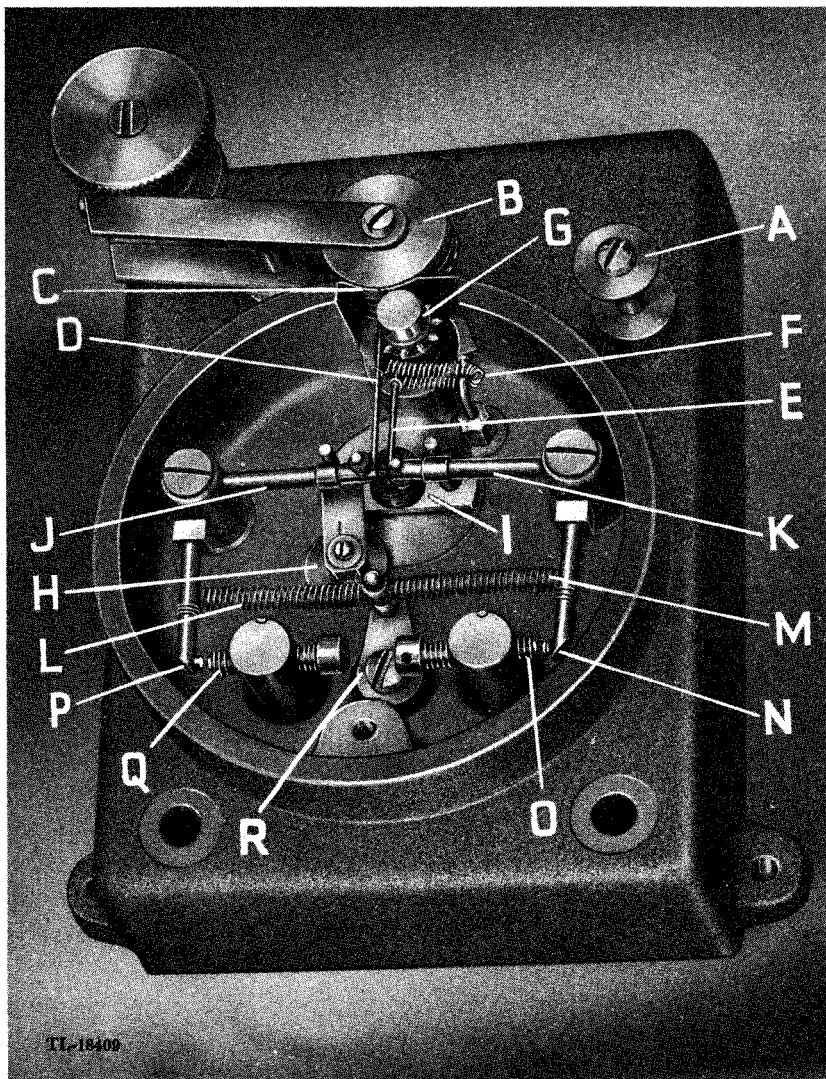

- | | | | |
|---|---------------------|---|--------------------|
| A | Tape guide | J | Elbow |
| B | Tape feed roller | K | Elbow |
| C | Slip plate | L | Contact spring |
| D | Selector pin | M | Contact spring |
| E | Selector pin | N | ON contact, arm |
| F | Selector pin spring | O | ON contact, fixed |
| G | Tape feed spindle | P | OFF contact, arm |
| H | Eccentric | Q | OFF contact, fixed |
| I | Rocker | R | Contact center |

Figure 11. Auto head, front view.

and ended a signal, the **start** pin rises, finds no perforation, and no signal is started. The **stop** pin rises and falls without affecting the circuit. The **start** pin rises again, passes through a perforation, and a new signal is started. During this time a space has been executed equivalent in duration to a dash. This is the amount of spacing separating one letter from the next. This spacing between letters is provided by one center-line hole with no perforation above or below it.

(4) **SPACE BETWEEN WORDS.** Normally, spacing between words and groups is equal to seven dots. When the **stop** pin has ended a word, the **start** pin rises, finds no perforation; then the **stop** pin rises and finds no perforation. A second time the **start** pin rises and finds no perforation; the **stop** pin rises and finds no perforation. A third time the **start** pin rises and finds no perforation; the **stop** pin also rises and finds no perforation. At its fourth rise, the **start** pin passes through a perforation, and starts the signal of the next word. As illustrated in figure 10, this spacing between words is provided by three center-line holes with no perforations above or below them.

12. AUTO HEAD (fig. 11).

a. The tape-feed roller has index holes which coincide with the pins in the tape-feed spindle. The tape-feed spindle pins rotate the tape-feed roller. The tape runs under the tape-feed roller and between the roller and slip plate. The spindle pins pass through the center-line perforations, carrying the tape along, and engage the index holes in the feed roller, rotating the feed roller.

b. Selector pins D and E are held in a vertical position by the tension of selector pin spring F. They are drawn up against the tape-feed spindle G. Where the pins rest against the tape-feed spindle, grooves are cut in the spindle shaft. The grooves accommodate the selector pins, and because one groove is deeper than the other, one pin is advanced relative to the other.

c. The tape-feed spindle G and eccentric H, which is linked to the rocker I, are geared together; therefore they function synchronously. Elbows J and K, to which the selector pins are attached, rest against the posts of the rocker I and are held in place by the tension of contact springs L and M.

d. The rocker posts position the selector pin elbows. The selector pins rise and fall in opposition to each other (180° out-of-phase). If the selector pins push against an unperforated part of the tape when approaching the peak of their upstroke, they will not complete the upstroke.

e. The eccentric to which the rocker is linked, is synchronized with the tape-feed spindle so that the signal perforations as they appear

in the tape will exactly coincide with the peak of the upstroke of the selector pins. Each selector pin makes a complete upstroke when a perforation appears, giving the pin clearance to pass through and climax its upstroke. Thus when each pin rises and a perforation in the tape is in line with it, the pin goes through; and there is an instantaneous contact between the selector arm contact and the stationary contact associated with it.

f. When each selector pin rises and meets a blank unperforated area of the tape, the pin cannot reach the peak of its stroke, and there is no meeting between the pin arm contact and the stationary contact associated with it. In order to make a complete signal element (dot or dash) both selector pins must function. The pin coupled to right-hand elbow K starts the signal by permitting arm contact N to meet stationary contact O associated with it. The pin coupled to left-hand elbow J stops the signal by permitting arm contact P to meet stationary contact Q associated with it.

g. When the pins complete two strokes, first one pin, then the other, a dot is executed. When the transmitter is functioning without tape, both pins are free to complete their strokes. Thus, the transmitter keys a continuous series of dots.

h. The auto head contacts are wired to a shielded socket, and connected to the electronic unit by means of a shielded two-wire cable. The third terminal of the auto head is coupled to the electronic unit through the shielding. Three auxiliary terminals on the auto head and drive unit, insulated from the case, connect directly to the *on*, *center*, and *off* terminals of the auto head. This permits connection to any mechanically polarized relay, such as the Western Electric polarized relay 209-FA, or the Creed British Post Office type.

13. SPEED MECHANISM.

The auto head is coupled to the driving motor by a combination gear and friction-drive arrangement (figs. 12 and 13). The auto head is terminated in a gear shaft, which is driven by a large gear on the friction-drive shaft. Friction-drive disk B has a leather-covered rim which bears against the face of 6-inch drive pulley A. The drive pulley is belt-driven at a constant speed by 1/20-hp induction motor E. Speed control rack C and pinion D are used to change the position of the friction-drive disk rim on the face of the 6-inch drive pulley. The shaft of the pinion extends to the top of the cover of the unit, and bears a dial scaled in words per minute. The switch that turns the motor on and off is a microswitch operated by a lever which also withdraws the face of the drive pulley from the rim of the friction-drive disk.

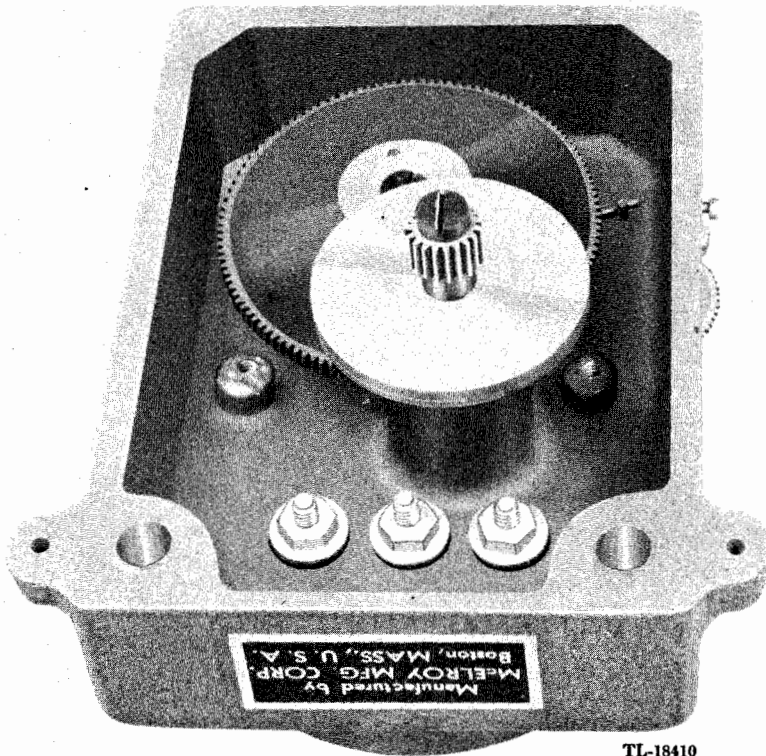

Figure 12. Auto head, rear view.

14. CONTROL TUBE (fig. 22).

a. Tube JAN-6V6 (V-2) and its associated circuit components act as an electronic switch to transfer the mechanical action of the auto head into dots and dashes. Terminal 2 of connector SO-2 may be considered as the arm of a single-pole, double-throw (SPDT) switch which makes contact with terminals 3 and 1 of SO-2. When 2 is closed to 3, a **start** condition is set up. When 2 is closed to 1, a **stop** condition is established.

b. This action serves to change the potential across capacitor C-11 which maintains grid bias for control tube V-2 at the value set by the **start** or **stop** condition until the next closed circuit condition of the switching circuit. Resistor R-12 is the grid resistor for tube V-2. Resistor R-10 is the cathode bias resistor. Capacitor C-10 is the cathode bypass capacitor for V-2. Resistor R-5 is the screen grid current limiting resistor. Resistors R-9, R-11, and R-13 are voltage divider resistors which provide voltages above ground for the elements of V-2. Note that resistor R-10 is not grounded, but is above ground by

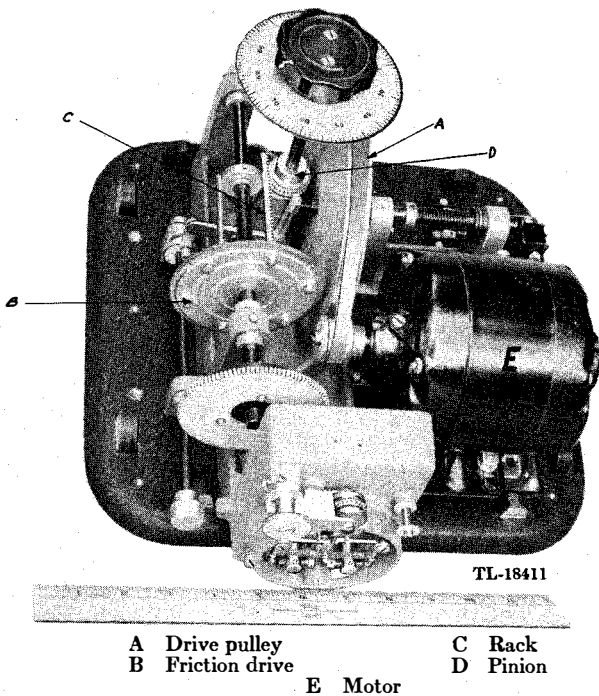

Figure 13. Auto head and drive unit, cover removed.

the voltage drop across resistors R-11 and R-13. Similarly the bias for the suppressor grid of V-2 is held above ground by the voltage drop across resistor R-13. Resistor R-8 is a load resistor for the suppressor grid circuit.

c. Capacitor C-4 couples audio voltage from the tone generator circuit which modulates the plate current of V-2. Modulated plate current for V-2 flows through the primary of transformer T-1 and produces an audio tone in the secondary, appearing across the contacts of J-1, or the output terminals. The winding of relay K-1, in series with T-1, is operated when plate current flows. Capacitor C-1 bypasses the primary winding of T-1; C-2 bypasses relay K-1. Resistor R-1, marked TONE CONTROL is actually a volume control; it is a shunt resistance across T-1. As the resistance is reduced, a larger proportion of the plate current to V-2 flows through R-1 than through T-1. In the extreme position, R-1 short circuits the primary of T-1. In the closed position, Switch S-1 shorts out the winding of Relay K-1.

15. TONE GENERATOR (fig. 22).

Tube JAN-89Y (V-1) and its associated components generates an audio-frequency tone used to modulate the plate current of control

tube V-2. The cathode, control grid, and screen grid act as a triode Hartley oscillator. The output is electron-coupled to the plate, and to the load (V-2). Resistor R-6 sets the grid bias. Inductance L-2 sets the operating frequency. Resistor R-7 is used to stabilize the frequency of the oscillator. Capacitor C-8 is a blocking capacitor to keep the high voltage off the control grid. Capacitor C-9 is a bypass capacitor to the cathode of tube V-1 through ground. Resistor R-2 is a current-limiting resistor in the supply to the screen grid. Capacitor C-3 is used for frequency stabilization. Resistor R-4 is a current-limiting resistor in series with the plate of V-1; C-5 is a coupling filter capacitor. R-3 is the plate load resistor.

16. POWER SUPPLY (fig. 22).

Tube JAN-80 (V-3) is a full-wave rectifier used to supply operating voltage to tubes V-1 and V-2. Transformer T-2 provides filament voltage to all tubes and high voltage alternating current to rectifier tube V-3. Inductance L-1 and capacitors C-6 and C-7 filter the rectified current and deliver smooth d-c voltage to the circuits of tubes V-1 and V-2. Fuse F-1 protects the equipment in the event of high-current drain on transformer T-2. Switch S-2 is the control switch for the electronic unit.

SECTION IV

MAINTENANCE

NOTE: Failure or unsatisfactory performance of equipment used by Army Ground Forces and Army Service Forces will be reported on W.D., A.G.O. Form No. 468 (Unsatisfactory Equipment Report). If Form No. 468 is not available, see TM 38-250. Failure or unsatisfactory performance of equipment used by Army Air Forces will be reported on Army Air Forces Form No. 54 (unsatisfactory report).

17. INSPECTION.

a. General. This equipment should be inspected at frequent intervals for indications of electrical or mechanical failure.

b. Detailed. (1) **ELECTRICAL.** (a) Inspect the relay contacts for pitting, or evidence of sparking. Check the adjustments of the relay contacts for proper spacing as outlined in paragraph 19.

(b) Inspect rectifier tube V-3 for evidence of gas while the equipment is in operation. A blue glow appearing within the tube indicates the presence of gas which impairs the normal operation of the tube and makes replacement necessary.

(c) Inspect the under side on the electronic unit for evidence of overheated parts or poorly soldered joints. Discoloration of resistors or wax dripping from a tubular capacitor gives evidence of overheating. (2) **MECHANICAL.** (a) Inspect the tubes to make sure that they are properly seated in their sockets. Check the seating of the relay at the same time.

(b) Inspect switches for positive operation and firmness of the locking nut. Tighten if necessary. Inspect knobs and dials to make sure that they are not slipping on their shafts.

(c) Thoroughly clean all components, especially the auto head, which is prone to collect dust and paper lint.

18. LUBRICATION (fig. 14).

a. General. For the proper functioning of automatic transmitter XTR-442-C, it is necessary that lubrication be performed at stated

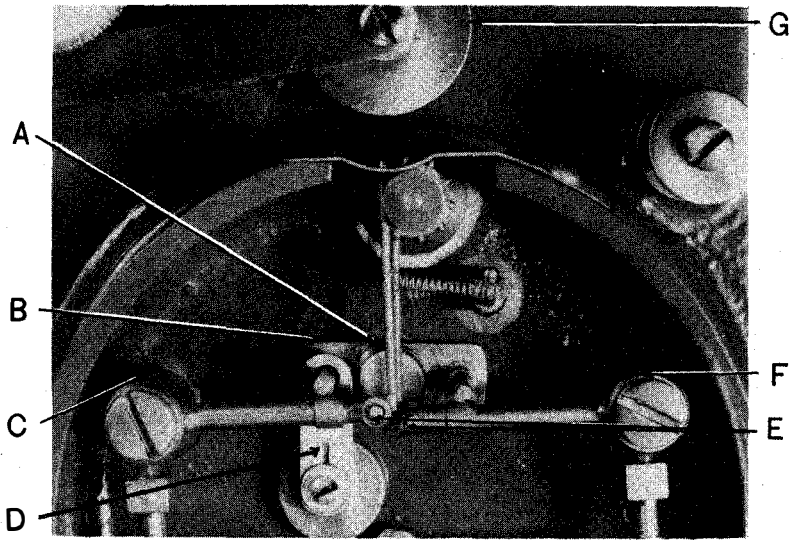

- A Oil hole in rocker bearing
 B Oil hole in top of link
 C Oil hole in selector pin elbow
 D Oil slot in link
 E Oil selector pin bearings
 F Oil hole in selector pin elbows
 G Oil hole in perimeter of groove, tape feed roller

Figure 14. Oiling points within the auto head.

intervals. All lubrication operations apply to the auto head and drive unit only; the electronic unit does not require lubrication.

b. Chart of Lubricants Used.

Product symbol	Nomenclature	Specification No.	Grade	Container size	Issuing service	ASF Supply Catalog No.
OE 30	Oil, Engine	U.S. Army 2-104B (Amend. 2)	SAE 30	1-qt can	QMC Ord Dept	14-0-2154-10 14-0-2184-990
GL	Grease, Lubricating, Special	Ordnance AXS-637	One grade only	8-oz tube	Ord Dept	14-G-196-400
GG	Grease, Graphited	Ordnance AXS-683	One grade only	1-lb can	Ord Dept	14-G938-16
WB2	Grease, General purpose	U.S. Army 2-108 (Amend. 2)	No. 2	1-lb can	QMC	14-G-1230-1
SD	Solvent, Dry-cleaning	Federal P-S-661a (Amend. 1)	One grade only	1-gal screw top can	QMC	51-S-4385-1

c. Points Requiring Lubrication. (1) Every 64 hours of operation lubricate with one drop of Engine Oil (OE 30) at:

- (a) Oil holes located on motor.
- (b) Oil holes located in drive.
- (c) Oiling points shown in figure 14.

(2) The drive shaft as illustrated on figure 14 is lightly lubricated with special lubricating grease (GL) or graphited grease (GG). **Do not oil** the speed control rack and pinion. A compression washer of special composition, included in the speed control assembly, will be damaged by oil or grease. **Do not oil** the speed control shaft which serves as the shaft for the friction disk. If oil accumulates on the shaft, the oil will be thrown on the face of the 6-inch drive pulley. The face of the pulley must be kept clean and dry so that coupling by friction will be maintained between the face of the pulley and the rim of the friction disk.

(3) Annually disassemble, clean, lubricate, and reassemble as follows:

- (a) Disconnect motor power source.
- (b) Remove belt drive by loosening the four tap screws in motor base and sliding motor toward large pulley.
- (c) Pull off motor shaft pulley after loosening Allen setscrew.
- (d) Remove four bolts securing the end bells to the stator.
- (e) Insert screwdriver in notch and pry off front end bell.
- (f) Remove stationary part of centrifugal starting switch from end bell. Switch is secured by machine screws.
- (g) Slide rotor off stator.
- (h) Pry off rear end bell.
- (i) Remove all old grease from bearing and end bell.
- (j) Pack the ball bearings with general purpose grease (WB2) by working the grease into the space between the balls and the inner and outer races.
- (k) Reassemble the motor by performing the steps above in reverse order.
- (l) Connect motor to power and check operation.
- (m) Replace drive belt and adjust belt tension by sliding motor and tightening the four cap screws.

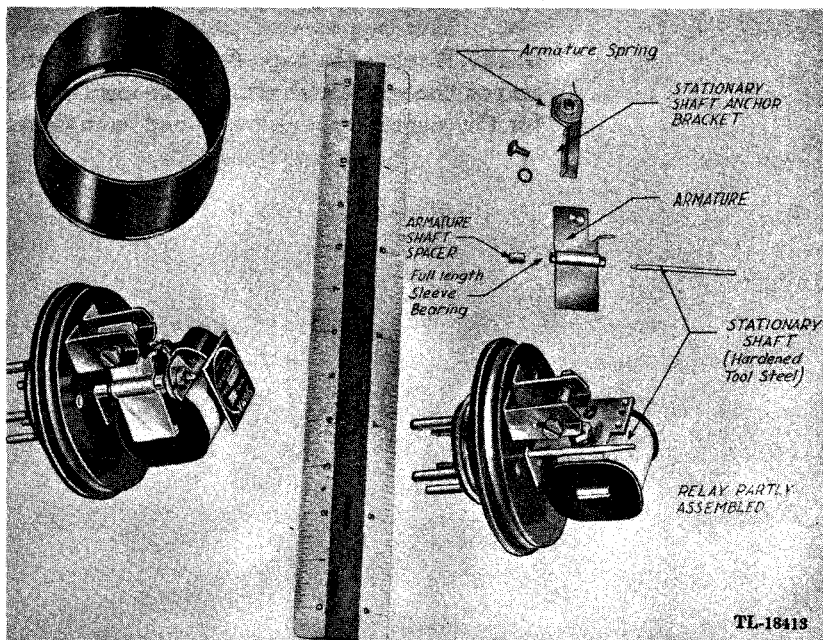

Figure 15. Keying relay.

19. ADJUSTING KEYING RELAY (fig. 15).

When the keying relay is adjusted, a loudspeaker or headset must be connected to the relay contact terminals in series with the output of an oscillator. Adjustments are as follows:

- a. Press the relay contact arm to the *on* position.
- b. Turn the contact screw until the clearance between the contact arm and the armature is 0.005 inch.
- c. Adjust the *off* contact until the center arm has 1/16 inch movement.
- d. Turn the relay spring screw until the arm contact swings over and touches the *off* contact. Give the screw half a turn beyond that point.

20. SYNCHRONIZING SELECTOR PINS (fig. 11).

The rise and fall of the selector pins must be synchronized with the rotation of the tape feed spindle so that, when a perforation occurs in the tape, the hole will arrive at the proper interval to allow the selector pins to rise through it. The procedure for alignment is as follows:

- a. Remove the auto head.
- b. With a No. 8 Allen wrench, loosen the two setscrews in the hub of the large gear which drives the tape-feed spindle.

c. Place a piece of perforated tape in proper position in the auto head. Rotate the tape-feed spindle with a screwdriver set in the slotted end of the spindle shaft. Make certain that the tape is in proper position for the points on the tape-feed spindle to pass through the tape center-line holes and engage the index holes in the tape-feed roller.

d. Turn the tape-feed spindle shaft until a perforation in the tape is in position for one of the selector pins to rise through it. Hold the shaft in this position.

e. Turn the eccentric shaft until the pin is at the peak of its stroke. Tighten the setscrews in the hub of the large gear.

f. Feed a length of tape through the auto head by rotating the eccentric shaft, and watch both selector pins. See that they clear the holes in the tape properly as they rise and fall.

21. ADJUSTING AUTO HEAD CONTACTS (fig. 11).

When the auto head contacts are adjusted, a loudspeaker or headset must be connected to jack (J-1) or to the tone output terminals. Adjustment is as follows:

a. Loosen the setscrews which lock the contact screws in the contact posts.

b. While the auto head is being driven, back away the contact screws until they do not meet the contacts on the arms.

c. Turn the right-hand contact toward the contact arm until, at each revolution, the moving contact meets it. A long tone will be heard.

d. Turn the left-hand contact toward the arm contact until, at each revolution, the moving contact meets it. Each time the *on* contacts meet, the signal will go on until the meeting of the *off* contacts stops it.

e. Give each contact a quarter-turn closer adjustment before tightening the setscrews.

22. REPLACING SELECTOR PIN SPRING (fig. 11).

When the selector pin spring is being replaced, care must be taken not to bend the selector pins. The replacement of this spring is as follows:

a. Lift the spring off the hook which anchors it in place.

b. With a small screwdriver, disengage the selector pins from the grooves in the tape-feed spindle.

c. Press the *off* contact arm away from the stationary contact.

d. Slip the spring off the stem bearing on the selector pin elbow.

- e. Remove the *on* selector pin.
- f. Slip the spring off the ends of the selector pins.
- g. Place the new spring on the pins before returning them to their bearings.
- h. With the pins in place on their bearings, press the selector pins back in the grooves in the tape-feed spindle.
- i. Loop the spring over the hook. Adjust the spring on the pins so that, when on the hook, the spring will be in the correct horizontal position.

23. REPLACING SELECTOR PINS.

To replace selector pins, follow the steps outlined in paragraph 22 above.

24. REPLACING CONTACT SPRINGS (fig. 11).

It is necessary to remove the selector pin elbows and disassemble the contact arm to replace a contact spring. The procedure is as follows:

- a. Remove the selector pin spring and selector pins as outlined in paragraph 22 above.
- b. Remove the selector pin elbows by unscrewing the bearing screws.
- c. Loosen screws in the contact arm blocks and pull the contact arms off the stems on the elbows.
- d. Slip the springs off the contact arms.
- e. Replace spring, and reassemble.
- f. Use an ohmmeter to make sure that the contact arm is insulated from the elbow.
- g. Before tightening the contact arm block setscrew, turn the contact arm until the face of the contact point is in line with the elbow bearing. This will insure that the faces of the stationary and arm contacts meet exactly when the elbows are replaced.

25. ADJUSTING SLIP PLATE.

The hole in the slip plate through which the holding screw passes is enlarged to allow adjustment of the slip plate to the roller. When replacing a slip plate, the roller must be lowered before the holding screw is tightened. With slip plate in place and the roller lowered, hold the auto head so that the spacing between the roller and slip plate can be seen. The arc of the roller must be concentric with the curve of the slip plate.

26. ADJUSTING TAPE-FEED ROLLER (fig. 9).

Tape-feed roller B must be adjusted properly to prevent unnecessary wear on the tape. Use the following procedure:

- a. Loosen tape-feed roller adjusting lock screw T and back out tape-feed roller adjusting screw S three or four full turns.
- b. Loosen the tape slip screw and permit the roller to seat itself on slip plate C (fig. 11).
- c. Screw the slip plate down so that it rests firmly against the left-hand edge of the case and tape-feed spindle G. (If necessary, the tape slip can be bent *slightly* to obtain the required fit.)
- d. Check the seating of the slip roller in the tape slip and, if necessary, tilt the roller so that it seats itself exactly in the tape slip. The roller can be tilted by using a pair of long nose pliers to bend the sledge upon which it is mounted.
- e. Check for proper alignment of the roller center holes with the teeth in the tape-feed spindle. If necessary, bend the sledge in or out to bring the roller holes exactly over the tape-feed spindle teeth. The roller should rotate freely on its spindle.
- f. Turn tape-feed roller adjusting screw S until the roller is lifted off the tape a distance equal to twice the thickness of the tape.
- g. Tighten tape-feed roller lockscrew T.

27. REPLACING INSULATING SLEEVES (fig. 11).

The Irvolute insulating sleeves are replaced by the following procedure:

- a. Follow the procedure outlined in paragraphs 24 a, b, and c.
- b. Strip the Irvolute sleeves off the elbow pins and slip on the new ones.
- c. Slide the contact sleeves on over the Irvolute insulation.
- d. Reassemble the components by reversing the steps followed during disassembly.
- e. Check insulation to the casting with an ohmmeter.

28. REPLACING ROCKER (fig. 11).

To replace the rocker, first follow the procedure outlined in paragraph 22 above. Then follow the procedure below:

- a. Remove the eccentric screw and washer.
- b. Slip the eccentric rocker link off the eccentric shoulder.

c. Take out the rocker shoulder screw and remove rocker I and the link (fig. 11).

d. Hold the new rocker so that its oiling hole is at the top. Slip the link on over the left-hand rocker arm pin. The oiling slot in the link must face outwards.

e. Replace the rocker and link and screw in the shoulder screw.

f. Slip the link on the eccentric shoulder and replace the eccentric screw and washer.

g. Reassemble the selector pins by reversing the steps used in removing them.

29. REPLACING SHOULDER WASHERS (fig. 11).

Follow the instructions outlined below:

a. Remove the auto head from the chassis.

b. Take out the four screws and slide the back cover off over the flexible coupling.

c. Remove the front cover.

d. Loosen both contact post setscrews and back out both contacts two or three full turns.

e. Remove the rubber-covered cable by taking off the three locknuts holding it in place.

CAUTION: Make sure that the three cable wires are correctly replaced by allowing them to retain their original bend.

f. Remove the contact posts and contact spring center by taking off the three hexagonal nuts.

g. Replace the waxed shoulder washers.

h. Replace the contact posts and contact spring holder. Tighten the three hexagonal nuts.

i. Replace the three wire cables. Tighten the three locknuts.

j. Replace the back.

k. Readjust the contacts as outlined in paragraph 21.

30. MECHANICAL TROUBLE LOCATION.

a. **General.** No matter how well equipment is designed and manufactured, faults occur in service, and the repairman must locate and

correct them as rapidly as possible. This paragraph and the following one contain information designed to aid those engaged in trouble shooting. (Remember, however, that preventive maintenance will minimize the necessity of trouble shooting.) Since it is not possible to foresee every fault that may occur in equipment, trouble location depends to a large extent on the common sense and analytic ability of the repairman. Proceed in a logical sequence, using the senses of sight, smell, and hearing in addition to regular test equipment.

b. No Signal at High Speed. (1) The auto head or the relay may be out of adjustment so that, at low speeds (10 to 50 words per minute), the keying is satisfactory, but, at higher speeds, the unit fails to key.

(2) To correct this trouble, adjust the auto head as directed in paragraph 21. Clean the contacts and contact arms with Solvent, Dry Cleaning Federal Spec. P-S-661a (SD). Wash the contact arms as well as the contacts, starting below the bearings. Oil from the bearings running down the contact arms to the contacts is a source of trouble. Care should be taken not to wash the oil out of the bearing. Adjustment of the keying relay is detailed in paragraph 19.

c. Continuous Signal or Irregular Dashes. (1) The auto head may be out of adjustment so that the *off* contacts are not meeting properly, or the relay armature may be out of adjustment allowing the *on* contact to be in continuous contact with the armature.

(2) To correct this trouble, adjust the relay as detailed in paragraph 19 or adjust the auto head as directed in paragraph 21.

d. Series of Dots but No Signal When Tape is Fed. (1) If the tape-feed spindle is not synchronized with the selector pins, the pins will not pass through the signal holes in the tape. To synchronize this action, proceed as directed in paragraph 20.

(2) If the tape-feed roller arm is bent, the selector pins will not pass into the grooves in the perimeter of the roller. In straightening this arm, use care to prevent scarring the roller or arm.

e. Tape Chewed Up by Spindle or Selector Pins. (1) If the index holes in the tape-feed roller do not meet the points of the tape-feed spindle, the center line holes in the tape will be chewed up. If the head accumulates dust or paper lint, the drag on the moving parts may force the selector pins through the paper.

(2) To correct the spindle alignment, loosen adjusting lock screw, T shown in figure 9. Turn *in* on adjusting screw T with the tape-feed roller lowered to the slip place until the roller rises slightly. Tighten the lock screw. To correct damage caused by the selector pins, disassemble the head, clean thoroughly with an approved cleaning solvent, lubricate as described in paragraph 18, and reassemble.

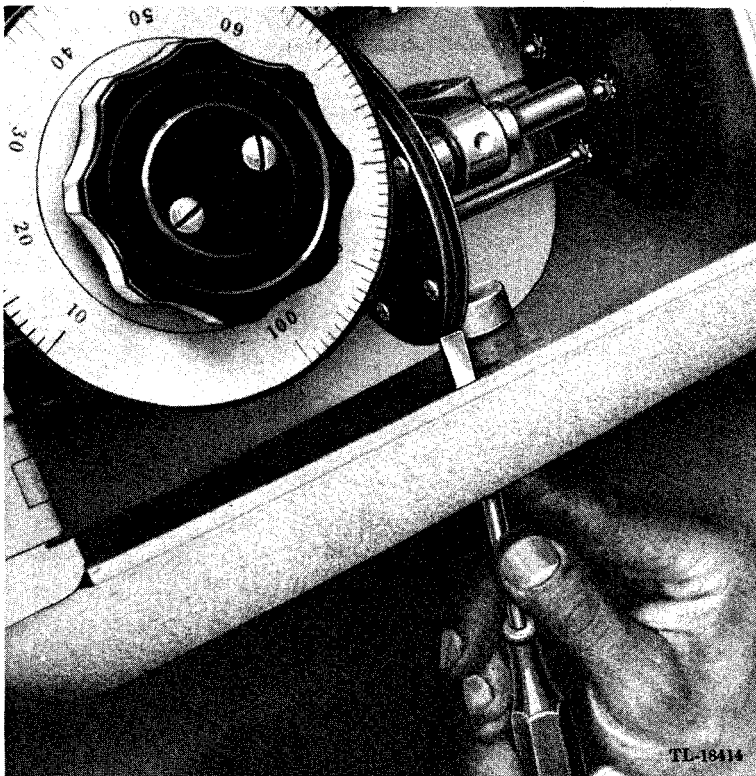

Figure 16. Removing flat from friction-drive disk.

f. Flat on Friction-Drive Disk. (1) If the auto-head bearings freeze, the friction-drive disk will be stopped. This will wear a flat on the disk. The flat, bumping on the face of the pulley, will cause considerable vibration.

(2) To remove the flat, proceed as follows:

(a) Set the disk at the high-speed position and turn on the motor.

(b) Hold a sharpened screwdriver as shown in figure 16 so that the blade of the screwdriver acts as a cutting tool, and carefully shave off the flat. Use caution when performing this operation. Too deep a cut will affect the calibration of the unit.

31. ELECTRICAL TROUBLE LOCATION.

a. The material contained in this section is intended as an aid in maintenance. Use it to help speed the location of faults. Consult the following trouble-shooting aids:

- (1) Block diagram of set (fig. 2).
- (2) Schematic diagram (fig. 22).

- (3) Voltage chart (par. 32).
- (4) Illustrations of components.

b. When failure is encountered, check over these simple points before initiating detail examination, such as: Is the unit connected to a source of primary power? Is the primary fuse F-1 intact? Is the power switch S-2 in the "on" position? If the answer to these questions is "yes" then consult the trouble chart that follows. If none of the points outlined in this chart correspond with the trouble encountered, then a detailed examination of the equipment is in order. The first step should be to check the tubes. The most general cause of improper operation of electronic equipment is tube failure. A complete set of *tested* tubes of the same type specified should be kept on hand at all times. Keep all spare parts for this equipment dry, clean, and ready for use at any time.

c. Trouble encountered in electronic equipment should be isolated by means of various tests and measurements, and the section determined in which the trouble is located. When this is done, the components of the associated circuit should be checked and the trouble located. A great aid to trouble shooting is the voltage and current chart showing normal readings; this table should be used with the following trouble chart.

NOTE: All resistance tests are made with the power off.

TROUBLE CHART FOR ELECTRONIC UNIT

<i>Symptom</i>	<i>Cause</i>	<i>Remedy</i>
1. Relay K-1 fails to operate.	1. Defective relay. Switch S-1 closed. Capacitor C-2 shorted. Defective tube V-2.	1. Make a resistance test on coil pins No. 1 and No. 5. This should show 2,000 ohms. If there is less than 2,000 ohms look for a shorted capacitor C-2. If the coil has shorted turns replace with a new one. Be sure switch S-1 is open. Test tube V-2 and replace if necessary.

TROUBLE CHART FOR ELECTRONIC UNIT (contd).

<i>Symptom</i>	<i>Cause</i>	<i>Remedy</i>
<p>2. No tone signal at jack J-1.</p>	<p>2. Defective transformer T-1. Capacitor C-1 shorted. Resistor R-1 adjusted to have no resistance in the circuit.</p> <p>Defective tube V-1. Defective choke L-2. Shorted capacitor C-8. Defective resistor R-6.</p>	<p>2. Make resistance test on transformer T-1 to determine its continuity. If capacitor C-1 is suspected, one lead will have to be disconnected while it is under test. Be sure resistor R-1 is adjusted for maximum resistance. Test tube V-1 and replace if necessary. Make a resistance test of each section of choke L-2. A shorted capacitor C-8 will put a positive voltage on the grid of V-1 (pin No. 5). An open resistor R-2 will remove voltage from the screen grid (pin No. 4) of V-1. Replace any defective parts.</p>
<p>3. No voltage at the plate of tube V-1 or V-2.</p>	<p>3. Shorted capacitor C-6 or C-7. Open filter choke L-1. Defective transformer T-2. Defective tube V-3. Shorted capacitor C-5 or open resistor R-3 or R-4 if no plate voltage on tube V-1.</p> <p>Open transformer T-1 or coil of relay K-1 if no plate voltage on tube V-2.</p>	<p>3. A low resistance reading of a few ohms from filament, pin No. 1 of tube V-3, to ground will indicate a shorted filter capacitor. A resistance test should be made on the filter choke to determine its continuity. A shorted capacitor C-5 will remove plate voltage from tube V-1 and heat up resistor R-3. Test resistors R-3, R-4, transformer T-1, relay K-1, and transformer T-2 for continuity. Test tube V-3. Replace any defective parts.</p>

32. VOLTAGE READINGS.

a. **General.** Normal voltages with the unit in operating condition and connected to a source of 115-volt, a-c power, are indicated in the following table. A defect in any component electrical part will cause one or several of these readings to be abnormal.

b. Voltage Chart.

Tube type No.	Function	Measurements made		Reading
		From	To	
80	Rectifier	Plate pin No. 2	Plate pin No. 3 (volts ac)	640
80	Rectifier	Filament pin No. 1	Chassis (volts dc)	380
80	Rectifier	Filament pin No. 1	Filament pin No. 4 (volts ac)	5
6V6	Oscillator	Plate pin No. 3	Chassis (volts dc)	145
6V6	Oscillator	Screen grid pin No. 4	Chassis (volts dc)	110
6V6	Oscillator	Control grid pin No. 5	Chassis (volts dc)	-13
6V6	Oscillator	Filament pin No. 2	Filament pin No. 7 (volts ac)	6.3
6V6	Control grid current (volume control clockwise)		(ma dc)	1
6V6	Plate current (volume control clockwise)		(ma dc)	10
6V6	Heater current		(ma ac)	450
6V6	Screen current (volume control clockwise)		(ma dc)	3
89Y	Amplifier	Heater pin No. 1	Heater pin No. 6 (volts ac)	6.3
89Y	Amplifier	Plate pin No. 2	Chassis (volts dc)	380
89Y	Amplifier	Screen pin No. 3	Chassis (volts dc)	380
89Y	Amplifier	Control grid cap	Chassis (volts dc)	0
89Y	Amplifier	Suppressor grid pin No. 4	Chassis (volts dc)	40
89Y	Amplifier	Cathode pin No. 5	Chassis (volts dc)	105
89Y	Amplifier	Plate current (volume control clockwise, tone on)	(ma dc)	15
89Y	Amplifier	Screen current (volume control clockwise, tone on)	(ma dc)	7

b. Voltage Chart (contd).

Tube type No.	Function	Measurements made		Reading
		From	To	
89Y	Amplifier	Cathode current (volume control clockwise, tone on)	(ma dc)	22
89Y	Amplifier	Heater current	(ma ac)	400
*	*	Total current drain on power supply (volume control clockwise, tone on)	(ma dc)	32
*	*	Total current drain on power supply (volume control clockwise, tone off)	(ma dc)	10
*	*	Voltage drop across R-9	(volts dc)	255
*	*	Voltage drop across R-R-11	(volts dc)	50
*	*	Voltage drop across R-R-13	(volts dc)	55

33. MOISTUREPROOFING AND FUNGIPROOFING.

a. General. The operation of Signal Corps equipment in tropical areas where temperature and relative humidity are extremely high requires special attention. The following items represent problems which may be encountered in operation:

- (1) Resistors, capacitors, coils, chokes, transformer windings, etc., fail.
- (2) Electrolytic action takes place in resistors, coils, chokes, transformer windings, etc., causing eventual break-down.
- (3) Hook-up wire and cable insulation break down. Fungus growth accelerates deterioration.
- (4) Moisture forms electrical leakage paths between contacts, from contacts to ground, on terminal boards, and on insulating strips, causing partial shorts, flash-overs, and crosstalk.

b. Treatment. A moistureproofing and fungiproofing treatment has been devised which, if properly applied, provides a reasonable degree of protection against fungus growth, insects, corrosion, salt spray, and moisture. The treatment involves the use of a moisture- and fungi-resistant varnish applied with a spray gun or brush. Refer to TB SIG 13, Moistureproofing and Fungiproofing Signal Corps Equipment, for a detailed description of the varnish spray method of moistureproofing

and fungiproofing, and the supplies and equipment required in this treatment.

CAUTION: Varnish spray may have toxic effects if inhaled. To avoid inhaling spray, use respirator if available; otherwise, fasten cheesecloth or other cloth material over nose and mouth.

c. Step-by-step Instructions for Treating Automatic Transmitter XTR-442-C, Auto Head and Drive Unit.

(1) **PREPARATION.** Make all repairs and adjustments necessary for proper operation of the equipment.



Figure 17. Auto head and drive unit, showing first step in disassembly.

(2) **DISASSEMBLY.**

- (a) Remove the power cord.
- (b) Disconnect the pilot light assembly.
- (c) Remove the two bolts fastening auto head to base (fig. 17(a)).
- (d) Remove the ten screws that fasten cover to base.

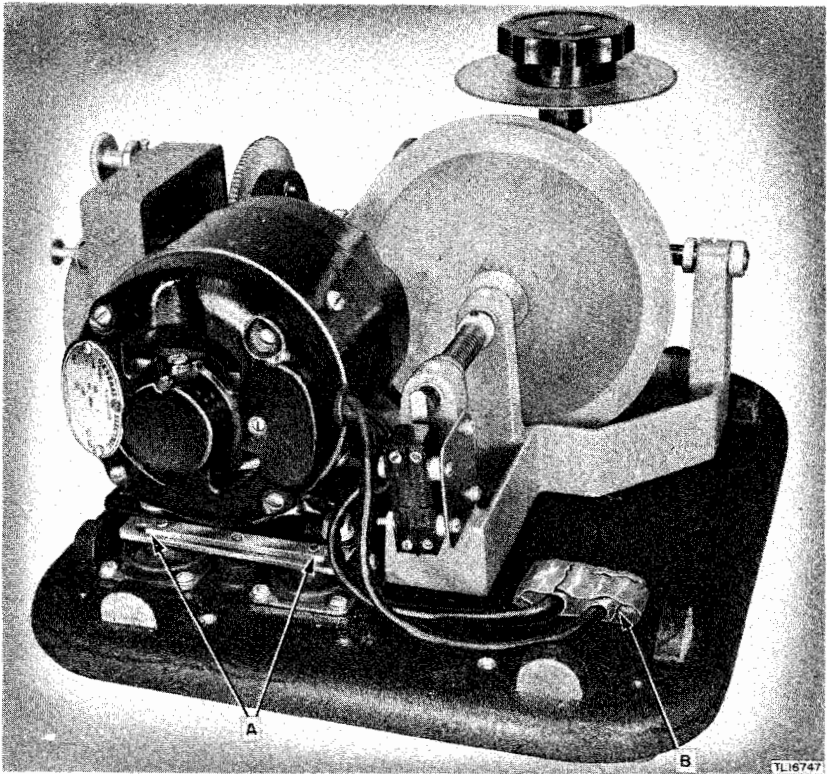

Figure 18. Auto head and drive unit prepared for moistureproofing and fungiproofing, rear view.

- (e) Lift cover from equipment.
- (f) Remove belt from pulleys.
- (g) Clean all dirt, dust, rust, fungus, oil, grease, etc., from the equipment to be treated.

NOTE: Unless the cleaning is done very carefully and thoroughly, the effectiveness of the moistureproofing and fungiproofing operation will be impaired.

(3) MASKING.

- (a) Mask the leather friction disk (fig. 19(b)).
- (b) Mask the teeth on the circular gear (fig. 19(a)).
- (c) Mask the teeth of the rack and pinion gear (fig. 19(c)).
- (d) Mask contacts on terminal strip (fig. 18(b)).
- (e) Mask coupling between friction disk and rack.

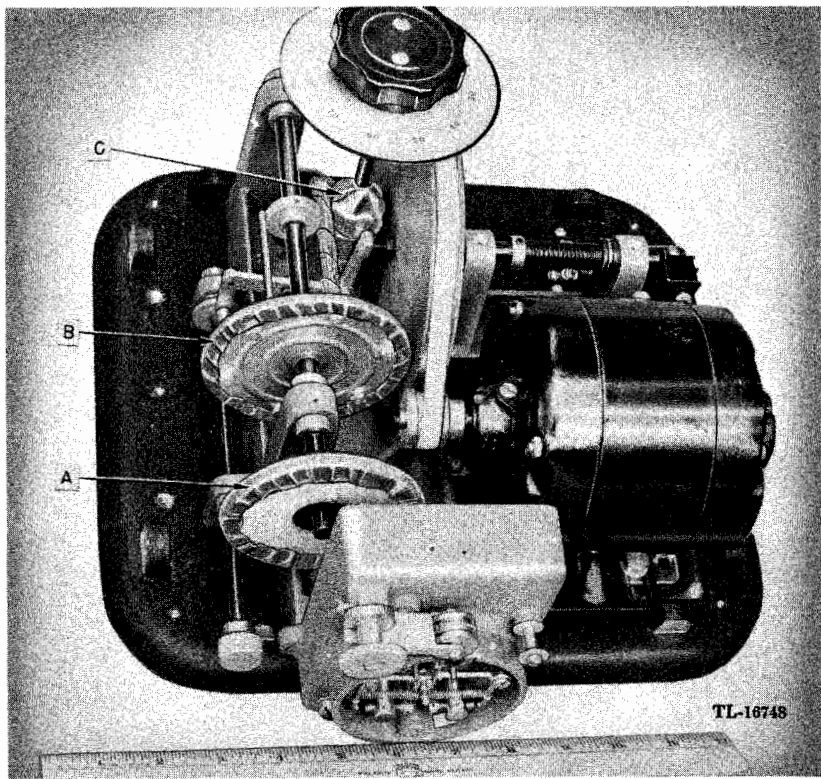

Figure 19. Auto head and drive unit prepared for moistureproofing and fungiproofing, top view.

(f) Mask three contact springs to which the auto head makes contact.
 (4) **DRYING.** Place equipment in oven or under heat lamps and dry for 4 to 6 hours at 140° F.

(5) VARNISHING.

(a) Apply three coats of moistureproofing and fungiproofing varnish (Lacquer, Fungus-resistant, Spec No. 71-2202 (Stock No. 6G1005.3), or equal), by brush to all components mounted on the base plate.

CAUTION: Do not allow varnish to drop on any moving surfaces.

(b) **DO NOT APPLY VARNISH TO ANY PART OF THE AUTO HEAD.**

(c) Avoid getting varnish on the rubber shock mountings (fig. 18(a)).

(d) As soon as the first coat of varnish has been applied, place the equipment in oven or under heat lamps and dry for 15 to 20 minutes.

- (e) Repeat operations (a) and (d) for one more coat of varnish.
- (f) When varnish is completely dry, remove all masking.

(6) REASSEMBLY.

- (a) Do not reassemble equipment until varnish is completely dry.
- (b) Clean all contacts with varnish remover, and burnish the contacts.
- (c) Reassemble equipment by following instructions for disassembly in reverse order.
- (d) Make a complete operational check of the unit to be sure it is in good operating condition.

(7) MARKING. Mark the equipment with "MFP" and the date of treatment near the nameplate.

EXAMPLE: MFP — 22 November 44.

d. Instructions for Treating Automatic Transmitter XTR-442-C, Electronic Unit.

(1) PREPARATION. Make all repairs and adjustments necessary for proper operation of the equipment.

(2) DISASSEMBLY.

- (a) Remove cover grill by removing four knurled bolts.
- (b) Remove the bottom cover plate by removing four screws securing it.
- (c) Disconnect cables fastened to chassis.
- (d) Remove the grid clip from Tube JAN-89Y.
- (e) Clean all dirt, dust, rust, fungus, etc., from the equipment.

NOTE: Unless the cleaning is done very carefully and thoroughly, the effectiveness of the moistureproofing and fungiproofing operation will be impaired.

(3) MASKING.

- (a) Mask the three binding posts marked X, Y, and C located on the left side of the chassis.
- (b) Mask the two toggle switches located on the front of the chassis.
- (c) Mask the two binding posts marked C and C1 located on the rear of the chassis.
- (d) Mask the phone jack hole located on the back of the chassis.
- (e) Mask the cable connector on the rear of the chassis.
- (f) Mask the rubber grommet and 6 to 8 inches of the power cord.

(g) Mask the end of the extractor fuse located on the rear of the chassis.

(h) Mask the grid clip and cap of tube JAN-89Y.

(i) Mask the glass of all tubes.

(j) Mask the bottom of all tube sockets and the relay socket.

(k) Mask the phone jack located *inside* the chassis.

(4) DRYING. Place equipment in oven and dry for 6 to 8 hours at 140° F.

(5) VARNISHING.

(a) Spray one coat of moistureproofing and fungiproofing varnish Fungus-resistant, Spec No. 71-2202 (Stock No. 6G1005.3), or equal, on all parts and surfaces of the equipment.

(b) Return equipment to oven for drying as soon as first coat of lacquer has been applied. Allow 15 to 20 minutes drying period.

(c) Repeat spraying and drying operations twice more.

(d) When lacquer is completely dry, remove all masking.

(6) REASSEMBLY.

(a) Reassemble equipment, when completely dry, by following instructions for disassembly in reverse.

(b) Make a complete operational check of the equipment to be sure it is in good operating condition.

(7) MARKING. Mark equipment with "MFP" and date of treatment near the nameplate.

EXAMPLE: MFP — 22 November 44.

SECTION V — SUPPLEMENTARY DATA

34. MAINTENANCE PARTS LIST FOR AUTOMATIC TRANSMITTER XTR-442-C.

Ref symbol	Signal Corps stock No.	Name of part and description	Mfr's part and code No.
18	4A3042/A6	AUTO HEAD AND DRIVE UNIT	MAH-142 (M29)
77	4A23	ARM, contact: brass; with cont.	1460C (M29)
30	4A55-1482C	ARM, pressure release: brass.	442C-76 (M29)
38	4A55-1484C	BEARING, sledge: brass.	1482C (M29)
39	4A55-1485C	BEARING; tape feed spindle.	1484C (M29)
40	4A55-1486C	BEARING; eccentric shaft-front.	1485C (M29)
54	3H310-23	BEARING; eccentric shaft-rear.	1486C (M29)
64	4A55-442C-11-4	BEARING; thrust; ball; $\frac{1}{4}$ " OD x $\frac{3}{8}$ " ID.	442C-47 (M29)
55	4A37	BEARING; oilite; $\frac{5}{8}$ " lg x $\frac{1}{2}$ " OD x $\frac{3}{8}$ " ID.	442C-11-4 (M29)
19	4A3042C/13	BELT, drive: fabric; $9\frac{1}{2}$ " lg x $\frac{3}{8}$ " wd.	442C-48 (M29)
88	2ZK9403.23	BLOCK, arm: brass; $\frac{3}{8}$ " lg x $\frac{3}{8}$ " wd x $\frac{1}{8}$ " thk.	1461C (M29)
89	4A53-442C-84	BOARD, term.: 3-cont.	3-140 (J5)
46	4A990	BUMPERS, rubber; $\frac{3}{4}$ " diam x $\frac{1}{8}$ ".	(M29)
84	4A990-1	CASTING, auto head: aluminum.	1421C (M29)
93	4A30-442C-87	CASTING, bracket: aluminum; grey.	442C-11 (M29)
27	4A3042C/15	CASTING, base: aluminum.	442C-87 (M29)
92	2Z2635.135	CENTER; contact spring: brass.	1465C (M29)
65	4A420-442C-46	CLAMP, cable: steel, RC.	6
66	4A420-442C-65	COLLAR; brass, cadmium plate; $\frac{1}{4}$ " thk x $\frac{5}{8}$ " OD x $\frac{3}{8}$ " ID; with 6-32 setscrew.	442C-46 (M29)
67	4A420-442C-66	COLLAR; brass; $\frac{3}{8}$ " thk x $\frac{5}{8}$ " OD x $\frac{3}{8}$ " ID.	442C- (M29)
71	4A420-442C-70	COLLAR; brass; $\frac{1}{4}$ " wd x $\frac{1}{2}$ " OD x $\frac{1}{8}$ " ID.	442C- (M29)
72	4A330-442C-71	COLLAR; brass; $\frac{1}{2}$ " OD x $\frac{1}{4}$ " ID x $\frac{1}{4}$ " thk.	442C (M29)
		COLLAR; eccentric: brass; $\frac{1}{8}$ " max diam x $\frac{3}{8}$ " thk.	442C (M29)

34. MAINTENANCE PARTS LIST FOR AUTOMATIC TRANSMITTER XTR-442-C (contd.)

<i>Ref symbol</i>	<i>Signal Corps stock No.</i>	<i>Name of part and description</i>	<i>Mfr's part and code No.</i>
90	4A2380-442C-85	CONTACT, spring: phosphor bronze.	442C-85 (M29)
69	4A569	DIAL: aluminum $3\frac{3}{8}$ " OD x $1\frac{1}{4}$ " ID; 10 to 100 wpm.	442C-68 (M29)
56	4A570-442C-50	DISK, friction: drive assem.	442C-50 (M29)
16	4A3042C/20	ELBOW, selector pin: brass; right-hand.	1458C (M29)
17	4A3042C/19	ELBOW, selector pin: brass; left-hand.	1459C (M29)
5	4A3042C/2	GEAR, spindle drive: fiber; 120-tooth.	1442C (M29)
41	4A700-442C-60	GEAR, pinion: brass; 20-tooth.	442C-60 (M29)
59	4A700-442C-55	GEAR, pinion: steel; $1\frac{1}{16}$ " diam.	442C-55 (M29)
83	4A700-442C-82	GEAR, head drive: fiber; $3\frac{1}{4}$ " diam.	442C-82 (M29)
23	4A3042C/14	HOLDER, contact screw: with cont.	1469C (M29)
33	4A3042C/3	HOLDER, selector pin: spring.	1448C (M29)
63	4A987	HOLDER, knob: aluminum; $1\frac{1}{2}$ " diam x 1" thk; $\frac{5}{16}$ " diam hole; with 10-32 setscrew.	442C-64 (M29)
6	4A3042C/4	HUB, drive gear: brass.	1443C (M29)
28	2Z5786-43	KNOB: tape feed roller lift.	1433C (M29)
68	2Z5753.38	KNOB: bakelite; $2\frac{3}{8}$ " diam x $\frac{7}{8}$ " h.	442C-67 (M29)
79	2Z5850-52	KNOB: sw control; brass.	442C-78 (M29)
15	4A1979-1457C	LINK, rocker eccentric: brass.	1457C (M29)
73	4A1979-442C-72	LINK: $1\frac{5}{8}$ " lg x $\frac{5}{8}$ " wd x $\frac{1}{16}$ " thk.	442C-72 (M29)
85	3H3000A05-27	MOTOR, a-c: 115-v; 60-cps; single-ph; 1/20-hp; 1,725 rpm.	5KH23A C9 (G3)
87	2Z8401.1	MOUNTINGS, shock: rubber; $1\frac{3}{4}$ " lg x $1\frac{3}{4}$ " wd x $\frac{1}{8}$ " thk.	P-6 (16)
9	4A3042/P4	PIN, selector: steel; $1\frac{1}{8}$ " lg.	1451C (M29)
37	6L3941-4-1	PIN: sledge spring stop.	1429C (M29)
44	4A3042C/6	PIPE: spindle bearing oil, $1\frac{5}{8}$ " lg x $\frac{1}{8}$ " OD.	1472C (M29)
45	4A3042C/7	PIPE: shaft bearing oil, $2\frac{11}{16}$ " lg x $\frac{1}{8}$ " OD.	1473C (M29)
3	4A3042C/17	PLATE, slip: steel; chrome-plated.	1440C (M29)

47	4A3042C/8	PLATE, front cover: steel; 3 $\frac{1}{4}$ " diam.	1422C (M29)
82	4A1790-442C-81	PLATE, sw mtg assem: steel.	442C-81 (M29)
86	4A1790-442C-83	PLATE, motor mtg assem: steel.	442C-83 (M29)
49	4A1895-442C-63	PULLEY, drive: cast iron; 6" diam.	442C-63 (M29)
50	4A1895-442C-49	PULLEY, motor shaft: steel.	442C-49 (M29)
57	4A1900	RACK: speed control assem.	442C-52 (M29)
13	4A3042/R5	ROCKER, elbow: brass.	1455C (M29)
1	6Z7682-1	ROLLER, tape feed: with sleeve.	1426C (M29)
4	6L6256-2.49S	SCREW, slip plate: No. 2-56; $\frac{1}{8}$ " lg.	1441C (M29)
11	6L6256-2.12S	SCREW: No. 2-56; $\frac{1}{8}$ " lg; fillister head.	1453C (M29)
14	4A3042C/10	SCREW, rocker shoulder: No. 6-32 thd.	1456C (M29)
20	6L6256-2.15CR	SCREW, arm block set: No. 2-56; $\frac{1}{8}$ " lg.	1462C (M29)
24	4A3042/S3	SCREW, cont: with cont.	1470C (M29)
26	6L15006-17.47S	SCREW, elbow shoulder: steel.	1483C (M29)
32	4A3042C/11	SCREW: tape feed roller.	1434C (M29)
35	6L20908-10Cr	SCREW: cont spring center.	1466C (M29)
43	6L4768-6-15F	SCREW, pinion gear: steel.	442C-62 (M29)
48	4A3042C/9	SCREW, cover: brass, $\frac{3}{8}$ " lg x 6-32 thd.	1424C (M29)
74	6L6440-8.47S1	SCREW, steel: $\frac{1}{2}$ " lg x $\frac{1}{4}$ " max diam.	442C-73 (M29)
78	6L15008-9.47S	SCREW, shoulder: steel; $\frac{5}{16}$ " lg.	442C-77 (M29)
81	6L18510-19.7S	SCREW, collar stop: 1 $\frac{5}{8}$ " lg; 10-32 thd.	442C-80 (M29)
10	4A2298.1	SHAFT: eccentric.	1452C (M29)
51	4A2298.3	SHAFT, drive pulley: cold-rolled steel.	442C-44 (M29)
52	4A2298.2	SHAFT, friction drive: cold-rolled steel.	442C-51 (M29)
61	4A2298.4	SHAFT, speed control: steel; 7 $\frac{1}{8}$ " lg x $\frac{5}{16}$ " diam.	442C-53 (M29)
70	4A2298	SHAFT, sw control and pressure release: steel; 8 $\frac{3}{4}$ " lg x $\frac{1}{4}$ " diam.	442C-69 (M29)
29	4A3042C/18	SLEDGE, brass: 2" lg x $\frac{3}{8}$ " h x 1 $\frac{1}{16}$ " wd.	1425C (M29)
21	4A3042C/5	SLEEVE, insulating: irvolite.	1463C (M29)
31	4A3042C/1	SLEEVE: tape feed roller.	1427C (M29)
54	4A3042C/12	SLEEVE: tape guide.	1437C (M29)

46 34. MAINTENANCE PARTS LIST FOR AUTOMATIC TRANSMITTER XTR-442-C (contd).

Ref symbol	Signal Corps stock No.	Name of part and description	Mfr's part and code No.
7	4A3042C/16	SPINDLE: tape feed.	1447C (M29)
2	4A3042/S10	SPRING, sledge: No. 19 wire.	1428C (M29)
8	4A3042/S9	SPRING, selector pin: No. 5/0 wire.	1450C (M29)
22	4A3042/S5	SPRING: cont arm.	1464C (M29)
53	4A2380.1-1	SPRING, drive pulley shaft: No. 20 wire.	442C-45 (M29)
60	4A2380.1	SPRING, compression type: $2\frac{1}{4}$ " lg x $\frac{1}{16}$ " diam.	442C-54 (M29)
25	4A2380	SPRING, arm tension: No. 8 wire.	442C-79 (M29)
12	6R38456	TOOL: cont adjusting.	1481C (M29)
36	6L50111-8C	WASHER, brass: $\frac{3}{8}$ " OD x $\frac{3}{8}$ " ID x 0.014" thk.	1454C (M29)
58	6L50522-23	WASHER, shoulder: fiber, $\frac{1}{2}$ " OD.	1471C (M29)
62	6L58026-14	WASHER: speed control friction.	442C-59 (M29)
75	6L54005-4	WASHER, rubber: $1\frac{1}{8}$ " OD x $\frac{3}{8}$ " ID.	442C-56 (M29)
76	6L58422-2F	WASHER, steel: $\frac{1}{4}$ " diam x $\frac{1}{8}$ " thk, with shoulder.	442C-74 (M29)
42	6L58421-1F	WASHER, shoulder: steel; $\frac{3}{8}$ " diam x $\frac{1}{8}$ " hole.	442C-75 (M29)
	4A610-442C-61	WHEEL, fly: brass; chrome-plated.	442C-61 (M29)
		AMPLIFIER	(M29)
E2, 3	2Z9418.46	BOARD, term: 18-lug.	442C-89 (M29)
	2Z9418.45	BOARD, term: 18-lug.	442C-88
W2	3E4538-4	CABLE ASSEMBLY: 3 ft lg with amphenol connector.	442C-99 (M29)
C1, 3, 5, 8	3DA20-55	CAPACITOR, paper: 0.02-mf; 600 vdcw.	TC-12 (S8)
C2	3DA10-163	CAPACITOR, paper: 0.01-mf; 600 vdcw.	TC-11 (S8)
C4	3DA50-95	CAPACITOR, paper: 0.05-mf; 600 vdcw.	TC-15 (S8)
C6, 7	3DB8-69.2	CAPACITOR, paper: oil; 8-mf; 600 vdcw.	TJU-6080 (C15)
C9, 10	3DB20-71	CAPACITOR, electrolytic: 20-mf; 250 vdcw.	VEC-6 (S8)
C11	3DA100-4	CAPACITOR, paper; 0.1-mf; 600 vdcw.	TC-1 (S8)
L1	3C344-18	COIL, filter choke: 8-h at 150 ma.	CI710 (S27)

L2	3C575G-2	COIL: filter choke.	4843 (U4)
J2	2Z8658	CONNECTOR, female: 3-cont.	PC-3F (A13)
F1, 2	3Z2587.1	FUSE, cartridge: 1/4-amp; 250-v; type 3AG.	(L3)
E1	3Z3285-2	HOLDER, fuse: for 3AG fuse.	HKM (B9)
J1	2Z5534A.1	JACK, phone: 2-ckt.	702A (M1)
I1	2Z6125-45	LAMP, indicator: 115-v neon bulb and mig assem.	PLN844-51 (S48)
H1	3Z741-15	POST, binding: screw-type.	442C-97 (M29)
K1	2Z7586-45.1	RELAY, keying: SPDT; 2,000-ohm coil; 3-amp cont; plug-in type.	Spcl (S63)
R1	2Z7296-2A	RESISTOR, pot: carbon; 50,000-ohm; 4-w.	M50MP (M1)
R2, 7	3RC31BE104J	RESISTOR, carbon: 100,000-ohm; 1-w.	RC31BE-104J
R3	3RC31BE203J	RESISTOR, carbon: 20,000-ohm; 1-w.	RC31BE-203J
R4	3RC31BE202J	RESISTOR, carbon: 2,000-ohm; 1-w.	RC31BE-202J
R5	3RC31BE103J	RESISTOR, carbon: 10,000-ohm; 1-w.	RC31BE-103J
R6	3RC31BE153J	RESISTOR, carbon: 15,000-ohm; 1-w.	RC31BE-153J
R8	3RC21BE514J	RESISTOR, carbon: 500,000-ohm; 1/2-w.	RC21BE-514J
R9	3Z6610-221	RESISTOR, wire-wound: 10,000-ohm; 10-w.	CC (U4)
R10	3Z6025-10	RESISTOR, wire-wound: 250-ohm; 10-w.	CC (U4)
R11, 13	3Z6200-4	RESISTOR, wire-wound: 2,000-ohm; 10-w.	SPT (A25)
R12	3RC31BE395K	RESISTOR, carbon: 4-meg; 1-w.	RC31BE-395K
X1	2Z8799-137	SOCKET, tube: octal.	78-S8 (A13)
X2	2Z8688	SOCKET, tube: 6-cont.	78S6 (A13)
X3	2Z8674.8	SOCKET, tube: 4-cont.	78-S4 (A13)
X4	2Z8687	SOCKET, tube: 5-prong.	78-S5 (A13)
S1, 2	3Z9858-9	SWITCH, toggle: SPST; 3-amp; 250-v.	(C18)
T1	2F9632.358	TRANSFORMER, AF: output; pri ct; sec 5-50 ohm.	8775B (U4)
T2	2Z9613.381	TRANSFORMER, power: pri 115-v; 50/60 cps; sec No. 1, 720 v at 120 ma ct; sec No. 2, 5 v at 3 amp ct; sec No. 3, 6.3 v at 4.5 amp ct.	P-6013 (S27)
V1	2J6V6G	TUBE, JAN-6V6G.	JAN 6V6G
V2	2J89Y	TUBE, JAN-89Y.	JAN 89Y
V3	2J80	TUBE, JAN-80.	JAN 80

LIST OF MANUFACTURERS

<i>Code</i>	<i>Name</i>
A 13	American Phenolic Corp.
A 25	Atlas Resistor Co.
B 9	Bussman Mfg. Co.
C 15	Cornell-Dubilier Electric Corp.
C 18	Cutler-Hammer Inc.
G 3	General Electric Co.
I 6	Isolantite Inc.
J 5	Jones, Howard B.
L 3	Littelfuse Lab.
M 1	Mallory, P. R. & Co.
M 29	McElroy & Goode Inc.
S 8	Sprague Products Co.
S 27	Standard Transformer Corp.
S 48	Signal Indicator Corp.
S 63	Sigma Instrument Corp.
U 4	Utah Radio Products Co.

RESISTOR COLOR CODES

RMA COLOR CODE FOR FIXED COMPOSITION RESISTORS

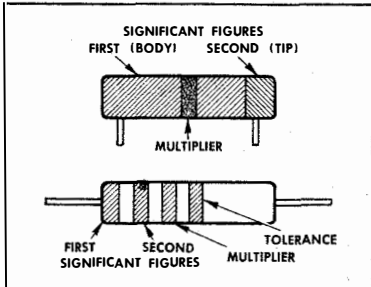

Insulated fixed composition resistors with axial leads are designated by a natural tan background color. Non-insulated fixed composition resistors with axial leads are designated by a black background color.

AWS COLOR CODE FOR FIXED COMPOSITION RESISTORS

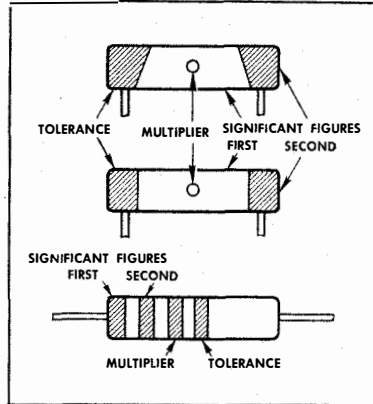

The exterior body color of insulated resistors may be any color except black. The usual color is natural tan. The exterior body color of uninsulated resistors with axial leads may be either black or white. The exterior body color of uninsulated resistors with radial leads may be black or it may be the color of the first significant figure of the resistance value.

COLOR	SIGNIFICANT FIGURE	MULTIPLIER	TOLERANCE (PERCENT)
BLACK	0	1	
BROWN	1	10	
RED	2	100	
ORANGE	3	1000	
YELLOW	4	10,000	
GREEN	5	100,000	
BLUE	6	1,000,000	
VIOLET	7	10,000,000	
GRAY	8	100,000,000	
WHITE	9	1,000,000,000	
GOLD		0.1	5
SILVER		0.01	10
NO COLOR			20

RMA: Radio Manufacturers Association
AWS: American War Standard
(American Standards Association)

Figure 20. Resistor color code.

TL 13418

CAPACITOR COLOR CODES

RMA 3-DOT COLOR CODE FOR MICA-DIELECTRIC CAPACITORS

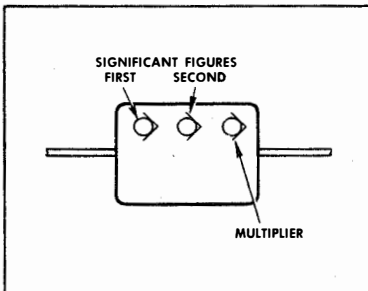

Capacitors marked with this code have a voltage rating of 500 volts.

RMA 6-DOT COLOR CODE FOR MICA-DIELECTRIC CAPACITORS

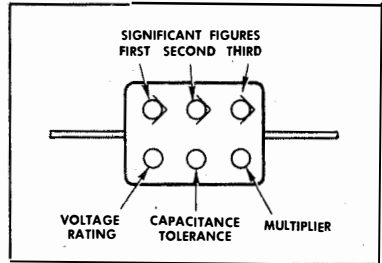

AWS 6-DOT COLOR CODE FOR PAPER-DIELECTRIC CAPACITORS

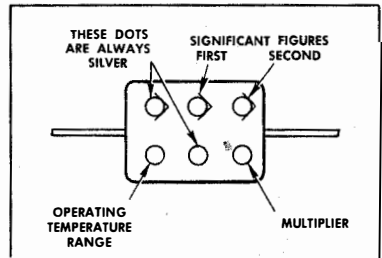

The silver dots serve to identify this marking. The sixth dot shows whether the capacitor has a maximum operating temperature of 167°F (black) or 185°F (brown).

COLOR	SIGNIFICANT FIGURE	MULTIPLIER		VOLTAGE RATING (VOLTS)	CHARACTERISTIC (AWS MICA-DIELECTRIC)
		RMA MICA- AND CERAMIC-DIELECTRIC AWS MICA- AND PAPER-DIELECTRIC	AWS CERAMIC-DIELECTRIC		
BLACK	0	1			A
BROWN	1	10	10	100	B
RED	2	100	100	200	C
ORANGE	3	1000	1000	300	D
YELLOW	4	10,000		400	E
GREEN	5	100,000		500	F
BLUE	6	1,000,000		600	G
VIOLET	7	10,000,000		700	
GRAY	8	100,000,000	0.01	800	
WHITE	9	1,000,000,000	0.1	900	
GOLD		0.1		1000	
SILVER		0.01		2000	
NO COLOR				500	

Figure 21. Capacitor color code.

AWS 6-DOT COLOR CODE FOR MICA-DIELECTRIC CAPACITORS

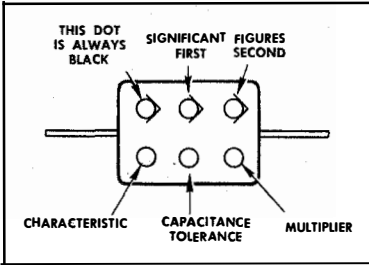

The black dot serves to identify the AWS marking. Capacitors marked with this code are rated at 500 volts, except the following: AWS type CMS5 capacitors with capacitances of 6,800, 7,500, and 8,200 micromicrofarads, and AWS type CM40 capacitors with capacitances of 9,100 and 10,000 micromicrofarads are rated at 300 volts.

AWS COLOR CODE FOR TUBULAR CERAMIC-DIELECTRIC CAPACITORS

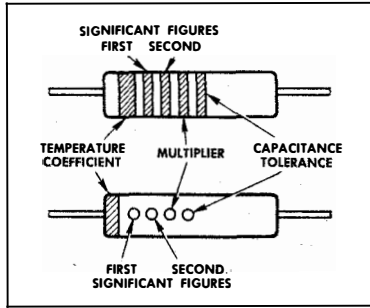

Capacitors marked with this code have a voltage rating of 500 volts.

RMA COLOR CODE FOR TUBULAR CERAMIC-DIELECTRIC CAPACITORS

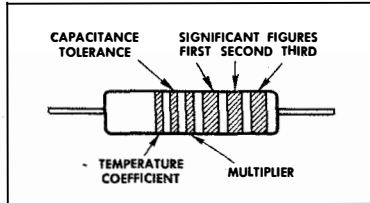

Capacitors marked with this code have a voltage rating of 500 volts.

RMA: Radio Manufacturers Association

AWS: American War Standard
(American Standards Association)

NOTE: These color codes give all capacitances in micromicrofarads.

CAPACITANCE TOLERANCE				TEMPERATURE COEFFICIENT OF CAPACITANCE $\times 10^{-4}$ MMF/MMF/°C
RMA & AWS MICA- AND PAPER-DIELECTRIC (PERCENT)	RMA CERAMIC-DIELECTRIC (PERCENT)	AWS CERAMIC-DIELECTRIC GREATER THAN 10 MMF (PERCENT)	AWS CERAMIC-DIELECTRIC LESS THAN 10 MMF (MMF)	
20	20	20	2.0	0
1	1	1		- 30
2	2	2		- 80
3	3	2.5	0.25	-150
4	4			-220
5	5	5	0.5	-330
6	6			-470
7	7			-750
8	2.5			+ 30
9	10	10	1.0	Not specified
5				
10				
20				

TL 13417

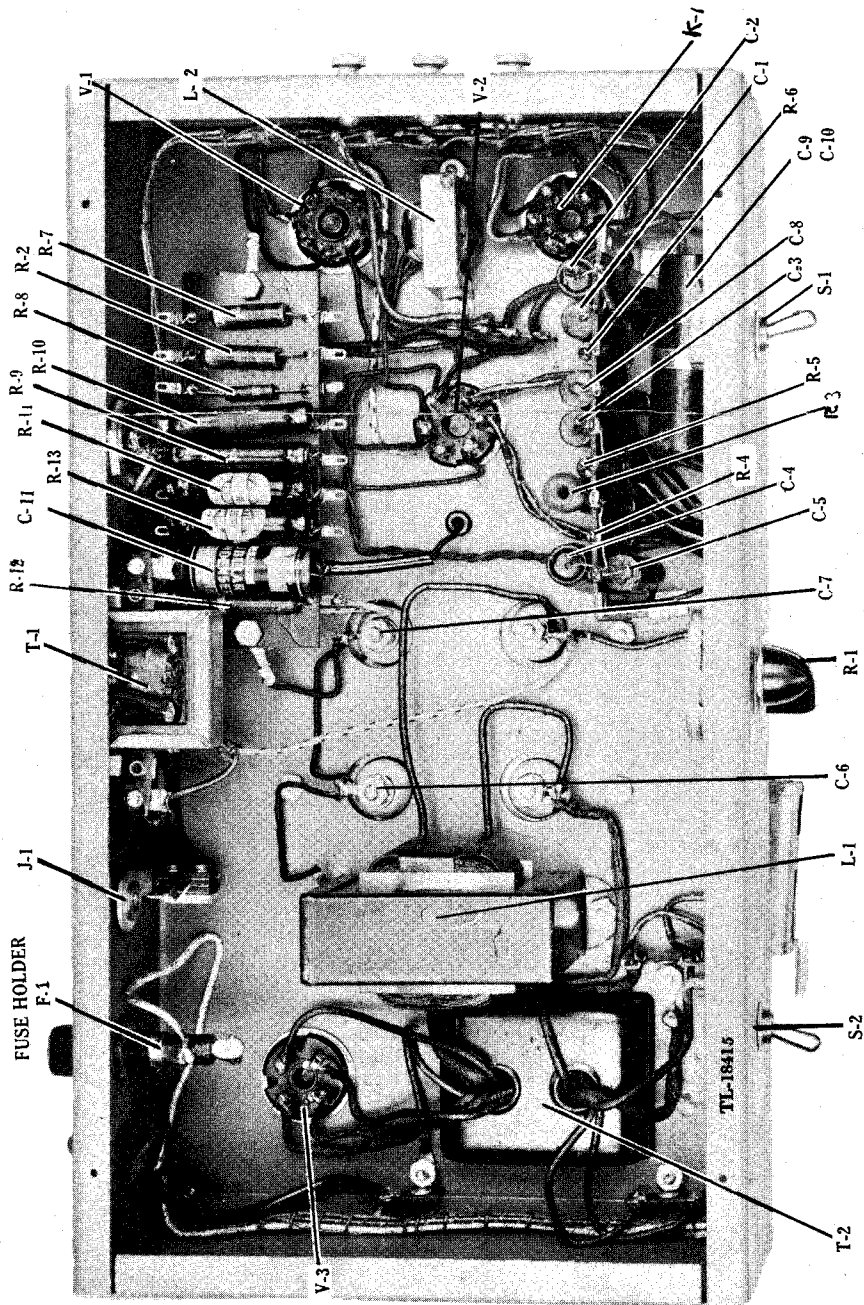

Figure 22. Underchassis view of electronic unit.

LEGEND

- C-1 .02 mfd, 600 vdcwv, paper capacitor.
- C-2 .01 mfd, 600 vdcwv, paper capacitor.
- C-3 Same as C-1.
- C-4 .05 mfd, 600 vdcwv, paper capacitor.
- C-5 Same as C-1.
- C-6 8 mfd, 600 vdcwv, oil capacitor.
- C-7 Same as C-6.
- C-8 Same as C-1.
- C-9 20 mfd, 250 vdcwv, electrolytic capacitor.
- C-10 Same as C-9.
- C-11 .1 mfd, 600 vdcwv, paper capacitor.
- F-1 5 amp, 3AG fuse.
- F-2 Same as F-1.
- I-1 Neon lamp.
- J-1 Headset jack.
- K-1 SPDT, keying relay.
- L-1 8 henry, iron core, choke.
- L-2 Tone choke.
- R-1 50,000 ohm, 4 watt, wire wound, variable resistor.
- R-2 100,000 ohm, 1 watt, composition resistor.
- R-3 20,000 ohm, 1 watt, composition resistor.
- R-4 2,000 ohm, 1 watt, composition resistor.
- R-5 10,000 ohm, 1 watt, composition resistor.
- R-6 15,000 ohm, 1 watt, composition resistor.
- R-7 Same as R-2.
- R-8 500,000 ohm, 1/2 watt, composition resistor.
- R-9 10,000 ohm, 10 watt, wire wound resistor.
- R-10 250 ohm, 10 watt, wire wound resistor.
- R-11 2,000 ohm, 10 watt, wire wound resistor.
- R-12 40 Meg ohms, 1 watt, composition resistor.
- R-13 Same as R-11.
- R-14 100,000 ohm, 1/3 watt, composition resistor.
- S-1 SPST, Toggle switch.
- S-2 Same as S-1.
- S-3 SPST, Snap Action Switch.
- T-1 Output Transformer.
- T-2 Power Transformer.
- V-1 6V6G, Vacuum Tube.
- V-2 89Y, Vacuum Tube.
- V-3 80, Vacuum Tube.

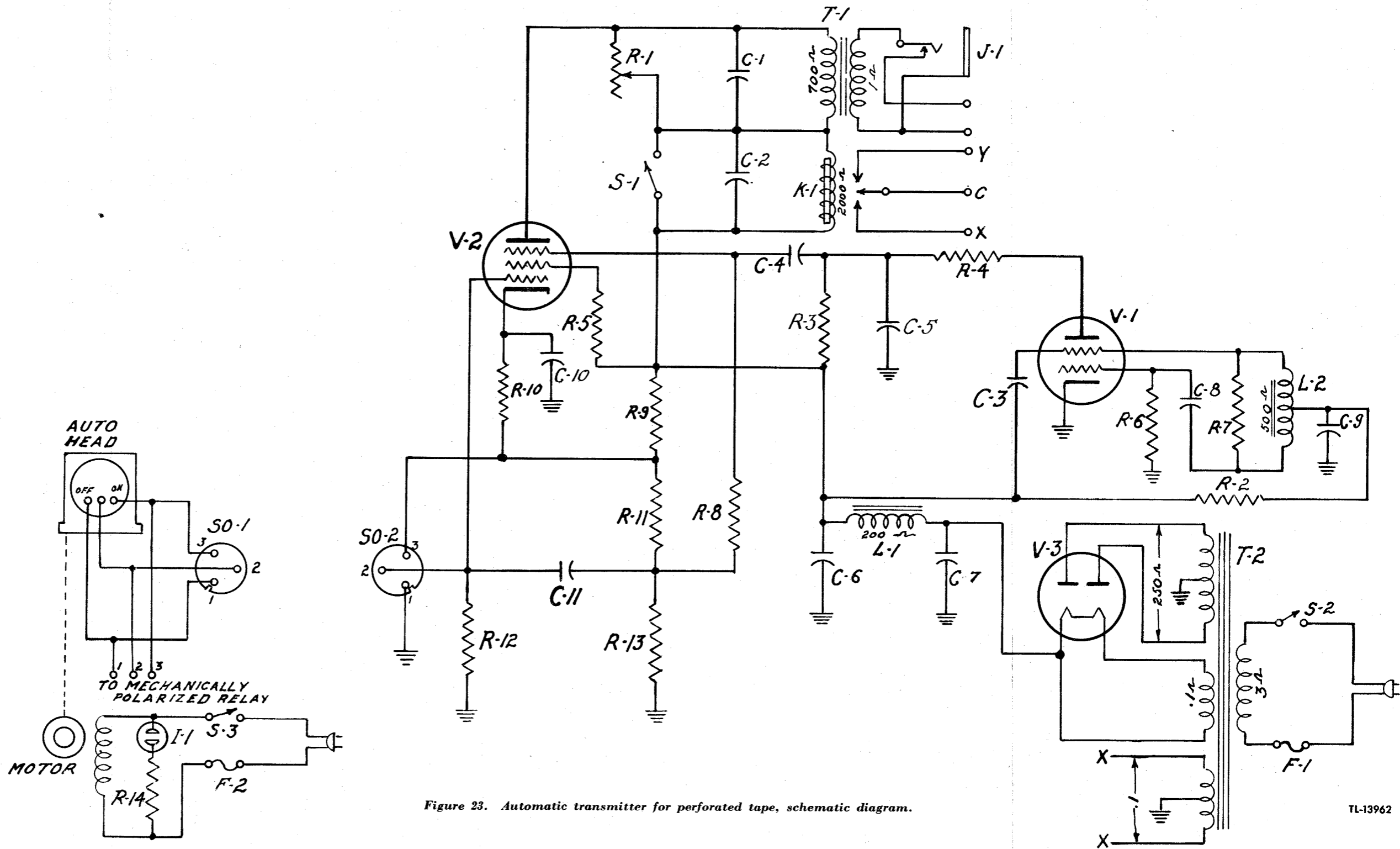

Figure 23. Automatic transmitter for perforated tape, schematic diagram.