

NAVSHIPS 92086

INSTRUCTION BOOK
for
OHMMETER ZM-1B/U

JETRONIC INDUSTRIES, INC.
PHILADELPHIA, PA.

BUREAU OF SHIPS

NAVY DEPARTMENT

Contract: NObsr-63271

*Approved by BuShips:
17 November 1953*

LIST OF EFFECTIVE PAGES

PAGE NUMBERS	CHANGE IN EFFECT
Title page	Original
A to C	Original
i to iii	Original
1-0 to 1-3	Original
2-1	Original
3-1, 4-1	Original
5-1, 6-1	Original
7-0 to 7-2	Original
8-1 to 8-4	Original

DEPARTMENT OF THE NAVY
BUREAU OF SHIPS
WASHINGTON 25, D. C.IN REPLY REFER TO
Code 993-100
17 November 1953

From: Chief, Bureau of Ships
To: All Activities Concerned with the
Installation, Operation and Main-
tenance of the Subject Equipment

Subj: Instruction Book for Ohmmeter
ZM-1B/U NAVSHIPS 92086

1. This is the instruction book for the subject equipment and is in effect upon receipt.
2. When superseded by a later edition, this publication shall be destroyed.
3. Extracts from this publication may be made to facilitate the preparation of other Department of Defense Publications.
4. All Navy requests for NAVSHIPS Electronics publications should be directed to the nearest District Publications and Printing Office. When changes or revised books are distributed, notice will be included in the Bureau of Ships Journal and in the Index of Bureau of Ships General and Electronics Publications, NAVSHIPS 250-020.

W. D. LEGGETT, JR.
Chief of Bureau

TABLE OF CONTENTS**SECTION 1—GENERAL DESCRIPTION**

<i>Paragraph</i>	<i>Page</i>
1. Equipment	1-1
2. Purpose and Basic Principles	1-1
3. Reference Data	1-1

SECTION 2—THEORY OF OPERATION

1. Description of Circuits	2-1
2. Description of Switches	2-1

SECTION 3—INSTALLATION

1. Unpacking Instructions	3-1
2. Installation	3-1

SECTION 4—OPERATION

1. Operation	4-1
--------------------	-----

SECTION 5—OPERATOR'S MAINTENANCE

1. Fuses	5-1
2. Pilot Lamp	5-1
3. Meter Zero	5-1
4. Internal Leakage Resistance	5-1
5. Tubes	5-1

SECTION 6—PREVENTIVE MAINTENANCE

1. Meter	6-1
2. Controls	6-1

SECTION 7—CORRECTIVE MAINTENANCE

1. Testing	7-1
2. Tube Operating Voltages	7-1
3. Tube Characteristics Design Center Values	7-1
4. Winding Data	7-1

SECTION 8—PARTS LISTS

LIST OF ILLUSTRATIONS

SECTION 1—GENERAL DESCRIPTION

<i>Figure</i>	<i>Title</i>	<i>Page</i>
1-1	Ohmmeter, Model ZM-1B/U	1-0
1-2	Ohmmeter, Model ZM-1B/U, Case Removed	1-2
1-3	Ohmmeter, Model ZM-1B/U, Rear View	1-2

SECTION 2—THEORY OF OPERATION

2-1	Measuring Circuit Diagram	2-1
-----	---------------------------------	-----

SECTION 7—CORRECTIVE MAINTENANCE

7-1	Wiring Diagram, Transformer	7-1
7-2	Schematic Diagram, Ohmmeter ZM-1B/U	7-3

LIST OF TABLES

SECTION 8—PARTS LISTS

<i>Figure</i>	<i>Title</i>	<i>Page</i>
8-1	List of Manufacturers	8-1
8-2	Cross Reference Parts List	8-1
8-3	Table of Replaceable Parts	8-2
8-4	Applicable Color Codes	8-4

ORDERING PARTS

All requests or requisitions for replacement material should include the following data:

1. Standard Navy stock number or, when ordering from a Marine Corps or Signal Corps supply depot, the Signal Corps stock number.
2. Name of part and complete description.

If the appropriate stock number is not available the following shall be specified:

1. Equipment model or type designation, circuit symbol, and item number.
2. Name or part and complete description.
3. Manufacturer's designation.
4. Contractor's drawing and part number.
5. JAN or Navy type number.

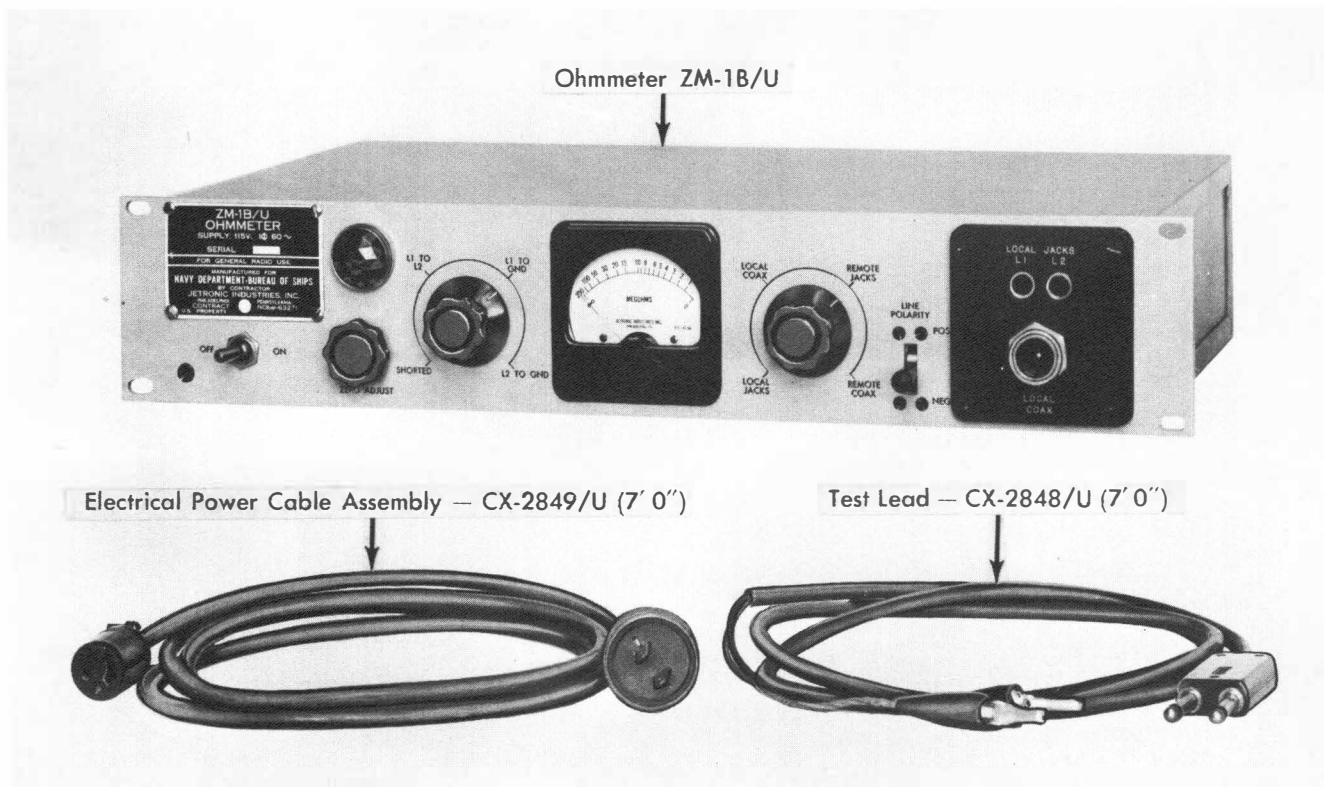

NAVSHIPS 92086
OHMMETER ZM-1B/U

Figure 1-1. Ohmmeter, Model ZM-1B/U

GENERAL
DESCRIPTION

SECTION 1 GENERAL DESCRIPTION

1. EQUIPMENT.

a. Figure 1-1 shows a front view of the ZM-1B/U Ohmmeter, the A.C. power cable and connectors, and

the test cable with plug and test clips.

b. Weight and Dimensions:

<i>Item</i>	<i>Weight</i>	<i>Unpacked Dimension</i>	<i>Weight</i>	<i>Packed Dimension</i>
1—ZM-1B/U Ohmmeter and Connection Cables	12½ lbs.	19 x 3½ x 10½ in.	18 lbs.	22½ x 14½ x 7 in.

2. PURPOSE AND BASIC PRINCIPLES.

The ZM-1B/U Ohmmeter measures resistance between .5 and 100 megohms and is designed specifically to measure the leakage resistance of balanced and unbalanced communication lines. The equipment consists of a 500 volt regulated power supply, a precision 10 megohm resistor, a D.C. microammeter, and various control switches. Connections are provided for two local lines on the front of the panel through a set of terminals (LOCAL JACKS) and a coax connector (LOCAL COAX). (See Figure 1-1.) Connections for two REMOTE lines are available at the rear of the cover through a removable plate on the equipment cover. These are marked REMOTE JACKS AND REMOTE COAX. (See Figure 1-3.)

Referring to Figure 1-2, SELECTOR SWITCH S103 allows resistance measurements between line L1 and line L2 (center conductor to shield for coax), between L1 and ground (center conductor to ground for coax), between L2 and ground (shield to ground for coax), and presents a short circuited termination for zero adjustment. The LINE POLARITY SWITCH S102 reverses the voltage output of the measuring circuit. At normal position this switch is open and no voltage is applied to the output terminals. Line L1 is positive when switch S102 is moved to POS and L1 is negative

when the switch is moved to NEG. The LINE SWITCH S104 selects the line to be measured.

CAUTION

THIS IS A HIGH RESISTANCE INSTRUMENT, THEREFORE CARE SHOULD BE EXERCISED TO KEEP INTERNAL SURFACE LEAKAGE TO A MINIMUM.

Any source of 95-130 volt 50-60 cycle power may be connected to the rear of the case through the cable and connections provided (W101).

3. REFERENCE DATA.

a. NOMENCLATURE.—This equipment is known as the ZM-1B/U Ohmmeter.

b. CONTRACT.—NObsr 63271.

c. CONTRACTOR.—Jetric Industries, Inc., Philadelphia, Pa.

d. COGNIZANT NAVAL INSPECTOR.—Inspector of Naval Material, Upper Darby, Pa.

e. NUMBER OF PACKAGES INVOLVED PER COMPLETE SHIPMENT. — ONE

f. TOTAL CUBIC CONTENTS. — 1.3 CU. FT.

g. TOTAL WEIGHT. — 18 LBS.

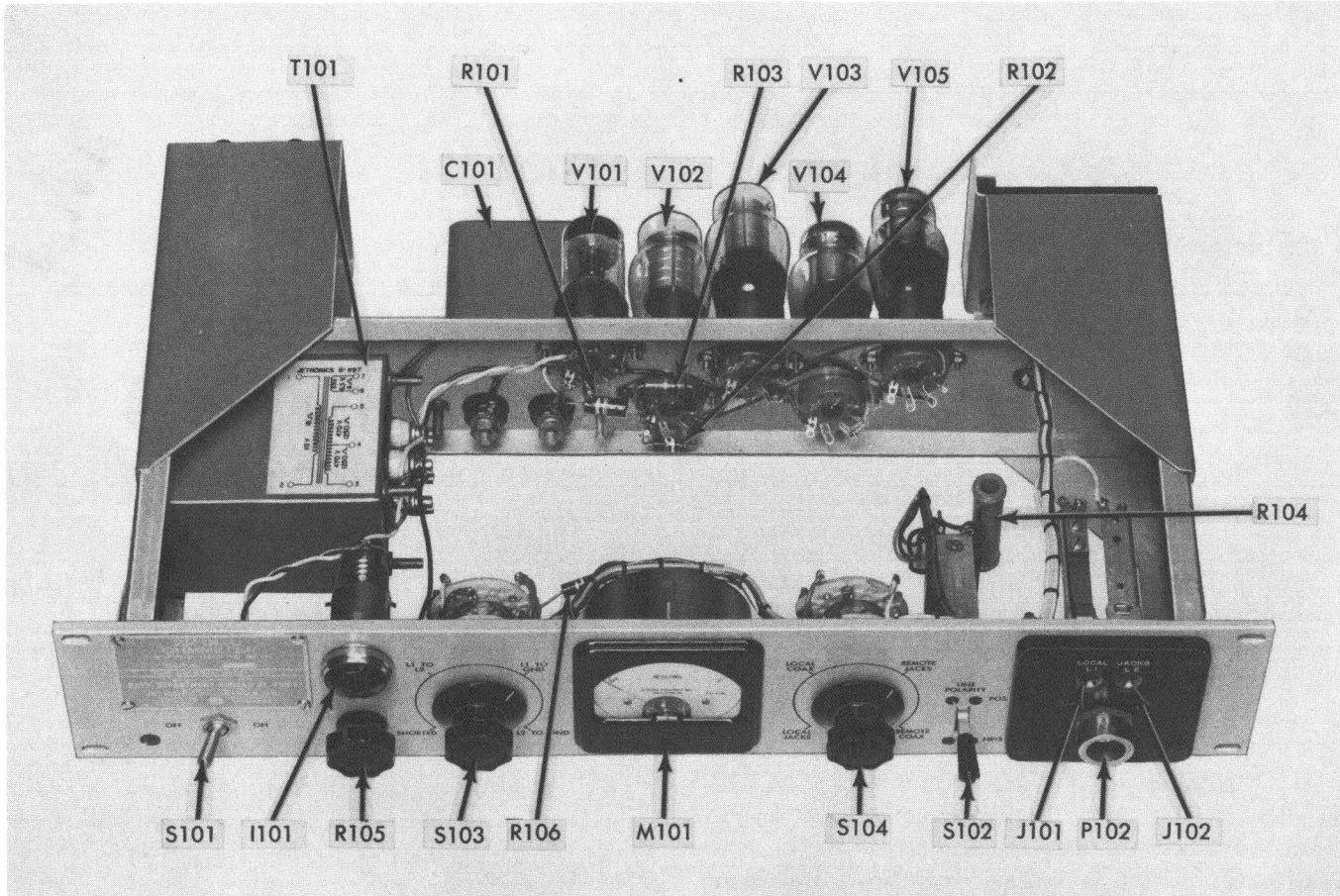

Figure 1-2. Ohmmeter, Model ZM-1B/U Case Removed

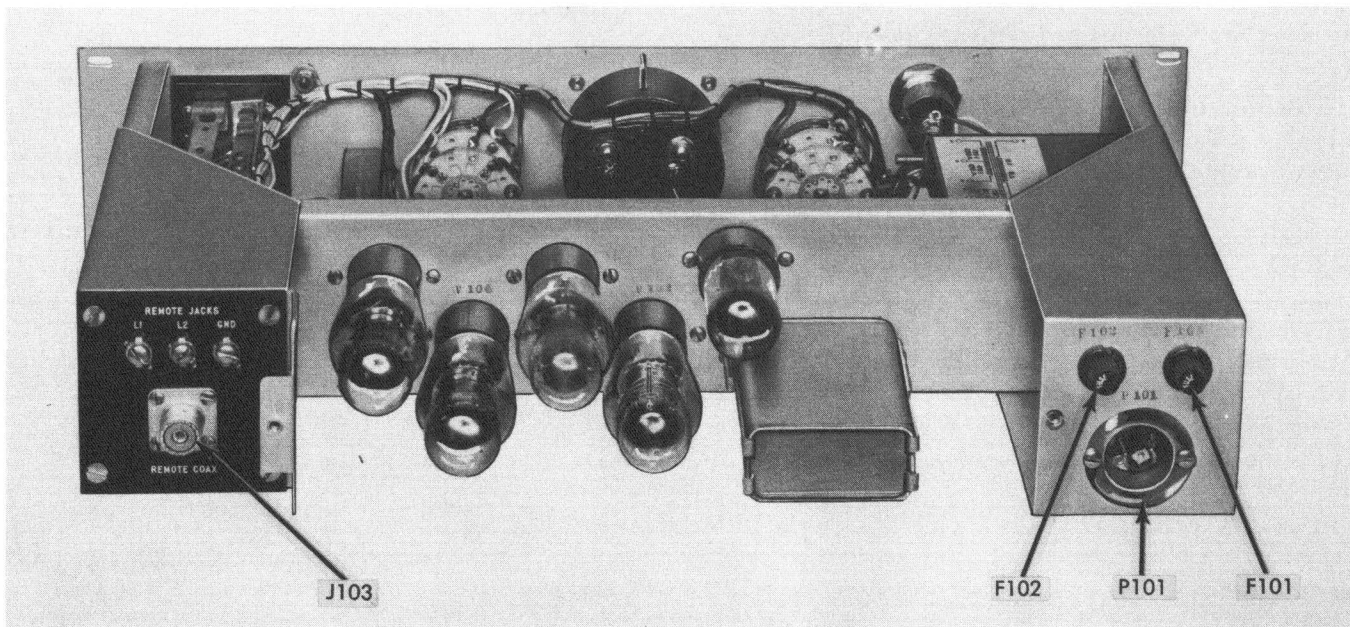

Figure 1-3. Ohmmeter, Model ZM-1B/U Rear View

SECTION 2 THEORY OF OPERATION

1. DESCRIPTION OF CIRCUITS.

The ZM-1B/U OHMMETER equipment consists of a conventional full wave power supply with the output regulated to approximately 500 volts through the resistance R101 (refer to Figure 7-2) by a series of voltage regulator tubes, V102 to V105. This regulated voltage is applied across conductors A and B of Figure 2-1. Figure 2-1 shows a common D.C. method of measuring resistance with a constant voltage. Potentiometer R105 and resistance R106 make up a relatively low resistance shunt to adjust the sensitivity of the 45 microampere meter M101. The meter measures the current as determined by the unknown resistance R_x and the 10 megohm precision resistor R104. The scale of the meter is calibrated in megohms from 1 to 200.

No part of the measuring circuit is grounded and care has been taken to keep the leakage resistance of this circuit to chassis at a high value. However, dust

and film accumulation on the phenolic terminal block of the LINE POLARITY SWITCH S102 and the REMOTE JACKS terminal board may result in a lowering of the internal leakage resistance. This condition can be remedied by cleaning these parts with dry cleaning solvent, MIL-S-16067 (SNSN G51-S-4718-10 for a 5 gal. can). Periodic checks of internal leakage resistance should be made in accordance with Sec. 5, par. 4.

2. DESCRIPTION OF SWITCHES.

The LINE POLARITY SWITCH S102 reverses the voltage polarity on the unknown resistance in order that any extraneous voltages on the line that might effect the accuracy of measurement will be detected. The position of the LINE SWITCH S104 selects the line to be measured and SELECTOR SWITCH S103 sets up the conditions for obtaining the desired resistance measurements.

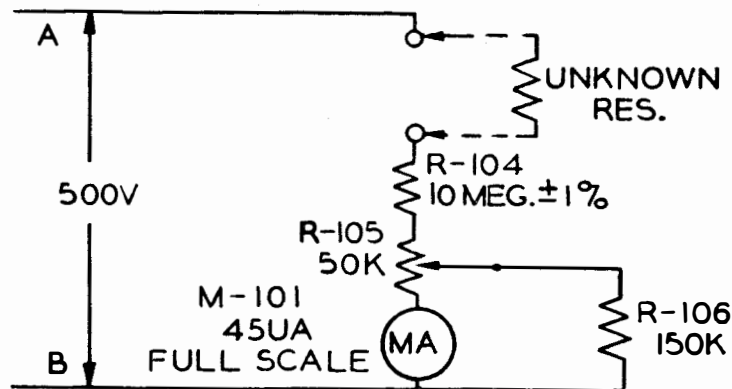

Figure 2-1. Measuring Circuit Diagram

SECTION 3 INSTALLATION

1. UNPACKING INSTRUCTIONS.

CAUTION

THIS EQUIPMENT INCORPORATES FRAGILE INSTRUMENTS. IT HAS BEEN PACKED WITH EXTREME CARE AND SHOULD BE UNPACKED AND HANDLED IN LIKE MANNER.

2. INSTALLATION.

a. TUBES.—The tubes for this equipment are separately packed and secured to the chassis. Remove the cover, unwrap the tubes and place them in their sockets in accordance with the following:

<i>Symbol Designation</i>	<i>Part</i>
V101	6X5GT/G Tube
V102	VR150 Tube
V103	VR150 Tube
V104	VR105 Tube
V105	VR105 Tube

b. EQUIPMENT MOUNTING.—The equipment is designed to mount on a standard 19" relay rack with 18¼ inch center to center mounting holes.

c. GROUNDING.—The terminal marked G on the terminal plate located on the rear of the equipment should be connected to the system ground to which leakage resistances are to be measured. The equipment proper may be grounded to the mounting rack through the panel mounting screws.

d. CONNECTION.—Use the A.C. power cable W101 to connect the equipment to any 50-60 cycle 95-130 volt source. Connections are made to the REMOTE JACK and REMOTE COAX connectors according to the application. LOCAL COAX and LOCAL JACKS can be connected at the front of the panel. Cable W102 is used for connecting to the LOCAL JACKS.

SECTION 4 OPERATION

To operate, turn on the POWER SWITCH S101 and allow 1 minute for the rectifier tube to warm up. The meter then reads "00". Check the full scale reading of the meter "0" by moving the SELECTOR SWITCH S103 to SHORT and the LINE POLARITY SWITCH S102 to its POS position. If necessary adjust zero adjust potentiometer R105 to obtain "0" full scale reading. Repeat for NEG position of LINE POLARITY SWITCH S102. (If any difference greater than 5% exists the equipment should be checked for internal leakage resistance.) (See Sec. 5, par. 4.) The equipment is then ready to measure the leakage resistance of a

line as determined by the position of the LINE SWITCH S104 and the SELECTOR SWITCH S103. L1 and L2 indicate the conductors of a 2 wire line. On a coax cable, L1 is the center conductor and L2 is the shield.

NOTICE

THE LINE OF WHICH THE LEAKAGE RESISTANCE IS TO BE MEASURED SHOULD BE DISCONNECTED FROM THE COMMUNICATION EQUIPMENT AT BOTH ENDS, AND SHOULD NOT BE ENERGIZED.

SECTION 5 OPERATOR'S MAINTENANCE

1. FUSES.—If a second fuse fails upon replacement the equipment should be checked for component and circuit defects.

CAUTION

DO NOT CONTINUE TO REPLACE FUSES UNTIL CAUSE OF FAILURE IS DETERMINED.

2. PILOT LAMP.—Lamps will occasionally fail. These can be replaced by removing the pilot light jewel cap at the front of the panel.

3. METER ZERO.—With the power switched off, the mechanical zero of the METER M101, Figure 1-2, may be set by turning the bakelite zero corrector screw

located below the scale opening until the meter pointer is at "00".

4. INTERNAL LEAKAGE RESISTANCE.—The internal leakage resistance of the measuring circuit to chassis should be checked at intervals. This can be done with the equipment itself by placing the SELECTOR SWITCH S103 at L1 to L2 and the LINE SWITCH at LOCAL JACKS. Insert plug of test cable W102 in LOCAL JACKS and clip L1 conductor to the equipment chassis. The meter pointer should not move from "00" by more than 2% of full scale when the LINE POLARITY SWITCH S102 is moved to either POS or NEG. Connect L2 to the chassis and repeat.

5. TUBES.—The tubes should be replaced at failure.

SECTION 6 PREVENTIVE MAINTENANCE

1. METER.—If meter pointer sticks, tap scale glass lightly with finger tip. If meter pointer shows excessive friction, repair or replace meter.

2. CONTROLS.—Keep knobs and various screws on the front of the panel tight.

FAILURE REPORTS

A FAILURE REPORT must be filled out for the failure of any part of the equipment whether caused by defective or worn parts, improper operation, or external influences. It should be made on Failure Report, form NAVSHIPS 383, which has been designed to simplify this requirement. The card must be filled out and forwarded to BUSHIPS. Full instructions are to be found on each card.

Use great care in filling the card out to make certain it carries adequate information. For example under "Circuit Symbol" use the proper circuit identification taken from the schematic drawings, such as T-803, in the case of a transformer, or R-207, for a resistor. Do not substitute brevity for clarity. Use the back of the card to completely describe the cause of failure and attach an extra piece of paper if necessary.

The purpose of this report is to inform BUSHIPS of the cause and rate of failures. The information is used by the Bureau in the design of future equipment and in the maintenance of adequate supplies to keep the present equipment going. The cards you send in, together with those from hundreds of other ships, furnish a store of information permitting the Bureau to keep in touch with the performance of the equipment of your ship and all other ships of the Navy.

This report is not a requisition. You must request the replacement of parts through your Officer-in-Charge in the usual manner.

Make certain you have a supply of Failure Report cards and envelopes on board. They may be obtained from the nearest District Printing and Publication Office.

SECTION 7 CORRECTIVE MAINTENANCE

1. TESTING.

The following information will be helpful in trouble shooting on the equipment covered in this INSTRUCTION BOOK.

D.C. Voltages from terminal to terminal should be checked with a 20,000 ohms/volt voltmeter. (AN/PSM-4, TS-352/U, NT-60086)

<i>Component</i>	<i>Terminal</i>	<i>Voltage</i>
T101	1-2	115VAC
	3-4	470VAC
	4-5	470VAC
	6-7	6.3VAC
V102	5-2	150VDC
V103	5-2	150VDC
V104	5-2	105VDC
V105	5-2	105VDC

The resistance of the windings of transformer T101 are marked on the Schematic Diagram, Figure 7-2

The leakage resistance of the circuit to chassis can be measured as explained in section 5 paragraph 4. Maximum allowable leakage resistance is 2% of full scale value.

2. TUBE OPERATING VOLTAGES.

<i>Type</i>	<i>Function</i>	<i>Heater A.C.</i>	<i>Peak Inverse</i>	<i>Regulating Voltage</i>	<i>Current ma.</i>
6X5	Rectifier	6.3*	1300*		.010
VR150	Regulator	—	—	150†	.010
VR105	Regulator	—	—	105†	.010

*read with 1000 ohms/volt A.C. voltmeter.
†read with 20,000 ohms/volt D.C. voltmeter.

3. TUBE CHARACTERISTICS DESIGN CENTER VALUES.

- 6X5G Full Wave Rectifier
- Heater—6.3 Volts AC or DC
- Heater Current .6 Amperes
- Pin 1—No conn.
- Pin 2—Heater
- Pin 3—Plate #2
- Pin 5—Plate #1
- Pin 7—Heater
- Pin 8—Cathode
- Peak Inverse Voltage—1250 Volts
- Peak Plate Current per plate—210 max. ma.

4. WINDING DATA.

(1) Power Transformer.

	<i>PRI.</i>	<i>SEC. #1</i>	<i>SEC. #2</i>
Voltage	115	470-470	6.3
Current	165	10 Ma.	1 AMP
No. Turns	650	5600	39
Turns at tap	—	2800	—
Wire Size	#28E	#40E	#22E
Turns/Layer	65	254	20
Resistance—Ohms	21	2500	.4
Terminals	1-2	3-4-5	6-7

Impregnation: Vacuum Clear varnish and Bake Insulation.

Insulation Test: 1500VRMS 60 cycle core to PRI. and Core to SEC.

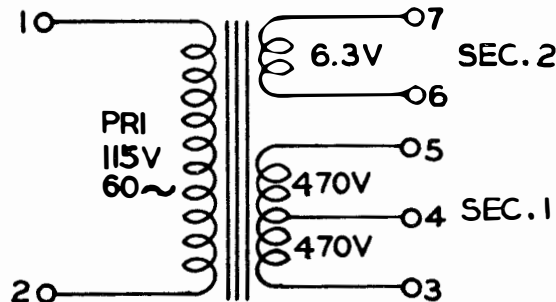

Figure 7-1. Wiring Diagram, Transformer

TABLE 8-1—LIST OF MANUFACTURERS

ABBREVIATION	PREFIX	NAME	ADDRESS
GE	CG	General Electric Company	Schnectady, New York
Littlefuse	CLF	Littlefuse Laboratories, Inc.	4757 N. Ravenswood Avenue, Chicago, Ill.
Carter		Carter Parts Company	213 Institute Place, Chicago, Ill.
Amphenol	CPH	American Phenolic Corp.	1830 S. 54th Avenue, Chicago, Ill.
Beede		Beede Electric Company	Penacook, New Hampshire
Hubbell	CHU	Harvey Hubbell, Inc.	Bridgeport, Conn.
N.E.	CN	National Electric Machine Shops	919 Jesup Blair Dr., Silver Spring, Md.
Stackpole	CSA	Stackpole Carbon Company	St. Mary's, Penna.
I.R.C.	CIR	International Resistance Company	401 N. Broad Street, Phila., Penna.
C.C.	CCC	Continental Carbon, Inc.	13902 Lorraine Avenue, Cleveland, Ohio
A-B	CBZ	Allen Bradley Company	134 W. Greenfield Avenue, Milwaukee, Wis.
A-H-H	CHH	Arrow-Hart and Hegeman Electric Co.	103 Hawthorn Street, Hartford, Conn.
Fed. Sw.	CFS	Federal Anti-Capacity Switch Corp.	72-82 Kingsley Street, Buffalo, New York
Oak	COC	Oak Mfg. Company	1260 Clybourn Avenue, Chicago, Ill.
Freed	CFX	Freed Transformer Company, Inc.	1718 Weirfield Street, Brooklyn 27, New York
R.C.A.	CRV	Radio Corporation of America	Tube Division, Harrison, New Jersey
Jetronic	CBUA	Jetronic Industries, Inc.	Main & Cotton Sts., Phila., Penna.
Drake	CAYS	Drake Mfg. Company	1713 W. Hubbard Street, Chicago, Ill.

TABLE 8-2—CROSS REFERENCE PARTS LISTS

STAND. NAVY STOCK NO.	KEY SYMBOL	STAND. NAVY STOCK NO.	KEY SYMBOL
G17-F-16302-100	F101	N16-T-53062-30	V102
G17-L-3914-100	I101	N17-C-48221-1021	W101
N16-C-49957-5958	C101	N17-C-48221-1026	W102
N16-R-50337-531	R101	N17-C-73108-5890	J103
N16-R-50677-751	R102	N17-C-73411-2793	P102
N16-R-50679-231	R106	N17-C-73428-3259	P101
N16-R-50976-231	R103	N17-F-74267-5401	E101
N16-R-73547-1326	R104	N17-J-39117-6465	J101
N16-R-87849-4453	R105	N17-L-76801-5141	X106
N16-S-63516-6549	X101	N17-S-73082-9028	S101
N16-T-53053	V104	N17-S-54777-1584	S102
N16-T-56860	V101		

TABLE 8-3—TABLE OF REPLACEABLE PARTS

Symbol Designation	Stock Numbers Signal Corps Standard Navy Air Force	Name of Part and Description	Function	JAN and (Navy Type) Numbers	Mfr. and Mfr's Designation	Contractor's Dwg. and Part No.	All Symbol Designation Involved	No. Per Unit
C101	N16-C-49957-5958	CAPACITOR, Fixed Paper Dielectric, 4 MFD. 600 V.D.C.W. with 2 mounting brackets	Filter	CP70EIFF 405K	GE 22F35G 103	A509	C101	1
E101	N17-F-74267-5401	FUSE HOLDER, Phenolic body with finger grip knob, for type 3 AG fuse	Line Fuse		Littlefuse 342001	A510	E101, E102	2
E102		Same as E101	Line Fuse					
F101	G17-F-16302-100	FUSE, Type #3 AG, 2 Ampere	Line Fuse	28032-2	Littlefuse 312002	A511	F101, F102	2
F102		Same as F101	Line Fuse					
I101	G17-L-3914-100	LAMP, 115V 6 watt Candelabra Base	Pilot Light		GE S6	A512	I101	1
J101	N17-J-39117-6465	JACK, Telephone tip sleeve single	Local Line Connection	JJ086	Carter AJ	B1192	J101, J102	2
J102		Same as J101	Local Line Connection					
J103	N17-C-73108-5890	RECEPTACLE, Coaxial Type	Remote Line Connection	49194	83-1-R	A636	J103	1
M101		METER, O-45 Microamperes Rectangular Phenolic Case OHMS Scale 0-200 MEGOHMS. Internal Resistance — 2000 OHMS.	Indicator		Beede 15	B1193 A460	M101	1
P101	N17-C-73428-3259	RECEPTACLE, 2 Prong Midget Twist-lock	Line Power	—49676	Hubbell 7486	A513	P101	1
P102	N17-C-73411-2793	RECEPTACLE, Concentric-Coax with ground terminal ring and lockwasher	Local Line Connection	—49120	N. E.	A637	P102	1
R101	For replacement use SNSN N16-R-50337-531	RESISTOR, Composition 15K \pm 10% 2 Watt		—RC 41BF 153K	Stackpole	B1194-1	R101	1
R102	N16-R-50677-751	RESISTOR, Composition, 510K \pm 5% 1 Watt		—RC 30BF 514J	I.R.C.	B1194-2	R102	1
R103	N16-R-50976-231	RESISTOR, Composition, 1 Meg \pm 10% 1 Watt		—RC 30BF 105K	I.R.C.	B1194-3	R103	1
R104	N16-R-73547-1326	RESISTOR, Precision, carbon deposited, ceramic coated. 10 Megohms \pm 1% 5 Watt		—636023- 1	C.C. X5	A514	R104	1

R105	For replacement use SNSN N16-R-87849-4453	POTENTIOMETER, Composition, 50K ± 10%, 2 watt, Linear Taper 3/8-32 x 3/8 Bushing, Round Shaft, 3/4 long in- cluding Bushing	Zero Adjust	—63123- M10	A - B JU5031	B1196	R105	1
R106	N16-R-50679-231	RESISTOR, Composition, 150K ± 10% 1 Watt		—RC 30BF 154K	I.R.C.	B1194-4	R106	1
S101	N17-S-73082-9028	SWITCH, Toggle, D.P.S.T. 6 Amp., 125 Volt	Line Power	ST 22K	A.H.H —82304-B	A515	S101	1
S102	N17-S-54777-1584	SWITCH, Lever Type 2 Sets S.P.D.T. Non-locking in both positions	Line Polarity	—24422	FED. 1425	B1197	S102	1
S103		SWITCH, Rotary: 2 Pole 4 Pos. with Dummy Lug. 3/8-32 x 3/8 Bushing, Round Shaft, 1 inch long including Bushing	Test Selector		Oak 57717-H20	A410	S103, S104	2
S104		Same as S103	Line Selector					
T101		TRANSFORMER, Power: Pri. 115V. 60 Cycles. Sec. 470-0-470 V. and 6.3 V. Pri- mary Rated 20 Volt — Amperes.	Power	—304289	13688	B1195	T101	1
V101	N16-T-56860	TUBE, Vacuum: Type 6X5	Full Wave Rectifier	JAN 6 X5 GT/G	R.C.A. 6 X5 GT/G	C2108-1	V101	1
V102	N16-T-53062-30	TUBE, Vacuum: Type VR150	Voltage Regu- lator	JAN-OD 3/VR150	R.C.A. VR150	C2108-2	V102, V103	2
V103		Same as V102						
V104	N16-T-53053	TUBE, Vacuum, Type VR105	Voltage Regu- lator	JAN-OC 3/VR105	R.C.A. VR105	C2108-3	V104, V105	2
V105		Same as V104						
W101	N17-C-48221-1021	CABLE ASSEMBLY, Consisting of one two-prong-male plug (Navy type — 49825), one 2-prong midget female, twist lock plug (Navy type 49677) and 7' type 2 SJO rubber covered cable	Power Cord	—6238 1	Jetronic B1198	B1198	W101	1
W102	N17-C-48221-1026	CABLE ASSEMBLY, Consisting of one twin telephone plug (Navy type — 491242, two crocodile test clips with rubber insul. sleeves, and 5' of type 2 SJO rubber covered cable	Test Cord	—62382	Jetronic B1199	B1199	W102	1
X101	N16-S-63516-6549	SOCKET OCTAL			Amphenol 77-MIP-8T	C2109-1	X101, X102, X103, X104, X105	5
X102		Same as X101						
X103		Same as X101						
X104		Same as X101						
X105		Same as X101						
X106	N17-L-76801-5141	SOCKET ASSEMBLY, pilot light, can- delabra base for type S6 lamp, with green faceted lens	Pilot Light		Drake 75	A516	X106	1

TABLE 8-4. APPLICABLE COLOR CODES

CAPACITOR COLOR CODES

RMA 3-DOT COLOR CODE FOR MICA-DIELECTRIC CAPACITORS

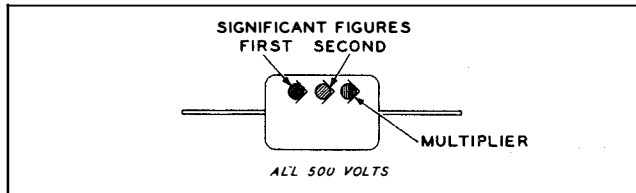

JAN 6-DOT COLOR CODE FOR PAPER-DIELECTRIC CAPACITORS

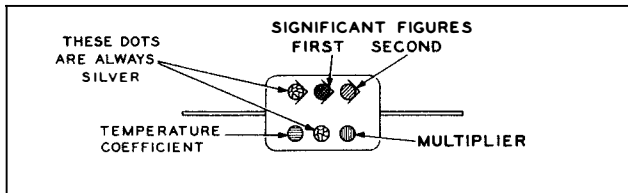

RMA 6-DOT COLOR CODE FOR MICA-DIELECTRIC CAPACITORS

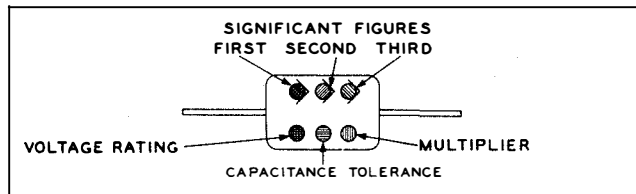

JAN 6-DOT COLOR CODE FOR MICA-DIELECTRIC CAPACITORS

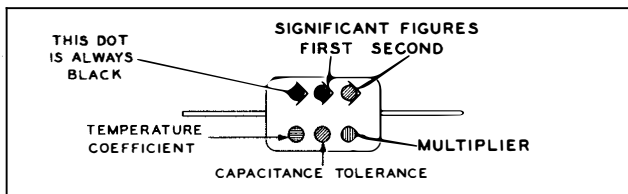

RMA COLOR CODE FOR TUBULAR CERAMIC-DIELECTRIC CAPACITORS

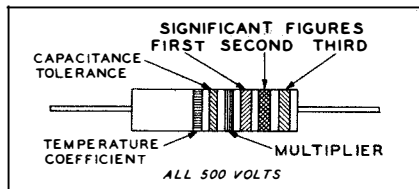

JAN COLOR CODE FOR FIXED CERAMIC-DIELECTRIC CAPACITORS
RADIAL TYPE NON-INSULATED

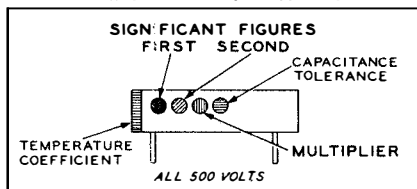

AXIAL TYPE INSULATED

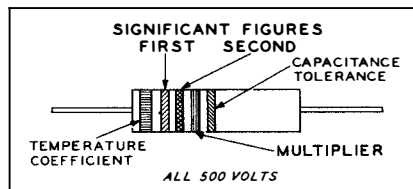

RMA: RADIO MANUFACTURERS ASSOCIATION
JAN: JOINT ARMY-NAVY

RESISTOR COLOR CODES

RMA COLOR CODE FOR FIXED COMPOSITION RESISTORS

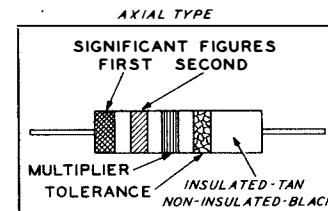

RADIAL TYPE

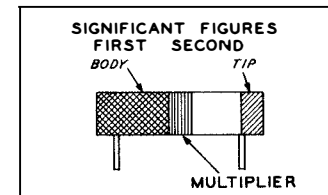

JAN COLOR CODE FOR FIXED COMPOSITION RESISTORS

AXIAL TYPE INSULATED

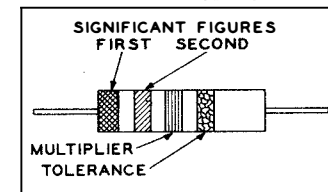

RADIAL TYPE NON-INSULATED

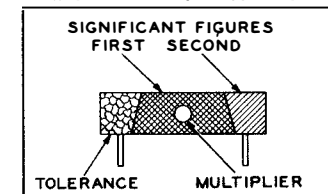

RESISTORS			CAPACITORS				VOLTAGE RATING	TEMPERATURE COEFFICIENT
TOLERANCE	MULTIPLIER	SIGNIFICANT FIGURE	COLOR	RMA MICA AND CERAMIC-DIELECTRIC	JAN MICA AND PAPER-DIELECTRIC	JAN CERAMIC DIELECTRIC		
	1	0	BLACK	1	1	1	A	
	10	1	BROWN	10	10	10	B	
	100	2	RED	100	100	100	C	
	1000	3	ORANGE	1000	1000	1000	D	
	10000	4	YELLOW	10000			E	
	100000	5	GREEN	100000			F	
	1000000	6	BLUE	1000000			G	
	10000000	7	VIOLET	10000000				
	100000000	8	GRAY	100000000		0.01		
	1000000000	9	WHITE	1000000000		0.1		
5	0.1		GOLD	0.1	0.1		1000	
10	0.01		SILVER	0.01	0.01		2000	
20			NO COLOR				500	