

**G.N.T.Co. TRANSMITTER
MODEL 112
INCORPORATING
SPEED REGULATOR MODEL 2042**

INSTRUCTION BOOKLET

G.N.T.Co. TRANSMITTER
MODEL 112
INCORPORATING
SPEED REGULATOR MODEL 2042

INSTRUCTION BOOKLET

THIRD EDITION

THE GREAT NORTHERN TELEGRAPH CO. (LTD.)

5, ST. HELEN'S PLACE - LONDON, E.C. 3

Telegrams :
NORDISKE, LONDON

Telephone : LONdon Wall 4567
Telex : LONdon Wall 5511

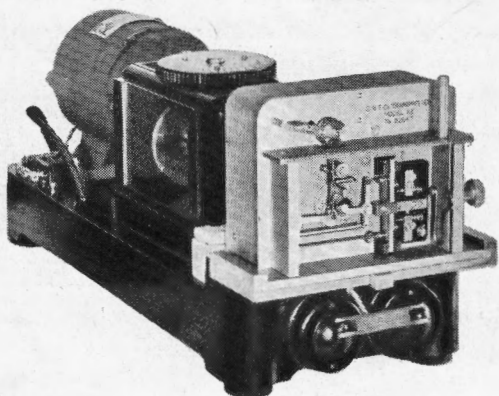

G.N.T.CO. TRANSMITTER MODEL 112

When ordering, please state—

- (1) *voltage of supply,*
- (2) *whether supply is alternating or direct current,*
- (3) *whether tape is 12 mm. or 9.5 mm. wide.*

G.N.T.Co. TRANSMITTER
MODEL 112
INCORPORATING
SPEED REGULATOR MODEL 2042

THIS Wheatstone transmitter, which is capable of working direct to line, embodies the following outstanding features :

(1) A speed range of 13—250 words per minute covered, without gear changes and without stopping the motor, by turning a single knob.

(2) The speed is governed at all settings, variations being smaller than $\pm \frac{1}{2}$ per cent. and supply voltage variations have no effect on the constancy of the speed.

(3) The working speed can be read directly from 15—240 w.p.m., and when returning to any speed setting after a temporary excursion to a different setting, exactly the same speed as before is always obtained.

(4) A specially designed contact mechanism ensures perfect contact making with a very short transit time and complete absence of rebound.

The transmitter mechanism, the speed regulator, and the motor, are all mounted on the main base. The transmitter mechanism is held in slides on the base and is secured by a clip to enable easy removal, this also being facilitated by the electrical connections between the mechanism and the base being made by means of jacks.

A pair of coupled switches are placed on the front face of the base directly under the transmitter mechanism. In the "off" position the current to the motor is switched

off, and the line is connected to key line. In the "on" position the mains are connected to the motor, and the line is connected direct to the transmitting mechanism.

The switch coupling bar also operates a clutch which uncouples the transmitter mechanism in the "off" position. The tape in the transmitter mechanism will thus be stopped immediately the switches are thrown.

The speed regulator consists of a combination of two governors and these are adjusted to the speed required by turning a knurled disc on which the dial is fixed. The speed range is covered in steps of 1 word per minute from 13 to 30 w.p.m., and in steps of 5 words per minute from 30 to 250 w.p.m., but only the range 15—240 w.p.m. is marked on the dial. Turning the dial anti-clockwise beyond the dial marking 15 w.p.m., two further speeds of 14 and 13 w.p.m. are obtained; 245 and 250 w.p.m. are obtained by turning the dial clockwise beyond the dial marking 240. The speed calibration is based on a standard word equal in length to 25 centreholes of tape.

For D.C. operation a shunt motor is employed, whereas for A.C. mains an induction motor is used. Both motors run at approximately 2,850 r.p.m., and a fixed gear in the speed regulator ensures that the regulator main shaft speed is well in excess of the maximum spindle speed of the transmitter.

A small reduction of the maximum speed obtainable may, however, result on D.C. if the voltage drop is greater than 20 per cent.

In the case of two-voltage D.C. motors, the motor speed at the higher voltage is higher than indicated above.

External connections from the main base are by plugs and sockets. A 3-pin plug and socket is used for the mains, the third pin being for earth connection of the metal parts of the transmitter, etc., and a 4-pin plug and socket is employed for line and key line and for the spacing and marking terminals of the telegraph battery.

OPERATION

TRANSMITTER MECHANISM

The two peckers are alternately given an up and down motion by a twin eccentric against which the bell cranks are pressed by the bell crank spring. When the peckers impinge on the tape, the bell crank spring allows the upward motion of the bell cranks to be arrested.

Each bell crank carries a push rod with a thrust collet which reverses the armature when a pecker is allowed to move upwards. Reversal of the armature allows the contact



CATHODE-RAY OSCILLOGRAMS SHOWING REVERSALS AT 120 W.P.M. (LEFT) AND AT 240 W.P.M. (RIGHT). NOTE THE SHORT TRANSIT TIME AND THE COMPLETE ABSENCE OF REBOUND.

spring to press against the marking or the spacing contact screw according to whether the marking or the spacing pecker has been allowed to complete its upward motion. The contact spring will remain on the corresponding contact screw, as the armature will be held by the attraction of the bias magnet, until a perforated hole in the tape allows the other pecker to move upwards whereby the position of the armature and the contact spring is reversed.

The use of magnetic bias eliminates wear and the consequent replacement of parts due to the downward pressure associated with the normal mechanical jockey construction.

The contact spring, together with its bearing, can be easily removed by unscrewing a single screw. The contact screws are also designed for easy removal, this being effected by unscrewing the screw holding the top clamping piece.

SPEED REGULATOR

The design of the speed regulator is based on the fact that a centrifugal governor operating in conjunction with a slipping clutch ensures a remarkably constant speed for light drives. In order to obtain the very wide range required, two centrifugal governors have been combined, one controlling the speed from 13 to about 80 w.p.m. and the other operating over the remaining part of the speed range.

The collars of the two governor sections are forced apart by means of the governor springs. Two of the collars are free to slide horizontally on the grooved governor spindle while the third, the control collar, is positioned on the spindle by the cam acting on the control bar. A feather in the control collar causes the spindle to rotate with it.

The governor spindle is supported by two ball-bearings, one rotating with the main shaft driving disc and the other fixed in the output end of the frame. The transmitter is driven by the governor spindle projecting through this end of the frame. At rest, both governor springs are equally compressed by the control bar arm, the control bar being held against the cam by means of a spring. Actually, the ball bearing stud of the control bar may not touch the cam until the regulator is revolving. On starting the motor, the governor spindle will be driven owing to the friction between the cork disc on the main shaft driving disc and the friction disc of the centrifugal unit. The centrifugal force acting on the governor masses will tend to draw the collars of the governor sections together against the force of the governor springs. The pressure of the friction disc against the cork disc will thus decrease and adjust the friction to a value which will drive the centrifugal unit—and with it the transmitter mechanism—at a constant speed as determined by the position of the cam. At high speeds the collars of the low speed governor section will close up and the high speed governor section alone will be active.

Ball bearings are provided throughout, thus eliminating the necessity for frequent lubrication.

In order to ensure accuracy in setting the speed control cam, a click disc with a circular series of holes is fixed under the disc knob in a definite position relative to the cam. Projecting through the top cover is a spring loaded steel pin which engages one of the holes in the click disc and locks the cam. Each hole in the click disc corresponds to a speed setting as indicated on the dial. When returning to any speed setting, after a temporary excursion to a different setting, exactly the same speed as before is therefore always obtained.

In the transmitter mechanism is incorporated a vibrating reed, which is operated by the eccentric driving spindle sleeve when the cover of the transmitter mechanism is removed. This enables the correctness of the adjustment of the speed regulator to be conveniently checked, as explained later.

DISMANTLING

TRANSMITTER MECHANISM

The transmitter mechanism may be dismantled by removing the following parts in the order stated below :

- The front glass. This will fall forward when the front glass clamping screw is released.
- The cover for the mechanism.
- The guide roller fork with guide roller.
- The tape platform.
- The pecker distance boss.
- The pecker springs.
- The bell crank spring.
- The bell cranks with peckers and pushrods.
- The contact spring together with its bearing.

The armature together with its bearing.

The contact screws.

The tape feed spindle. This is withdrawn after loosening the two set screws on the tape feed gear wheel boss, and

The tape feed gear wheel and spindle sleeve will now fall out.

The transmitter coupling flange on the driving spindle.

The front plate ball bearing retaining plate.

The driving spindle with the twin eccentric.

The front plate. Remove the two screws fixing this plate to the base plate and the four large screws which hold front and back plates together, also loosen one of the bias adjusting screws for the bias magnet.

The reed actuating bar and spring.

The bias magnet.

SPEED REGULATOR

After removing the transparent side covers, the speed regulator, without detaching it from the main base, may be partly dismantled as follows :

The governor spindle with its ball bearing may be pulled out after unscrewing the fixing screws of the outer retaining plate for the ball bearing in the output end of the frame.

The centrifugal unit is now entirely free and may be removed from the frame, preferably by pulling the friction disc end out first.

The component parts of the centrifugal unit may now be separated as desired.

By unscrewing the disc knob screw, the undermentioned parts will separate in the following order :

The disc knob with dial and click disc, disc knob stop lever, the cam c.p., control bar retaining plate, and control bar c.p.

The click pin spring and click pin may be removed after removal of the disc knob.

In order to remove the gear at the driving end, the speed regulator should first be detached from the main base. The main shaft, with its pinion and driving disc, should be removed before the driving shaft with its 50-teeth gear wheel. The ball bearing in the main shaft driving disc may be removed by first removing the retaining plate for the ball bearing.

REASSEMBLING

TRANSMITTER MECHANISM

This is carried out in the reverse order to the dismantling.

Care should be taken to ensure that the back of the armature spindle will not touch the front plate of the transmitter mechanism.

The transmitter coupling flange should be pushed up against the shoulder on the driving spindle and fixed securely by its grub screw.

SPEED REGULATOR

This is carried out in reverse order to the dismantling.

It will be found that the relative position of the disc knob with dial and the cam is governed by steady pins, so that it is only possible to choose one of two positions for the disc knob. The correct position is obtained by allowing the control bar ball bearing stud to sink into the concave recess provided on the cam and replacing the disc knob so that the

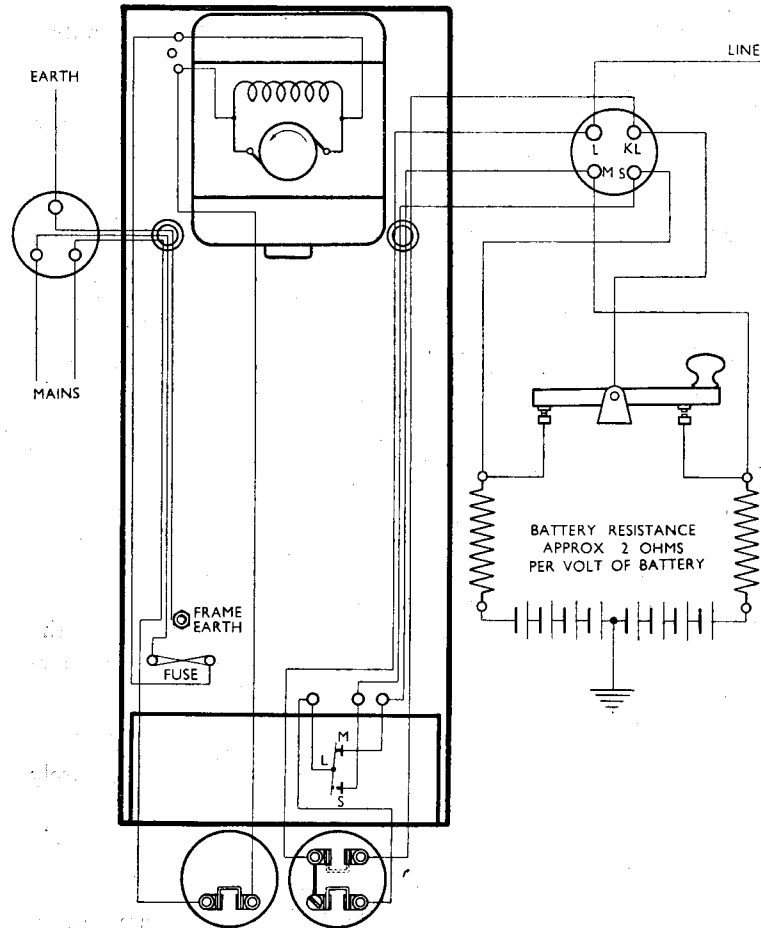

INTERNAL WIRING DIAGRAM OF TRANSMITTER WITH D.C. MOTOR.

NOTE THAT ONLY THE TWO OUTER PINS OF THE 3-PIN MOTOR PLUG ARE EMPLOYED.

EXTERNAL CONNECTIONS AS NORMALLY USED.

figure 240 on the dial is in line with the index stud. See that the disc knob stop lever is in its extreme left position before the disc knob is located as above.

When reassembling the centrifugal unit it is important to note that the centre collar should have its rounded shoulders pointing towards the friction disc.

Care should be taken to see that the lock nuts for the pivot pins in the collars are tightened securely.

With the dial turned to indicate the lowest speed, the complete centrifugal unit is placed in its approximate position with the control arm circular guide gripping the end of the control bar arm, whereupon the governor spindle, with its ball bearing attached, is pushed through the hole in the frame and through the centrifugal unit, taking care that the feather fixed in the control collar slides into the groove in the governor spindle.

The end of the spindle will be found to enter the ball bearing in the main shaft driving disc with a smooth resistance, due to the small spring in the main shaft driving disc ball bearing centre bush. This spring is fitted to ensure that the inner race will revolve with the spindle.

Leave a clearance of about $\frac{1}{8}$ " between the output end outer retaining plate and the transmitter coupling flange, regulator end, before the latter is fixed firmly by its grub screw to the governor spindle.

NOTE.—Before coupling the motor to the speed regulator, make sure that the motor turns anti-clockwise, as seen from the coupling, see note under diagram, p. 14.

After fitting the speed regulator to the main base, check, with transmitter mechanism in place and the switches in the "off" position, that there is a clearance of about $\frac{1}{8}$ " between the transmitter coupling flange, regulator end, and the transmitter coupling link. Adjustment is made by altering

the position of the clutch actuating fork on the clutch actuating bar. In the "on" position, there should be a clearance of about $\frac{1}{16}$ " between the transmitter coupling link and the transmitter coupling flange, transmitter end. Adjustment is made by slightly bending the clutch actuating fork.

ADJUSTMENTS

TRANSMITTER MECHANISM

The pecker distance boss, if worn by the peckers, should be turned to a new position and secured by its screw. The peckers, when worn on one side against the pecker distance boss, should be turned round half a turn.

To locate the tape feed teeth, remove the guide roller fork temporarily and loosen the two set screws in the tape feed gear wheel boss (112/63). Tape feed spindle (112/61A) is now free to rotate independently of tape feed gear wheel (112/62A). Turn the tape feed gear wheel with the finger until the spacing pecker is in its highest position and press a tape with signal holes down into the recess in the tape platform to engage the tape feed teeth. Keeping the tape feed gear wheel stationary with the finger, adjust the tape feed spindle slightly by pressing a tooth gently to the left or the right with the tip of a screw driver until the pecker is just seen to be pushed forward by the back (right hand) edge of a hole, see sketch. This can be most easily observed by noticing when the pecker just ceases to press against the pecker distance boss. Tighten up the two set screws fixing the tape feed spindle, the teeth of which should now lie centrally in the middle slot of the tape platform.

The tension of the bell crank spring should be approximately 300 g (10½ ozs.). To check this, place the pointer of the spring gauge on the right hand side of the vertical lever of the spacing bell crank in line with the anchor pin

for the bell crank spring and press it to the left. Turn the spring gauge so that it applies an increasing pressure. The bell crank should just cease to make contact with the twin eccentric when the gauge indicates approximately the required tension.

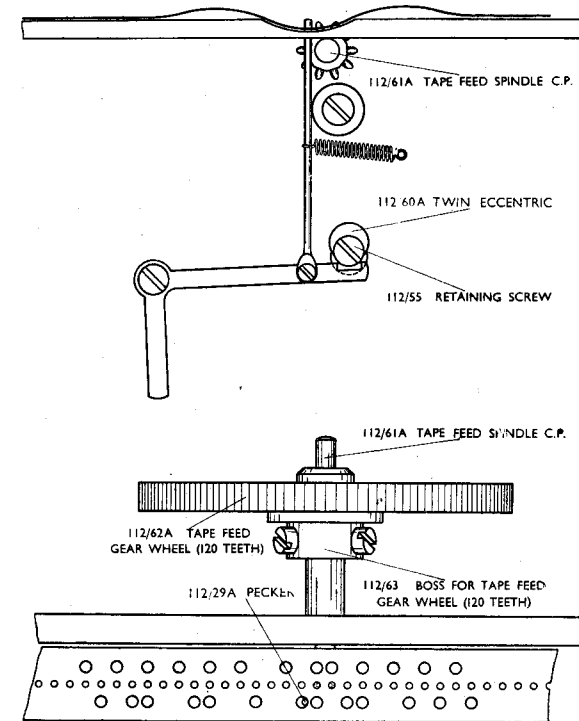

Bias adjustment of the contact mechanism is carried out by proceeding as follows :—

(1) Withdraw the push rods from the guide plate in the armature bearing, leaving the collets resting against the face of the guide plate. Having eased the clamping screws in the contact screw holders, turn the contact screws well back so that they do not touch the contact spring. Now adjust the bias screws for the bias magnet so that the armature

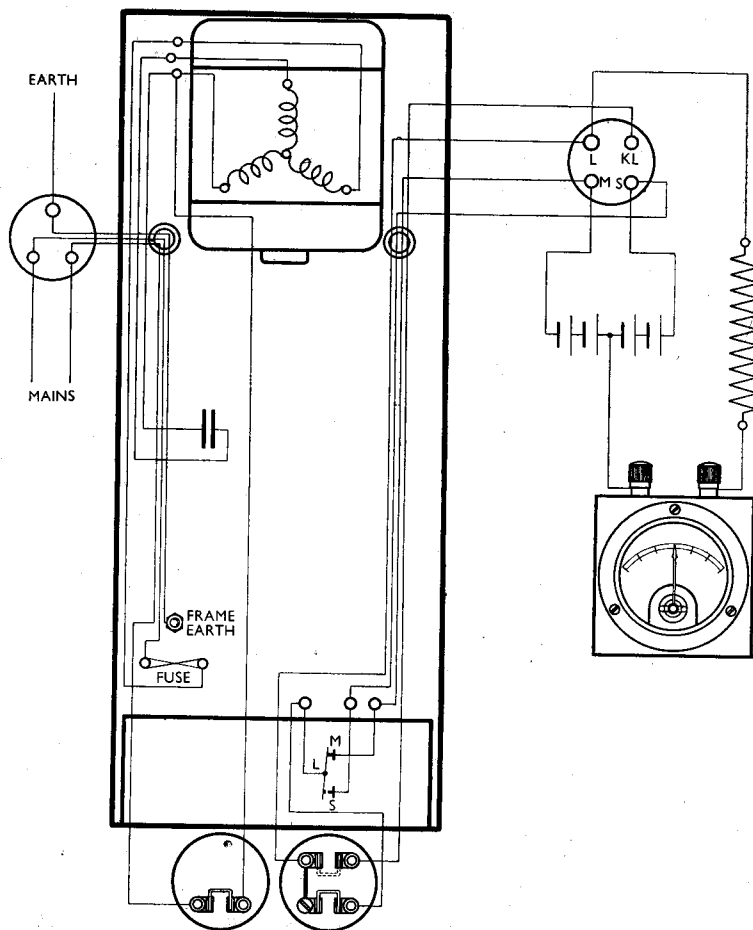

INTERNAL WIRING DIAGRAM OF TRANSMITTER WITH A.C. MOTOR.

NOTE THAT REVERSING ANY TWO OF THE THREE MOTOR CONNECTIONS TO THE 3-PIN MOTOR PLUG WILL EFFECT A REVERSAL OF THE DIRECTION OF ROTATION OF THE MOTOR SPINDLE.

EXTERNAL CONNECTIONS AS USED FOR ZERO BIAS TEST.

stops press equally against either of the lower poleshoes. Use the spring gauge for this adjustment. The pressure to either side when measured at the extreme top end of the armature should be approximately 80 g (3 ozs.).

(2) Insert the push rod collets in the guide plate. Unscrew the lock nut for either collet. Deflect the top of the armature to the right. With the marking pecker in its highest position, advance the collet of the marking (top) push rod a quarter of a turn beyond the point where it touches the armature and lock it in this position by tightening up the lock nut for the collet. Repeat this adjustment for the spacing collet with the lower end of the armature deflected to the right and with the spacing pecker in its highest position. When finally adjusted, reversal of the armature should take place when the twin eccentric has turned through exactly half a revolution. By observing the position of the slot in the retaining screw of the twin eccentric this is easily ascertained. If necessary, readjust by advancing one of the thrust collets.

Insert a blank tape in the transmitter and check that the thrust collets do not push the armature. If this is the case, the peckers have become too short due to wear, and they should be renewed. The correct length of new peckers is such that in their lowest position the top of the peckers are just flush with the surface of the recess in the tape platform.

(3) Screw up the marking (top) contact screw so that it just touches the contact spring when the top of the armature is deflected to the right. Use a dry cell and a milliammeter in series with a resistance during this adjustment. Now further advance the contact screw one quarter of a turn and clamp it in this position. Repeat this adjustment for the spacing contact screw with the armature reversed.

Connect the dry cell, milliammeter and resistance across the spacing and marking contact plugs. Turn the tape feed gear wheel with the finger, and if a deflection on the meter is then observed, slightly retract each contact screw an equal amount.

The contact pressure should be approximately 110 g (4 ozs.), but need be checked only occasionally by pressing the spring gauge against the contact spring just beyond the contact butt. If necessary the contact spring bearing should be removed, and the contact spring bent in order to obtain the desired contact pressure.

It is important to see that the ends of the contact spring do not foul the armature sapphire distance collars in either position of the armature. Adjustment may be made by easing the two screws fixing the base plate for the battery switch to the front plate, shifting the former slightly and clamping it in the correct position.

(4) In order to adjust the transmitter to give marking and spacing currents of equal duration, it should be connected up with a split battery, the voltages of the two halves of which are exactly equal, and with a centre-zero galvanometer, or milliammeter, and a suitable resistance between the line terminal and the centre of the battery. Two or four dry cells may be used as a split battery. With the transmitter running at a speed in the vicinity of the highest actual working speed, a final adjustment of the contact screws is then made until the meter shows dead zero.

For routine adjustments only the procedure under (3) and (4) is necessary, but it will be as well to check that reversal of the armature takes place at positions of the twin eccentric spaced 180° apart with the contact screws withdrawn, as mentioned under (2).

The distance between the guide roller and the tape platform has been set at the factory to equal three thicknesses of tape. If this distance should alter due to wear, readjustment may be effected by turning the eccentric stop nut behind the front plate.

SPEED REGULATOR

The speed regulator's main shaft, with its pinion and driving disc, is mounted inside an adjustable sleeve for the

purpose of readjusting the speed in accordance with the wear on the cork clutch. Two cross-holed screws in the flange of the sleeve are provided for this adjustment.

To adjust or check the dial indications proceed as follows :—

Remove the cover of the transmitter mechanism, start the motor, set the dial at 120 words per minute and screw out the left-hand cross-holed screw half a turn or more. Now carefully note the deflections of the reed vibrating inside the transmitting mechanism, while slowly turning the right-hand cross-holed screw inward. If the deflection is thereby increased continue to screw inward until the highest deflection is obtained. If, however, the deflections decrease, or after the deflections have reached their maximum commence to decrease, loosen the right-hand screw and tighten the left-hand one while watching the reed as before, until maximum deflections are obtained. Finally, lock the sleeve in the position obtained by tightening up the screw which was first slackened.

MAINTENANCE

TRANSMITTER MECHANISM

The bias magnet should be kept free from dust. It is especially important to see that iron filings do not find their way into the air gaps between the poleshoes and the armature.

Dust and paper fluff collecting round the peckers should be brushed away daily.

Contacts.

The platinum contact surfaces of the contact screws and the contact spring should be burnished occasionally, depending on the amount of use. Only in cases of bad pitting should the superfine contact file surface of the burnishing tool be used prior to burnishing.

The platinum surfaces of the contact screws should be slightly convex, and if a small lathe is available, it will

be found convenient to fit the contact screws in this machine while burnishing. The platinum points of the contact spring should be burnished rather flat and it should not be necessary to remove the contact spring from its bearing during this operation.

Lubrication.

The felt oiling pad for the twin eccentric should always be kept supplied with oil.

A drop or two of a good quality medium oil should be applied to the bearings once a week. It will be found convenient to use a thin metal wire dipped in oil for this purpose. The guide roller, the bell crank bosses and the armature bearings are provided with lubricating holes.

The ball bearings for the driving spindle in the transmitter mechanism should be lubricated with grease.

SPEED REGULATOR

When the circular series of holes in the click disc is worn, the disc can be turned over so that the unworn ends of the holes are in use.

In the course of time wear of the cork disc may be expected to lower the speed. Even with constant use, however, it will be found that the wear is very small, and all that is necessary is to check the reference speed of 120 w.p.m. at intervals of, say, three months. If required, adjustment should be effected as mentioned in the previous section.

When, eventually, the adjustable sleeve can no longer travel inwards, the cork disc must be renewed.

To fit this, only the centrifugal unit need be removed, as previously described, giving access to the face of the main shaft driving disc. The old cork disc can now be removed with a knife, the driving disc well cleaned and a new disc glued on.

A cellulose adhesive such as Durofix is suitable for all climates, while Seccotine or a similar glue can be used if the atmosphere is not damp.

The new cork disc must now be trimmed with a file for true running. To do this, start the motor, rest the file on the speed regulator frame and press it lightly against the disc.

After re-assembly the correct position of the adjustable sleeve should be found by means of the vibrating reed, as previously mentioned.

Lubrication.

The ball bearing for the governor spindle in the main shaft driving disc should be oiled with a good quality medium oil, 2 or 3 drops a month. This can be done without dismantling, viz. :—

Remove one side cover, turn the disc knob to the lowest speed and pull the centrifugal unit's friction disc towards the output end by gripping the high speed governor arm linkage, so as not to bend the friction disc vanes. The bearing is now visible, and the oil can be applied with a thin wire.

It is recommended to dismantle the instrument completely at six-monthly intervals and apply grease to all the other ball bearings. Crimsangere BB No. 1 grease as supplied in the tool kit is recommended. Smear the governor spindle with oil and put a drop of oil on the pivot pins in the centrifugal unit.

It should be noted, that whilst the cork disc requires no oiling, accidentally applied oil has no detrimental effect whatever.

MOTOR

Motors incorporating ball bearings should be lubricated with grease, while a good quality medium oil should be used for motors with plain bearings, in the latter case at frequent intervals. In the case of D.C. motors, the commutator should occasionally be wiped clean with a rag moistened with paraffin.

FUSE

Replacement of fuse wire should be effected by using copper wire approximately 0.002 in. diameter.

TOOL KIT

The tool kit contains the following tools and accessories :—

- 2 112/81 Collet Spanners.
- 1 112/83 Tommy Pin.
- 1 Burnisher.
- 1 Screwdriver 5" × $\frac{1}{8}$ ".
- 1 Screwdriver 5" × $\frac{1}{4}$ ".
- 1 Oil Can.
- 1 Pair of Tweezers.
- 1 Bottle of Oil.
- 1 Tin of Grease.
- 1 G.N.T.Co. Spring Gauge Model 2046.
- 1 Instruction Booklet.

SPARE PARTS LIST

FOR

G.N.T.Co. TRANSMITTER MODEL 112

INCORPORATING

SPEED REGULATOR MODEL 2042

On the following pages are shown drawings of a number of spare parts, and parts lists are given for both transmitter and speed regulator. In some cases, the letters c.p. are added to indicate a part consisting of two or more separate parts assembled together.

When ordering spare parts, please give the number of each part and the serial number of the instrument for which they are required.

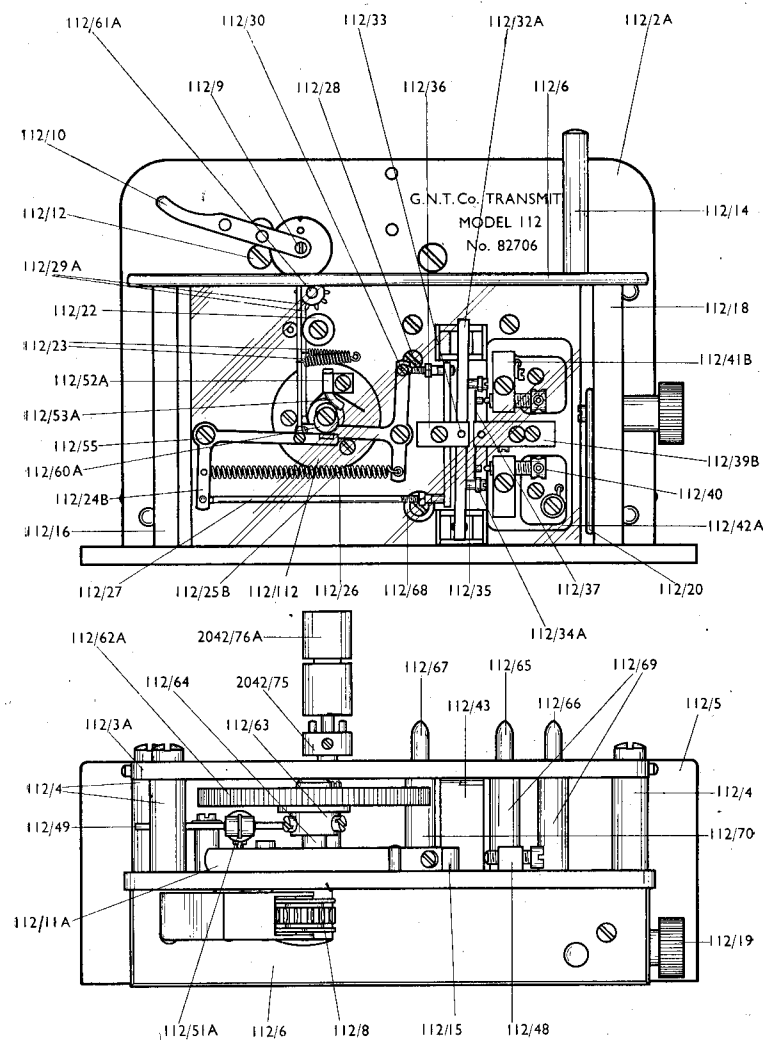

112/1 TRANSMITTER MECHANISM C.P.

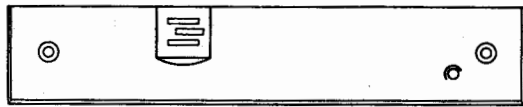

112/6 TAPE PLATFORM (12 MM TAPE)

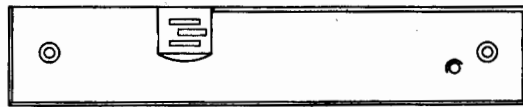
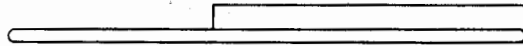

112/7 TAPE PLATFORM C.P. (9.5 MM TAPE)

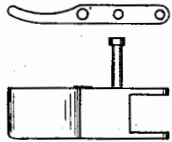

112/10 GUIDE ROLLER FORK. C.P.

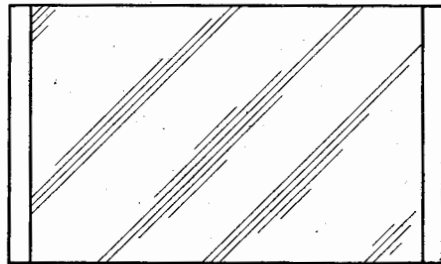

112/13 FRONT GLASS

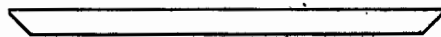

112/8 GUIDE ROLLER



112/9 GUIDE ROLLER SPINDLE



112/12 ECCENTRIC STOP NUT WITH SCREW



112/14 GUIDE PIN



112/19 FRONT GLASS CLAMPING SCREW

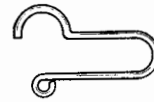

112/20 FRONT GLASS SPRING



112/26 BELL CRANK SPRING (300g)



112/27 PUSH ROD WITH THRUST COLLET SPACING C.P.



112/28 PUSH ROD WITH THRUST COLLET MARKING C.P.

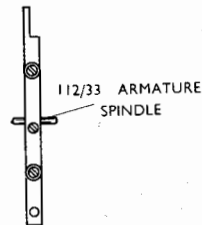

112/33 ARMATURE SPINDLE

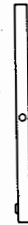

112/31 ARMATURE ASSEMBLY



112/39B CONTACT SPRING BEARING C.P.



112/29A PECKER



112/23 PECKER SPRING

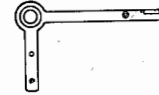

112/24B BELL CRANK, SPACING C.P.



112/30 PIVOT SCREW FOR PECKERS AND PUSHRODS



112/37 CONTACT SPRING C.P.



112/40 CONTACT SCREW



112/22 PECKER DISTANCE BOSS

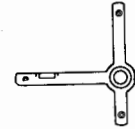

112/25B BELL CRANK, MARKING C.P.

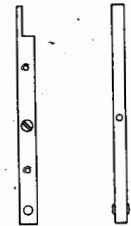

112/32A ARMATURE C.P.

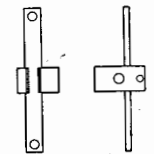

112/36 ARMATURE BEARING C.P.



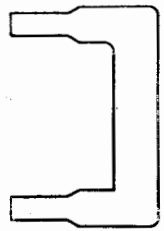

112/43 BIAS MAGNET

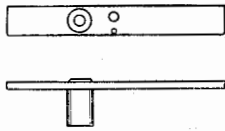

112/49 REED ACTUATING LEVER C.P.



112/50 REED ACTUATING LEVER SPRING



112/51A REED C.P.



112/60A TWIN ECCENTRIC



112/55 RETAINING SCREW

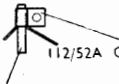

112/52A OILING PAD HOLDER



112/56A DRIVING SPINDLE ASSEMBLY

112/53A OILING PAD



112/61A TAPE FEED SPINDLE C.P.



112/64 TAPE FEED SPINDLE SLEEVE C.P.



112/63 BOSS FOR TAPE FEED GEAR WHEEL (120 TEETH)

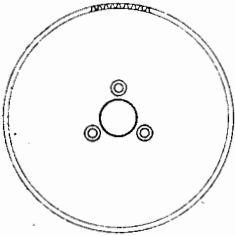

112/62A TAPE FEED GEAR WHEEL (120 TEETH)



112/73 SPRING JACK ASSEMBLY

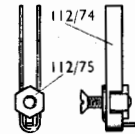

112/72A SPRING CLIP FOR MECHANISM

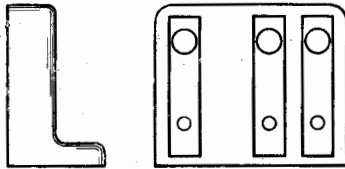

112/76 SPRING JACK SUPPORT



112/79 SPINDLE BUSH

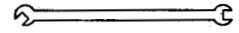

112/81 SPANNER



112/84 CLUTCH ACTUATING BAR C.P.



112/83 TOMMY PIN

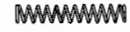

112/86 CLUTCH ACTUATING BAR SPRING

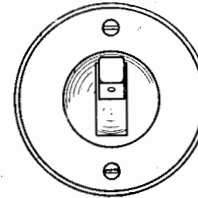

112/89 LINE SWITCH C.P.

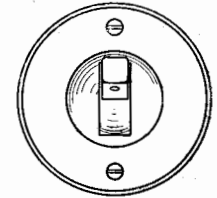

112/90 MAINS SWITCH C.P.

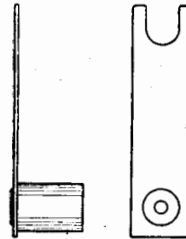

112/88A CLUTCH ACTUATING FORK C.P.

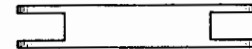

112/91 SWITCH COUPLING BAR

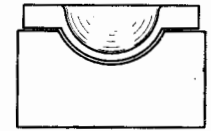

112/92 FUSE C.P.

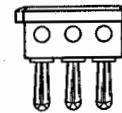

112/97 MOTOR PLUG C.P.

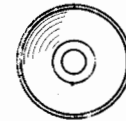

112/107 RUBBER FOOT



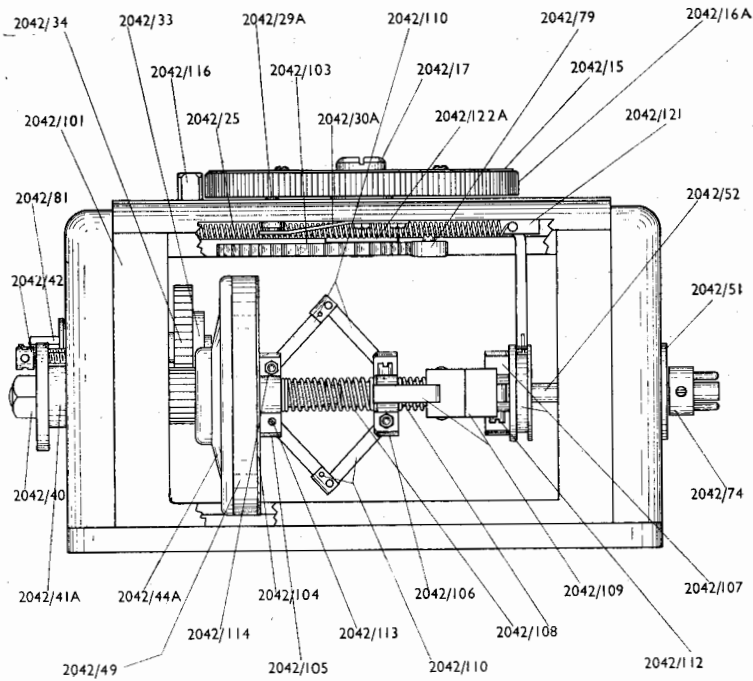

2042/1A SPEED REGULATOR C.P.

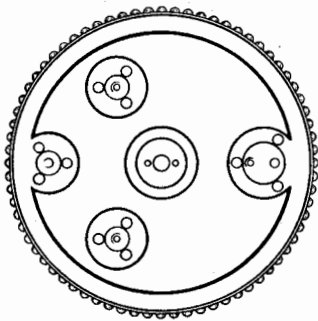

2042/16A DISC KNOB C.P.

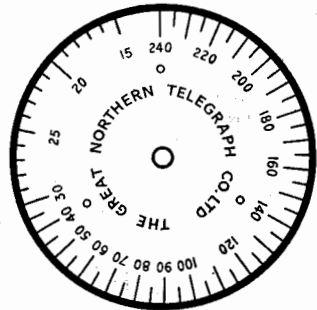

2042/15 DIAL

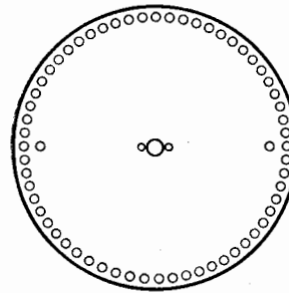

2042/18 CLICK DISC



2042/103 CAM C.P.

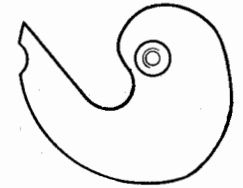

2042/17 DISC KNOB SCREW



2042/29A CLICK PIN

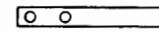

2042/30A CLICK PIN SPRING



2042/32 DRIVING SHAFT



2042/34 DRIVING SHAFT GEAR WHEEL (50 TEETH)

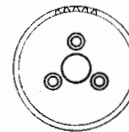

2042/33 DRIVING SHAFT GEAR WHEEL BOSS

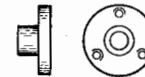

2042/35 DRIVING SHAFT INNER DISTANCE COLLAR



2042/37 MAIN SHAFT



2042/38 MAIN SHAFT INNER DISTANCE COLLAR

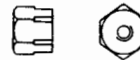

2042/40 MAIN SHAFT HEXAGON NUT

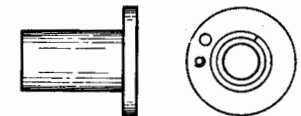

2042/41A MAIN SHAFT ADJUSTABLE SLEEVE C.P.

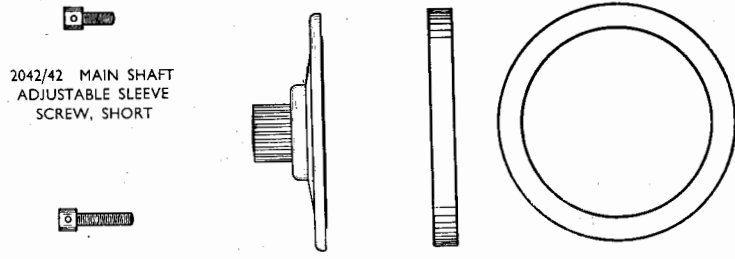

2042/42 MAIN SHAFT
ADJUSTABLE SLEEVE
SCREW, SHORT

2042/43 MAIN SHAFT
ADJUSTABLE SLEEVE
SCREW, LONG

2042/44A MAIN SHAFT
DRIVING DISC C.P.

2042/49 CORK DISC



2042/52 GOVERNOR SPINDLE C.P.

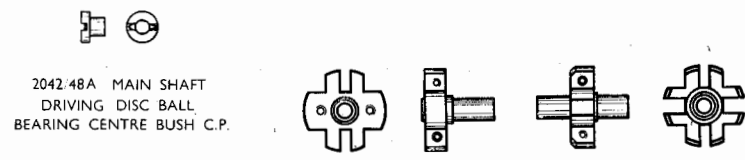

2042/48A MAIN SHAFT
DRIVING DISC BALL
BEARING CENTRE BUSH C.P.

2042/105 FRICTION DISC
COLLAR C.P.

2042/106 CENTRE
COLLAR C.P.

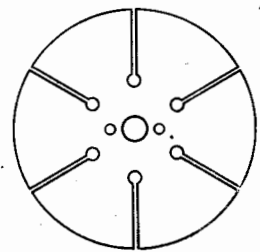

2042/104 FRICTION DISC

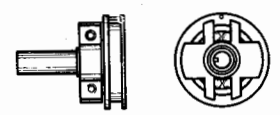

2042/107 CONTROL COLLAR C.P.



2042/108 GOVERNOR SPRING

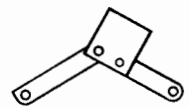

2042/109 GOVERNOR ARM
LINKAGE, LOW SPEED C.P.



2042/110 GOVERNOR ARM
LINKAGE, HIGH SPEED C.P.



2042/111 PIVOT PIN,
LOW SPEED

2042/112 PIVOT PIN
LOCK NUT,
LOW SPEED

2042/113 PIVOT PIN,
HIGH SPEED

2042/114 PIVOT PIN
LOCK NUT,
HIGH SPEED

2042/80 MOTOR
COUPLING,
MOTOR END C.P.

2042/81 MOTOR
COUPLING,
REGULATOR END C.P.

2042/74 TRANSMITTER
COUPLING FLANGE,
REGULATOR END C.P.

2042/75 TRANSMITTER
COUPLING FLANGE,
TRANSMITTER END C.P.



2042/82 MOTOR
COUPLING LINK



2042/76 TRANSMITTER
COUPLING LINK

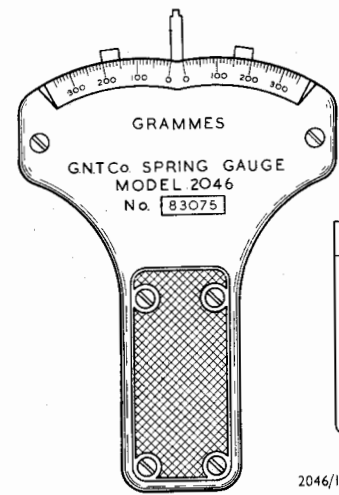

2046/101 SPRING GAUGE C.P.
FRONT

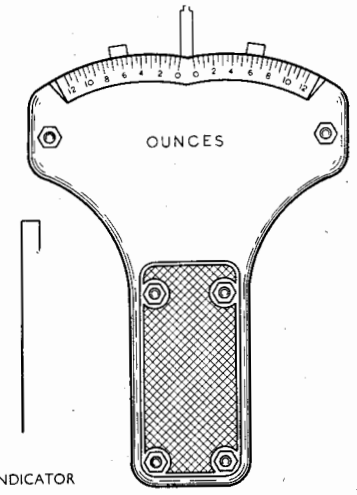

2046/101 SPRING GAUGE C.P.
BACK

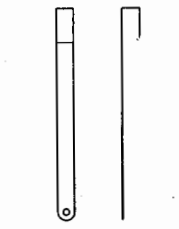

2046/109 INDICATOR



2046/111 SPRING C.P.

G.N.T.Co. TRANSMITTER

MODEL 112

PARTS LIST

112/1	Transmitter mechanism c.p.	112/31	Armature assembly.
112/2A	Front plate c.p.	112/32A	Armature c.p.
112/3A	Back plate c.p.	112/33	Armature spindle.
112/4	Distance piece.	112/34A	Armature sapphire.
112/5	Base plate.	112/35	Armature sapphire distance collar.
112/6	Tape platform (12 mm. tape).	112/36	Armature bearing c.p.
112/7	Tape platform c.p. (9.5 mm. tape).	112/37	Contact spring c.p.
112/8	Guide roller.	112/39B	Contact spring bearing c.p.
112/9	Guide roller spindle.	112/40	Contact screw c.p.
112/10	Guide roller fork c.p.	112/41B	Contact screw holder c.p.
112/11A	Guide roller spring.	112/42A	Base plate for battery switch c.p.
112/12	Eccentric stop nut with screw.	112/43	Bias magnet.
112/13	Front glass.	112/48	Bias adjusting screw holder.
112/14	Guide pin.	112/49	Reed actuating lever c.p.
112/15	Guide roller spring support.	112/50	Reed actuating lever spring.
112/16	Left-hand glass support.	112/51A	Reed c.p.
112/17	Right-hand glass support.	112/52A	Oiling pad holder.
112/18	Front glass clamp.	112/53A	Oiling pad.
112/19	Front glass clamping screw.	112/55	Retaining screw.
112/20	Front glass spring.	112/56A	Driving spindle assembly.
112/22	Pecker distance boss.	112/60A	Twin eccentric.
112/23	Pecker spring.	112/61A	Tape feed spindle c.p.
112/24B	Bell crank, spacing c.p.	112/62A	Tape feed gear wheel (120 teeth).
112/25B	Bell crank, marking c.p.	112/63	Boss for tape feed gear wheel (120 teeth).
112/26	Bell crank spring (300 g).	112/64	Tape feed spindle sleeve.
112/27	Push rod with thrust collet, spacing c.p.	112/65	Connecting plug, spacing.
112/28	Push rod with thrust collet, marking c.p.	112/66	Connecting plug, marking.
112/29A	Pecker.	112/67	Connecting plug, line.
112/30	Pivot screw for peckers and push rods.	112/68	Connecting plug insulating washer.

112/69	Connecting plug insulating sleeve, spacing and marking.	112/92	Fuse c.p.
112/70	Connecting plug insulating sleeve, line.	112/93	D.C. motor c.p. State voltage.
112/71A	Main base c.p.	112/94	A.C. motor c.p. State voltage.
112/72A	Spring clip for mechanism c.p.	112/95	Motorbase, concave top.
112/73	Spring jack assembly.	112/96	Motor base, flat top.
112/74	Spring jack.	112/97	Motor plug c.p.
112/75	Spring jack clamping nut.	112/99	Condenser for A.C. motor. State particulars on nameplate of motor.
112/76	Spring jack support.	112/100	Condenser clamping strap.
112/79	Spindle bush.	112/101	Mains plug, 3-pin c.p.
112/81	Spanner.	112/102	Mains socket, 3-pin c.p.
112/83	Tommy pin.	112/103A	4-pin plug for line, etc., c.p.
112/84	Clutch actuating bar c.p.	112/104A	4-pin socket for line, etc., c.p.
112/86	Clutch actuating bar spring.	112/106	Cover for mechanism c.p.
112/88A	Clutch actuating fork c.p.	112/107	Rubber foot.
112/89	Line switch c.p.	112/112	Front plate ball bearing retaining plate.
112/90	Mains switch c.p.	112/113	Mechanism slide c.p.
112/91	Switch coupling bar.		

G.N.T.Co. SPEED REGULATOR

MODEL 2042

PARTS LIST

2042/1A	Speed regulator c.p.	2042/34	Driving shaft gear wheel (50 teeth).
2042/15	Dial.	2042/35	Driving shaft inner distance collar.
2042/16A	Disc knob c.p.	2042/37	Main shaft.
2042/17	Disc knob screw.	2042/38	Main shaft inner distance collar.
2042/18	Click disc.	2042/40	Main shaft hexagon nut.
2042/25	Control bar spring.	2042/41A	Main shaft adjustable sleeve c.p.
2042/29A	Click pin.	2042/42	Main shaft adjustable sleeve screw, short.
2042/30A	Click pin spring.		
2042/32	Driving shaft.		
2042/33	Driving shaft gear wheel boss.		

2042/43	Main shaft adjustable sleeve screw, long.	2042/82	Motor coupling link.
2042/44A	Main shaft driving disc c.p.	2042/101	Speed regulator frame c.p.
2042/47A	Main shaft driving disc ball bearing retaining plate.	2042/102	Side cover.
2042/48A	Main shaft driving disc ball bearing centre bush c.p.	2042/103	Cam c.p.
2042/49	Cork disc.	2042/104	Friction disc.
2042/51	Output end, outer retaining plate for ball bearing.	2042/105	Friction disc collar c.p.
2042/52	Governor spindle c.p.	2042/106	Centre collar c.p.
2042/74	Transmitter coupling flange, regulator end, c.p.	2042/107	Control collar c.p.
2042/75	Transmitter coupling flange, transmitter end, c.p.	2042/108	Governor spring.
2042/76A	Transmitter coupling link.	2042/109	Governor arm linkage, low speed c.p.
2042/77	Ball bearing, $\frac{3}{16}$ " bore.	2042/110	Governor arm linkage, high speed c.p.
2042/78	Ball bearing, $\frac{1}{4}$ " bore.	2042/111	Pivot pin, low speed.
2042/79	Ball bearing, $\frac{1}{8}$ " bore.	2042/112	Pivot pin lock nut, low speed.
2042/80	Motor coupling stud, motor end c.p.	2042/113	Pivot pin, high speed.
2042/81	Motor coupling stud, regulator end c.p.	2042/114	Pivot pin lock nut, high speed.
		2042/116	Index stud.
		2042/117	Disc knob stop lever.
		2042/118	Output end, inner retaining plate for ball bearing.
		2042/121	Control bar c.p.
		2042/122A	Control bar retaining plate.

G.N.T.Co. SPRING GAUGE

MODEL 2046

PARTS LIST

2046/101	Spring gauge c.p.	2046/107	Clamping bar, $\frac{3}{16}$ " \times $\frac{3}{8}$ "
2046/102	Front cover.	2046/108	Clamping bar, $\frac{1}{8}$ " \times $\frac{3}{16}$ "
2046/103	Back cover.	2046/109	Indicator.
2046/106	Clamping screw support.	2046/110	Indicator pivot pin.
		2046/111	Spring c.p.