

# **High Tones, Low Tones, Modem Tones**

## **What Are They and What Do They Mean?**

BY BILL HENRY\*, K9GWT



**HAL COMMUNICATIONS CORP.**

BOX 365  
URBANA, ILLINOIS 61801

**If you're satisfied with just learning buzz words, keep on going. If you would like to actually and quite painlessly learn what these words mean, then read K9GWT's informative article on RTTY tones.**

# High Tones, Low Tones, Modem Tones

## What Are They and What Do They Mean?

BY BILL HENRY\*, K9GWT

**O**ur RTTY hobby has grown a lot in the past ten years, and we have added many features and terms that, while they certainly expand the usefulness of our equipment, also generate a certain amount of confusion. One of the most confusing RTTY concepts for both newcomers and old-time RTTY operators is this business of RTTY tones: "high," "low," "modem," and "IARU" tones.

### Why Use Tones?

Many of the early amateur radio RTTY techniques were adapted from existing standards developed for commercial printing telegraph systems. The use of audio tones and the frequency of the tones evolved from existing commercial standards. The RTTY data from the keyboard is actually a series of pulses of current or voltage. The "standard" Baudot teleprinter hook-up uses a 60 milliamperere current loop, the **Mark** or "rest" machine condition being with current *on* and the **Space** condition with current *off* (somewhat "upside down" from what you might think). On a telephone line, this information can be transmitted simply by opening and closing a series circuit. A printer's selector magnets are connected at the other end and the RTTY circuit is complete. However, when long lines are used, it is much more convenient to send a.c. signals over the telegraph lines because of the relative simplicity of a.c. amplifiers as compared to d.c. amplifiers. Therefore, most long-distance RTTY circuits use two different audio tones to represent the **Mark** and **Space** RTTY conditions. Early amateur RTTY operators used this same tone technique for v.h.f. RTTY communications. A typical RTTY pulse waveform and a frequency diagram of the audio tones used are shown in figs. 1(A) and (B).

When we transmit RTTY on v.h.f., we use these tones to directly modulate the f.m. or a.m. transmitter to produce the F2 or A2 type emission. (F2 emission is audio tone modulation of a frequency modulated signal; A2 is audio tone modulation of an amplitude modulated signal.) Two different audio tone frequencies are used to

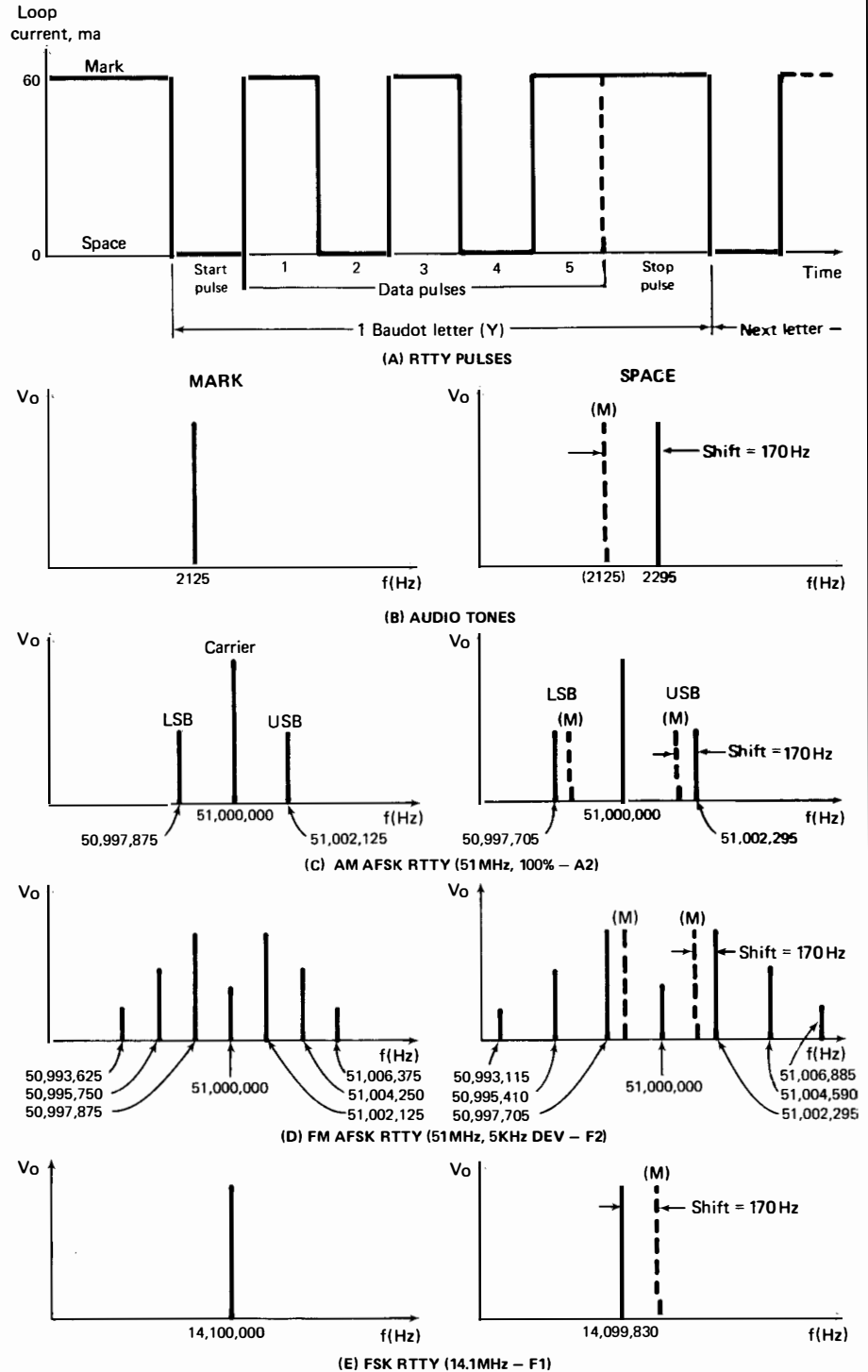

Fig. 1 - A visualization of Audio Frequency Shift Keying (AFSK) and Frequency Shift Keying (FSK) RTTY. See text for details.

\*Box 365, Urbana, Illinois 61801

represent the RTTY mark and space conditions; the difference between them is called the "RTTY Shift Frequency" (**Shift** for short). This technique is commonly called **AFSK** (**A**udio **F**requency **S**hift **K**eying). Notice that you need two electronic interfaces to the v.h.f. station: (1) a tone encoder (audio oscillator) that converts the transmit mark and space pulses into mark and space audio tones, and (2) a tone demodulator that converts the mark and space tone frequencies back into keying pulses which drive the RTTY printer. The combination of the transmit tone encoder and receive tone decoder is often called an RTTY **demodulator, tuning unit (TU)**, or **Modem** (computer term for modulator-demodulator). Frequency diagrams for typical 51 MHz a.m. and f.m. RTTY signals are shown in figs. 1(C) and (D).

RTTY operation on the high frequencies (below 30 MHz) is done in a slightly different manner. We are allowed to use only type F1 **FSK** (**F**requency **S**hift **K**eying) for RTTY transmission on the lower frequencies. (F1 emission is the direct shifting of the radio carrier frequency by the RTTY data.) The reason for this restriction is to minimize the bandwidth required by each station in this crowded section of the spectrum. The FSK RTTY signal is transmitted so that the mark condition corresponds to one radio frequency and the space to a lower radio frequency. Note that only one radio signal, at either the mark or space frequency, is transmitted at a time.

To receive this RTTY signal we use a communications receiver with a **b.f.o.** (**b**eat **f**requency **o**scillator) and adjust the frequency dial so that two different audio tones are produced, one for the mark pulse and the other for the space pulse. An RTTY demodulator is then used to recover the RTTY data pulses from the tones, just like for v.h.f. AFSK operation. Note that because we are using the b.f.o. on the receiver, the audio tone frequency produced at the receiver speaker can be controlled simply by turning the receiver frequency dial. Any number of different mark and space tone frequency pairs may be chosen for reception; however, they will all differ in frequency by the same amount—the original difference between the transmitted mark and space radio frequency. This frequency difference is called the **RTTY Shift Frequency**, or **Shift** for short (as in the previous discussion of v.h.f. AFSK operation). A frequency diagram of a 14.100 MHz FSK signal is shown in fig. 1(E). Note that none of the diagrams in fig. 1 present the full frequency spectra; the sidebands caused by the digital switching between the mark and space are omitted for clarity.

From the previous discussion, you can see that there are some similarities and differences between v.h.f. and h.f. amateur RTTY operation. Obviously, since both require use of a receive tone demodulation unit, it is desirable to be able to

use the same unit for reception of both v.h.f. and h.f. RTTY signals. Note that although the tone frequencies produced by the h.f. receiver can be set to most any convenient frequency by adjusting the tuning, the v.h.f. receiver does not have this capability. Since F2 or A2 modulation is used for v.h.f. AFSK, the receiver demodulator frequencies must match the tones transmitted. Therefore, if we are to use the same demodulator for v.h.f. and h.f., we would want to choose a unit that is compatible with the tones used by other stations. Here is where the "great high versus low tone controversy" starts, and

we will discuss it in greater detail shortly. First, however, we need to consider just how h.f. FSK RTTY is generated.

### Transmitting H.F. FSK RTTY

As we discussed above, our h.f. amateur RTTY must be transmitted using type F1 emission, frequency shift keying (FSK). The classic way of generating the FSK RTTY signal is simply to use a circuit that directly shifts the transmitter carrier frequency as the RTTY pulses change between mark and space conditions. In fact, this is the way we generated RTTY for years, and it is still used in some com-

## DATA TERMINAL FOR MULTI-MODE COMMUNICATIONS

ASCII, Baudot, or Morse — the **DS3100ASR** can do them all with a full complement of data rates and interface standards. The DS3100 is designed with the operator in mind; keyboard controls and operating conditions are clearly shown by the triple-legend keytops and on-screen status indicators. The very large display memory (200 lines of 72 characters) and additional "mailbox" storage of the MSO3100 (32,000 characters approximately 450 more lines) allow you to handle your traffic without resorting to paper tape or retyping print-outs. Other outstanding DS3100 features are:

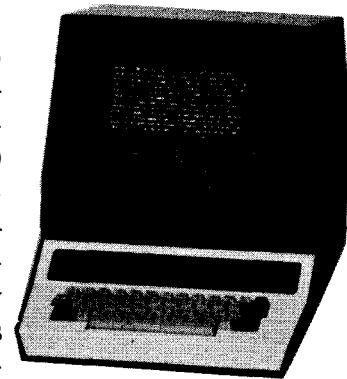

- True "ASR" operation — pretype and edit 50 lines of transmit text on-screen while receiving
- 150 Line receive display buffer
- Baudot from 45 to 100 bd (US or CCITT #2)
- ASCII from 110 to 9600 bd (full or half duplex)
- Morse from 1 to 175 wpm
- Current loop or RS232 modem connector
- WRU, SEL-CAL, and Mailbox (with MSO3100)
- Ten programmable HERE IS messages
- Available for 120V, 60Hz or 220V, 50Hz

Write or call for more details about the DS3100 and MSO3100.



**HAL COMMUNICATIONS CORP.**

BOX 365  
URBANA, ILLINOIS 61801

217-367-7373

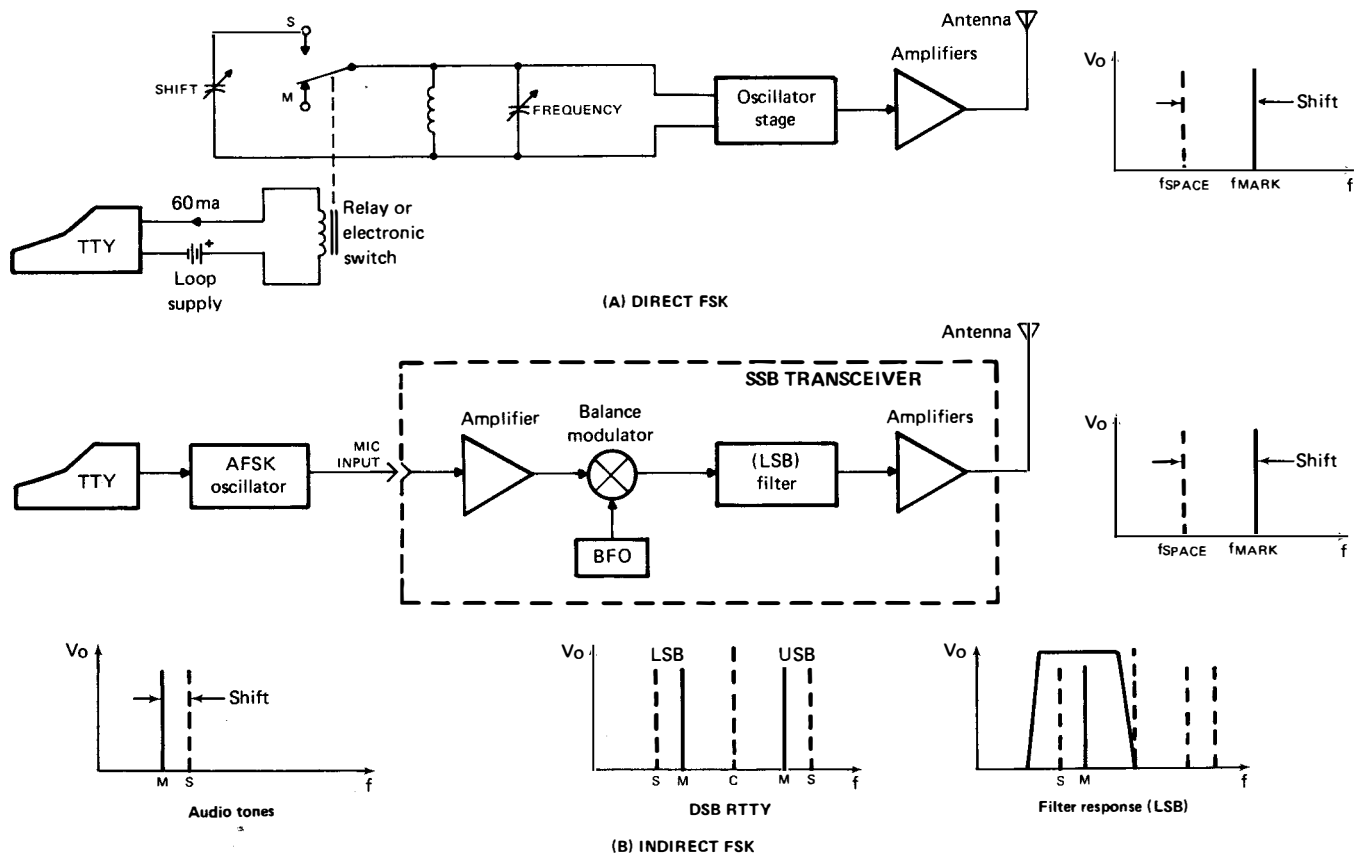

Fig. 2— Methods of generating an FSK RTTY signal.

mercial amateur transceivers (e.g., the TS820 and IC720). This technique is called **direct FSK** and will give very pure FSK RTTY emissions. A simple "direct FSK" transmitter system is shown in fig. 2(A).

However, there are a number of problems with this technique that may not be convenient for many of us. For example, if the transmitter or transceiver does not include a direct FSK input connection, it will be necessary to add a frequency shifting circuit. Most of us are understandably reluctant to modify our new radio, particularly when a modification to the oscillator circuits could degrade the frequency stability of the entire unit. Also, changing the frequency shift to be transmitted involves further changes in both home-brew and commercial direct FSK circuits. For example, one commercial radio requires that you remove 37 screws, get out the counter, adjust a trimmer, change a jumper, put the screws back, and hope nothing has changed!

A second technique which is much simpler for the operator to hook-up and use may be used to generate h.f. FSK RTTY. This technique makes use of the l.s.b. (lower sideband) mode of the transmitter and the same transmit RTTY tone encoder used for v.h.f. AFSK. This procedure has become quite popular and has a number of strong advantages, as well as some potential problem areas to watch out for. The technique works as follows:

(1) Separate audio tone frequencies are generated with an AFSK oscillator to represent the transmit mark and space pulse conditions.

(2) The audio tone signal is coupled into the microphone or phone patch input of an l.s.b. transmitter.

(3) The balanced modulator stage of the transmitter generates a double-sideband, suppressed carrier signal.

(4) A bandpass filter stage in the transmitter selects only the lower of the two sidebands and further suppresses the carrier.

(5) The heterodyne oscillator and mixer circuits convert the l.s.b./FSK RTTY signal to the desired band and output radio frequency.

Since the lower sideband was chosen, the lower audio tone frequency input (v.h.f. AFSK mark) will produce the higher radio frequency output signal (h.f. FSK mark). Thus, the two h.f. and v.h.f. tone standards are made compatible. The **indirect FSK** transmitter system is shown in fig. 2(B).

Because we are using a transmitter designed for one service (voice s.s.b.) for something completely different (RTTY FSK), there are a number of precautions that should be observed. Foremost among these is the consideration of the **100% duty cycle nature of RTTY**. In voice, the average transmitter power is only 50% of the peak power developed while talking—called "50% duty cycle." For RTTY,

however, we have a strong carrier on the air for the entire time we are transmitting—"100% duty cycle." Therefore, we need to be very heat conscious when using s.s.b. equipment for RTTY. Often, a final amplifier stage designed for many watts of output in voice service should be considerably derated for RTTY service. Particularly if the transmitter uses tubes not specifically designed for transmitter service (so-called "TV sweep-tubes," for example), we should decrease the output power from the normal voice or c.w. values. Also, if a very strong audio signal is introduced into the l.s.b. transmitter, "splatter" will result. This may not be a very serious problem for voice operations, but for RTTY, many spurious RTTY signals will be generated, *all of which are illegal!* Finally, consider the high-gain audio input of most transmitters: if the wires to the mike jack are not properly grounded or shielded, 60 or 120 Hz "hum" can be introduced and another spurious RTTY signal will be the result! These considerations are really just common sense, and most s.s.b. transmitters can be used for h.f. RTTY if these precautions are observed.

The technique of using audio tones with an h.f. s.s.b. transmitter results in an r.f. output that is a true F1, FSK emission, undistinguishable from a signal generated by shifting the transmitter oscillator frequency. I recommend we call this technique **indirect FSK** to reflect the fact that

tones and s.s.b. techniques are used to generate the FSK signal. This technique is *not* AFSK as it has been mistakenly called. AFSK is what we use for v.h.f. RTTY!

If all of this seems complicated, wait. It gets even deeper! To further add to the confusion, there are now several audio tone frequency standards that may be used. In fact, there is one standard in universal use by amateurs in the United States (high tones) and quite a different standard used by amateurs elsewhere in the world (low tones). Also, computer operators now use entirely different tone frequencies for phone-line and r.f. data communications. The differences and uses of these tone frequency standards are discussed below.

### Low Tones or High Tones?

The **high tones** (for higher frequency audio tones) are really the traditional standard U.S. RTTY tones used since the early days of amateur RTTY. The **low tones** are the IARU international standard used extensively in most other countries of the world. When receiving (or transmitting) on the h.f. bands (3-30 MHz), either set of tones will work since you tune the receiver to produce the desired beat note frequency. However, when AFSK modulation is added to an f.m. or a.m. signal, you must be prepared to receive the same tone frequencies as those used by the transmitting station; the a.m. or f.m. receiver does not use a b.f.o. to produce the audio tone.

In the United States, the long-standing v.h.f. AFSK tone standard has been to use the *high tones* (2125 Hz mark and 2295, 2550, or 2975 Hz space). To be compatible with other U.S. v.h.f. RTTY stations, you must use a high-tone demodulator! In Europe, in particular, the reverse standard is developing; the IARU *low tone* (1275 Hz mark and 1445, 1700, or 2125 Hz space, depending upon the shift chosen) is the standard to be observed. The two systems are basically incompatible for v.h.f. AFSK operation! Due to low-pass filter parameters, use of data rates greater than 150 baud is not recommended when "high" or "low" tone demodulator combinations are used. Frequency relationships between "high" and "low" tones are shown in fig. 3.

Each tone set has its advantages and disadvantages. Some of the considerations for each tone set are as follows:

#### High Tones (Mark = 2125 Hz)

##### Advantages:

1. High tones are the U.S. v.h.f. AFSK standard. Their use is required for compatibility when operating v.h.f. AFSK in the U.S. A high tone demodulator may be used for both v.h.f. and h.f. use in the United States.

2. When tones are connected to the audio input of an h.f. i.s.b. transmitter, there may be less problems with spurious signals when high tones are used rather

than low tones. Since the tone frequencies are high, harmonics and distortion products that may be caused by overdriving the transmitter input occur at audio frequencies beyond the audio passband of the transmitter, and therefore *should* not be transmitted. The rejection of the frequency components of the unwanted sideband will also be greater for high tones than for low tones.

##### Disadvantages:

1. The relatively high audio frequencies used in the high tone set may not fall within the audio frequency response of the receiver or transmitter. In general, the stan-

dard amateur shift, 170 Hz, will pass most current receivers and transmitters (the Collins S-Line is an exception). However, few pieces of equipment will pass the tones for both receiving and transmitting 425 or 850 shift with high tones (the Drake TR-7 is an exception). The use of high tone demodulators for h.f. RTTY is therefore restricted to transmission of just 170 shift, and only receivers incorporating either a variable b.f.o. or passband tuning will receive all three shifts.

2. High tones are not the IARU standard and will not be compatible with v.h.f.

## PERFORMANCE VERSATILITY CONVENIENCE

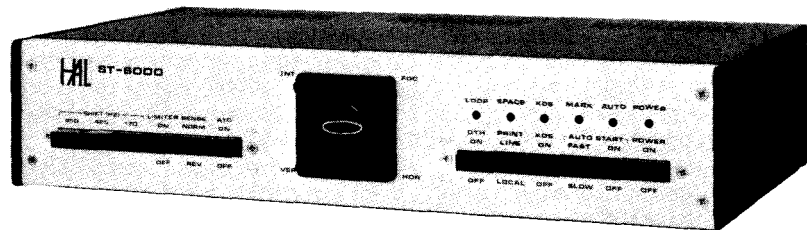

The HAL ST6000 has them all:

- performance to copy the weak and distorted signal
- versatility to match a variety of I/O interfaces
- convenience for simple but accurate operator use

All this at half the price of comparable-performance units.

#### PERFORMANCE:

- Optimized active input, discriminator, and low-pass filters.
- Crystal tone keyers match discriminator filters.
- Hard-limiting FM or AM types of operation.

#### VERSATILITY:

- Interface current loop circuits; built-in loop supply.
- RS-232C and MIL-188 data I/O connections.
- CMOS pre- and post-autostart data I/O data connections.
- Available for low, high, marine-compatible, and special tones.

#### CONVENIENCE:

- Hard-limiting operation for simple but effective operation.
- Tuning oscilloscope for precise receiver tuning.
- ATC, DTH, KOS, autostart, and antispaces features.
- Operate 120/220 VAC, 50/60 Hz; table or rack mount.
- Solid state design with proven field-tested dependability.

Write or call for more information on the HAL ST6000.



**HAL COMMUNICATIONS CORP.**

BOX 365  
URBANA, ILLINOIS 61801

217-367-7373

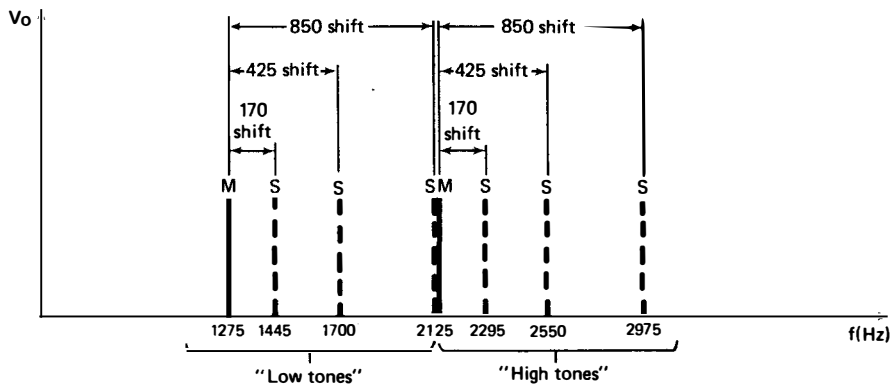

Fig. 3- Low and high tones.

AFSK in many countries of the world.

### Low Tones (Mark = 1275 Hz)

#### Advantages:

1. Low tones are the IARU international standard, and their use assures compatibility with v.h.f. AFSK operations in many areas of the world.
2. Low tones can be used with virtually all s.s.b. receivers and transmitters for all three standard shifts. Variable b.f.o. or passband tuning features are not required to assure good reception of 425 and 850 Hz shift stations.

#### Disadvantages:

1. Low tones are not compatible with existing U.S. v.h.f. AFSK operations. Since there is a great deal of high tone AFSK equipment already in use in the United States and neighboring countries, it is unreasonable to expect that the U.S. standard will shift to low tones.
2. When low tones are used with an l.s.b. transmitter to generate F1 RTTY emissions, there is a strong probability that overdriving the transmitter audio and modulator stages will result in spurious harmonics and mixer products that will be radiated. Of course, these problems will not occur if the audio drive level is properly set.

Although you may develop your own personal preferences, I recommend that you consider the following operating conditions as a starting point:

#### In the United States

Use **high** tones for all v.h.f. AFSK amateur communications and for normal 170 Hz shift h.f. operation. Use **low** tones when receiving h.f. commercial RTTY stations unless you have a receiver with a variable-pitch b.f.o. or with i.f. passband tuning. The exception applies to use of the older Collins S-Line equipment: use **low** tones for all h.f. operations, amateur or commercial.

#### In Europe (and all other areas where IARU standards apply):

Use **low** tones exclusively for both v.h.f. AFSK and h.f. operations. The only exception would be when you communicate with another v.h.f. AFSK station who is using **high** tones.

### Modem Tones

With the increasing popularity of personal computing, more and more amateur radio operators are combining the two hobbies and using their radios to exchange computer ideas and programs. Recent U.S. FCC approval of amateur use of the ASCII computer code has certainly encouraged this growing section of our RTTY hobby, particularly among v.h.f.-f.m. RTTY repeater users. Some of us have used the "standard" high tones of 2125/2295 Hz for 110 and 300 baud ASCII communications and 2125/2975 Hz for up to 1200 baud ASCII. If the demodulator low-pass filters are readjusted (and they must be on practically all good-quality h.f./v.h.f. demodulators), these tone pairs work well for ASCII.

However, commercial standards already exist for ASCII communications on telephone circuits. These tone standards are particularly attractive for amateur use since modems can often be obtained from surplus sources for low cost or can be built with a minimum number of parts from diagrams published in semiconductor manuals. Since these tones are not the same as those we have used for 45 baud Baudot for years, there is often little interference caused between users of ASCII and Baudot. Sometimes the same v.h.f. repeater can be used simultaneously for both applications! For these reasons there is a growing popularity in the use of two commercial data set standards for v.h.f. amateur operation: the **Bell 103 Modem** and the **Bell 202 Modem** standards.

The **103 Modem** is used for telephone line data communications at data rates

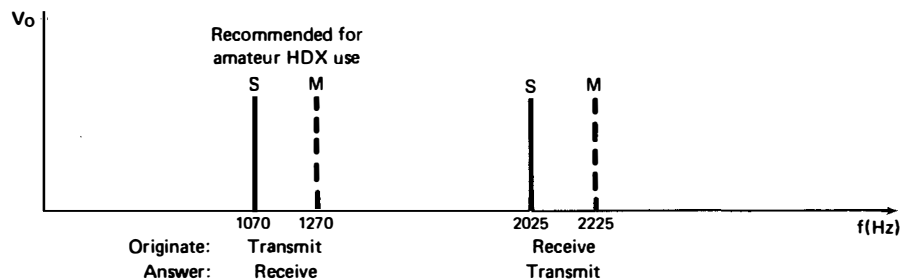

Fig. 4- "103 Modem" tones.

up to 300 baud. The modems that are sold include both transmit tone generation and receive tone demodulation circuitry. Control circuitry is also included to permit automatic send-receive control or "handshaking" between two data terminals; a touch-tone dialing circuit sometimes is also included. The 103 Modem is designed for full duplex (FDX) operation, meaning that data or text may be received and printed even while you are typing and transmitting data. Our amateur communications are usually carried out using half duplex (HDX); we take turns talking or exchanging data.

Because the 103 Modem operates in FDX, two sets of tones are used for data transfer between data terminals, one set for each direction of data flow. Since any terminal on the telephone circuit can start or originate a data connection, a convention has been established to keep track of what set of tones is used with each terminal. The terminal or station that places the initial "call" is called the **originate** station; the receiving terminal is called the **answer** station. The "originate" and "answer" modes are set in each modem by control signals at the beginning of the data connection, and these modes remain in this condition for the duration of the exchange. However, after the call has been completed and the connection broken ("hang-up" the line), the second station may now place a call to another terminal. Since it is now the originating station, its modem will select the originate tone sets for use. The tone frequencies used in 103 Modems are:

#### Originate Mode

Transmit data: 1270 Hz mark, 1070 Hz space

Receive data: 2225 Hz mark, 2025 Hz space

#### Answer Mode

Transmit data: 2225 Hz mark, 2025 Hz space

Receive data: 1270 Hz mark, 1070 Hz space

Notice that the transmit tones of one station correspond to the receive tones of the other station, assuring simultaneous data flow in both directions (full duplex).

Amateur radio communications are generally conducted using half-duplex communications. Also, when we are transmitting, we prefer to transmit the same set of tones that we use when re-

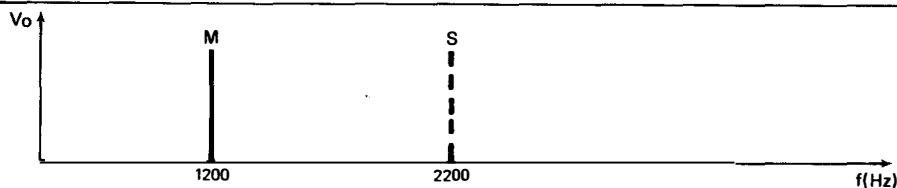

Fig. 5- "202 Modem" tones.

ceiving. It is recommended that amateurs use the **originate-transmit** mode set of 103 Modem tones for v.h.f. ASCII transmissions (1270 Hz mark, 1070 Hz space). These tones agree with the above commercial standards and are sufficiently removed from the standard Baudot tones (2125 Hz and 2295 Hz) to prevent interference. A frequency diagram of the 103 Modem is shown in fig. 4.

The **202 Modem** is used for data transmission at rates up to 1200 baud. The 202 Modem is a half-duplex device, and therefore only one set of tone frequencies is commonly used: 1200 Hz for mark and 2200 Hz for space. Here again, these tones are different from those used by amateur Baudot stations. The 1200 baud data rate is certainly attractive when a large amount of data must be sent and the communications channel has little noise (typical v.h.f.-f.m. situation). However, the tone frequencies of 2125/2295 Hz and 1200/2200 Hz are not easily separated, and it probably is not feasible to use the two simultaneously on the same channel as may be done with 1270/1070 and 2125/2295 Hz tone pairs. A frequency diagram of the 202 Modem is shown in fig. 5.

Since the major application for use of 1200 baud data exchange will probably

be over v.h.f.-f.m. links, signal-to-noise ratios will generally be quite good and high-performance demodulation circuitry is not needed. A good phase-lock-loop circuit will give very satisfactory performance at 300 or 1200 baud over an f.m. communications link. Often, a satisfactory demodulator can be constructed from diagrams given in a manufacturer's application notes and may involve only one or two integrated circuits. Such circuits are available for the 565 PLL IC, the 6860 IC, and the XR-2211 IC, for example.

### Recommended Standards for Amateur RTTY Tones

Based on the previous discussions of the features and reasons for the various RTTY tone frequencies used, the following standards are recommended:

#### H.F. RTTY (Mark = higher radio frequency)

U.S.A.:

2125 Hz mark, 2295 Hz space—45 through 110 baud (ASCII or Baudot)

2125 Hz mark, 2550 Hz space—110 through 300 baud (ASCII)

C.W. ID = 2025 Hz (all shifts)

Europe:

1275 Hz mark, 1445 Hz space—45 through 110 baud (ASCII or Baudot)

1275 Hz mark, 1700 Hz space—110 through 300 baud (ASCII)  
C.W. ID = 1175 Hz (all shifts)

#### V.H.F. RTTY:

U.S.A.:

2125 Hz mark, 2295 Hz space—45 to 74 baud Baudot

C.W. ID = 2025 Hz

1270 Hz mark, 1070 Hz space—110 to 300 baud ASCII

C.W. ID = 1370 Hz

1200 Hz mark, 2200 Hz space—300 to 1200 baud ASCII

C.W. ID = 1100 Hz

Europe:

1275 Hz mark, 1445 Hz space—45 to 100 baud Baudot

C.W. ID = 1175 Hz

1270 Hz mark, 1070 Hz space—110 to 300 baud ASCII

C.W. ID = 1370 Hz

1200 Hz mark, 2200 Hz space—300 to 1200 baud ASCII

C.W. ID = 1100 Hz

As our small section of the amateur hobby continues to grow, it is important that we establish some compatible standards so that we may continue to communicate with each other. V.h.f. repeater groups in particular are presently isolated groups who may choose their own standards with little concern about techniques and procedures used elsewhere. However, this isolation is probably short-lived, particularly if current trends for repeater linking and satellite development continue. A little preplanning and agreement now can prevent a very big compatibility problem later when the hobby has grown and these techniques are in use.

(Reprinted from CQ, November 1982, with permission.)



**HAL COMMUNICATIONS CORP.**

**BOX 365**

**URBANA, ILLINOIS 61801**