

# Armed Services Technical Information Agency

Because of our limited supply, you are requested to return this copy WHEN IT HAS SERVED YOUR PURPOSE so that it may be made available to other requesters. Your cooperation will be appreciated.

# AD

# 39099

NOTICE: WHEN GOVERNMENT OR OTHER DRAWINGS, SPECIFICATIONS OR OTHER DATA ARE USED FOR ANY PURPOSE OTHER THAN IN CONNECTION WITH A DEFINITELY RELATED GOVERNMENT PROCUREMENT OPERATION, THE U. S. GOVERNMENT THEREBY INCURS NO RESPONSIBILITY, NOR ANY OBLIGATION WHATSOEVER; AND THE FACT THAT THE GOVERNMENT MAY HAVE FORMULATED, FURNISHED, OR IN ANY WAY SUPPLIED THE SAID DRAWINGS, SPECIFICATIONS, OR OTHER DATA IS NOT TO BE REGARDED BY IMPLICATION OR OTHERWISE AS IN ANY MANNER LICENSING THE HOLDER OR ANY OTHER PERSON OR CORPORATION; OR CONVEYING ANY RIGHTS OR PERMISSION TO MANUFACTURE, USE OR SELL ANY PATENTED INVENTION THAT MAY IN ANY WAY BE RELATED THERETO.

Reproduced by  
DOCUMENT SERVICE CENTER  
KNOTT BUILDING, DAYTON, 2, OHIO

# UNCLASSIFIED

# INTERIM DEVELOPMENT REPORT

IDR 358-6

Copy No. 4

AD NO. 39-099

ASTIA FILE COPY

## INTERIM DEVELOPMENT REPORT

FOR

RADIO SET AN/URC-8

1 July 1954

Navy Department  
Contract NObsr-63161

Bureau of Ships  
December 23, 1952

FURTHER DISSEMINATION IS AUTHORIZED ONLY TO  
MILITARY AGENCIES.

# COLLINS RADIO COMPANY

C E D A R R A P I D S , I O W A , U . S . A .

Report No. IDR-358-6  
1 July 1954

INTERIM DEVELOPMENT REPORT  
FOR  
RADIO SET AN/URC-8

This report covers the period from 1 April 1954 to 30 June 1954

PREPARED BY:

*E. W. Schwittick*  
Project Engineer

APPROVED BY:

*Ed Pappenfus*  
Head, Department III

*Walter B. Jones*  
Development Contract Director  
By Direction of Insp. of Naval Mat.

Report of progress under Contract NObsr 63161, December 23, 1952  
Navy Department, Bureau of Ships, Electronics Division

A PUBLICATION OF  
THE RESEARCH AND DEVELOPMENT LABORATORIES  
COLLINS RADIO COMPANY  
Cedar Rapids, Iowa

## ABSTRACT

This report contains a description of the present status of the development of the AN/URC-8. In particular it relates to the stage of development wherein essentially all design decisions have been reached and indicates the state of construction dictated by these decisions.

## INTERIM DEVELOPMENT REPORT

### RADIO SET AN/URC-8

#### PART I

##### A. PURPOSE

The purpose of the development work contained in this and following reports is to provide a rugged and reliable receiving and transmitting equipment. Simplicity of maintenance and operation consistent with dependability will be the determining factors in making many of the design decisions.

##### B. DETAIL FACTUAL DATA

###### 1. AN/URC-8 Receiver

During this period, work on the receiver portion fell into three general categories: testing of the experimental model and the incorporation of circuit changes indicated by the test results; continuation of the design of all r-f coils, the front-end tuning coils in particular; and construction of the developmental model of the receiver.

As a result of tests of the experimental model, the following changes were made in tube complement, as seen by comparing the block diagram of the developmental model in Figure 1 with that of the preceding report: (a) a second stage of r-f amplification was added between the second and third r-f coils to provide simplified alignment, improved tracking, and better signal-to-noise ratio. (b) The M. O. filament regulator tube was found not essential and was eliminated. (c) The bfo injection was moved from the grid of the last i-f amplifier to the detector input, and a bfc buffer stage was added. The result is improved linearity and frequency stability in cw reception. (d) A second stage of a-f amplification was added to provide reserve gain and to improve the signal-handling ability by reducing the r-f and i-f gain requirements.

The tube complement is 19 total, using 5 types.

The results of performance tests of the experimental model indicate no serious deviation from the specification requirements, with the exception of receiver power supply regulation. A careful study of possible fully regulated systems revealed the present unregulated type to be considerably superior to fully regulated types in reliability and low heat dissipation. Regulation is used only for M. O. supply voltage; the remaining circuitry is designed to operate from the unregulated supply.

The selectivity of the experimental model is shown in Figure 2, indicating the "broad" or "narrow" response curves available by a front panel switch. The "broad" position (approximately 9 kc bandwidth at 6 db) would normally be used for phone reception; the "narrow" position (2 kc bandwidth at 6 db) for cw. The high skirt selectivity results from the employment of two plug-in mechanical filters (pictured in Figure 2 of the preceding report).

Coils have been designed for all r-f tuned circuits with emphasis on the sixteen variable-pitched tuning coils. The present models of these tuning coils have good linearity and Q, and satisfactory frequency range (these properties for a typical coil are given in Figure 3), but are not yet completely tracked.

A simple winding machine has been constructed and found satisfactory for the accurate reproduction of all variable-pitched tuning coils for the four prototype receivers.

During this period, the developmental model has been nearly completed. The electrical design incorporates the modifications found necessary in tests of the experimental model. The mechanical design, except for mounting details, is practically complete. Only the rack and gearing which moves the ferrite cores in the tuning coils remain for initial design.

A front view of the developmental model is shown in Figure 4.

Behind the dial window, a vertically sliding shutter, actuated by the bandswitch knob, reveals the proper scale for the frequency band in use, on each of two dials. The upper dial is calibrated in megacycles and tenths of megacycles, the lower dial in kilocycles. All calibrations are linear and reading is direct. For example, readings of 2.9 on the megacycle dial and 33 on the kilocycle dial indicate a frequency of 2.933 mc or 2933 kc.

The two dials are shown in Figure 5 above, in normal positions (but without shutter), and below, separated to reveal all calibrations. Identical dials will be used on the transmitter.

The water-tight front cover is held by screws into the four tapped holes in the handles. Two fuses and two spares for the line voltage in use are available on the front panel; four fuses for the alternate line voltage are mounted on the power supply module.

A top view of the developmental model is shown in Figure 6. From left to right are the front end module, the power supply module, and the i-f audio module. The modules plug into a 3/16 inch floor plate and are secured by corner screws. The front end module is not completed as of this report, but will be shortly. Pending final design of the slug-positioning rack, a temporary rack has been made and will be used for initial performance tests of the developmental model.

In Figure 7, the three modules have been removed to show the plug-in power and r-f receptacles in the floor plate.

A bottom view of the model is shown in Figure 8. Near center is the M. O. unit which mounts with four screws and connects electrically by means of two plugs. The wiring harness joins front panel controls, module receptacles, filtering components and rear chassis plugs. The front panel was not wired at the time of the photographs, and gearing was not installed.

The front-end module, without its tuning rack, and with main shield cover removed, appears in Figure 9. This module will contain all circuitry ahead of the mechanical filters. Along the far side is the sub-assembly mounting the four M. O. multiplier coils. Housed in three shielded sub-assemblies on the near side are the antenna coils and the 1st and 2nd r-f coils. The latter three subassemblies with shields removed are shown in Figure 10. Each unit is one tuned circuit position, and contains a coil for each of the four bands. The 12 ferrite tuning cores enter from above, each attached to the slug rack. The four cores for the M. O. multiplier coils attach to the same rack, all 16 cores moving in unison during tuning.

The power supply module, with bottom plate removed, is shown in Figure 11. The power transformer is an experimental sample which is satisfactory for initial testing of the developmental model pending arrival of the final units. A sample of the final case has been substituted on the module for Figures 4 and 6 to show true component size.

The i-f-audio module, with bottom cover removed, is shown in Figure 12. Two etched-circuit, dip soldered, terminal boards are used in this module, one appearing on the near side. Removal of screws allows the boards to swing out for access in servicing.

Heat-reducing tube shields are used on two audio output tubes, one i-f amplifier tube, and the first r-f amplifier tube to limit bulb temperatures to acceptable values. To achieve reliability at maximum specified ambient temperature (65 deg C), the use of these shields as well as the numerous cut-outs and heat-barriers throughout the construction represent the results of considerable heat transfer study during the design of this model.

Figure 13 shows the M.O. unit which mounts the cylindrical sealed frequency-determining tuned circuit, the M. O. tube, the buffer tube, and the M. O. voltage regulator tube. The M. O. oven (not shown) is an independent hollow cylinder which slips over the tuned circuit housing. The oven will operate only below zero degrees C.

## 2. AN/URC-8 Transmitter

Figures 14, 15, and 16, depict the top, bottom and front views respectively, of the preliminary design model of the transmitter. Views of the

individual module units contained in this transmitter have been included in preceding reports.

This transmitter model is electrically complete and is ready for electrical type testing at this time. Bench tests have been performed with this model and satisfactory results have been obtained. The transmitter is mechanically complete with the exception of the front and sub-panels. The front panel view as shown in Figure 16 should not be considered representative. Since front panel gearing has not been included in this model, more knobs than necessary appear on the front panel and the main frequency indicating dial has not been included. The air intake and outlet parts and handles are not as they are intended to be in the prototype model.

Figures 17 and 18 show the transmitter filter box and folding cable. The filter box is intended to be attached to the rear of the transmitter case. It includes all plugs necessary for interconnecting cables and remote box operation and a radio-frequency filter for each lead.

### 3. AN/URC-8 A-C Power Supply

Figures 19, 20, 21 and 22 depict the top, bottom, rear and front views, respectively, of the prototype model of the a-c power supply.

The handles, air ports and spare fuse cover shown on the front view are balsa wood replicas. These items will be aluminum castings and have not as yet been obtained. The handles for all units of the equipment will be of this form and the transmitter air ports will be identical to the a-c power supply air ports.

The preliminary design model of the a-c power supply has been bench tested and is ready for type testing with the transmitter. The prototype power supply (shown in the figures) still requires wiring.

## PART II

### A. PROGRAM FOR NEXT INTERVAL

#### 1. Receiver

(a) The tracking design of the front-end tuning coils will be completed.

(b) The developmental model will be finished and will be tested. The tuning coils will be individually tuned for these tests until tracking design is complete.

(c) Based on evaluation of the developmental model, final electrical and mechanical design for the first prototype model will follow. By the end of the next interval, the prototype model should be nearly finished.



It is planned that during the first month of the following interval the prototype model will be completed and given initial tests in preparation for tests under Navy supervision to start November 1.

2. Transmitter and A-C Power Supply

(a) A type test will be conducted on the preliminary design models of the transmitter and a-c power supply.

(b) The prototype a-c power supply model will be completed.

(c) Based on the type test of the preliminary model, the prototype model of the transmitter will be constructed. By the end of the next reporting period the prototype transmitter construction should be 85% complete.

COLLINS RADIO COMPANY

Project Performance and Schedule

Contract NObsr 63161

(Report) Date: July 1, 1954

Period Covered 9/30/53 to 6/30/54

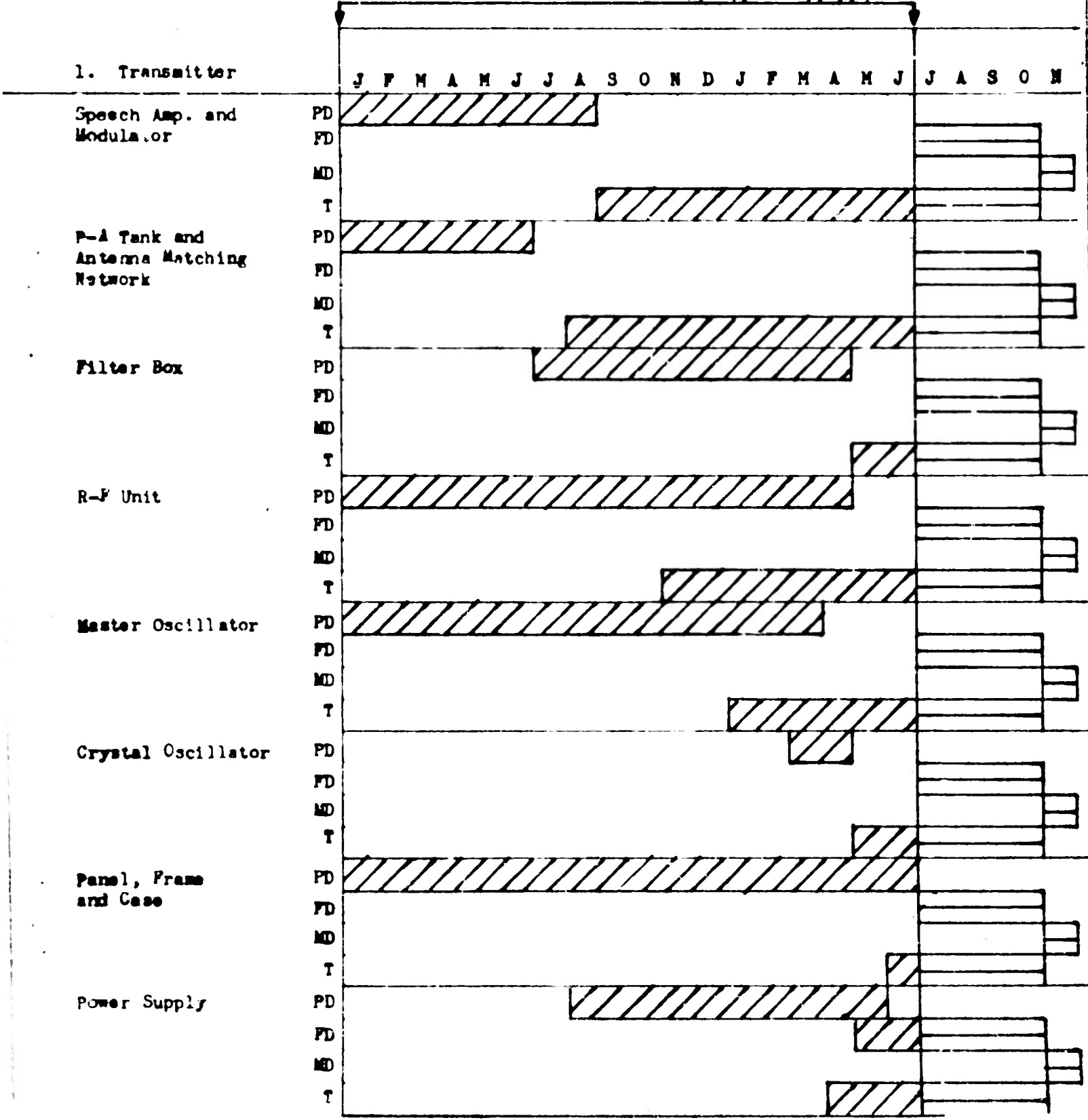

Legend:



- Work Completed

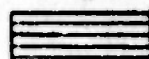

- Schedule of Projected Operation

PD — Preliminary Design

FD — Final Design

MD — Model Delivery Period

T — Test

Period covered 4/1/54 to 6/30/54

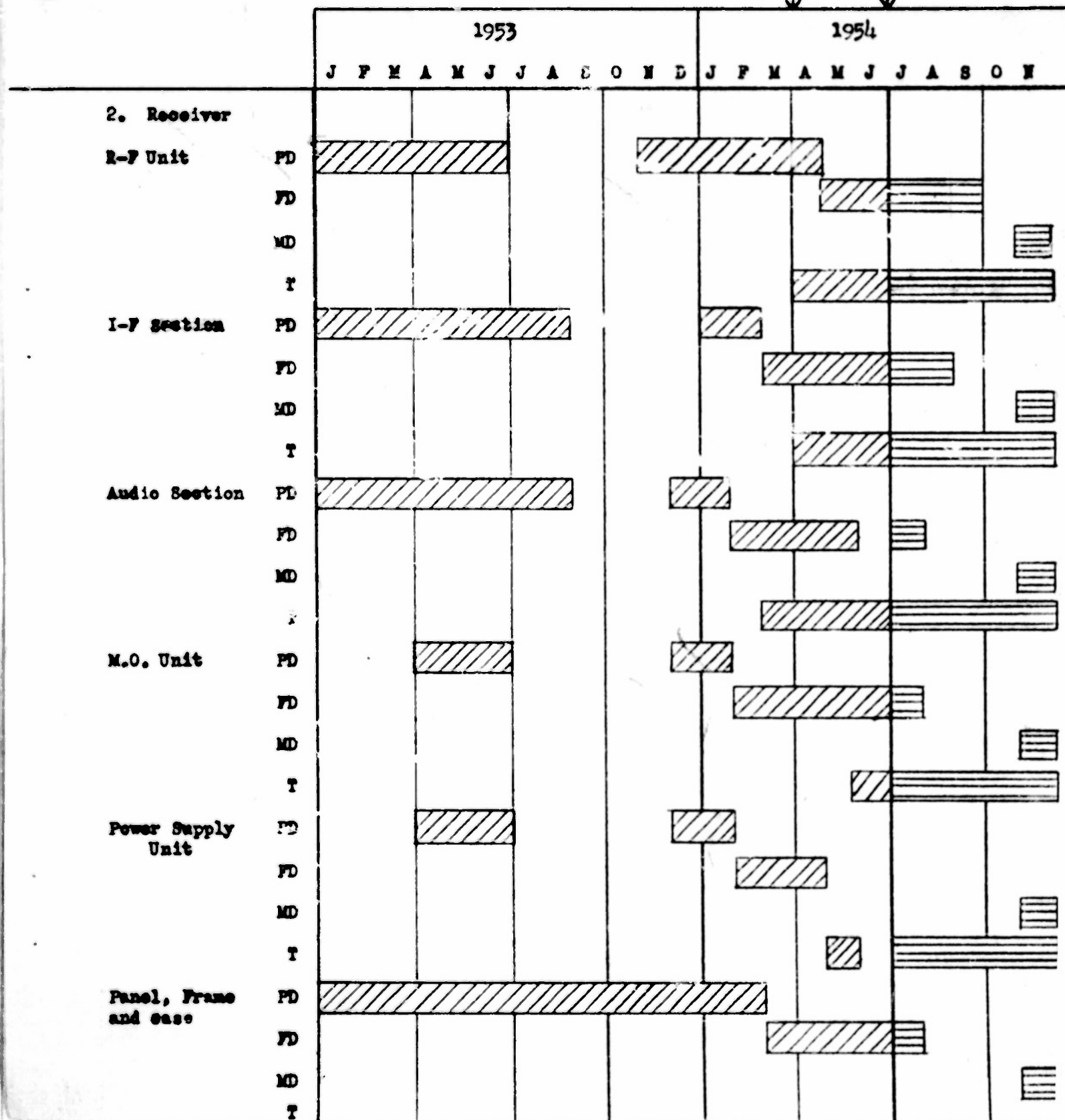

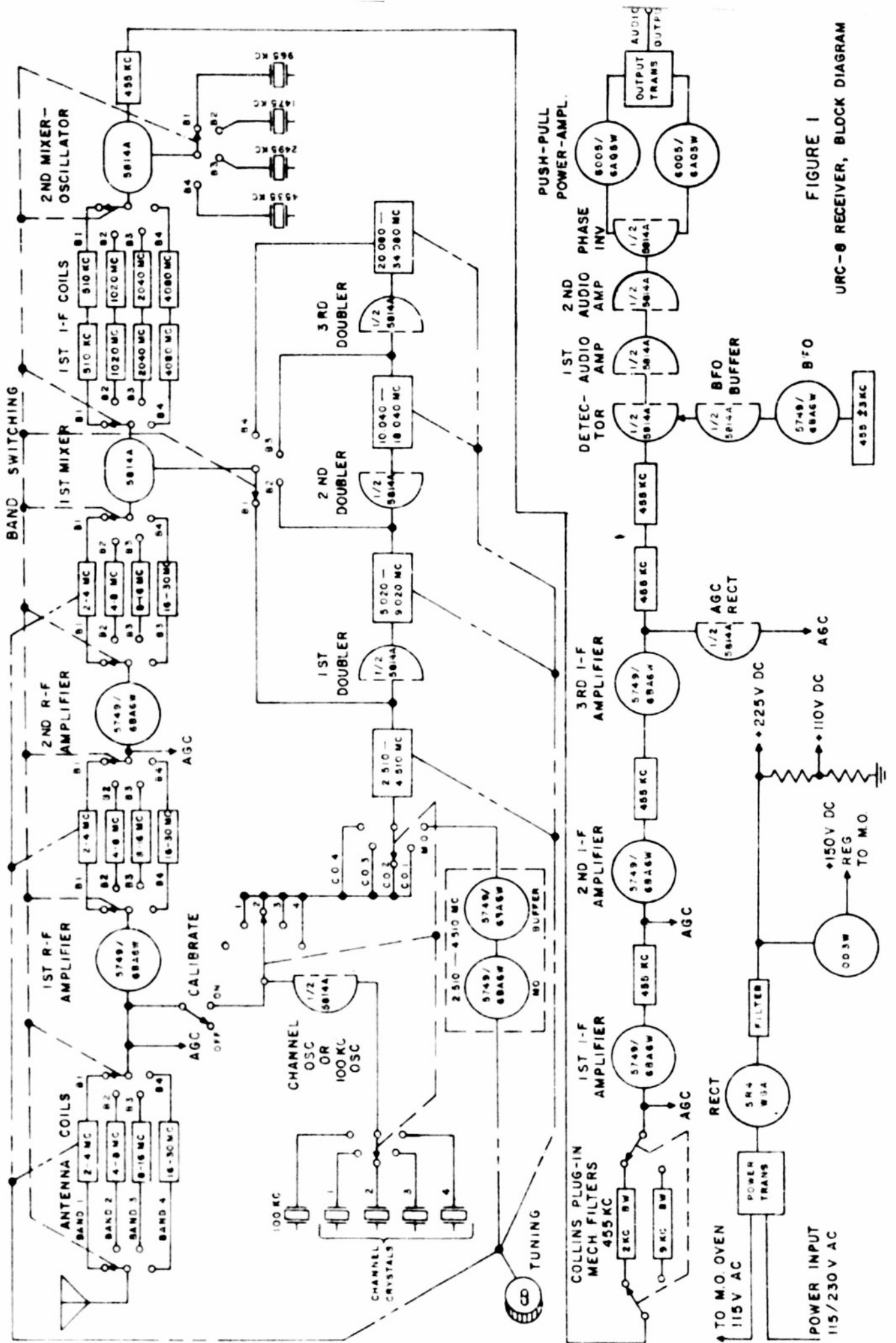
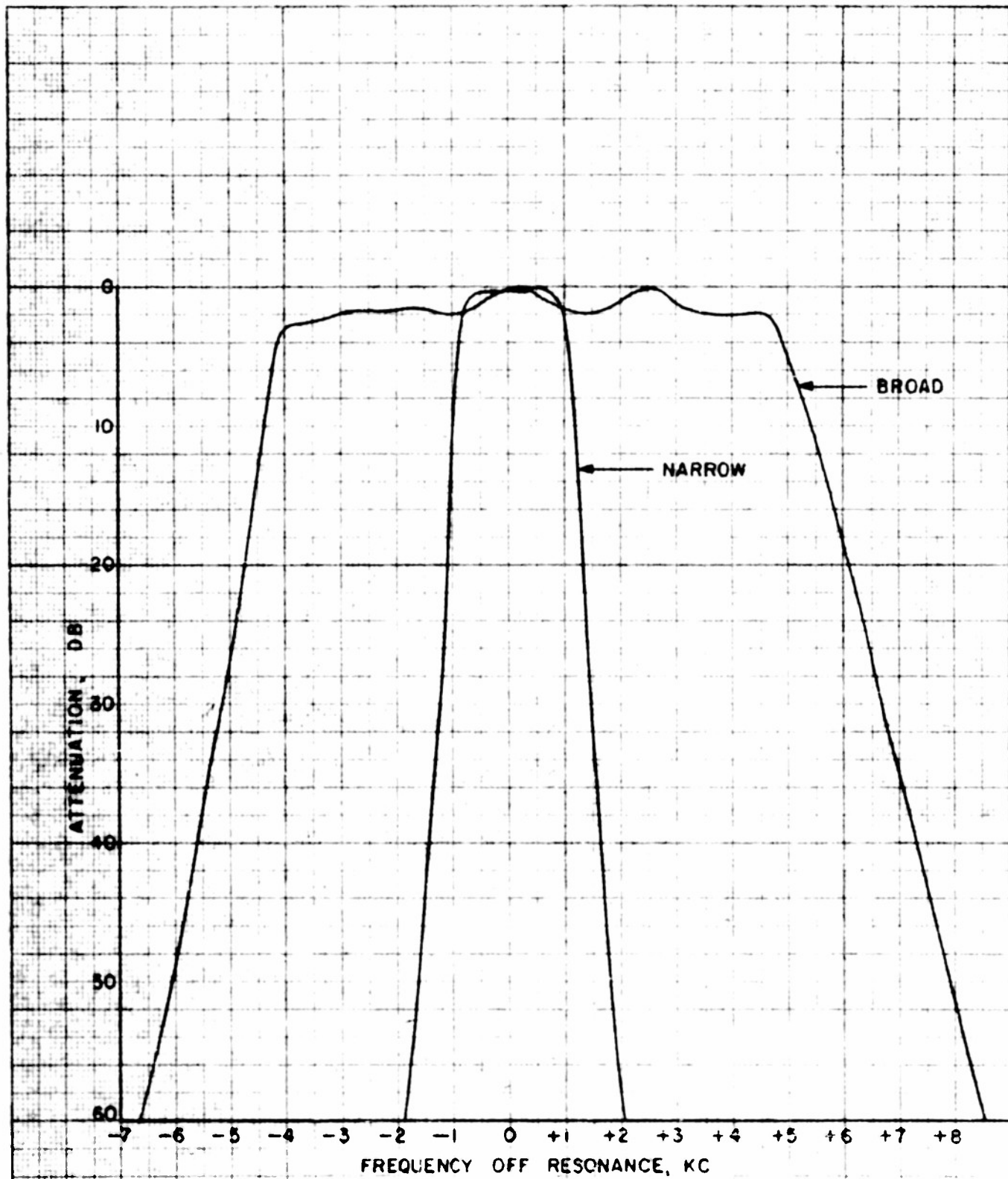

FIGURE 1  
URC-8 RECEIVER, BLOCK DIAGRAM



SELECTIVITY CURVES  
URC-8 RECEIVER, EXPERIMENTAL MODEL  
USING COLLINS PLUG-IN 2KC AND 9KC MECHANICAL FILTERS

FIGURE 2

NO. 1408 4.0 DIETZEN DWA. 1.000  
MILLIMETER

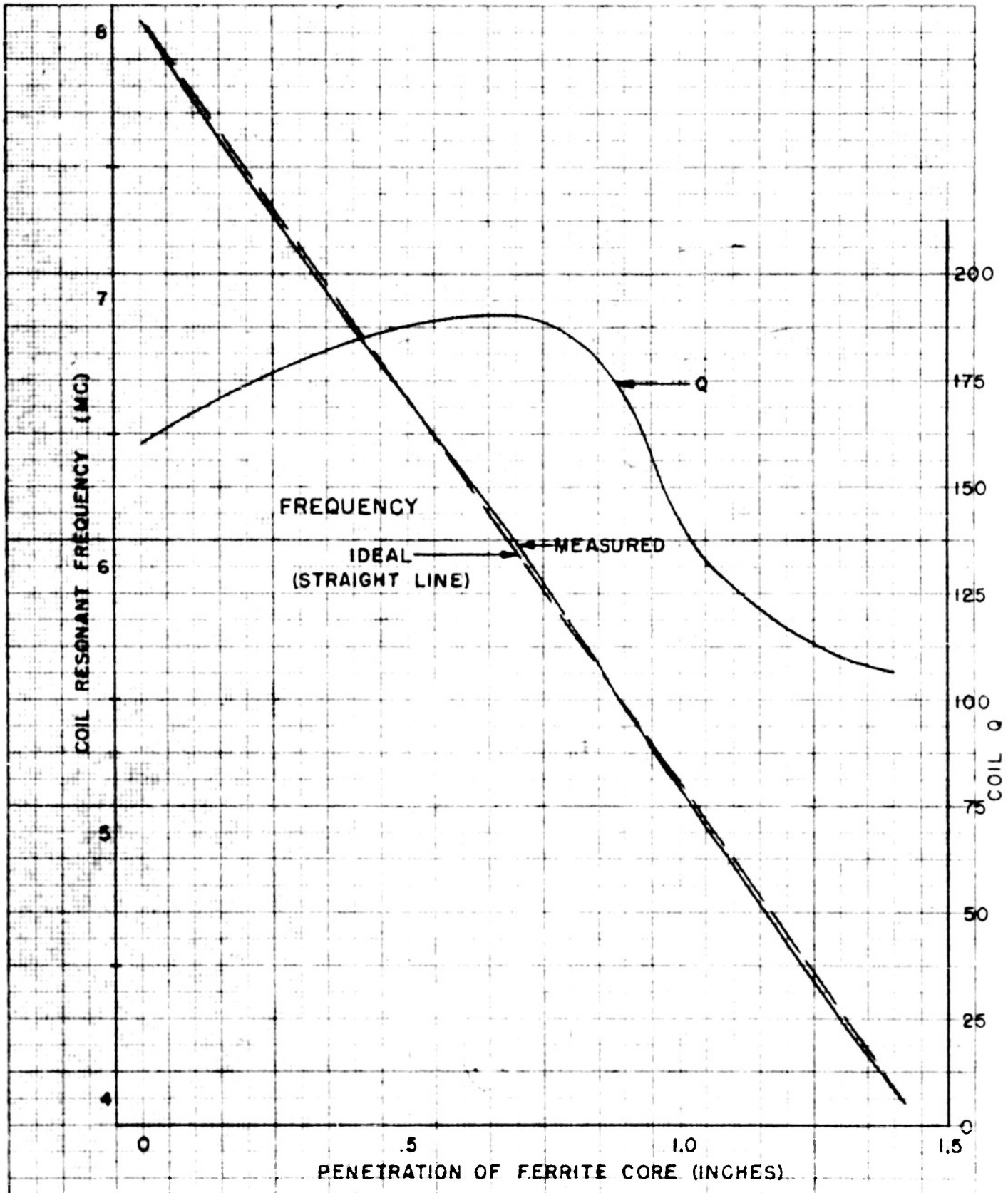

LINEARITY AND Q OF VARIABLE-PITCHED TUNING COIL  
BAND 2 ANT. COIL URC-8 RECEIVER EXPERIMENTAL MODEL

FIGURE 3

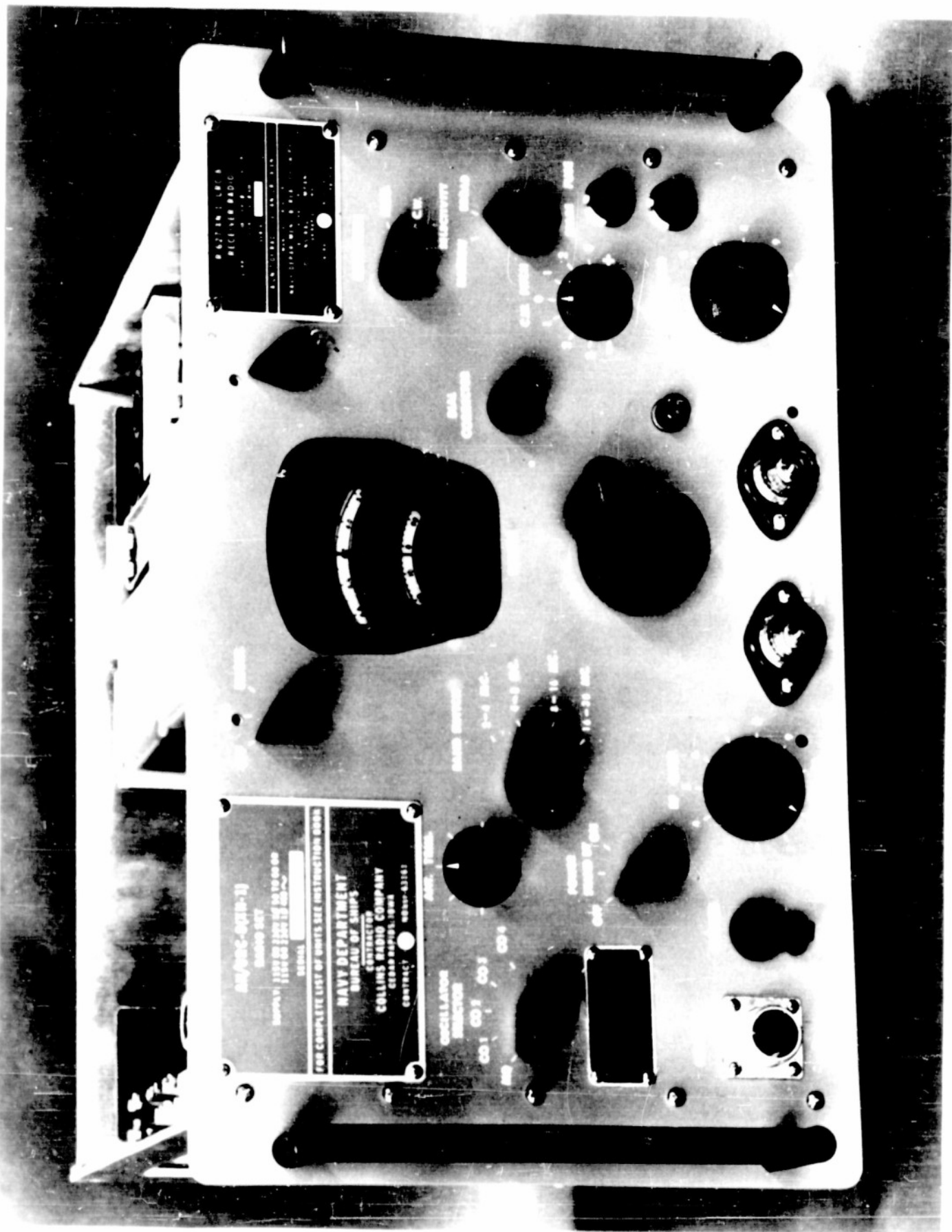

P 627 IN 1 1/2 1/2  
 RECEIVER RADIO  
 ...  
 ...  
 ...  
 ...  
 ...

AM/RC-428-1)  
 RADIO SET  
 PARTS LIST 1107 02 1207 12 10 10 00  
 1107 02 1207 12 10 10 00  
 SERIAL  
 FOR COMPLETE LIST OF PARTS SEE INSTRUCTION BOOK  
 NAVY DEPARTMENT  
 BUREAU OF SHIPS  
 CONTRACT  
 COLLINS RADIO COMPANY  
 CINCINNATI, OHIO  
 CONTRACT 98307-AJ151

OSCILLATOR  
 SECTION  
 CO-1 CO-2 CO-3  
 CO-4

MAIN SECTION  
 1-1 1-2  
 1-3 1-4  
 1-5 1-6  
 1-7 1-8  
 1-9 1-10  
 1-11 1-12

AM  
 SECTION  
 1-13  
 1-14  
 1-15  
 1-16  
 1-17  
 1-18  
 1-19  
 1-20  
 1-21  
 1-22  
 1-23  
 1-24  
 1-25  
 1-26  
 1-27  
 1-28  
 1-29  
 1-30  
 1-31  
 1-32

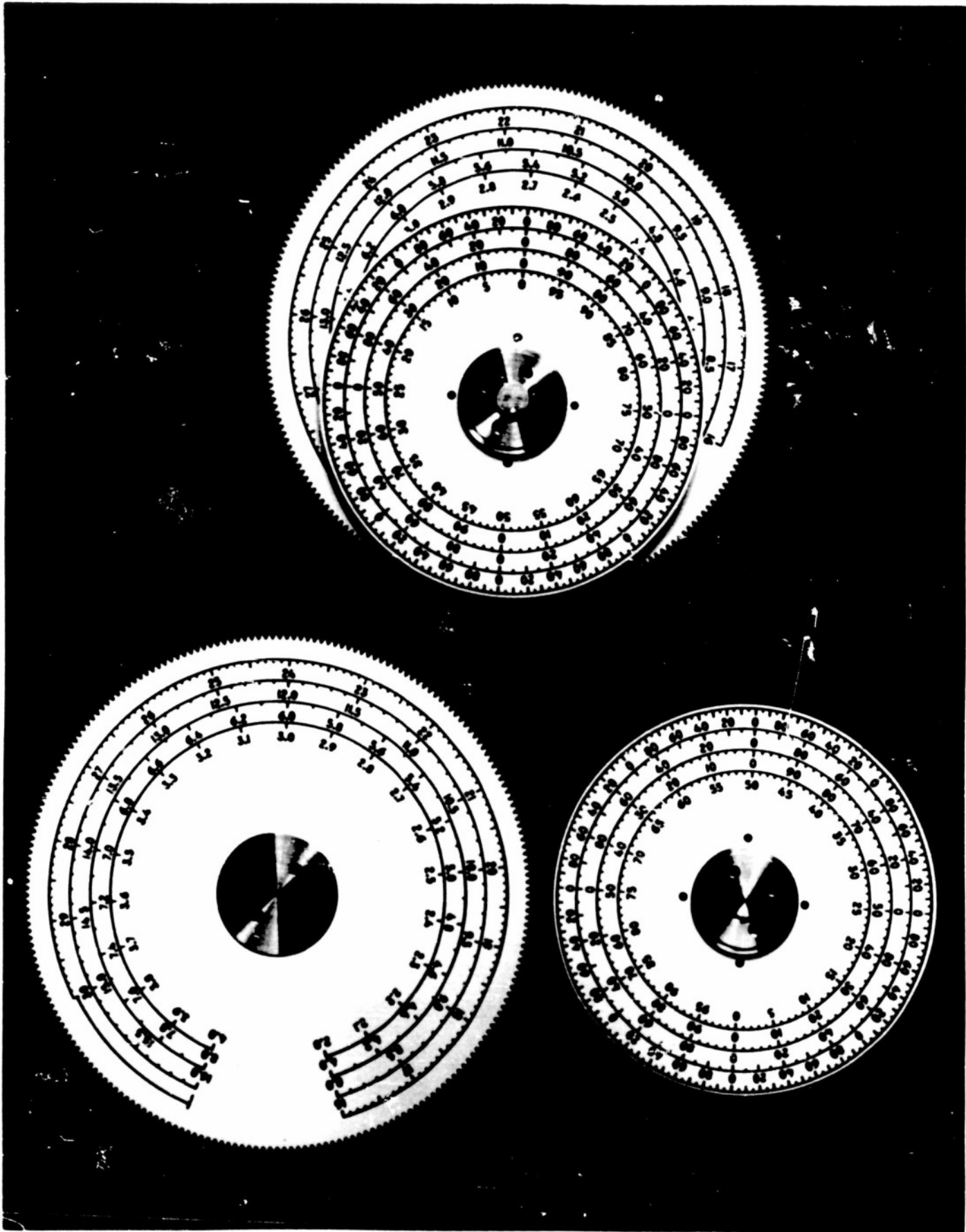
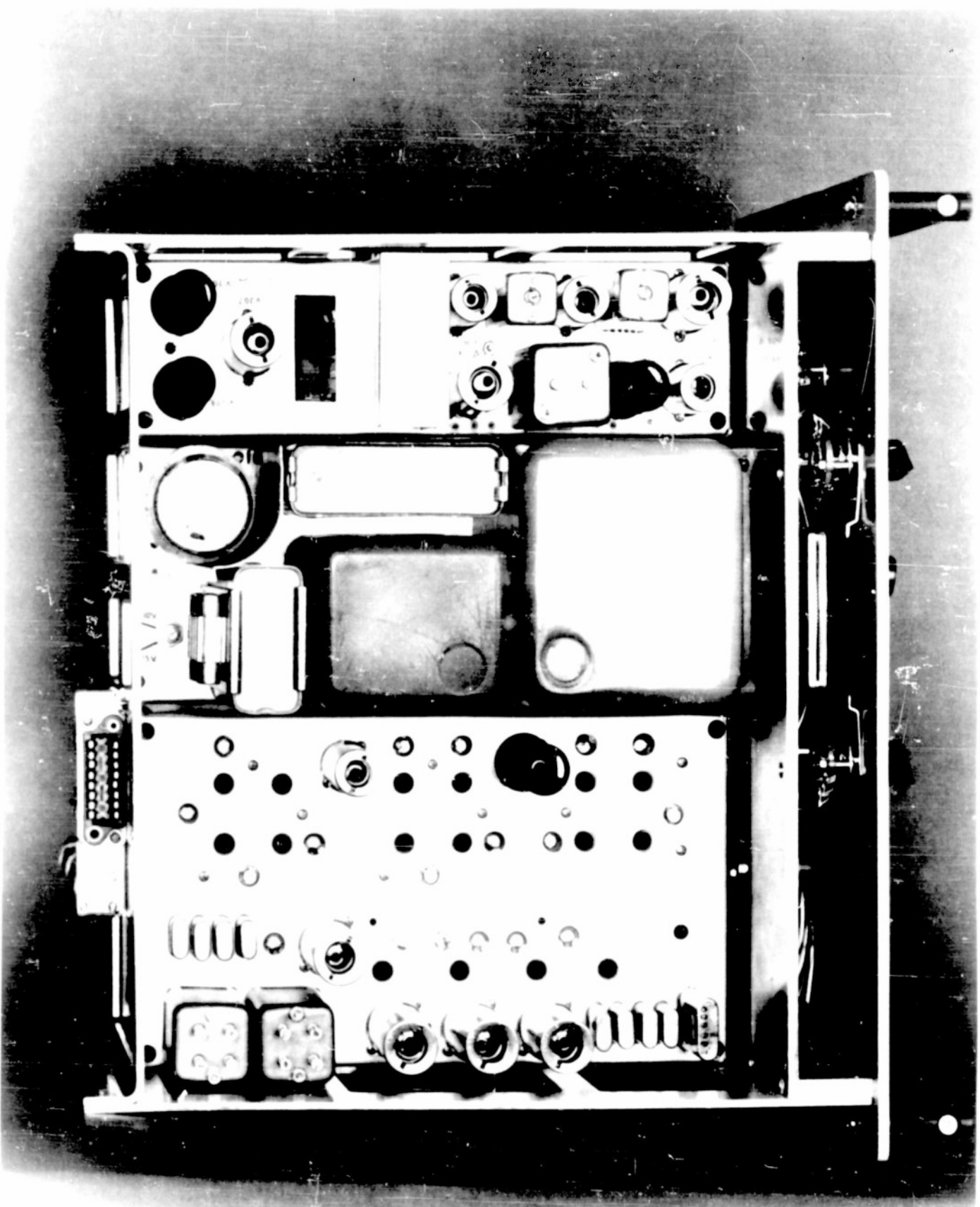
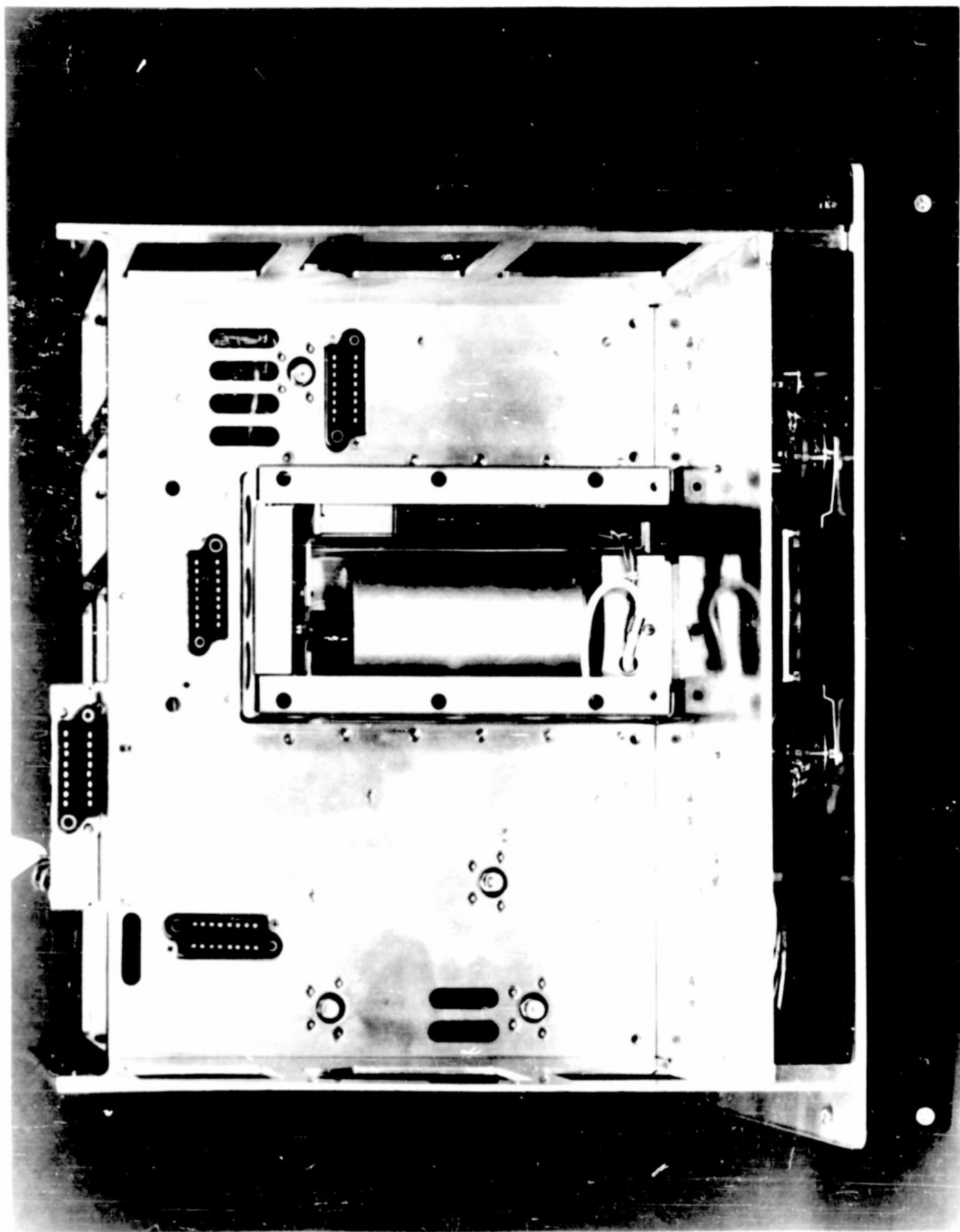

Figure 5. Tuning Dials





1  
2  
3  
4  
5  
6  
7  
8  
9  
10  
11  
12  
13  
14  
15  
16  
17  
18  
19  
20  
21  
22  
23  
24  
25  
26  
27  
28  
29  
30  
31  
32  
33  
34  
35  
36  
37  
38  
39  
40  
41  
42  
43  
44  
45  
46  
47  
48  
49  
50



F O O D M T V M R

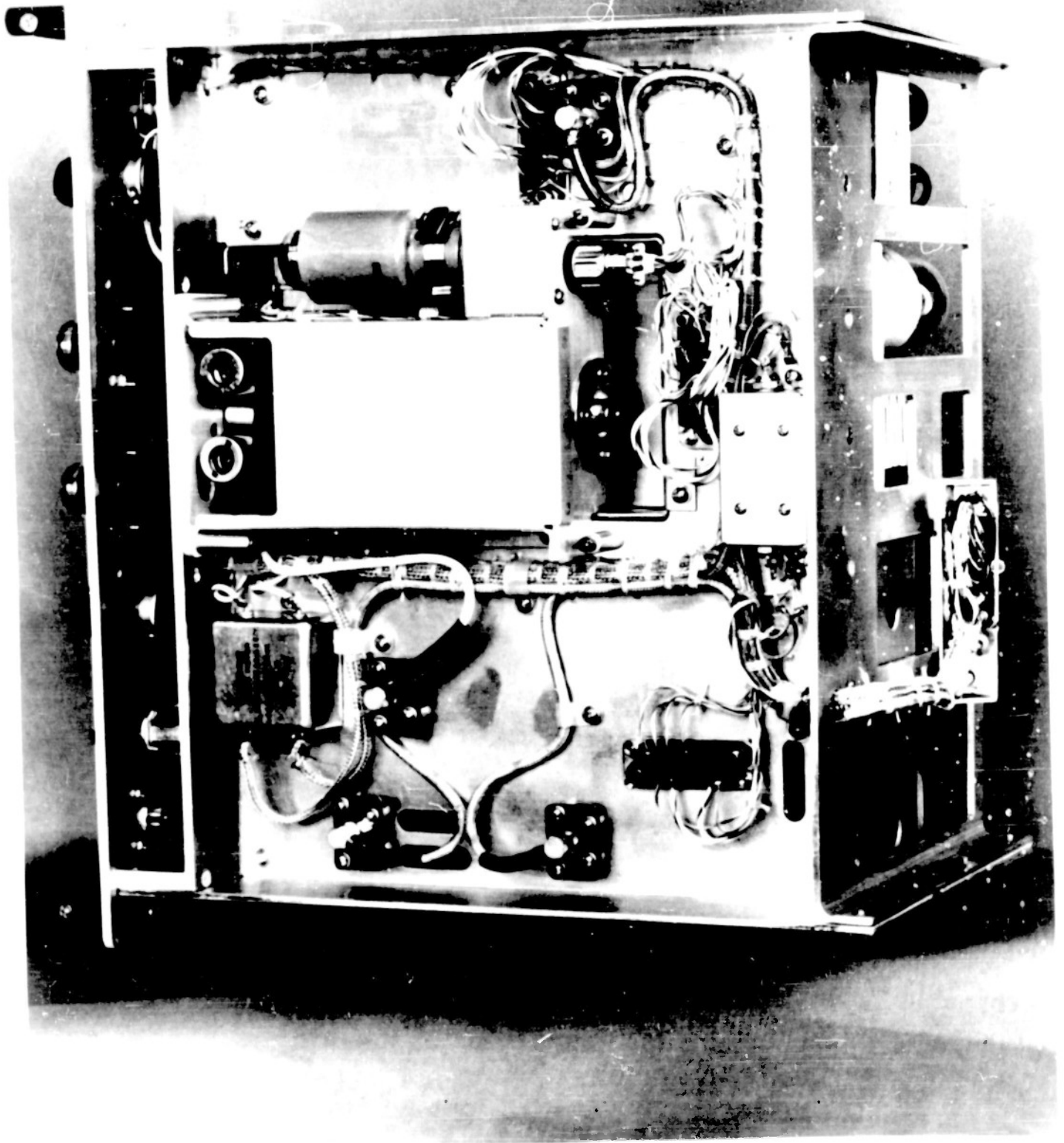

F. D. M. 7

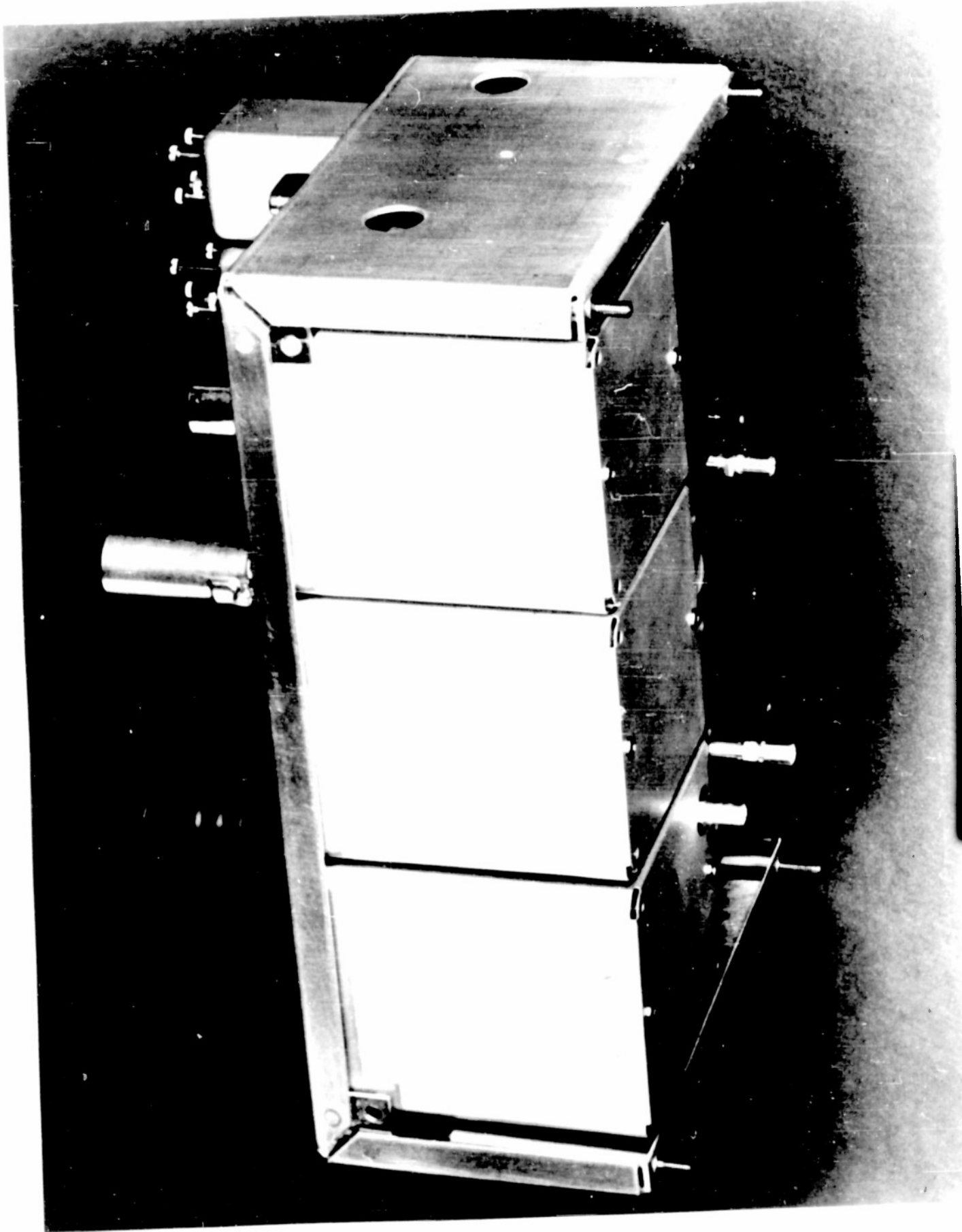

Figure 9. Front End Module

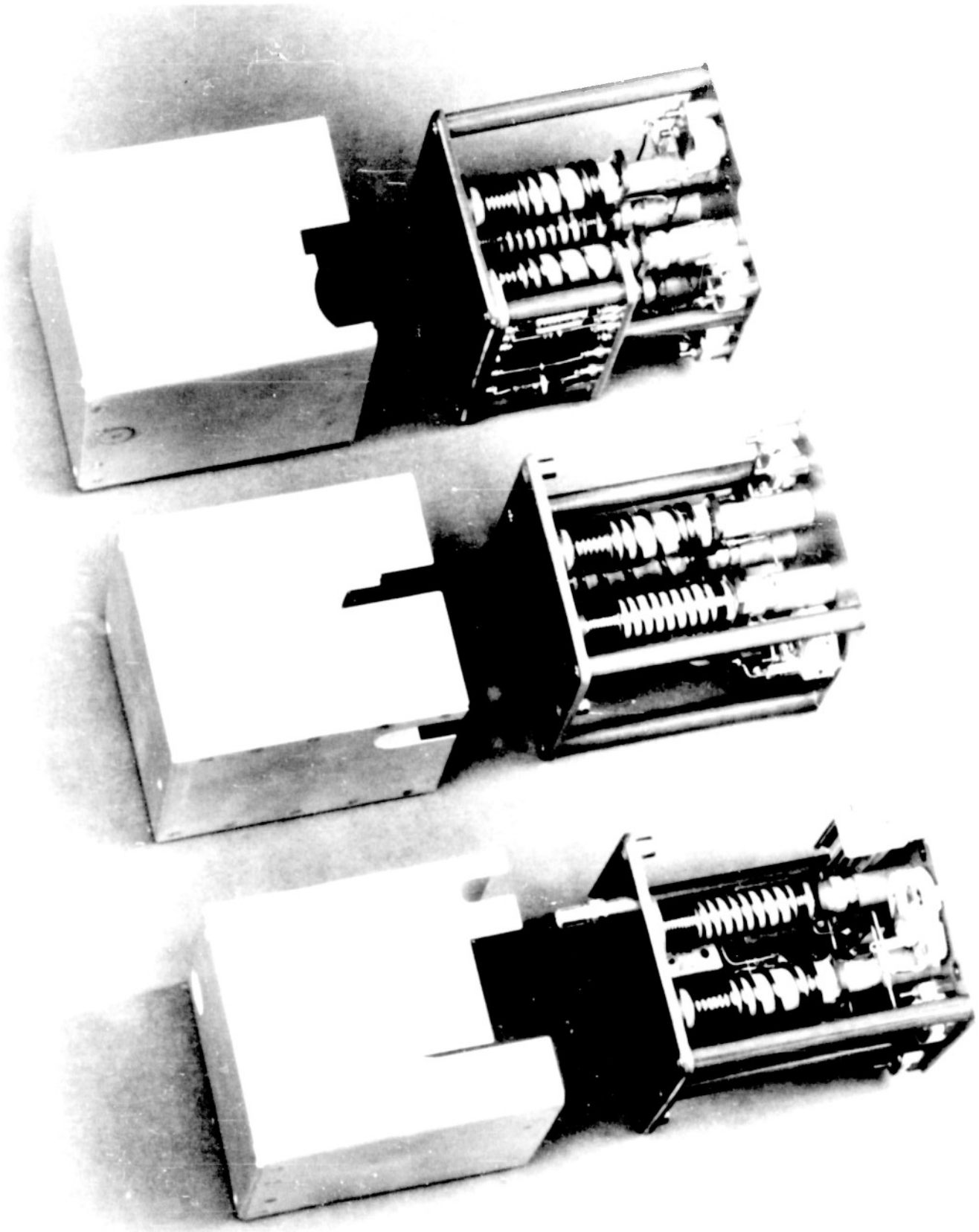

Figure 10. R. F. Coil Sub-assemblies

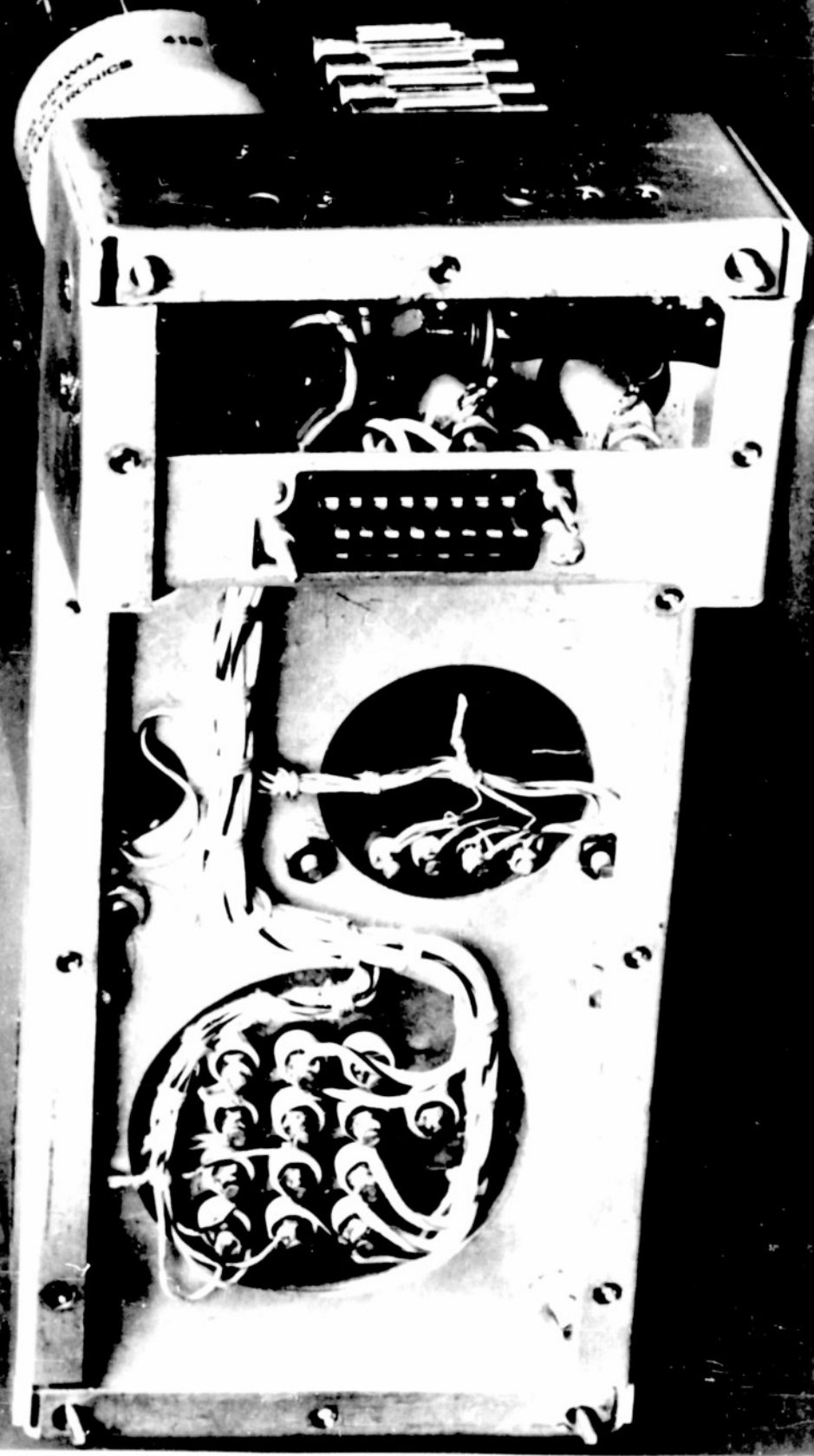

Figure 11. Power Supply Module

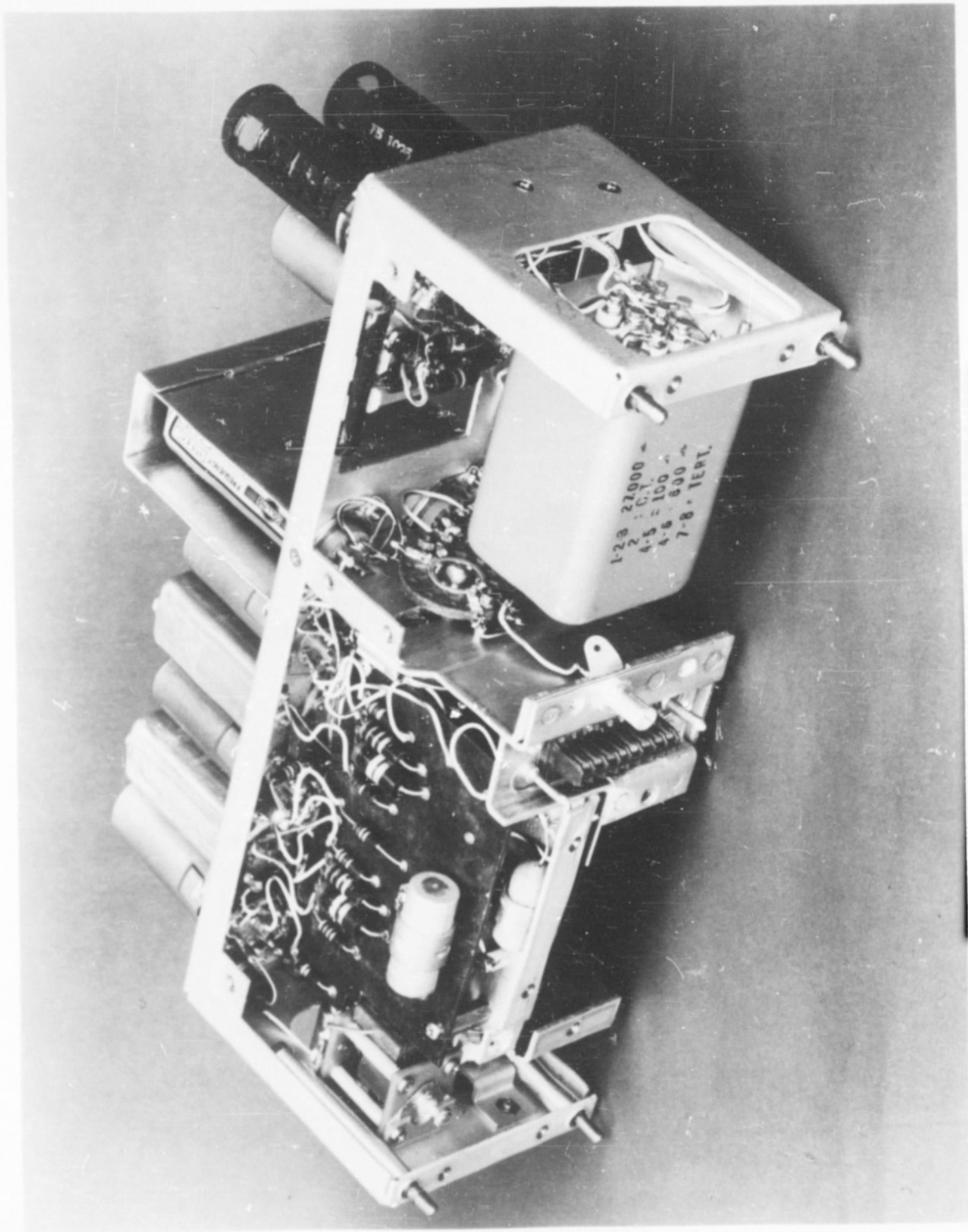

Figure 12. I. F. Audio Module

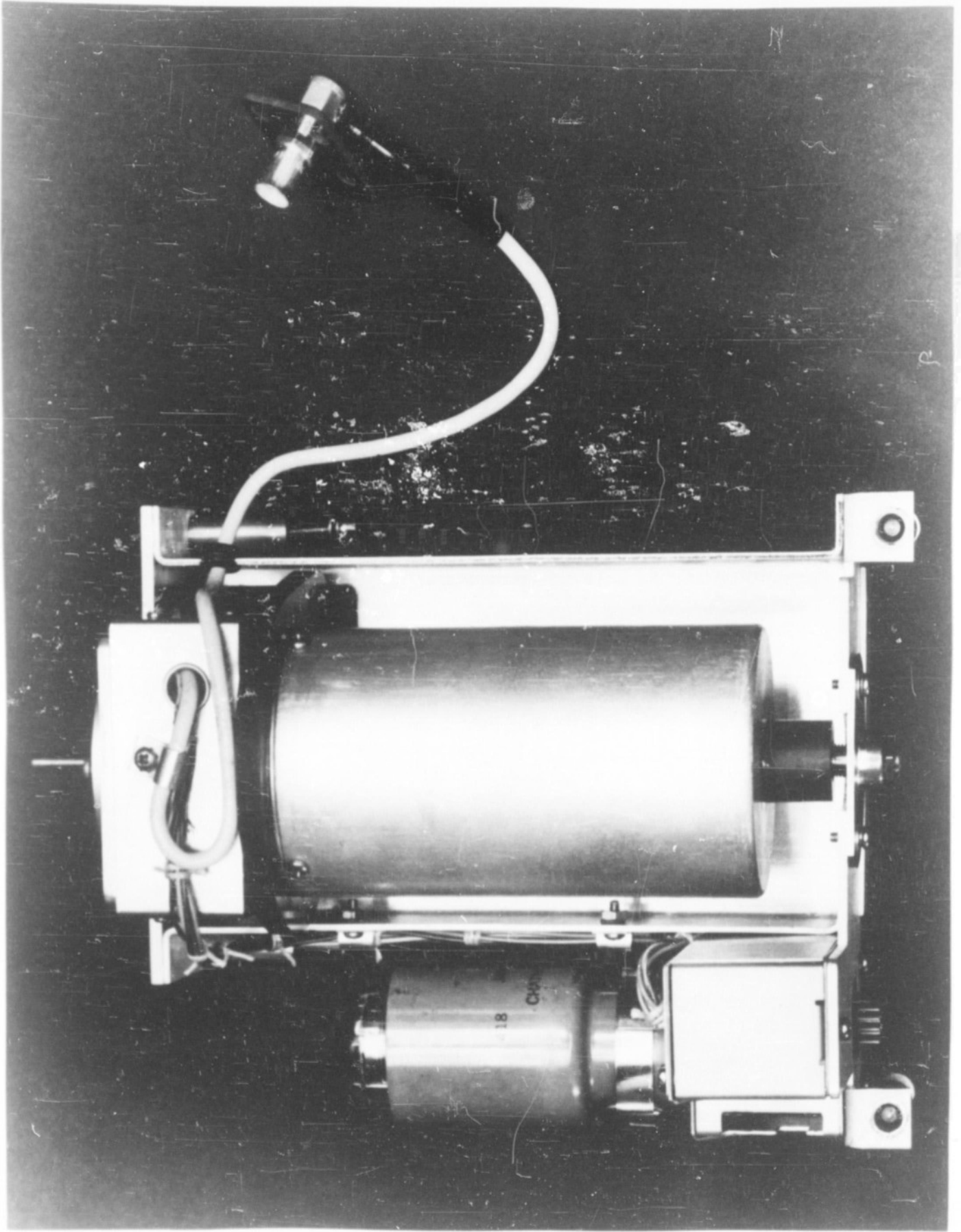

Figure 13. M. O. Unit



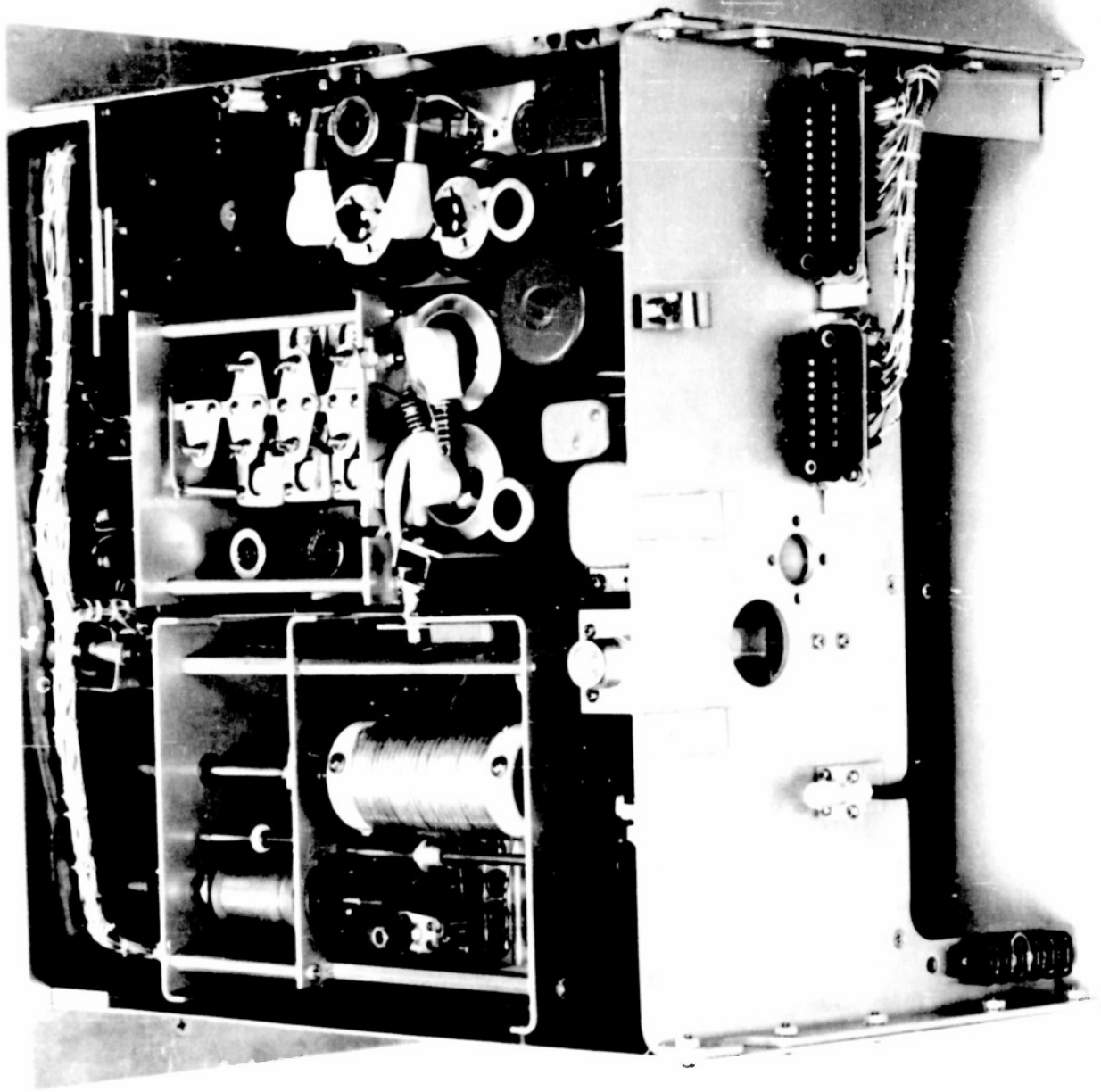

Figure 14. Transmitter, Top View

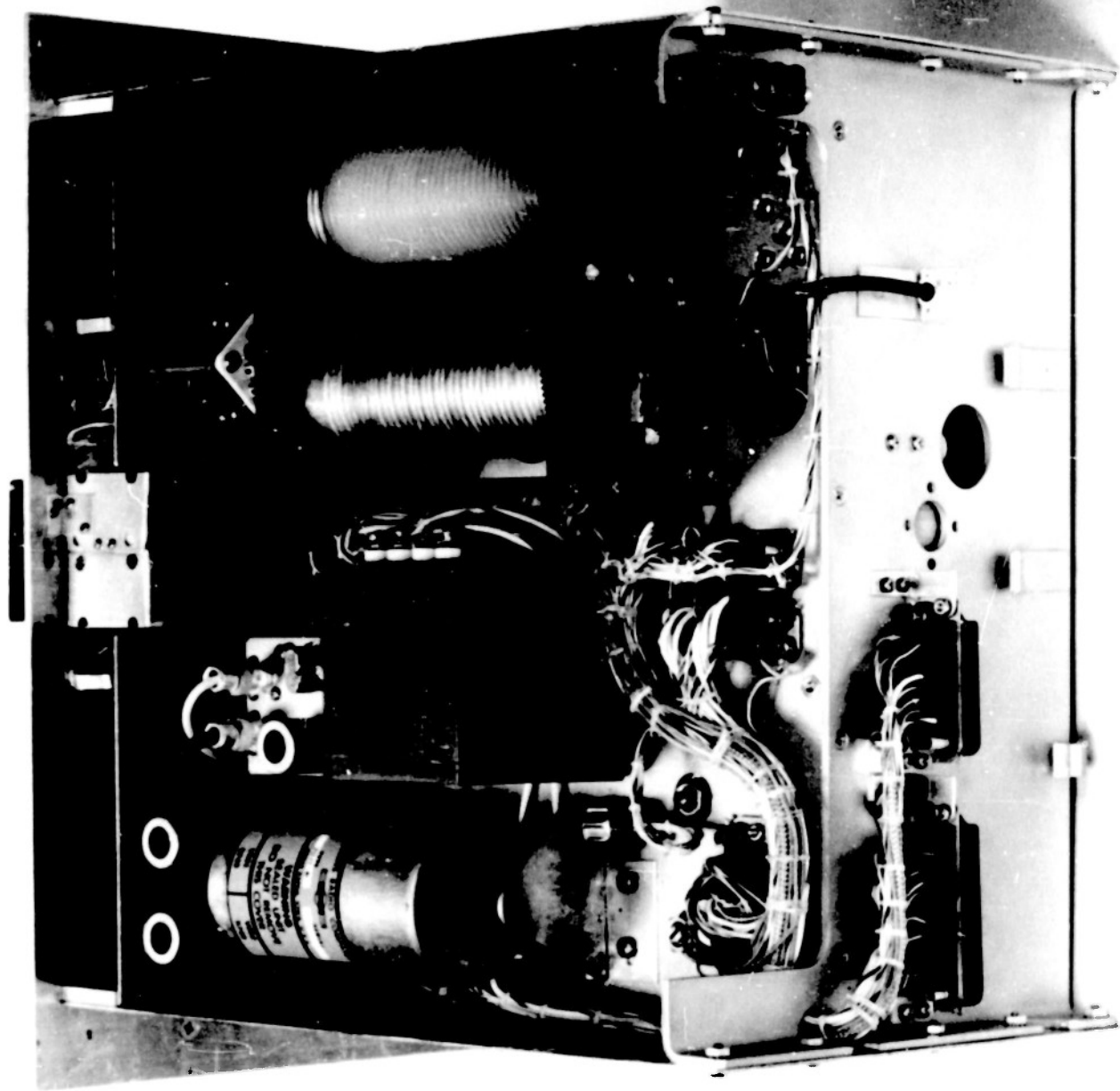

Figure 26. Transmitter, Bottom View

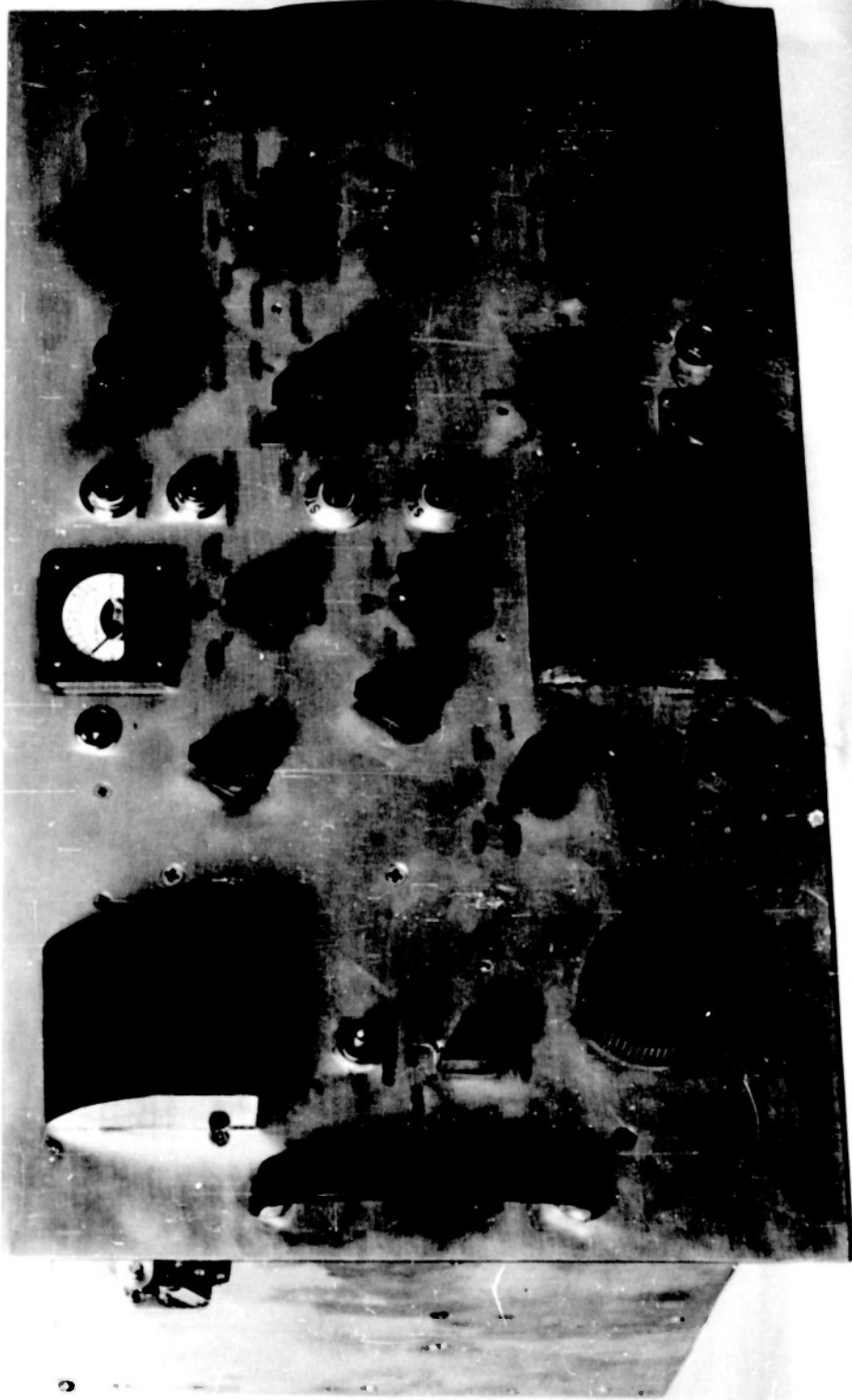

Figure 1. Transmitter, Front View

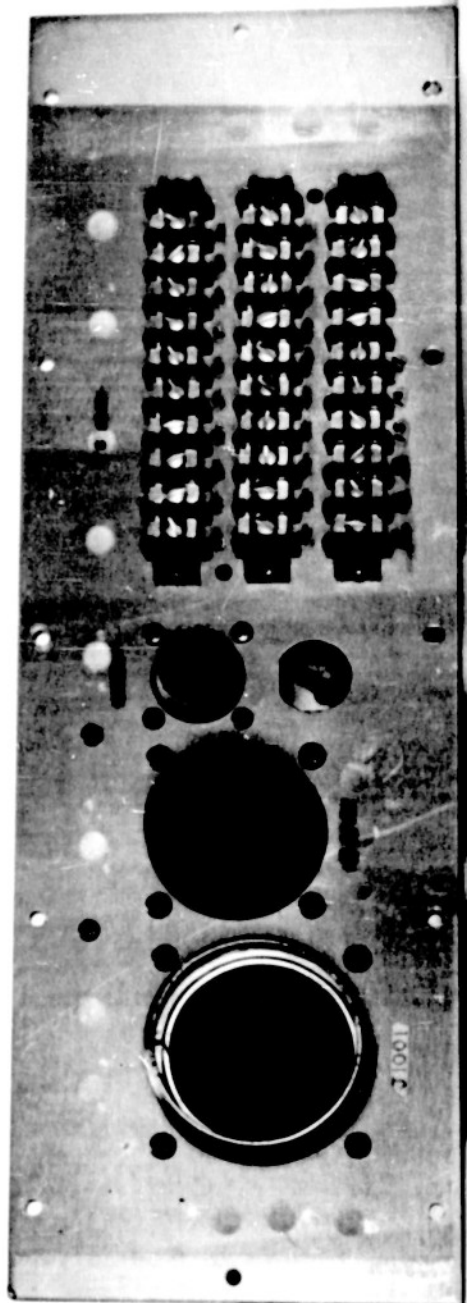

Figure 21. Filter Box, Rear View

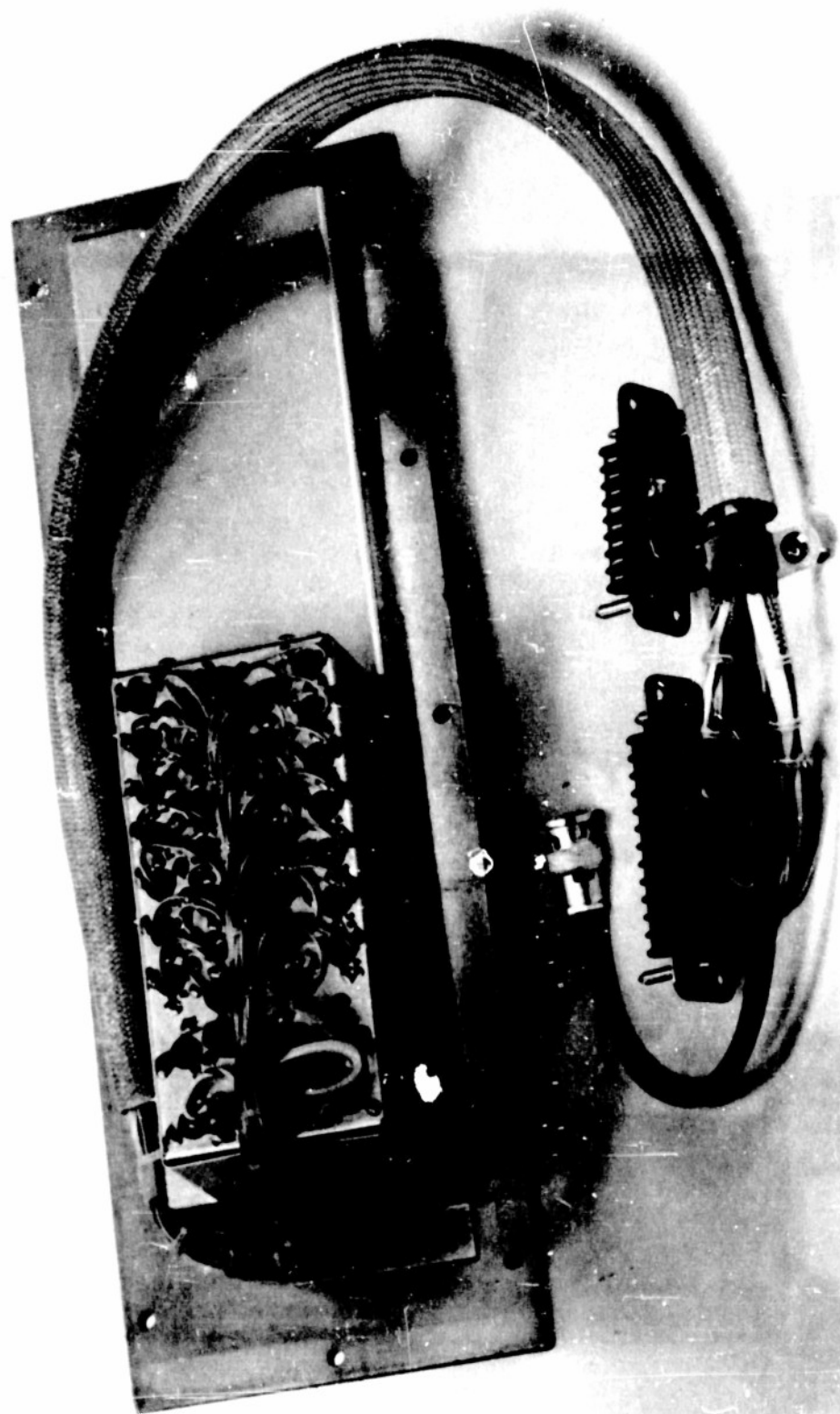

Figure 6. Filter Box with Folding Case

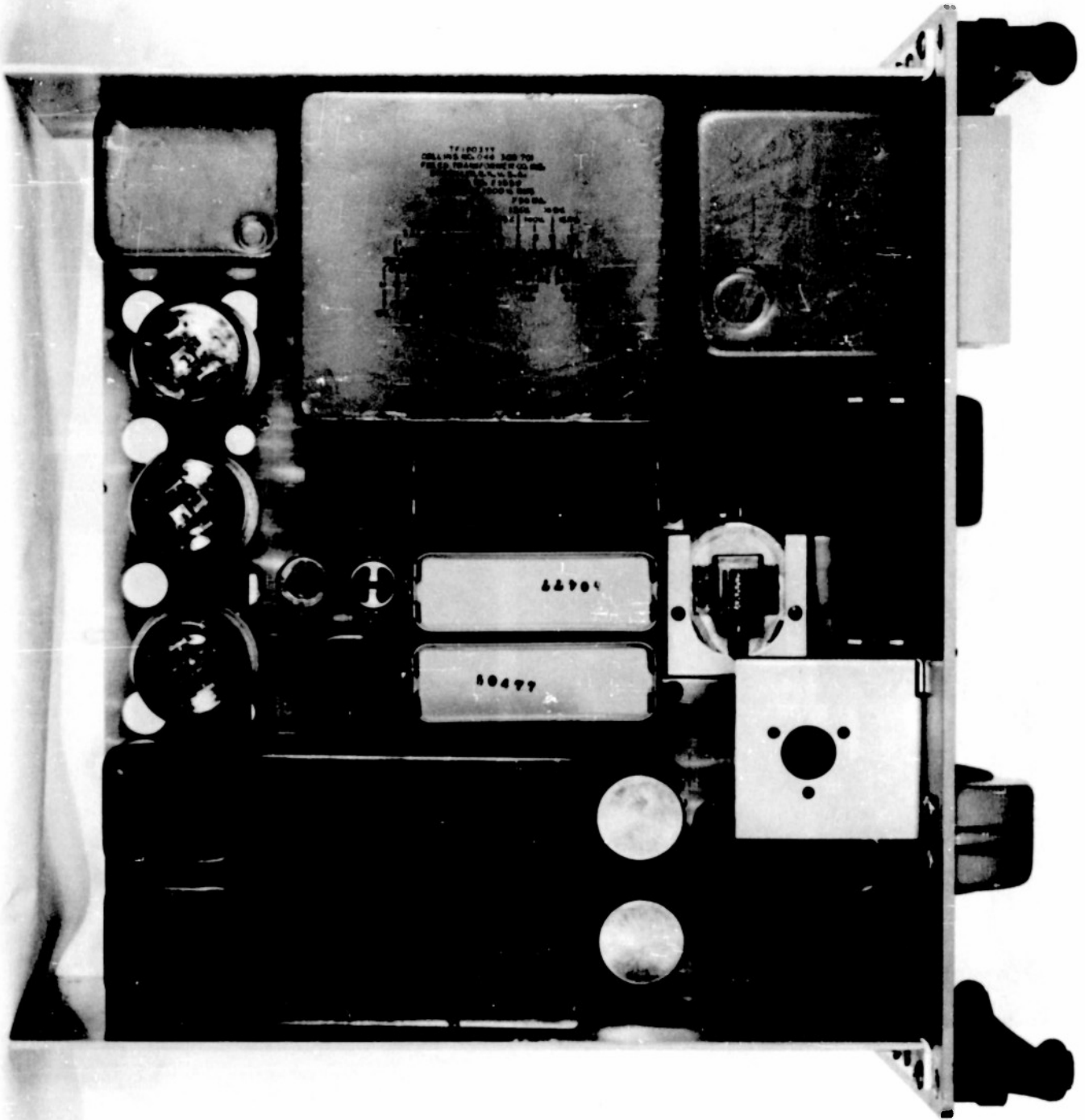

Figure 19. AC Power Supply, Top View

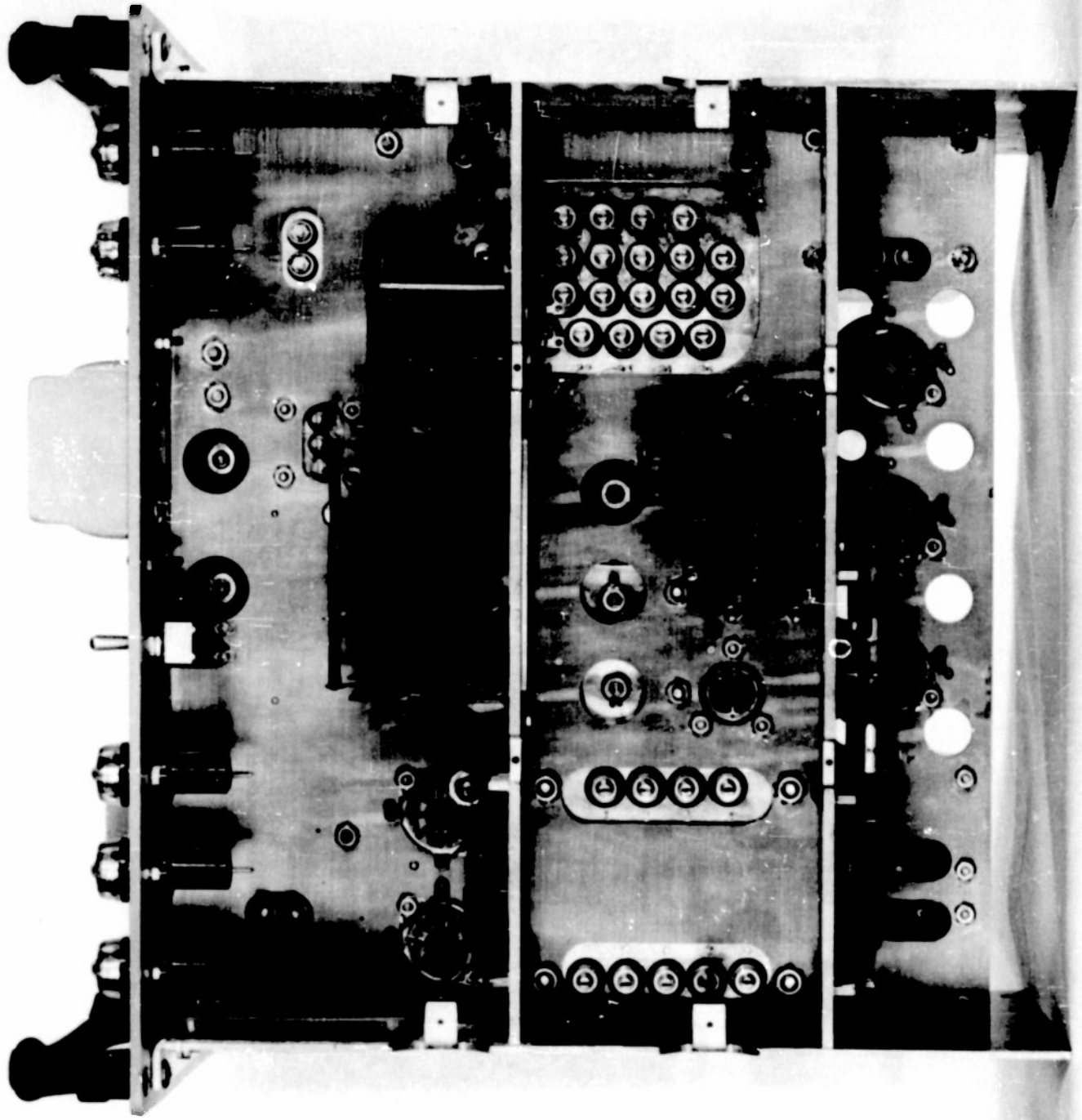

Figure 20. AC Power Supply, Bottom View

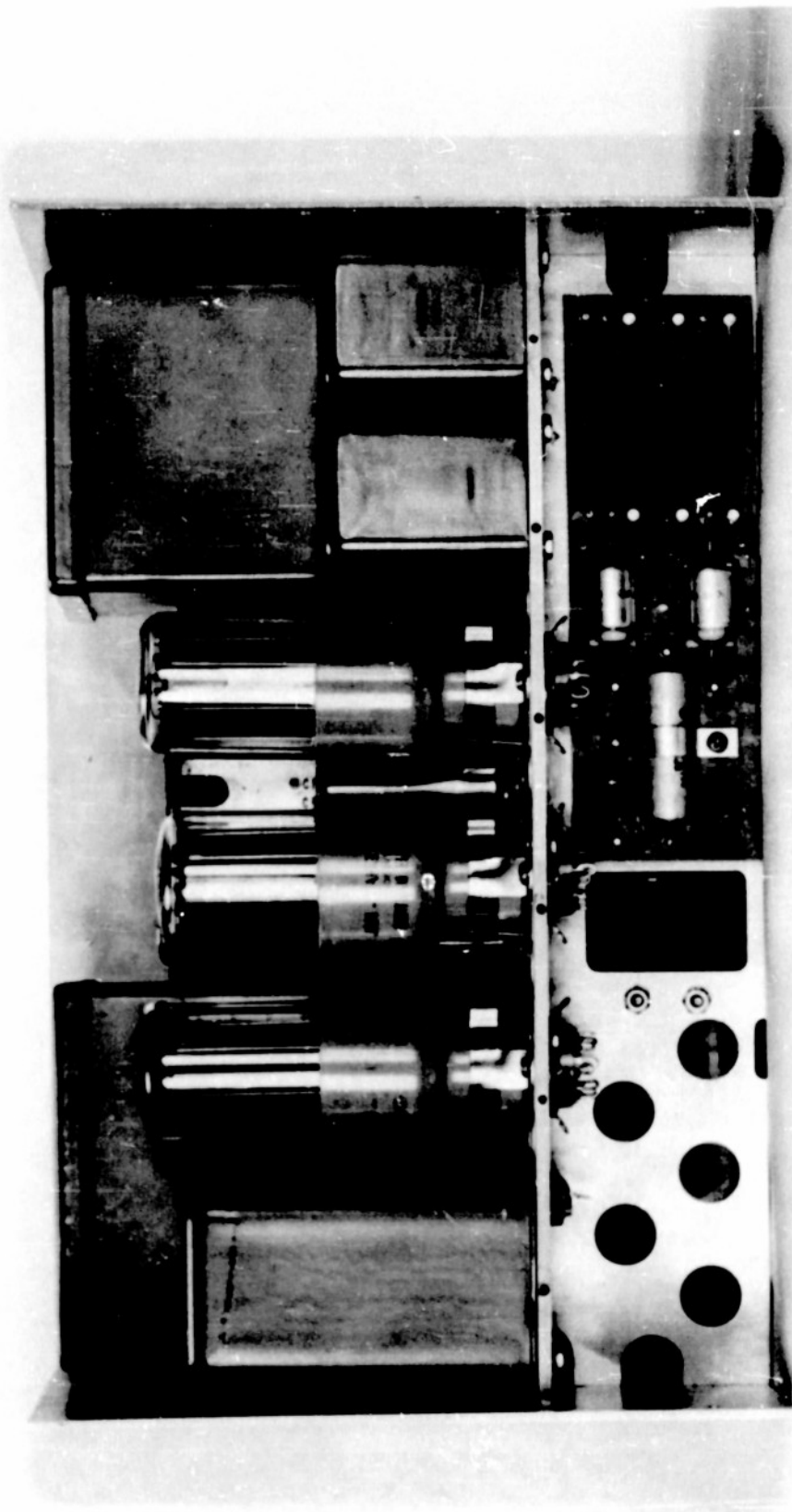

Figure 21. AC Power Supply, Rear View



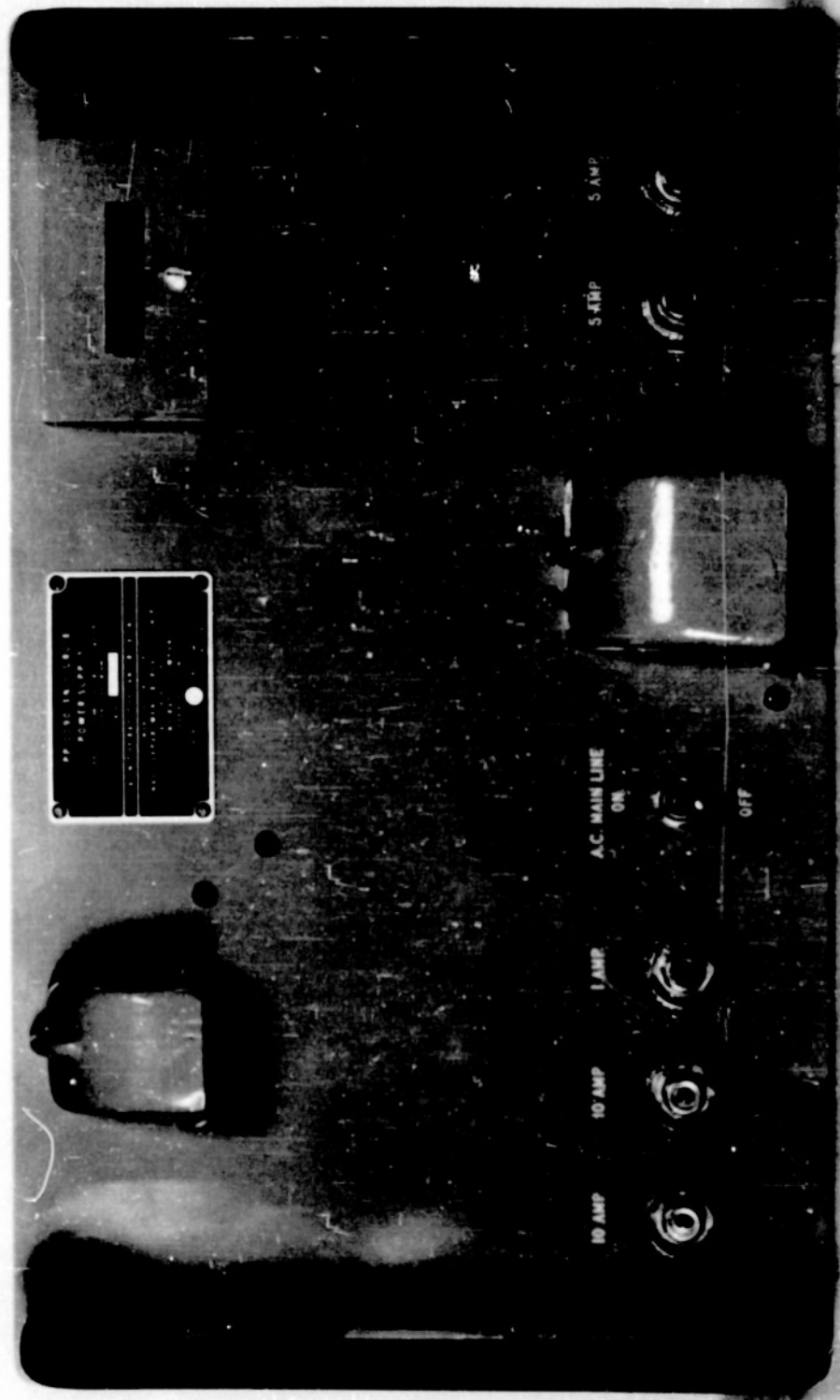

Figure 22. AC Power Supply, Front View

# Armed Services Technical Information Agency

Because of our limited supply, you are requested to return this copy WHEN IT HAS SERVED YOUR PURPOSE so that it may be made available to other requesters. Your cooperation will be appreciated.

# AD

# 39099

NOTICE: WHEN GOVERNMENT OR OTHER DRAWINGS, SPECIFICATIONS OR OTHER DATA ARE USED FOR ANY PURPOSE OTHER THAN IN CONNECTION WITH A DEFINITELY RELATED GOVERNMENT PROCUREMENT OPERATION, THE U. S. GOVERNMENT THEREBY INCURS NO RESPONSIBILITY, NOR ANY OBLIGATION WHATSOEVER; AND THE FACT THAT THE GOVERNMENT MAY HAVE FORMULATED, FURNISHED, OR IN ANY WAY SUPPLIED THE SAID DRAWINGS, SPECIFICATIONS, OR OTHER DATA IS NOT TO BE REGARDED BY IMPLICATION OR OTHERWISE AS IN ANY MANNER LICENSING THE HOLDER OR ANY OTHER PERSON OR CORPORATION, OR CONVEYING ANY RIGHTS OR PERMISSION TO MANUFACTURE, USE OR SELL ANY PATENTED INVENTION THAT MAY IN ANY WAY BE RELATED THERETO.

Reproduced by  
DOCUMENT SERVICE CENTER  
KNCTT BUILDING, DAYTON, 2, OHIO

# UNCLASSIFIED