

AD-A075 245 NAVAL OCEAN SYSTEMS CENTER SAN DIEGO CA  
AN/URT-23 A(V) POWER SUPPLY FEASIBILITY STUDY.(U)  
UNCLASSIFIED MAR 79 C W ROSENGRANT  
NOSC/TR-428

F/G 10/2

NL

| OF |  
AD  
A075245



END  
DATE  
FILMED  
11-79  
DDC

LEVEL

12

# NOSC

NOSC TR 428

NOSC TR 428

ADA075245

Technical Report 428

## AN/URT-23A(V) POWER SUPPLY FEASIBILITY STUDY

CW Rosengrant

March 1979

DDC FILE COPY

DDC  
RECEIVED  
OCT 19 1979  
RECEIVED  
E

Approved for public release; distribution unlimited

NAVAL OCEAN SYSTEMS CENTER  
SAN DIEGO, CALIFORNIA 92152

79 10 17 057



NAVAL OCEAN SYSTEMS CENTER, SAN DIEGO, CA 92152

AN ACTIVITY OF THE NAVAL MATERIAL COMMAND

RR GAVAZZI, CAPT USN

Commander

HL BLOOD

Technical Director

### ADMINISTRATIVE INFORMATION

This feasibility study was prepared for S Zanin of the Naval Ocean Systems Center, Code 8134, under 63520N, X0712-CC, X0712001, 813-CM68. The work was performed by the Power Electronics Branch, Code 9234, Naval Ocean Systems Center. The study is concerned with obtaining switching-mode power supply volume estimates in order to determine the feasibility of replacing the AN/URT-23A(V), 400-Hz power supply with a power supply that will operate on 60-Hz power.

Released by  
CE Holland, Head  
Advanced Applications  
Division

Under authority of  
CD Pierson, Jr., Head  
Electronics Engineering and Sciences  
Department

### METRIC CONVERSION TABLE

To convert from  
inch<sup>3</sup>

to  
metre<sup>3</sup>

Multiply by  
 $1.639 \times 10^{-5}$

UNCLASSIFIED

SECURITY CLASSIFICATION OF THIS PAGE (When Data Entered)

REPORT DOCUMENTATION PAGE		READ INSTRUCTIONS BEFORE COMPLETING FORM
1. REPORT NUMBER NOSC Technical Report 428 (TR 428)	2. GOVT ACCESSION NO.	3. RECIPIENT'S CATALOG NUMBER
4. TITLE (and Subtitle) AN/URT-23A(V) POWER SUPPLY FEASIBILITY STUDY	5. TYPE OF REPORT & PERIOD COVERED Final Technical Evaluation Report, March 1979	6. PERFORMING ORG. REPORT NUMBER
7. AUTHOR(s) CW/Rosengrant	8. CONTRACT OR GRANT NUMBER(s)	
9. PERFORMING ORGANIZATION NAME AND ADDRESS Naval Ocean Systems Center San Diego, CA 92152	10. PROGRAM ELEMENT, PROJECT, TASK AREA & WORK UNIT NUMBERS 63520N X0712 CC X0712001 813-CM68	
11. CONTROLLING OFFICE NAME AND ADDRESS Naval Electronic Systems Command (PME 117) Department of the Navy Washington, DC 20360	12. REPORT DATE March 1979	
14. MONITORING AGENCY NAME & ADDRESS (if different from Controlling Office)	13. NUMBER OF PAGES 51	15. SECURITY CLASS. (of this report) Unclassified
16. DISTRIBUTION STATEMENT (of this Report) Approved for public release; distribution unlimited.		15a. DECLASSIFICATION/DOWNGRADING SCHEDULE
17. DISTRIBUTION STATEMENT (of the abstract entered in Block 20, if different from Report)		
18. SUPPLEMENTARY NOTES		
19. KEY WORDS (Continue on reverse side if necessary and identify by block number)		
Direct current power	Power converter	URT-23A(V)
Electric power	Power requirements	60-Hz power
Feasibility study	Power supplies	400-Hz power
Power consumption	SSN(X)	
20. ABSTRACT (Continue on reverse side if necessary and identify by block number)		
<p>This report was prepared as part of a study to develop an advanced communications center for the SSN(X) submarine. The objective was to determine the feasibility of replacing or modifying the 400-Hz power supply of the URT-23A(V) high frequency transmitting set to permit operation from 60-Hz power without the external power supply. The feasibility of powering the transmitter set with the same power supply and dc or 400-Hz sources was also of concern.</p> <p>Block diagrams of the 60- and 400-Hz power supply configurations were created and used in studying the power requirements of the transmitter set. Power requirements and consumption estimates were made for the</p>		

DD FORM 1 JAN 73 1473

EDITION OF 1 NOV 65 IS OBSOLETE  
S/N 0102-LF-014-6601

UNCLASSIFIED

SECURITY CLASSIFICATION OF THIS PAGE (When Data Entered)

393 159

JOB

UNCLASSIFIED

SECURITY CLASSIFICATION OF THIS PAGE (When Data Entered)

20. Continued.

major functions of the transmitter set. This information was used in paper designs for two switching mode power supplies and one inverter power supply. These designs were used in the selection of parts that would satisfy the design parameters. The dimensions of the selected parts were used in estimating the volume of a hypothetical power supply configuration. Results indicate that it is possible to replace the 400-Hz power supply in the rf amplifier with a power supply that increases the height of the rf amplifier by 2.2 inches, operates from dc, 60- or 400-Hz power, and opens up 70 cubic inches in the rf amplifier for future growth.

The report recommends that the feasibility of the proposed supply design be demonstrated by building a breadboard model that can operate from DoD-STD-1399, section 300 shipboard power and satisfy the power requirements of the transmitter set.

UNCLASSIFIED

SECURITY CLASSIFICATION OF THIS PAGE (When Data Entered)

## OBJECTIVE

Determine the feasibility of modifying or replacing the 400-Hz power supply of the URT-23A(V) to operate from 60-Hz power without the external power supply. The feasibility of powering the transmitter set with the same power supply and dc or 400-Hz sources is also of concern.

## RESULTS

1. Block diagrams of the 60- and 400-Hz power supply configurations were created and used to study the power requirements of the transmitter set. The primary functional blocks of the transmitter set were examined for power consumption levels. Based on the transmitter power distribution configuration and power consumption estimates, paper designs for two switching-mode power supplies and one inverter power supply were produced.
2. Volume estimates of these power supplies were made by using actual parts that satisfied the design parameters. The results of the power supply volume estimates indicate that it is possible to replace the rf amplifier 400-Hz power supply with a power supply that increases the rf amplifier height by 2.2 inches, operates from dc, 60- or 400-Hz power, and opens up 70 in<sup>3</sup> in the rf amplifier for future growth.

## RECOMMENDATION

Demonstrate the feasibility of the proposed power supply design by building a breadboard model that can operate from DoD-STD-1399, section 300 shipboard power and satisfy the power requirements of the AN/URT-23A(V) transmitter.

Accession For	
NTIS GRA&I	<input checked="" type="checkbox"/>
DPC TAB	<input type="checkbox"/>
Unannounced	<input type="checkbox"/>
Justification	
By _____	
Distribution/ _____	
Availability Codes	
Dist	Avail and/or special
A	

## INTRODUCTION

This work was performed to determine the feasibility of replacing or modifying the internal power supply of the AN/URT-23A(V) high-frequency transmitting set to permit operation from 60-Hz power sources. Current operation of the AN/URT-23A(V) from 60-Hz power sources requires a separate optional power supply (PP-3916A/UR), while operation from 400-Hz power sources is accomplished via a power supply internal to the rf amplifier assembly (AM-3924A(P)/UR). Utilization of 60-Hz power is the preferred approach. Space is critical in many of the radio set installations so the purpose of this study is to determine the feasibility of powering the radio set from 60-Hz sources without the use of the external power supply. The feasibility of powering the radio set via the same power supply from dc and 400-Hz sources is also of concern.

## DESCRIPTION OF URT-23 TRANSMITTER

The AN/URT-23A(V) is a 1-kW radio transmitter capable of transmitting on the frequency band of 2.0 to 29.9999 MHz. The transmitter may transmit in continuous wave (CW), amplitude modulation (AM), radio teletype (RATT), upper side band (USB), lower side band (LSB), independent side band (ISB), and ISB/RATT.

The transmitter set (fig 1) may be powered by any one of three sources: 115 V/3 $\phi$ /400 Hz; 208 V/3 $\phi$ /60 Hz; and 440 V/3 $\phi$ /60 Hz. 400-Hz power is converted in the 400-Hz power supply, PP-3917A/UR, that is contained in the Radio Frequency Amplifier, AM-3924A(P)/URT. 60-Hz power is converted in the 60-Hz power supply, PP-3916A/UR, a separate unit in the transmitter set.

PRECEDING PAGE BLANK

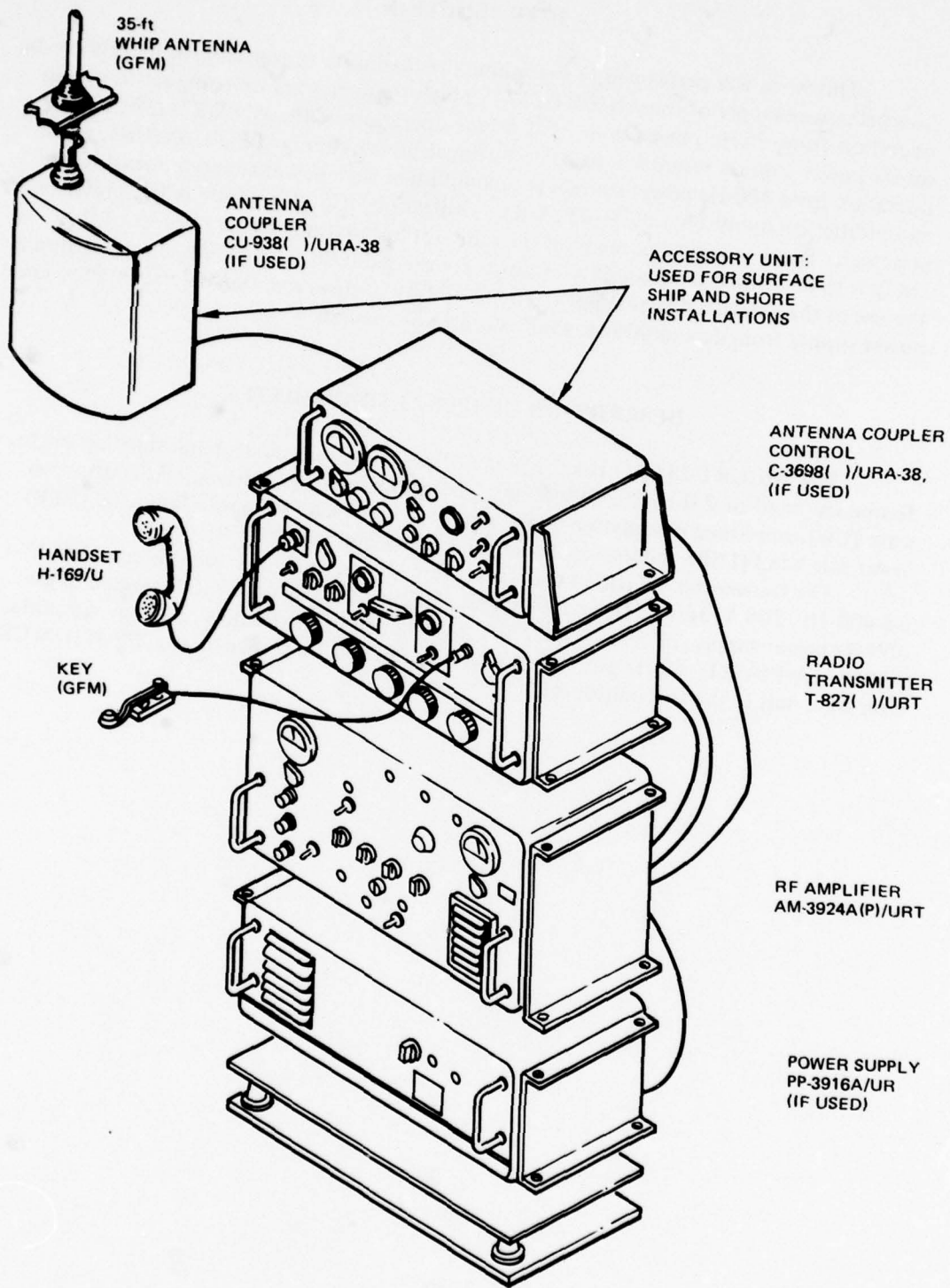

Figure 1. AN/URT-23A(V) transmitter set.



## 400-Hz POWER

Figure 2 is a block diagram that describes how 400-Hz power is utilized. When the primary power switch, S4, is closed, single-phase 115-V power is applied to the exciter. The exciter produces a 28-V dc voltage when it is set to standby or operate that causes standby relay K2 to close.

When relay K2 closes, power is delivered to the 400-Hz blower motor, final amplifier filaments, driver amplifier filaments, APC-PPC\* power control board, and dc power control board.

The dc power control board produces 28, 20, 12, and 11 V dc. The 12-V dc voltage is supplied to remote units, and the 28-, 20-, and 12-V dc voltages are used by the power amplifier control circuits. The 28-V dc voltage causes band switch motor drive relay K3 and time delay relay K4 to close.

When relay K3 closes, the 60-Hz inverter receives 28-V dc power, which allows the band switch motor to operate. Relay K4 is the time delay relay that closes 3 minutes after 20 V dc is applied to it. When K4 closes, 28 V dc is applied to operate relay K1. Relay K1 is closed by the 28-V dc voltage, but only if a 20-V dc voltage from the exciter is also applied to it. This 20-V dc voltage is supplied by the exciter only when it is in the operate mode (ie, AM, CW, USB, ISB, LSB, RATT, or ISB/RATT). When K1 closes, 115-V, three-phase 400-Hz power is applied to the driver and final amplifier plate circuits.

---

\*APC-PPC: Average power control – peak power control

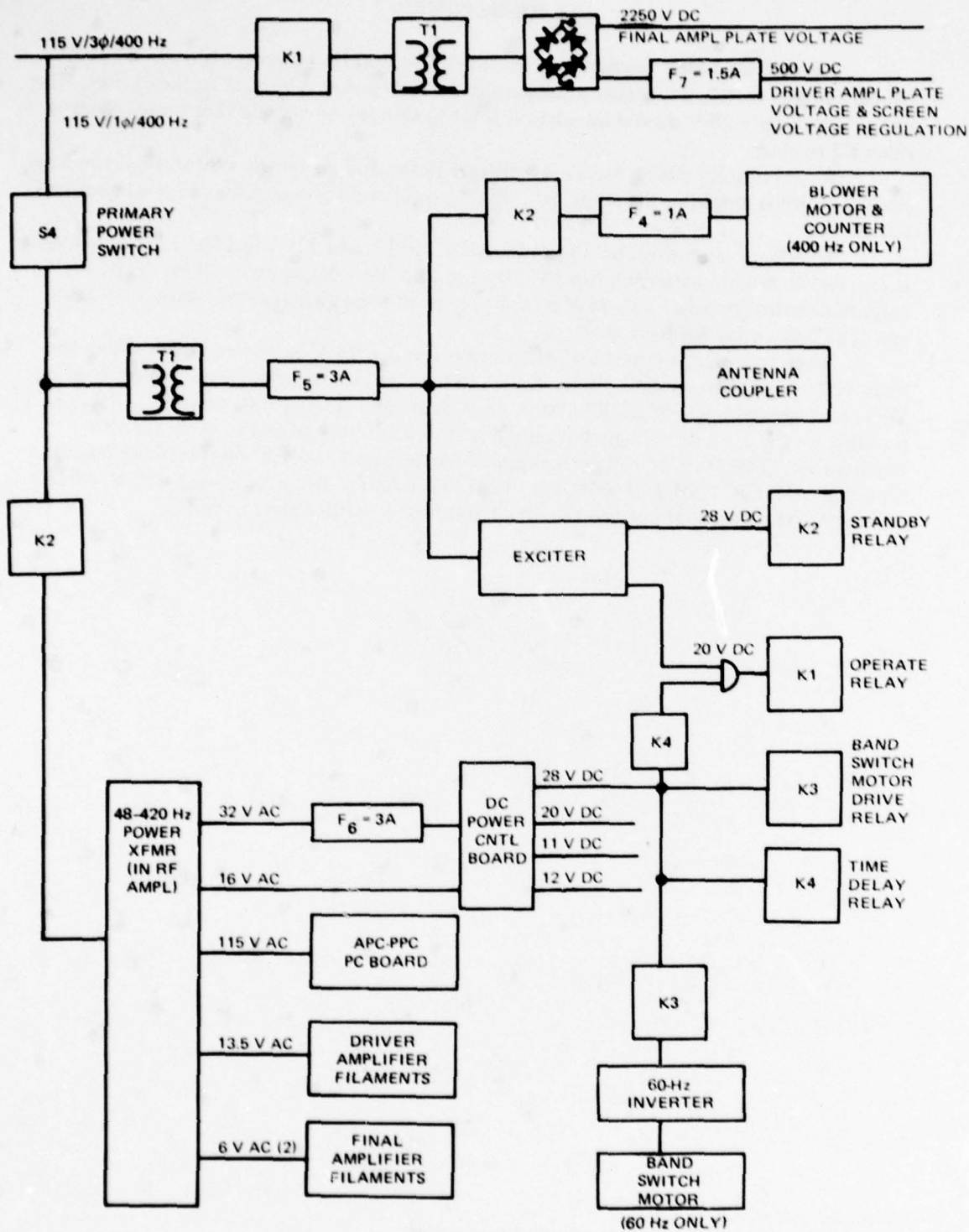

Figure 2. 400-Hz power distribution block diagram.

### 60-Hz POWER

The configuration for operating with 60 Hz is shown in figure 3. Operating with 60 Hz is the same as operating with 400 Hz with the following exceptions:

1. The 400-Hz blower motor operates from a 400-Hz inverter.
2. The band switch motor receives 60-Hz power directly from switch S-4.
3. The 440- and 208-V ac voltages are changed to usable voltages through different transformer connections.

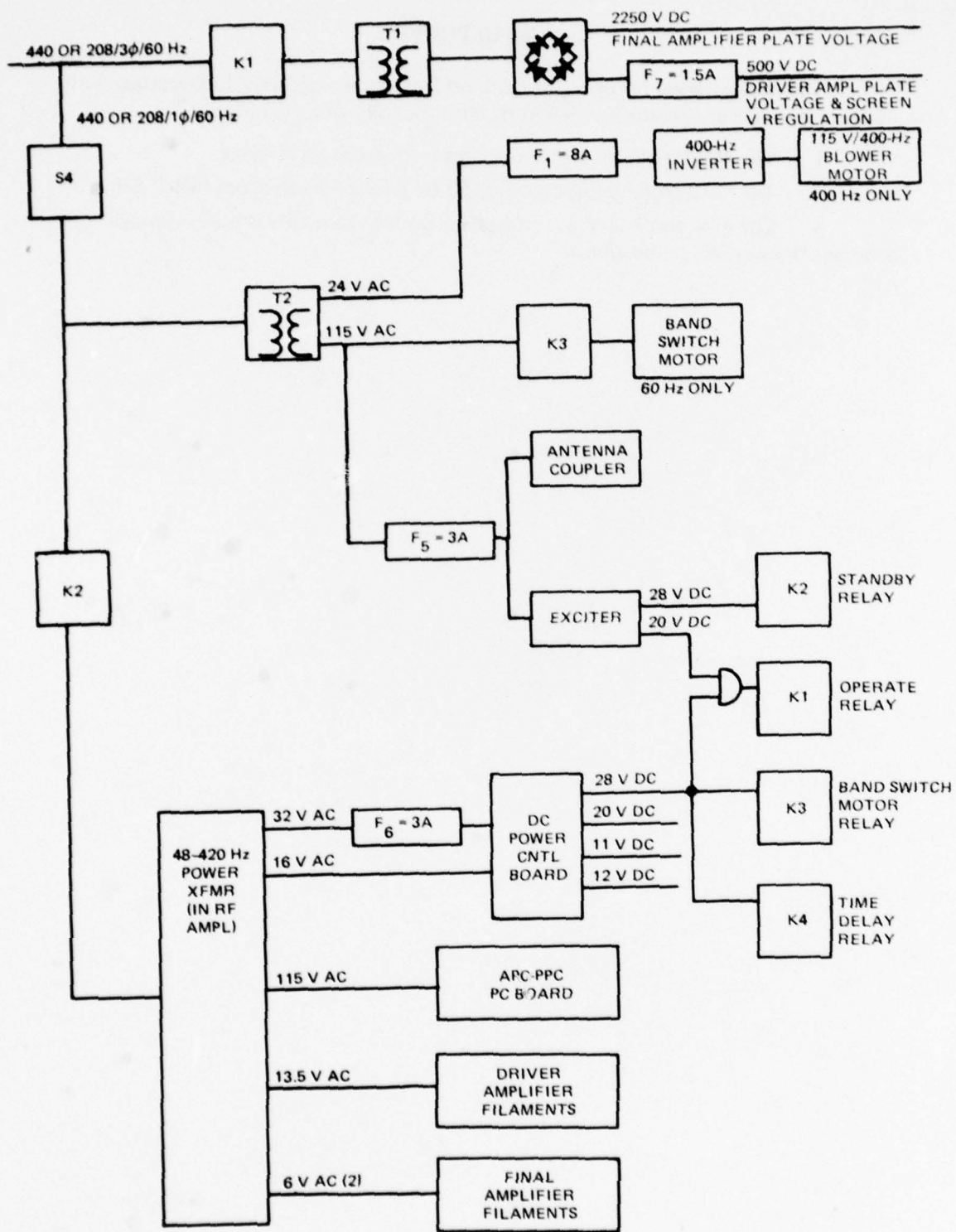

Figure 3. 60-Hz power distribution block diagram.

### 60- AND 400-Hz POWER REQUIREMENTS

Table 1 represents approximations for the amount of power that is required by each of the functions powered by the 48-420-Hz transformer. Table 2 represents similar figures, but for the main power branches of the transmitter set. The estimate for total maximum power consumed by the transmitter set is 4569 watts — the specified power consumption is 4500 watts. Details of the calculation for these estimated figures are contained in appendix A.

Table 1. 48-420-Hz transformer power users.

LINE	POWER (WATTS)	USER
16 V ac	3.2	auxiliary equipment
32 V ac	64	dc control board
13.5 V ac	135	driver ampl filaments
6 V ac	65	final ampl filaments
115 V ac	69	APC-PPC P.C. board
	Total 336.2	

Table 2. Main branch power users.

LINE	POWER (WATTS)	USER
2250 V dc	3375	final ampl plate voltage
500 V dc	500	driver ampl plate voltage
115 V ac	230	exciter & antenna coupler
24 V ac	63	400-Hz blower motor
	65	400-Hz inverter
115 V ac	336	48-420-Hz transformer (table 1)
	Total 4569	

### 60- AND 400-Hz POWER SUPPLY VOLUMES

A primary consideration when examining an alternative power supply is the volume occupied by the present power supply. The rf amplifier contains the 400-Hz power supply. Also within the rf amplifier is the 48-420-Hz power transformer that services the filaments and control boards.

The 60-Hz power supply occupies its own unit, but it also delivers power to the 48-420-Hz transformer. For both power supplies, the transformers are designed to the frequency of the line power they operate on. The only exception is the 48-420-Hz power transformer. Table 3 lists the power supplies, some of their components, and the volumes that they occupy.

Table 3. Power supply volumes.

ITEM	VOLUME
48-420-Hz power transformer	70.56 in <sup>3</sup> (4 × 3.6 × 4.9)
400-Hz power supply	711.48 in <sup>3</sup> (10.5 × 15.4 × 4.4)
power transformer T1	18.19 in <sup>3</sup> (2.12 × 3.12 × 2.75)
power transformer T2	156.4 in <sup>3</sup> (5.93 × 6.31 × 4.18)
60-Hz inverter	82.59 in <sup>3</sup> (6.81 × 4.125 × 2.94)
60-Hz power supply	2344 in <sup>3</sup> (7.1 × 17.38 × 19)
power transformer	684 in <sup>3</sup> (6 × 12 × 9.5)*
400-Hz inverter	22.5 in <sup>3</sup> (2.5 × 1.5 × 6)*

\*Approximate

### PROPOSED 60-Hz POWER SUPPLY DESIGN

A 60-Hz power supply design that operates from 200 V/3 $\phi$ /60 Hz is described in appendices B, C, and D. The design consists of three basic sections that are illustrated in figure 4.

1. 2250-V dc power supply
2. 500-V dc power supply
3. 400-Hz inverter power supply

The power supply was designed for the 200 V/3 $\phi$ /60 Hz power option of the AN/URT-23A(V) transmitter. A power supply designed to meet the new 115 V or 440 V/3 $\phi$ /60 Hz shipboard power specified by DoD-STD-1399, section 300 will have the same volume within a first order approximation since the same amount of power is being delivered by the power supply. The different voltages would be handled by converter transformer turn ratios.

The power supply designs include volume estimates based on actual components selected to satisfy the parameters of the design. The volume estimates are summarized in table 4.

The 2250-V dc power supply section powers the final amplifier plates. This line is the single largest user of power in the transmitter set and draws an estimated maximum of 3375 watts. The power supply design is a switching-mode regulator, buck-boost configuration, operating at 20 kHz. The design estimate for this power supply assumed lossless circuit elements since switching regulators normally have high efficiency. In any case, circuit elements are derated sufficiently to account for some inefficiency.

The 500-V dc power supply section supplies power for the driver amplifier plates and for screen voltage regulation. This line is the second largest user of power in the transmitter set and draws an estimated maximum of 500 watts. This power supply is also a switching-mode regulator operating in a buck-boost configuration at 20 kHz. Again lossless circuit elements were assumed but actual parts derated.

The 400-Hz inverter supplies 115 V/1 $\phi$  power to the blower motor, band switch motor, antenna coupler, exciter, and other users. Of these users, only the band switch motor needs to be modified for 400-Hz operation. Power supplied by the inverter to these

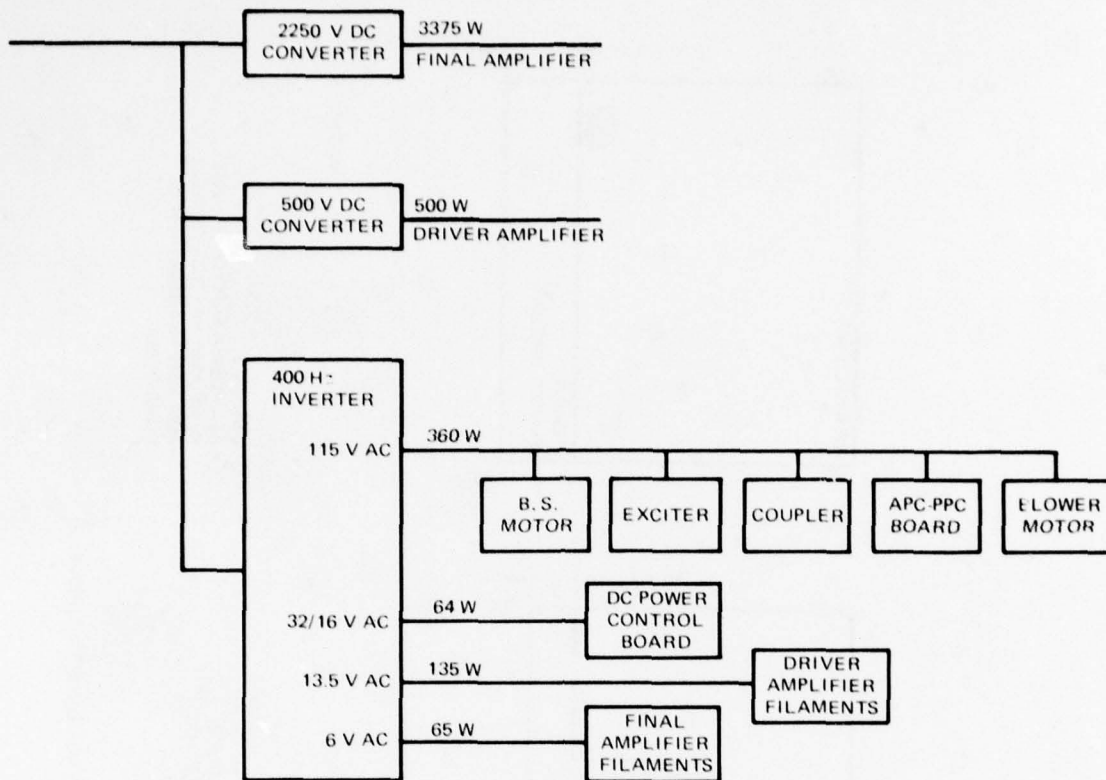

Figure 4. Proposed power supply.

Table 4. Volume estimates of 60-Hz power supply.

SECTION	VOLUME, in <sup>3</sup>
2250 V dc (3375 W)	256 (4 × 4 × 16)
500 V dc (500 W)	160 (3 × 4 × 16)
400-Hz inverter (676 W)	288 (6 × 6 × 8)
Filtering (estimate)	100
Cooling (estimate)	100
Total	904

users is estimated to be 676 watts. A 40% efficiency rate was imposed on this inverter, which is rather harsh for such a device but takes into account a worst-case situation. This constraint resulted in a larger inverter volume than would have been obtained with a more common 60% or 70% efficiency specification.

The present 400-Hz power supply occupies 355 in<sup>3</sup>. The alternative design occupies 904 in<sup>3</sup>. Power supply configuration options are illustrated in figure 5 that will accommodate the proposed power supply in an enlarged rf amplifier (option A), or separate chassis (option B). Both options leave volume open in the rf amplifier for future growth.

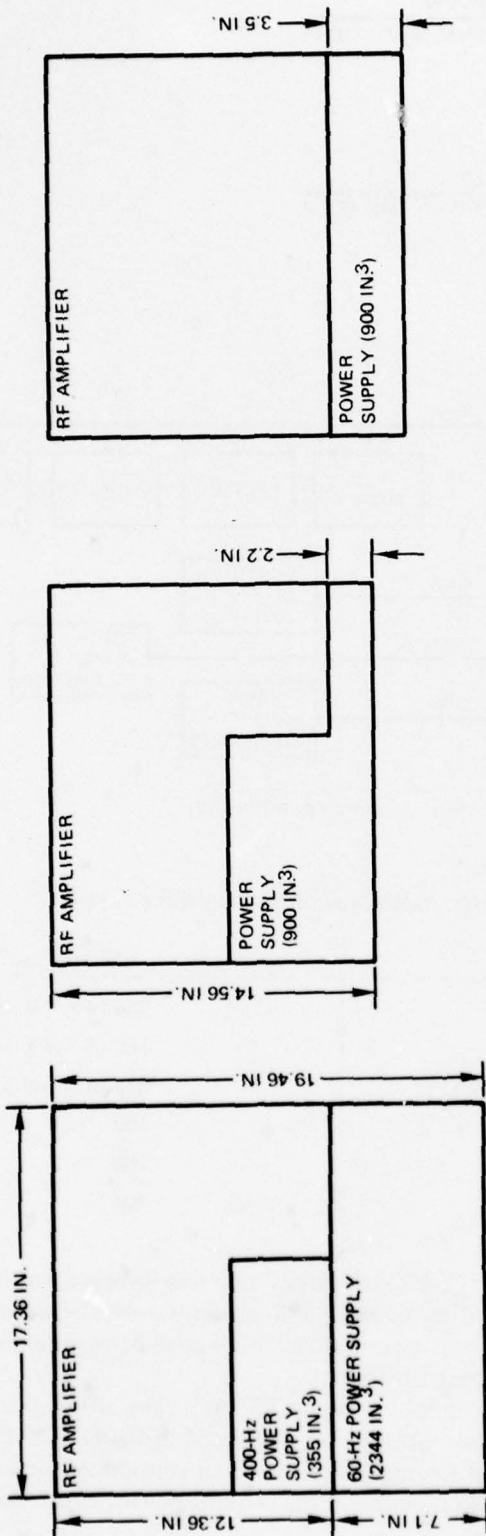

PRESENT CONFIGURATION

OPTION A  
 • 48-420-Hz TRANSFORMER VOLUME AVAILABLE FOR NEW TRANSMITTER FUNCTIONS

OPTION B  
 • ALL POWER SUPPLY VOLUME IN RF AMPLIFIER AVAILABLE FOR NEW TRANSMITTER FUNCTIONS

Figure 5. Power supply configuration options.



## CONCLUSIONS AND RECOMMENDATIONS

The present 400-Hz power supply can be replaced with a power supply that increases the rf amplifier height by 2.2 inches, operates from dc, 60, or 400 Hz, and opens up 70 in<sup>3</sup> in the rf amplifier for future growth.

It is recommended that the feasibility of the power supply design be verified by building a breadboard model that can operate from shipboard power as specified in DoD-STD-1399, section 300, and meet the requirements of the AN/URT-23A(V) transmitter.

## APPENDIX A: URT-23A(V) POWER CONSUMPTION ESTIMATES\*

Reference: AN/URT-23A(V) Operation and Maintenance Instructions, NAVELEX  
0967-456-9010

### 2250-V DC LINE

Delivers power to final amplifier (FA) plate

Peak RF output is 1 kW in the CW mode.

In CW mode the plate current is no greater than 750 mA for each FA tube.

There are two FA tubes in parallel.

$$\begin{aligned}\text{POWER DELIVERED ON 2250 V DC LINE} &= 2 (0.75 \times 2250) \\ &= 3375 \text{ WATTS}\end{aligned}$$

### 500-V DC LINE

No specific information on maximum current consumption was found, but the 500V dc line is fused to 1.5 A; assuming that the maximum operating current is two-thirds 1.5 A, the maximum operating current will be 1 A.

$$\begin{aligned}\text{POWER DELIVERED ON 500 V DC LINE} &= 1 \times 500 \\ &= 500 \text{ WATTS}\end{aligned}$$

### 115-V AC LINE SERVING THE ANTENNA COUPLER AND EXCITER

The antenna coupler and exciter are powered by a 115 V ac line fused at 3 A. Assuming that the maximum current delivered is two-thirds the fused value, the current delivered to the coupler and exciter is 2 A as a worst case.\*\*

$$\begin{aligned}\text{POWER DELIVERED TO 24 V AC LINE} &= 5.33 \times 24 \\ &= 128 \text{ WATTS (ROUNDED)}\end{aligned}$$

To confirm the validity of the above estimates, the following check is made. A typical inverter may operate at 65% efficiency. Assuming that this is close to the efficiency of the inverter under consideration, the maximum power being delivered to the blower by the inverter is 83.15 watts.\*\*\* This is reasonably close to the known 63 W being consumed by the blower to justify the assumptions made.

---

\*Where there was uncertainty, maximum figures were used.

\*\*In the 400-Hz distribution of power, the blower motor is also delivered power on this line, so this is a worst case estimate.

\*\*\* $0.65 \times 127.92 = 83.15$ .

The following lines deliver power from the 48-420-Hz transformer:

#### 16-V AC LINE

This voltage is rectified and regulated to 12 V dc for use by auxiliary equipment. Current is less than 0.2 A.

$$\text{POWER DELIVERED} = 0.2 \times 16 = 3.2 \text{ WATTS}$$

#### 32-V AC LINE

This line delivers power to the dc control board. It is fused to 3 A, so employing the assumption that maximum working currents are two-thirds the fused current, 2 A is the estimated maximum working current.

$$\text{POWER} = 32 \times 2 = 64 \text{ WATTS}$$

#### 12.5-V AC LINE

This line supplies power to the driver amplifier filaments. Two filaments in parallel that are specified to be 0.2 ohm each are served by this line.

$$\text{POWER} = 13.5 \times 0.1 = 135 \text{ WATTS}$$

#### 6-V AC LINE

There are two of these lines that each serve the filament to the final amplifier tube. The filaments are specified as 5.4 ohms.

$$\text{POWER} = 2 (6 \times 5.4) = 64.8 \text{ WATTS}$$

#### 115-V AC LINE

The APC-PPC\* board is powered by this line. The estimated maximum working current is 0.6A based on the characteristics of the transistors (type 2N2219A) that are served by this line.

$$\text{POWER} = 115 \times 0.6 = 69 \text{ WATTS}$$

---

\*APC-PPC: Average power control - peak power control

## APPENDIX B: DESIGN OF A 2250 V DC, 3375-W POWER SUPPLY

- Reference: (a) Switching Regulators by LL Ogborn, Associate Professor of Engineering, Purdue University  
 (b) Magnetics, Inc, Catalog MMC-100  
 (c) Magnetics, Inc, Catalog MPP-303A  
 (d) Spacecraft Transformer and Inductor Design, JPL Publication 77-35, by Colonel WT McLyman  
 (e) NOSC TR 177, J Foutz, E Kamm, 1 June 1978

The following calculations represent the basic design calculations for a power converter that will supply 2250 V dc/1.5 A to the final amplifier plates of the AN/URT-23A(V). The converter is a switching-mode regulator operating at 200 kHz in a buck-boost configuration (fig B1). The purpose of this design is to obtain an estimate of the volume that such a converter would occupy.

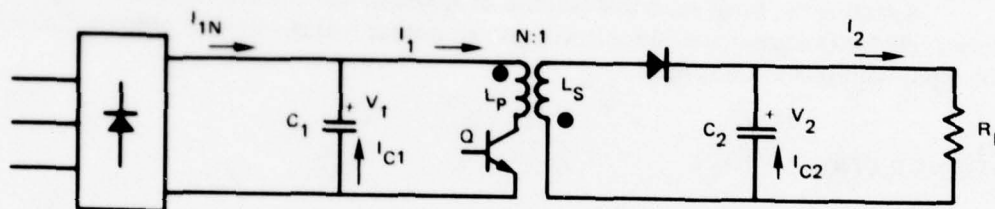

Figure B1. Buck-boost switching-mode regulator.

The input power to the converter is 200 V/3 $\phi$ /60 Hz. The required output is 2250 V/1.5 A. The calculations that follow assume that  $C_2$  is sufficiently large to keep  $V_2$  constant and that the diode, inductors, and transistor are ideal elements. Specifications for the converter are contained in table B1.

Table B1. Specifications for buck-boost converter design.

INPUT: 200 V/3 $\phi$ /60 Hz (270 V dc when rectified)  
 OUTPUT: 2500 V dc/1.5 A  
 SWITCHING FREQUENCY (f): 20 kHz  
 DUTY CYCLE: 50%

\*A boost regulator has the input voltage added to the inductor voltage when charging the output capacitor, but the buck-boost regulator has only the inductor voltage charging the output capacitor.

There are three methods of obtaining the required output voltage:

1. Adjusting the duty cycle ( $D$ ) of the switching transistor:

$$\frac{V_{in}}{V_{out}} = \frac{1 - D}{D}$$

2. Adjusting the turns ratio of transformer:

$$\frac{V_{in}}{V_{out}} = \frac{N_P}{N_S}$$

3. A combination of 1 and 2.

If only the duty cycle were used to obtain the required voltage, and a 1:1 turns ratio transformer were used in the circuit of figure B1, the transistor would experience a voltage of at least 2250 V dc across its collector and emitter when it switched off. Transistors do not commonly have a  $V_{CE}$  breakdown voltage greater than 400 V, so adjusting the duty cycle would not be a practical method of obtaining the voltage in this case.

Selecting the turns ratio as a method of achieving the required output voltage, a 50% duty cycle for  $Q$  is employed since it will give an output voltage directly proportional to the input voltage and turns ratio.

#### TURNS RATIO

$$\frac{N_P}{N_S} = \frac{V_1}{V_2}$$

$V_1$  = input voltage (270 V dc)

$V_2$  = output voltage (2250 V dc)

$N_P$  = number of turns as primary side

$N_S$  = number of turns as secondary side

$$\frac{N_S}{N_P} = \frac{270}{2250}$$

$$\frac{N_P}{N_S} = 8.333$$

This turns ratio will cause 270 V on the primary when 2250 V is on the secondary.

## WAVEFORMS

Current and voltage waveforms for the regulator of figure B1 are shown in figures B2 and B3.

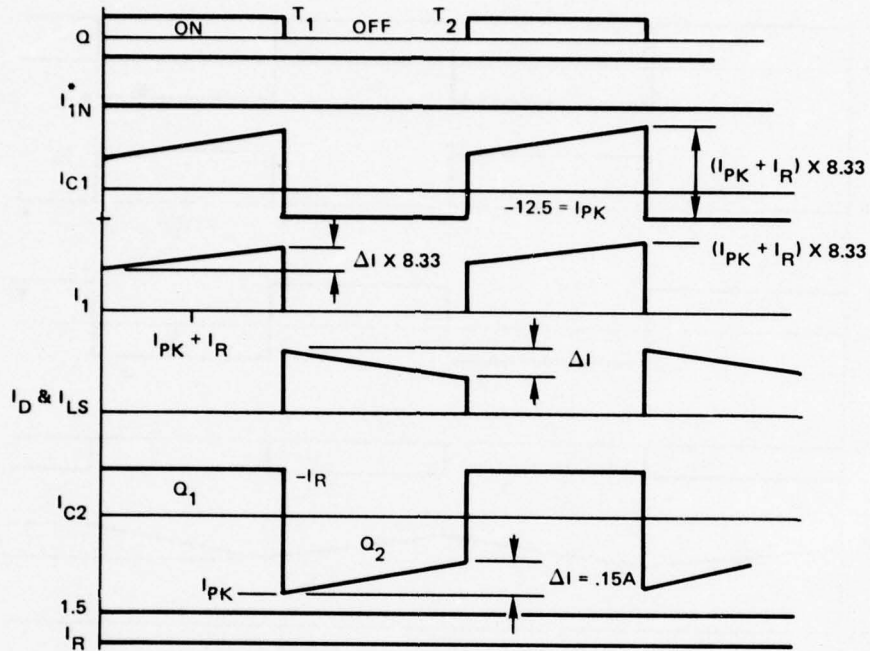

Figure B2. Buck-boost regulator current waveforms for  $D = 0.5$ .  
(Not to Scale)

\*Assumed to be smooth dc for the purposes of these figures.

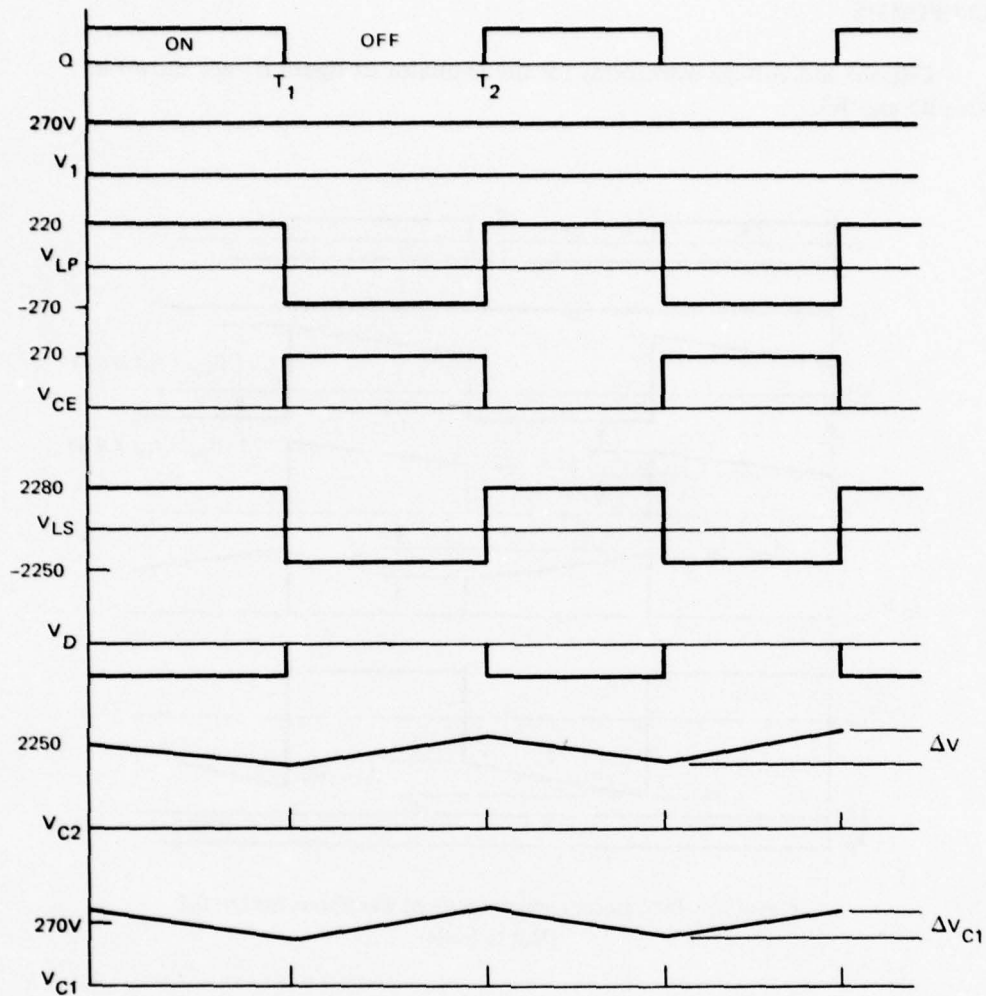

Figure B3. Buck-boost regulator voltage waveforms for  $D = 0.5$ .  
(Not to Scale)

$\Delta V$  is specified here to be 1% P/P of  $V_2$ .  $V_2$  is 2250 V dc, so  $\Delta V$  is 22.5 V P/P.  
The rms value of  $\Delta V$  is 13 V.  $\Delta V_{C1}$  is specified as 10% of  $V_1$ .  $V_{C1}$  ripple voltage is 15.6 V rms.

### $I_{PK}$

Specify  $\Delta I$  on  $C_2$  to be 10% of  $I_{RL}$ :  $\Delta I$  will be 0.15 A P/P.

$$Q = IT$$

For  $Q_1$ :  $I = 1.5$  A

$$T = 25 \mu s$$

$$\therefore Q_1 = 3.75 \times 10^{-5} \text{ coulombs}$$

$$\text{For } Q_2: Q_2 = \frac{1}{2} \times \Delta I (T_2 - T_1) + [I_{PK} - \Delta I](T_2 - T_1)$$

$$Q_1 = Q_2$$

so,

$$I_{PK} = 1.575 \text{ A}$$

### $I_D$ RMS ( $I_{LS}$ RMS)

$$I_D \text{ RMS} = \left[ \left( (I_{PK} + I_R)^2 + (I_{PK} + I_R) \Delta I + \frac{\Delta I}{3} \right)^2 \frac{T_2 - T_1}{T_2} \right]^{1/2}$$

$$I_{PK} + I_R = 3.075$$

$$\Delta I = 0.15 \text{ A}$$

$$T_2 = 50 \mu\text{s}$$

$$T_1 = 25 \mu\text{s}$$

$$I_D \text{ rms} = 2.228 \text{ A}$$

### $I_1$ RMS

$$I_1 \text{ rms} = 8.33 \times I_D \text{ rms}$$

$$\therefore I_1 \text{ rms} = 18.56 \text{ A}$$

### $I_{C1}$ RMS

The rms value of the waveform is the square root of the sum of the squares of the rms values of the trapezoidal ( $I_1$ ) and square wave ( $I_2$ ) functions.

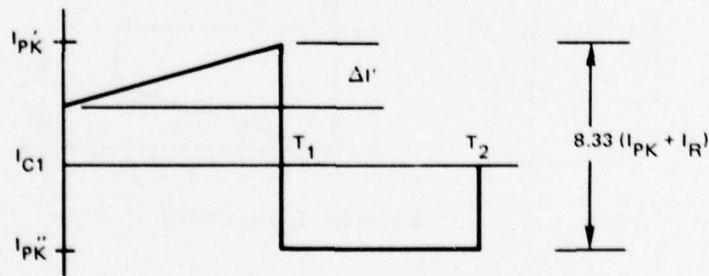

Figure B4.  $I_{C1}$  waveform.



$$\Delta I = 0.15 \text{ A}$$

$$T_1 = 25 \mu\text{s}$$

$$I_{PK} = 1.575 \text{ A}$$

$$T_2 = 50 \mu\text{s}$$

$$I_R = 1.5 \text{ A}$$

$$\Delta I' = 8.33 \Delta I = 1.25 \text{ A}$$

$$|I''_{PK}| = I_{in} = 12.5 \text{ A}$$

$$I'_{PK} = 8.33 (I_{PK} + I_R) - |I''_{PK}|$$

$$I'_{PK} = 13.1 \text{ A}$$

$$I_{C1 \text{ RMS}} = \left[ I_1^2 \text{ RMS} + I_2^2 \text{ RMS} \right]^{1/2}$$

$$I_1 \text{ RMS} = \left[ \left( (I'_{PK})^2 + I'_{PK} \Delta I' + \frac{(\Delta I')^2}{3} \right) \frac{T_1}{T_2} \right]^{1/2}$$

$$I_1 \text{ RMS} = 9.7 \text{ A}$$

$$I_2 \text{ RMS} = I''_{PK} \left[ \frac{T_1}{T_2} \right]^{1/2}$$

$$I_2 \text{ RMS} = 8.83 \text{ A}$$

$$I_{C1 \text{ RMS}} = 13.123 \text{ A}$$

### $I_{C2 \text{ RMS}}$

Referring to figure B5 and using equations from reference (d),  $I_{C2 \text{ rms}}$  may be calculated after determining the rms value of the square wave,  $I_1$ , and trapezoidal wave,  $I_2$ .

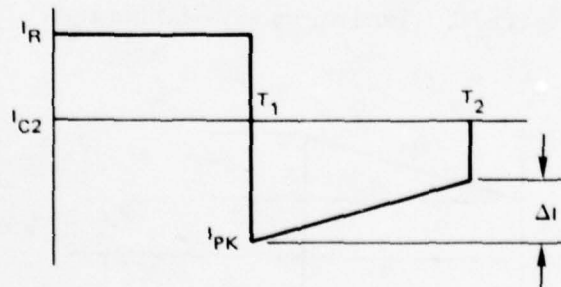

Figure B5.  $I_{C2}$  waveform.

$$I_1 \text{ RMS} = I_R \left( \frac{T_1}{T_2} \right)^{1/2}$$

$$I_R = 1.5 \text{ A}$$

$$T_1 = 25 \mu\text{s}$$

$$T_2 = 50 \mu\text{s}$$

$$I_1 \text{ RMS} = 1.06 \text{ A}$$

$$I_2 \text{ RMS} = \left[ \left( I_{PK}^2 + I_{PK} \Delta I + \frac{\Delta I^2}{3} \right) \frac{T_2 - T_1}{T_2} \right]^{1/2}$$

$$I_{PK} = 1.575 \text{ A}$$

$$\Delta I = 0.15 \text{ A}$$

$$I_2 \text{ RMS} = 1.176 \text{ A}$$

$$I_{C2} \text{ RMS} = \left[ I_1^2 \text{ RMS} + I_2^2 \text{ RMS} \right]^{1/2}$$

$$I_{C2} \text{ RMS} = 1.58 \text{ A}$$

#### SECONDARY WINDING WIRE SIZE

Wire size is determined by the rms current that the wire can handle, and the circular mils per ampere specified. For the secondary winding, the rms current will be the same as  $I_D \text{ RMS}$ , 2.228 A. AWG 17 wire is selected for the secondary windings because it is rated at 2.74 A based on 750 circ mils per ampere. AWG 17 wire has an area of 2420 circ mils.

#### PRIMARY WINDING WIRE SIZE

The rms current in the primary winding will be 18.5 A. The wire size selected for the primary side is AWG 8. AWG 8 wire is rated at 22.0 A based on 750 circ mils per ampere. AWG 8 wire has an area of 18 000 circ mils.

$C_1$

$$C = I \frac{\Delta T}{\Delta V}$$

$$I = I_{PK}'' \text{ (from figure B4)}$$

$$= 12.5 \text{ A}$$

$\Delta V$  is specified to be 10% of  $V_1$ .

thus

$$\Delta V = 27 \text{ V}$$

$$\Delta T = 25 \mu\text{s}$$

$$C_1 = 11.6 \mu\text{F}$$

$C_2$

From reference (a),

$$C_2 = \frac{DV_2}{\Delta V_2 R_L f}$$

$$V_2 = 2250 \text{ V dc}$$

$$D = 0.5$$

$$\Delta V_2 = 22.5 \text{ V P/P (1\% ripple specified)}$$

$$f = 20 \text{ kHz}$$

$$R_L = 1500\Omega$$

$$C_2 = 1.67 \mu\text{F}$$

$L_S$

From reference (a)

$$L_S = \frac{DV_2}{2\Delta I f}$$

$$D = 0.5$$

$$V_2 = 2250$$

$$\Delta I = 0.15 \text{ A P/P (specified)}$$

$$L_S = 187.5 \text{ mH}$$

## CORE SELECTION

Core selection is based on the core selection charts of reference (b). The initial selection is based on the power handling capability of the core. The next consideration is for a core that has a window (W) large enough to handle the required windings. The core's ability to handle the windings is calculated by determining the winding factor (WF). Suitable winding factors vary between 30% and 60%, with 40% being a typical value for

machine wound cores. These calculations will use a winding factor of 50% as the criterion for a satisfactory core window.

The core that was finally selected for this design is the Magnetics, Inc, model MC-1620. Its dimensions are illustrated in figure B6.

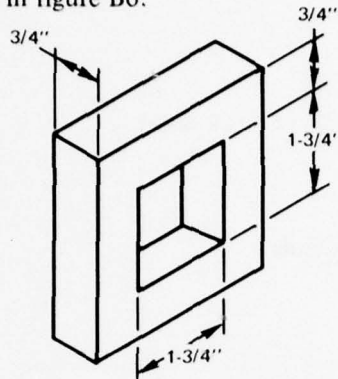

Figure B6. Magnetics, Inc, core model MC-1620.

The core mean magnetic path ( $\ell$ ), core cross section ( $A$ ), and core window ( $W$ ) are listed in table 2.

Table B2. MC-1620 core dimensions.

$\ell$	= 25.4 cm
$A$	= 3.63 cm <sup>2</sup>
$W$	= 3899175 circ mil*

#### WIRE TURNS NEEDED

$$N_S^2 = \frac{L_S \ell}{0.4\pi\mu A \times 10^{-8}}$$

$$L_S = 187.5 \text{ mH}$$

$$\ell = 25.4 \text{ cm}$$

$$\mu = 500 \text{ (permalloy 80)}$$

$$A = 3.63 \text{ cm}^2$$

$$N_S = 456.9 \text{ turns}$$

$$\frac{N_S}{N_P} = 8.33$$

$$N_P = 54.8 \text{ turns}$$

\*circ mil = in<sup>2</sup> × 1273200

## WINDING FACTOR

The winding factor may now be calculated for the new core.

$$WF_P = \frac{A_{WP} N_P}{W}$$

$$A_{WP} = 18000 \text{ circ mils (AWG 8 wire)}$$

$$N_P = 55 \text{ turns}$$

$$W = 3899175 \text{ circ mils}$$

$$WF_P = 0.253$$

$$WF_S = \frac{A_{WS} N_S}{W}$$

$$A_{WS} = 2420 \text{ circ mils (AWG 17 wire)}$$

$$N_S = 457 \text{ turns}$$

$$W = 3899175 \text{ circ mils}$$

$$WF_S = 0.283$$

$$WF_P + WF_S = 0.536$$

An optimum transformer design will have the entire window area filled by the windings. This is indicated by a factor (WF) of approximately 0.5. Air space among the windings and wire insulation are assumed to take up half the winding area. Thus, the WF of 0.53 calculated here indicates that the core selected for this power supply design will fulfill the requirements of this design.

## CIRCUIT ELEMENT VOLUME ESTIMATES

The following volume estimates use representative, although not necessarily optimum, circuit elements since the purpose of this design is to estimate the volume of a practical converter. These external dimensions are on the conservative side and may therefore be considered a worst case.

## BRIDGE RECTIFIER

The bridge rectifier consists of six diodes. Such a rectifier may be made from a bridge rectifier package or, in order to obtain a worst-case volume estimate, a set of six diodes.

The diode chosen for the bridge network must be able to handle a reverse voltage of 200 V – for safety – and at least 22-A average current. A diode that satisfies these requirements is the 1N2156. The 1N2156 diode is rated at 200 V and 25 A. The maximum

rectangular dimensions of the single diode package are  $0.7 \times 0.7 \times 1.5$ . The estimated dimensions of a set of six of these diodes is  $1 \times 2 \times 5$  inches.

### $C_1$

$C_1$  is required to have a capacitance of  $11.5 \mu\text{F}$  and a working voltage of 270 V dc. The capacitor selected for  $C_1$  is the Cornell Dubilier capacitor described in table B3. The configuration of the capacitor is drawn in figure B7 and has a capacitance of  $11.7 \mu\text{F}$ .

Table B3. Cornell Dubilier tantalum foil capacitor Y3R9LNE.

Capacitance:  $3.9 \mu\text{F}$   
Case size: E-5 (0.406" D, 2.87" L)  
Dc working voltage: 250 V dc (at  $125^\circ\text{C}$ )

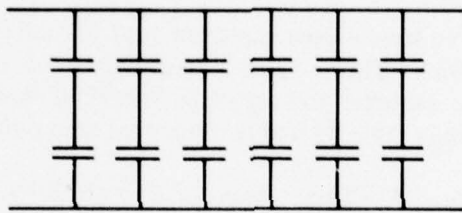

Figure B7.  $C_1$  configuration.

The rectangular volume that these capacitors would occupy is estimated to be  $2 \times 4 \times 4$  inches.

### TRANSFORMER

The transformer ( $L_p$  and  $L_s$ ) will have maximum dimensions when it has been wound. The estimated maximum dimensions are illustrated in figure B8.

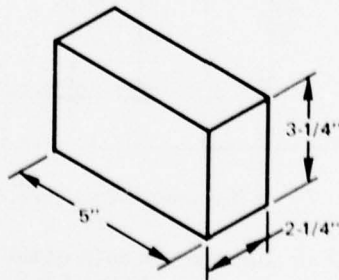

Figure B8. Estimated maximum dimensions of transformer with model 1620 core.

For the purposes of this estimate, the transformer will be assumed to have a rectangular volume of  $5 \times 3 \times 4$  inches.

### SWITCHING TRANSISTOR (Q)

The switching transistor must be capable of handling  $V_{CE}$  of at least 270 V and  $I_C$  of at least 18.5 A rms. Such a transistor is the Motorola MJ10015, which has a  $V_{CE}$  of 400 V and  $I_V$  of 40 A. This transistor is contained in a TO-3 package that will occupy a rectangular volume of approximately  $2 \times 1 \times 1$  inches.

### DIODE (D<sub>1</sub>)

The diode of the regulator must be capable of handling a reverse voltage of 3000 V dc and a current of 3 A rms. Such a diode is a combination of four Westinghouse 1N3990 diodes in series. The 1N3990 diode is rated at 6 A/1000 V and comes in a DO-4 package. The rectangular volume that a set of four diodes would occupy is  $4 \times 1 \times 3$  inches.

### CAPACITOR C<sub>2</sub>

C<sub>2</sub> is required to have a capacitance of  $1.67 \mu\text{F}$  and to be able to withstand a dc working voltage of 3000 V. The ac ripple current will be 1.5 A rms.

Cornell Dubilier tantalum foil capacitor Y3R9LNE is selected. This capacitor has the characteristics given in table B4 and is configured as in figure B9.

Table B4. Characteristics of Cornell Dubilier tantalum foil capacitor Y3R9LNE.

Capacitance:  $3.9 \mu\text{F}$

Case size: E-5 (0.406" D, 2.87" L)

Dc working voltage: 250 V (at 125°C)

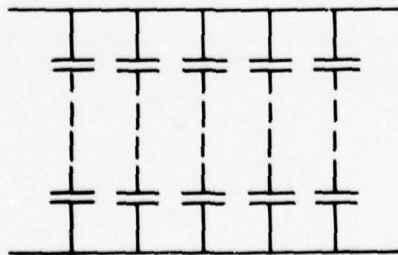

Figure B9. Capacitor C<sub>2</sub> configuration.

There are twelve  $3.9 \mu\text{F}$  capacitors in each of the five shunt branches. This gives an overall capacitance of  $1.625 \mu\text{F}$  rated at 3000 V dc (125°C).

The dimensions of an insulated E-5 case are 0.406 (diameter) and 2.874 (length). The estimated rectangular volume of a  $5 \times 12 \times 1$  array of these capacitors is  $3 \times 4 \times 8$  in.

## CONTROL CIRCUITRY

The control circuitry will be allocated a rectangular volume of  $3 \times 3 \times 4$ . The volume allocated to the control circuitry will account for circuit elements that provide for soft start-up, protection circuitry, switching control, and sense elements. These functions will be scattered throughout the power supply and in many cases take up only interstitial volumes and not have a large impact on the final volume. Liberal use of the new, compact control and driver DIPs is assumed.

## SUMMARY OF DIMENSIONS

Table B5. Summary of estimated dimensions of circuit elements.

CIRCUIT ELEMENT	DIMENSIONS (in)	VOLUME (in <sup>3</sup> )
BRIDGE RECTIFIER	1 × 2 × 5	10
C <sub>1</sub>	2 × 4 × 4	32
T <sub>1</sub>	3 × 4 × 5	60
Q	1 × 2 × 2	4
D	1 × 3 × 4	12
C <sub>2</sub>	3 × 4 × 8	96
Control circuitry	3 × 3 × 4	<u>36</u>
		Total 250

In one hypothetical arrangement of the elements of table B5, the elements were fitted into a  $4 \times 4 \times 16$  inch box. This represents a total volume of  $256 \text{ in}^3$ .



## APPENDIX C: DESIGN OF A 500 V DC, 500-W POWER SUPPLY

- References: (a) Switching Regulators by LL Ogborn, Associate Professor of Engineering, Purdue University  
(b) Magnetics, Inc, Catalog MCC-100  
(c) Magnetics, Inc, Catalog MPP-303A  
(d) Spacecraft Transformer and Inductor Design, JPL Publication 77-35 by Colonel WT McLyman  
(e) NOSC TR 177, J Foutz, E Kamm, 1 June 1978

The calculations in this appendix represent an outline of calculations for the design of a power converter that will supply 500 V dc/1.0 A to the URT-23A(V) driver amplifier plates and for screen voltage regulation. This converter design is operating at 20 kHz in a buck-boost configuration (fig C1). The purpose of this design is to determine circuit parameters so that suitable devices may be selected. The volume occupied by these devices will be used to estimate the volume of the complete converter.

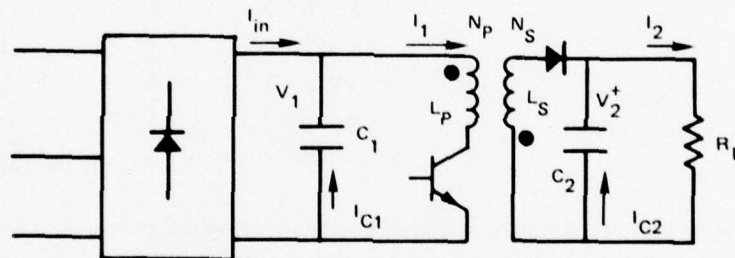

Figure C1. Buck-boost switching-mode regulator.

The specifications for the converter are contained in table C1.

Table C1. Specifications for buck-boost converter design.

INPUT: 200 V/3 $\phi$ /60 Hz (270 V dc when rectified)

OUTPUT: 500 V dc/1.0 A

SWITCHING FREQUENCY (f): 20 kHz

DUTY CYCLE (D): 50%

If the duty cycle were used to obtain the required voltage and a 1:1 turns ratio transformer were used in the circuit of figure C1, the transistor would have at least 500 Vdc imposed across the collector and emitter. Since transistors do not commonly have a  $V_{CE}$  breakdown voltage greater than 400 V, adjusting the duty cycle would not be a practical method of obtaining the required voltage in this case.

For a 50% duty cycle and 1:1 transformer turns ratio, the output voltage will equal the input voltage. If the turns ratio of the transformer is adjusted, 500 V dc may be obtained on the secondary side while the primary side will still see 270 V dc across the switching transistor. This is a practical method of obtaining the required 500-V dc output voltage.

### URNS RATIO

The turns ratio required on the transformer is determined by the following formula:

$$\frac{V_1}{V_2} = \frac{N_P}{N_S}$$

$V_1$  = input voltage

$V_2$  = output voltage

$N_P$  = number of turns on primary side

$N_S$  = number of turns on secondary side

For the voltage specified in this design the turns ratio is calculated as follows:

$$\frac{V_1}{V_2} = \frac{N_P}{N_S}$$

$$\frac{270}{500} = \frac{N_P}{N_S}$$

$$\frac{N_S}{N_P} = 3.125$$

Current and voltage waveforms that are encountered in the circuit of figure C1 are drawn in figures C2 and C3.

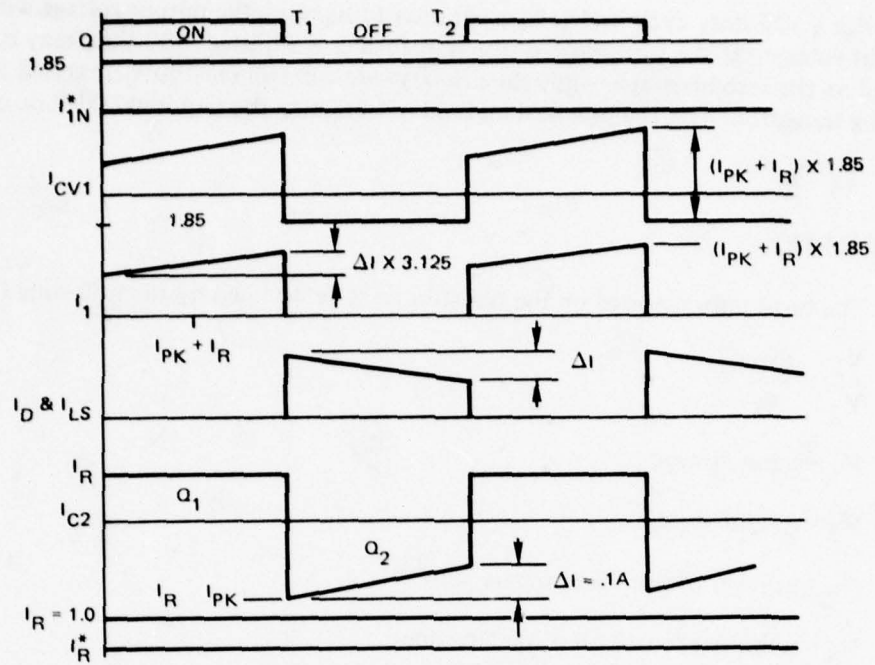

Figure C2. Buck-boost regulator current waveforms for  $D = 0.5$ .  
(Not to Scale)

\*Assumed to be smooth dc for the purposes of these figures.

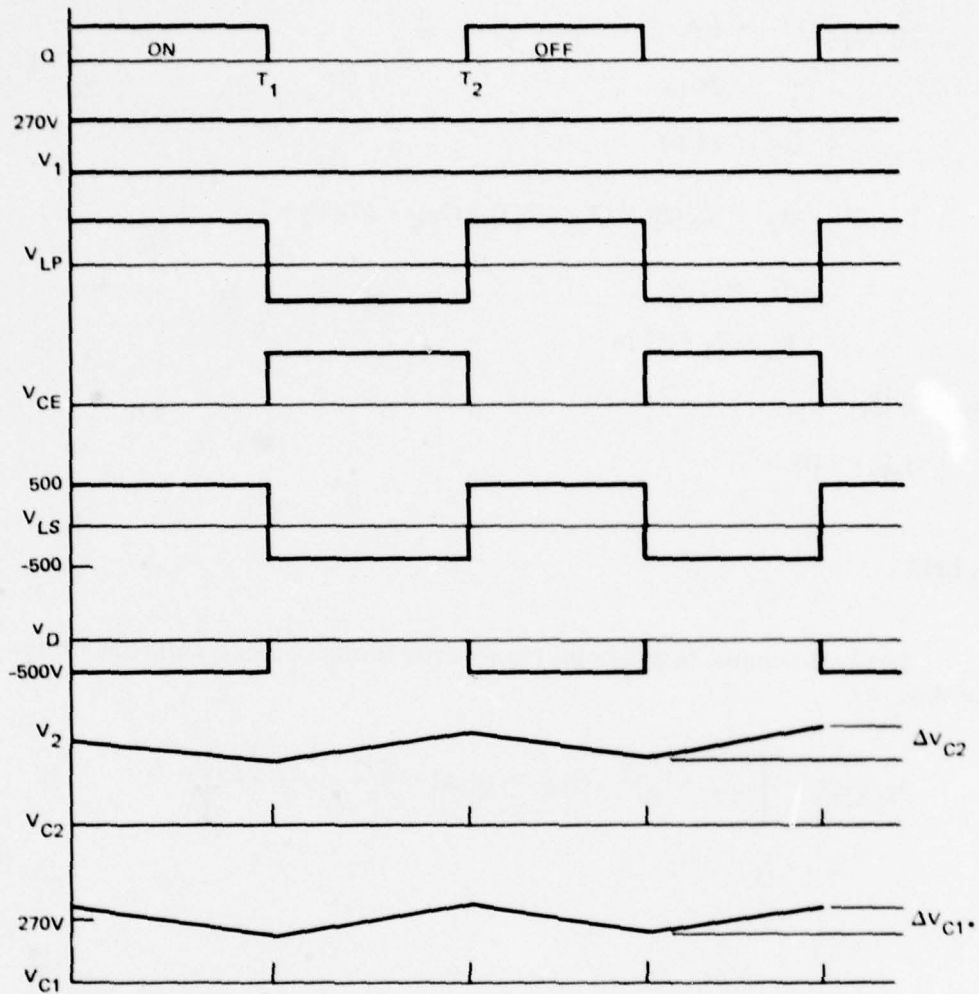

Figure C3. Buck-boost regulator voltage waveforms for  $D = 0.5$ .  
(Not to Scale)

$\Delta V$  is specified here to be 1% of  $V_2$ .  $V_2$  is 500 V dc, so  $\Delta V_{C2}$  is 5 V P/P. The rms value of  $\Delta V_{C2}$  is 2.89V.  $\Delta V_{C1}$  is specified as 10% of  $V$  in.  $V_{C1}$  ripple voltage is 15.6 V rms.

### $I_{PK}$

$\Delta I$  of  $I_D$  OR  $I_{C2}$  in figure C2 is specified to be 10% of  $I_R$  for these calculations.  
Thus,  $\Delta I$  is 0.1 A P/P.

Calculating,

$$Q_1 = Q_2 \quad (I_{C2} \text{ of fig C2})$$

$$Q = IT$$

$$\text{For } Q_1: I = 1 \text{ A}$$

$$T = 25 \mu\text{s}$$

$$\therefore Q_1 = 25 \mu\text{c}$$

$$\text{For } Q_2: Q_2 = \frac{1}{2} (\Delta I \times (T_2 - T_1)) + (I_{PK} - \Delta I)(T_2 - T_1)$$

$$\Delta I = .1 \text{ A}$$

$$T_2 - T_1 = 25 \mu\text{s}$$

Thus, for  $Q_1 = Q_2$ ,

$$I_{PK} = 1.05 \text{ A}$$

### $I_D$ RMS

$I_D$  rms is required to determine the wire size for the secondary winding for the transformer.

$$I_D \text{ RMS} = \left[ (I_{PK} + I_R)^2 + (I_{PK} + I_R) \Delta I + \frac{\Delta I^2}{3} \frac{T_2 - T_1}{T_2} \right]^{1/2}$$

$$I_{PK} + I_R = 2.08$$

$$\Delta I = 0.1 \text{ A}$$

$$T_1 = 25 \mu\text{s}$$

$$T_2 = 50 \mu\text{s}$$

$$I_D \text{ RMS} = 1.49 \text{ A}$$

### SECONDARY WINDING WIRE SIZE

The required wire size is determined by the rms current and circular mils per ampere specified. For the secondary winding, 1.49 A rms is the maximum rms current experienced. AWG 19 wire is rated at 1.72 A based on 750 circ mils per ampere. The wire area for AWG 19 wire is 1560 circ mils based on the maximum diameter of heavy formvar wire with insulation.

## $I_1$ RMS

$I_1$  rms determines the wire size of the primary side of the transformer. Referring to figure C2,

$$\Delta I = .1 \text{ A}$$

$$I_{PK} = 1.05 \text{ A}$$

$$I_R = 1 \text{ A}$$

$$I_1 = 1.85 (\Delta I)$$

$$I_2 = 1.85 (I_{PK} + I_R)$$

$$T_1 = 25 \mu\text{s}$$

$$T_2 = 50 \mu\text{s}$$

$$I_1 \text{ RMS} = \left[ \left( I_2^2 + I_1 I_2 + \frac{I_1^2}{3} \right) \frac{T_1}{T_2} \right]^{1/2}$$

$$I_1 \text{ RMS} = 2.75 \text{ A}$$

(Note:  $I_1$  RMS is 1.85 times  $I_D$  RMS)

## PRIMARY WINDING WIRE SIZE

The primary side of the transformer experiences a maximum rms current of 2.75 A. AWG 16 wire is rated at 3.44 A based on 750 circ mils per ampere. The wire area for AWG 16 wire is 3000 circ mils based on the maximum diameter of heavy formvar wire with insulation.

$I_1$  is the square wave function in  $I_{C2}$ , and  $I_2$  is the trapezoidal wave function in  $I_{C2}$

$$I_1 \text{ RMS} = I_R \left( \frac{T_1}{T_2} \right)^{1/2}$$

$$I_1 \text{ RMS} = 0.707 \text{ A}$$

$$I_2 \text{ RMS} = \left[ \left( I_{PK}^2 + I_{PK} \Delta I + \frac{\Delta I^2}{3} \right) \frac{T_2 - T_1}{T_2} \right]^{1/2}$$

$$I_2 \text{ RMS} = 0.78 \text{ A}$$

$$I_{C2} \text{ RMS} = 1.05 \text{ A}$$

C1

Using figures C2, C3, and C4, and specifying  $\Delta V_{C1}$  to be 10% of  $V_1$

$$C_1 = I \frac{\Delta T}{\Delta V_{C1}}$$

$$I = I''_{PK} = 1.85 \text{ A}$$

$$\Delta V_{C1} = 27 \text{ V}$$

$$\Delta T = 25 \mu\text{s}$$

$$C_1 = 1.7 \mu\text{F}$$

$I_{C1 \text{ RMS}}$

$I_{C1 \text{ rms}}$  is required for selecting the proper capacitor for  $C_1$ . Using figure C4,

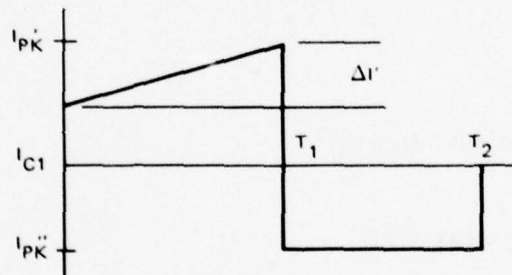

Figure C4. Current waveform across  $C_1$ .

$$\Delta I = 0.1 \text{ A}$$

$$T_1 = 25 \mu\text{s}$$

$$I_{PK} = 1.05 \text{ A}$$

$$T_2 = 50 \mu\text{s}$$

$$I_R = 1 \text{ A}$$

$$\Delta I' = 1.85 (\Delta I) = 0.185 \text{ A}$$

$$|I''_{PK}| = I_{IN} = 1.85 \text{ A}$$

$$I'_{PK} = 1.85 (I_{PK} + I_R) - |I''_{PK}| = 1.9425 \text{ A}$$

$$= 1.85 (I_{PK})$$

$$I_{C1 \text{ RMS}} = \left[ I_1^2 \text{ RMS} + I_2^2 \text{ RMS} \right]^{1/2}$$

$I_1$  is the trapezoidal wave function, while  $I_2$  is the square wave function.

$$I_1 \text{ RMS} = \left[ \left( (I'_{PK})^2 + I'_{PK} \Delta I' + \frac{(\Delta I')^2}{3} \right) \frac{T_1}{T_2} \right]^{1/2}$$

$$= 1.44 \text{ A}$$

$$I_2 \text{ RMS} = I''_{PK} \left[ \frac{T_1}{T_2} \right]^{1/2}$$

$$= 1.31 \text{ A}$$

$$\therefore I_{C1} \text{ RMS} = 1.95 \text{ A}$$

$I_{C2}$

$I_{C2}$  rms is required for selecting the proper capacitor for C2. Using figure C5,

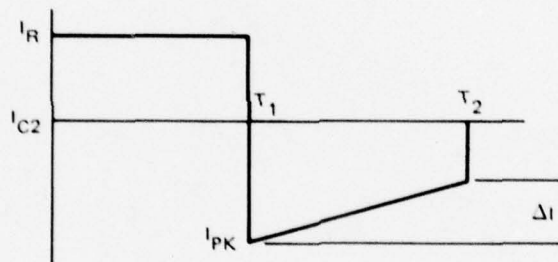

Figure C5.  $I_{C2}$  current waveform.

$$I_R = 1.0 \text{ A}$$

$$T_1 = 25 \mu\text{s}$$

$$I_{PK} = 1.05 \text{ A}$$

$$T_2 = 50 \mu\text{s}$$

$$\Delta I = 0.1 \text{ A}$$

$$T_2$$

$$I_{C2} \text{ RMS} = \left( I_1^2 \text{ RMS} + I_2^2 \text{ RMS} \right)^{1/2}$$

C2

Reference (d) gives a formula for calculating C2. V will be specified here to be 1% of V2.



$$C_2 = \frac{V_2 D}{\Delta V_2 R_L f}$$

$$V_2 = 500 \text{ V}$$

$$D = 0.5$$

$$\Delta V_2 = 5 \text{ V}$$

$$R_L = 500 \Omega$$

$$f = 20 \text{ kHz}$$

$$C_2 = 5 \mu\text{F}$$

### $L_S$

$L_S$  is required to determine the number of turns of wire on the secondary of the transformer. Its calculation is based on specifying the current droop through  $L_S$  as it delivers power to the load. The following equation from reference (d) is used.

$$L_S = \frac{DV_2}{2\Delta I f}$$

$$D = 0.5$$

$$V_2 = 500$$

$$\Delta I = 0.1 \text{ A (specified)}$$

$$f = 20 \text{ kHz}$$

$$L_S = 6.25 \text{ mH}$$

$L_P$  may be calculated after the number of turns on the primary side have been calculated by using the following equation.

$$L_P = \frac{N_P^2 0.4\pi\mu A \times 10^{-8}}{\ell}$$

### CORE SELECTION

Core selection is based on the core selection charts of reference (b). The initial selection is for a core that can handle the required power at the operating frequency. The next consideration is for a core that has a window area ( $W$ ) that can handle the turns required for the specified inductance. The ability of the core to handle the number of

turns is determined by calculating the winding factor (WF). The winding factor varies between 30% and 60%, with 40% a typical value for machine wound cores. These calculations will use a winding factor of approximately 50% as the criterion for a satisfactory core window.

Several cores that could handle the throughput power were chosen before one with a suitable window area was found. The following calculations are based on this core. Core dimensions are shown in figure C6.

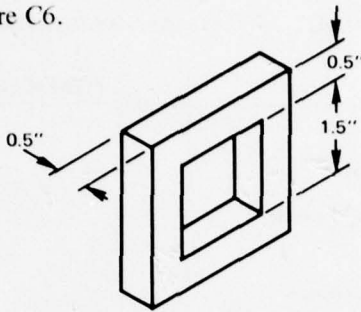

Figure C6. Magnetics, Inc, core model MC1610.

The mean magnetic path ( $\ell$ ), core cross section ( $A$ ), and window area ( $W$ ) are listed in table C2.

Table C2. Mc1610 core dimensions.

$$\begin{aligned}\ell &= 20.32 \text{ cm} \\ s &= 1.61 \text{ cm}^2 \\ W &= 2764700 \text{ circ mils}^*\end{aligned}$$

#### WIRE TURNS NEEDED

The number of turns for the primary and secondary side determines the voltage ratio and inductances. The formula used is from reference (c).

$$N_S^2 = \frac{L_S \ell}{.4\pi\mu A \times 10^{-8}}$$

$$L_S = 62.5 \text{ mH}$$

$$\mu = 500 \text{ (permalloy 80)}$$

$$A = 1.61 \text{ cm}^2$$

$$\ell = 20.32 \text{ cm}$$

$$N_S = 354.3 \text{ turns}$$

\*Circ mils =  $\text{in}^2 \times 1273200$

The calculations in this appendix represent the general design calculations for a 400-Hz inverter which will supply 115-V power to the users listed in table D1. It is estimated, table D1, that the inverter will supply a maximum of 676 watts to its load. If the inverter is assumed to be 40%\* efficient, 1690 watts of power will be delivered to the inverter.

Table D1. 400-Hz inverter load estimate.

USER	POWER CONSUMED (WATTS)
Blower motor	63
Band switch motor	50
Antenna coupler and exciter	230
P.C. board	69
D.C. power control board	64
D.A. & F.A. filaments	200
Total	676

The blower motor operates only on 115 V/1 $\phi$ /400 Hz. The antenna coupler and exciter operate on either 115 V/60 Hz or 115 V/400 Hz. The band switch motor presently operates on 60 Hz and will not operate on 400 Hz, so a suitable 400 Hz replacement for the band switch motor would have to be installed.

The inverter circuit used in this design (fig D1) is an updated design of the 400-Hz inverter presently used in the AN/URT-23A(V), 60-Hz power supply. The original 400-Hz inverter needed to supply only 63 watts of power to the blower motor, but this new version will supply a total of 676 watts to the users listed in table D1. A summary of specifications for the inverter is contained in table D2.

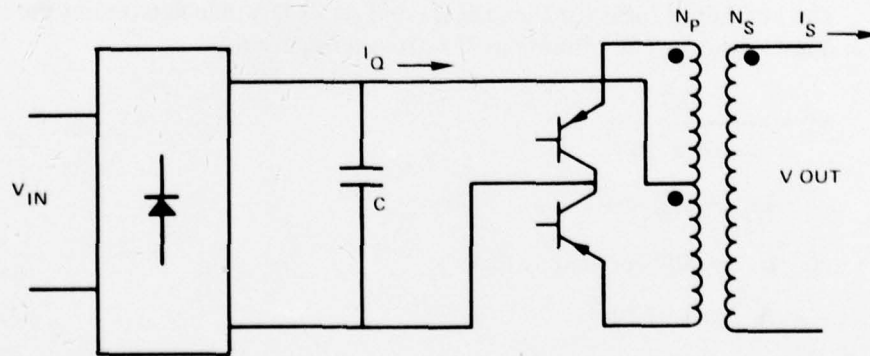

Figure D1. 400-Hz inverter circuit.

\*This is a lower figure than is normal for inverters, but is used here to obtain a worst-case design.

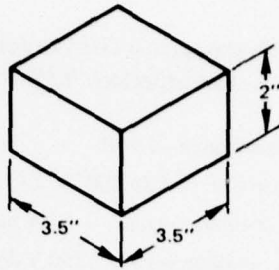

Figure C7. Maximum wound transformer dimensions.

For the purposes of this estimate, the transformer will be assumed to have a rectangular volume of  $3 \times 4 \times 4$  inches.

### CAPACITOR C1

Capacitor C1 has a capacitance of  $1.7 \mu\text{F}$  and a dc working voltage of 270 V. Ac ripple current is 1.95 A rms. Cornell Dubilier tantalum foil capacitor Y2R2LNE is selected. This capacitor has the characteristics listed in table C3 and is configured as in figure C7.

Table C3. Characteristics of Cornell Dubilier tantalum foil capacitor Y2R2LNE.

Capacitance:  $2.2 \mu\text{F}$   
 Case size: E-4 (0.406"D, 2.249"L)  
 Max ripple current: 1.68 A rms  
 Dc working voltage:  $250 V_{\text{DCW}}$  (at  $125^\circ\text{C}$ )

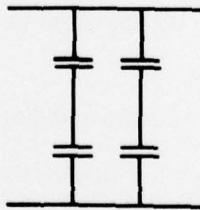

Figure C8. Capacitor C1 configuration.

The capacitor bank will have an estimated rectangular volume of  $2 \times 2 \times 4$  inches.

### CAPACITOR C2

Capacitor C2 has a capacitance of  $5 \mu\text{F}$  and a dc working voltage of 500 V dc. Ac ripple current is 1.05 A rms. Cornell Dubilier tantalum foil capacitor Y3R9LNE is selected. Capacitor characteristics are listed in table C4. The configuration of the capacitors is illustrated in figure C9.

Table C4. Characteristics of Cornell Dubilier tantalum foil capacitor Y3R9LNE.

Capacitance: 3.9  $\mu$ F  
 Case size: E-5 (0.406"D, 2.874"L)  
 Max ripple current: 1.47 A rms  
 Dc working voltage: 250 V dc (at 125°C)

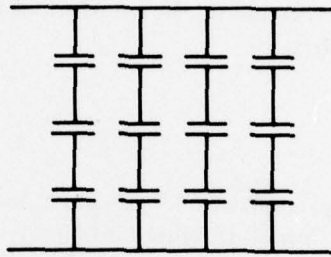

Figure C9. Capacitor C2 configuration.

The capacitor bank will have an estimated rectangular volume of 3 x 3 x 4 inches.

### SUMMARY

Only capacitors C1, C2, and the transformer have volume estimates contained in this appendix. Other elements of the converter have been calculated in appendix B and will be used here. The borrowed elements are for a much higher-rated converter, but the elements are comparable in size to this lower-power design. Table C5 is a summary of element dimensions and volumes.

Table C5. Summary of estimated dimensions of circuit elements.

CIRCUIT ELEMENTS	DIMENSIONS (in)	VOLUME (in <sup>3</sup> )
Bridge rectifier	1 x 2 x 4	8
C <sub>1</sub>	2 x 2 x 4	16
T <sub>1</sub>	3 x 4 x 4	48
Q	1 x 2 x 2	4
D	1 x 3 x 4	12
C <sub>2</sub>	3 x 3 x 4	36
Control circuitry	3 x 3 x 4	36
		Total 160

A hypothetical arrangement of the elements in table C5 may be fitted into a rectangular volume of 3 x 4 x 16 inches. This represents a total volume of 192 in<sup>3</sup>.

#### APPENDIX D: DESIGN OF A 115-V/1 $\phi$ /400-Hz INVERTER

- References:
- (a) Magnetics, Inc, Catalog MCC-100
  - (b) Magnetics, Inc, Catalog MPP-303A
  - (c) Spacecraft Transformer and Inductor Design, JPL Publication 77-35,  
by Colonel WT McLyman
  - (d) Model AN/URT-23A(V) Technical Manual, Operation and Maintenance  
Inst, NAVELEX 0967-456-9010, Naval Electronic Systems Command
  - (e) NOSC TR 177, Power Electronics Technology Applications for Future  
SSBN's, J Foutz, E Kamm, 1 June 1978

$$\frac{N_S}{N_P} = 1.85$$

$$N_P = 191.5 \text{ turns}$$

### WINDING FACTOR (WF)

The winding factor is the percent of the core window occupied by the wound wire.

$$WF_P = \frac{A_{WP} N_P}{W}$$

$$A_{WP} = 3000 \text{ circ mils (AWG 16 wire)}$$

$$N_P = 192 \text{ turns}$$

$$W = 2864700 \text{ circ mils}$$

$$WF_P = 0.20$$

$$WF_S = \frac{A_{WS} N_S}{W}$$

$$A_{WS} = 1560 \text{ circ mils (AWG 19 wire)}$$

$$N_S = 354$$

$$WF_S = 0.193$$

$$WF = WF_S + WF_P$$

$$= 0.392$$

### VOLUME CALCULATIONS

The volumes of  $C_1$ ,  $C_2$ , and the transformer will be calculated here since they constitute the single largest volume users. Estimates of the volumes of the other elements will be based on another design.

### TRANSFORMER

The transformer consists of the MC1610 core and the wire windings. The estimated maximum dimensions that the transformer would occupy are illustrated in figure C7.

Table D2. Summary of 400-Hz inverter specifications.

Input: 200 V/3 $\phi$ /60 Hz (270 V dc when rectified)

Output: 115 V/1 $\phi$ /400 Hz

Power delivered to load: 676 watts

Power delivered to inverter: 1690 watts (40% efficient inverter)

## RECTIFIER DIODES

1690 watts of power will be delivered to the inverter on the 200 V/3 $\phi$ /60 Hz line. Each diode will be rated for at least 8.5 A rms and peak reverse voltage of at least 143 V under normal conditions. A diode that satisfies these specifications is the Westinghouse IN3893. This diode has the ratings listed in table D3.

Table D3. Westinghouse IN3893 diode ratings.

$V_{RRM}$ : 400 V

$I_F$ : 12 A

This diode is contained in a DO-4 package that has maximum cylindrical dimensions of 1.25 in (L) and 0.424 in (D). It is estimated that a set of six of these diodes would occupy a rectangular volume of 1  $\times$  3  $\times$  3 inches.

## CAPACITOR (C)

The capacitor is specified to be charged to 270 V dc, and may drop 54 V (20%) without affecting the operation of the inverter. During the period that the capacitor is discharging, it is supplying approximately 6.26 A to the inverter based on 40% inverter efficiency and a 676-watt load. Figure D2 is used to determine the time between charging for the capacitor.

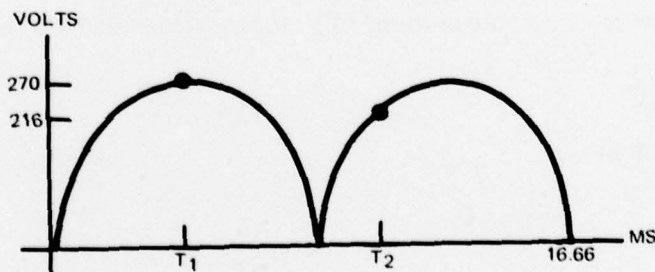

Figure D2. Rectified 60-Hz power to the capacitor.



$$T_2 = 8.33 \text{ ms} + t_2$$

Solving for  $t_2$ :

$$216 = 270 \sin \omega t_2$$

$$\omega = 2\pi f$$

$$f = 60 \text{ Hz}$$

$$t_2 = 2.46 \text{ ms}$$

$$T_2 = 10.79 \text{ ms}$$

The time period that the capacitor is discharging is  $\Delta T$ .

$$\Delta T = T_2 - T_1$$

$$T_2 = 10.79 \text{ ms}$$

$$T_1 = 4.16 \text{ ms}$$

$$\Delta T = 6.63 \text{ ms}$$

The amount of charge lost by the capacitor during this period is  $\Delta Q$ .

$$\Delta Q = I \Delta T$$

$$I = 6.26 \text{ A}$$

$$\Delta T = 6.63 \text{ ms}$$

For three-phase rectification, the time interval between the start of discharge and charging of the capacitor is  $T \div 3$  or 2.21 ms.

$$\Delta Q = 1.4 \times 10^{-2} \text{ coulomb}$$

For the specified voltage drop, 54 V, the capacitor will have the value of C.

$$C = \frac{\Delta Q}{\Delta V}$$

$$C = 256 \mu\text{F}$$

Thus, the capacitor must have a value of  $256 \mu\text{F}$  and be able to handle  $270 \text{ V dc}$ . A candidate capacitor that will satisfy these specifications is an arrangement, (fig D3) of 12 Cornell Dubilier type RC533306. The specifications of this capacitor are given in Table D4.

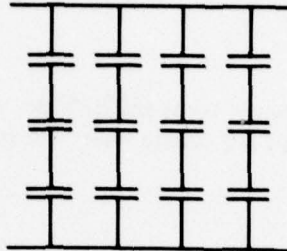

Figure D3. Configuration of filter capacitor.

Table D4. C-D type RC533306 capacitor specifications.

$V_{\text{DCW}} (125^\circ\text{C}): 100 \text{ V dc}$

Capacitance:  $200 \mu\text{F}$

Case dimensions:  $1 \times 1.5 \times 3$  inches

A set of 12 of these capacitors will occupy a rectangular volume of  $4 \times 5 \times 5$  inches.

## TRANSISTORS

Each transistor will handle a maximum  $2.5 \text{ A rms}$  and have a collector-emitter voltage of at least  $270 \text{ V}$ . A transistor that may handle these specifications is the Westinghouse type 153-30. This transistor's ratings are listed in table D5. The rectangular volume that would be occupied by a set of two of these transistors is  $1 \times 2 \times 3$  inches.

Table D5. Westinghouse 153-30 transistor ratings.

$V_{\text{CE}}: 300 \text{ V}$

$I_{\text{C}}: 7.5 \text{ A}$

## CONTROL CIRCUITRY

Control circuitry for the inverter will consist of resistors and a capacitor. The control circuitry will be assigned an arbitrary volume of  $1 \times 5 \times 6$  inches.

## TRANSFORMER

The primary side of the inverter transformer is center tapped for a push-pull circuit configuration (fig D1). The transformer must be able to pass at least 676 watts at 400 Hz.

### TURNS RATIO

The voltage across the primary turns is 270 V dc. 115 V ac rms is required on the secondary side, so since the output is a square wave, the rms value equals one-half the peak-to-peak voltage, 230 V P/P.

$$\frac{N_P}{N_S} = \frac{V_P}{V_S}$$

$$V_P = 270 \text{ V}$$

$$V_S = 115 \text{ V}$$

$$\frac{N_P}{N_S} = 2.35$$

### NUMBER OF TURNS

A form of Faraday's law for electromagnetic induction is:

$$N = \frac{E \times 10^4}{K B_m f A_c}$$

N = number of turns

E = rms voltage

K = 4 for square wave (4.44 for sine wave)

f = frequency

B<sub>m</sub> = flux density in teslas\*

A<sub>c</sub> = cross-sectional area in cm<sup>2</sup>

For the number of primary turns:

$$E_P = 270 \text{ V}$$

$$K = 4$$

---

\*1T = 10<sup>4</sup> Gauss

Specifying  $B_m$  .

$$B_m = 0.64 (B_{SAT} \text{ for Permalloy 80 is approximately } 0.75)$$

$$\therefore N_p = 229.8 \text{ turns}$$

since

$$N_s = \frac{N_p}{2.35}$$

$$N_s = 97.8 \text{ turns}$$

#### WIRE SIZE

The secondary turns will be supplying a maximum of 676 watts at 115 V ac. This indicates a maximum load current,  $I_s$ , of 5.8 A. AWG 13 wire is rated at 6.9 A based on 750 circ mils per ampere. AWG 13 wire has a wire area (WA) of 5850 circ mils.

The primary turns will carry 2.47 A. AWG 17 wire is rated at 2.74 A based on 750 circ mils per ampere. The wire area (WA) of AWG 17 wire is 2420 circ mils.

#### TRANSFORMER CORE

The transformer core material used for this calculation is permalloy 80. The core must be able to handle 676 watts. The Magnetics Core MC0168 (fig D4) is a suitable core for this power level. The window area of the core is  $8 \text{ in}^2$ .

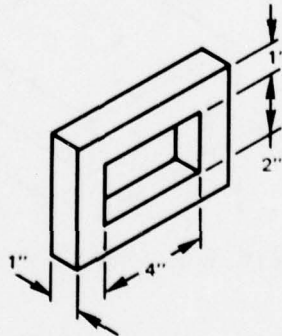

Figure D4. Magnetics MC-0248 core dimensions.

### WINDING FACTOR (WF)

In effect, there will be two primary windings of 230 turns each with AWG 13 wire, and one secondary winding of 98 turns with AWG 17 wire. The winding factor with the core window (W) and the wire sizes is:

$$WF = \frac{2(N_P \times WA_P) + (N_S \times WA_S)}{W}$$

$$N_P = 230 \text{ turns}$$

$$WA_P = 5850 \text{ circ mils (AWG 13 wire)}$$

$$N_S = 98 \text{ turns}$$

$$WA_S = 2420 \text{ circ mils (AWG 17 wire)}$$

$$W = 8 \text{ in}^2 = 10185600 \text{ circ mils}^*$$

$$\therefore WF = 0.287$$

This is a suitable winding factor for this transformer core.

### TRANSFORMER VOLUME

With windings, the maximum transformer dimensions are illustrated in figure D3.

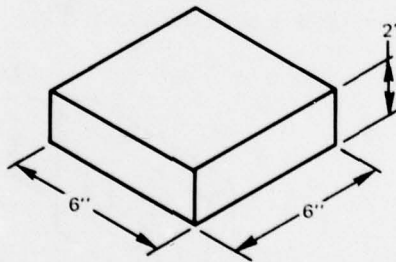

Figure D5. Estimated dimensions of transformer.

### SUMMARY

A summary of the volumes of the inverter elements is contained in table D5.

\*Circ mils =  $\text{in}^2 \times 1273200$

Table D5. Inverter element volume estimates.

ELEMENT	VOLUME (in <sup>3</sup> )
Rectifier	9 (1 × 3 × 3)
Capacitor	100 (4 × 5 × 5)
Transistors	6 (1 × 2 × 3)
Control circuitry	30 (1 × 6 × 5)
Transformer	72 (2 × 6 × 6)
Total	217

These elements may be placed in a box with rectangular dimensions of 6 × 6 × 8 inches. The volume would be 288 in<sup>3</sup>.